

# FURUNO

# OPERATOR'S MANUAL

**FACSIMILE RECEIVER**

---

**MODEL FAX-410**

---



**FURUNO ELECTRIC CO., LTD.**  
NISHINOMIYA, JAPAN

# IMPORTANT NOTICE

---

- This manual is intended for use by native speakers of English.
- No part of this manual may be copied or reproduced without written permission.
- If this manual is lost or worn, contact your dealer about replacement.
- The contents of this manual and equipment specifications are subject to change without notice.
- The example screens (or illustrations) shown in this manual may not match the screens you see on your display. The screen you see depends on your system configuration and equipment settings.
- FURUNO will assume no responsibility for the damage caused by improper use or modification of the equipment or claims of loss of profit by a third party.
- Store this manual in a convenient place for future reference.



# SAFETY INSTRUCTIONS

## Safety Instructions for the Operator

### **WARNING**

**Do not open the equipment except to replace paper.**

Only qualified personnel should work inside the equipment.

**Immediately turn off the power at the switchboard if water leaks into the equipment or something is dropped into the equipment.**

Continued use of the equipment can cause fire or electrical shock. Contact a FURUNO agent for service.

**Do not disassemble or modify the equipment.**

Fire, electrical shock or serious injury can result.

**Do not place liquid-filled containers on the top of the equipment.**

Fire or electrical shock can result if a liquid spills into the equipment.

**Immediately turn off the power at the switchboard if the equipment is emitting smoke or fire.**

Continued use of the equipment can cause fire or electrical shock. Contact a FURUNO agent for service.

**Make sure no rain or water splash leaks into the equipment.**

Fire or electrical shock can result if water leaks in the equipment.

### **WARNING**

**Use the proper fuse.**

Use of a wrong fuse can result in damage to the equipment or cause fire.

**Handle the LCD with great care. Strong shock may break it.**

If the LCD breaks, LCD liquid may leak out. Do not swallow or touch the liquid - it is toxic if swallowed. If it is swallowed or contacts eyes, rinse the contacted area thoroughly with water and contact a physician immediately.

**Dispose of the main unit according to appropriate regulations.**

The main unit contains a battery. It should also be disposed of according to appropriate regulations.

**The power supply shall conform to the recommended rating.**

Fire or electrical shock may result if an improper power supply is used.

### **CAUTION**

**Do not use commercial cleaners to clean the main unit.**

Commercial cleaners may remove paint and markings. Remove dust from the main unit with a soft cloth. For stubborn dirt, use water-diluted mild detergent and a soft cloth.

**Be careful not to catch fingers between upper lid and chassis when changing recording paper.**

Injury may result.

## Safety Instructions for the Operator (con't)

### **WARNING LABEL**

A warning label is attached to the main unit. Do not remove the label. If the label is missing or damaged, contact a FURUNO agent or dealer about replacement.

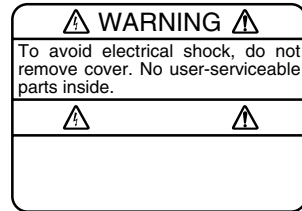

Name: Warning Label 1  
Type: 86-003-1011-1  
Code No.: 100-236-231

## Safety Instructions for the Installer

### **WARNING**



**Securely attach protective earth to the ship's body.**

The protective earth is required to the power supply to prevent electrical shock.

### **CAUTION**

**Observe the following compass safe distances to prevent interference to a compass:**

	Magnetic compass	Steering compass
Main unit	1.0 m	0.7 m

**Do not install the main unit in direct sunlight or where it may be subjected to vibration or shock.**

Inappropriate mounting location may affect performance or damage the unit.

# CONTENTS

	Page
<b>1. OUTLINE</b> . . . . .	1
1.1 Characteristics . . . . .	1
1.2 List of Standard Components . . . . .	2
1.3 System Components . . . . .	3
<b>2. OPERATION</b>	
2.1 Description of key . . . . .	4
2.2 Contrast and brightness . . . . .	7
2.3 Basic operation . . . . .	7
2.3.1 Channel setting . . . . .	7
2.3.2 Fine-adjustment of frequency, and selection of a desired frequency . . . . .	7
2.3.3 Start and stop of recording . . . . .	8
2.3.4 Manual phasing . . . . .	8
2.3.5 Synchronization . . . . .	8
2.3.6 Selection of reception mode . . . . .	9
2.3.7 Timer release and release of key lock in the timer mode . . . . .	9
2.4 Description of setting mode . . . . .	10
2.4.1 Switching of receiver (audio) . . . . .	10
2.4.2 Setting of timer reception . . . . .	11
2.4.3 Sleep timer setting . . . . .	12
2.4.4 Registration of new frequency . . . . .	13
2.4.5 Time setting . . . . .	14
2.4.6 Setting of ISB frequency . . . . .	15
2.4.7 Adjustment of contrast . . . . .	15
2.4.8 RAM clearance function . . . . .	16
2.4.9 Attention at the time of operation . . . . .	16
2.5 Operation with external receiver . . . . .	17
<b>3. MAINTENANCE</b>	
3.1 Back-up battery . . . . .	18
3.2 Lubrication and Cleaning . . . . .	18
<b>4. INSTALLATION</b>	
4.1 Main unit . . . . .	19
4.2 Wiring . . . . .	20
4.2.1 DC power supply built-in type . . . . .	20
4.2.2 AC power supply built-in type . . . . .	20
4.3 Terminal board . . . . .	21
4.3.1 Connection of BK . . . . .	21
4.3.2 Connection with external receiver . . . . .	21
4.4 Grounding . . . . .	22
4.5 Receiving antenna . . . . .	22

4.6	Exchange of a recording paper	23
5.	SPECIFICATIONS	SP-1
5.1	Receiver	SP-1
5.2	Recorder	SP-1
5.3	Automatic Control	SP-1
5.4	Power, Dimension & Weight	SP-1

## APPENDIX

### TABLE OF FACSIMILE STATION

Area map of existing stations	SP-2
Facsimile station table	SP-3

PACKING LIST	A-1~2
--------------	-------

Outside view	D-1
--------------	-----

Layout diagram	D-2
----------------	-----

## 1 . OUT LINE

FAX-410 is the high sensitive weather facsimile receiver using electronic scanning thermal head recording system.

### 1. 1 Characteristics

- (1) Electronic scanning with thermal head recording system provides clear image, quiet operation.
- (2) Pre-programmed all existing weather facsimile stations in the world. Vacant channels for new station are provided, and rewriting of the memory data is possible for changing frequency of existing station.
- (3) 9-tones gradation recording function provides clear and detailed weather photo from satellite.
- (4) Timer programming function up to 16 programs in a week provides operation free for reception of each program.
- (5) ISB shift function is equipped for corresponding to simultaneous broadcasting of fax/teletype by a multiple method of SSB by the station of the U.S. Marines management to which the frequency irregularly changes by 1-2kHz.
- (6) Possible to record the data receiving signal from external receiver.
- (7) Automatic start/stop circuit is equipped in accordance with WMO standard.
- (8) Easy operation by automatic selection of phase matching and recording speed.

## 1. 2 List of Standard Components

### Facsimile receiver. List of Standard Components

#### Standard Components

Name	Model name/Code No.	Q'ty	Remarks
Main unit	FAX-410	1 set	AC Power supply or DC Power supply
Installation materials		1	
Accessories		1 set	
Spare parts		1 set	

#### Installation materials

Name	Model name/Code No.	Q'ty	Remarks
Grounding wire	343200G01	2m	With terminal
Coaxial connector	M207-P	2	For Antenna cable
Self-tapping screw	M5×25	4	Clamp for Main unit
Flat washer	M6	5	Adjust to Clamp for Main unit

#### Accessories

Name	Model name/Code No.	Q'ty	Remarks
Recording paper	F220VP	1	257mm×30m
Operator's Manual		1	

#### Spare parts (AC Power supply)

Name	Model name/Code No.	Q'ty	Remarks
Fuse	ST4-2AN1	4	250VAC2A

#### Spare parts (DC Power supply)

Name	Model name/Code No.	Q'ty	Remarks
Fuse	ST6-7A	4	125VAC7A





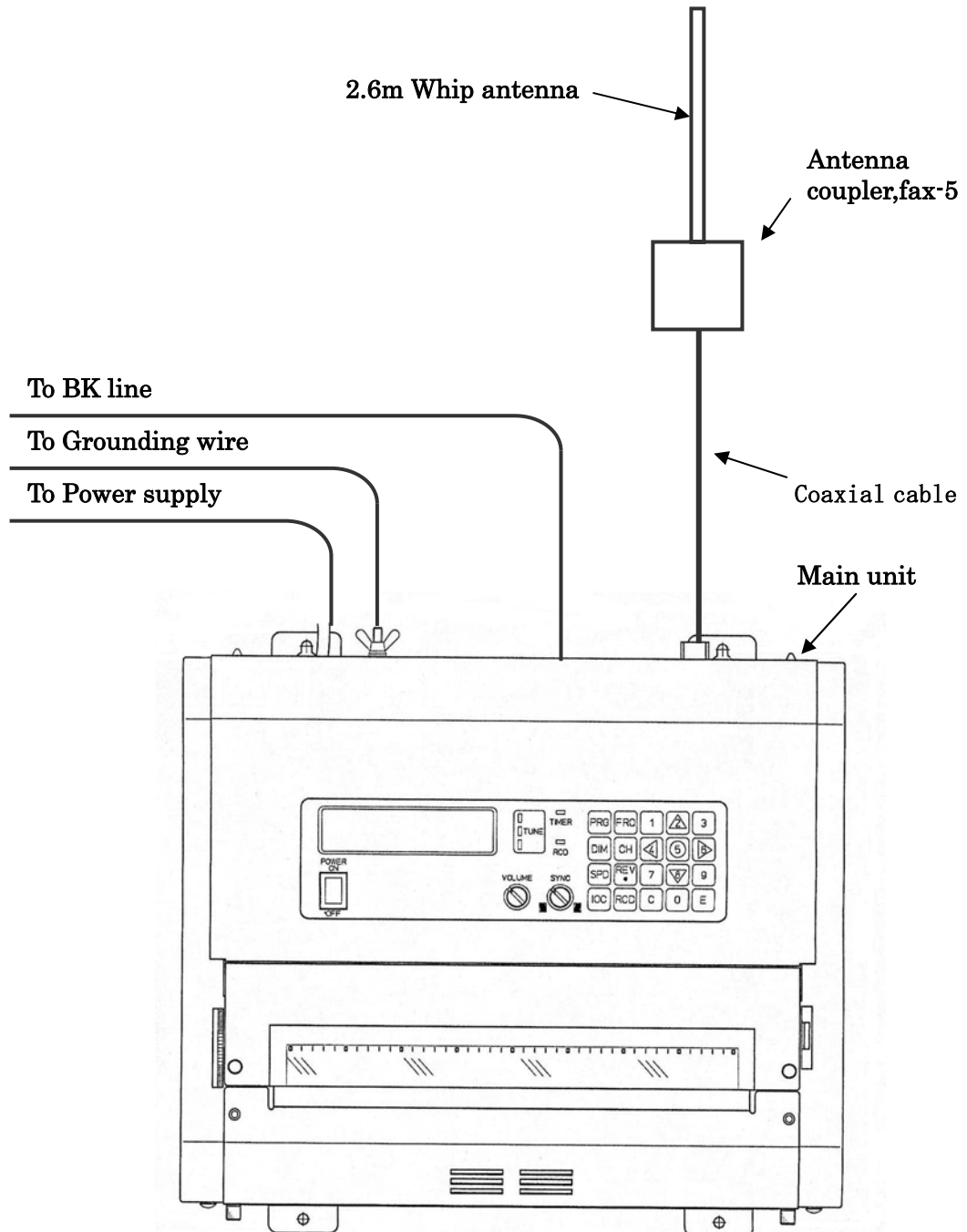



### 1. 3 System Components







## 2. OPERATION

The unit, with antenna(s) and power supply, receives and records signal automatically by the control of APSS when desired channels have been set.



### 2.1 Description of key

 Program key : For preparation to mode setting.  
One of following modes can be selected by pressing  key and next, a  key.  
Be sure to follow instruction of the indicator in selecting a mode. To cancel a setting, press the  key to reset to the initial display of selection mode. Then, press a  key to reset or the  key to set the standard operation mode.



  key : Switch the receiver, internal or external

  key : Set timer reception

  key : Set sleep timer

  key : Set a new frequency or change stored frequency

  key : Set clock time

  key : Set ISB

  key : Clear RAM

 Dimmer key : For adjusting a backlight brightness of the LCD indicator, 4 levels selectable.

 Speed key : For selection of SPD (speed).

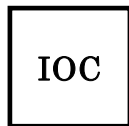

IOC key : For selection of IOC.



Up key : Channel up in the channel mode or frequency up in the frequency mode.

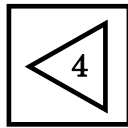

Left key : For manual phasing in recording (towards left).  
A press of the key shifts 2.5% of the paper width.

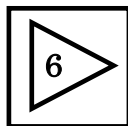

Right key : For manual phasing in recording (towards right).  
A press of the key shifts 2.5% of the paper width.



Down key : Channel down in the channel mode or frequency down in the frequency mode.



Reverse key or dot key : (REV) For reversal of black-white of the recording.  
(.) Decimal point in setting time or frequency.  
A press of the key alternates the (REV)/(.).



Frequency key : For selection of frequency mode from channel mode and for shift to frequency setting in the frequency mode. For frequency setting, press **FRQ** key and enter frequency with **0<sup>N</sup>~9** keys and **REV** key.  
(unit: 0.1kHz, Available frequency for setting are within 80-159.9kHz or 2-24.9999MHz.)

- CH** Channel key : For selection of channel mode from frequency mode, and for shift to the channel setting in the channel mode. For setting a channel, press **CH** key and enter channel number with three **N**<sub>0~9</sub> keys. The channel covers 000~406 (existent frequency) and 410~733 (new frequency).
- C** Clear key : For deletion of memorized value in a set mode and for return to the standard operation mode from a set mode.
- RCD** Record key : To start and stop recording. In the non-recording mode, a press of **RCD** key sets automatic phasing mode and recording starts when phasing is completed. In the automatic phasing, a press of **RCD** key stops the automatic phasing and starts recording. A press of **RCD** key while recording stops recording.
- 5** ○ key : Time display (clock function)
- N**<sub>0~9</sub> Number key : To enter number or mode.
- E** Entry key : To acknowledge setting.

## 2.2 Contrast and brightness

Contrast of LCD display depends on the visual angle and the temperature and hence, be sure to adjust it with the contrast knob (see Fig. 1) for optimum result at the time of installation. The backlight brightness of the LDC can be adjusted in five stages by pressing the **DIM** key.

## 2.3 Basic operation

Power switch is on the left of the front panel. When the power is turned on, the channel at the last power off is displayed.

<b>C000</b>	<b>JMH</b>	<b>3622.5</b>
<b>S120</b>	<b>I576</b>	

The channel [000] is displayed as an example.

C on the left top shows channel display mode.

<b>000</b>	<b>JMH</b>	<b>F</b>	<b>3622.5</b>
<b>S120</b>	<b>I576</b>		

F before frequency shows frequency display mode.

These two display modes are selected alternatively by pressing **FRQ** key or **CH** key.

Channel number is displayed with 3 figures. Upper 2 figures are assigned for a station and last figure represents its own frequency code.

### 2.3.1 Channel setting

A press of **▲**/**▼** key in the channel display mode scrolls channel number. Selection of a channel is possible by pressing **REV** key first and next, three **0~9<sup>N</sup>** keys. When a station is chosen with two **CH** keys and the **0~9<sup>N</sup>** key is pressed, asterisk mark (\*) appears in the 3rd figure and the most sensitive frequency of that station is selected automatically.

### 2.3.2 Fine-adjustment of frequency, and selection of a desired frequency

In the frequency display mode, fine-adjustment of the frequency with a step of 0.1kHz is possible by pressing **▲**/**▼** key. Best tuning is indicated when the green LED is lit on the TUNE display.

It is also possible to select a desired frequency by pressing **FRQ** key first and next, four~six **0~9<sup>N</sup>** keys with **REV** key (available frequency for setting are

within 2000.0~24999.9kHz).

### 2.3.3 Start and stop of recording

#### (1) Start

Recording starts automatically (Start/Stop, Phase, Speed, IOC) by receiving the APSS signal. To start halfway of the received picture, press **RCD** key once and automatic speed setting and auto-phasing mode are set. Then, recording starts upon phasing is completed. When the phase signal for automatic start is not received, recording does not start. Then, press **RCD** key again for manual recording.

#### (2) Stop

Recording stops automatically when auto stop signal is received. In the absence of auto stop signal or to stop halfway, press **RCD** key.

### 2.3.4 Manual phasing

In manual recording mode or when the phasing is not completed in the proper position by auto phasing,

be sure to adjust the phase using the **◀/▶** key.

The phase signal shifts by 2.5% of the paper width or about 6.4mm per keying.

### 2.3.5 Synchronization

When a recorded picture (phase signal, etc.) drifts to left or right, be sure to adjust the synchronization with SYNC knob to stop drift.

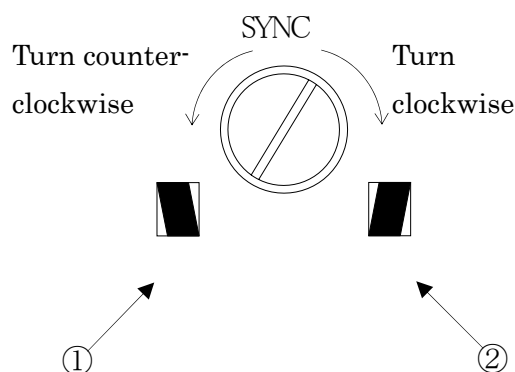

When the picture is such as shown in the left illustration (①), turn the knob counter-clockwise. In case of the right illustration (②), turn the knob clockwise.

### 2.3.6 Selection of reception mode

The reception mode refers IOC, speed, and normal/reverse printing and modes. The former two (IOC and speed) are automatically selected by receiving the APSS signal and phase signal. For the latter two modes, desired ones should be selected manually.

#### (1) Speed and IOC

When incorrect speed or IOC is selected in manual recording or when auto-recording has started at improper position, its setting can be changed with following procedure.

##### a) Change of speed

Press **SPD** key, then the display on the right appears. Press **N<sub>0~9</sub>** key to select correct speed.

```
SPEED:120
1-120  2-90  3-60
```

##### b) Change of IOC

Press **IOC** key, then the display on the right appears. Press **N<sub>0~9</sub>** key to select correct IOC.

```
IOC:576
1-576  2-288
```

#### (2) Reverse mode

When recorded picture is reversed (white/black), follow the procedure below.

Press **REV** key, then the display on the right appears. Press **N<sub>0~9</sub>** key to select mode.

```
REVERSE: OFF
1-OFF  2-ON
```

#### (3) Time display

A built-in clock is provided. The present time is displayed by pressing **5** key in the standard operation mode.

When the displayed time is not correct, be sure to reset the time by following the instructions in 1.4.5.

Right display indicates April 10, Tuesday, 12:00.

```
C000  JMH    3622.5
APR   10  MON 12:00
```

### 2.3.7 Timer release and release of keylock in the timer mode

When the timer is in operation (except sleep timer), function of each key (except **DIM** key) is locked to keep set values and hence, ordinary keying is inhibited.

To release this timer or keylock in the timer mode, follow the procedure below.

- (1) In the timer standby mode (time for the next recording is displayed):

Press **PRG** key then the message on the right is displayed. Then, a press of **E** key releases the timer operation and shifts the mode to the standard operation mode. By pressing **C** key before fix the timer release, the timer standby mode is maintained.

**TIMER RCV : OFF ?  
PUSH E KEY**

- (2) In the timer operation mode (standard operation being displayed):

Press the **PRG** key and the message on the right appears. Fixing with the **E** key releases the keylock (even though in the timer operation mode, each key function is revised and all operations are possible).

**KEY LOCK : OFF ?  
PUSH E KEY**

To release the timer mode in such a case, refer to 1.4.2. When the keylock off is displayed, it is possible to clear the keylock off with the **C** key.

## 2.4 Description of setting mode

Shift to a set mode is made by pressing the **PRG** key. When the mode is set, the message on the right is shown. Pressing the **C** key in this mode, the standard operation mode is reset.

When a **N<sub>0~9</sub>** key is pressed, it is possible to set one of the following modes as explained in 1.4.1~1.4.6.

**SET PRG. NO. 1-9  
ESC PUSH C KEY**

To cancel a setting after shifting to the setting mode and before fix it, press the **PRG** key.

Pressing the **PRG** key resets to the initial setting mode (as displayed above).

### 2.4.1 Switching of receiver (audio)

Switching of the internal or external receiver is set by the following procedure.

Press **1** key. Then the receiver switching mode is set and message on the right appears. The displayed number 1 is for internal

**AF IN : INT  
1-INT 2-EXT**



receiver, 2 is for external receiver. Pressing the **E** key after setting a **0~9<sup>N</sup>** key, completes the setting.

#### 2.4.2 Setting of timer reception

This unit has 16 booking functions and each timer is set as follows.

Press **2** key. Then the timer reception setting mode is set and the message is shown on the right. The displayed number correspond to the following entries respectively.

- 1 : Release
- 2 : Setting
- 3 : Re-calling (readout of the booking data)
- 4 : Entry booking

**TIMER RCV : 1-OFF  
2-ON 3-RCL 4-STR**

##### (1) Release

Press **1** key. Then the message is shown on the right. Pressing the **E** key releases the timer mode

**TIMER RCV : OFF?  
PUSH E KEY**

##### (2) Setting

Press **2** key. Then the message is shown on the right.

Select booking number(s), 0~F, by pressing **Δ**/**▽** key.

The display shown on the right is an example when selecting booking number "0".

Then, press **▷** key to fix the selection

Plural selection of the booking numbers are acceptable. The display shown on the right is an example when select and fix the booking number "0", "1", "2" and "3".

Press the **E** key to complete the setting.

**SET REG No. 0-F  
PUSH Δ/▽&▷&E KEY**

**TIMER RCV NO.: 4  
0123**

##### (3) Re-calling (readout of the booking data)

Press **3** key.

Select a booking number to be confirmed by pressing **Δ**/**▽** key. Then, contents of the booking data is displayed.

**RECALL TIMER REG  
SET REG NO. 0-F**

#### (4) Entry booking

Press **4** key.

Select a timer number for booking by pressing **Δ**/**▽** key. Then, the unit will ask whether the number is correct or not. Fix the number by pressing the **E** key or enter a new number if the number is not correct. The display on the right shows when the number 1 is set.

```
STORE TIMER REG
SET REG NO. 0-F
```

```
R1 SET CHANNEL
NO. in 3 FIGURES
```

Then, enter a channel number with three **N<sub>0~9</sub>** keys (or press two **N<sub>0~9</sub>** keys and **REV** key for automatic setting of the maximum sensitive frequency) and fix with the **E** key or reset a channel with the **C** key.

```
R1 C000 SET DAY
of THE WEEK by Δ ▽
```

Further, set a day of the week with **Δ**/**▽** key and fix it with the **E** key. Then, set start and end time with **N<sub>0~9</sub>** keys from 00:00 to 23:59.

```
R1 C000 MON
SET START/STOP
```

After setting is completed, fix it with the **E** key. To change the time while setting, press the **C** key to reset the time.

After fix with the **E** key, the setting is displayed as shown on the right.

```
08 : 00 - 09 : 00 ?
PUSH E KEY
```

The message on the right is for setting: Channel No.000 at JMH 3MHz, booking No.1, starting Monday 08:00 and ending 09:00.

Be sure to give one minute or longer for time interval between start times of booking.

For example, 12:00~12:30 for No.1 and 12:31~13:00 for No.2.

```
000 JMH 3622.5
1MON 08:00-09:00
```

#### 2.4.3 Sleep timer setting

The sleep timer indicates the sleep mode after a specified time for reception has passed and its setting is made as following.

Press **3** key. Then the message is shown on the right. The displayed numbers refer to

the following operations.

- 1 : Release
- 2 : Setting

(1) Release

Select "1" in the above message, and fix with **E** key. (display on the right)

Note: When the system is in the sleep mode, press **PRG** & **E** keys to shift the mode to the standard operation mode.

SLEEP MODE : OFF  
1-OFF 2-ON

SLEEP MODE : OFF ?  
PUSH E KEY

(2) Setting

Select "2" in the above message, and enter desired time to sleep by **N**<sub>0~9</sub> key (max. 23:59), and fix it with **E** key. To correct or change the entered time before pressing **E** key, press the **C** key for resetting.

SLEEP TIME :  
SET SLEEP TIME

#### 2.4.4 Registration of new frequency

Registration of a new frequency (450~724) or re-writing of an existent frequency (CH000~443) can be made in the following procedure.

Press the **5** key, and the frequency registration mode is set. Then, message shown on the right appears. Enter a channel number with three **N**<sub>0~9</sub> keys.

Right example is for channel 000. To change the entered number, use the **C** key. Then, enter a call sign with the **◀**/**▶** & the **▲**/**▼** key, and fix it with the **E** key.

To correct call sign, press **C** key and re-enter a call sign before pressing **E** key.

The message on the right shows when AAA (3 figures) is entered.

Then, enter a frequency (3~6 figures) with **N**<sub>0~9</sub> keys and **REV** key with a unit of 0.1kHz Available frequency for setting are within 80.0~159.9kHz or 2000.0~24999.9kHz. Press **E** key to fix the registration. To correct the entry halfway, use **C** key for resetting. Further, the speed, IOC, reverse and decoder can besetin sequence.

CHANNEL PROGRAM  
SET CH in 3 FIGS

C000 SET CALL S-  
IGN by ▲▼·◀▶KEY

C000 AAA 0.0  
SET FREQUENCY

SET SPEED 120-60  
1-120 2-90 3-60

SET REVERSE  
1-OFF 2-ON

SET IOC 576/288  
1-576 2-288

#### 2.4.5 Time setting

Clock time can be set by the following procedure.

Pressing the **(5)** key sets the time setting mode and message shown on the right appears.

Set month with **(Δ)**/**(▽)** key, and fix it with **(E)** key.

The message on the right shows entering April. Next, enter date with 2 figures by the **(<sup>N</sup>0~9)** key, and fix it with the **(E)** key. (e.g. April 10<sup>th</sup>)

Then, enter day of the week with **(Δ)**/**(▽)** key, and fix it with the **(E)** key. Message shown on the right indicates Monday.

Finally, enter year (last two figures) and time (hour: 2 figures, minute: 2 figures) each with the **(<sup>N</sup>0~9)** key, and fix with the **(C)** key. To correct the setting halfway, press the **(E)** key for resetting.

SET MONTH  
by **(Δ)**/**(▽)** KEY

APR  
SET DATE in 2FIG

APR 10 SET DAY  
Of THE WEEK by **(Δ)**/**(▽)**

APR 10 MON '  
SET YEAR in 2FIG

SET TIME in 4FIG

APR 10 MON '05  
12:00

#### 2.4.6 Setting of ISB frequency

Signals from multiplex-communication station are easily received by setting an ISB (Independent side band) width as shown in the following.

Pressing **6** key sets the ISB setting mode and the message on the right is shown.

The displayed numbers correspond to the following.

**ISB +0.0KHz : OFF**  
**1-OFF 2-ON 3-QTY**

- 1 : Release
- 2 : Setting
- 3 : Shift quantity entry

##### (1) Release

Press **1** key, and fix with the **E** key orelease the mode.

##### (2) Setting

Press **2** key, and fix with the **E** key, then a displayed amount of frequency is shifted.

Be careful as a frequency shift is set in all channels. When the power is turned on, the shift frequency for all channels is indicated when ISB has been set.

**ISB +1.9kHz : ON**  
**PUSH ENT KEY**

##### (3) Shift quantity entry

Press **3** key.

Then use the **◀/▶** key to decide plus (+) or minus (-), and enter a shift width by **N<sub>0~9</sub>** key (2 figures).

Press the **E** key to fix it. To correct the entry halfway, use the **C** key for re-entry.

**SET ISB in 2FIGS**  
**+/- by · KEY**

#### 2.4.7 Adjustment of contrast

**SET CONTRAST**  
**by Δ/▽ KEY**

**CONTRAST : 9**  
**By Δ/▽ KEY**

Press **7** key, then the contrast adjustment display appears (upper left).

Press **Δ/▽** key to select contrast level for 0 ~ 9. Larger value leads higher contrast.

Press **E/C** key to set and memorize the contrast level.

#### 2.4.8 RAM clearance function

The unit has RAM to memorize the frequency data of the FAX transmitting stations in the world and to retrieve such data. Therefore, when a part or all of RAM data is deleted in error so that the initial data in ROM (data at the time of delivery) has to be retrieved, the following procedure is needed to clear the RAM data. Be careful since all the data in the RAM will be initialized, deleting the data of registered frequencies, etc. when this procedure is performed.

Pressing **9** key sets the RAM clear mode and pressing **E** key clears the RAM data. To stop this procedure, press the **C** key or the **PRG** key.

**RAM CLEAR !!**  
**PUSH ENT KEY**

#### 2.4.9 Attention at the time of operation

Be careful of the following thing when operation.

**[CAUTION]**

If operations other than normal operation are repeated, the keyboard may lock. In such a case, turn the power switch OFF, and turn it ON again.

## 2.5 Operation with external receiver

### (1) External receiver

When an external receiver is used, it should have a local oscillator with very good frequency stability. The A1 detected beat, a low-frequency output, can be monitored with the unit when the signal is supplied through receiver jack of the external receiver. If the signal is supplied from the speaker terminal, it is suggested to use a dummy resistor and supply signal from both ends of the dummy resistor. The signal enters the input terminal (EXT-IN) on the back of the unit and should be 50mV or larger at the input terminal. When an external receiver is of ordinary type, there will be no problem of excessive input since there is a protection circuit inside the unit. However, if direct current is superposed, be sure to input it through a non-polarized capacitor of about  $1 \mu F$ .

### (2) Operation

#### a) Beat adjustment

When using an external receiver whose beat frequency is adjustable within a range of  $\pm 2\text{kHz}$  or more by means of the beat knob, set the frequency dial so as to maximize the deflection of the receiver's "S" meter, and adjust the beat knob so that the center LED of the tuning indicator of the unit is lit. When a signal from station with ISB communication from a U.S. Navy station, e.g., Guam, Pearl Harbor or San Francisco, is received, sometimes an adjustment of the frequency is necessary with a variable condenser or spread variable condenser, because the frequency may shift within a range of  $\pm 2\text{kHz}$  from the specified frequency of the station.

#### b) Band width

When noise is low, a wide bandwidth is advantageous to have good picture quality. However, a narrow bandwidth down to 1kHz is preferable in a noisy condition.

#### c) Selection of external receiver

Refer to 1.4.1 to use an external receiver and also to return to the internal receiver.

#### d) Recording

Refer to 1.3.3 for recording operations and for reverse reception. In reverse reception, set the external receiver to the FBO, LSB or USB mode similarly.

### NOTE

BFO : Beat frequency oscillator

LSB : Lower side band

USB : Upper side band

ISB : Independent side band

## **3. Maintenance**

### **3. 1 Back-up battery**

This device uses a manganese lithium battery as a back-up battery.

Please exchange to new one after using for 5 years.

Ask to a service shop for replacing the back-up battery.

### **3. 2 Lubrication and Cleaning**

#### **(1) Lubrication**

Lubricate a paper sending gear with 1-2 drops of lubricating oil at every 2-3 months.

#### **(2) Cleaning**

Clean the thermal head with attached cotton cleaner at every month.

When garbage has adhered to the thermal head, soak a little ethyl alcohol on cloth and wipe it off. Don't use other than ethyl alcohol.



## 4. INSTALLATION

### 4. 1 Main unit

Install the TF-711 main unit on a plane desk or a solid and plane wall with 4 pcs. of screws and washers.

Caution: A print may become blurred if the installation place is uneven. In that case, put some washers or suitable attachment to adjust the flatness as following figure.

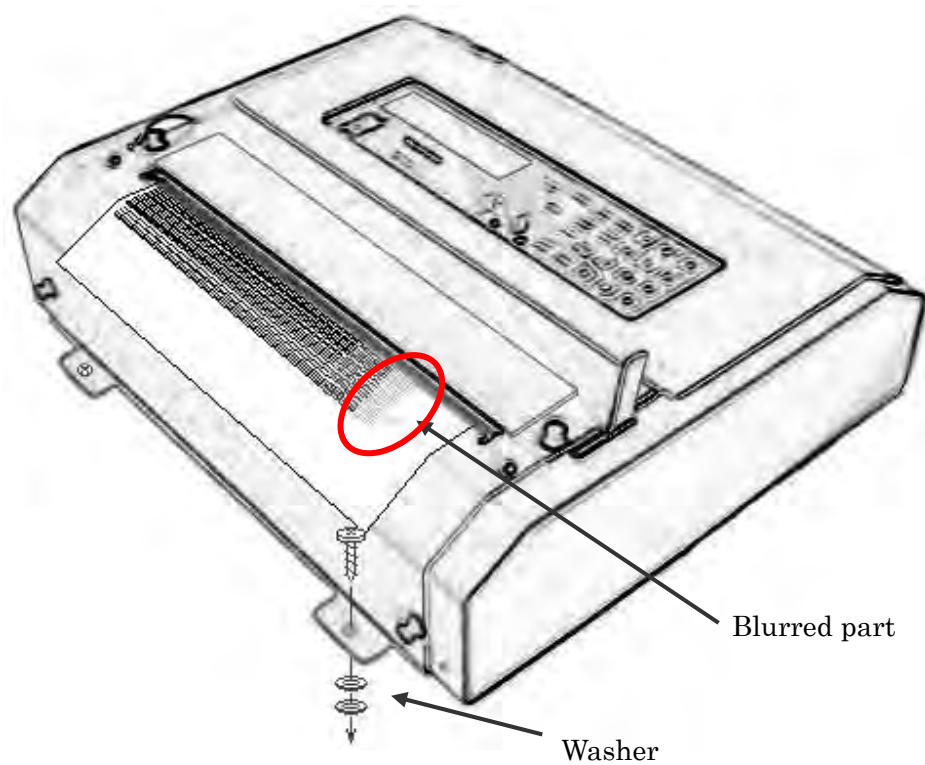

## 4. 2 Wiring

### 4.2.1 DC power supply built-in type

Connect black wire to “-“ (negative), and red wire to “+” (positive).

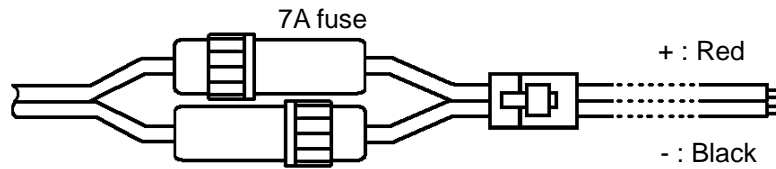

Fig. 4.2.1 DC power cable

### 4.2.2 AC power supply built-in type

Operation voltage (100/115/200/230 VAC) is pre-set at factory in accordance with customer's request.

In case of changing operation voltage, re-adjust the voltage changer inside the AC power supply unit as follows.

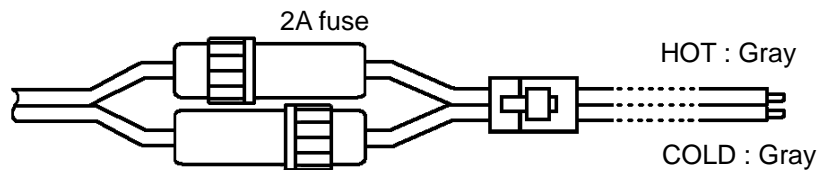

Fig. 4.2.2 AC power cable

Voltage setting:

Referring to drawing in the right, change the short harness (ribbon wire) in accordance with required voltage.

For example, connect the short Harness Between CN4 and CN5 in case of 100 VAC.

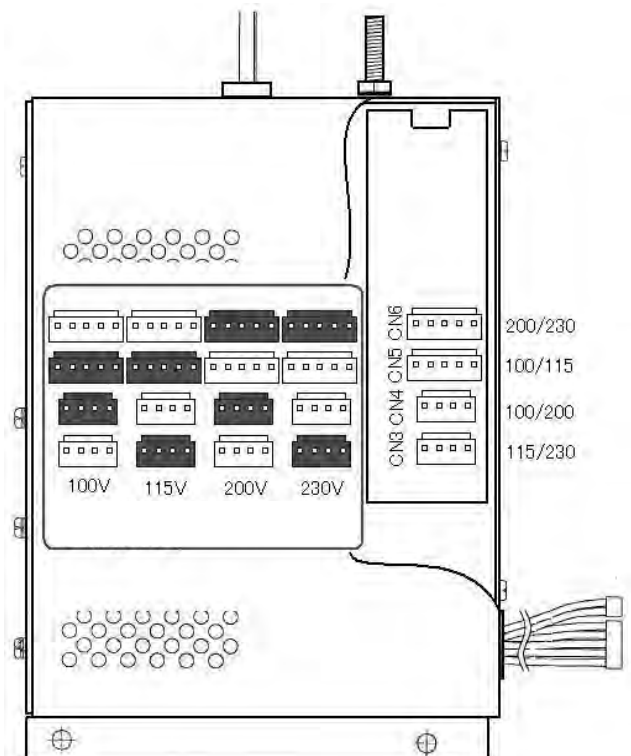
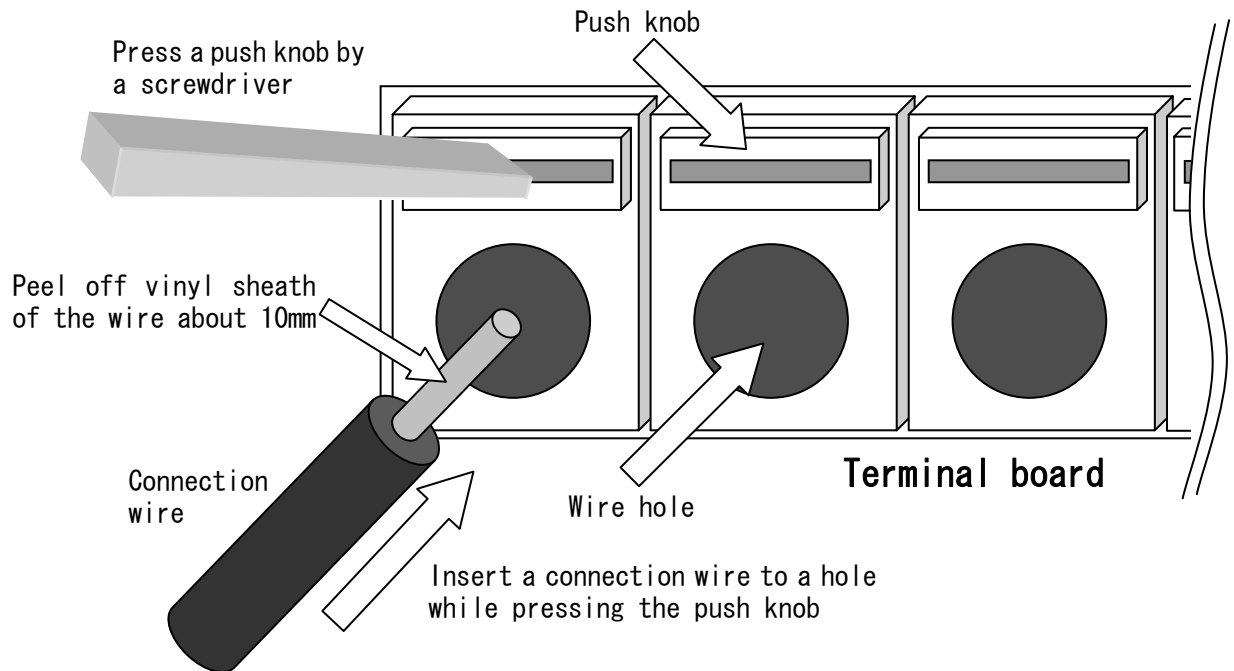

Fig. 4.2.3 AC power supply unit

#### 4. 3 Terminal board

Use terminal board on the rear panel of the main unit for the connection between BK, external receiver or decoder. Insert a connection wire in a terminal in the following ways.



Note: Use connection wire with single core 0.4~1.0mmØ or standard twist core 0.3mm<sup>2</sup>~0.7mm<sup>2</sup>.

##### 4. 3. 1 Connection of BK

Connect BK referring to attached “Layout diagram” in the APPENDIX.

BK voltage is 12 ~ 24 VDC, no polarity.

BK cable is not included in the standard supply scope.

##### 4. 3. 2 Connection with external receiver

Connect with external receiver referring to article 2.5 “Operation with external receiver” (page 17).

## 4. 4 Grounding

A GND terminal is on the rear panel of the main unit.

Be sure to ground the main unit using attached earth wire (3m KIV wire 50/0.45 with copper tube terminal).

## 4. 5 Receiving antenna

Following antennas are suitable to use as the receiving antenna for the FAX-410.

- A) Antenna coupler FAX-5 + 2.6 m whip antenna (supplied by us as option)
- B) Whip antenna (6 m ~ 8 m)
- C) Wire antenna (Reverse-L or T type)

Note: Generally, whip antenna is suitable for reception over 6 MHz, and wire antenna is suitable for reception under 6 MHz.

Receiving sensitivity would become worse when using one antenna for other receivers and/or transmitters through multi-coupler. In that case, please use other antenna or install exclusive antenna.

Be sure to connect BK especially for following case in order to avoid from burning trouble of antenna coil/receiver circuit.

- A) In case of using same antenna which is used for a transmitter
- B) When a transmitting antenna is located near to receiving antenna of FAX-410

Use high frequency coaxial cable as an antenna cable.

When using optional antenna coupler FAX-5, turn ON the switch S1 on BK board inside the main unit.

#### 4. 6 Exchange of a recording paper

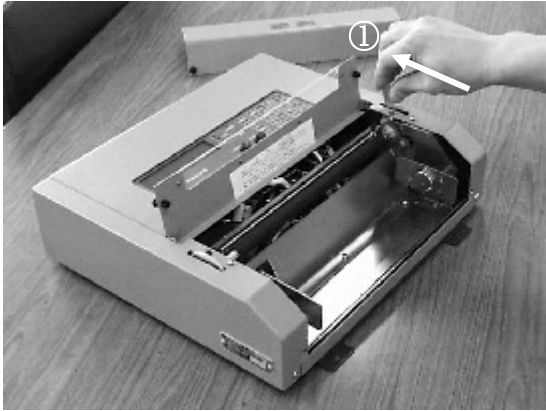

Fig. 1

- (1) Remove the front cover, up the paper cutting plate, slide the paper feed lever in the direction of rear.

(Ref. Fig.1)

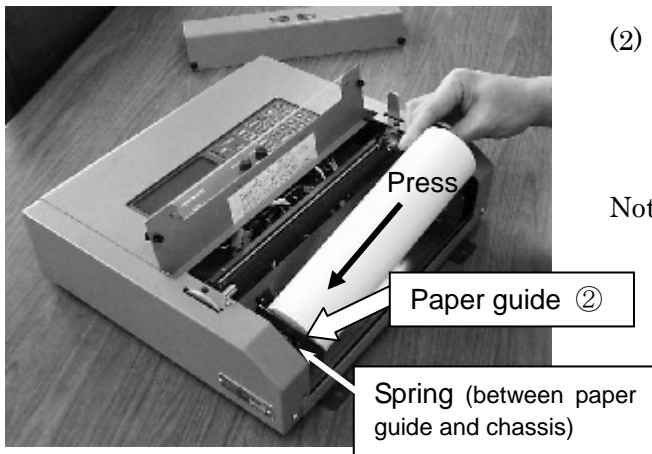

Fig. 2

- (2) Set the roll paper to the holder by pressing a paper guide ② to left side.

(Ref. Fig.2)

Note: The paper guide ② can be moved about 3cm to left, and can be locked by rotating clockwise (about 90 degree).

The lock can be released by rotating the paper guide anti-clockwise (about 90 degree).

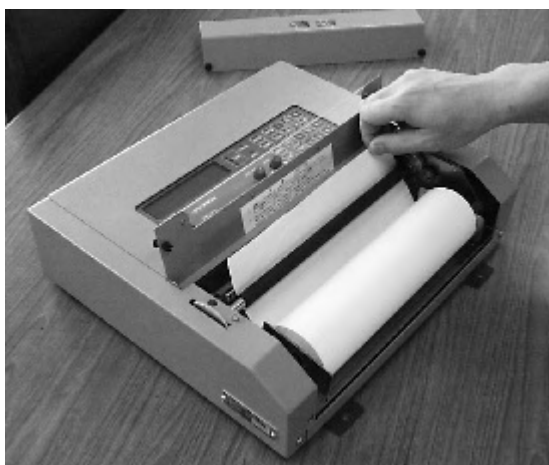

Fig. 3

- (3) Pull out the end of paper upwards from under the rubber roller.

(Ref. Fig.3)



- (4) Pull down ahead the paper feed lever, pulling the end of paper a little ahead.  
(Ref. Fig.4)



- (5) Return the paper cutting plate to the original position.

Fig. 5



- (6) Install the front cover.  
At that time, place the end of paper above the front cover.  
(Ref. Fig.6)

Fig. 6

## 5. SPECIFICATIONS

### 5. 1 Receiver

Reception	: Synthesized double superheterodyne
Frequency range	: MF/HF 2.0000 ~ 24.99999 MHz
Mode	: F3C
Selectivity	: 2.0 kHz at -6 dB
Number of channels	: 315 channels
Sensitivity	: MF/HF 2 $\mu$ V at 20 dB SINAD
Channel selection	: Automatic or manual, digital with ten-key pad
Tuning indicator	: 3 LEDs (light emitting diodes)
Display	: 32 characters in 2 lines with LCDs (liquid crystal display)
Audio input	: Impedance 600 $\Omega$ , frequency 1900 $\pm$ 400 Hz level 0 dBm, or high impedance

### 5. 2 Recorder

Recording system	: Electronic scanning with thermal head
IOC	: Index of cooperation - 576 and 288
Recording speed	: 60, 90, 120 scans per minute
Gradation	: 9 tones (white, 7 gray levels and black)
Recording paper	: Thermal paper (257 mm X 60 m)
Line density	: 8 dots/mm (total number of dots: 2048)

### 5. 3 Automatic Control

Start/stop	: Automatic start or stop by timer program and/or WMO standard remote control signal (or manual)
Recording rate	: Automatic selection of recording rate (or manual)
IOC	: Automatic selection of IOC by WMO start signal (or manual)
Phase	: Automatic selection of phase matching by passing signal (or manual)

### 5. 4 Power, Dimension & Weight

Power source	: DC 10 ~ 40 V, max. 28 W AC 100/115/200/230V, 50 or 60 Hz, max. 30 VA
Dimension	: 93(H) $\int$ 382(W) $\int$ 312.5(D) mm
Weight	: 7.4 kg $\pm$ 0.7 kg (AC type, including recording paper) 6.9 kg $\pm$ 0.7 kg (DC type, including recording paper)

# TABLE OF FACSIMILE STATION

## Table of pre-programmed frequencies and area map

This unit has a ROM (read only memory) which is pre-programmed 150 of existing frequencies of transmitting stations. Stations and frequencies are shown in the map and table respectively.

This table is reference data and is subject to change without previous notice.

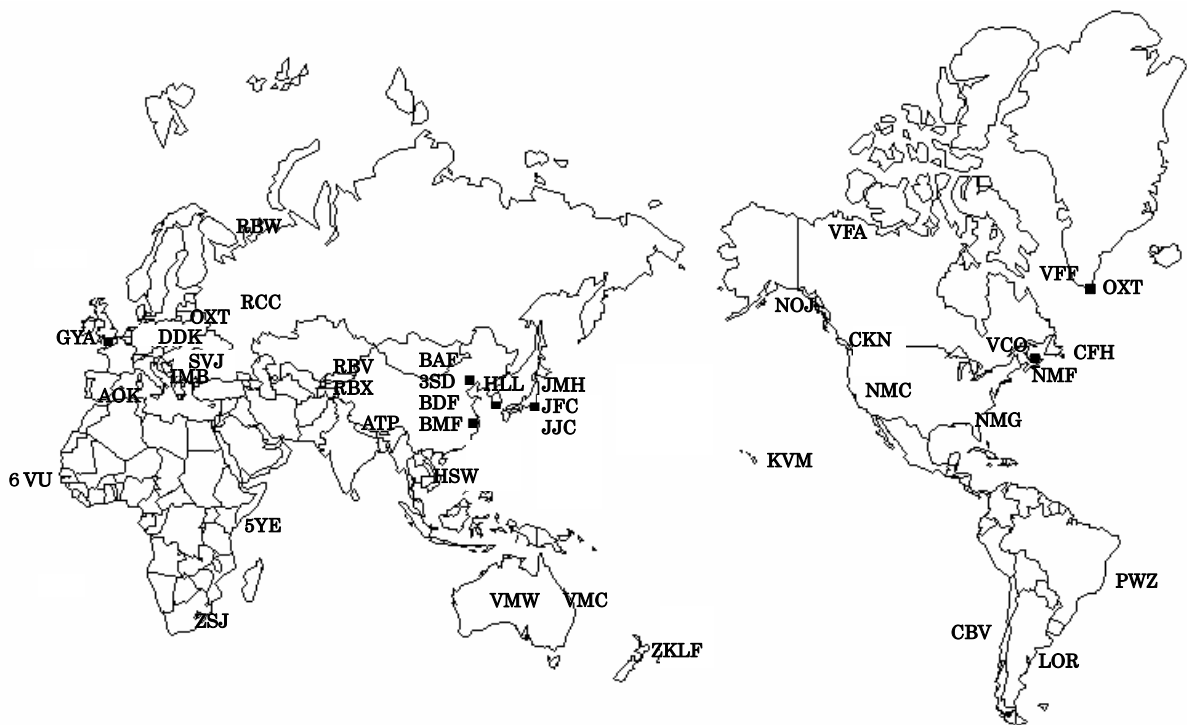



## FACSIMILE STATION TABLE

CHANNEL NO.	CALL SIGN	STATION	FREQUENCY [kHz]	CHANNEL NO.	CALL SIGN	STATION	FREQUENCY [kHz]
000	JMH	JAPAN	3622.5	050	3SD	BEIJING	8461.9
001	JMH	JAPAN	7305.0	051	3SD	BEIJING	12831.9
002	JMH	JAPAN	13597.0	052	3SD	BEIJING	16903.9
010	JJC	MALAYSIA	8467.5	060	BDF	SHANGHAI	3241.0
011	JJC	MALAYSIA	12745.5	061	BDF	SHANGHAI	5100.0
012	JJC	MALAYSIA	16971.0	062	BDF	SHANGHAI	7420.0
013	JJC	MALAYSIA	17069.6	063	BDF	SHANGHAI	11420.0
014	JJC	MALAYSIA	22542.0	064	BDF	SHANGHAI	18940.0
015	JJC	MALAYSIA	17430.0				
020	JFC	JAPAN	4274.0	070	BMF	TAIPAI	4616.0
021	JFC	JAPAN	6414.5	071	BMF	TAIPAI	5250.0
022	JFC	JAPAN	8658.0	072	BMF	TAIPAI	8140.0
023	JFC	JAPAN	13074.0	073	BMF	TAIPAI	13900.0
024	JFC	JAPAN	16907.5	074	BMF	TAIPAI	18560.0
030	HLL	SEOUL	5385.0	080	ZKLF	AUCKLAND	3247.4
031	HLL	SEOUL	5857.5	081	ZKLF	AUCKLAND	5807.0
032	HLL	SEOUL	7433.5	082	ZKLF	AUCKLAND	9459.0
033	HLL	SEOUL	9165.0	083	ZKLF	AUCKLAND	13550.5
034	HLL	SEOUL	13570.0	084	ZKLF	AUCKLAND	16340.1
040	BAF	BEIJING	5526.9	090	VMC	CHARLEVILLE	2628.0
041	BAF	BEIJING	8121.9	091	VMC	CHARLEVILLE	5100.0
042	BAF	BEIJING	10116.9	092	VMC	CHARLEVILLE	11030.0
043	BAF	BEIJING	14366.9	093	VMC	CHARLEVILLE	13920.0
044	BAF	BEIJING	16025.9	094	VMC	CHARLEVILLE	20469.0
045	BAF	BEIJING	18236.9				

CHANNEL NO.	CALL SIGN	STATION	FREQUENCY [kHz]	CHANNEL NO.	CALL SIGN	STATION	FREQUENCY [kHz]
100	VMW	WILUNA	5755.0	180	6VU	DAKAR	4790.5
101	VMW	WILUNA	7535.0	181	6VU	DAKAR	13667.5
102	VMW	WILUNA	10555.0	182	6VU	DAKAR	19750.0
103	VMW	WILUNA	15615.0				
104	VMW	WILUNA	18060.0	190	LOR	PUERTO BELGRANO	5705.0
				191	LOR	PUERTO BELGRANO	12672.0
110	VLM	CASEY	7470.0				
				200	PWZ	RIO DE JANEIRO	12665.0
120	KVM	HONOLULU	9982.5	201	PWZ	RIO DE JANEIRO	16978.0
121	KVM	HONOLULU	11090.0				
122	KVM	HONOLULU	16135.0	210	CBV	VALPARAISO	4228.0
123	KVM	HONOLULU	23331.5	211	CBV	VALPARAISO	8677.0
				212	CBV	VALPARAISO	17146.4
130	HSW	BANGKOK	7396.8				
131	HSW	BANGKOK	17520.0	220	NMG	NEW ORLEANS	4317.9
				221	NMG	NEW ORLEANS	8503.9
140	ATP	NEW DELHI	7404.9	222	NMG	NEW ORLEANS	12789.9
141	ATP	NEW DELHI	14842.0	223	NMG	NEW ORLEANS	17146.4
150	GYA	PERSIAN GULF	3289.5	230	NMF	BOSTON	4235.0
151	GYA	PERSIAN GULF	6834.0	231	NMF	BOSTON	6340.5
152	GYA	PERSIAN GULF	14436.0	232	NMF	BOSTON	9110.0
153	GYA	PERSIAN GULF	18261.0	233	NMF	BOSTON	12750.0
160	5YE	NAIROBI	9044.9	240	CFH	HALIFAX	4271.0
161	5YE	NAIROBI	17447.5	241	CFH	HALIFAX	6496.4
				242	CFH	HALIFAX	10536.0
170	ZSJ	CAPE NAVAL	4014.0	243	CFH	HALIFAX	13510.0
171	ZSJ	CAPE NAVAL	7508.0				
172	ZSJ	CAPE NAVAL	13538.0				
173	ZSJ	CAPE NAVAL	18238.0				





CHANNEL NO.	CALL SIGN	STATION	FREQUENCY [kHz]	CHANNEL NO.	CALL SIGN	STATION	FREQUENCY [kHz]
250	VFF	IQUALUIT & RESOLUTE	3253.0	340	RBV	TASHKENT	3690.0
251	VFF	IQUALUIT & RESOLUTE	7710.0	341	RPJ	TASHKENT	4365.0
260	VCO	SYDNEY,NOVA SCOTIA	4416.0	342	RBV	TASHKENT	5890.0
261	VCO	SYDNEY,NOVA SCOTIA	6915.0	343	RBX	TASHKENT	7570.0
270	VFA	INUVIK	8457.8	344	RCH	TASHKENT	9340.0
280	XL17	AIRBORNE ICET.	4616.0	345	RBV	TASHKENT	14982.5
281	XL17	AIRBORNE ICET.	6915.1	350	RBX	TASHKENT2	3280.0
282	XL17	AIRBORNE ICET.	7708.1	351	RBX	TASHKENT2	5285.0
290		COST GUARD ICE B.	14770.0	352	RLJ	TASHKENT2	8083.0
300	NOJ	KODIAK	2054.0	353	RCH	TASHKENT2	9150.0
301	NOJ	KODIAK	4298.0	354	ROM	TASHKENT2	13947.0
302	NOJ	KODIAK	8459.0	360	RBW	MURMANSK	5336.0
303	NOJ	KODIAK	12412.5	361	RBW	MURMANSK	6445.5
310	NMC	PT.REYES	4346.0	362	RBW	MURMANSK	7908.8
311	NMC	PT.REYES	8682.0	363	RBW	MURMANSK	10130.0
312	NMC	PT.REYES	12786.0	370	GYA	NORTHWOOD	2618.5
313	NMC	PT.REYES	17151.2	371	GYA	NORTHWOOD	4610.0
314	NMC	PT.REYES	22527.0	372	GYA	NORTHWOOD	8040.0
320	IMB	ROMA	4777.5	373	GYA	NORTHWOOD	11086.5
321	IMB	ROMA	8146.6	380	DDH	HAMBURG	3855.0
322	IMB	ROMA	13597.4	381	DDK	HAMBURG	7880.0
330	SVJ	ATHENS	4481.0	382	DDK	HAMBURG	13882.5
331	SVJ	ATHENS	8105.0	390	OXT	SKAMLEBAEK	5850.0
				391	OXT	SKAMLEBAEK	9360.0
				392	OXT	SKAMLEBAEK	13855.0
				393	OXT	SKAMLEBAEK	17510.0

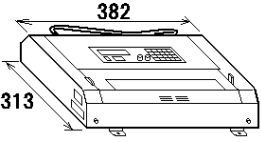
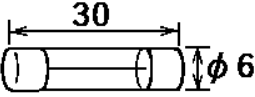
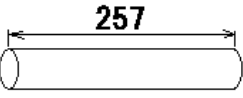

# PACKING LIST

08AX-X-9851 -0 1/1

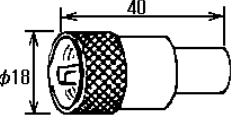
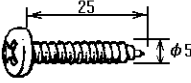
## FAX-410 (AC)

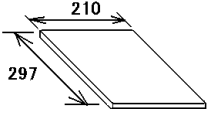
NAME	OUTLINE	DESCRIPTION/CODE No.	Q'TY
<b>ユニット UNIT</b>			
ファクシミリ受画装置 FACSIMILE RECEIVER		FAX-410* 999-999-118	1 (* )
<b>予備品 SPARE PARTS</b>			
管入りヒューズ GLASS TUBE FUSE		2A 999-999-125	4 (* )
<b>付属品 ACCESSORIES</b>			
記録紙 RECORDING PAPER		F220VP 999-999-123	1 (* )
<b>工事材料 INSTALLATION MATERIALS</b>			
アース線 GROUNDING WIRE		2M 999-999-119	1 (* )
同軸プラグ COAX. PLUG		M207-P 999-999-120	2 (* )
ナハタツピンネジ SELF-TAPPING SCREW		5X25 SUS 999-999-121	4 (* )
平座金 FLAT WASHER		M6 999-999-122	5 (* )
<b>図書 DOCUMENT</b>			
取扱説明書 OPERATOR'S MANUAL		999-999-124	1 (* )

(\* )は、ダミーコードに付き、注文できません。

(\* ) THIS CODE CANNOT BE ORDERED.

コード番号末尾の[\*\*]は、選択品の代表コードを表します。

CODE NUMBER ENDING WITH "\*\*" INDICATES THE CODE NUMBER OF REPRESENTATIVE MATERIAL.





(略図の寸法は、参考値です。 DIMENSIONS IN DRAWING FOR REFERENCE ONLY.)

08AX-X-9851

# PACKING LIST

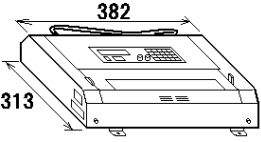
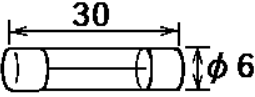
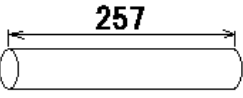
08AX-X-9852 -0 1/1

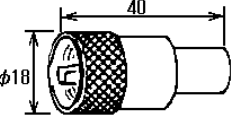
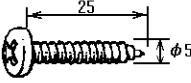
FAX-410 (DC)

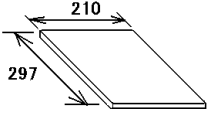
NAME	OUTLINE	DESCRIPTION/CODE No.	Q'TY
<b>ユニット UNIT</b>			
ファクシミリ受画装置 FACSIMILE RECEIVER		FAX-410* 999-999-118	1 (* )
<b>予備品 SPARE PARTS</b>			
管入りヒューズ GLASS TUBE FUSE		7A 999-999-126	4 (* )
<b>付属品 ACCESSORIES</b>			
記録紙 RECORDING PAPER		F220VP 999-999-123	1 (* )
<b>工事材料 INSTALLATION MATERIALS</b>			
アース線 GROUNDING WIRE		2M 999-999-119	1 (* )
同軸プラグ COAX. PLUG		M207-P 999-999-120	2 (* )
ナベタツピンネジ SELF-TAPPING SCREW		5X25 SUS 999-999-121	4 (* )
平座金 FLAT WASHER		M6 999-999-122	5 (* )
<b>図書 DOCUMENT</b>			
取扱説明書 OPERATOR'S MANUAL		999-999-124	1 (* )

(\*)は、ダミーコードに付き、注文できません。

(\*) THIS CODE CANNOT BE ORDERED.

コード番号末尾の[\*\*]は、選択品の代表コードを表します。

CODE NUMBER ENDING WITH "\*\*" INDICATES THE CODE NUMBER OF REPRESENTATIVE MATERIAL.

(略図の寸法は、参考値です。 DIMENSIONS IN DRAWING FOR REFERENCE ONLY.)

08AX-X-9852

Outside view

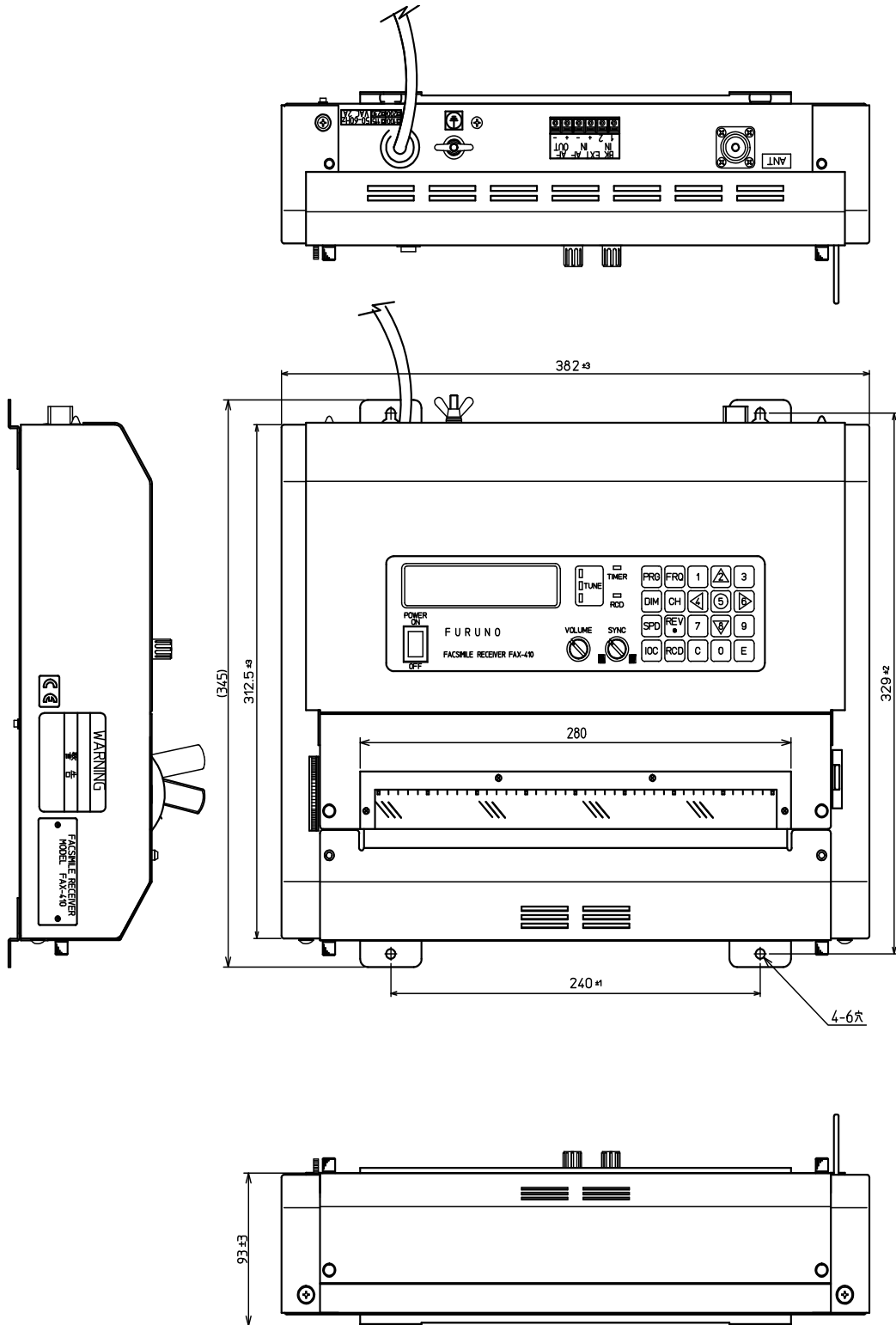

Weight: 7.4kg ± 0.7kg

# Layout diagram

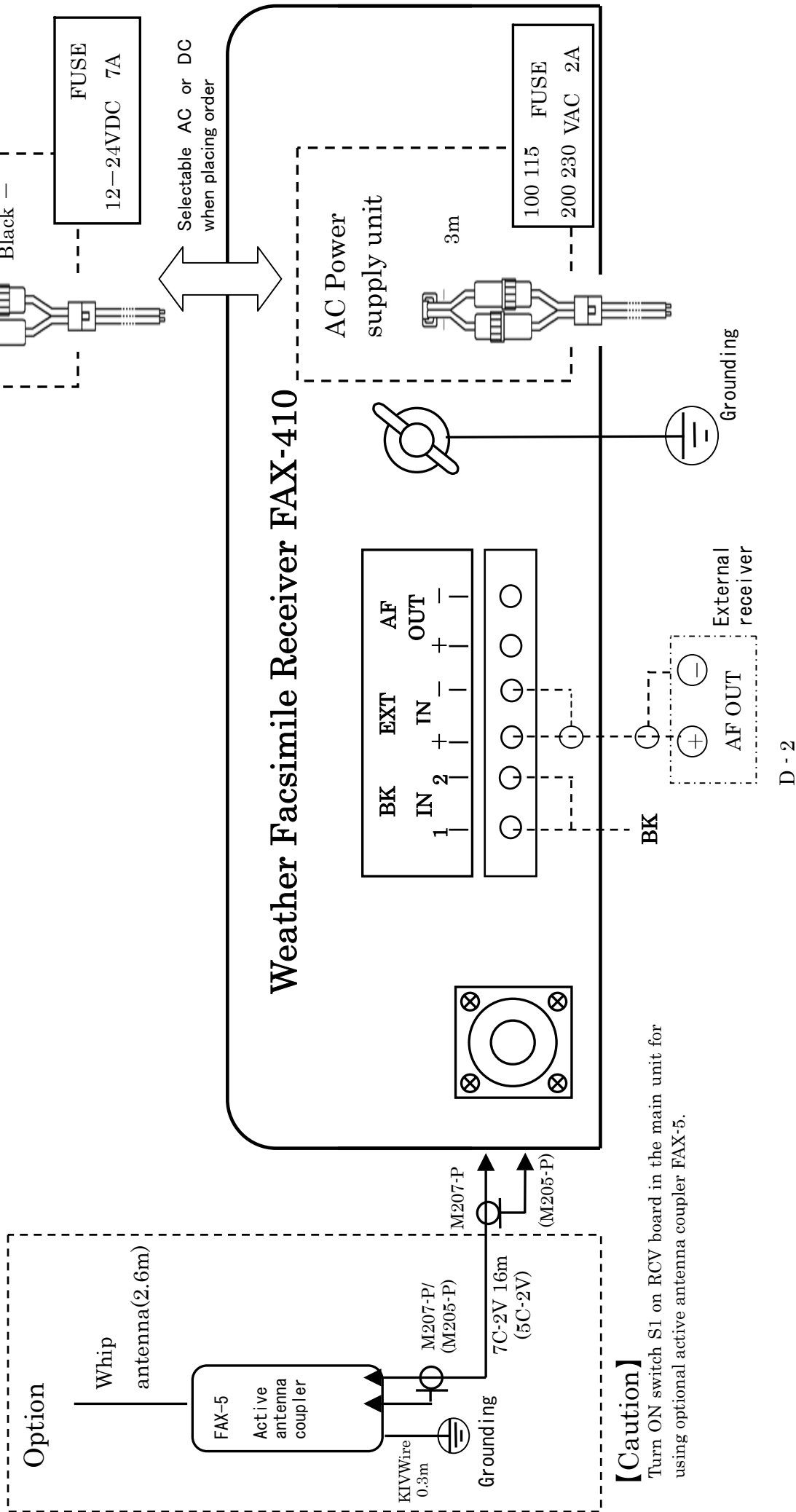

## 【Caution】

Turn ON switch S1 on RCV board in the main unit for using optional active antenna coupler FAX-5.



## Free Manuals Download Website

<http://myh66.com>

<http://usermanuals.us>

<http://www.somanuals.com>

<http://www.4manuals.cc>

<http://www.manual-lib.com>

<http://www.404manual.com>

<http://www.luxmanual.com>

<http://aubethermostatmanual.com>

Golf course search by state

<http://golfingnear.com>

Email search by domain

<http://emailbydomain.com>

Auto manuals search

<http://auto.somanuals.com>

TV manuals search

<http://tv.somanuals.com>