

FURUNO

OPERATOR'S MANUAL

COLOR LCD SOUNDER

MODEL FCV-600L



FURUNO ELECTRIC CO., LTD.
NISHINOMIYA, JAPAN

© **FURUNO ELECTRIC CO., LTD.**

9-52, Ashihara-cho,
Nishinomiya, Japan

Telephone: 0798-65-2111
Telefax: 0798-65-4200

•Your Local Agent/Dealer

All rights reserved. Printed in Japan

FIRST EDITION : APR. 1998
H3 : OCT. 7, 2002

(DAMI) PUB. No. OME-23620
FCV-600L



* 00080821800 *



* OME23620H30 *



SAFETY INSTRUCTIONS

WARNING



Do not open the equipment.

ELECTRICAL SHOCK HAZARD. Only qualified personnel should work inside the equipment.

Immediately turn off the power at the switchboard if water leaks into the equipment.

Continued use of the equipment can cause fire or electrical shock. Contact a FURUNO agent for service.

Do not disassemble or modify the equipment.

Fire, electrical shock or serious injury can result.

Immediately turn off the power at the switchboard if the equipment is emitting smoke or fire.

Continued use of the equipment can cause fire or electrical shock. Contact a FURUNO agent for service.

Make sure no rain or water splash leaks into the equipment.

Fire or electrical shock can result if water leaks in the equipment.

WARNING

Keep heater away from equipment.

A heater can melt the equipment's power cord, which can cause fire or electrical shock.

Use the proper fuse.

Use only a 3A fuse. Use of a wrong fuse can result in equipment damage and void the warranty.

CAUTION

A warning label is attached to the equipment. Do not remove the label. If the label is peeling off or is illegible, contact a FURUNO agent or dealer.

About the TFT LCD

The TFT LCD is constructed using the latest LCD techniques, and displays 99.99% of its pixels. The remaining 0.01% of the pixels may drop out or blink, however this is not an indication of malfunction.

TABLE OF CONTENTS

| | |
|-------------------------------------|-----|
| FOREWORD | iii |
| MENU TREE | iv |
| SYSTEM CONFIGURATION | v |
| PRINCIPLE OF OPERATION | vi |

OPERATIONAL OVERVIEW

| | |
|---|----|
| 1.1 Control Description | 1 |
| 1.2 Indications, Markers | 2 |
| 1.3 Turning On/Off the Power | 3 |
| 1.4 Adjusting Tone and Brilliance | 3 |
| 1.5 Selecting a Display | 3 |
| 1.6 Selecting Display Range | 7 |
| 1.7 Adjusting the Gain | 7 |
| 1.8 Automatic Operation | 8 |
| 1.9 Selecting Picture Advance Speed | 8 |
| 1.10 Erasing Weak Echoes | 9 |
| 1.11 Measuring Depth | 9 |
| 1.12 A-scope Display | 10 |
| 1.13 User Menu | 10 |
| 1.14 Suppressing Interference | 11 |
| 1.15 Suppressing Low Level Noise | 11 |
| 1.16 Selecting Background and Echo Colors | 11 |
| 1.17 Alarms | 12 |
| 1.18 White Marker | 13 |
| 1.19 Fine Adjustment of Gain in Dual-Frequency Operation | 13 |

OPTIONAL MODE

| | |
|--|----|
| 2.1 Displaying the Optional Mode Menu .. | 15 |
| 2.2 System Menu | 15 |
| 2.3 Demonstration Display | 17 |
| 2.4 Bottom Level | 17 |
| 2.5 TVG Level | 18 |
| 2.6 Echo Offset | 18 |

INTERPRETING THE DISPLAY

| | |
|----------------------------------|----|
| 3.1 Zero Line | 19 |
| 3.2 Fish School Echoes | 19 |
| 3.3 Bottom Echo | 19 |
| 3.4 Surface Noise/Aeration | 20 |

MAINTENANCE & TROUBLESHOOTING

| | |
|-------------------------------------|----|
| 4.1 Checking | 21 |
| 4.2 Cleaning the Display Unit | 21 |
| 4.3 Transducer Maintenance | 21 |
| 4.4 Replacing the Fuse | 21 |
| 4.5 Troubleshooting | 22 |
| 4.6 Test | 23 |
| 4.7 Test Pattern | 23 |
| 4.8 Clearing the Memory | 24 |

SPECIFICATIONS..... SP-1

FOREWORD

A Word to FCV-600L Owners

Congratulations on your choice of the FURUNO FCV-600L Color LCD Sounder. We are confident you will see why the FURUNO name has become synonymous with quality and reliability.

For over 50 years FURUNO Electric Company has enjoyed an enviable reputation for innovative and dependable marine electronics equipment. This dedication to excellence is furthered by our extensive global network of agents and dealers.

This equipment is designed and constructed to meet the rigorous demands of the marine environment. However, no machine can perform its intended function unless operated and maintained properly. Please carefully read and follow the recommended procedures for operation and maintenance.

We would appreciate hearing from you, the end-user, about whether we are achieving our purposes.

Thank you for considering and purchasing FURUNO equipment.

Features

The FURUNO FCV-600L is a dual-frequency (50 kHz and 200 kHz) color LCD sounder. Comprised of a display unit and a transducer, the FCV-600L displays underwater conditions in 16 colors (including background) on a bright 5.6-inch color TFT (Thin Film Transistor) LCD.

The main features of the FCV-600L are

- Compact design permits installation where space is limited.
- Bright 5.6-inch color LCD with temperature compensated tone and brilliance control.
- Wide variety of display modes: bottom lock, dual frequency, marker zoom, bottom zoom, nav data and graphic display.
- Automatic function permits unattended adjustment of range and gain. The range scale and gain automatically change to display the bottom in reddish-brown on the lower half of the screen.
- Navigation data display (requires navigation data input from external navigator) provides position, course, speed, depth, temperature and waypoint data indications.
- Alarms: Bottom, Fish (bottom-lock, normal), Temperature (within, over range set).
- A-scope display discriminates bottom fish, vital for bottom trawler and trap users.
- Waterproof construction permits installation on open bridge.
- Universal 10.2–31.2 VDC power supply consuming less than 15 W power.

MENU TREE

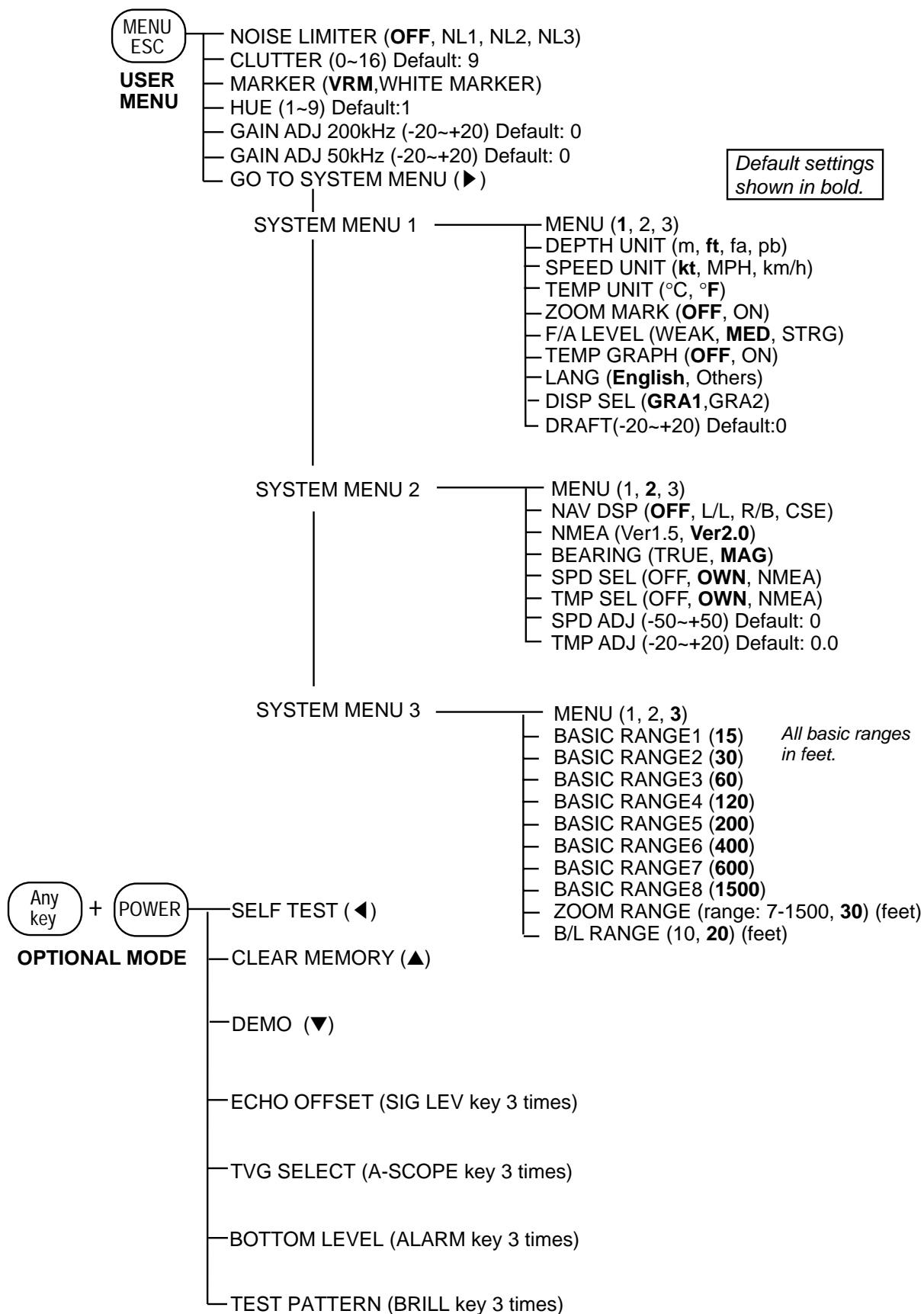

SYSTEM CONFIGURATION

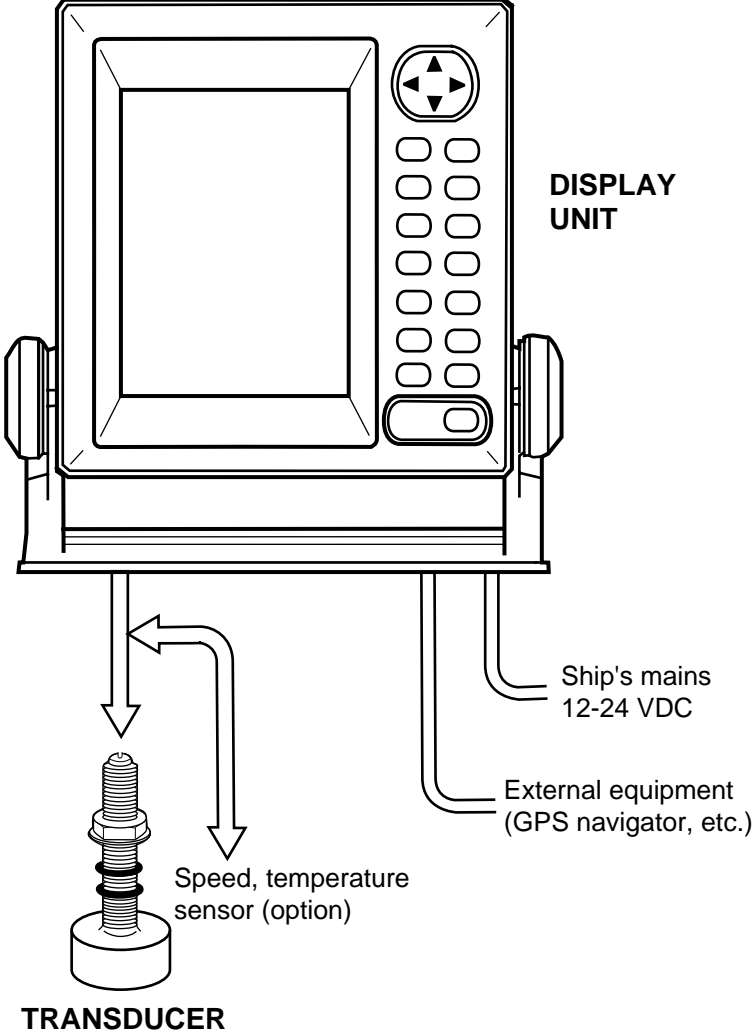

FCV-600L system configuration

PRINCIPLE OF OPERATION

The FCV-600L determines the distance between its transducer and underwater objects such as fish, lake bottom or seabed and displays the results on its screen. It does this by utilizing the fact that an ultrasonic wave transmitted through water travels at a nearly constant speed of 4800 feet (1500 meters) per second. When a sound wave strikes an underwater object such as fish or sea bottom, part of the sound wave is reflected back toward the source. Thus by calculating the time difference between the transmission of a sound wave and the reception of the reflected sound wave, the depth to the object can be determined.

The entire process begins in the display unit. Transmitter power is sent to the transducer as a short pulse of electrical energy. The electrical signal produced by the transmitter is converted into an ultrasonic signal by the transducer and transmitted into the water. Any returning signals from intervening objects (such as a fish school) are received by the transducer and converted into an electrical signal. The signals are then amplified in the amplifier section, and finally, displayed on the screen.

The picture displayed is made up of a series of vertical scan lines, one for each transmission. Each line represents a snapshot of what has occurred beneath the boat. Series of snapshots are accumulated side by side across the screen, and the resulting contours of the bottom and fish between the bottom and surface are displayed.

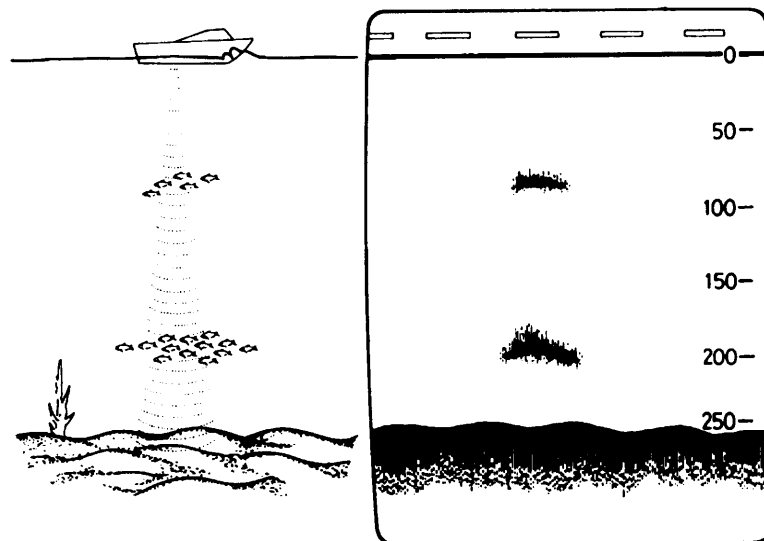

Underwater conditions and video sounder display

OPERATIONAL OVERVIEW

1.1 Control Description

All operations of the FCV-600L are carried out with the controls on the front panel of the display unit. All controls respond immediately to your command and the unit emits a beep to signify correct key sequence. (Invalid key input emits several beeps.)

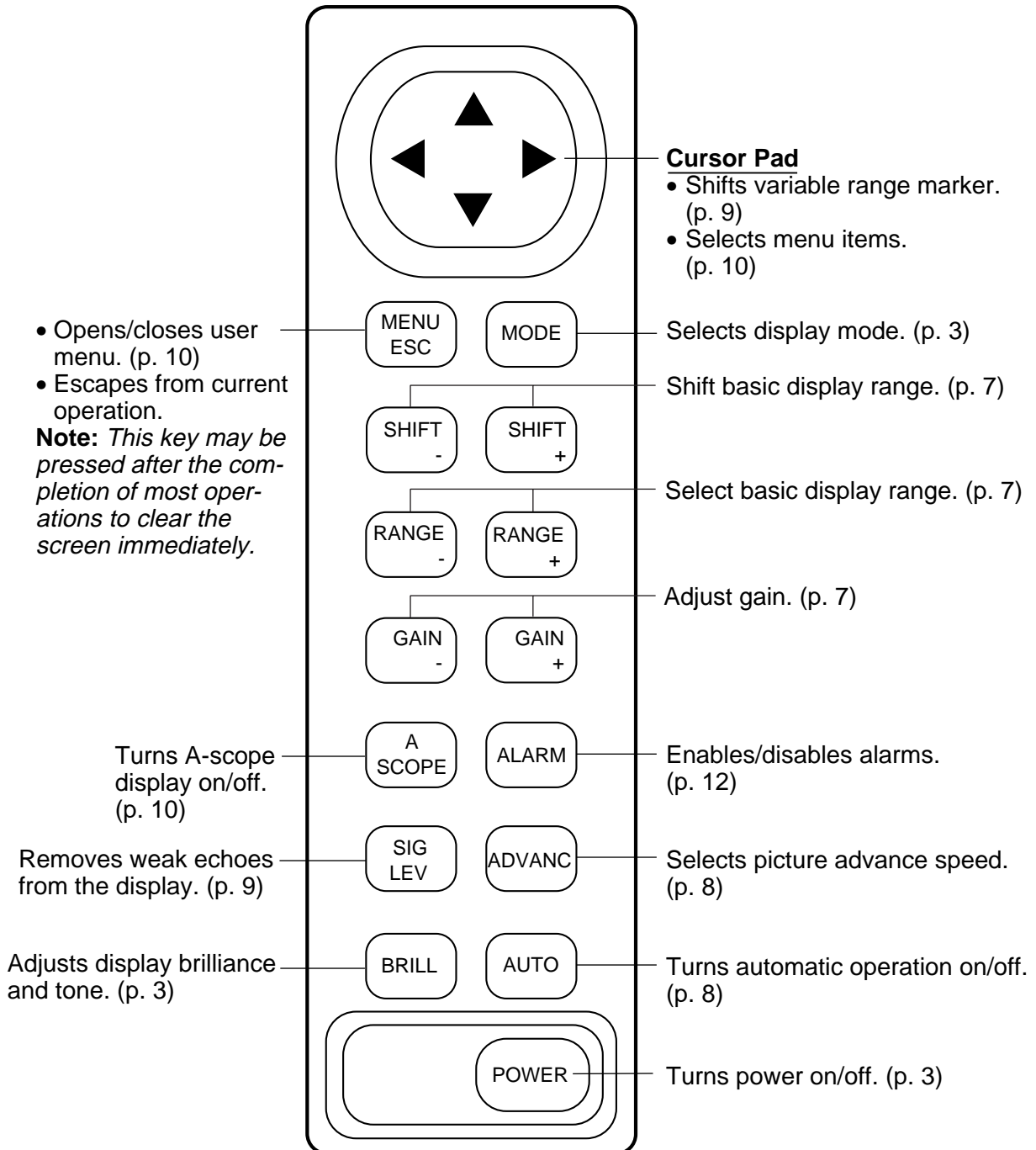

Figure 1-1 Controls

1.2 Indications, Markers

The figure below shows all indications and markers which may appear in the normal display. The combination displays (normal display plus marker or zoom display) may additionally display the zoom marker.

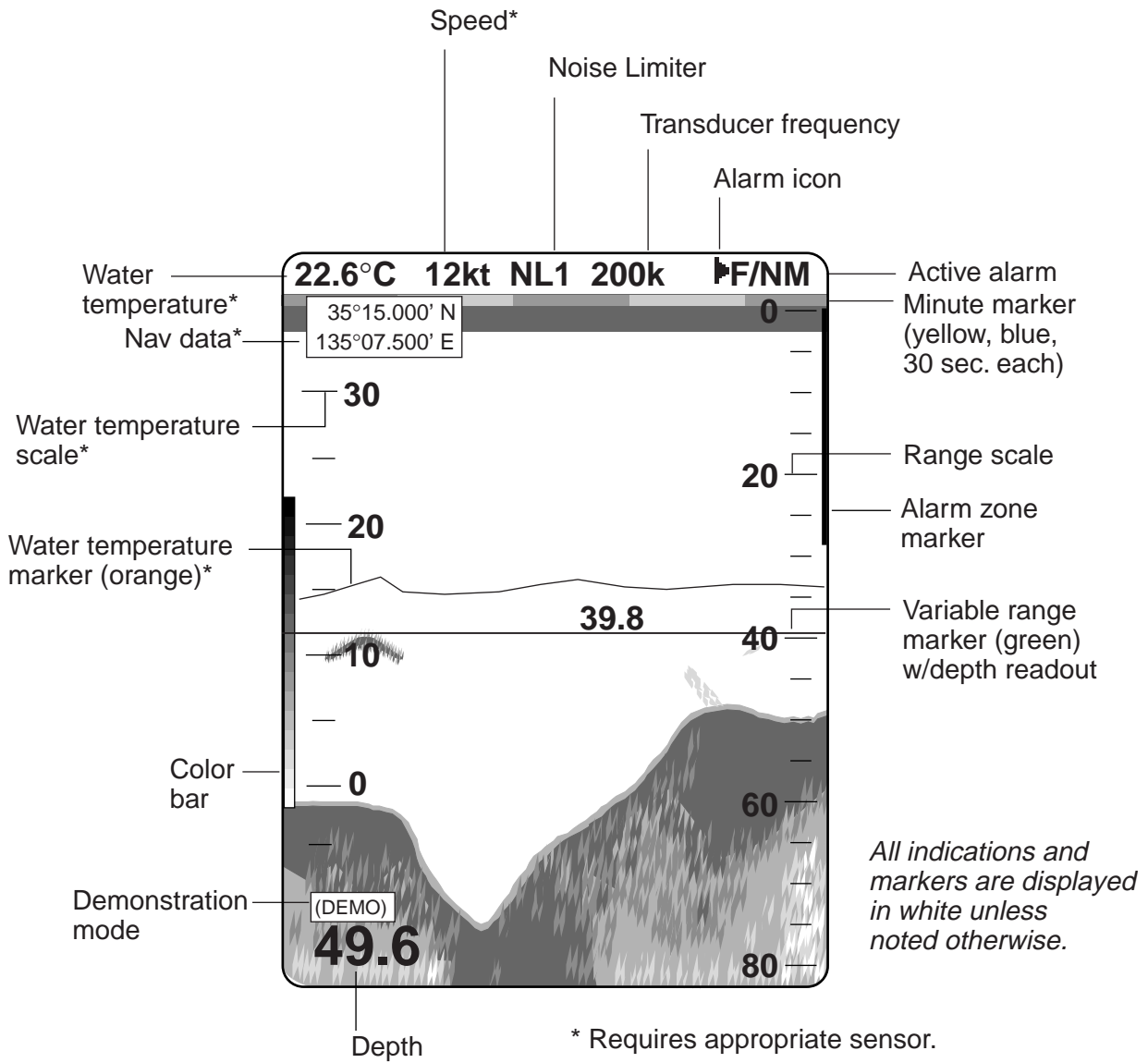
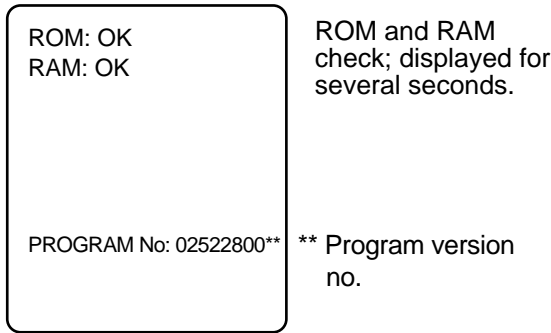

Figure 1-2 Indications

1.3 Turning On/Off the Power

Press the POWER key to turn the power on/off. When the unit is turned on it proceeds in the sequence shown below.



↓ You may press any key to show the sounder display immediately.

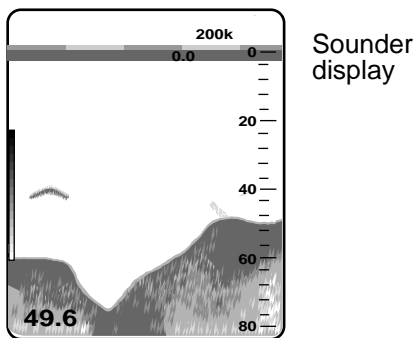

Figure 1-3 Start-up sequence

Note: Wait at least five sec. before reapplying the power.

1.4 Adjusting Tone and Brilliance

1. Press the BRILL key. The tone and brilliance setting display appears.



Figure 1-4 Tone and brilliance setting display

2. Press ◀ or ▶ to adjust display tone.
3. Press ▲ or ▼ to adjust display brilliance.

Note: Tone or brilliance must be adjusted within about 10 seconds after pressing the BRILL key or the tone and brilliance display will be erased.

1.5 Selecting a Display

Seven displays are available: normal (50 or 200 kHz), dual frequency, marker zoom, bottom zoom, bottom lock, data, and graphic. (An A-scope display is also available with the A-SCOPE key.)

1. Press the MODE key.

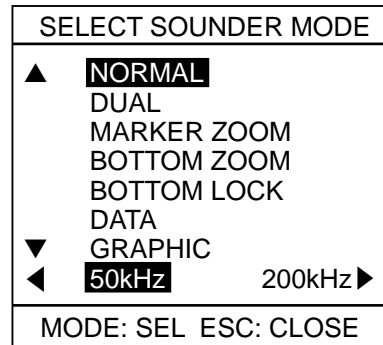

Figure 1-5 Select sounder mode screen

2. Press the MODE key again to select a sounder mode. You may also select a sounder mode by pressing ▲ (upward) or ▼ (downward).
3. Press the MENU ESC key to conclude your selection.

Normal display

50 kHz

The sounder uses ultrasonic pulses to detect bottom conditions. The lower the frequency of the pulse, the wider the detection area. Therefore, the 50 kHz frequency is useful for general detection and judging bottom condition.

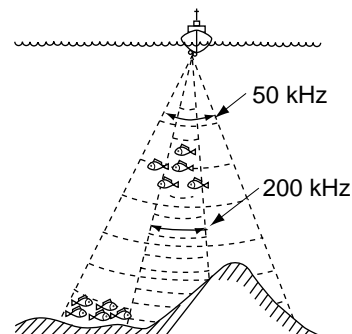

Figure 1-6 Comparison of detection ranges of 50 kHz and 200 kHz transducers

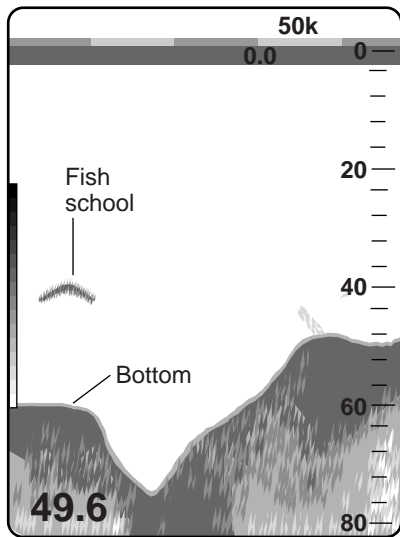

Figure 1-7 Typical 50 kHz normal display

200 kHz

The higher the frequency of the ultrasonic pulse the better the resolution. Therefore, the 200 kHz frequency is ideal for detailed observation of fish schools.

Dual-frequency display

The 50 kHz picture appears on the left; the 200 kHz picture on the right. This display is useful for comparing the same picture with two different transmitting frequencies.

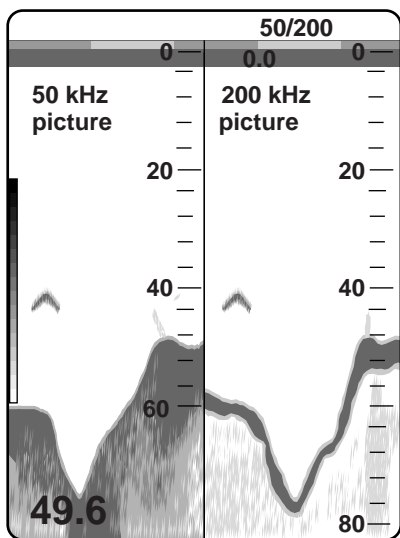

Figure 1-8 Dual-frequency display

Marker-zoom display

This mode expands selected area of the normal picture to full vertical size of the screen on the left-half window. You may specify the portion to expand by operating the VRM (Variable Range Marker), which you can shift with ▲ or ▼. The area between the VRM and zoom range marker is expanded. The length of the segment is equal to one division of the depth scale.

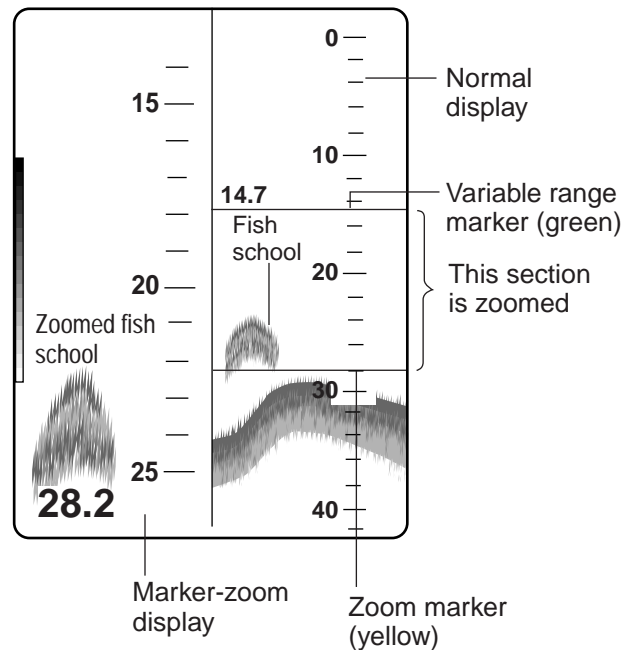

Figure 1-9 Marker-zoom display plus normal display

Bottom-zoom display

This mode expands bottom and bottom fish echoes two to five times to vertical size of the screen, and is useful for determining bottom hardness. A bottom displayed with a short echo tail usually means it is a soft, sandy bottom. A long echo tail means a hard bottom.

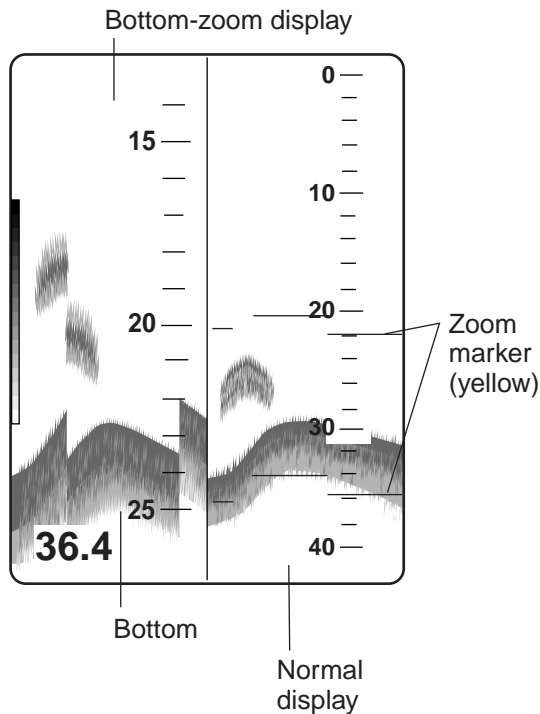

Figure 1-10 Bottom-zoom display plus normal display

Bottom-lock display

The bottom-lock display provides a compressed normal picture on the right half of the screen and a 5 or 10 meter (10 or 20 feet) wide layer in contact with the bottom is expanded onto the left half of the screen. This mode is useful for bottom discrimination.

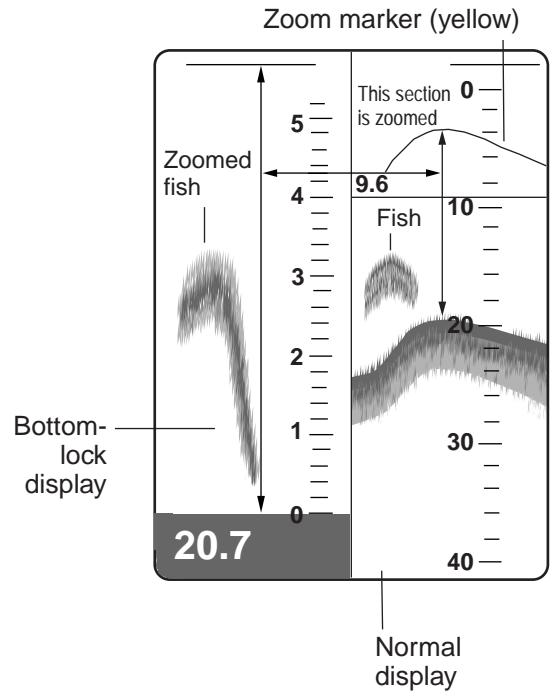

Figure 1-11 Bottom-lock display plus normal display

Note: The zoom marker is not displayed in the default setting. It may be turned on in System menu 1. For further details see page 15.

Data display

This display provides navigation data in digital form. Position, course, speed, depth, water temperature and waypoint data can be shown. Requires nav data input and appropriate sensors.

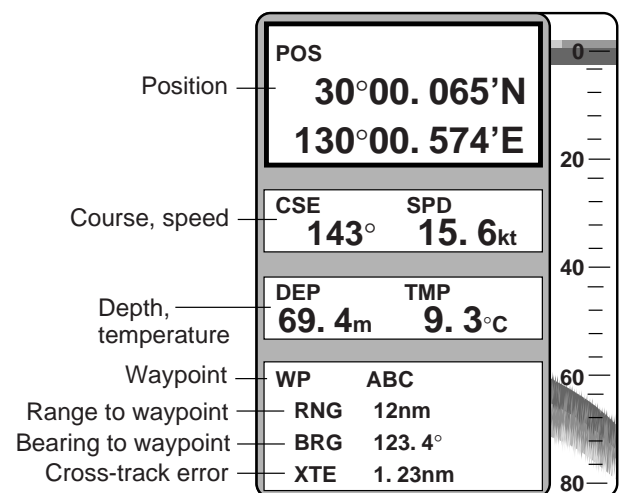

Figure 1-12 Data display

Enlarging a nav data indication

You can enlarge and display one of the data indications as follows:

1. Press ▲ or ▼ to select the indication you want to display. A blue cursor circumscribes your selection. For example, select the waypoint data window.
2. Press ► to enlarge the data.

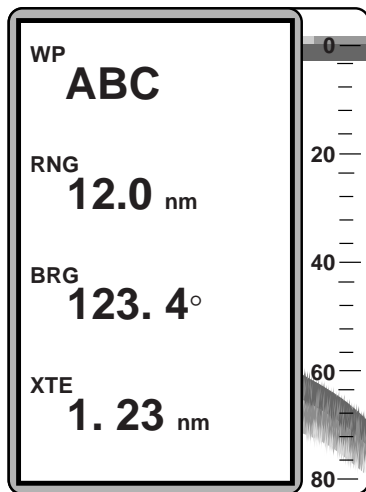

Figure 1-13 WP data window enlarged

3. To return to the full data display, press ◀.

Graphic displays

There are two types of graphic displays and you can select which one to display on the SYSTEM MENU1.

Graphic display 1

This display provides analog and digital displays of cross-track error (XTE), course and bearing. It is useful for monitoring progress toward a waypoint. The XTE scale in the center of the display, graduated in increments of 0.1 nm, shows cross-track error, the direction and distance the boat is off course. In the example below the XTE marker (red) shows the boat is off course by 0.2 nm starboard. Therefore you would steer left by the same distance to return to course.

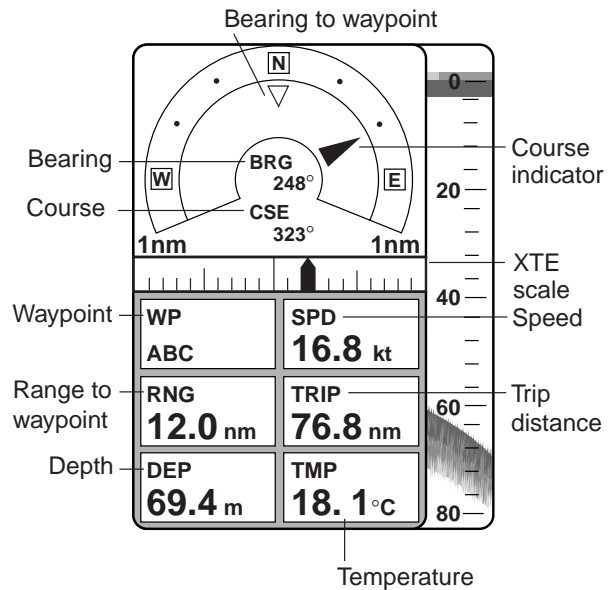

Figure 1-14a Graphic display 1

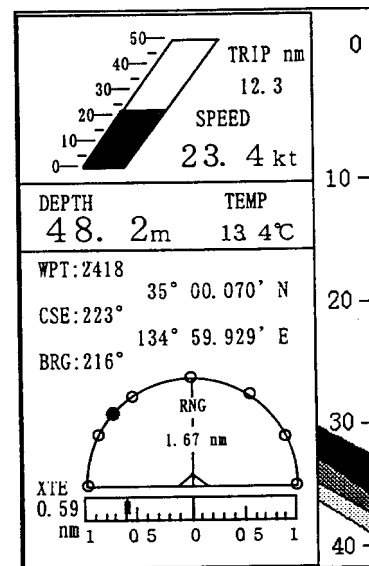

Figure 1-14b Graphic display 2

Resetting trip distance on graphic displays

The trip distance indication displays the distance the boat has traveled. To reset the indication to zero, press ◀ or ► until the indication reads zero.

1.6 Selecting Display Range

The basic range and range shifting functions used together give you the means to select the depth you can see on the screen. The basic range can be thought of as providing a “window” into the water column and range shifting as moving the “window” to the desired depth.

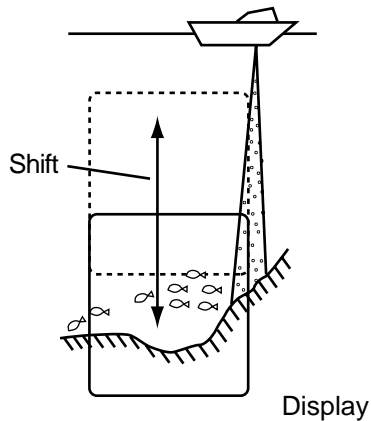

Figure 1-15 Range and display shift concept

Basic range selection

The basic range may be selected with the RANGE keys from the eight ranges shown in the table below.

Table 1-1 Basic ranges (default settings)

| Unit | Display Range | | | | | | | |
|-------------|---------------|----|----|-----|-----|-----|-----|------|
| | 1 | 2 | 3 | 4 | 5 | 6 | 7 | 8 |
| Meters | 5 | 10 | 20 | 40 | 80 | 150 | 200 | 500 |
| Feet | 15 | 30 | 60 | 120 | 200 | 400 | 600 | 1500 |
| Fathoms | 3 | 5 | 10 | 20 | 40 | 80 | 100 | 250 |
| Passi/Braza | 3 | 5 | 10 | 30 | 50 | 100 | 150 | 300 |

Press a RANGE key and the display shown below appears. Press a RANGE key again to select a basic range.



Figure 1-16 Range display

Range shifting

The basic range may be shifted up or down with the SHIFT keys. Press a SHIFT key and the display shown below appears. Press a SHIFT key again to select the amount of shift.



Figure 1-17 Shift display

Note 1: The RANGE and SHIFT keys are inoperative in automatic operation. See next page for details.

Note 2: The maximum shift range is 1500 feet (500 m). However, actual range will depend on underwater conditions. In the worst case echoes will not appear.

1.7 Adjusting the Gain

The GAIN keys adjust the sensitivity of the receiver. Adjust them so that a slight amount of noise remains on the screen. Generally, use a higher gain setting for greater depths and a lower setting for shallower waters.

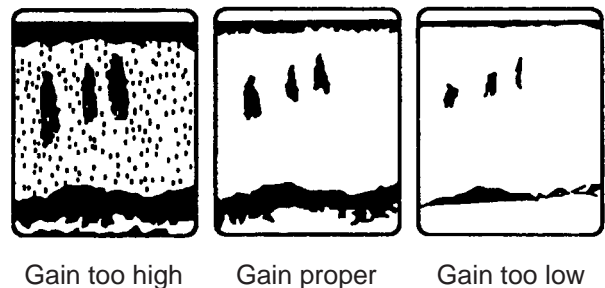

Figure 1-18 Examples of proper and improper gain

Press a GAIN key and the display shown below appears. Press a GAIN key again to adjust the gain. Note that the GAIN keys are inoperative in automatic operation.

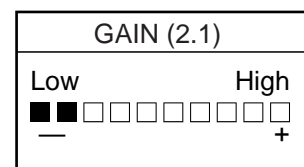

Figure 1-19 Gain setting display

1.8 Automatic Operation

Automatic operation is useful when you are preoccupied with other tasks and do not have time to adjust the display.

How it works

The automatic function automatically selects the proper gain and range scale according to depth. It works as follows:

- The range changes automatically to locate the bottom on the lower half of the screen. It jumps to one step shallower range when bottom echoes reach a halfway point of the full scale from top and to one step deeper range when they come to the lower edge of the scale.
- The gain is automatically adjusted to display the bottom echo in reddish-brown (default color arrangement).
- Clutter level (on the User menu), which suppresses low level noise, is automatically adjusted.

Two types of automatic modes

Two types of automatic modes are available: cruising and fishing. Cruising is for tracking the bottom; fishing is for searching fish schools. Since cruising uses a higher clutter rejection setting than fishing, it is not recommended for fish detection – weak fish echoes may be deleted by clutter rejection. Note that the SHIFT, RANGE and GAIN keys are inoperative in the auto mode.

How to enable automatic operation

1. Press the AUTO key. The auto mode display appears.

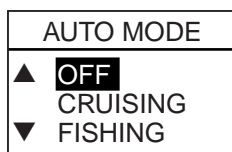

Figure 1-20 Auto mode display

2. Press the AUTO key again to select Cruising or Fishing.
3. Press the MENU ESC key.

1.9 Selecting Picture Advance Speed

The picture advance speed determines how quickly the vertical scan lines run across the screen. When selecting a picture advance speed, keep in mind that a fast advance speed will expand the size of the fish school horizontally on the screen and a slow advance speed will contract it.

1. Press the ADVANC key. The following display appears.

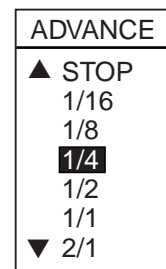

Figure 1-21 Picture advance speed selection display

The fractions in the menu denote number of scan lines produced per transmission. For example, 1/8 means one scan line is produced every 8 transmissions. STOP freezes the display and it is convenient for observing an echo.

2. Press the ADVANC key again to select speed desired.
3. Press the MENU ESC key.

1.10 Erasing Weak Echoes

Dirty water or reflections from plankton may be painted on the display in green or light-blue. These weak echoes may be erased as follows:

1. Press the SIG LEV key. The following display appears.

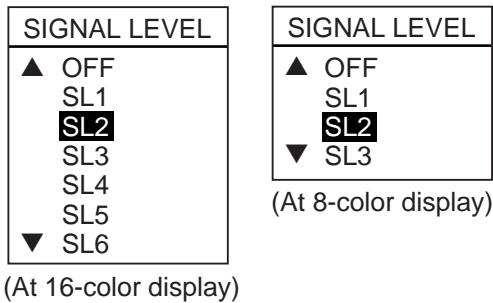

Figure 1-22 Signal level display

2. Press the SIG LEV key again to select signal level (echo color) to erase. The color deleted disappears from the color bar and is replaced with dark-blue color. SL1 erases the weakest echo; SL6 the light-blue echo.
3. Press the MENU ESC key.

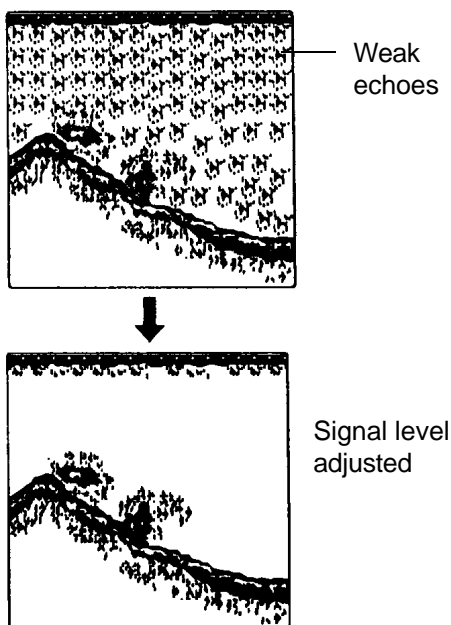

Figure 1-23 How SIG LEV works

1.11 Measuring Depth

The VRM (Variable Range Marker) functions to measure the depth to fish schools, etc.

1. Press ▲ or ▼ to place the VRM on an echo.
2. Read the VRM range just above the VRM.

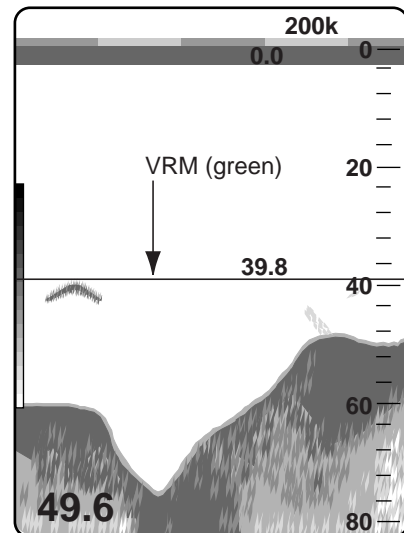

Figure 1-24 How to measure depth with the VRM

1.12 A-scope Display

This display shows echoes at each transmission with amplitudes and tone proportional to their intensities, on the right 1/3 of the screen. It is useful for estimating the kind of fish school and bottom composition.

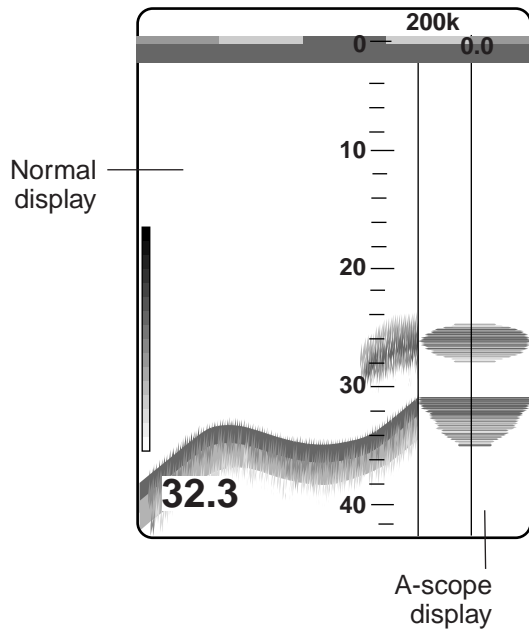

Figure 1-25 A-scope display

1. Press the A-SCOPE key. The A-SCOPE selection display appears.



Figure 1-26 A-scope selection display

2. Press ▲ or ▼ to select OFF or ON.
3. Press the MENU ESC key.

1.13 User Menu

The User menu has several functions which require adjustment according to operating conditions.

1. Press the MENU ESC key to display the User menu.

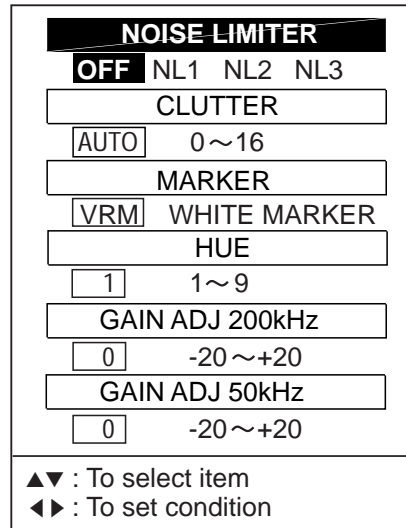

Figure 1-27 User menu

2. Press ▲ or ▼ to select menu item. As you operate ▲ or ▼, the selected item and its current setting are displayed in yellow.
3. Press ◀ or ▶ to set condition.
4. Press the MENU ESC key to close the menu.

1.14 Suppressing Interference

Interference from other acoustic equipment operating nearby or other electronic equipment on your boat may show itself on the display as shown in Figure 1-28.

To suppress interference, do the following:

1. Press the MENU ESC key to display the User menu.
2. Select NOISE LIMITER.
3. Press ◀ or ▶ to select degree of suppression desired; OFF, NL1, NL2 or NL3. The higher the number the greater the degree of suppression.
4. Press the MENU ESC key.

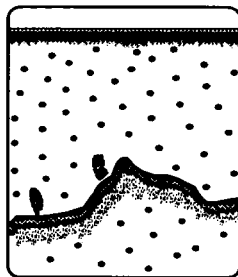

Interference from other sounder

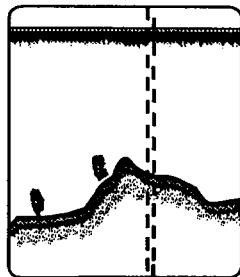

Electrical interference

Figure 1-28 Forms of interference

Turn the noise limiter circuit off when no interference exists, otherwise weak echoes may be missed.

1.15 Suppressing Low Level Noise

Light-blue dots may appear over most of screen. This is mainly due to dirty water or noise. This noise can be suppressed by adjusting CLUTTER on the User menu.

When the automatic mode is on, the clutter suppression setting is fixed at AUTO. To suppress low level noise in manual sounder operation do the following:

1. Press the MENU ESC key.
2. Select CLUTTER.

3. Press ◀ or ▶ to select clutter rejection level desired. The higher the number the higher the degree of suppression. Note that weak echoes may not be displayed when the clutter circuit is on.
4. Press the MENU ESC key.

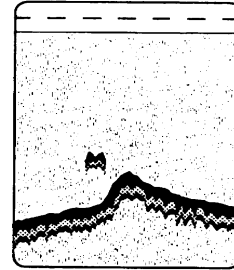

Figure 1-29 Clutter appearance

1.16 Selecting Background and Echo Colors

1. Press the MENU ESC key.
2. Select HUE.
3. Press ◀ or ▶ to select hue arrangement number. (You can see the result of your selection behind the menu.) Table 1-2 shows hue no., echo color and background color.

Table 1-2 Background and echo colors

| Hue No. | Echo Color | Background Color |
|---------|---------------------------|------------------|
| 1 | 16 color | Medium-blue |
| 2 | 8 color | Medium-blue |
| 3 | 16 color | Dark-blue |
| 4 | 8 color | Dark-blue |
| 5 | 16 color | White |
| 6 | 8 color | White |
| 7 | 16 color | Black |
| 8 | 8 color | Black |
| 9 | Monochrome, 8 intensities | |

4. Press the MENU ESC key.

1.17 Alarms

Bottom alarm

The bottom alarm sounds when the bottom is within the alarm range set. To activate the bottom alarm the depth must be displayed.

Fish alarm

There are two types of fish alarms: bottom-lock and normal. The bottom-lock fish alarm sounds when fish are within a certain distance from the bottom. The normal fish alarm sounds when fish are within the preset alarm range.

Water temperature alarm

There are two types of water temperature alarms: IN and OUT. The IN alarm sounds when the water temperature is within the range set; the OUT alarm sounds when the water temperature is higher than the range set. This alarm requires water temperature data.

Activating/deactivating an alarm

1. Press the ALARM key to display the alarm setting display and select alarm desired.

| | | |
|--|-----------------------------------|---|
| BOTTOM ALARM ZONE RANGE | <input type="checkbox"/> OFF | ON |
| | <input type="text" value="0"/> ~ | <input type="text" value="5"/> <input type="text" value="5"/> |
| FISH (NORMAL) ALARM ZONE RANGE | <input type="checkbox"/> OFF | ON |
| | <input type="text" value="0"/> ~ | <input type="text" value="5"/> <input type="text" value="5"/> |
| FISH (B/L) ALARM ZONE RANGE | <input type="checkbox"/> OFF | ON |
| | <input type="text" value="22"/> ~ | <input type="text" value="21"/> <input type="text" value="1"/> |
| TEMP ALARM ZONE RANGE | <input type="checkbox"/> OFF | IN OUT |
| | <input type="text" value="32"/> ~ | <input type="text" value="37"/> <input type="text" value="5"/> |
| ▲▼ : To select item ◀▶ : To set condition | | |

Table 1-3 Alarm width data

| Alarm | Alarm Width (m) | Default Setting (m) |
|-------------|-----------------|---------------------|
| Bottom | 1-99 | 5 |
| Fish-Normal | 1-99 | 5 |
| Fish-B/L | 1-B/L value | 1 |
| Temp IN | 1-99 | 5 |
| Temp OUT | 1-99 | 5 |

Figure 1-30 Alarm mode display

2. Press ▶ to select ON.

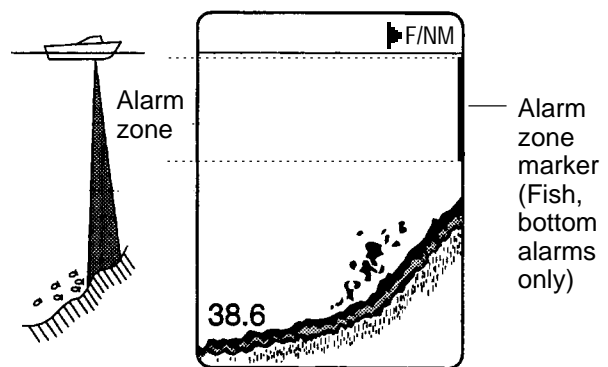

Figure 1-31 Alarm zone

3. Press ▼ to set ALARM RANGE.
4. Press ◀ or ▶ to change alarm zone as desired.
5. Press ▼ to set RANGE.
6. Press ◀ or ▶ to change range as desired.

7. To deactivate an alarm, select OFF.

Note : For fish alarm set "F/A LEVEL". See page15.

Silencing the buzzer

The buzzer sounds whenever an alarm is violated. You can temporarily silence the buzzer by pressing the ALARM key. However, the buzzer will sound whenever the alarm setting is violated.

1.18 White Marker

The white marker functions to display a particular echo color in white. For example, you may want to display the bottom echo (reddish-brown) in white to discriminate fish echoes near the bottom. Note that the bottom must be displayed in reddish-brown for the white marker to function.

1. Press the MENU ESC Key.
2. Press ▲ or ▼ to select MARKER.
3. Press ► to select WHITE MAKER
4. Press the MENU ESC Key.
5. Press ▲ or ▼ to select color to display in white. As you press ▲ or ▼ the arrow next to the color bar shifts and selected echo color is displayed in white.

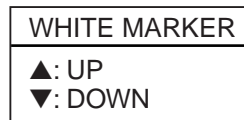

Figure 1-32 White marker display

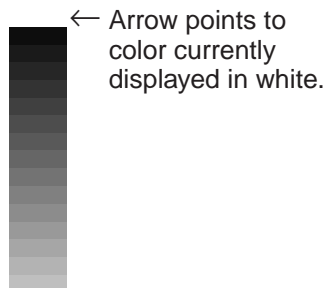

Figure 1-33 Color bar when white marker display is on

To turn the white marker function off, set the arrow below the weakest color in the color bar in step 5 of the above procedure.

1.19 Fine Adjustment of Gain in Dual-Frequency Operation

The gain of both the 50 kHz and 200 kHz transducers can be adjusted individually on the User menu as follows:

1. Press the MENU ESC key.
2. Select GAIN ADJ 200kHz or GAIN ADJ 50kHz.
3. Press ◀ or ▶ to adjust gain.
4. Press the MENU ESC key.

This page is intentionally left blank.

OPTIONAL MODE

2.1 Displaying the Optional Mode Menu

The Optional mode mainly contains less-of-ten used functions which once preset do not require frequent adjustment. You can access the Optional mode menu as follows:

1. Turn off the equipment.
2. Press the POWER key while pressing any key. The following display appears.

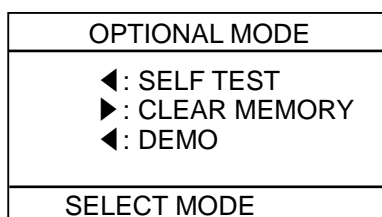

Figure 2-1 Optional mode selection display

3. Operate the Cursor Pad to select mode desired.

Note: SELF TEST and CLEAR MEMORY are explained in the chapter on maintenance.

4. To escape from the Optional mode, turn off the power.

Note: Wait at least five seconds before reapplying the power.

2.2 System Menu

There are three system menus: system menu 1, system menu 2, and system menu 3.

1. Press the MENU ESC key.
2. Press ▼ key to select GO TO SYSTEM MENU.
3. Press ▶ at the GO TO SYSTEM MENU. The System menu 1 appears.
4. With the cursor selecting MENU, operate the Cursor Pad to select system menu desired.

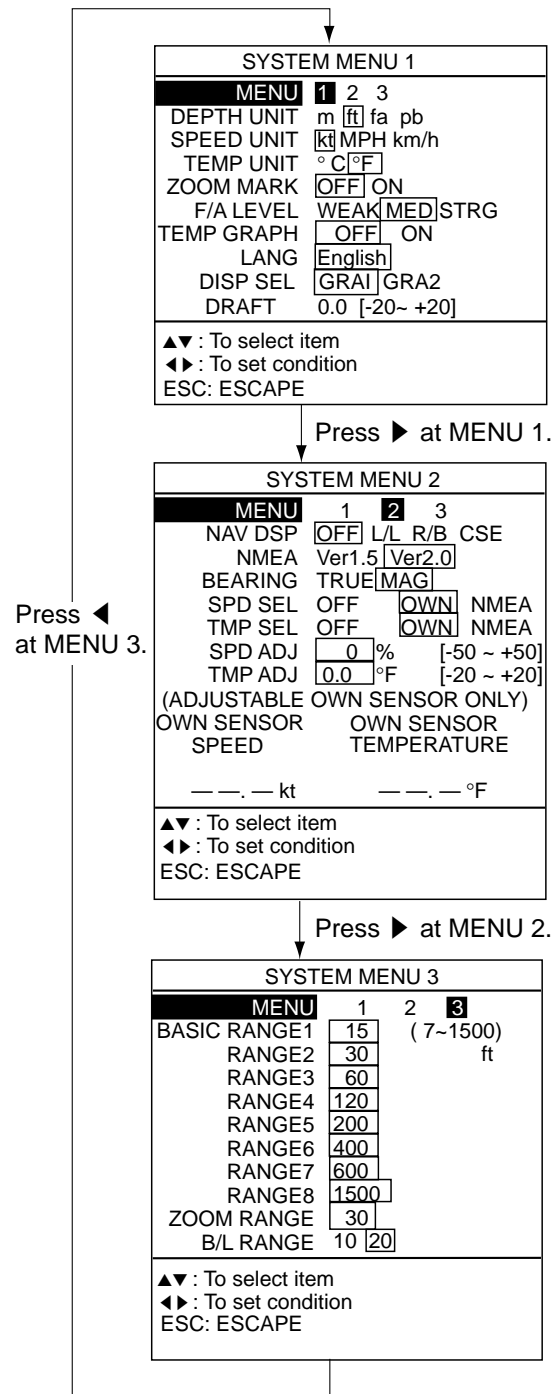

Figure 2-2 System menus

System menu 1 description

MENU: Selects system menu desired.

DEPTH UNIT: Selects unit of depth measurement among meters, feet, fathoms, or passi/braza. Default setting is feet.

SPEED UNIT: Selects unit of speed measurement among knots, miles per hour, or kilometers per hour. Default setting is knots. Requires speed data.

TEMP UNIT: Selects unit of temperature measurement; Celsius or Fahrenheit. Default setting is Fahrenheit. Requires temperature data.

ZOOM MARK: The zoom marker appears in the normal, bottom marker and bottom zoom displays and marks the area which is expanded in the bottom marker and bottom zoom pictures. You can turn on/off the marker as desired. The default setting is off.

F/A (Fish Alarm) LEVEL: Selects minimum echo strength level which triggers fish alarm; weak, medium, or strong. Default setting is medium.

TEMP GRAPH: Displays current water temperature in line graph form. (See illustration on page 2.) Default setting is off. Requires water temperature data.

LANG: Selects menu language; Japanese, English or etc. Default setting is English.

DISP SEL: Select graphic displays: GRA1, steering display; GRA2, speed meter display.

DRAFT: The zero line (sometimes referred to as the transmission line) represents the transducer's position, and moves off the screen when a deep phased range is used.

System menu 2 description

MENU: Selects system menu desired.

NAV DSP: Selects nav data to display on the video sounder displays; position (L/L), range and bearing (R/B), or course (CSE). This data appears in white characters on a blue background at the upper left-hand corner on the video sounder displays. (See illustration on page 2.) Default setting is off. Requires nav data input.

NMEA: Selects NMEA data input format; Ver. 1.5 or Ver. 2.0. Default setting is Ver. 2.0.

BEARING: Ship's course and bearing to a waypoint may be displayed in true or magnetic bearing, on the graphic display. Magnetic bearing is true bearing plus (or minus) earth's magnetic deviation. Default setting is magnetic. Requires bearing data.

SPD SEL: Selects source of speed input; OFF, OWN (speed sensor), or NMEA (external). Default setting is OWN. Requires speed data.

TMP SEL: Selects source of water temperature input; OFF, OWN (water temperature sensor), or NMEA (external). Default setting is OWN. Requires water temperature data.

SPD ADJ: If the speed sensor-generated speed indication is wrong, you can correct it here. (NMEA format speed data cannot be adjusted.) For example, if the speed indication is 10% lower than actual speed, enter +10. Default setting is zero.

TEMP ADJ: If the water temperature sensor-generated water temperature indication is wrong, you can correct it here. (NMEA format water temperature data cannot be adjusted.) For example, if the water temperature indication is 2° higher than actual water temperature, enter -2. Default setting is zero.

System menu 3 description

MENU: Selects system menu desired.

BASIC RANGE 1–BASIC RANGE 8: Set range of each of the eight basic ranges. Default basic ranges are 15, 30, 60, 120, 200, 400, 600, and 1500 (feet).

Note 1: All default basic ranges are restored whenever the depth unit is changed. Therefore, change the depth unit before changing the basic ranges.

Note 2: Ranges must be set in numerical order. For example, if basic range 3 is 60 feet and basic range 5 is 200 feet, the basic range which can be set for basic range 4 is between 60 and 200 feet.

ZOOM RANGE: Select the range to zoom in the marker and bottom zoom modes. You may select a range between 7 and 1500 feet. Default setting is 30 feet.

B/L RANGE: The expansion width for the bottom-lock display can be selected to 10 feet or 20 feet. Default setting is 20 feet.

2.3 Demonstration Display

The demonstration display lets you get acquainted with the features of the FCV-600L without connecting the transducer. You can activate it as follows:

1. Turn on the power while pressing any key.
2. Press ▼. The following display appears:

| |
|---|
| DEMO MODE |
| OFF ON |
| ◀▶ : To set condition ESC: OPTION MODE |

Figure 2-3 Demo mode display

3. Press ▶ to select ON.
4. Reset the power. "DEMO" appears above the depth indication on the video sounder displays and at the top right-hand corner on the data and graphic displays.

To return to normal operation, turn off the demonstration display at step 2 in the above procedure.

2.4 Bottom Level

If the depth indication is unstable in automatic operation or the bottom echo cannot be displayed in reddish-brown by adjusting the gain controls in manual operation, you may adjust the bottom echo level detection circuit, for both 50 kHz and 200 kHz, to stabilize the indication. Note that if the level is set too low weak echoes may be missed and if set too high the depth indication will not be displayed.

1. Turn on the power while pressing any key.
2. Press the ALARM key three times. The start-up screen appears and shortly thereafter the BOTTOM LEVEL display appears.

| |
|---|
| BOTTOM LEVEL |
| 50kHz= 80(20~200) 200kHz= 80(20~200) |
| ▲▼ : 50kHz ◀▶ : 200kHz |

Figure 2-4 Bottom level display

3. Operate the Cursor Pad to set level. The default bottom level for both 50 kHz and 200 kHz is 80.
4. Press the POWER key to escape.

2.5 TVG Level

TVG (Time Varied Gain) compensates for propagation attenuation of the ultrasonic waves. It does this by equalizing echo presentation so that fish schools of the same size appear in the same density in both shallow and deep waters. In addition, it reduces surface noise. Note that if the TVG level is set too high short range echoes may not be displayed.

1. Turn on the power while pressing any key.
2. Press the A-SCOPE key three times. The start-up screen appears and shortly thereafter the TVG SELECT display appears.

| TVG SELECT | |
|------------|--------|
| 50kHz= | 5(0~9) |
| 200kHz= | 5(0~9) |
| ▲▼ : | 50kHz |
| ◀▶ : | 200kHz |

Figure 2-5 TVG select display

3. Operate the Cursor Pad to set level. The default TVG level for both 50 kHz and 200 kHz is 5.
4. Press the POWER key to escape.

2.6 Echo Offset

The echo offset feature functions to compensate for too weak or too strong echo level. If the on-screen echo level appears to be too weak or too strong and the level cannot be adjusted satisfactorily with the gain controls, do the following to adjust echo level:

1. Turn on the power while pressing any key.
2. Press the SIG LEV key three times. The start-up screen appears and shortly thereafter the ECHO OFFSET display appears.

| ECHO OFFSET | |
|-------------|-------------|
| 50kHz= | 0(-99~ +99) |
| 200kHz= | 0(-99~ +99) |
| ▲▼ : | 50kHz |
| ◀▶ : | 200kHz |

Figure 2-6 Echo offset display

3. Operate the Cursor Pad to adjust level. The default echo offset is 40 for 50 kHz; 0 for 200 kHz.
4. Press the POWER key to escape.

INTERPRETING THE DISPLAY

3.1 Zero Line

The zero line (sometimes referred to as the transmission line) represents the transducer's position, and moves off the screen when a deep phased range is used.

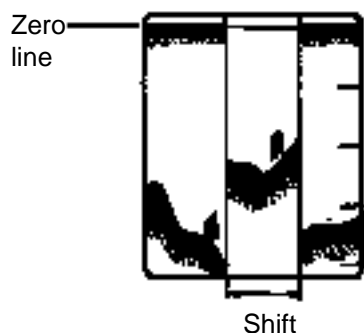

Figure 3-1 Zero line

3.2 Fish School Echoes

Fish school echoes will generally be plotted between the zero line and the bottom. Usually the fish school/fish echo is weaker than the bottom echo because its reflection property is much smaller compared to the bottom. The size of the fish school can be ascertained from the density of the display.

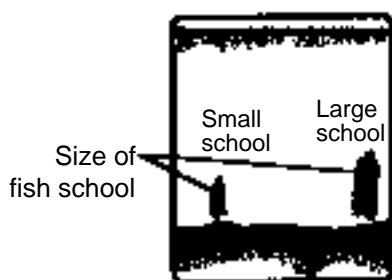

Figure 3-2 Fish school echoes

3.3 Bottom Echo

Echoes from the bottom are normally the strongest and are displayed in reddish-brown color (in default color arrangement) but the color and width will vary with bottom composition, water depth, frequency, sensitivity, etc.

In a comparatively shallow depth, a high gain setting will cause a second or sometimes a third or a fourth echo to be displayed at the same interval between them below the first echo trace. This is because the echo travels between the bottom and the surface twice or more in shallow depths.

The color of the bottom echo can be used to help determine the density of the bottom materials (soft or hard). The harder the bottom, the wider the trace. If the gain is set to show only a single bottom echo on mud, a rocky bottom will show a second or third bottom return. The range should be chosen so the first and second bottom echoes are displayed when bottom hardness is being determined.

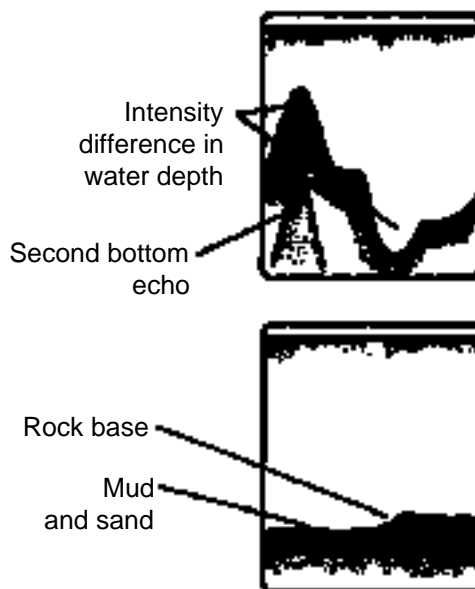

Figure 3-3 Bottom echoes

3.4 Surface Noise/Aeration

When the waters are rough or the boat passes over a wake, surface noise may appear near the zero line. As surface turbulence is acoustically equivalent to running into a brick wall, the bottom echo will be displayed intermittently. Similar noise sometimes appears when a water temperature difference (thermocline) exists. Different species of fish tend to prefer different temperature zones, so the thermocline may be useful to help identify target fish. 200 kHz tends to show shallow thermoclines better than 50 kHz.

In rough waters the display is occasionally interrupted due to below-the-ship air bubbles obstructing the sound path. This also occurs when the boat makes a quick turn or reverses movement. Lowering the picture advance speed may reduce the interruption. However, reconsideration of the transducer installation may be necessary if the interruption occurs frequently.

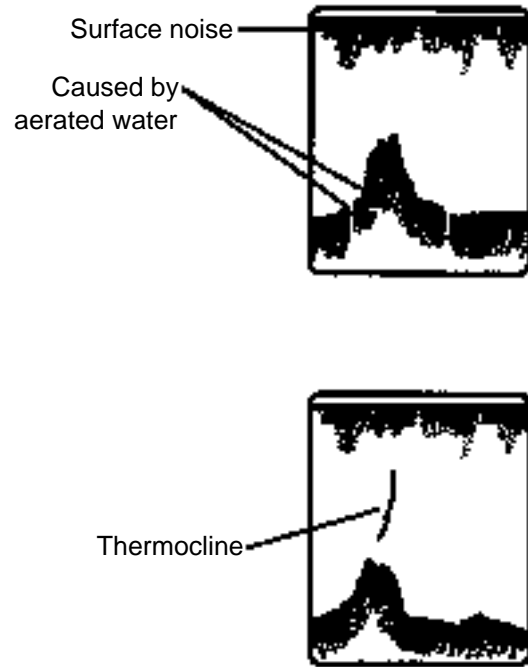

Figure 3-4 Surface noise/aeration

MAINTENANCE & TROUBLESHOOTING

WARNING

Do not open the cover.

There are no user-serviceable parts inside. Refer any repair work to a qualified technician.

4.1 Checking

Regular maintenance is essential for good performance. Checking the items listed in the table below on a regular basis will keep the equipment in good shape for years to come.

Table 4-1 Checking

| Item | Action |
|------------------------------------|---|
| Cable run | If conductors are exposed, replace cable. |
| Power cable, transducer cable plug | If loosened, tighten. |
| Display unit ground | If corroded, clean. |
| Ship's mains voltage | If out of rating, correct problem. |

4.2 Cleaning the Display Unit

Dust or dirt on the display unit can be removed with a soft cloth. If desired a water-moistened cloth may be used. Do not use chemical cleaners to clean the display unit; they can remove paint and markings.

For screen, wipe the LCD carefully to prevent scratching, using tissue paper and an LCD cleaner. To remove dirt or salt deposits, use an LCD cleaner, wiping slowly with tissue paper so as to dissolve the dirt or salt. Change paper frequently so the salt or dirt will not scratch the LCD. Do not use solvents such as thinner, acetone or benzene for cleaning.

4.3 Transducer Maintenance

Marine life on the transducer face will result in a gradual decrease in sensitivity. Check the transducer face for cleanliness each time the boat is dry-docked. Carefully remove any marine life with a piece of wood or fine-grade sandpaper.

4.4 Replacing the Fuse

The fuse on the power cable protects the system from reverse polarity of the ship's mains and equipment fault. If the fuse blows, find the cause before replacing it. Use only a 3A fuse. Using the wrong fuse will damage the unit and void the warranty.

WARNING

Use only a 3A fuse.

Use of a wrong fuse can result in equipment damage and void the warranty.

4.5 Troubleshooting

The table below provides simple troubleshooting procedures which you may follow to restore normal operation. If you cannot restore normal operation, contact your dealer.

Table 4-2 Troubleshooting

| If... | Then check... |
|--|--|
| neither echo nor fixed range scale appears | <ul style="list-style-type: none"> • battery voltage. • fuse. • power supply. • power cable. |
| no echo appears but fixed range scale appears | <ul style="list-style-type: none"> • if display advance speed is set to STOP. • transducer plug. |
| echo appears but no zero line | <ul style="list-style-type: none"> • if range shifting is set to 0. |
| sensitivity is low | <ul style="list-style-type: none"> • gain setting. • if air bubbles are present or marine life is stuck to the transducer. • if water is dirty. • if bottom is too soft to return an echo. |
| there is extreme interference or noise | <ul style="list-style-type: none"> • if transducer or cable is close to engine. • if unit is properly grounded. • if other echo sounders of the same frequency as own are being operated nearby. |
| there is no or unrealistic speed/temperature readout | <ul style="list-style-type: none"> • sensor plug. |
| there is no or unrealistic ship's position readout | <ul style="list-style-type: none"> • connection between sounder and navigator. • navigator itself. |

4.6 Test

The test checks the ROM, RAM, color bar and keyboard for proper operation. You may start the test as follows:

1. Turn on the power while pressing any key.
2. Press ◀. The following display appears:

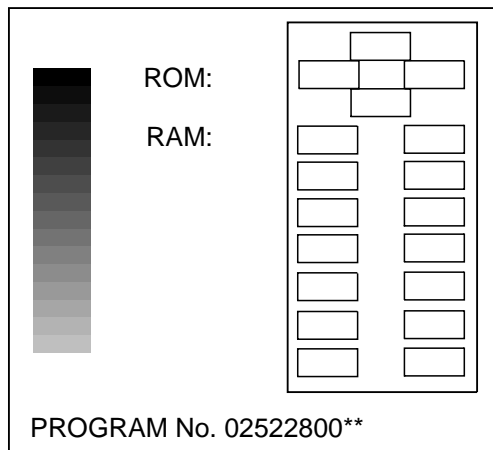

** = Version no.

Figure 4-1 Test display

3. The ROM and RAM are checked and the results are displayed as OK or NG (No Good).
4. Press and release each key (except the POWER key) one by one. If the key is normal, its on-screen location lights in black and the buzzer sounds while the key is pressed.

4.7 Test Pattern

This feature tests for proper display of colors.

1. Turn on the power while pressing any key.
2. Press the BRILL key three times. Press the BRILL key again to change the test pattern as below.

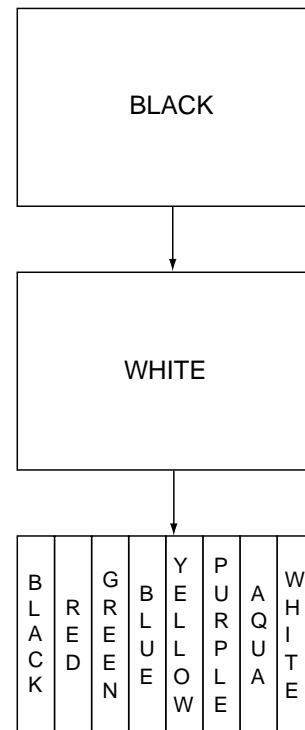

Figure 4-2 Test patterns

3. Press the POWER key to escape.

4.8 Clearing the Memory

The memory (all menu settings) can be cleared to start afresh. All default menu settings are restored when the memory is cleared. For your reference all default settings are shown in the menu tree at the beginning of this manual.

1. Turn on the power while pressing any key.
2. Press ▲. The following display appears:

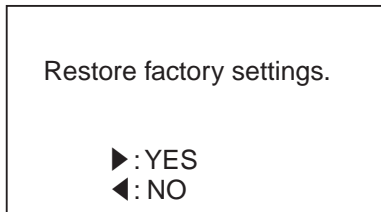

Figure 4-3 Clear memory display

3. Press ▶ to clear the memory. The following display appears while data is being cleared.

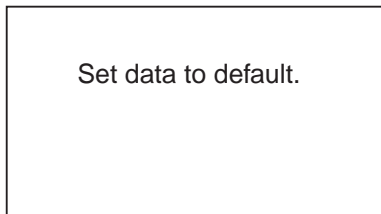

Figure 4-4 Display while memory is being cleared

4. The Optional mode menu appears.

SPECIFICATIONS OF COLOR LCD SOUNDER FCV-600L

This equipment is a dual-frequency (50/200 kHz) color LCD video sounder which has a large variety of functions, all contained in a splash-proof rugged plastic case that is compact to fit small boats.

1. GENERAL

- (1) TX Frequency 50 kHz/200 kHz
- (2) Output Power 350 Wrms
- (3) TX Rate 1500 pulse/min max.
- (4) Pulselength 0.125 to 3.0 ms
- (5) Sensitivity 15 dB μ V
- (6) Transducer Dual-frequency one-mold type

2. DISPLAY UNIT

- (1) Display Mode 5.6 inch color TFT LCD
- (2) Echo Color 16 colors (including background color) according to echo intensity.
Marks are indicated in 8 colors. Monochrome display is also available.
- (3) Display Mode Normal mode (high frequency / low frequency), Dual-frequency,
Zoom, Data, Graphic
- (4) Zoom Display Marker zoom, Bottom zoom, Bottom-lock expansion
- (5) Basic Range

| Indication Unit | Range No. | | | | | | | | Setting Range |
|--------------------|-----------|----|----|-----|-----|-----|-----|------|---------------|
| | 1 | 2 | 3 | 4 | 5 | 6 | 7 | 8 | |
| Meters | 5 | 10 | 20 | 40 | 80 | 150 | 200 | 500 | 2~500 |
| Feet | 15 | 30 | 60 | 120 | 200 | 400 | 600 | 1500 | 7~1500 |
| Fathom | 3 | 5 | 10 | 20 | 40 | 80 | 100 | 250 | 1~250 |
| Passi/Braza | 3 | 5 | 10 | 30 | 50 | 100 | 150 | 400 | 1~400 |

- (6) Range Shift 0~300 m, 0~1000 ft, 0~150 fa or 0~200 p/b
- (7) Zoom Range Bottom-lock expansion: 5 m or 10 m
Marker/Bottom zoom: from 2 m to 300 m
- (8) Display Advance Speed 7 steps (Lines/TX: Freeze, 1/16, 1/8, 1/4, 1/2, 1/1, 2/1)
- (9) User Setting Interference reduction, Clutter level, Alarm zone, Hue Setting,
Sensitivity adjustment

3. I/O DATA

- (1) Data Format NMEA0183(Ver.1.5/2.0)
- (2) Input Data RMA,RMB,BWC,GLL,VTG,VHW,MTW
- (3) Output Data SDDBT,YCMTW,VWVHW

4. POWER SUPPLY AND POWER CONSUMPTION

- (1) Voltage and Current 12-24 VDC: 1-0.5 A
- (2) Power Consumption 15 W or less

5. ENVIRONMENTAL CONDITION

- (1) Temperature -15 °C to +55 °C
- (2) Relative Humidity Less than 95% (at 40°C)
- (3) Water Resistance IEC IPX5
- (4) Category of Equipment Display Unit: For protected area
Transducer: For Submerged area

6. COATING COLOR

- (1) Display Unit Panel: N3.0 Newton No.5
Chassis: 2.5GY5/1.5

Free Manuals Download Website

<http://myh66.com>

<http://usermanuals.us>

<http://www.somanuals.com>

<http://www.4manuals.cc>

<http://www.manual-lib.com>

<http://www.404manual.com>

<http://www.luxmanual.com>

<http://aubethermostatmanual.com>

Golf course search by state

<http://golfingnear.com>

Email search by domain

<http://emailbydomain.com>

Auto manuals search

<http://auto.somanuals.com>

TV manuals search

<http://tv.somanuals.com>