

# FURUNO

## OPERATOR'S MANUAL

DUAL-FREQUENCY SEARCHLIGHT SONAR

MODEL CH-300

---



**FURUNO ELECTRIC CO., LTD.**  
NISHINOMIYA, JAPAN



(Elemental Chlorine Free)

The paper used in this manual  
is elemental chlorine free.

© **FURUNO ELECTRIC CO., LTD.**

9-52 Ashihara-cho,  
Nishinomiya 662-8580, JAPAN

Telephone : 0798-65-2111

Fax : 0798-65-4200

Your Local Agent/Dealer

All rights reserved.

Printed in Japan

Pub. No. OME-13250

( DAMI ) CH-300

FIRST EDITION : APR. 2005

A1 : APR. 19, 2005



\* 0 0 0 1 5 1 9 0 0 0 \*



\* O M E 1 3 2 5 0 A 1 0 \*



# SAFETY INSTRUCTIONS

## WARNING



### **ELECTRICAL SHOCK HAZARD Do not open the equipment.**

Only qualified personnel should work inside the equipment.

**Immediately turn off the power at the switchboard if water leaks into the equipment or something is dropped in the equipment.**

Continued use of the equipment can cause fire or electrical shock. Contact a FURUNO agent for service.

**Do not disassemble or modify the equipment.**

Fire, electrical shock or serious injury can result.

**Immediately turn off the power at the switchboard if the equipment is emitting smoke or fire.**

Continued use of the equipment can cause fire or electrical shock. Contact a FURUNO agent for service.

**Make sure no rain or water splash leaks into the equipment.**

Fire or electrical shock can result if water leaks in the equipment.

## WARNING

**Keep heater away from equipment.**

A heater can melt the equipment's power cord, which can cause fire or electrical shock.

**Use the proper fuse.**

The fuse in the hull and transceiver units protects them from overvoltage, equipment fault and reverse polarity of the ship's mains. If a fuse blows replace it with fuse of the same amperage. Use of a wrong fuse can result in damage to the equipment.

**Retract the transducer before turning off the power.**

Damage to the equipment may result. Wait until the transducer retraction switch [↑] lights steadily and then turn off the power.

## CAUTION

**Do not exceed 20 knots when operating the equipment and do not exceed 15 knots when lowering or raising the transducer.**

The transducer may become damaged.

**Do not use the equipment for other than its intended purpose.**

Use of the equipment as a stepping stool, for example, may result in personal injury or damage to the equipment.

### WORKING WITH THE SONAR OIL

#### Precautions

- Keep oil away from eyes. Wear protective gloves when working with the oil. The oil can cause inflammation of the eyes.
- Do not touch the oil. Wear protective gloves when working with the oil. The oil can cause inflammation of the skin.
- Do not ingest the oil. Diarrhea and vomiting may result.
- Keep the oil out of reach of children.

#### Emergency procedures

- If the oil enters eyes, flush with clean water about 15 minutes. Consult a physician.
- If the oil is ingested, see a physician immediately.

#### Disposal of oil and its container

Dispose of oil and its container in accordance with local regulations. For further details, contact place of purchase.

#### Storage

Seal container to keep out foreign material. Store in dark, cool place.

## CAUTION

**Set the gain properly.**

No picture appears if the gain setting is too low, and noise appears when the gain is too high. If the gain is set improperly, the depth indication may be wrong, resulting in a potentially dangerous situation if the vessel is navigated by monitoring the depth indication.



Gain too high



Proper gain



Gain too low

### Warning labels

**Warning labels are attached to the display, transceiver and hull units. Do not remove the labels. If a label is missing or illegible, contact a FURUNO agent or dealer.**

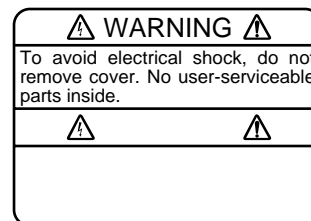

TRANSCIVER UNIT  
Name: Warning Label (1)  
Type: 86-003-1011-1  
Code No.: 100-236-231

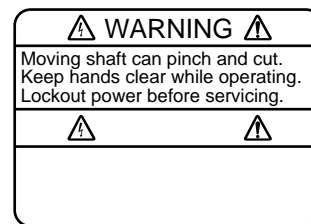

HULL UNIT  
Name: Injury  
Warning Label  
Type: 06-021-4015-0  
Code No.: 100-281-590

### TFT LCD

The high quality TFT (Thin Film Transistor) LCD displays 99.999% of its picture elements. The remaining 0.01% may drop out or light, however this is an inherent property of the LCD; it is not a sign of malfunction.

# TABLE OF CONTENTS

---

<b>FOREWORD .....</b>	<b>vi</b>
<b>SYSTEM CONFIGURATION.....</b>	<b>viii</b>
<b>1. OPERATIONAL OVERVIEW.....</b>	<b>1-1</b>
1.1 Control Description .....	1-1
1.2 Remote Controller.....	1-2
1.3 Turning the Power On/Off .....	1-3
1.3.1 Power on.....	1-3
1.3.2 Power off.....	1-3
1.4 Raising, Lowering the Transducer.....	1-4
1.4.1 Lowering the transducer .....	1-4
1.4.2 Raising the transducer .....	1-4
1.5 Adjusting Screen Brilliance, Panel Dimmer .....	1-5
1.6 Choosing a Display.....	1-6
1.7 Choosing a Frequency.....	1-9
1.8 Mix Display .....	1-11
1.9 Adjusting the Gain .....	1-13
1.10 Menu Overview.....	1-15
<b>2. HORIZONTAL MODE.....</b>	<b>2-1</b>
2.1 Operational Overview .....	2-1
2.2 Typical Horizontal Mode Display .....	2-2
2.3 Choosing a Range.....	2-3
2.4 Choosing Sector Width .....	2-4
2.5 Choosing Train Center.....	2-5
2.6 Choosing a Tilt Angle .....	2-5
2.6.1 Tilt angle for surface fish .....	2-6
2.6.2 Distinguishing fish echo from bottom echo in coastal waters .....	2-6
2.6.3 Suitable tilt angle .....	2-8
2.7 Choosing Training Speed.....	2-9
2.8 Changing Training Direction.....	2-9
2.9 Finding Echo Position with the Cursor .....	2-10
2.10 Event Marker .....	2-11
2.11 Depth and Horizontal Range Markers .....	2-12
2.12 Adjusting the Picture.....	2-13
2.12.1 Suppressing bottom and surface reflections .....	2-13
2.12.2 Suppressing bottom tail.....	2-14
2.12.3 Displaying weak echoes clearly.....	2-14
2.12.4 Erasing weak echoes .....	2-16
2.12.5 Suppressing interference from marine life .....	2-17
2.12.6 Enlarging fish echoes (horizontal expansion display).....	2-18
2.13 Target Lock.....	2-19
2.13.1 Choosing a target lock mode.....	2-19
2.13.2 Position mode .....	2-19
2.13.3 Echo mode.....	2-20

2.14	Horizontal Menu Overview .....	2-22
2.14.1	Horizontal menu description .....	2-22
2.15	Interpreting the Horizontal Display .....	2-24
2.15.1	How the horizontal mode picture is painted.....	2-24
2.15.2	Sample displays .....	2-25
2.15.3	Combination display examples.....	2-29
<b>3.</b>	<b>VERTICAL SCAN MODE .....</b>	<b>3-1</b>
3.1	Operational Overview.....	3-1
3.2	Typical Vertical Scan Mode Display .....	3-2
3.3	Choosing a Range .....	3-3
3.4	Choosing Train Center .....	3-4
3.5	Choosing Display Sector.....	3-5
3.6	Choosing Sector Center.....	3-6
3.7	Choosing Training Speed.....	3-7
3.8	Finding Echo Position with the Cursor .....	3-7
3.9	Changing Training Direction.....	3-7
3.10	Event Marker.....	3-8
3.10.1	Deleting all event markers from the vertical scan display.....	3-9
3.11	Depth and Horizontal Range Markers.....	3-9
3.12	Adjusting the Picture .....	3-10
3.12.1	Displaying weak echoes clearly.....	3-10
3.12.2	Suppressing noise and interference.....	3-11
3.13	Vertical Menu Overview .....	3-12
3.13.1	Vertical menu description .....	3-12
3.14	Interpreting the Vertical Scan Display .....	3-13
3.14.1	How the vertical scan mode picture is painted .....	3-13
3.14.2	Sample displays .....	3-14
3.14.3	Horizontal/vertical scan port-starboard, Horizontal/vertical scan upward-downward display.....	3-16
<b>4.</b>	<b>ECHO SOUNDER MODE.....</b>	<b>4-1</b>
4.1	Operational Overview.....	4-1
4.2	Typical Echo Sounder Display .....	4-2
4.3	Choosing a Range .....	4-3
4.4	Train Direction.....	4-4
4.5	Choosing a Tilt Angle .....	4-4
4.6	Choosing a Picture Advance Speed.....	4-4
4.7	Measuring Range by Cursor .....	4-5
4.8	Event Marker.....	4-5
4.8.1	Inscribing the event marker .....	4-6
4.8.2	Deleting all event markers from echo sounder display.....	4-6
4.9	Range Marker .....	4-7
4.10	Adjusting the Picture .....	4-7
4.10.1	Displaying weak echoes clearly.....	4-7
4.10.2	Finding echo strength (A-scope display) .....	4-9
4.10.3	Suppressing interference and noise.....	4-9
4.11	Echo Sounder Menu Overview .....	4-10
4.11.1	Echo sounder menu description .....	4-10

<b>5. MENU OPERATION .....</b>	<b>5-1</b>
5.1 COM1 Menu .....	5-1
5.1.1 COM1 menu description.....	5-2
5.2 COM2 Menu .....	5-3
5.2.1 Displaying the COM2 menu.....	5-3
5.2.2 COM2 menu description.....	5-3
5.3 Short-cut Menu, Preset Menu .....	5-4
5.3.1 Choosing short-cut or preset .....	5-4
5.3.2 Preset key .....	5-5
5.3.3 Short-cut key .....	5-7
5.4 SYSTEM Menu.....	5-9
5.4.1 How to open the SYSTEM menu.....	5-9
5.4.2 System setting menus .....	5-10
5.4.3 Sonar (horizontal) mode range settings.....	5-14
5.4.4 Vertical scan mode range settings.....	5-15
5.4.5 Echo sounder mode range settings .....	5-16
5.4.6 Track range settings .....	5-17
5.4.7 Color palette.....	5-18
5.4.8 Language .....	5-19
5.4.9 System backup.....	5-19
5.4.10 Loading backup data .....	5-19
5.4.11 Transducer frequency adjustment .....	5-20
5.4.12 Demonstration mode .....	5-20
5.4.13 Restoring all default settings .....	5-21
<b>6. MAINTENANCE, TROUBLESHOOTING.....</b>	<b>6-1</b>
6.1 Preventive Maintenance .....	6-1
6.2 Cleaning the Equipment.....	6-1
6.3 Hull Unit Maintenance.....	6-2
6.3.1 Lubrication .....	6-2
6.3.2 Manually raising, lowering transducer .....	6-2
6.4 Transducer Maintenance .....	6-3
6.5 Fuse Replacement.....	6-3
6.6 Troubleshooting .....	6-4
6.7 Error Messages .....	6-5
6.8 Diagnostics .....	6-6
6.9 Test Pattern .....	6-8
<b>MENU TREE.....</b>	<b>AP-1</b>
<b>SPECIFICATIONS.....</b>	<b>SP-1</b>
<b>INDEX.....</b>	<b>IN-1</b>

# FOREWORD

---

Thank you for purchasing the CH-300 Dual-Frequency Searchlight Sonar. We are confident you will discover why FURUNO has become synonymous with quality and reliability.

Dedicated in the design and manufacture of marine electronics equipment for half a century, FURUNO Electric Company has gained an unrivaled reputation as a world leader in the industry. This is the result of our technical excellence as well as our worldwide distribution and service network.

Please carefully read and follow the safety information and operating and maintenance instructions set forth in this manual before attempting to operate the equipment and conduct any maintenance. Your sonar will perform to the utmost of its ability only if it is operated and maintained in accordance with the correct procedures.

## Features

The CH-300 is a dual-frequency searchlight sonar. Consisting of a monitor unit, control unit, transceiver unit and hull unit, it displays underwater objects on the monitor of choice, in 8 or 16 colors according to received echo strengths.

The main features are

- Horizontal and vertical section modes for detecting, searching, tracking and monitoring fish school.
- 12 display modes for virtually any fishing application.
- Mix mode discriminates small fish.
- Fish or bottom echo can be displayed in white to distinguish bottom fish.
- Hull unit automatically raises the transducer when ship's speed exceeds prescribed speed.
- User-programmed function keys provide one-touch access to desired function.
- Two types of target lock for effective tracking of fish school.
- Digital display of position, speed, course, water temperature, depth, tide speed and direction. (Requires appropriate sensors.)



## Usage Precautions

- The Motion Sensor MS-100 compensates for ship's pitching and rolling. However, it does not compensate for load unbalance.
- If the equipment will not be used for a long time, shut off the power to it at the mains switchboard, to prevent battery discharge.
- If the soundome is to be operated while the ship is dry-docked, set the transmitter output power to "minimum" (on the COM1 menu). Damage to the train-tilt section may result if it is operated with maximum transmitter power while the ship is dry-docked.
- When the ship is dry-docked check for signs of corrosion on the soundome. Find the reason for the corrosion and attach a zinc plate to the hull unit as an anticorrosion measure if necessary.

## Notice

- No part of this manual may be copied or reproduced without written permission.
- If this manual is lost or worn, contact your dealer about replacement.
- The contents of this manual and equipment specifications are subject to change without notice.
- The example screens (or illustrations) shown in this manual may not match the screens you see on your display. The screen you see depends on your system configuration and equipment settings.
- This manual is intended for use by native speakers of English.
- FURUNO will assume no responsibility for the damage caused by improper use or modification of the equipment or claims of loss of profit by a third party.

# SYSTEM CONFIGURATION

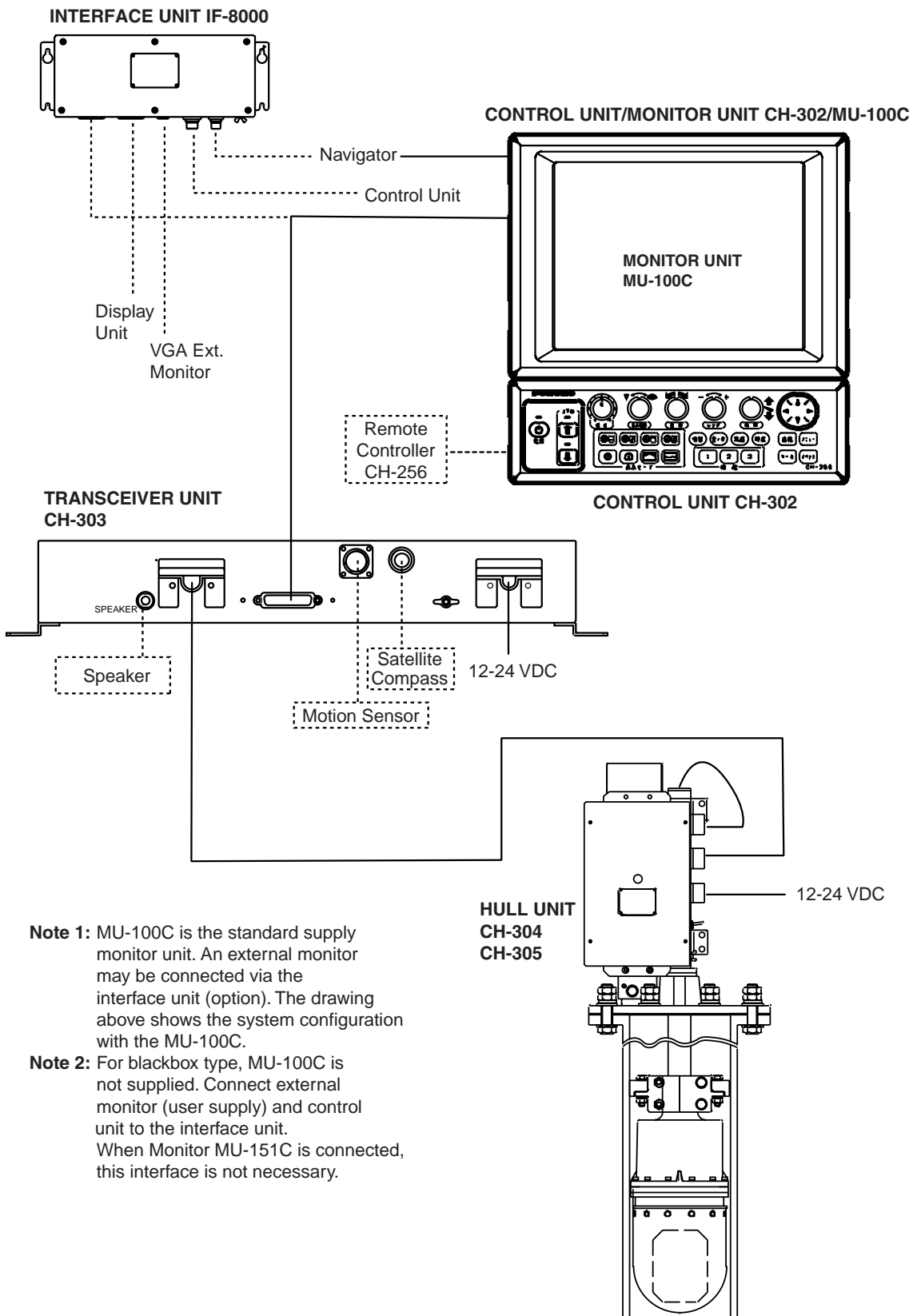

System configuration

# 1. OPERATIONAL OVERVIEW

## 1.1 Control Description

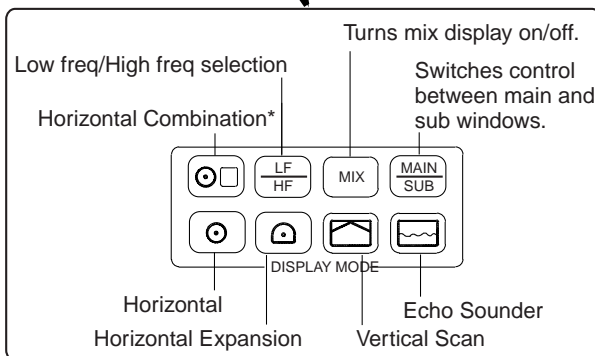
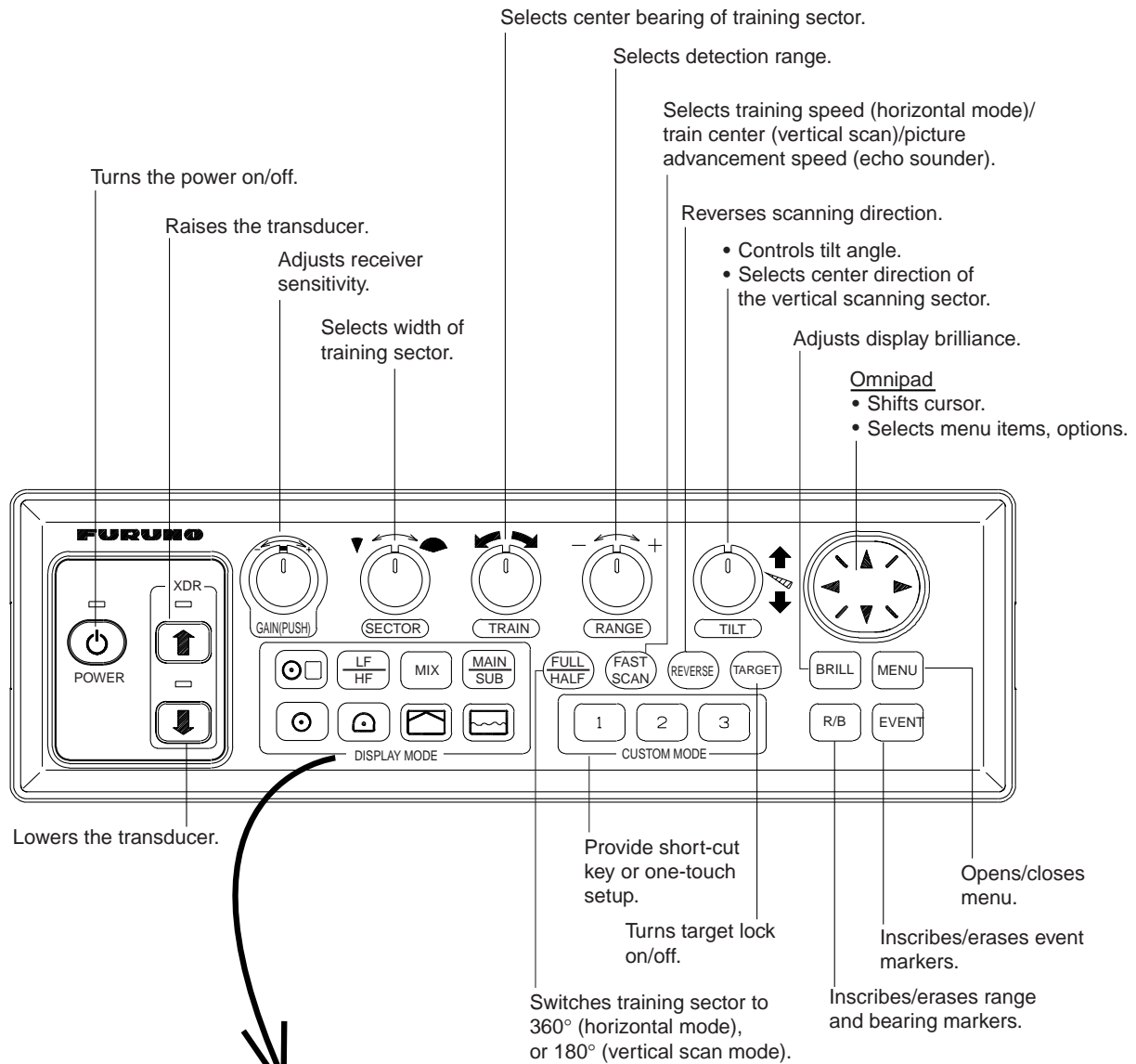

\* Horizontal/History, Horizontal/Vertical scan, Horizontal/Vertical zoom, Horizontal/Video plotter

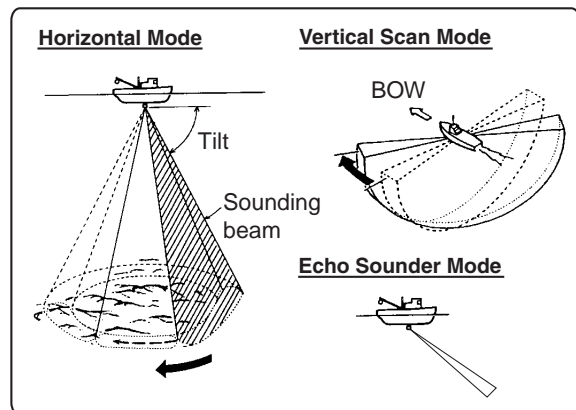

Control unit

## 1.2 Remote Controller

The Remote Controller CH-256 (option) provides armchair control over range, tilt, target lock and sounding range.

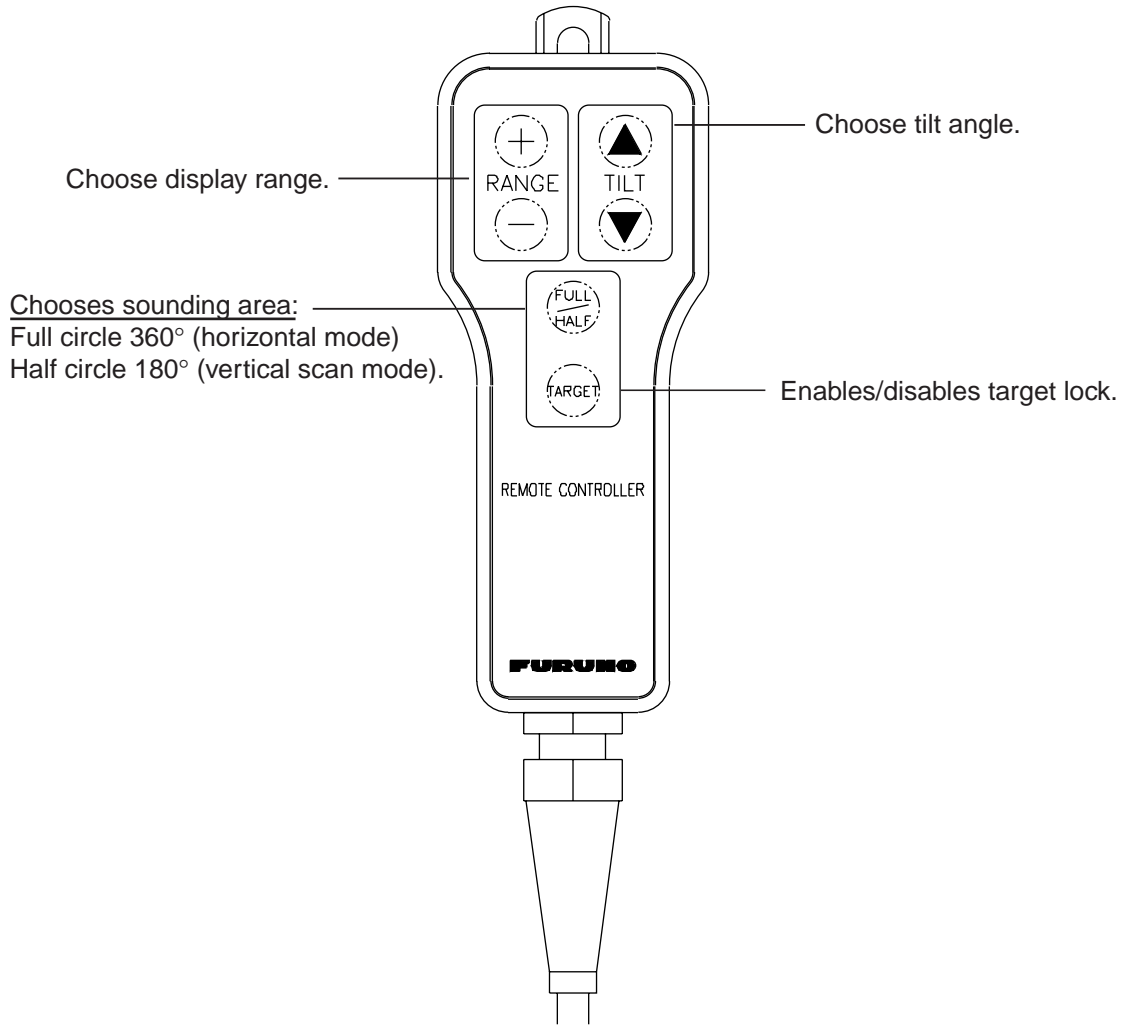

*Remote controller*

## 1.3 Turning the Power On/Off

### 1.3.1 Power on

This sonar has a demonstration mode which provides simulated operation without the transducer. For further details see page 5-20.

Press the **POWER** switch on the control unit till you hear a “click.” A beep sounds, the lamp above the switch lights and the startup display appears. Four seconds later the last-used display appears.



\*\* : Frequency

#### Startup display

**Note 1:** Wait at least five seconds before reapplying the power.

**Note 2:** If the language selection window appears, see paragraph 5.4.8.

### 1.3.2 Power off

1. Check that the speed is under 15 knots\*, and then press the [↑] switch on the control panel to retract the transducer. The lamp above the switch blinks while the transducer is being raised and lights steadily when it is fully raised. \*The transducer may be damaged if it is raised when the speed is more than 15 kts.

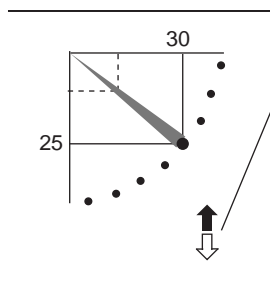

#### Transducer status indicator

- Up arrow: Filled when transducer is fully retracted into the tank.
- Down arrow: Filled when transducer is fully lowered.
- Appropriate arrow flashes during raising/lowering of transducer.

**Note:** When the transducer is being raised automatically (auto raise feature), the arrows are filled and the up arrow flashes. When the transducer is fully retracted, the up arrow lights and the down arrow becomes hollow.

#### Transducer status indicator

2. Confirm that the lamp above the [↑] switch lights steadily (meaning the transducer is fully retracted) and then press the **POWER** switch.

**Note 1:** The transducer is automatically retracted into the tank even if the equipment is turned off before retracting the transducer. However, for safety purposes, make it a habit to retract the transducer before turning off the power.

**Note 2:** After changing settings, wait at least one minute before turning off the power to allow the equipment to memorize settings (and start up with them at the next power up). No harm will result to the equipment if this is not done.

## 1.4 Raising, Lowering the Transducer

### 1.4.1 Lowering the transducer

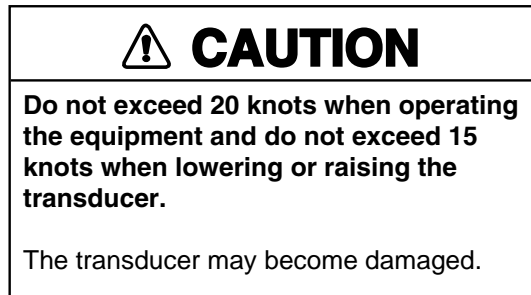

With the boat at the fishing ground, press the [↓] switch to lower the transducer. The lamp above the switch blinks while the transducer is being lowered and lights when it is completely lowered. The down arrow of the transducer status indicator is filled when the transducer is completely lowered.

### 1.4.2 Raising the transducer

Press the [↑] switch to raise the transducer. The lamp above the switch blinks while the transducer is being raised and lights steadily when it is fully raised. The up arrow of the transducer status indicator is filled when the transducer is fully retracted.

**Note 1:** The automatic transducer retraction feature, which requires speed input, raises the transducer when the ship's speed exceeds the operator-set speed (between 5 and 15 knots). If speed data is erroneous the transducer may be raised at a speed different from the speed specified. For further details about the automatic transducer retraction, see AUTO RETRACTION on page 5-13.

**Note 2:** An audio alarm may sound when the ship's speed exceeds the speed specified. For further details, see SPEED ALARM/MESSAGE on page 5-13.

## 1.5 Adjusting Screen Brilliance, Panel Dimmer

Screen brilliance can be adjusted in 10 steps and panel dimmer (backlighting) in five.

1. Press the **BRILL** key to open the dialog box for screen brilliance and panel dimmer adjustment. Do the next step within four seconds, otherwise the dialog box will be erased.

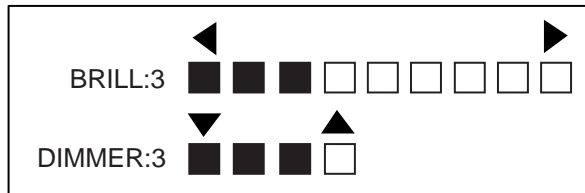

*Brilliance, panel dimmer dialog box*

2. Press ◀ or ▶ as appropriate to adjust screen brilliance (0 is the lowest brilliance; 9 the highest). Note that continuous pressing of the **BRILL** key also changes the brilliance level.
3. Press ◀ or ▶ as appropriate to adjust the panel dimmer (0 is the lowest level; 4 is the highest).
4. Press the **MENU** key to register settings and close the dialog box. Note that the dialog box is automatically erased if there is no control operation within about four seconds.







**Note 1:** The brilliance of a commercial monitor cannot be adjusted with the **BRILL** key. Use the associated control on the monitor.

**Note 2:** For the supplied monitor unit, if you turn off the power with the brilliance set at minimum the screen will show nothing at next power-up. In this case press the **BRILL** key several times to raise the brilliance.

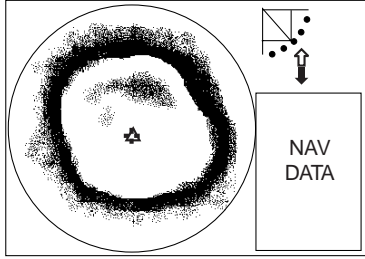
## 1.6 Choosing a Display

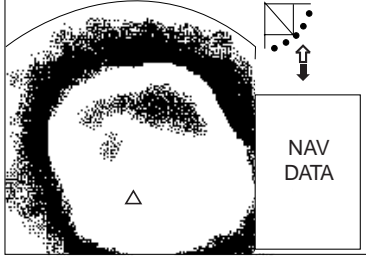
12 displays are provided; choose the one which best suits your current needs. For a description of each display, see Chapter 2.

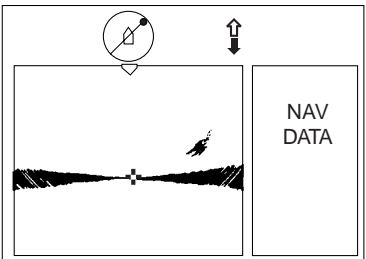

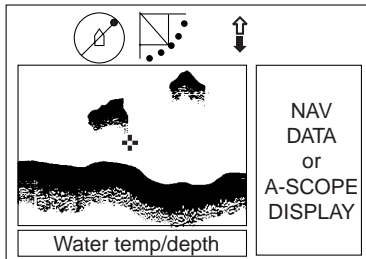



### Single-frequency displays

Key	Display	Key	Display
	 <p><u>HORIZONTAL</u></p> <p>This mode provides 360 degree coverage. Useful for general search. (Chapter 2)</p>		 <p><u>EXPANDED HORIZONTAL</u></p> <p>Expanded horizontal picture appears over the entire screen. (Chapter 2)</p>
	 <p><u>VERTICAL SCAN</u></p> <p>Vertical section of underwater conditions appears on the entire screen. (Chapter 3)</p>		 <p><u>ECHO SOUNDER</u></p> <p>Using a fixed spot beam this display shows fish echoes below or around the vessel. (Chapter 4)</p>

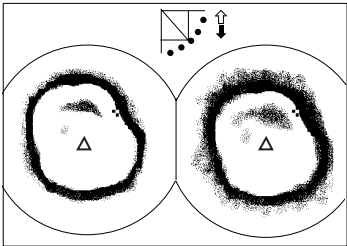
*Single-frequency displays*

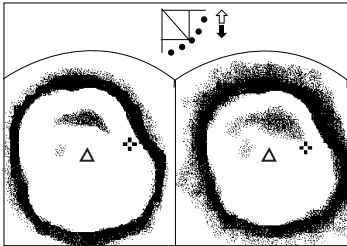

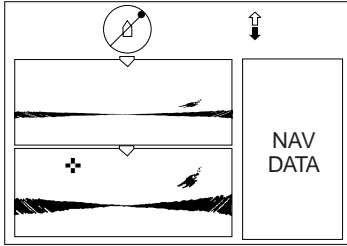
**Dual-frequency displays**

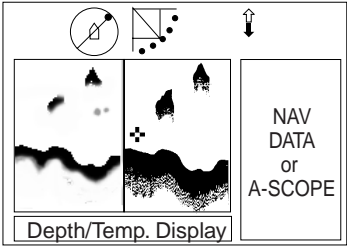
Key	Display	Key	Display
 x2	 <p><u>DUAL-FREQ HORIZONTAL</u></p> <p>360° dual-freq. display of fish echoes, etc. (Chapter 2)</p>	 x2	 <p><u>DUAL-FREQ. HORIZ. EXPANSION</u></p> <p>Expansion of dual-freq. horizontal display. (Chapter 2)</p>
 x2	 <p><u>DUAL-FREQ. VERTICAL SCAN</u></p> <p>Dual-freq. display of vertical section of fish echoes. Useful for judging depth and center position of fish school. (Chapter 3)</p>	 x2	 <p><u>DUAL-FREQ. ECHO SOUNDER</u></p> <p>Dual-freq. display of fish echoes below vessel. (Chapter 4)</p>

*Dual-frequency displays*

1. OPERATIONAL OVERVIEW

**Combination displays**

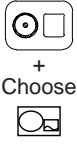
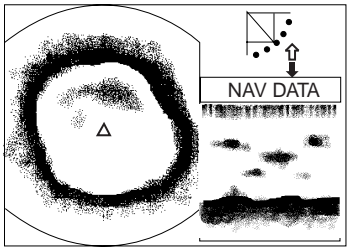
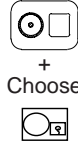
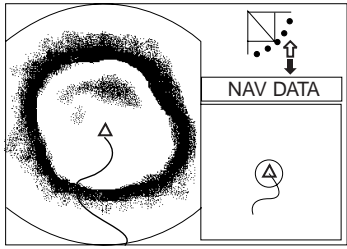
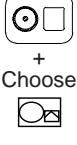
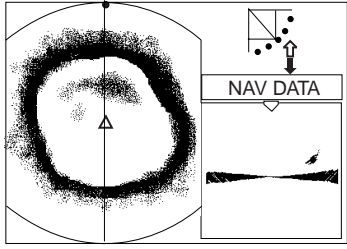
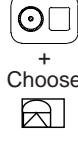
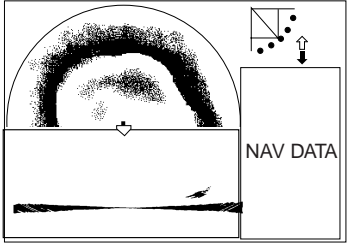
Key	Display	Key	Display
 <p>+ Choose</p>	 <p><u>HORIZONTAL/HISTORY</u></p> <p>The horizontal picture appears in the main window; the history picture in the sub window. Useful for showing history of fish movement, distribution. (Chapter 2)</p>	 <p>+ Choose</p>	 <p><u>HORIZONTAL/VIDEO PLOTTER</u></p> <p>The horizontal picture appears in the main window and the video plotter picture, which traces ship's track, in the sub window. (Chapter 2)</p>
 <p>+ Choose</p>	 <p><u>HORIZONTAL/VERTICAL SCAN</u></p> <p>The horizontal picture appears in the main window; the vertical fan picture in the sub window. (Chapter 3)</p>	 <p>+ Choose</p>	 <p><u>HORIZONTAL/VERTICAL ZOOM</u></p> <p>The horizontal picture appears in the main window; vertical zoom picture in the sub window. (Chapter 3)</p>

*Combination displays*

## 1.7 Choosing a Frequency

You may choose low frequency or high frequency, with the **LF/HF** key. The display shows HI or LO at the top of the screen depending on your selection. Use the table below to determine which frequency to use.

Item	Low frequency	High frequency
Long-range detection	<b>PREFERABLE</b> Attenuation loss is small on low frequency.	<b>NOT RECOMMENDED</b> Attenuation loss is great on high frequency.
Use in shallow waters	<b>NOT RECOMMENDED</b> Bottom echo is prominent because of wide beam width so fish echoes are hidden.	<b>PREFERABLE</b> Bottom echo is less prominent because of narrow beam width so fish echoes are easy to find.
Detection range (detection "leaks")	<b>PREFERABLE</b> Detection area is wide (beam width is wide).	<b>NOT RECOMMENDED</b> Detection area is narrow (beam width is narrow).
Detection of bottom fish	<b>NOT RECOMMENDED</b> Fish echo and bottom echo overlap. (Wide beam width)	<b>PREFERABLE</b> Fish echo and bottom echo are displayed separately. (Narrow beam width)
Detection of bait fish	<b>NOT RECOMMENDED</b> Not suited for this purpose. (Bait fish are not easily detected with low frequency.)	<b>PREFERABLE</b> Well suited for this purpose. (Bait fish are more easily detected with high frequency.)
Affected by air bubbles from other vessels	<b>NOT RECOMMENDED</b> Low frequency is easily interfered by cavitation from other vessels.	<b>PREFERABLE</b> High frequency is not easily interfered by cavitation from other vessels.

The dual-frequency display is useful for comparing the picture from one frequency against the other to overcome deficiencies in both. Use the single-frequency for objective-specific fishing.

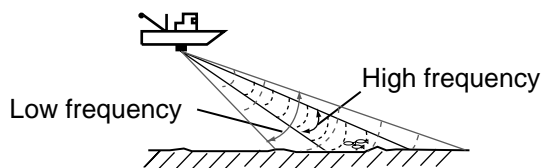

**Frequency selection and mode**

**Single-frequency display or combination display (other than vertical scan combination):** The **LF/HF** key chooses low frequency or high frequency alternately.

**Dual-frequency display (mix mode OFF):** The **LF/HF** key switches the frequency of the high-and low-frequency displays alternately.

**Dual-frequency display (mix mode ON):** The **LF/HF** key changes the frequency of the left-hand display\* (top display in dual-frequency vertical scan display) from low to high alternately.

\* Dual-frequency horizontal display, Dual-frequency horizontal expansion display, Dual-frequency echo sounder display.

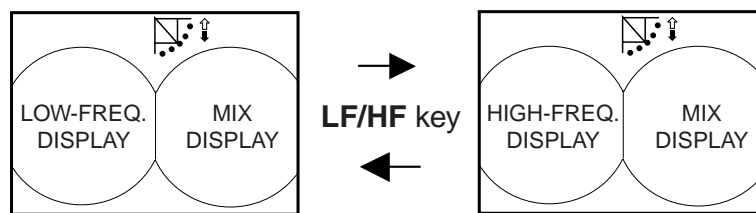

*Frequency switching in dual-frequency combination display, mix display ON*

**Combination display (vertical scan combination):**

Main window is active: The **LF/HF** key changes the frequency of the main window from low to high alternately.

Sub window is active: The **LF/HF** key changes the frequency of the sub window from low to high alternately.

To switch between main and sub windows use the **MAIN/SUB** key.

## 1.8 Mix Display

The mix display compares echo intensity between low and high frequencies, and displays echoes from tiny fish in discriminative colors. This is done by utilizing the fact that tiny fish return a stronger echo against a high frequency rather than a low frequency. The equipment accomplishes this as follows:

- If a high frequency echo is stronger than the corresponding echo on the low frequency, the high frequency echo is displayed.
- If the low frequency echo is stronger than or equal to the high frequency echo, it is less likely to be a tiny fish and therefore is displayed in blue.

In other words, the echoes displayed in orange thru light-blue may be considered to be tiny fish such as whitebait. When the mix display is active the indication MX appears at the top of the display.

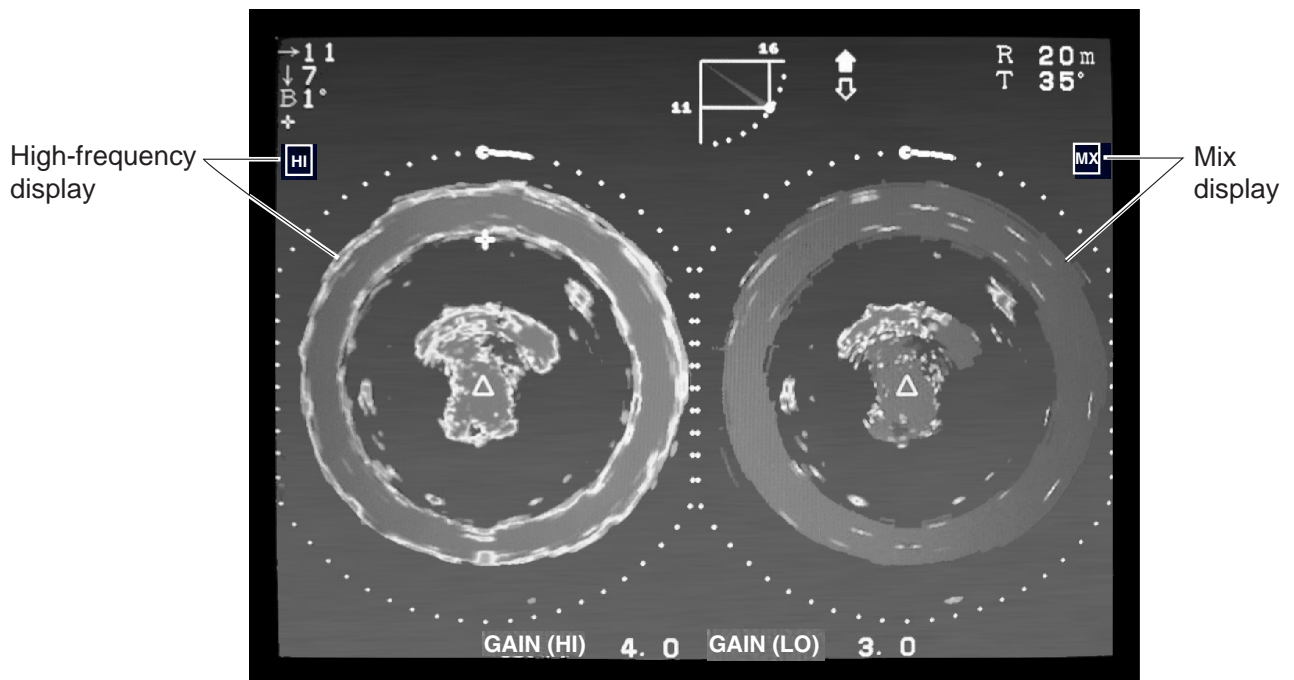

*How the mix display works*

## 1. OPERATIONAL OVERVIEW

To use the mix display effectively, it is important that the gain for both the low and high frequencies is set properly. When searching for young fish such as whitebait, follow the procedure below. For detailed information about gain adjustment, see the next section.

### **Gain adjustment**

1. Adjust the high-frequency gain while observing targeted fish.
2. While observing the mix display, set the low-frequency gain to 0 and gradually raise it just until echoes from adult fish disappear from the mix display.
3. While observing the echoes from young fish on the mix display, readjust the low-frequency gain in order to distinguish young fish. When the echoes from young fish are weak, lower the low-frequency gain. If adult fish appear, raise the low-frequency gain. (Rule of thumb: For whitebait, low-frequency gain is set 3-4 steps lower than high-frequency gain.)

To activate the mix mode, press the **MIX** key. How to display the mix display depends on the display mode in use.

**Single-frequency display or combination display (other than vertical scan combination):** Use the **MIX** key to switch between the mix display and the single-frequency display alternately.

**Dual-frequency display:** Use the **MIX** key to switch between the mix display and the dual-frequency display alternately.

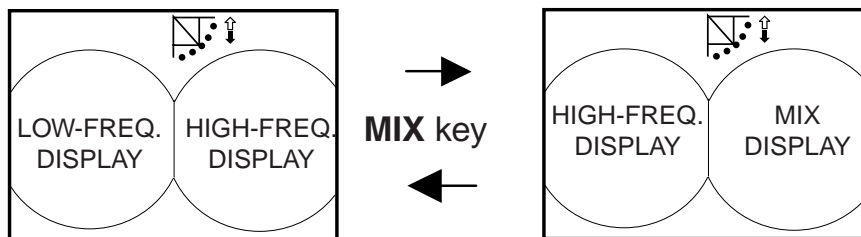

*How the MIX key works in dual-frequency mode*

### **Combination display (vertical scan combination):**

Main window is active: The **MIX** key changes the frequency of the main window from low to high alternately.

Sub window is active: The **MIX** key changes the frequency of the sub window from low to high alternately.

To switch between main and sub windows use the **MAIN/SUB** key.

## 1.9 Adjusting the Gain

The **GAIN** control adjusts the sensitivity of the receiver. Normally, the control is adjusted so that the bottom echo is displayed in reddish-brown mixed with red. Initially set the gain between “4” and “6” and then fine tune according to fishing ground, etc.

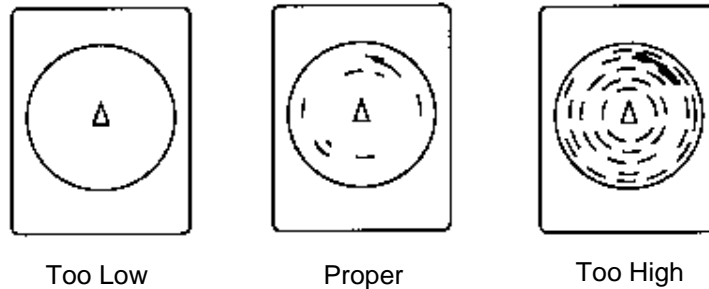

*How to adjust the gain*

### Single-frequency or combination display

When using both high and low frequency in the horizontal/vertical scan display, refer to the procedure on the next page.

1. Push the **GAIN** control.

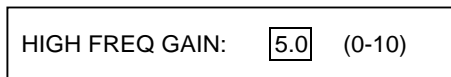

2. Turn the **GAIN** control to adjust the gain (range: 0-10).

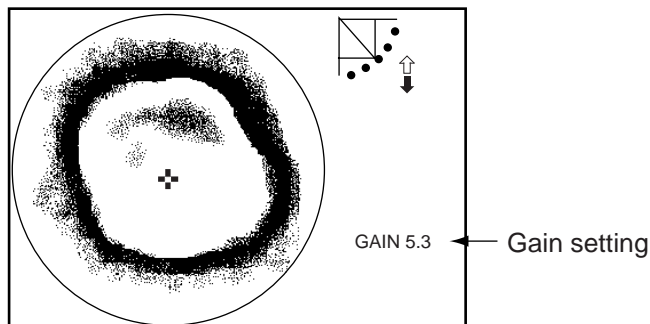

*Location of gain setting indication*

3. Press the **MENU** key to close the gain setting window. Note that it is not necessary to press the **MENU** key – the window will automatically if no operation is detected for four seconds.

**Note 1:** Step 1 is not necessary if the menu item GAIN SETTING PROTECT (SYSTEM SETTING 2 menu) is set for OFF.

**Note 2:** You can switch control between the main and sub windows in the horizontal/vertical scan display with the **MAIN/SUB** key.

## 1. OPERATIONAL OVERVIEW

### Dual-frequency display

1. Push the **GAIN** control.

HIGH FREQ GAIN : <input type="text" value="5.0"/>	(0-10)
LOW FREQ GAIN : 5.0	(0-10)
PUSH GAIN KNOB TO SPECIFY THE FREQ	
ROTATE GAIN KNOB TO CHANGE THE FREQ	

2. Push the **GAIN** control to choose the frequency for which you want to adjust the gain.
3. Rotate the **GAIN** control to adjust the gain (range: 0-10).

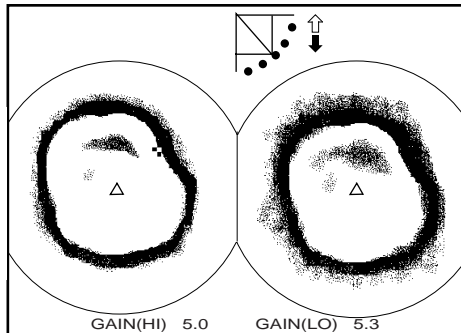

Gain setting high and low frequencies

*Location of gain setting indications on dual-frequency display*

4. Press the **MENU** key to close the gain setting window.



## 1.10 Menu Overview

The menu, consisting of six menus, mostly contains items which once preset do not require frequent adjustment. Below is the procedure for basic menu operation.

1. Press the **MENU** key to open the menu.

**Note:** Either PRESET (default setting) or SHORT-CUT appears between ES and SYS at the top of the screen depending on the setting of CUSTOM KEY on the SYSTEM SETTING 1 menu, and they set the function of the custom keys [1], [2], [3]. For further details see pages 5-3 through 5-7.)

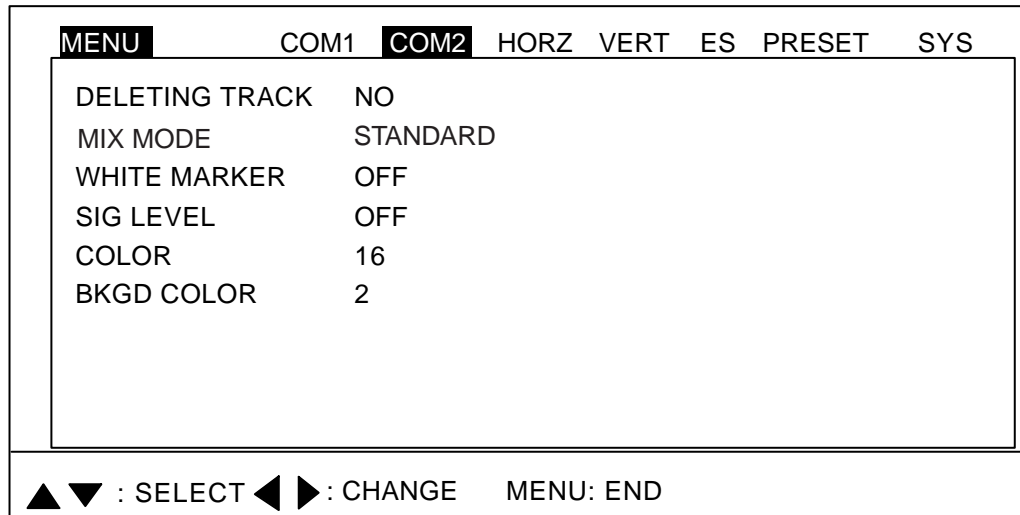

*COM2 menu*

2. The last-used menu is displayed. To choose a different menu, press ▲ to choose MENU and then press ◀ or ▶ to choose menu desired.
3. Press ▲ or ▼ to choose menu item desired. At the bottom of the screen menu help is provided.
4. Press ▶ to open the corresponding dialog box. The example below shows the dialog box for DELETING TRACK, which is in the COM2 menu.

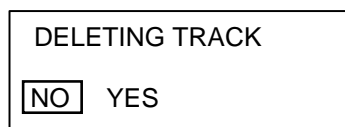

*Dialog box for deleting track*

5. Press ◀ or ▶ to choose option desired. If the option requires input of numeric data, use ◀ or ▶ to lower or raise the figure, respectively.
6. Press ▲ or ▼ to return to the menu, or press the **MENU** key to register your selection and close the menu.

## 1. OPERATIONAL OVERVIEW

This page intentionally left blank.

# 2. HORIZONTAL MODE

## 2.1 Operational Overview

The figure below shows the typical horizontal mode operating sequence.

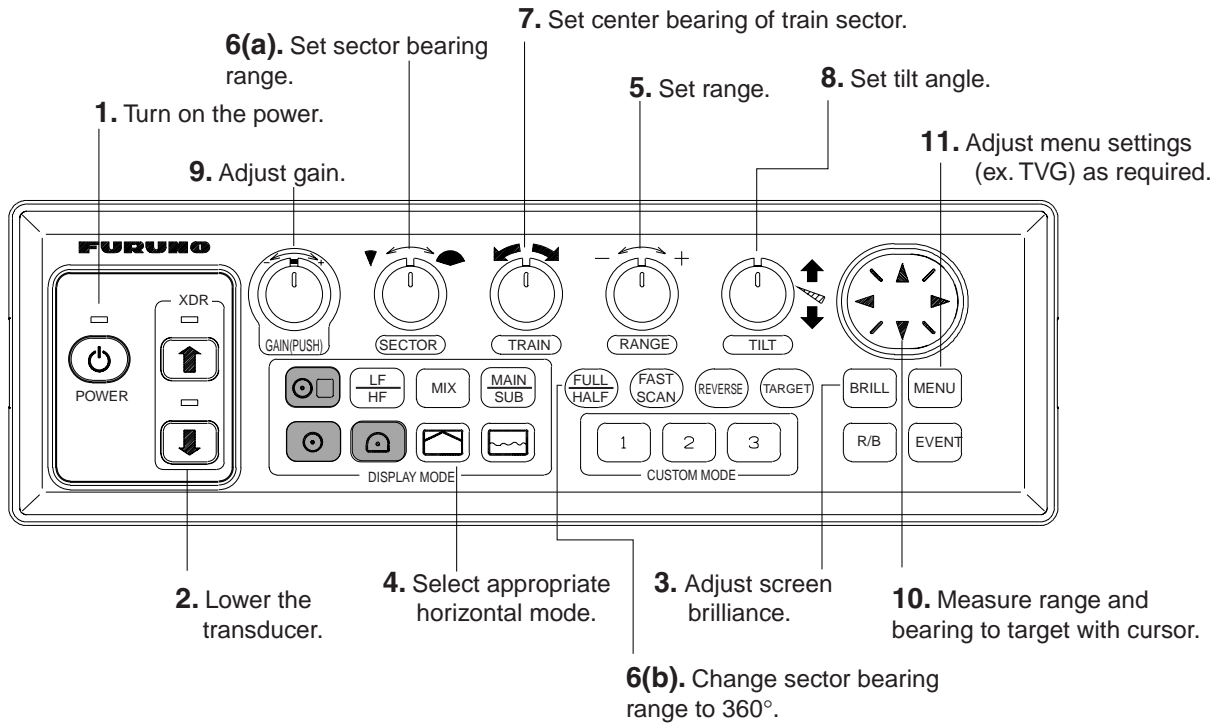

Control panel

## 2.2 Typical Horizontal Mode Display

Press the  (horizontal mode) key. Each press chooses the single frequency or dual-frequency horizontal mode display alternately.

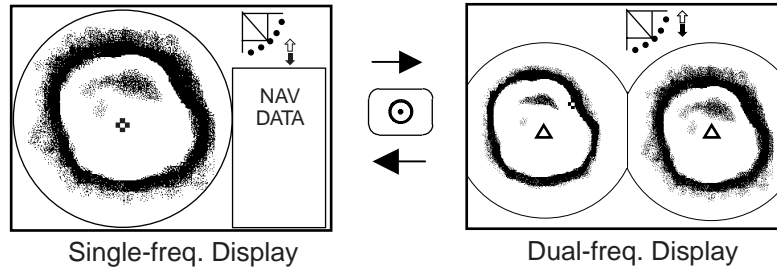

*Switching between single-frequency horizontal and dual-frequency horizontal displays*

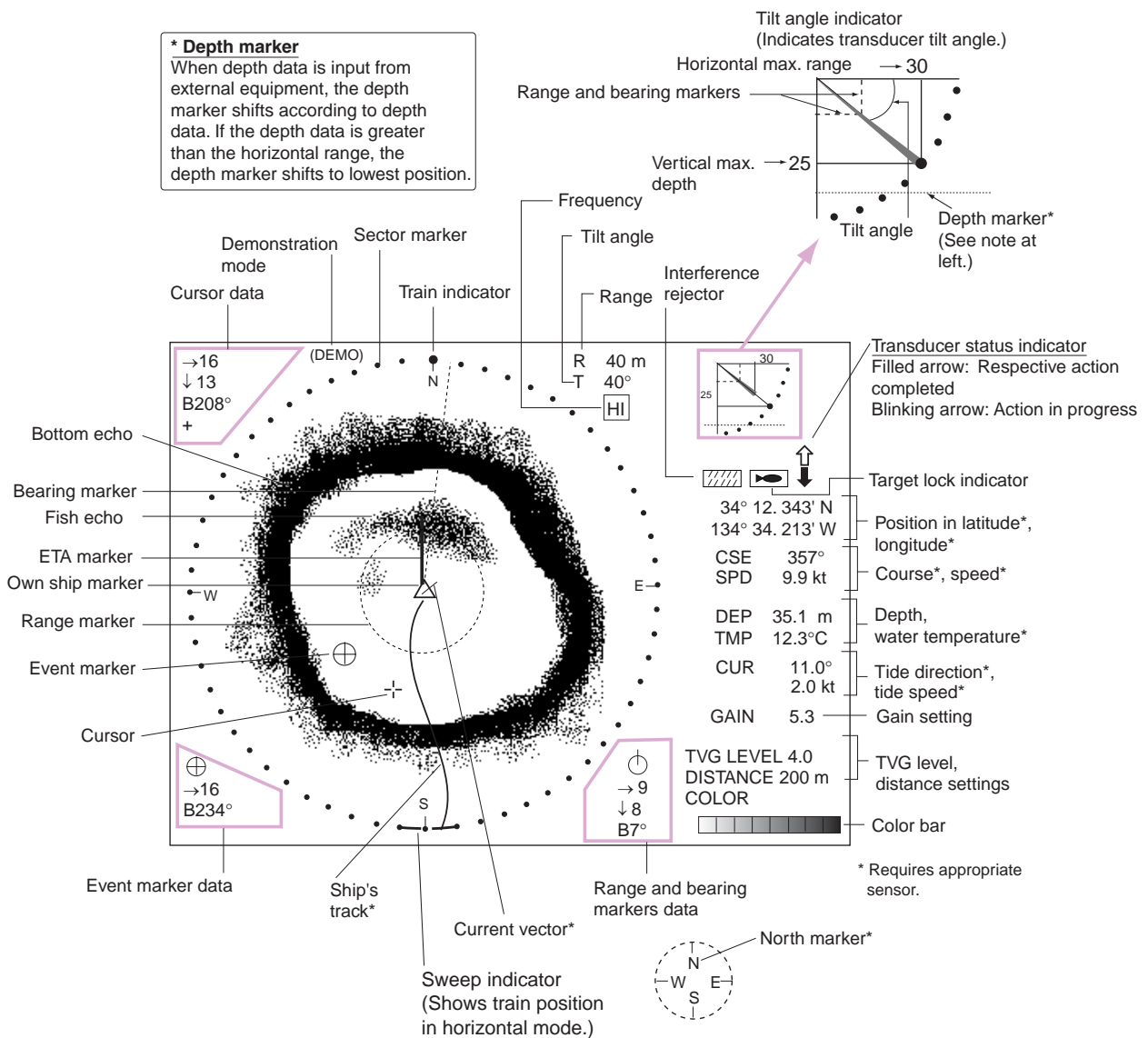

*Single-frequency horizontal display*

## 2.3 Choosing a Range

The **RANGE** control chooses the detection (display) range. Choose the range according to either the fish species being searched or the depth desired. 15 ranges are available and minimum and maximum ranges depend on the transducer used.

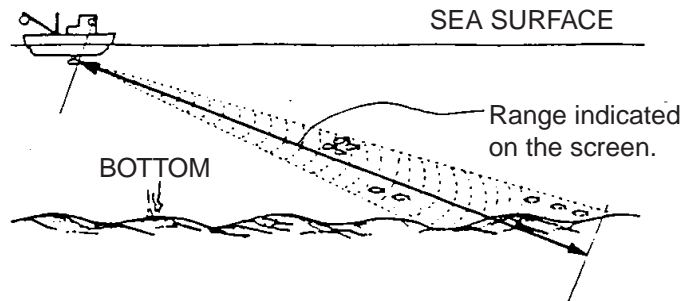

*Range description*

### Default horizontal mode range settings

	1	2	3	4	5	6	7	8	9	10	11	12	13	14	15
m	20	40	60	80	100	120	160	200	250	300	400	500	600	800	1200
ft	50	100	200	300	400	500	600	700	800	1000	1200	1500	2000	3000	4000

Normally the range is set so that the bottom is traced at the lower part of the screen (like an echo sounder). Each time the **RANGE** control is operated the newly selected range briefly appears in large characters at the screen top. Range is always displayed at the right-hand corner of the screen.

**Note 1:** Unit of range measurement may be chosen from among meters, feet, fathoms, passi/braza or Hiro (Japanese) with UNIT on the SYSTEM SETTING 1 menu. For details see page 5-11.

**Note 2:** Ranges may be freely preset as desired. For details see page 5-14.

## 2.4 Choosing Sector Width

You may set the width of the scanned sector.

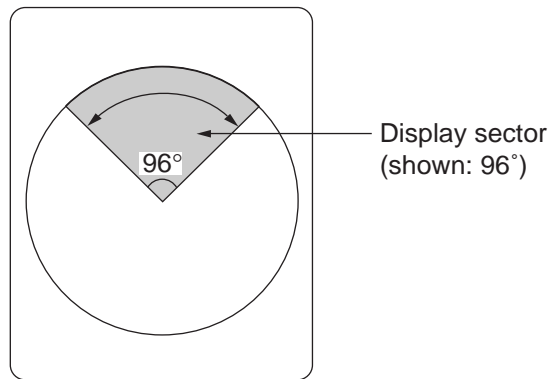

*Sector width*

The **SECTOR** control chooses the width of the scanned sector among the sixteen positions shown in the table below. Clockwise rotation of the control increases the sector width; counterclockwise rotation decreases it.

	1	2	3	4	5	6	7	8	9	10	11	12	13	14	15	16
Sector width (°)	6	24	48	72	96	120	144	168	192	216	240	264	288	312	336	360

In the full-circle mode (360°) the direction of training is clockwise; in the half-circle mode the direction is clockwise to counterclockwise alternately.

### One-touch selection of 360° sector

Each pressing of the **FULL/HALF** key alternately chooses 360° sector (full circle) or 168° sector (half circle). If the **SECTOR** control is operated following the selection of the full-circle display, the next pressing of the **FULL/HALF** key presents the full-circle display.

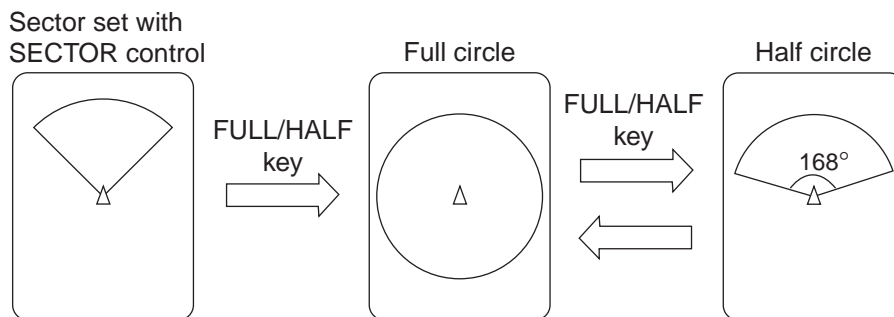

*How the FULL/HALF key works*

## 2.5 Choosing Train Center

The **TRAIN** control chooses the center direction of the detection range. The range of adjustment is  $0^\circ$  to  $354^\circ$  in increments of  $6^\circ$ . The selected bearing is shown with a filled circle, the train indicator, on the bearing scale.

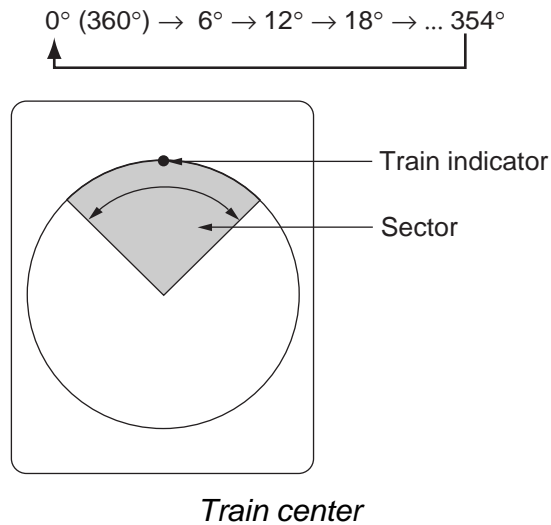

## 2.6 Choosing a Tilt Angle

The tilt angle shows the direction to which the sound wave is emitted. When the sound wave is emitted horizontally, the tilt angle is said to be  $0^\circ$  and when emitted vertically,  $90^\circ$ .

To set a tilt angle, operate the **TILT** control. Watch the tilt angle indication and tilt angle indicator at the top right corner of the screen. The tilt angle can be set in increments of  $1^\circ$  from  $0^\circ$  to  $+5^\circ$  (upward) to  $0^\circ$  to  $90^\circ$  (downward). Choose tilt angle depending on target fish. For surface fish choose a narrow angle (about  $5^\circ$ ) and for bottom fish, a wide angle (about  $40^\circ$ ).

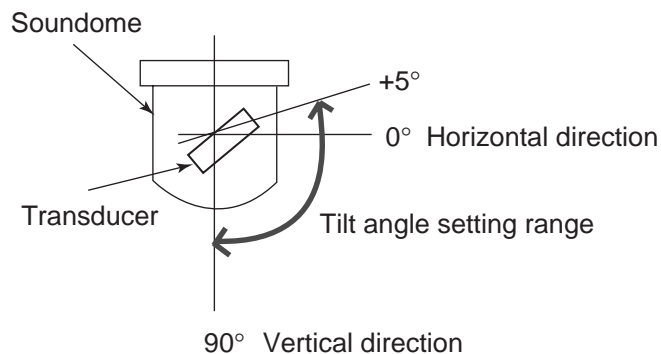

### 2.6.1 Tilt angle for surface fish

Sound emitted from the sonar transducer forms an oval-shaped beam with a width of approximately  $10^\circ$  ( $-3$  dB, full scan, vertical beam width on 85 kHz) in the vertical direction (vertical beam width). The tilt angle is indicated by the angle between the center line is parallel with the sea surface and one half of the emitted sound goes upward, toward the sea surface. This causes one half of the emitted sound to be reflected toward the transducer and displayed on the screen as sea surface reflections. When the sea is calm, since the sound is reflected just like reflections become negligible.

However if the sea is not calm enough, they will become dominant and interfere with observation of wanted echoes. To minimize these sea surface reflections and to search fish schools effectively, the tilt angle is usually set between  $5^\circ$  and  $7^\circ$  so the upper portion of the beam becomes almost parallel with the sea surface. When the sea is rough, the tilt angle is slightly increased to lessen the affect of sea surface reflections.

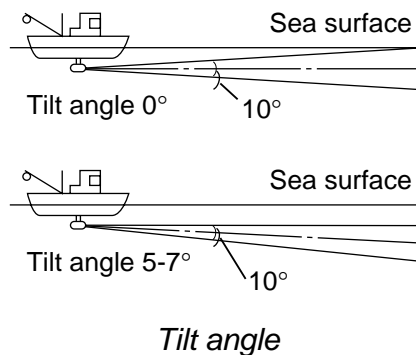

### 2.6.2 Distinguishing fish echo from bottom echo in coastal waters

In coastal operations the bottom reflection is prominent so it is important to be able to distinguish fish echoes from the bottom echo. The information below will help you to do this.

#### Tilt angle and bottom echo

**Case 1 - Tilt angle  $30^\circ$  to  $40^\circ$ :** The bottom echo, captured by the vertical beam width ( $10^\circ$  at  $-3$ dB full circle, 85kHz), is displayed "ring-shaped" and in strong colors.

**Case 2 - Tilt angle  $10^\circ$  to  $20^\circ$ :** The bottom echo is displayed wider and in weak colors as the distance to the bottom increases.

**Case 3 - Tilt angle  $0^\circ$  to  $5^\circ$ :** The bottom echo is either weak or is not displayed even if the vertical beam width captures the bottom echo, because the distance to the bottom is too far.



### How to discriminate fish echoes from the bottom

The figure at the bottom of the page illustrates how two fish schools "a" and "b" are displayed on the screen using three different tilt angles.

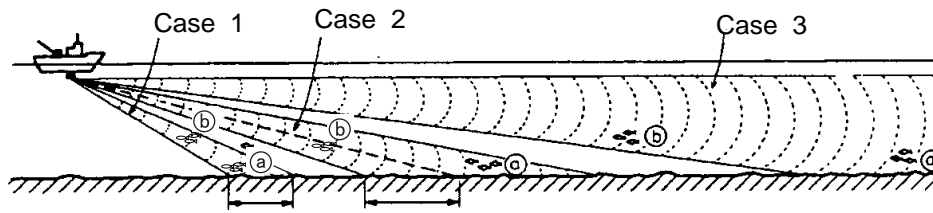

(Case 1, 2 and 3 are relative to the bottom pictured above.)

#### *Detecting beam and fish position*

Using the above three cases, fish schools will be displayed as below.

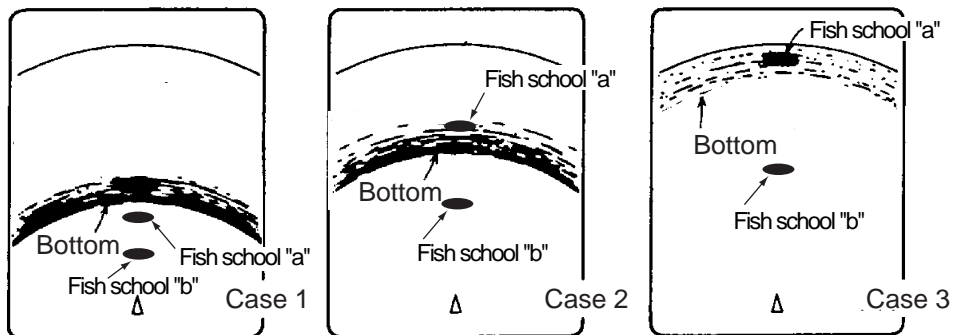

#### *Fish echo and tilt angle*

**Case 1 (Tilt angle 30° to 40°):**

Fish school "a" and "b" are just above the bottom echo.

**Case 2 (Tilt angle 10° to 20°):**

Fish school "b" is clearly seen. Fish school "a" is behind the bottom echo therefore it is difficult to discern.

**Case 3 (Tilt angle 0° to 5°):**

Bottom echo is weak so fish school "b" is easily seen. Fish school "a" is masked by the bottom echo so it is difficult to discern. However, larger fish schools may appear in this condition.

### 2.6.3 Suitable tilt angle

The figure below illustrates the relationship among tilt angle (0, 5, 10 and 15 degrees), depth and detection range. Refer to it to find out the suitable tilt angle for a given depth/detection range.

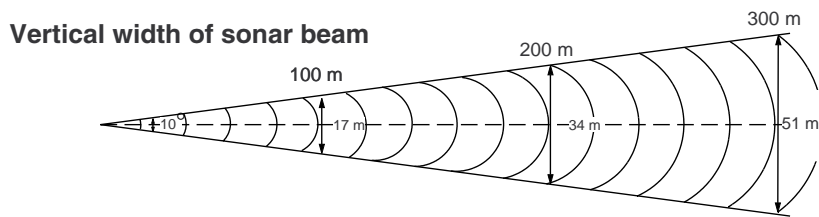
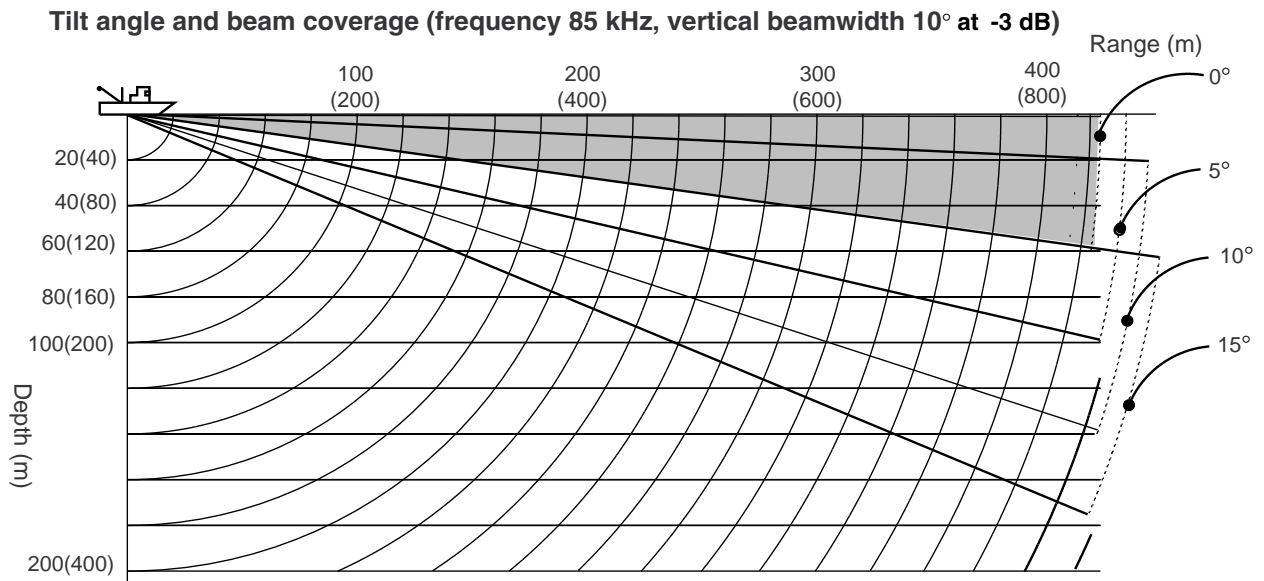

*Tilt angle and beam coverage*

*Frequency and detection range*

Frequency	Vertical beam width	100 m	200 m	300 m
85 kHz	10° (-3 dB)	17 m	34 m	51 m
60 kHz	14° (-3 dB)	24 m	48 m	72 m
153 kHz	5° (-3 dB)	9 m	18 m	27 m
215 kHz	4° (-3 dB)	7 m	14 m	21 m

## 2.7 Choosing Training Speed

The training speed chooses how fast the transducer scans the sounding sector. Two choices are available, normal speed (default setting) and high speed, and one may be selected with the **FAST SCAN** key. Each time the key is pressed “NORM” (normal speed) or “FAST” (high speed) momentarily appears at the screen top.

Normal (6°): 60 transmissions required to complete full 360° picture (default setting).

High (12°): On ranges higher than 160 m, 30 transmissions required to complete the full 360° picture.

The time necessary to train a full circle depends on frequency, range and mode. The table below shows the time required to complete one full circle in the horizontal mode.

### Single frequency

Range (m)	20	40	60	80	100	120	160	200	250	300	400	500	600	800	1200	
Time (sec)	NS*	9	9	9	9	9	11	14	17	21	25	33	41	49	65	97
	HS*	9	9	9	9	9	11	12	14	16	18	22	26	30	38	54

### Dual frequency

Range (m)	20	40	60	80	100	120	160	200	250	300	400	500	600	800	1200	
Time (sec)	NS*	11	11	11	11	11	12	15	18	22	26	34	42	50	66	98
	HS*	11	11	11	11	11	12	14	15	17	19	23	27	31	39	55

\* NS, Normal Speed, HS, High Speed

## 2.8 Changing Training Direction

The training direction may be reversed to reconfirm fish echoes. Press the **REVERSE** key to reverse training direction between counterclockwise and clockwise alternately.

“REVERSE” appears at the top of the screen for three seconds when training direction is reversed.

## 2.9 Finding Echo Position with the Cursor

The cursor measures horizontal range, depth and bearing. Operate the Omnipad to place the cursor where desired. Cursor position data appears at the top left-hand corner on the screen.

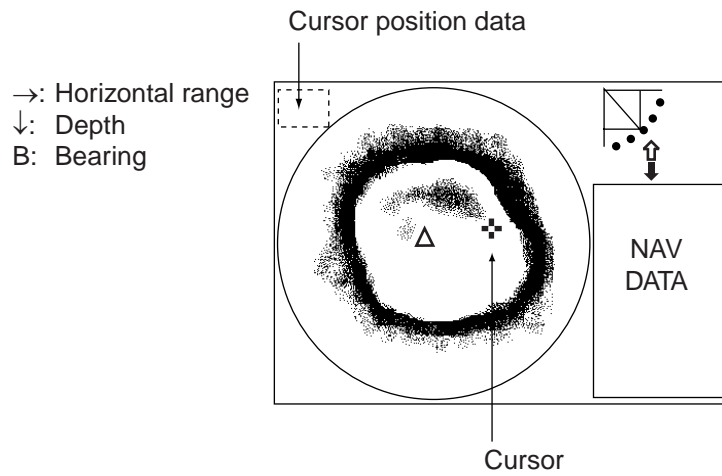

*Location of cursor position data*

## 2.10 Event Marker

The event marker functions to mark important locations on the horizontal mode display, and five event markers may be inscribed. Press the **EVENT** key to inscribe the event marker. Each time the key is pressed the "latest event marker" (⊕) is inscribed at the cursor location and all previously entered event markers are shown by the "previous event marker" (+). Five event markers may be entered and when the capacity for event markers is reached the eldest event marker is erased from the screen to make room for the latest.

**Note 1:** Event markers cannot be entered from the history or video plotter display (other display in horizontal combination displays). Event markers may only be entered from the horizontal display.

**Note 2:** The tilt angle must be less than 75-degrees. Correct event marker position data is not possible with the tilt angle higher than 75-degrees.

**Note 3:** Event marker position may be output to external equipment. See paragraph 5.4.2

**Note 4:** Event markers are only erased from the currently used display (horizontal, vertical, echo sounder).

### Entering an event mark

1. Operate the Omnipad to place the cursor on the location desired for an event marker.
2. Press the **EVENT** key to inscribe the event marker. Event marker data appears at the bottom left-hand corner.

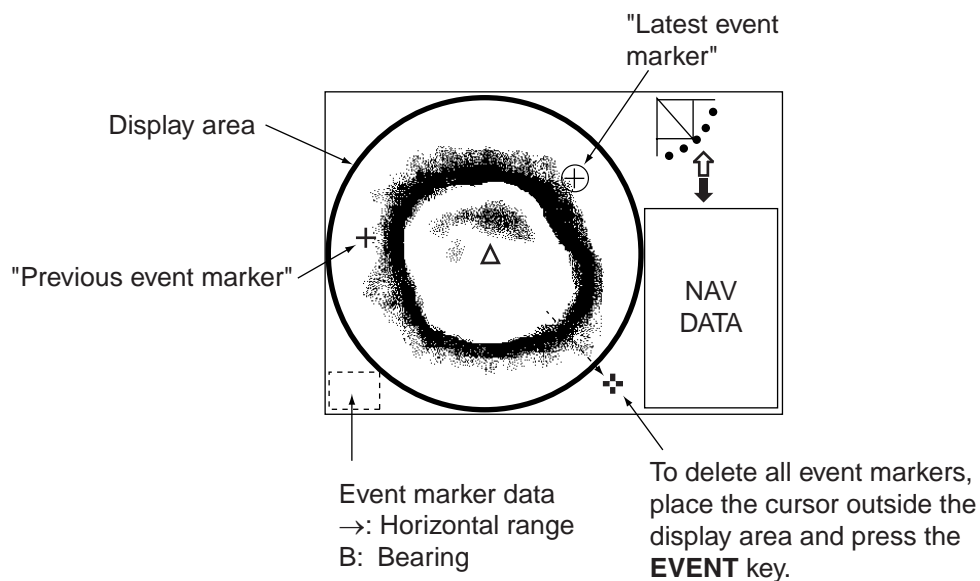

*How to use the event marker*

**Deleting all event markers from the horizontal display**

To delete all event markers inscribed on the horizontal mode display, do the following:

1. Operate the Omnipad to place the cursor outside the display area.
2. Press the **EVENT** key to show the following dialog box. Do the next step within four seconds, otherwise the dialog box will be erased.

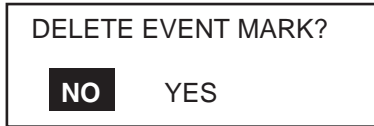

3. Press **▶** to choose YES and then press the **MENU** key.

**2.11 Depth and Horizontal Range Markers**

The horizontal range, depth and bearing to a fish school can be measured by using the range and bearing markers.

**Note:** Range and bearing markers cannot be inscribed on the history display or video plotter display.

1. Operate the Omnipad to place the cursor on the location desired.
2. Press the **R/B** key to display the range and bearing markers. Horizontal range, depth and bearing to the cursor location are shown at the bottom right-hand corner of the screen.
3. To erase the range and bearing markers, place the cursor outside the display area and press the **R/B** key, or place the cursor on the range or bearing marker and press the **R/B** key.

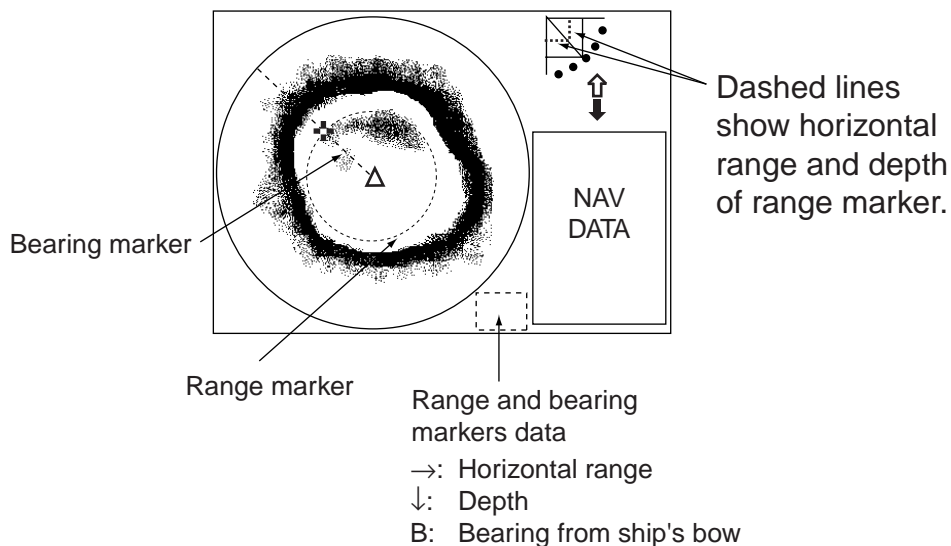

*Range and bearing markers*

## 2.12 Adjusting the Picture

### 2.12.1 Suppressing bottom and surface reflections

In shallow fishing grounds, excessive sea surface and bottom reflections often interfere with wanted fish echoes and they cannot be eliminated sufficiently with the TVG controls. In such cases, try to reduce the output power, without turning down the gain. The picture becomes clearer when output power is reduced rather than when the gain is decreased.

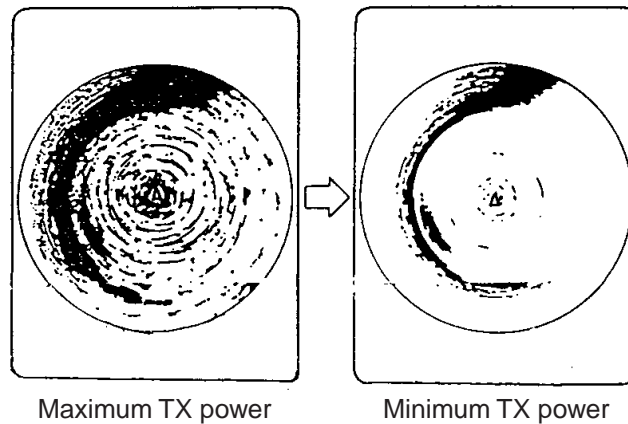

*Sonar image and TX power setting*

1. Press the **MENU** key to open the menu.
2. Press **▲** to choose MENU and then press **◀** to choose the COM1 menu.

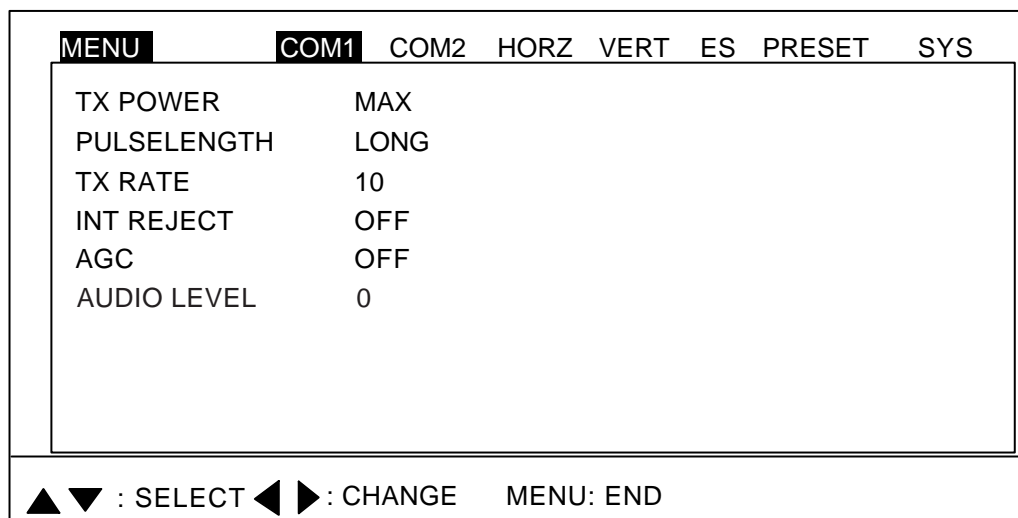

*COM1 menu*

3. Press **▲** to choose TX POWER and then press **▶**. The following dialog box appears.

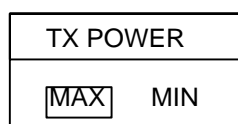

4. Press **▶** to choose MIN. (For long-range detection be sure to return the setting to MAX.)
5. Press the **MENU** key to register your selection and close the menu.

### 2.12.2 Suppressing bottom tail

As described earlier, fish schools near the bottom are sometimes difficult to detect because you have to discriminate fish echoes from the bottom reflections. To discriminate fish echoes near the bottom, choose the short Tx pulselength on the COM1 menu to decrease the tail of bottom reflections.

1. Press the **MENU** key to open the menu.
2. Press **▲** to choose MENU and then press **◀** to choose the COM1 menu.
3. Press **▲** or **▼** to choose PULSELENGTH and then press **▶**. The following dialog box appears.

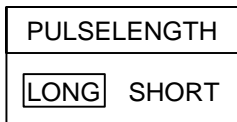

4. Press **▶** to choose SHORT.
5. Press the **MENU** key to register your selection and close the menu.

### 2.12.3 Displaying weak echoes clearly

Echoes from targets (such as the bottom or a fish) return to the transducer in order of the distance to them, and when their intensities are compared at the transducer face, those from nearer targets are generally stronger when their reflecting properties are nearly equal. The sonar operator will be quite inconvenienced if these echoes are directly displayed on the screen, since he won't be able to judge the actual size of the target from the size of echoes displayed on the screen. To overcome this inconvenience, use the TVG function. It compensates for propagation loss of sound in water: amplification of echoes on short range is suppressed and gradually increased as range increases, so that similar targets are displayed in similar intensities irrespective of the ranges to them.

The TVG also functions to suppress unwanted echoes and noise which appears in a certain range area on the screen.

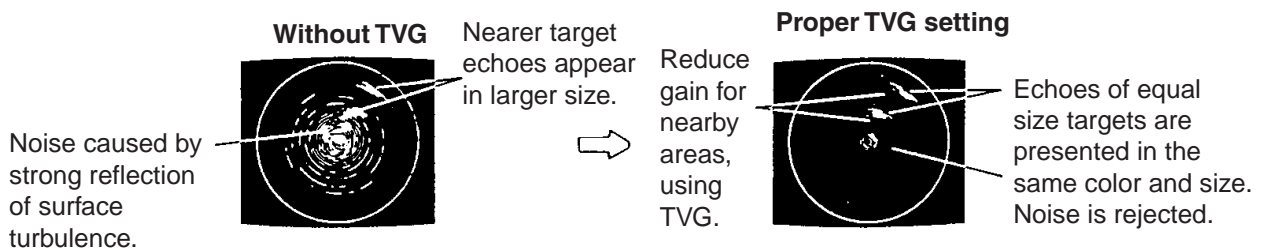

*How TVG works*

**Note:** Excessive TVG may eliminate short-range echoes.



**To adjust TVG:**

1. Press the **MENU** key to open the menu.
2. Press **▲** to choose MENU and then press **◀** or **▶** to choose HORZ.

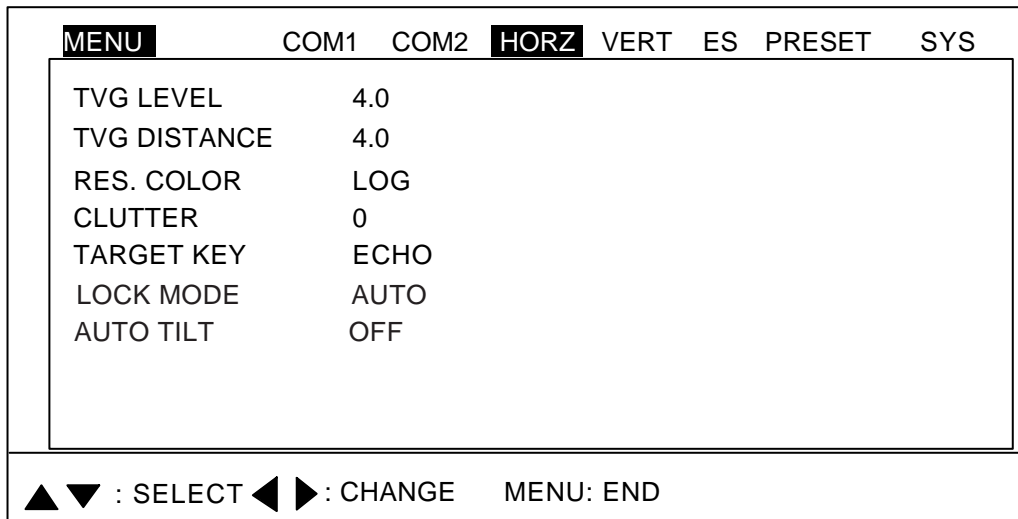

*HORZ menu*

3. Press **▲** or **▼** to choose TVG DISTANCE and press **▶**. The following dialog box appears.

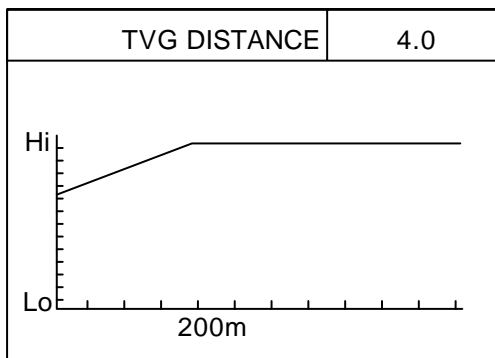

4. Press **◀** or **▶** to adjust TVG distance between 3.0 and 5.0 (130-320 m). As a general rule, use a higher setting for low-frequency transducer; a lower setting for high frequency transducer. The larger the figure the greater the distance at which TVG works. When you open the TVG dialog box the TVG line changes from solid to dashed and a solid line denotes current TVG setting.

TVG Distance Setting	0	0.5	1.0	1.5	2.0	2.5	3.0	3.5	4.0	4.5	5.0	....	10.0
Meters	3	8	20	40	60	100	130	160	200	250	320	....	1000
Feet	10	30	70	130	210	330	410	520	660	820	1040		3280
Passi/braza	2	5	10	20	40	60	80	100	120	150	180		600
Hiro	2	5	10	20	40	60	80	100	130	170	210	....	660

## 2. HORIZONTAL MODE

5. Press the **MENU** key to register your selection and close the menu.
6. To suppress reflections by the sea surface or plankton, choose TVG LEVEL and press **▶**.
7. Press **◀** or **▶** to adjust TVG LEVEL, considering sea conditions. A setting between 2.0 and 5.0 should provide satisfactory results. The higher the figure the less the gain over distance.
8. Press the **MENU** key to register your selection and close the menu.
9. Watch a distant fish echo which is approaching own ship, adjusting the tilt angle so the fish echo is within the sounding beam. Observe color of fish echo. If the color and size of the echo stay the same as the echo approaches own ship, the TVG setting is proper. If the echo suddenly becomes smaller, the TVG level may be too high.

### 2.12.4 Erasing weak echoes

Weak echoes such as interference can be erased from the screen, using the “signal level” feature. This is useful when you want to observe a fish school echo.

1. Press the **MENU** key to open the menu.
2. Press **▲** to choose MENU.
3. Press **◀** to choose COM2.
4. Press **▲** or **▼** to choose SIG LEVEL.
5. Press **▶** to open the dialog box.



6. Press **◀** or **▶** to choose echo color to erase. Pressing **▶** erases echoes from weak to strong in ascending order of strength. You can also see which echo color is erased by watching the color bar.
7. Press the **MENU** key to register your selection and close the menu.

### 2.12.5 Suppressing interference from marine life

If you are fishing in an area where there are a lot of fishing vessels, you may receive interference from other vessels' sonar or echo sounder. Further, electrical interference onboard own ship may generate interference. To suppress this type of interference use the interference rejector.

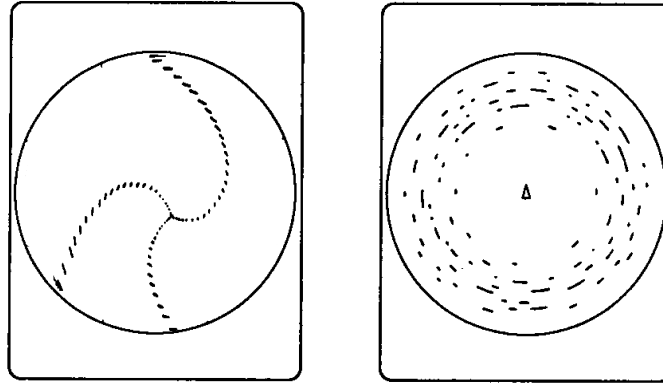

(A) Inteference from other sonars (yours or other's)

(B) Interference from marine life

*Interference from other sonars, marine life*

1. Press the **MENU** key to open the menu.
2. Press **▲** to choose MENU and then press **◀** to choose the COM1 menu.
3. Press **▲** or **▼** to choose INT REJECT and then press **▶**. The following dialog box appears.

INT REJECT			
<input type="checkbox"/>	LoFREQ	<input type="checkbox"/>	HiFREQ
<input type="checkbox"/>	BOTH		

4. Press **◀** or **▶** to choose the frequency where you want to suppress interference. When the interference suppressor is turned on  appears at the top of the screen.
5. Press the **MENU** key to register your selection and close the menu.

Note that the interference rejector cannot be turned on/off independently for each frequency in case of the dual-frequency display.

### 2.12.6 Enlarging fish echoes (horizontal expansion display)

Fish echoes may be enlarged 1.5 times by using the horizontal expansion display. Press the  key to activate the horizontal expansion display (single frequency). Then, the horizontal display is expanded at the center of training direction, bow direction.

Train center direction	Position after expansion	Remarks
318° -42°	Moves to screen bottom	For viewing forward
48° -123°	Moves to left side of screen	For viewing starboard side
138° -222°	Moves to screen top	For viewing aft
228° -312°	Moves to right side of screen	For viewing port side

You can switch between the single-frequency horizontal expansion display and the dual-frequency horizontal expansion display alternately with the  key as shown below.

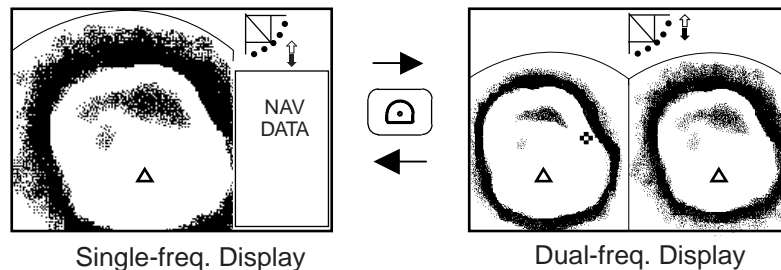

Switching between single-frequency horizontal expansion and dual-frequency horizontal expansion displays

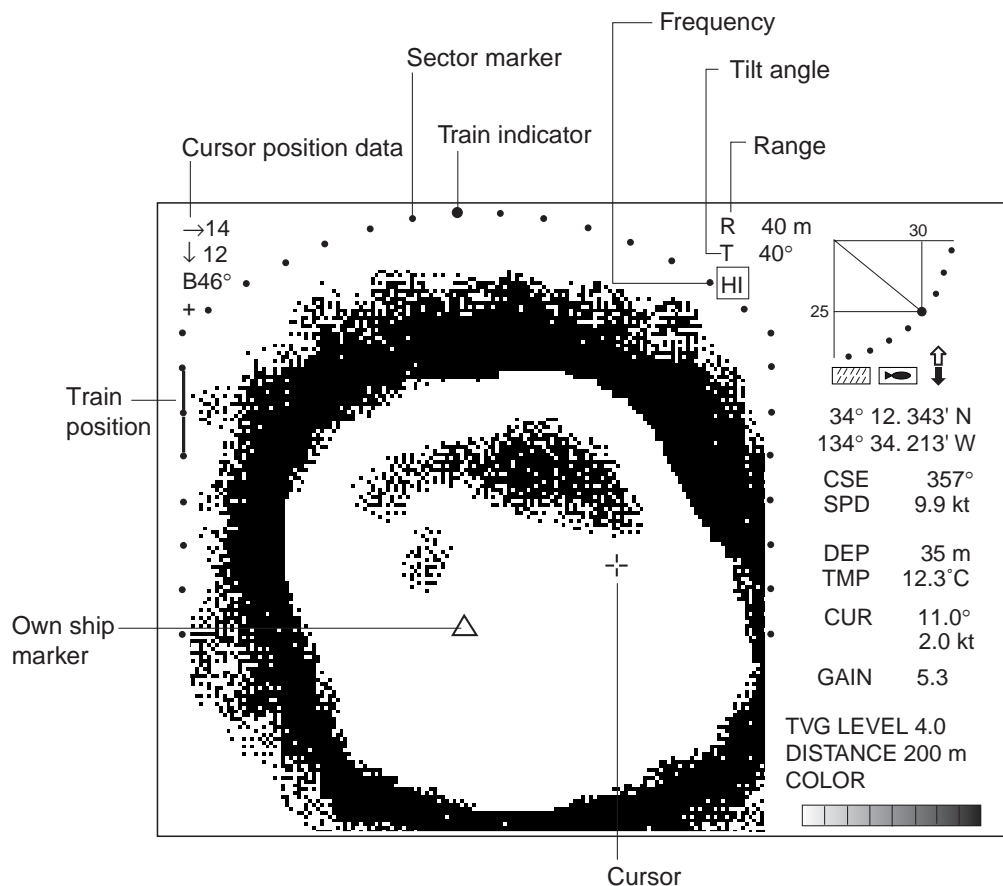

Horizontal expansion display

## 2.13 Target Lock

Two types of target lock modes are available.

- Position:** Tracks stationary position (such as a reef) using position data from a navigator. Available in the horizontal mode only.
- Echo:** Tracks fish echo either manually or automatically. Available in the horizontal mode only.

### 2.13.1 Choosing a target lock mode

1. Press the **MENU** key to open the menu.
2. Press **▲** to choose MENU
3. Press **◀** or **▶** to choose the HORZ menu.
4. Press **▲** or **▼** to choose TARGET KEY.
5. Press **◀** or **▶** to show following dialog box.

TARGET KEY	
POS	ECHO

6. Press **◀** or **▶** to choose option desired.
7. Press the **MENU** key to register your selection and close the menu.

### 2.13.2 Position mode

This mode tracks a stationary position (such as a reef) using position data fed from a navigator.

**Note 1:** This function is inoperative in the echo sounder mode.

**Note 2:** This mode requires position data. When there is no position data the message “NO POSITION DATA.” appears for four seconds and tracking is automatically cancelled. Check the navigator.

**Note 3:** The tilt angle must be less than 75 degrees to use this feature.

1. Use the Omnipad to choose the location to track.
2. Press the **TARGET** key.

The message “POS LOCK” appears momentarily at the screen top, the target lock marker is displayed at the cursor position and the target lock indicator appears at the top right-hand corner of the screen while tracking (with position data from external equipment) is occurring. **SECTOR**, **TILT** and **FULL/HALF** controls are inoperative since their functions are inoperative during position mode target lock.

The detection area is fixed at 48-degrees. Tilt angle and train are automatically adjusted to track the target even if your vessel is moving.

## 2. HORIZONTAL MODE

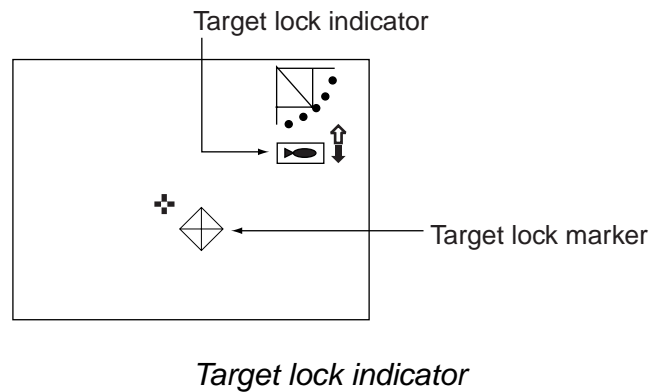

3. To turn off the target lock, press the **TARGET** key again. The message "LOCK END" momentarily appears, the target lock marker and the target lock indicator disappear and previously used sector, train and tilt settings are restored. Also, latitude and longitude indication returns to normal.

**Note 1:** Target lock is automatically canceled if position data is lost.

**Note 2:** When target lock is activated in the vertical scan combination display, the vertical bearing cursor automatically shows target direction. When target lock is canceled the vertical bearing cursor is returned to its previous position. The vertical scan display operates like the vertical search features when the target lock is active. For further details about the vertical search feature, see page 5-8.

### 2.13.3 Echo mode

The echo mode tracks a fish school either automatically or manually. The default setting is automatic, and you can choose automatic or manual with "LOCK MODE" in the HORZ menu. Note that this mode is not available in the vertical scan or echo sounder mode

#### Automatic tracking

The automatic echo target lock function automatically tracks a fish school appearing in the operator-chosen target lock zone. I

1. Press the **TARGET** key.

The dialog box below appears at the screen center, the message "ECHO LOCK" appears for three seconds at the top of the screen, the target lock area appears in the current train area and the target lock indicator appears at the right-hand side of the screen.

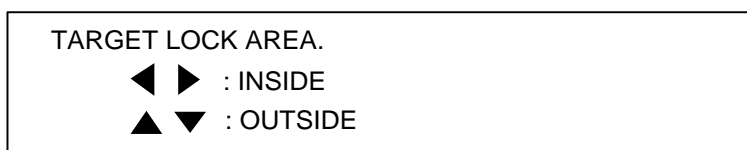

2. Use the Omnipad to set the detection area: ▲ of ▼ to set the outer boundary; ◀ or ▶ to set the inner boundary. Use the SECTOR and TRAIN controls to adjust the detection area. Do not include bottom echoes in the zone, so that target lock will not be activated by bottom echoes.

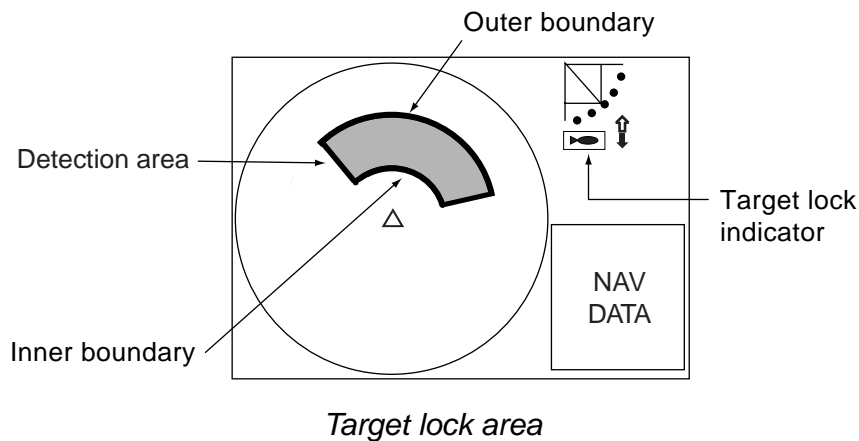

When a target of red or reddish-brown color is detected in the zone, the target lock indicator blinks, the buzzer sounds and the detection area disappears. When a tracked target is lost, the operation shown below is repeated.

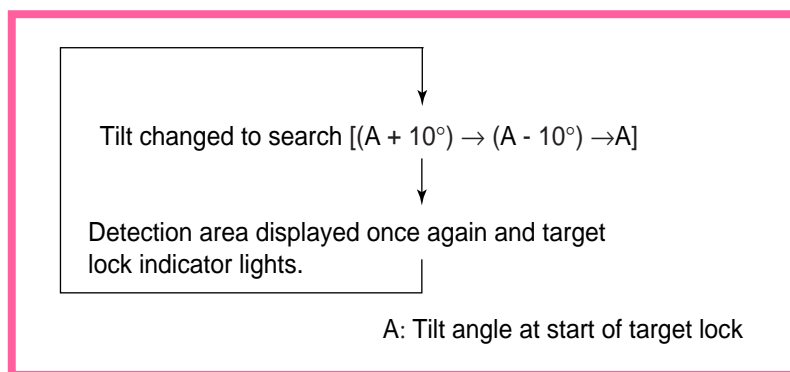

3. If the target does not appear even though the tilt angle is changed, adjust the **SECTOR** and **TRAIN** controls to change the detection area.
4. To turn off the target lock, press the **TARGET** key again. The message "LOCK END" appears for three seconds at the screen top, the target lock indicator disappears and operation continues with current train and tilt settings.

### Manual tracking

1. Set LOCK MODE to MANUAL on the HORZ menu.
2. Press the **TARGET** key when a wanted target echo appears.

The message "ECHO LOCK" appears along with the target lock indicator. Then, the transducer train direction is reversed and searching starts with the current tilt angle. When a target echo appears the transducer train direction is again reversed automatically, the buzzer sounds and the target lock indicator blinks.

If the fish echo is lost the tilt angle is automatically changed to continue tracking as shown right.

1. Tilt angle is changed by  $+10^\circ$  ( $A+10^\circ$ ).  
(A is the tilt angle used when tracking began.)
2. Tilt angle is changed by  $-10^\circ$  ( $A-10^\circ$ ).
3. If the echo could not be found, tracking is cancelled and tilt angle A is restored.

4. To quit the target lock, press the **TARGET** key again. The message "LOCK END" appears momentarily.

## 2.14 Horizontal Menu Overview

This section presents an overview of the items on the HORZ menu.

1. Press the **MENU** key to open the menu.
2. Press **▲** to choose MENU and then press **◀** or **▶** to choose the HORZ menu.

<b>MENU</b>	COM1	COM2	<b>HORZ</b>	VERT	ES	PRESET	SYS
TVG LEVEL		4.0					
TVG DISTANCE		4.0					
RES. COLOR		LOG					
CLUTTER		0					
TARGET KEY		ECHO					
LOCK MODE		AUTO					
AUTO TILT		OFF					

▲ ▼ : SELECT   ◀ ▶ : CHANGE   MENU: END

*HORZ menu*

3. Press **▲** or **▼** to choose item desired.
4. Press **▶** to show corresponding dialog box.
5. Press **◀** or **▶** to choose option desired.
8. Press the **MENU** key to register your selection and close the menu.

### 2.14.1 Horizontal menu description

**TVG LEVEL:** Compensates for propagation loss of sound in water. Default setting is 4.0. For further details, see paragraph 2.12.3.

**TVG DISTANCE:** As above. Default setting is 4.0.

**RES. COLOR:** Sets transfer characteristics of input signal level versus display echo level. Echo strength is emphasized in order of CUBE, SQUARE, LINEAR, LOG, and you can observe the characteristics of each by watching the color bar as you change the setting.

**LOG:** Displays weak to strong echoes in their respective levels. This is the default setting, and is suitable for general use.

**LINEAR:** Downplays the weak echoes when compared with LOG. Effective for suppressing weak echoes such as plankton.

**SQUARE:** Strong echoes are emphasized more than in LINEAR.

**CUBE:** Strong echoes are emphasized even more than in SQUARE.

**CLUTTER:** Low intensity echoes, often caused by sediments in water, are painted on the screen as a large number or random dots. This noise can be suppressed. The higher the number (setting) the weaker the echoes which are erased.



**TARGET KEY:** Chooses target lock function between position and echo. Default setting is ECHO. For further details see paragraph 2.13.

**LOCK MODE:** Chooses how to track fish echo in "echo" target lock; automatically or manually. Default setting is AUTO. For further details see paragraph 2.13.

**AUTO TILT:** Turns automatic tilt on or off, and the default setting is OFF. The choices are  $\pm 2^\circ$ ,  $\pm 4^\circ$ ,  $\pm 6^\circ$ , and  $\pm 10^\circ$ . Automatic tilt adjusts the tilt angle in the following sequence:  
B  $\rightarrow$  (B-A)  $\rightarrow$  B  $\rightarrow$  (B+A)  $\rightarrow$  B  $\rightarrow$  (B-A)  $\rightarrow$  B  $\rightarrow$  (B+A) ...  
B: Current tilt angle  
A: Auto tilt setting

For example, the tilt angle is  $30^\circ$  and the automatic tilt setting is  $4^\circ$ . Then, the tilt angle is changed in the following sequence:  $30^\circ \rightarrow 26^\circ \rightarrow 30^\circ \rightarrow 34^\circ \rightarrow 30^\circ \rightarrow 26^\circ \rightarrow 30^\circ \rightarrow 34^\circ \dots$

**Note:** The **TILT** control is inoperative when automatic tilt is active.

## 2.15 Interpreting the Horizontal Display

This section provides information necessary for interpreting the horizontal display.

### 2.15.1 How the horizontal mode picture is painted

The wide sounding beam is emitted from the soundome at a certain tilt angle (see hatched area in the figure below). The information (target echoes) obtained by this beam is displayed in sectors of increments of  $12^\circ$  of the screen. Thus, all directions around the boat are sounded in 30 times of transmissions.

**Note:** When the "FAST SCAN" is switched off, the equipment operates in a narrow sounding beam. Then, the echoes appear on a  $6^\circ$  sector in each transmission, so 60 transmissions are required to complete the full  $360^\circ$  picture ( $6^\circ \times 60 = 360^\circ$ ). This means that training speed is slower. However, since transmission power is concentrated into the narrow sounding beam, a superior detection range is obtained. Furthermore, since the bottom contour is painted distinctly, bottom fish may be more easily detected.

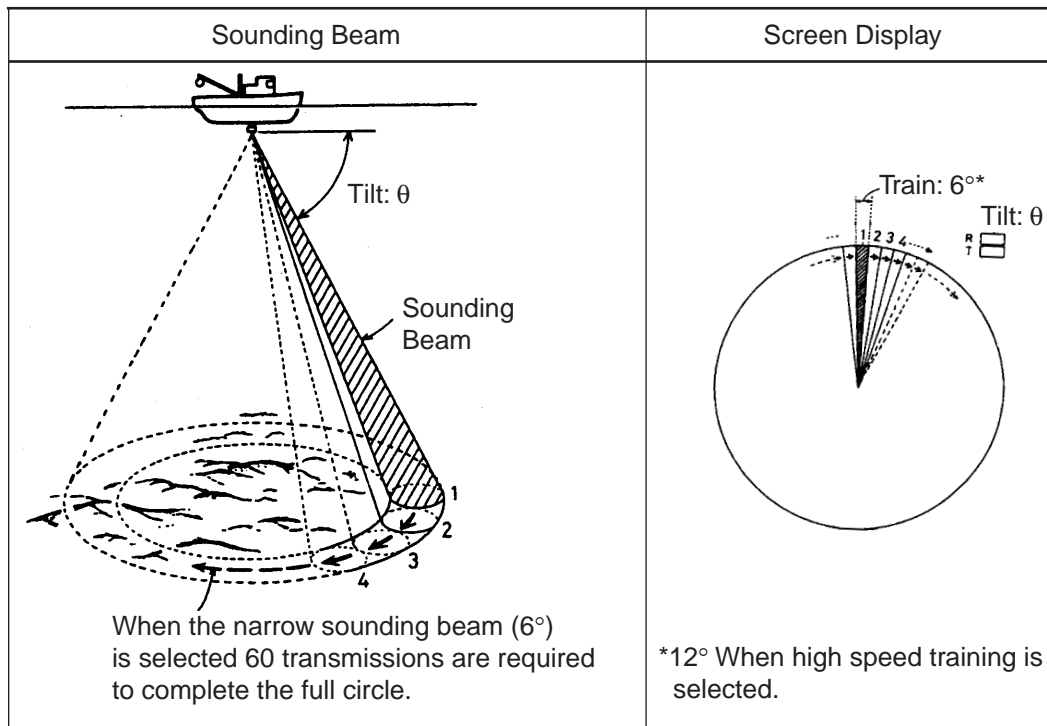

*How the horizontal mode picture is painted*

## 2.15.2 Sample displays

This section provides various examples of horizontal mode displays. The appearance of actual fish echoes will vary according to factors such as transmission frequency, gain and TVG settings, and bottom composition and contour.

### Bottom echoes

When the tilt angle is changed, the bottom echo illustrated below will appear on the display. When the tilt is decrease (toward 0°), the bottom trace becomes wider and weaker. By observing the bottom condition on the display, the skipper can prevent net damage.

(A) Flat bottom

Tilt angle: 10° to 15°

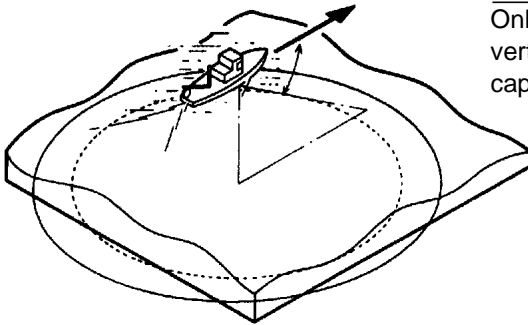

Decreased tilt angle  
Only half of  
vertical beam width  
captures the bottom.

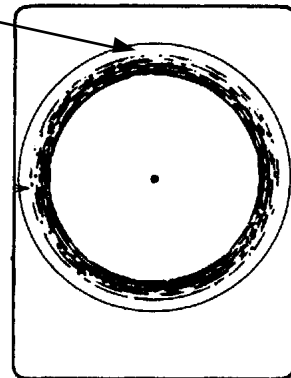

(B) Flat bottom

Tilt angle: 20° or more

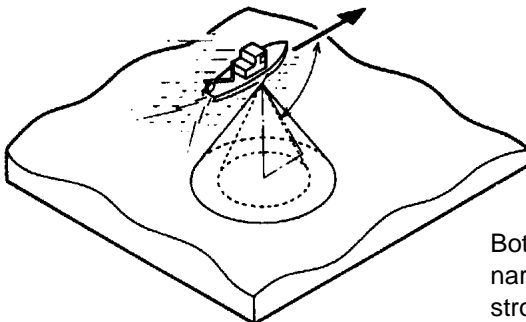

Bottom is displayed  
narrower and in  
stronger colors when  
compared to (A).

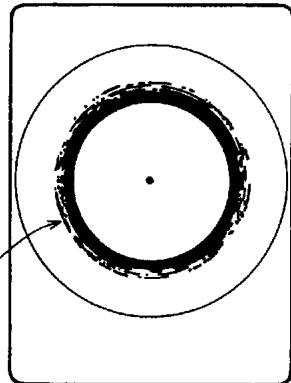

(C) Sloping bottom

Tilt angle: 20° or more

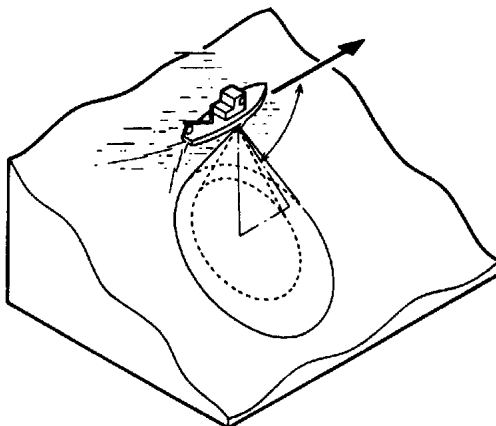

Shallow bottom  
is displayed in  
a strong color  
and with a  
short tail.

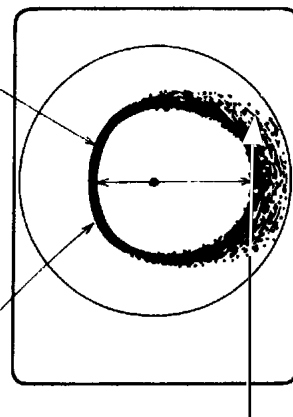

Bottom

The deeper, sloping  
bottom echo is displayed  
in a weak color and  
with a long tail.

*Bottom echoes*

## 2. HORIZONTAL MODE

### Fish schools

A fish school appears as a mass of echoes on the screen. The color of the mass shows the density of fish schools on the sonar beam. To find distribution and center point of a fish school, try several different tilt angles.

(A) Sea surface fish  
Tilt angle: 0° to 10°

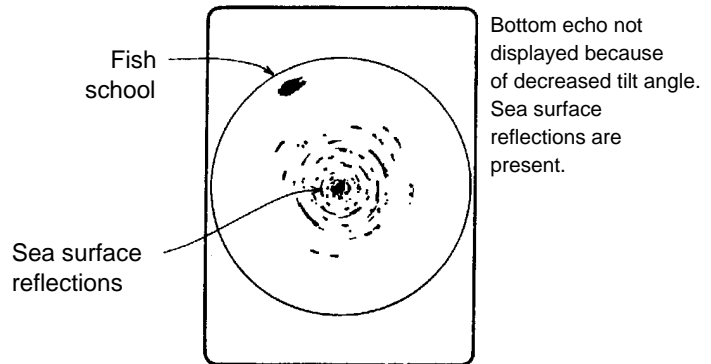
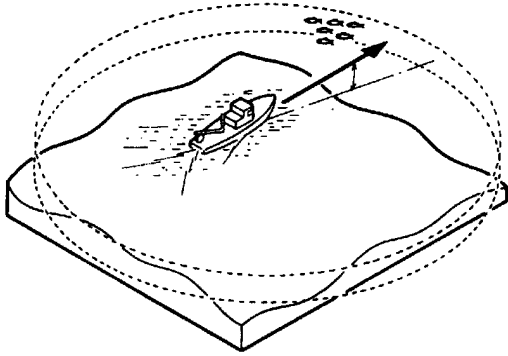

(B) Midwater, bottom fish Tilt angle: 30° or more  
Fish echo which appears before bottom can be detected.

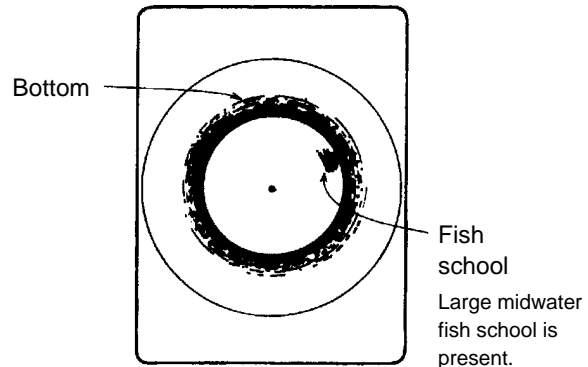
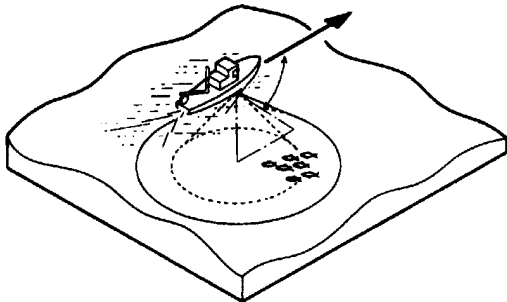

Tilt angle: 0° to 20°  
Fish echo which appears together with or after bottom can be detected.

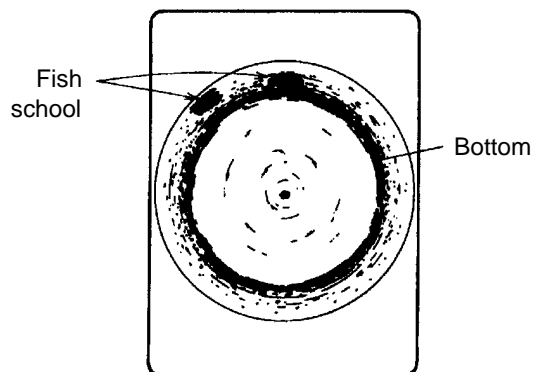
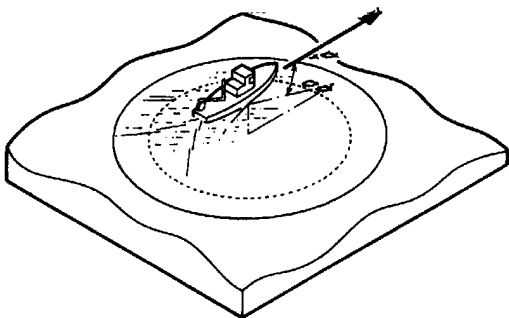

When the tilt angle is shallow, the reflection echo from bottom is weak and the fish echo which appears from bottom is easy to find.

*Fish schools*

**Sea surface reflections**

To reduce sea surface reflections, set the tilt angle to 5° or higher, so the upper edge of the sonar beam does not hit the sea surface, or adjust TVG. When a decreased tilt angle is used, sea surface reflections cover a large area as illustrated below.

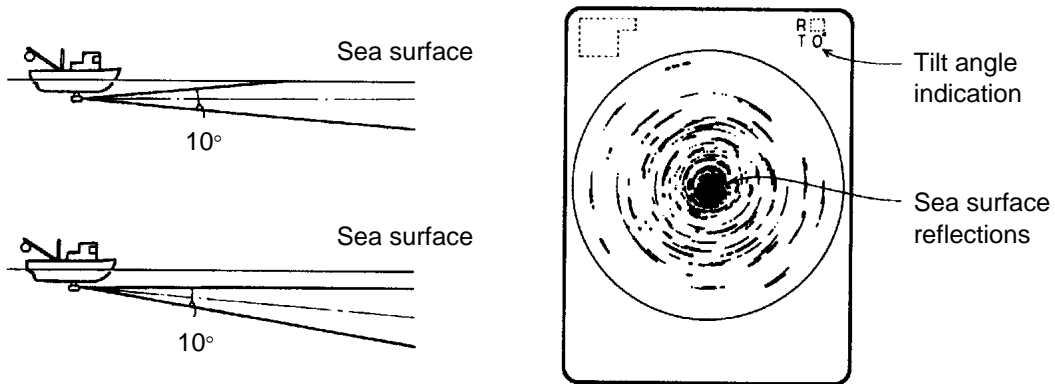

*Sea surface reflections*

**Wake**

A wake produced by own ship or another ship can be a strong reflecting object when a decreased tilt angle is used. As the wake appears as a thick continuous line, it can be easily distinguished from a fish school. A wake contains many air bubbles which attenuate ultrasonic energy, making it difficult to sound beyond the wake.

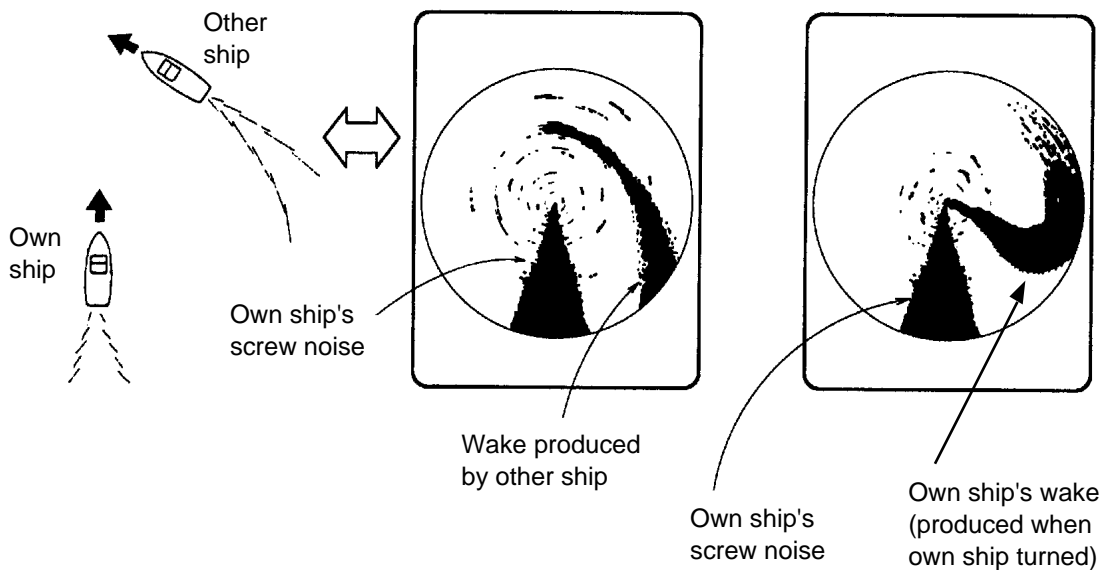

*Wake*

**Sidelobe echo (false echo)**

An ultrasonic wave is emitted only in the direction set by the **TILT** control, however there are some emissions outside the main beam. These are called sidelobes. The energy of the sidelobe is fairly weak but when the water is comparatively shallow and the bottom is rocky and hard, strong signals are detected by the sidelobe. These are represented on the display as a false echo as shown below.

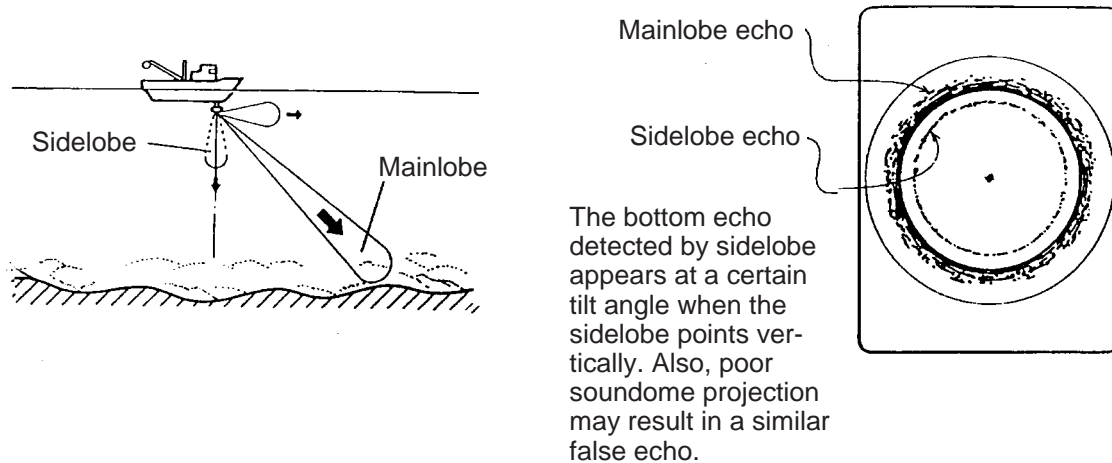

*Sidelobe echoes*

**Noise**

When the fishing ground is crowded with many fishing boats, the sonar is subject to interference from ultrasonic equipment (echo sounder or sonar) on other boats as well as those on own ship.

For instance, interference from the sonar operated on other boats will show itself on the display as in the figure below. This interference can be suppressed by changing the Tx rate on the COM1 menu.

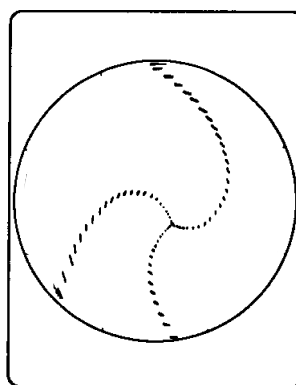

*Interference from sonars*

### 2.15.3 Combination display examples

#### How to choose a combination display

1. Press the  key to show the combination display selection window.



2. Use ▲ or ▼ to choose the combination display desired. You may also use the  key to choose a display.
3. Press the **MENU** key to close the selection window, or wait four seconds for it to close automatically.

**Note 1:** Combination displays may be disabled on the SYSTEM SETTING 2 menu. Only those displays which are turned on appear in the combination display selection window.

**Note 2:** If all combination displays are turned off the vertical scan combination display is automatically shown.

## 2. HORIZONTAL MODE

### Horizontal/history display

The horizontal display appears in the main window; the history display in the sub window. The length of the picture displayed in the history display is equal to about four full circle pictures. Thus the history display enables you to observe the history of fish movement and distribution. It is also useful for detecting bottom fish, reefs and sunken vessels.

The history display cannot be adjusted.

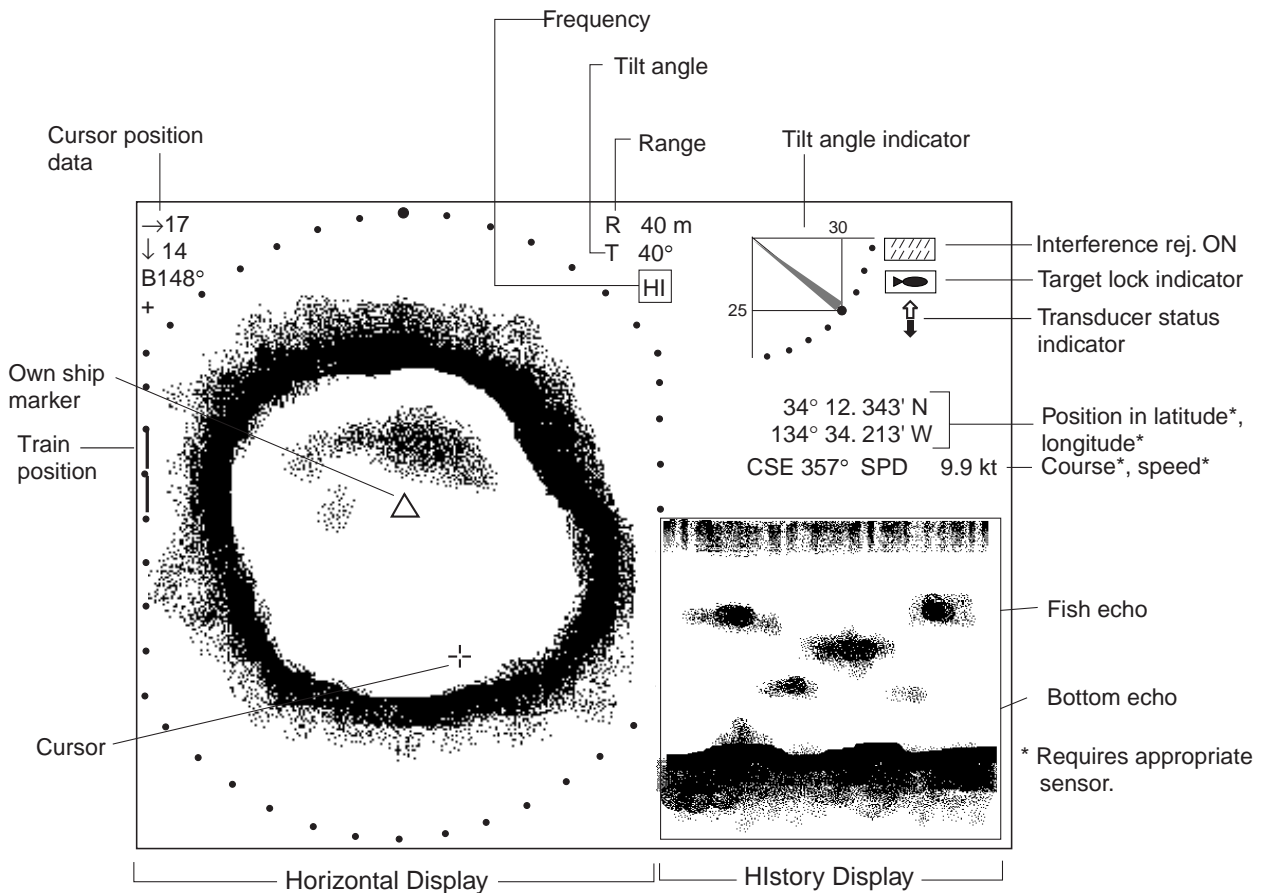

*Horizontal/history display*



### Horizontal/video plotter display

The horizontal display appears in the main window; the video plotter display, which traces ship's track on the display, in the sub window. Compared to the horizontal display the video plotter's range is much longer. For example, an event marker entered on the horizontal display disappears from that display when it goes out of the current range. However, when entered on the video plotter display it remains on the video plotter display for a much longer time when a long range scale is used. This can be useful when you want to return to the location denoted with an event marker. Like with the horizontal display you can inscribed five event markers on the video plotter display.

To display track on the horizontal display, the tilt angle must be less than 75 degrees.

You may switch control between the horizontal display and the video plotter display with the **MAIN/SUB** key. The message MAIN WINDOW CONTROLLABLE or SUB WINDOW CONTROLLABLE appears with each pressing of the key. A red rectangle circumscribes the sub window when it is chosen. With the video plotter display selected you may change its range with the **RANGE** control.

**Note:** Controls other than RANGE may only be operated from the main window. When you attempt to operate them when the sub window is chosen the message SELECT MAIN WINDOW appears.

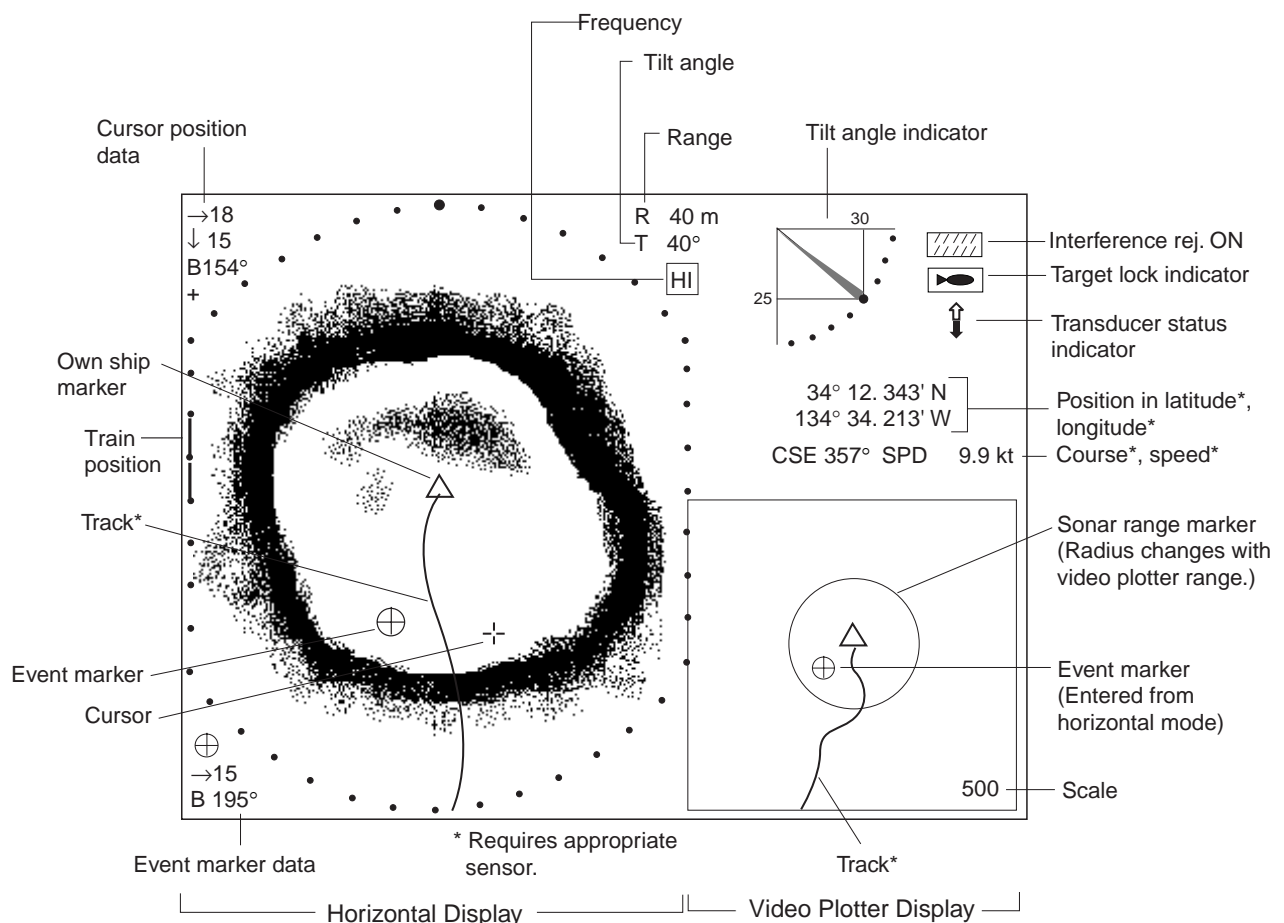

*Horizontal/Video Plotter display*

## 2. HORIZONTAL MODE

This page intentionally left blank.

# 3. VERTICAL SCAN MODE

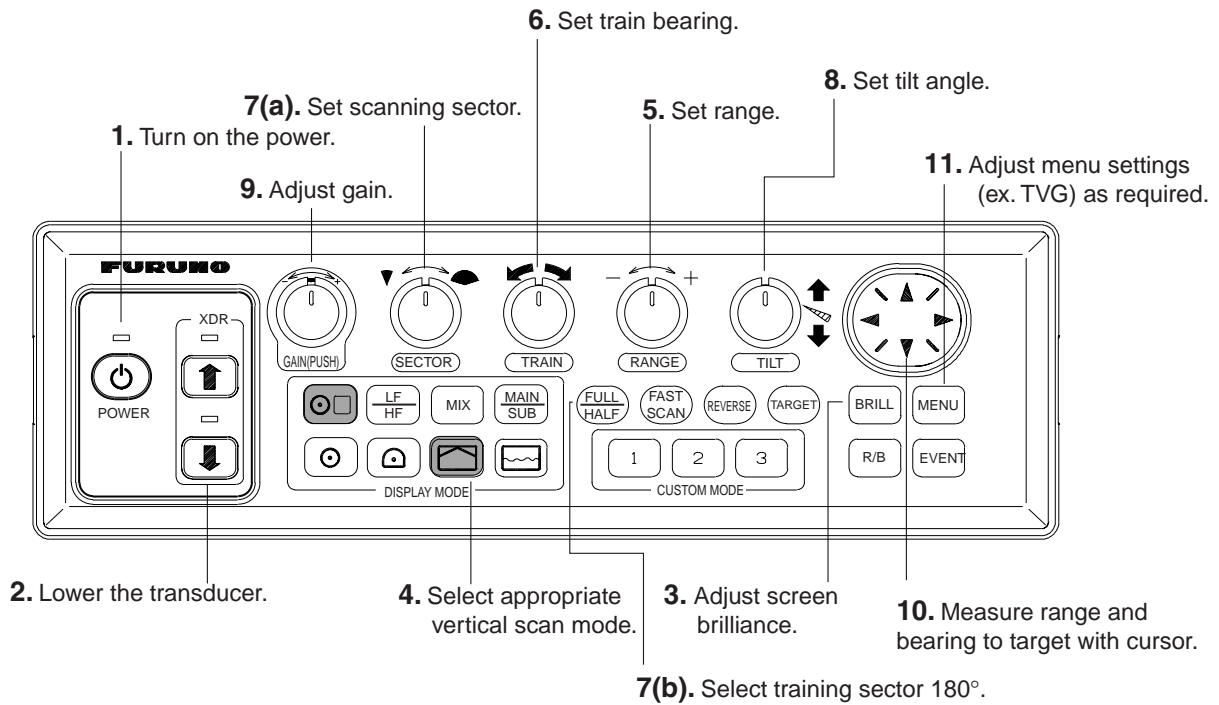

## 3.1 Operational Overview

The figure below shows the typical vertical scan mode operating sequence.



Control panel

### 3.2 Typical Vertical Scan Mode Display

Press the  key to show the vertical scan display. You can switch between the single-frequency vertical scan display and the dual-frequency vertical scan display alternately with the  key as shown below.

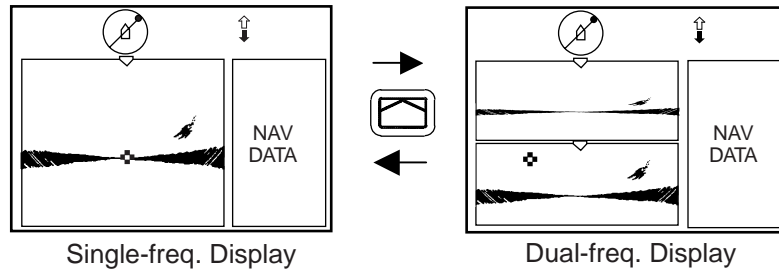

Switching between single-frequency vertical scan and dual-frequency vertical scan displays

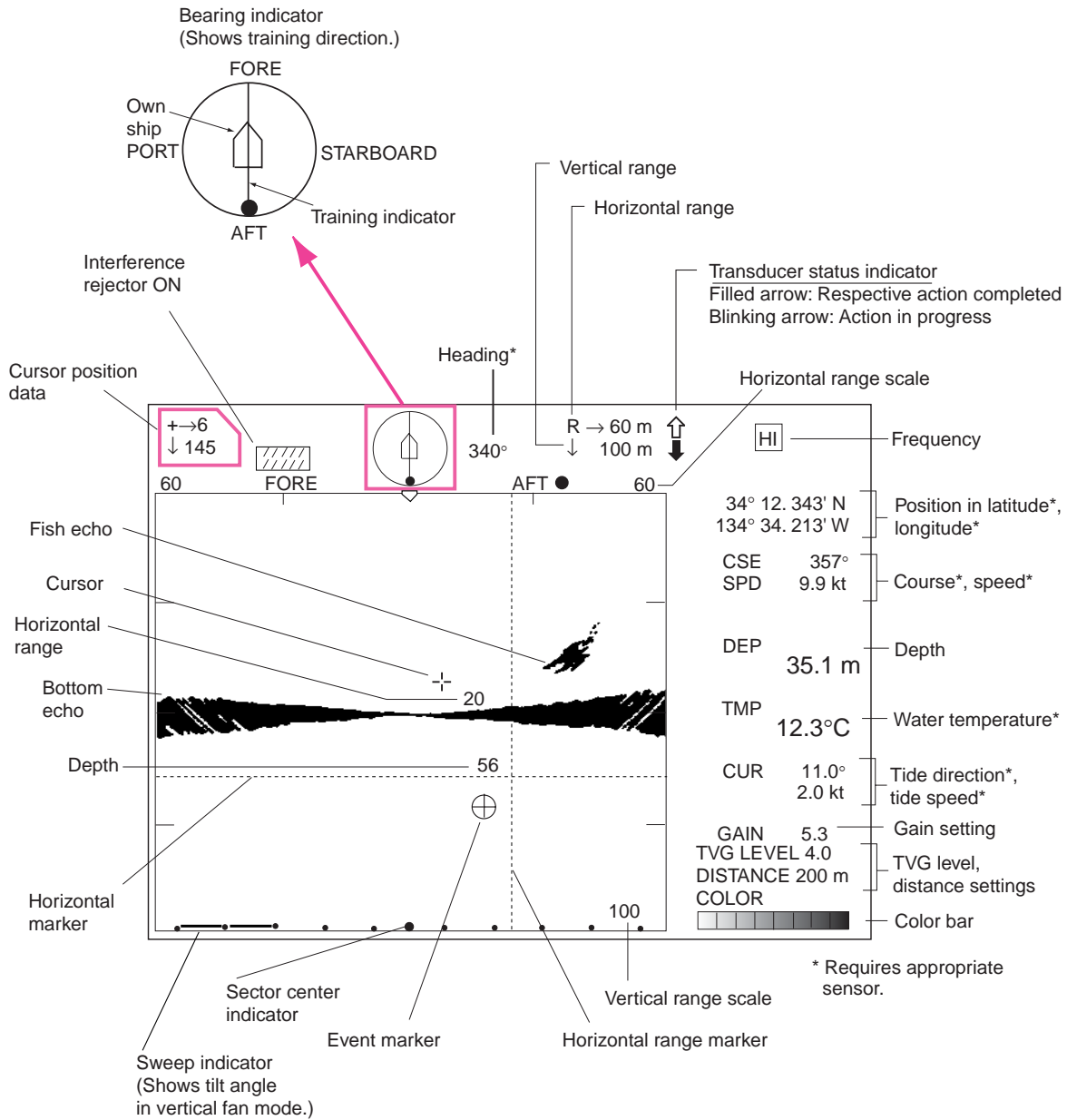

Single-frequency vertical scan display

### 3.3 Choosing a Range

The **RANGE** control chooses the detection (display) range, in 15 settings. Choose the range according to either the fish species being searched or the depth desired. Each time the control is operated the newly chosen range briefly appears in large characters at the screen top. Range is permanently displayed at the top right-hand corner of the screen. Normally the range is set so that the bottom is traced at the lower part of the screen (like an echo sounder).

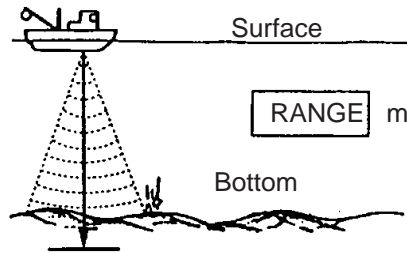

*Range concept*

#### Default vertical scan mode range settings

Unit	1	2	3	4	5	6	7	8	9	10	11	12	13	14	15
Meters	10	20	30	40	60	80	100	120	160	200	250	300	400	500	600
Feet	30	60	90	120	150	200	250	300	400	500	600	800	1000	1500	2000

**Note 1:** Unit of range measurement may be chosen from among meters, feet, fathoms, passi/braza or Hiro (Japanese) with UNIT on the SYSTEM SETTING 1 menu. For details see page 5-11.

**Note 2:** Ranges may be freely preset as desired. For details see page 5-15.

### 3.4 Choosing Train Center

The **TRAIN** control determines the bearing of the vertical scan beam, from 0° to 180°. Bearing of beam position can be found with the train indicator.

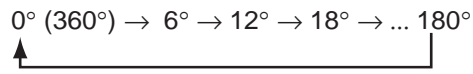

	Train Indicator	Train of Vertical Fan Beam

*Train indicator*

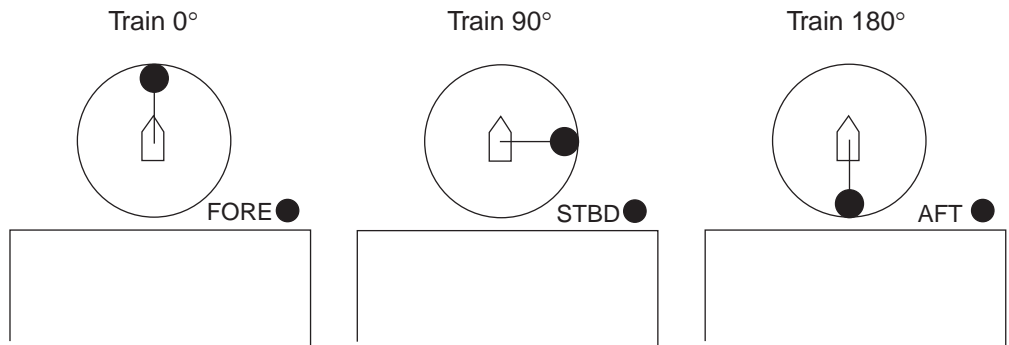

*Train indicator and display*

## 3.5 Choosing Display Sector

Sector means the width of the transducer training, from 6° to 180°.

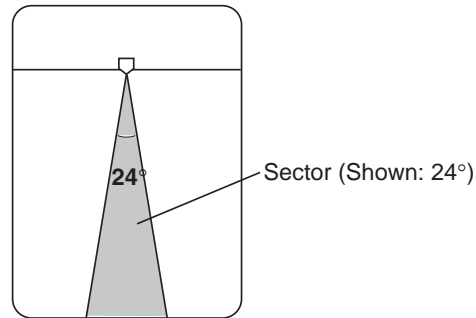

*Sector*

The **SECTOR** control chooses the training area among the sixteen positions shown in the table below. Clockwise rotation of the control increases the sector width; counterclockwise rotation decreases it.

	1	2	3	4	5	6	7	8	9	10	11	12	13	14	15	16
Sector width (°)	6	12	24	36	48	60	72	84	96	108	120	132	144	156	168	180

### One-touch selection of 180° sector

1. Press the **FULL/HALF** key. A half-circle display of 180° is presented.
2. Press the **FULL/HALF** key again, and a 120°-sector display is presented.

**Note:** Operating the **SECTOR** control between steps 1 and 2 in the procedure above displays the 180° sector at the next pressing of the **FULL/HALF** key.

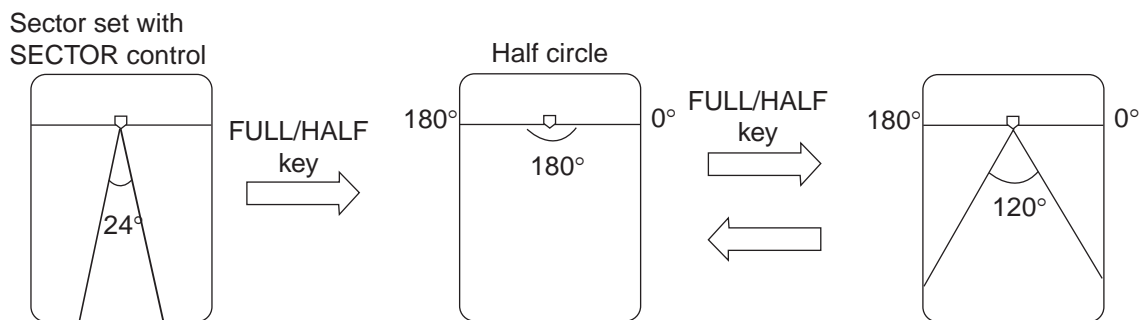

*How the FULL/HALF key works*

### 3.6 Choosing Sector Center

The center direction of the sounding beam in the vertical direction can be changed with the **TILT** control. The setting range is 0° to 180° in increments of 6°. Choose the setting which places the sector center in the middle of the detection range.

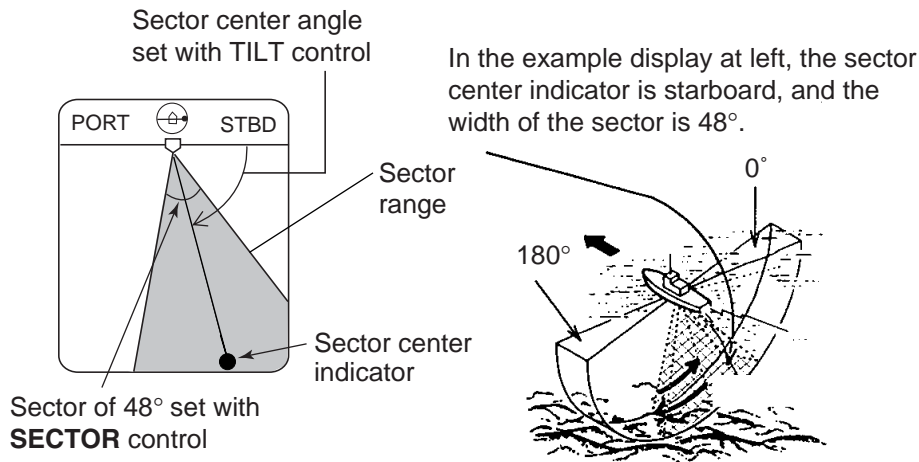

*Sector center*

#### Automatic shifting of own ship position

Own ship position on the screen is automatically shifted either rightward or leftward according to the direction of the sector center and display sector width.

The figure below shows the own ship position has been shifted rightward on the screen to provide the wider view at the port side.

- Sector center 0° to 60°: Own ship position shifted to port side
- Sector center 66° to 114°: Own ship position shifted to center
- Sector center 120° to 180°: Own ship position shifted starboard

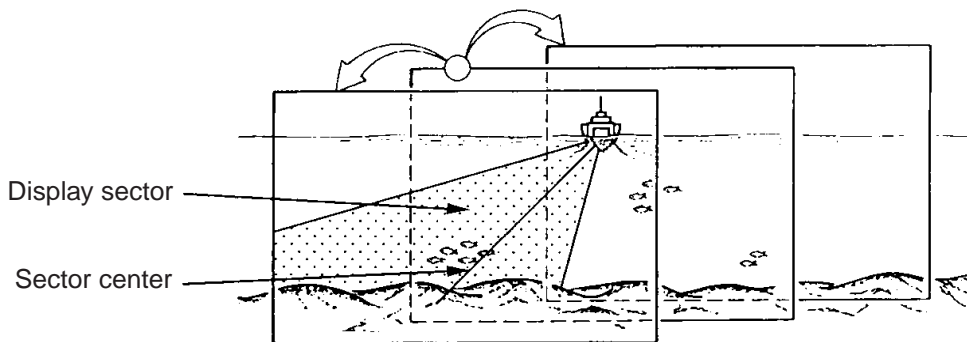

*How automatic shifting works*



### 3.7 Choosing Training Speed

The training speed chooses how fast the transducer scans the display sector. Two choices are available, 3° (normal speed, default setting) and 6° (high speed), and one may be selected with the **FAST SCAN** key. Each time the key is pressed the display momentarily shows "NORM" (normal speed) or "FAST" (high speed).

Normal: 60 transmissions for half circle in increments of 3°.

High: 30 transmissions for half circle in increments of 6°.

### 3.8 Finding Echo Position with the Cursor

The cursor measures horizontal range and depth. Operate the Omnipad to place the cursor where desired. Cursor data appears at the top left-hand corner on the screen.

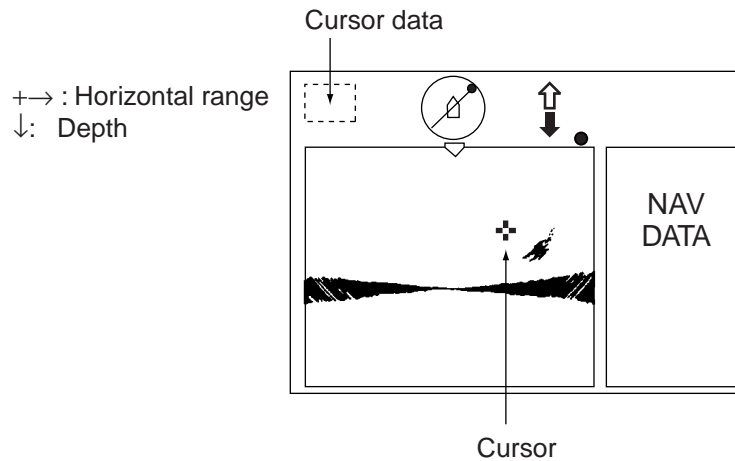

*Location of cursor position data*

### 3.9 Changing Training Direction

The training direction may be reversed to reconfirm fish echoes. Press the **REVERSE** key to reverse training direction between counterclockwise and clockwise alternately.

"REVERSE" appears at the top of the screen for three seconds when training direction is reversed.

### 3.10 Event Marker

The event marker functions to mark important locations on the vertical scan display, and five event markers may be inscribed. Each time the **EVENT** key is pressed the “latest event marker” (⊕) is inscribed at the cursor location and all previously entered event markers are shown by the “previous event marker” (+). When the capacity for event markers is reached the eldest event marker is erased from the screen to make room for the latest. Note that the marker cannot be inscribed from the vertical scan display in the horizontal/vertical scan display.

1. Operate the Omnipad to place the cursor on the location desired for an event marker.
2. Press the **EVENT** key to inscribe the event marker. The event marker is inscribed on the vertical scan display, as well as the horizontal and video plotter displays.

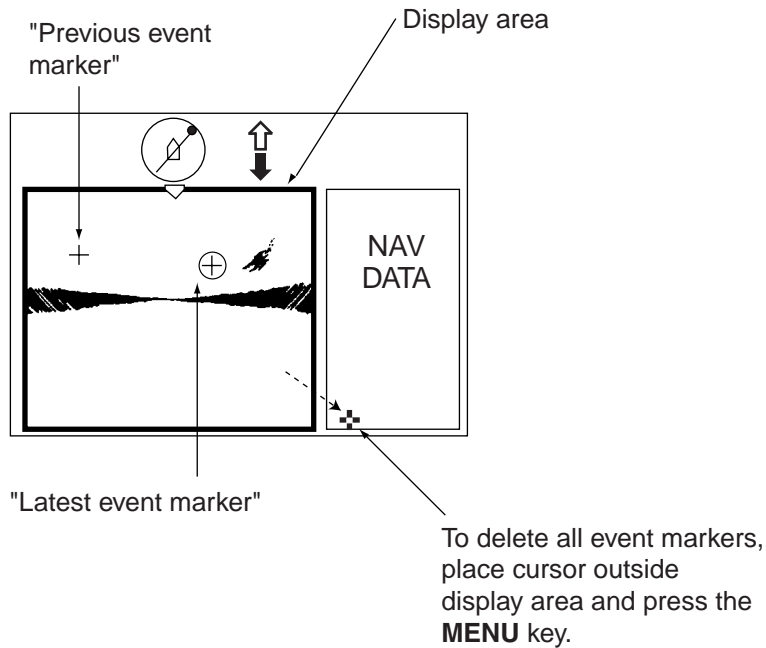

*How to inscribe, delete the event markers*

### 3.10.1 Deleting all event markers from the vertical scan display

All event markers inscribed on the vertical scan display may be deleted as follows:

1. Operate the Omnipad to place the cursor outside the display area.
2. Press the **EVENT** key to show the following dialog box. Do the next step within four seconds, otherwise the dialog box will be erased.

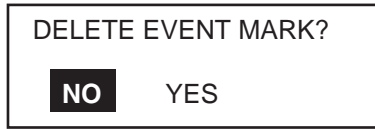

3. Press **▶** to choose YES and press the **MENU** key.

## 3.11 Depth and Horizontal Range Markers

The depth and horizontal range markers function to measure the horizontal range and depth to a desired echo.

**Note:** Depth and horizontal range markers cannot be inscribed from the vertical scan display when it is in the sub window (Horizontal/vertical scan display). Inscribe the markers from the horizontal display to show it in the vertical scan display.

1. Operate the Omnipad to place the cursor on the location desired.
2. Press the **R/B** key to display the depth and horizontal range markers. Horizontal range and depth appear on the screen.
3. To erase the depth and horizontal range markers, press the **R/B** key again, or place the cursor on the depth or horizontal range marker and press the **R/B** key.

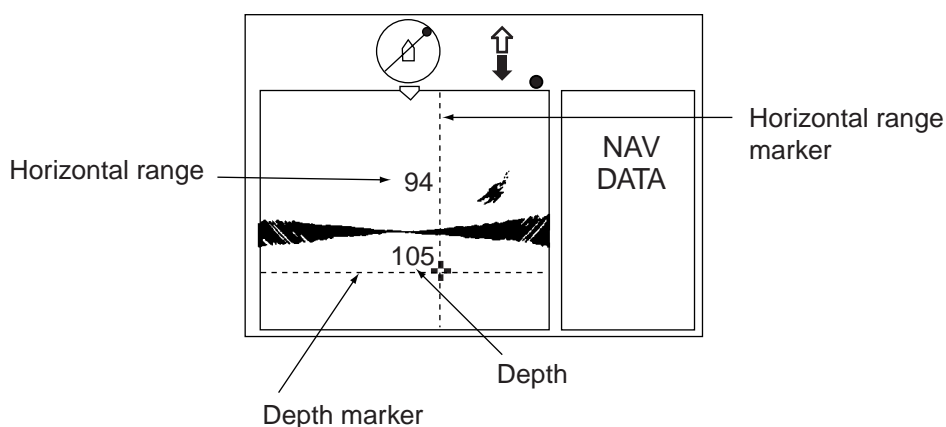

*Depth and horizontal range markers*

## 3.12 Adjusting the Picture

### 3.12.1 Displaying weak echoes clearly

Echoes from targets (such as the bottom or a fish) return to the transducer in order of the distance to them, and when their intensities are compared at the transducer face, those from nearer targets are generally stronger when their reflecting properties are nearly equal. The sonar operator will be quite inconvenienced if these echoes are directly displayed on the screen, since he won't be able to judge the actual size of the target from the size of echoes displayed on the screen. To overcome this inconvenience, use the TVG function. It compensates for propagation loss of sound in water: amplification of echoes on short range is suppressed and gradually increased as range increases, so that similar targets are displayed in similar intensities irrespective of the ranges to them. The TVG also functions to suppress unwanted echoes and noise which appears in a certain range area on the screen.

#### To adjust TVG:

1. Press the **MENU** key to open the menu.
2. Press **▲** to choose MENU and then press **◀** or **▶** to choose the VERT menu.

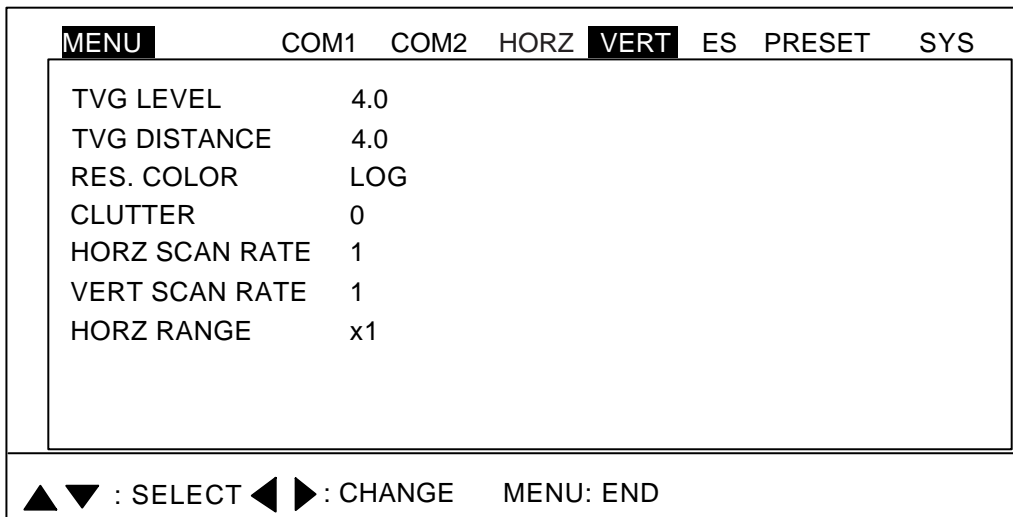

*VERT menu*

3. Press **▲** or **▼** to choose TVG DISTANCE and then press **▶** to show the following dialog box.

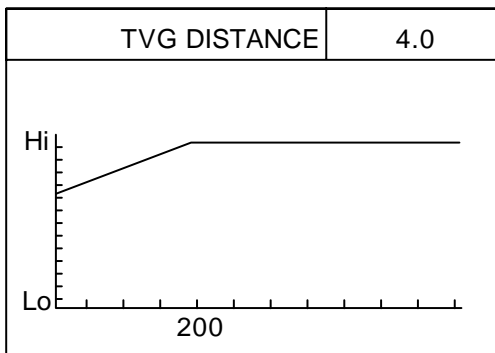

- Press ◀ or ▶ to adjust TVG distance, considering sea conditions. The larger the figure the greater the distance at which the TVG works.

TVG Distance Setting	0	0.5	1.0	1.5	2.0	2.5	3.0	3.5	4.0	4.5	5.0	....	10.0
Meters	3	8	20	40	60	100	130	160	200	250	320	....	1000
Feet	10	30	70	130	210	330	410	520	660	820	1040		3280
Passi/braza	2	5	10	20	40	60	80	100	120	150	180		600
Hiro	2	5	10	20	40	60	80	100	130	170	210	....	660

- Press or to close the dialog box and return to the VERT menu.
- To suppress reflections by the sea surface or plankton, choose TVG LEVEL and press ▶.
- Press ◀ or ▶ to adjust TVG LEVEL, considering sea conditions. The larger the figure the less the gain over distance.
- Press the **MENU** key to register your selection and close the menu.

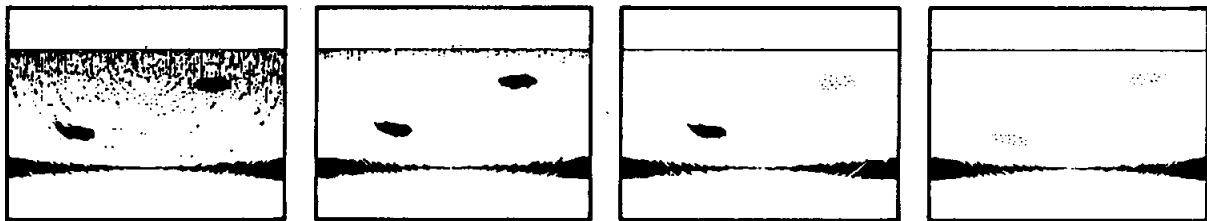

Wrong

Correct

Level too high

Distance too high

*Examples of proper and improper TVG*

### 3.12.2 Suppressing noise and interference

You may encounter occasional noise or intermittent interference as shown below. This is mostly caused by electrical equipment, engine, propeller noise from own ship, or noise from other sonars being operated nearby. If interference appears, turn on the interference rejector in the COM1 menu to suppress it. Note that the interference rejector cannot be turned on/off independently for each frequency in case of the dual-frequency display.

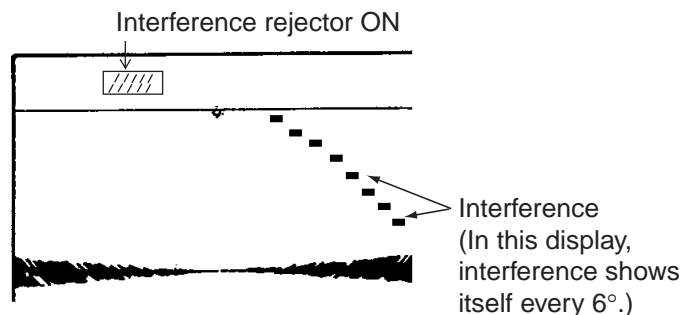

*Appearance of interference*

### 3.13 Vertical Menu Overview

This section presents an overview of the items on the VERT menu.

1. Press the **MENU** key to open the menu.
2. Press **▲** to choose MENU and then press **◀** or **▶** to choose the VERT menu.

<b>MENU</b>	COM1	COM2	HORZ	<b>VERT</b>	ES	PRESET	SYS
TVG LEVEL	4.0						
TVG DISTANCE	4.0						
RES. COLOR	LOG						
CLUTTER	0						
HORZ SCAN RATE	1						
VERT SCAN RATE	1						
HORZ RANGE	x1						

▲▼ : SELECT   ◀▶ : CHANGE   MENU: END

#### *VERT menu*

3. Press **▲** or **▼** to choose item desired.
4. Press **▶** to show corresponding dialog box.
5. Press **◀** or **▶** or to choose option desired.
6. Press the **MENU** key to register your selection and close the menu.

#### 3.13.1 Vertical menu description

**TVG LEVEL:** Compensates for propagation loss of sound in water. The default setting is 4.0.

**TVG DISTANCE:** As above. Default setting is 4.0.

**RES. COLOR:** Sets transfer characteristics of input signal level versus display echo level. Echo strength is emphasized in order of CUBE, SQUARE, LINEAR, LOG. You can see the characteristics of each by watching the color bar as you change the setting. Default setting is LOG.

LOG: Displays weak to strong echoes in their respective levels. This setting is suitable for general use.

LINEAR: Downplays the weak echoes when compared with LOG. Effective for suppressing weak echoes such as plankton.

SQUARE: Strong echoes are emphasized more than in LINEAR.

CUBE: Strong echoes are emphasized even more than in SQUARE.

**CLUTTER:** Low intensity echoes, often caused by sediments in water, are painted on the screen as a large number of random dots. The higher the number (setting) the weaker the echoes which are erased.

**HORZ SCAN RATE:** Sets the scan rate (1, 2, 3, 4) for the horizontal display in the horizontal/vertical scan combination display. For example, if the scan for the horizontal display is "4" and the scan rate for the vertical scan display is "2", then for every four scans at the horizontal display two scans are produced at the vertical scan display. Raise the figure to give importance to the horizontal display.

**VERT SCAN RATE:** Sets the scan rate (1, 2, 3, 4) for the vertical scan display in the horizontal/vertical scan combination display. Raise the figure to give importance to the vertical display.

**HORZ RANGE:** You may choose the horizontal range expansion factor for the horizontal expansion display from x1 or x2. Note that this feature cannot be adjusted when the vertical search mode or target lock is active.

## 3.14 Interpreting the Vertical Scan Display

This section provides information necessary for interpreting the vertical scan display.

### 3.14.1 How the vertical scan mode picture is painted

The sounding beam is emitted and the information (target echoes) obtained by the beam appears in the corresponding sector as it appears on the sonar mode. The difference is that the training is performed only in vertical direction. It forms a sounding area of a half-circle (like a slice of watermelon) to observe a vertical section of underwater conditions. The bearing of the vertical sounding beam can be chosen manually or automatically.

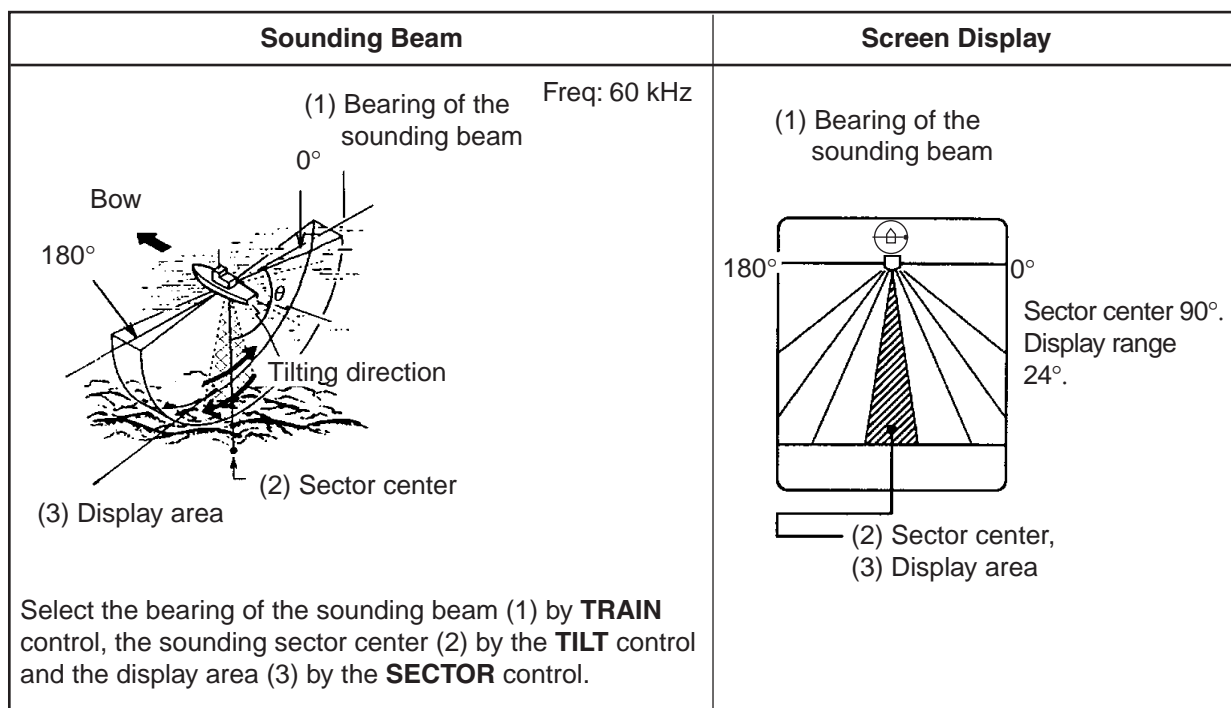

*How the vertical scan mode picture is painted*

### 3.14.2 Sample displays

#### Port-starboard picture (bottom)

You can see fish echoes at the center-right of the screen. The bottom is displayed wider as the distance from the ship's position increases. Therefore, it may be difficult to discriminate bottom fish.

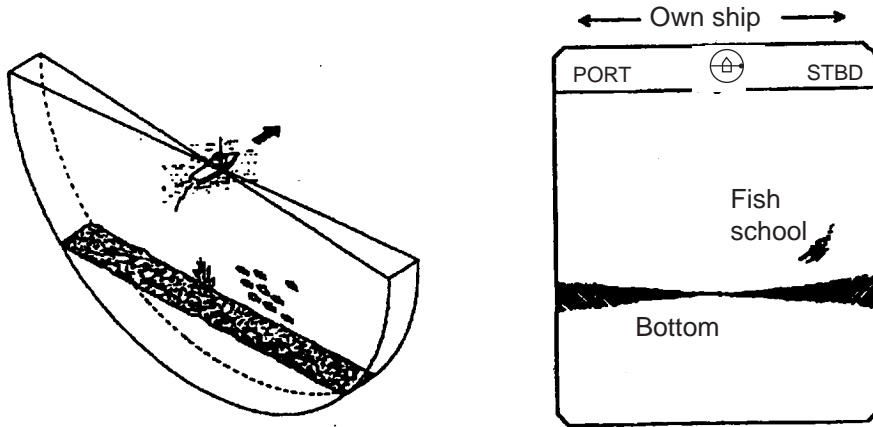

*Port-starboard picture*

#### When ship passes over fish schools

The sounding beam is directed fore-aft and the display is off-centered\* to present a wider view of the area forward of the ship. You can clearly see fish schools approaching from the bow of the ship.

\*: Automatically shifted.

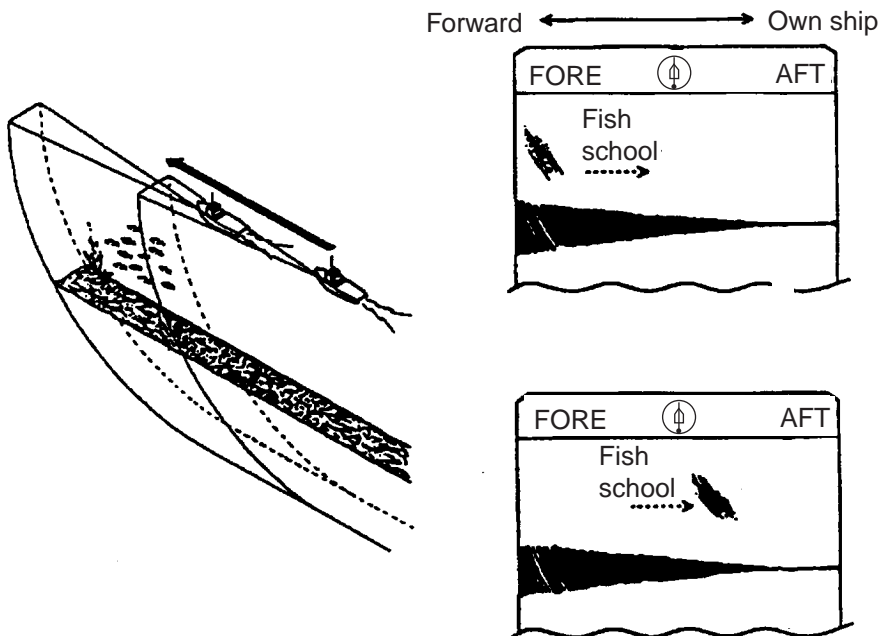

*Picture appearance when passing over fish schools*



### Display of net hauling

This is an example of net hauling display. The location of the net is indicated clearly.

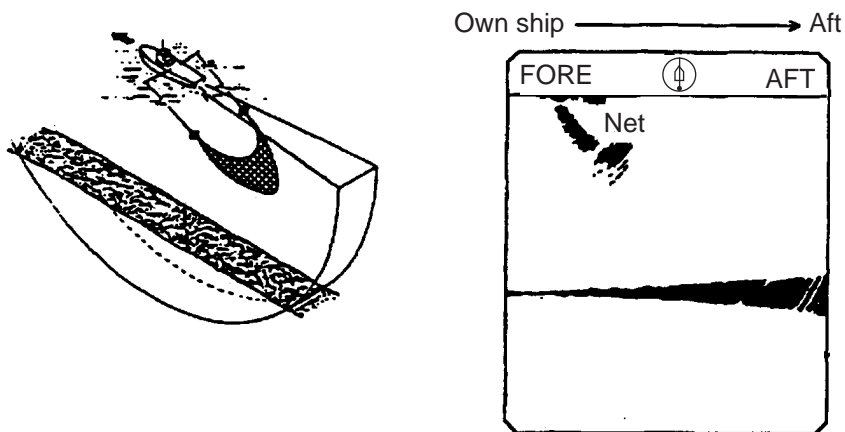

*Net hauling and sonar picture*

### False echo

In shallow water (depth less than 100 m) detection, unwanted echoes shown in the figure may appear. This phenomenon is caused by the false echo from the previous transmission. Reducing the Tx rate (on the COM1 menu) or lowering the range may lessen this effect.

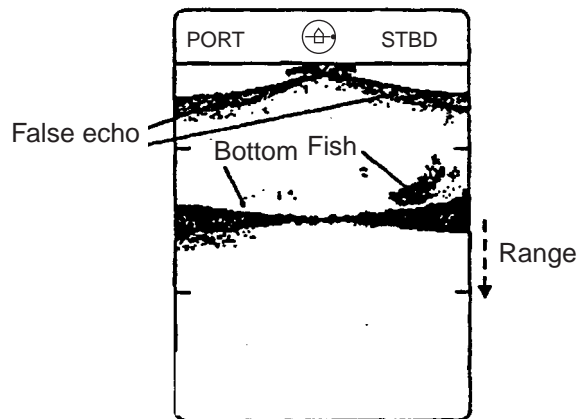

*False echoes*

3. VERTICAL SCAN MODE

**3.14.3 Horizontal/vertical scan port-starboard, Horizontal/vertical scan upward-downward display**

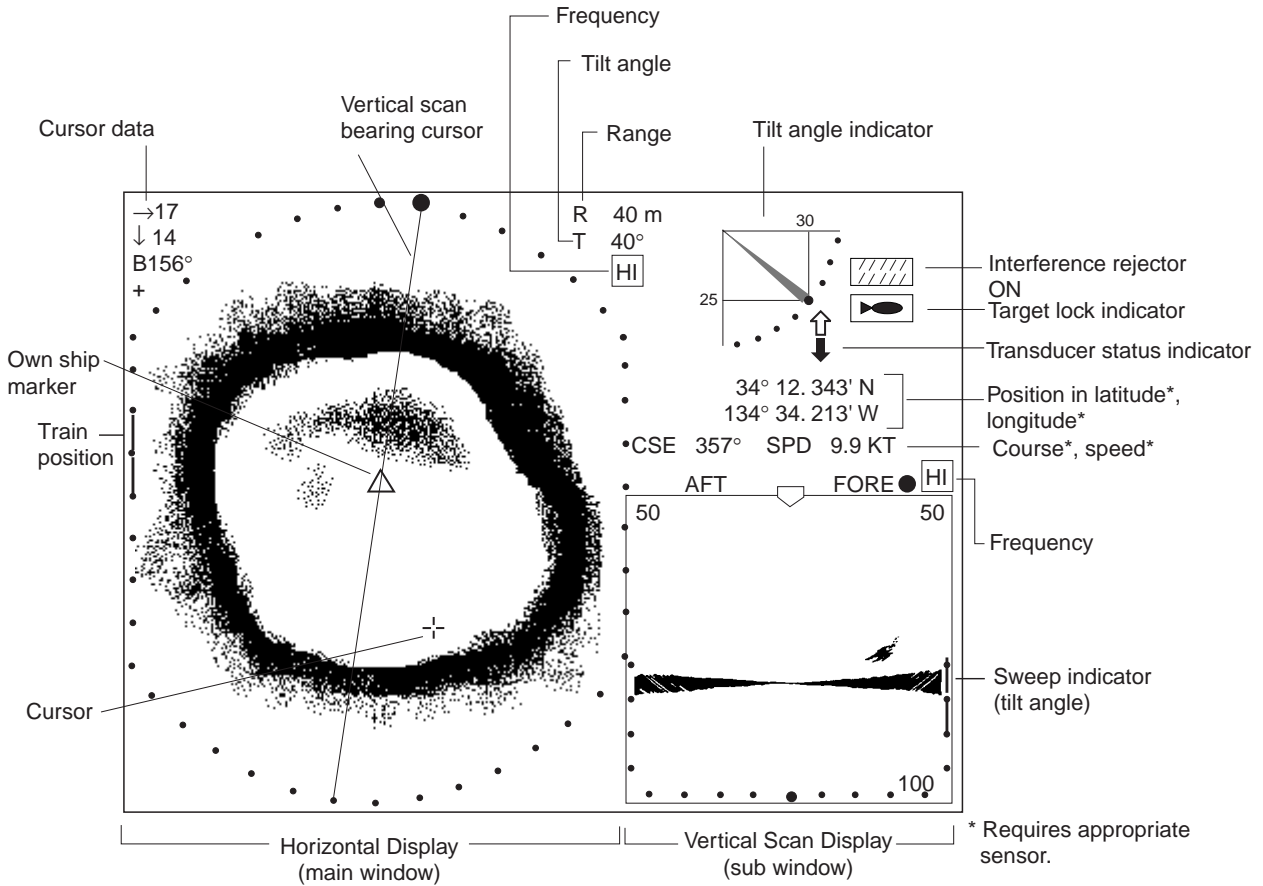

*Horizontal/vertical scan display (port-starboard direction)*

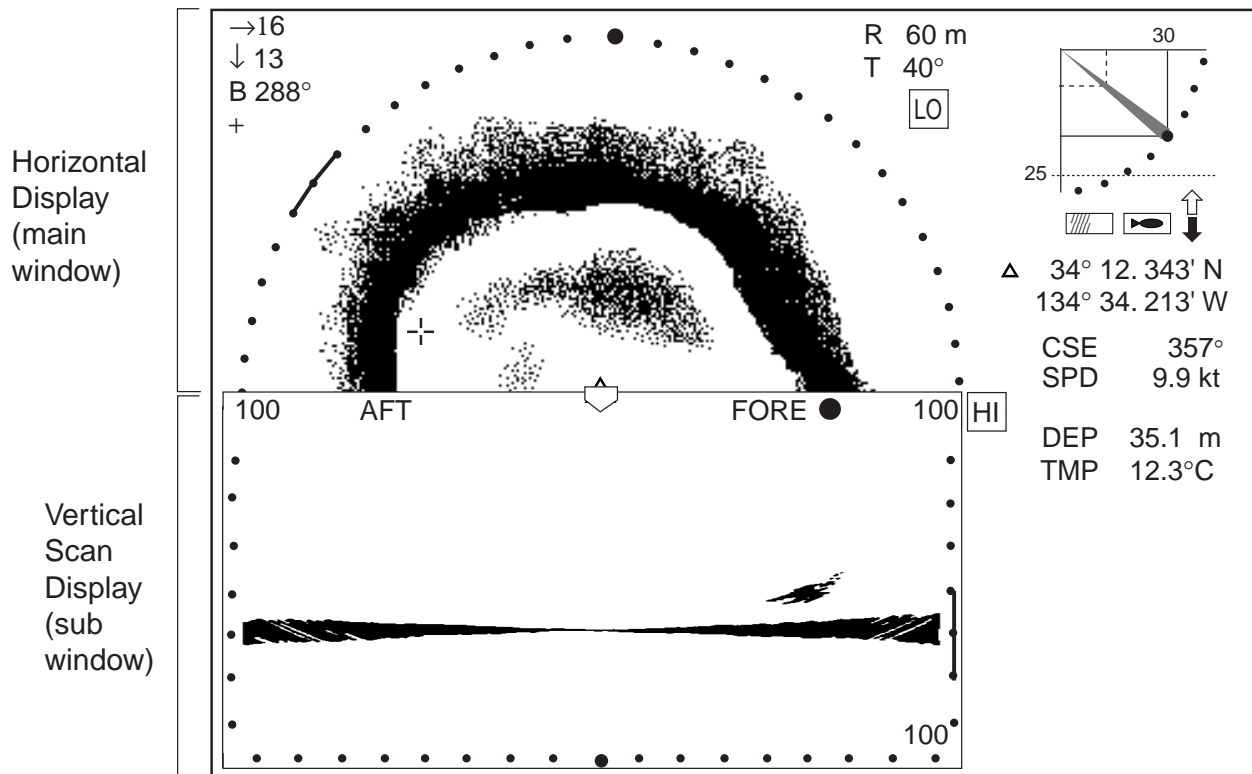

*Horizontal/vertical scan display (upward-downward direction)*

Press the  key to choose and display the horizontal/vertical scan display. The horizontal display appears in the main window; the vertical scan display in the sub window.

The displays are independent of each other so you can adjust them as desired. Press the **MAIN/SUB** key to choose the window to adjust. Each pressing of the key momentarily displays MAIN WINDOW CONTROLLABLE or SUB WINDOW CONTROLLABLE at the top of the screen. A red cursor appears in the sub window when it can be controlled. The following controls are operative on either window: **SECTOR, TRAIN, RANGE, TILT, FAST LF/HF, MIX, SCAN, FULL/HALF** and **CUSTOM MODE**.

**Note:** **R/B, EVENT** or **TARGET** controls may only be operated from the main window. When you attempt to operate them from the sub window the message SELECT MAIN WINDOW appears.

### **TRAIN control**

For horizontal display: Sets training center direction.

For vertical scan display: Sets direction of bearing cursor shown on the horizontal mode display.

### 3. VERTICAL SCAN MODE

#### **SECTOR control**

For the vertical scan display: When the display sector is  $6^\circ$  (minimum) the tilt angle of the horizontal and vertical scan modes are interlocked and each transmission on the horizontal display is reflected on the vertical scan display. The message TILT ANGLE MONITOR WINDOW momentarily appears on the screen and the vertical bearing cursor disappears.

**Note:** Only the **SECTOR** control may be operated in this condition.

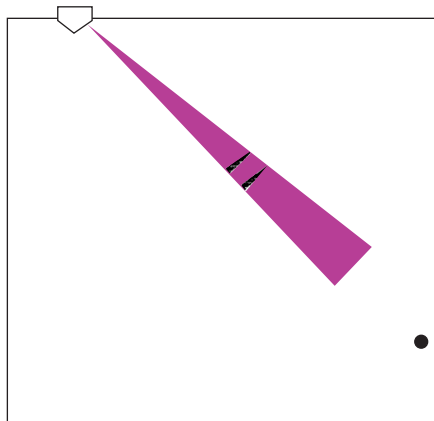

# 4. ECHO SOUNDER MODE

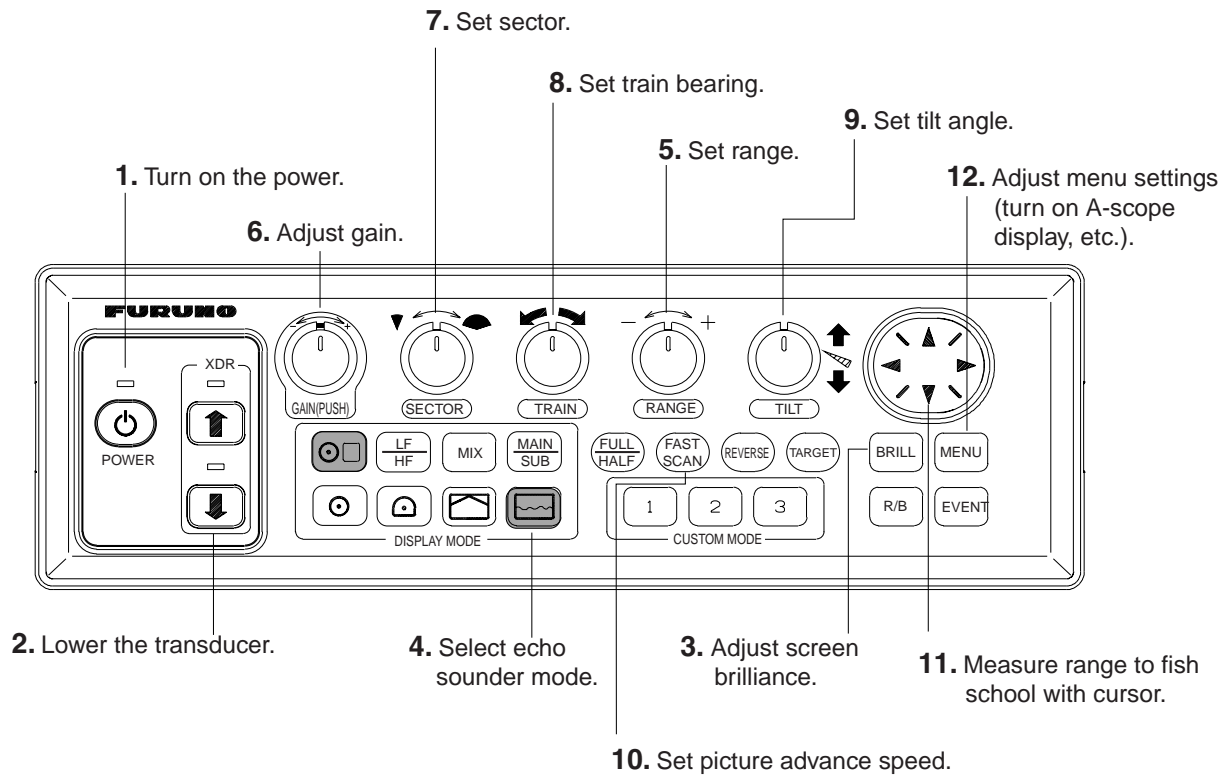

## 4.1 Operational Overview

The figure below shows the typical echo sounder mode operating sequence.



*Control panel*

## 4.2 Typical Echo Sounder Display

Press the  key to display the echo sounder picture. You can switch between the single-frequency echo sounder display and the dual-frequency echo sounder display alternately with the  key as shown below.

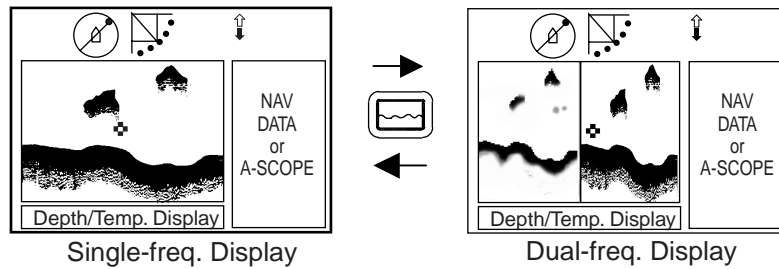

*Switching between single-frequency echo sounder and dual-frequency echo sounder displays*

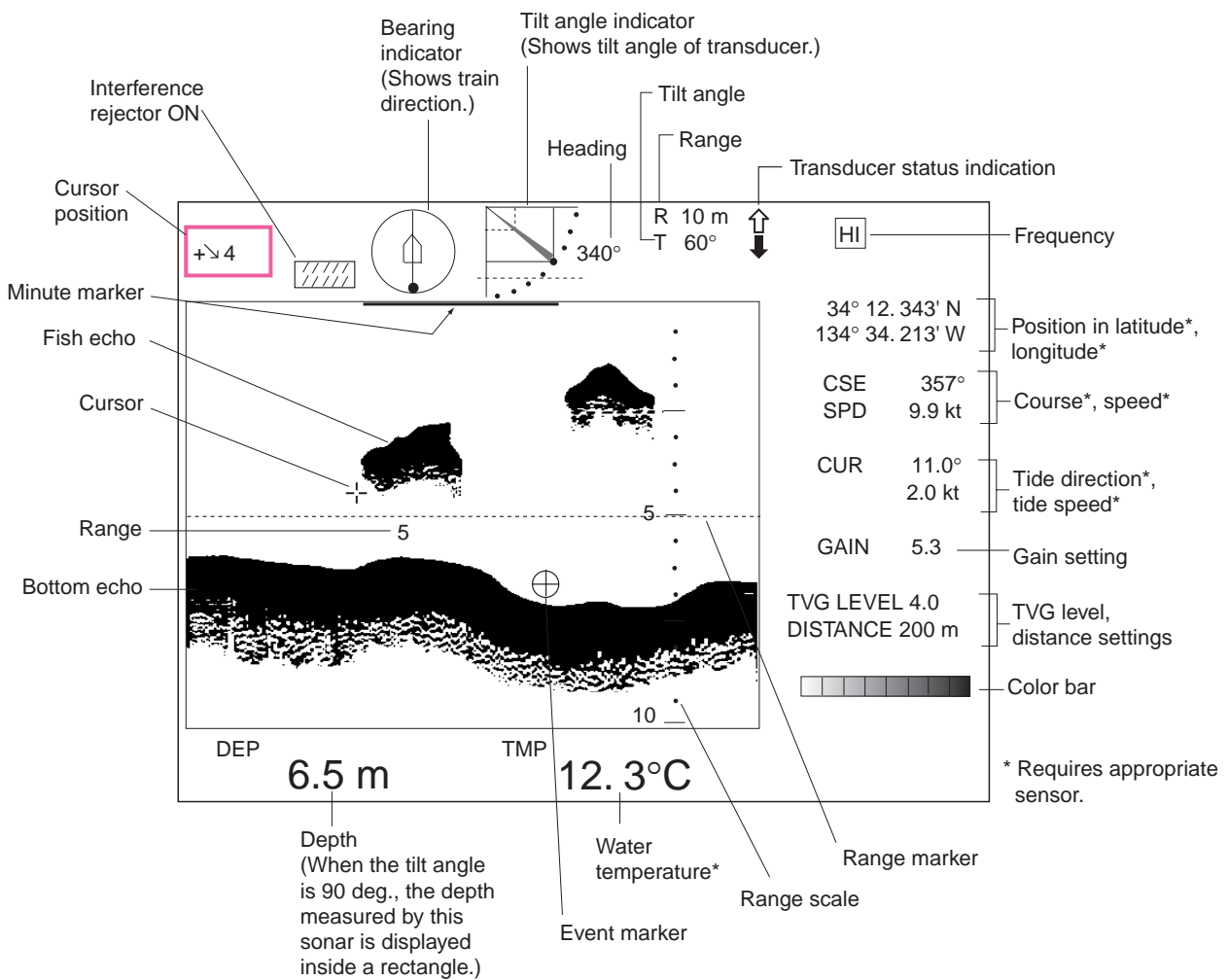

*Single-frequency echo sounder display*

### 4.3 Choosing a Range

The **RANGE** control chooses the detection (display) range, in 15 settings. Choose the range according to either the fish species being searched or the depth desired. Each time the control is operated the newly chosen range briefly appears in large characters at the screen top. Range is permanently displayed at the top right-hand corner.

Normally the range is set so that the bottom is traced at the lower part of the screen.

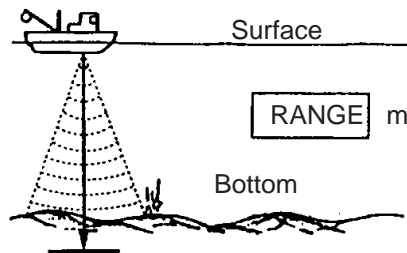

*Range concept*

#### Default echo sounder mode range settings

Unit	1	2	3	4	5	6	7	8	9	10	11	12	13	14	15
Meters	10	20	30	40	60	80	100	120	160	200	250	300	400	500	600
Feet	30	60	90	120	150	200	250	300	400	500	600	800	1000	1500	2000

**Note 1:** Unit of range measurement may be selected for meters, feet, fathoms, passi/braza or Hiro (Japanese). For details see UNIT on page 5-11.

**Note 2:** Ranges may be freely preset as desired. For details see page 5-16.

## 4.4 Train Direction

The sounding beam may be directed toward fore, aft, port or starboard. Operate the **TRAIN** control to choose sounding beam direction. Each setting on the control is an increment of 6°. The train indicator at the top of the screen shows training direction: 0°, fore direction; 90°, starboard direction; 180°, aft direction, and 270°, port direction.

0° (360°) → 6° → 12° → 18° → ... 354°

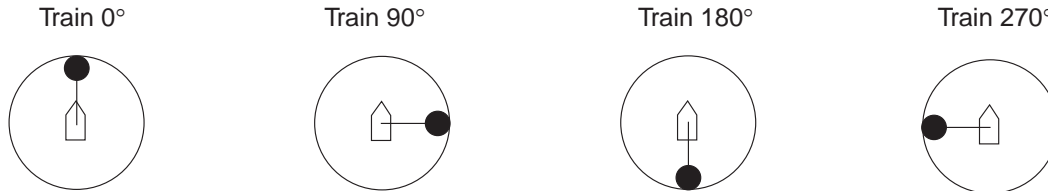

*Train indicator and display*

## 4.5 Choosing a Tilt Angle

The transducer can be pointed directly toward the bottom or forward of the ship. Operate the **TILT** control to choose an appropriate tilt angle. The available tilt angle is 0° (horizontal direction) to 90° (vertical) in increments of 1°. Chosen tilt angle appears at the top of the display to the right of “T”.

## 4.6 Choosing a Picture Advance Speed

The picture advance speed determines how quickly the vertical scan lines run across the screen, from right to left. When choosing a picture speed, keep in mind that a fast advance speed will expand a fish school horizontally on the screen and a slow one will contract it.

1. Press the **FAST SCAN** key to show the following dialog box.

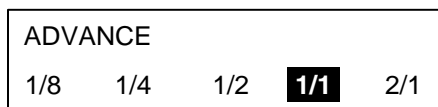

2. Press ◀ or ▶ (**FAST SCAN** key may also be used) to select a speed. The fractions in dialog box correspond to the number of scan lines produced per transmission. For example, “2/1” means two scan lines are produced per transmission.
3. Press the **MENU** key to close the dialog box. Note that the dialog box is automatically closed if there is no control operation for about four seconds.



## 4.7 Measuring Range by Cursor

Use the cursor to display the range from own ship to the cursor location. Use the Omnipad to place the cursor where desired. The range to the cursor appears at the upper left-hand corner of the screen.

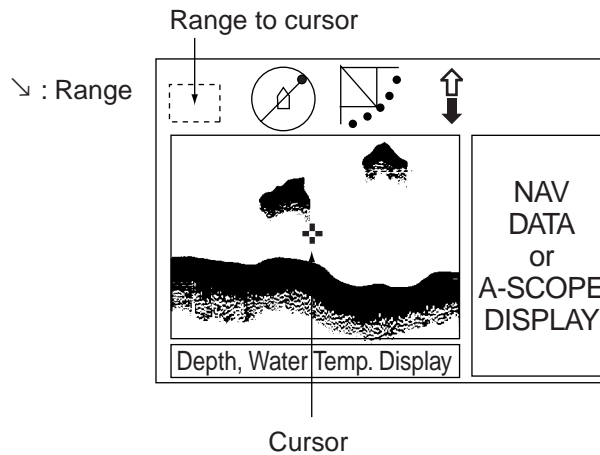

*How to measure range with the cursor*

## 4.8 Event Marker

The event marker functions to mark important locations on the echo sounder display, and five event markers may be inscribed. Each time the **EVENT** key is pressed the “latest event marker” (⊕) is inscribed at the cursor location and all previously entered event markers are shown by the “previous event marker” (+). When the capacity for event markers is reached the eldest event marker is erased from the screen to make room for the latest.

**Note 1:** The event marker inscribed on the echo sounder display will also be inscribed on the horizontal and video plotter displays, at own ship position always.

**Note 2:** Event marker position can be output to external equipment. For details see TARGET L/L on page 5-10.

**Note 3:** Event markers are automatically erased as they move off the screen with picture advancement.

## 4. ECHO SOUNDER MODE

### 4.8.1 Inscribing the event marker

1. Operate the Omnipad to place the cursor on the location desired for an event marker.
2. Press the **EVENT** key to inscribe the event marker.

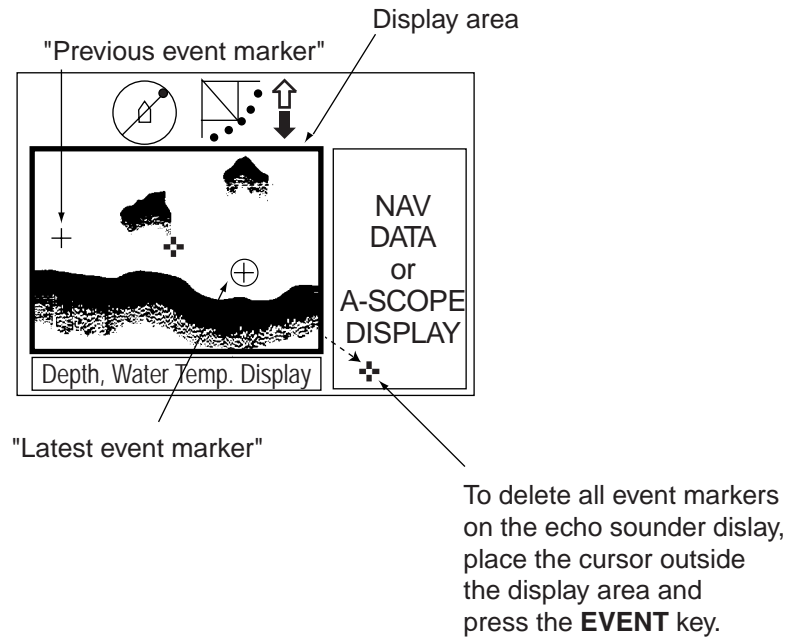

*How to inscribe, delete the event markers*

### 4.8.2 Deleting all event markers from echo sounder display

Event markers inscribed on the echo sounder display may be erased collectively as follows:

1. Operate the Omnipad to place the cursor outside the display area.
2. Press the **EVENT** key to show the following dialog box. Do the next step within four seconds, otherwise the dialog box will be erased.

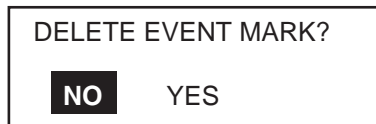

3. Press **▶** to choose YES and press the **MENU** key.

## 4.9 Range Marker

The range marker functions to measure the range to a target echo (fish school, bottom, etc.)

1. Operate the Omnipad to place the cursor on the location desired.
2. Press the **R/B** key to display the range marker. The range marker appears along with range indication.
3. To erase the range marker, press the **R/B** key again, or place the cursor on the range marker and press the **R/B** key.

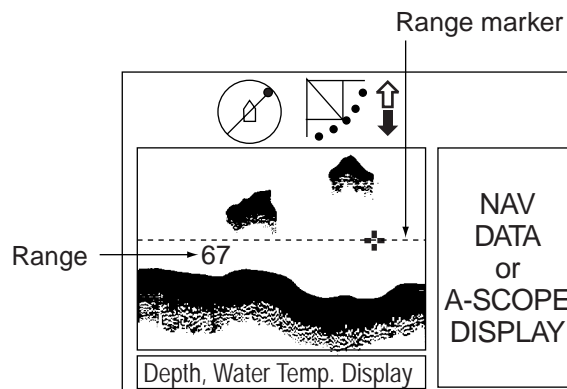

*Range marker*

## 4.10 Adjusting the Picture

### 4.10.1 Displaying weak echoes clearly

Echoes from targets (such as the bottom or a fish) return to the transducer in order of the distance to them, and when their intensities are compared at the transducer face, those from nearer targets are generally stronger when their reflecting properties are nearly equal. The sonar operator will be quite inconvenienced if these echoes are directly displayed on the screen, since he won't be able to judge the actual size of the target from the size of echoes displayed on the screen. To overcome this inconvenience, use the TVG function. It compensates for propagation loss of sound in water: amplification of echoes on short range is suppressed and gradually increased as range increases, so that similar targets are displayed in similar intensities irrespective of the ranges to them.

The TVG also functions to suppress unwanted echoes and noise which appears in a certain range area on the screen.

#### To adjust TVG:

1. Press the **MENU** key to open the menu.
2. Press **▲** to choose MENU and then press **◀** or **▶** to choose the ES menu.

#### 4. ECHO SOUNDER MODE

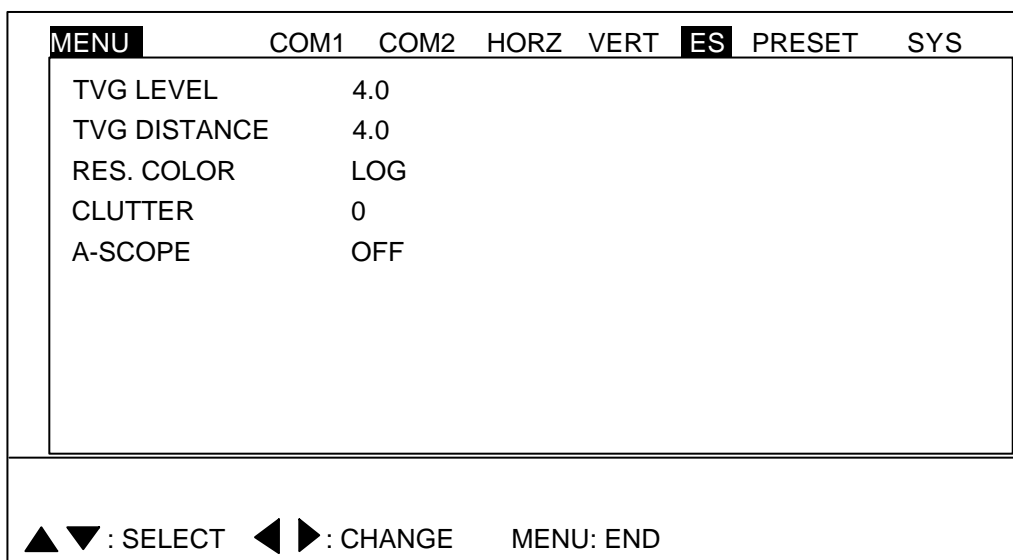

*ES menu*

3. Press ▲ or ▼ to choose TVG DISTANCE and press ▶. The following dialog box appears.

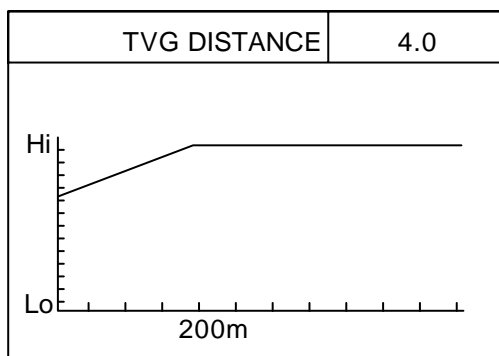

4. Press ◀ or ▶ to adjust TVG distance.

TVG Distance Setting	0	0.5	1.0	1.5	2.0	2.5	3.0	3.5	4.0	4.5	5.0	....	10.0
Meters	3	8	20	40	60	100	130	160	200	250	320	....	1000
Feet	10	30	70	130	210	330	410	520	660	820	1040		3280
Passi/braza	2	5	10	20	40	60	80	100	120	150	180		600
Hiro	2	5	10	20	40	60	80	100	130	170	210	....	660

5. Press ▲ or ▼ to close the dialog box and return the ES menu.  
 6. To suppress reflections by the sea surface or plankton, choose TVG LEVEL and press ▶.  
 7. Press ◀ or ▶ to adjust TVG LEVEL.  
 8. Press the **MENU** key to register your selection and close the menu.

### 4.10.2 Finding echo strength (A-scope display)

The A-scope display shows echoes at each transmission with amplitudes and tone proportional to their intensities on the right 1/4 of the screen. It is useful for estimating the kind of fish school and bottom composition.

1. Press the **MENU** key.
2. Press **▲** to choose MENU.
3. Press **◀** or **▶** or to choose ES.
4. Press **▼** to choose A-SCOPE.
5. Press **◀** or **▶** to open the dialog box.

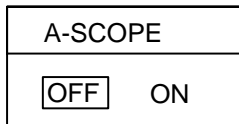

6. Press **▶** to choose ON.
7. Press the **MENU** key to close the dialog box.

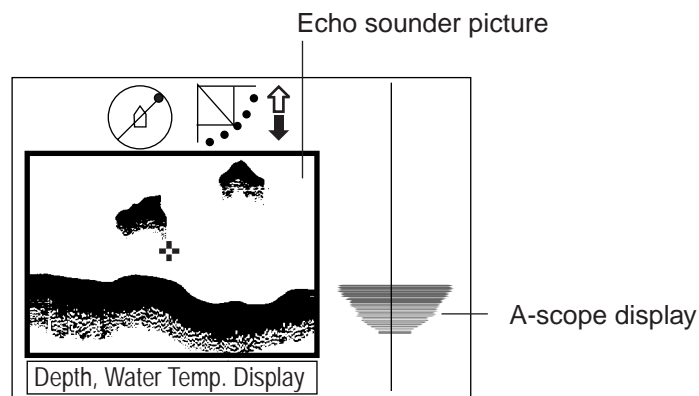

*A-scope display*

### 4.10.3 Suppressing interference and noise

You may encounter occasional noise or intermittent interference on the display. This is mostly caused by electrical equipment, engine, propeller noise from own ship, or noise from other sonars being operated nearby. If interference appears, turn on the interference rejector in the COM1 menu to suppress it. Note that the interference rejector cannot be turned on/off independently for each frequency in case of the dual-frequency display.

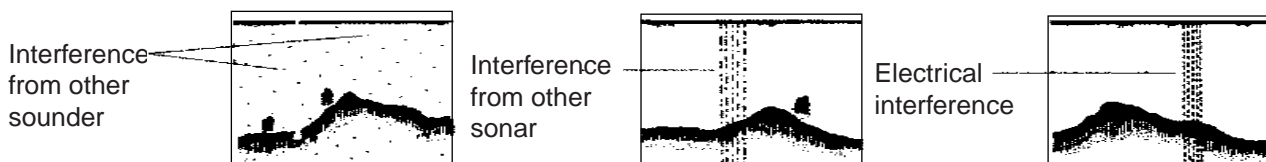

*Interference*

## 4.11 Echo Sounder Menu Overview

This section presents an overview of the items on the ES menu.

1. Press the **MENU** key to open the menu.
2. Press **▲** to choose MENU and then press **◀** or **▶** or to choose the ES menu.

MENU	COM1	COM2	HORZ	VERT	ES	PRESET	SYS
TVG LEVEL		4.0					
TVG DISTANCE		4.0					
RES. COLOR		LOG					
CLUTTER		0					
A-SCOPE		OFF					

▲▼ : SELECT   ◀▶ : CHANGE   MENU: END

*ES menu*

3. Press **▲** or **▼** to choose item desired.
4. Press **▶** to show corresponding dialog box.
5. Press **◀** or **▶** to choose option desired.
6. Press the **MENU** key to register your selection and close the menu.

### 4.11.1 Echo sounder menu description

**TVG LEVEL:** Compensates for propagation loss of sound in water. See paragraph 4.10.1. Default setting is 4.0.

**TVG DISTANCE:** As above. Default setting is 4.0.

**RES. COLOR:** Sets transfer characteristics of input signal level versus display echo level. Echo strength is emphasized in order of CUBE, SQUARE, LINEAR, LOG. You can see the characteristics of each by watching the color bar as you change the setting. The default setting is LOG.

**LOG:** Displays weak to strong echoes in their respective levels. This setting is suitable for general use.

**LINEAR:** Downplays the weak echoes when compared with LOG. Effective for suppressing weak echoes such as plankton.

**SQUARE:** Strong echoes are emphasized more than in LINEAR.

**CUBE:** Strong echoes are emphasized even more than in SQUARE.

**CLUTTER:** Low intensity echoes, often caused by sediments in water, are painted on the screen as a large number of random dots. The higher the number (setting) the weaker the echoes which are erased.

**A- SCOPE:** Turns the A-scope display on/off. Default setting is OFF. See paragraph 4.10.2.

# 5. MENU OPERATION

---

This chapter provides menu operating information on menus not previously discussed: COM1, COM2, PRESET (or SHORT-CUT, depending on the setting of CUSTOM KEY on the SYSTEM SETTING 1 menu) and SYS (System) menu.

## 5.1 COM1 Menu

1. Press the **MENU** key to open the menu.
2. Press **▲** to choose MENU, and then press **◀** to choose COM1.

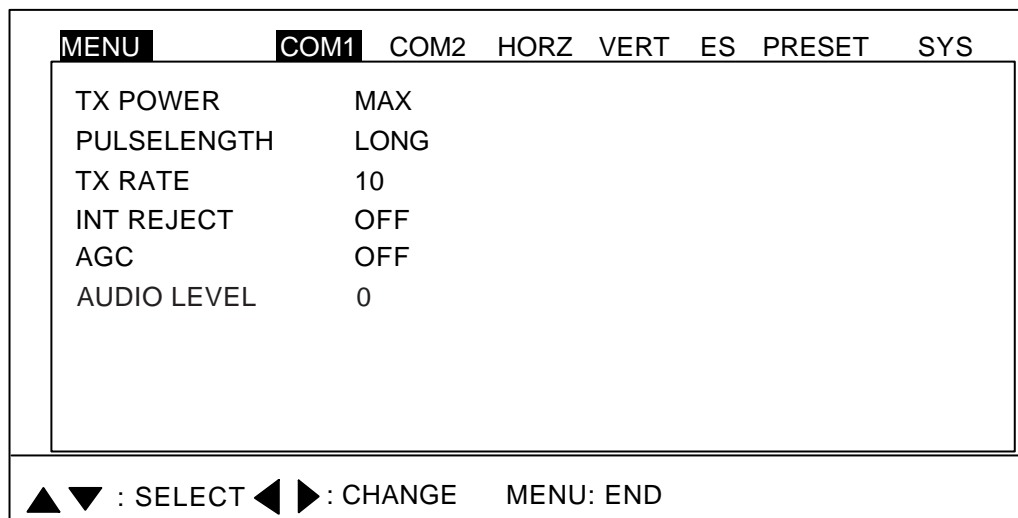

*COM1 menu*

3. Press **▲** or **▼** to choose item; **◀** or **▶** to open associated dialog box.
4. Press **◀** or **▶** to choose option desired.
5. Press **▲** or **▼** to return to the COM1 menu, or press the **MENU** key to register your selection and close the menu.

## 5. MENU OPERATION

### 5.1.1 COM1 menu description

**TX POWER:** Chooses transmitter output power to maximum or minimum. The default setting is "maximum." For further details see paragraph 2.12.1.

**PULSELENGTH:** Chooses pulselength to short or long (default setting). For details see paragraph 2.12.2.

**TX RATE:** The Tx rate may be set between 1-10 (default setting: 10) in the case of the internal transmitter, or an external synchronous signal may be used. The higher the number the greater the number of transmissions. For operation in shallow waters, choose the Tx rate which displays the second reflection from the bottom between the sea surface and bottom. For use of an external video sounder or sonar, choose EXT.

**INT REJECT:** Turns the interference rejector on (high freq, low freq or both low and high freq) or off (default setting). When turned on  appears at the top of the screen. Note that the interference rejector cannot be turned on/off independently for each frequency in case of the dual-frequency display. For further details about interference rejection, see paragraph 2.12.5 (horizontal display) and 3.12.2 (vertical scan display).

**AGC:** Automatically lowers sensitivity against strong echoes such as those from the bottom and large fish schools to emphasize weak echoes such as those from fish close to the bottom. The default setting is OFF.

**AUDIO LEVEL:** Adjusts the audio level (0-10) of the external loudspeaker (option). Sometimes you may be preoccupied with other tasks and unable to concentrate on watching the sonar picture. In such cases it would be a good choice to use the audio function. This function enables you to monitor echoes from fish schools and seabed through the built-in speaker. After you've become accustomed to monitoring fish aurally, you should be able to detect a fish school from a range longer than you can detect it on the screen. In addition you may judge whether the fish school is approaching or going away; the tone becomes higher when the school is approaching and lowers when the school is going away.

**Note:** If a dual-frequency display is active, the frequency sound from the left-side display\* (for the dual-frequency vertical scan display the top display) is output.

\*: Dual-frequency horizontal display, dual-frequency horizontal expansion, dual frequency echo sounder



## 5.2 COM2 Menu

### 5.2.1 Displaying the COM2 menu

1. Press the **MENU** key to open the menu.
2. Press **▲** to choose MENU, and then press **◀** or **▶** to choose COM2.

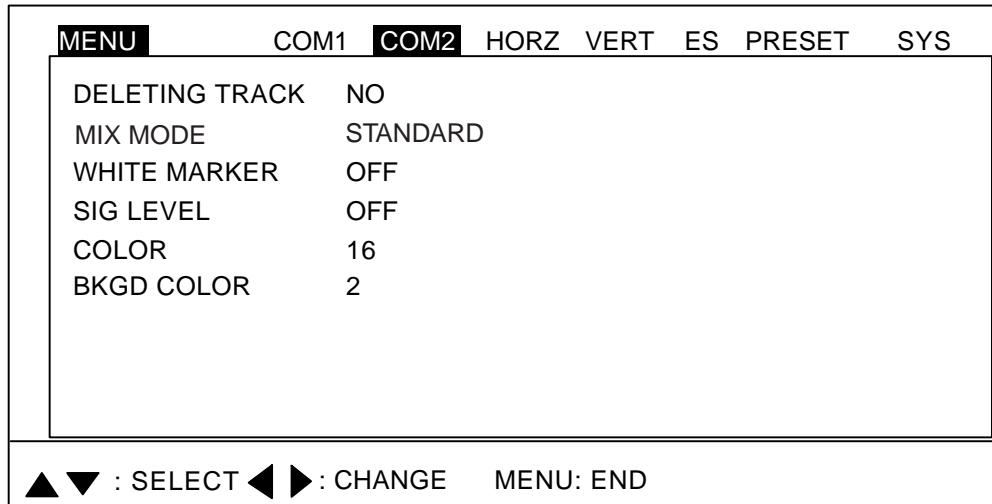

*COM2 menu*

### 5.2.2 COM2 menu description

**DELETING TRACK:** Choose ON to delete all ship's track (from horizontal and horizontal/video plotter displays).

**MIX MODE:** Choose how to process the mix display. "STANDARD" displays high frequency level when high frequency signal is larger than low frequency signal, which is useful for finding absolute echo level. "EMPHASIS" displays difference in level when high frequency signal is larger than low frequency signal, which is useful for finding difference in echo level between low and high frequencies. Default setting is STANDARD.

**WHITE MARKER:** Displays desired echo in white. It is useful for discriminating bottom fish from the bottom echo. The setting range for the 8-color display is OFF, 1-7, and for the 16-color display, OFF, 1-15.

**SIG LEVEL:** Refer to page 2-16.

**COLOR:** Chooses 8- or 16-color display.

**BKGD COLOR:** Chooses color of background, text and menu. Three choices are available and these are shown in the table below.

BKGD COLOR	Background	Text	Menu
1	Black	Gray	Dark-blue
2	Dark-blue	White	Medium blue
3	White	Black	Gray

### 5.3 Short-cut Menu, Preset Menu

These menu program the CUSTOM MODE keys [1], [2] and [3], and one of the menus appears according to the setting of CUSTOM KEY on the SYSTEM SETTING 1 menu.

**Short-cut key:** One-touch activation of corresponding dialog box. This is the default setting.

**Preset key:** One-touch setup of mode, sector, train, range, tilt and speed controls. Below are the default settings for PRESET.

CUSTOM MODE key	Display Mode	Frequency	Sector	Train	Range (m)*	Tilt
Key 1	Horizontal expansion	LO	240°	0°	200	30°
Key 2	Horizontal	HI	360°	0°	200	30°
Key 3	Vertical scan	LO	180°	90°	120	90°

#### 5.3.1 Choosing short-cut or preset

1. Press the **MENU** key to open the menu.
2. Press **▲** to choose MENU, and then press **▶** to choose SYS.

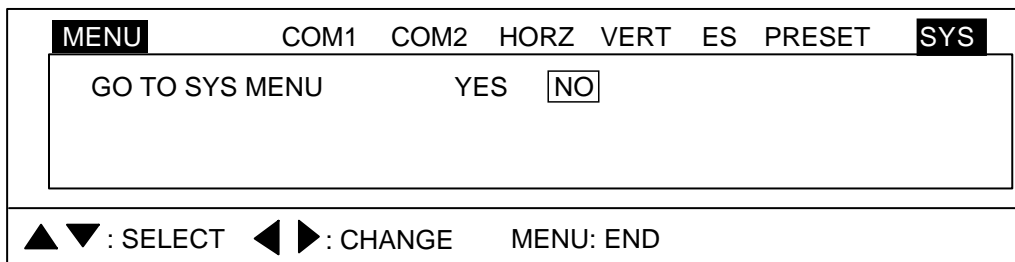

*Display for opening system menu*

3. Press **▼** to choose GO TO SYS MENU.
4. Press **◀** to choose YES.

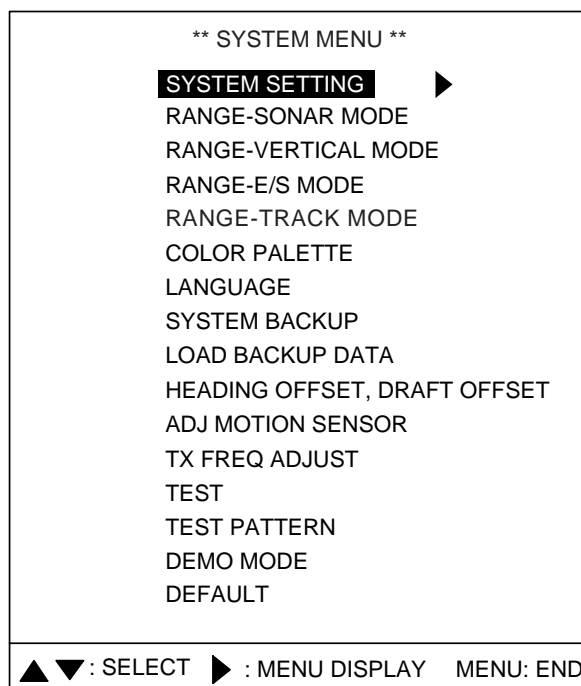

*System menu*

5. Press ► to open the SYSTEM SETTING menu.

\*\* SYSTEM SETTING 1 \*\*

MENU	1	2
POSITION	: SHIP'S L/L	SHIP'S LOP CURSOR L/L
TRACK	: OFF	ON
CURRENT DATA	: OFF	FLOW FROM FLOW TO
HEADING INDICATION	: TRUE	AZ
NORTH MARK	: OFF	ON
CSE DATA	: NAV	GYRO
NAV DATA	: GPS	LoranC LoranA DR DECCA OTHERS
NAV2 BAUDRATE	: 4800	9600 19200 38400
TVG CORRECTION	: OFF	1/2 1/1
UNIT	: m	ft fa HIRO P/B
TEMP	: °C	°F
TARGET L/L	: OFF	ON
CUSTOM KEY	: PRESET KEY	SHORT-CUT KEY
ETA MARK	: OFF	10sec 30sec 1min 3min 6min

▲▼: SELECT ◀▶: CHANGE MENU: END

#### System setting 1 menu

6. Press ▲ or ▼ to choose CUSTOM KEY.
7. Press ◀ or ▶ to choose PRESET KEY or SHORT-CUT KEY as desired.
8. Press the **MENU** key twice to register your selection and close the menu.

### 5.3.2 Preset key

1. Choose PRESET KEY following the procedure in paragraph 5.2.1.
2. Press the **MENU** key to open the menu.
3. Press ▲ to choose MENU, and then press ◀ or ▶ to choose PRESET.

MENU	COM1	COM2	HORZ	VERT	ES	PRESET	SYS
	MODE	FREQ.	SECTOR	TRAIN	RANGE	TILT	
PRESENT	⊙	HI	360°	0°	200	30°	
CUSTOM1	⊔	LO	240°	0°	200	30°	
CUSTOM2	⊙	HI	360°	0°	200	30°	
CUSTOM3	⊔	HI	180°	90°	200	90°	

ADJUST THE KNOBS AND FUNCTION KEYS TO THE DESIRED SETTING,  
THEN PRESS A CUSTOM MODE KEY TO SAVE THE SETTING.

FUNCTION KEY: ENTRY MENU: END

#### PRESET menu

## 5. MENU OPERATION

4. Set the **MODE**, **HI/LO**, **SECTOR**, **TRAIN**, **RANGE** and **TILT** controls according to target fish or fishing area.
5. Press the CUSTOM MODE keys [1], [2] or [3] to program. You are asked if you want to save the settings to the custom key pressed. (In the example, the custom key [1] was pressed.)

SAVE THE SETTING TO CUSTOM1 KEY?	
<input type="checkbox"/> NO	<input type="checkbox"/> YES
◀▶ : CHANGE    MENU: END	

6. Press ▶ to choose YES.
7. Press the **MENU** key. The message "PRGM SET" appears at the screen top.
8. Press the **MENU** key to finish.

### Activating the custom mode

1. Press appropriate CUSTOM MODE key. The indication CUSTOM1, CUSTOM2 or CUSTOM3 appears at the top of the screen depending on key pressed.
2. To escape from the custom mode operation, operate any of the controls among **MODE**, **SECTOR**, **TRAIN**, **RANGE**, **TILT** and **FAST SCAN**.

### 5.3.3 Short-cut key

The default settings are key [1], interference rejector; key [2], signal level, and key [3], background color. The operator may change their functions as desired.

**Note:** In the combination modes the short-cut key operation is only possible from the main window.

1. Choose SHORT-CUT following the procedure in paragraph 5.2.1.
2. Press the **MENU** key to open the menu.
3. Press **▲** to choose MENU, and then press **◀** or **▶** to choose SHORT-CUT.

MENU	COM1	COM2	HORZ	VERT	ES	SHORT-CUT	SYS
KEY 1	VER SEARCH	VOLUME	DEL TRACK	AUTO TILT	BKGD		
KEY 2	SIG LEVEL	CLUTTER	RES. COLOR	WHITE MARKER			
KEY 3	VER SEARCH	VOLUME	DEL TRACK	AUTO TILT	BKGD		
	SIG LEVEL	CLUTTER	RES. COLOR	WHITE MARKER			
	VER SEARCH	VOLUME	DEL TRACK	AUTO TILT	BKGD		
	SIG LEVEL	CLUTTER	RES. COLOR	WHITE MARKER			

SELECT FUNCTION TO BE ALLOCATED TO EACH CUSTOM KEY.  
CUSTOM KEY MAY BE USED AS A PRESET KEY.

▲ ▼ : SELECT    ◀ ▶ : CHANGE    MENU: END

#### SHORT-CUT menu

4. Press **▲** or **▼** to choose key to preset. For example choose KEY 1.
5. Press **◀** or **▶** to choose item.
6. Press the **MENU** key to finish.

#### Activating a short-cut key

1. Press a CUSTOM MODE key, and the dialog box programmed for the custom key pressed appears. For example, the dialog box below is for CLUTTER (HORZ).

CLUTTER (HORZ):	<b>0</b>	1	2	3
-----------------	----------	---	---	---

2. Press **◀** or **▶** to choose option desired.
3. Press the **MENU** key to close the dialog box.

## VERTICAL SEARCH FUNCTION

When you find a target of interest on the horizontal display, simply press the function key programmed for VER. SEARCH to get a cross-sectional view of the vertical plane. This mode is useful for evaluating fish school concentration and location of the targeted fish school or for assistance in navigation.

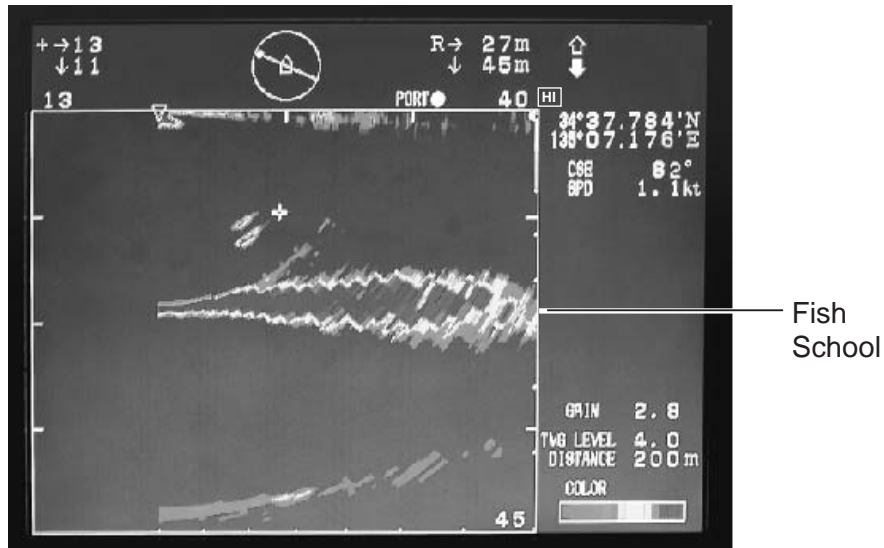

The vertical search picture is drawn using the following specifications:

- Horizontal range: Same as set on horizontal mode
- Vertical range: Same as set on horizontal mode
- Train marker: Train angle at the moment function key is turned on
- Vertical scan display range: 0-90 degrees (own ship position shifted leftward)

## 5.4 SYSTEM Menu

This menu provides items which may be set according to operator's preference. A demonstration mode is provided to acquaint you with the many functions of this equipment, and it may be used without connection of the transducer.

### 5.4.1 How to open the SYSTEM menu

1. Press the **MENU** key to open the menu.
2. Press **▲** to choose MENU, and then press **▶** to choose SYS.
3. Press **▼** to choose GO TO SYS MENU.
4. Press **◀** to choose YES.

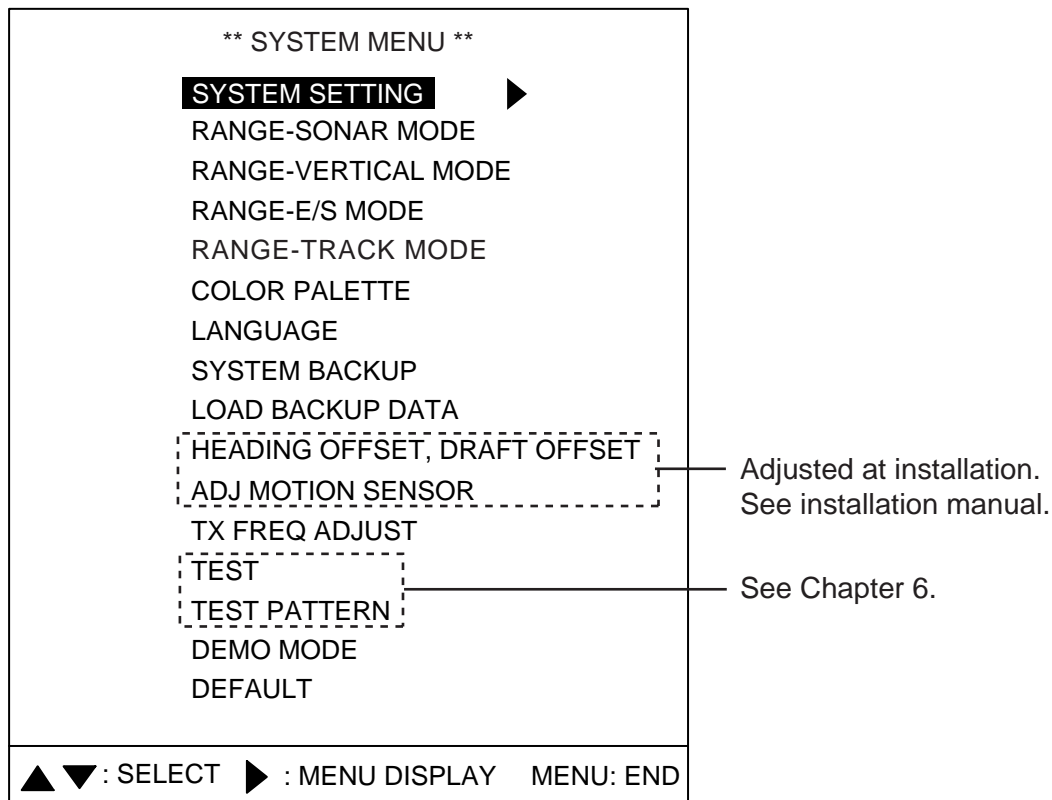

*System menu*

5. Press **▲** or **▼** to choose item desired.
6. Press **◀** or **▶** to open corresponding dialog box.
7. Press **◀** or **▶** to choose option.
8. Press the **MENU** key twice to register your selection and close the menu.

### 5.4.2 System setting menus

#### SYSTEM SETTING 1 menu

1. Display the SYSTEM menu and press ▲ or ▼ to choose SYSTEM SETTING.
2. Press ►.
3. Press ▲ to MENU.
4. Press ◀ to choose "1."

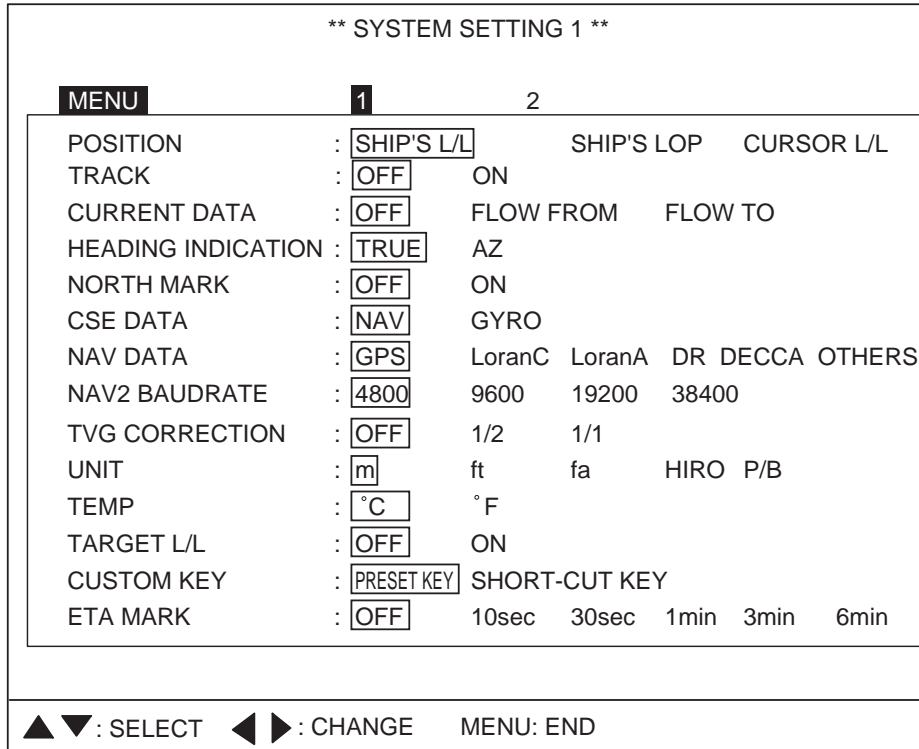

*System setting 1 menu*

#### SYSTEM SETTING 1 menu description

**POSITION:** Chooses how to displays ship’s position; latitude and longitude, Decca/Loran C LOP or Cursor L/L. (The connected navigator must be capable of displaying L/L or LOP.) The default setting is latitude and longitude. Position data required.

**TRACK:** Turns the track display on or off on the horizontal display. The track is always shown on the video plotter display regardless of this setting.

**CURRENT DATA:** Turns current data (tide), shown by vector, on or off. FLOW FROM shows from what direction the current is flowing; FLOW TO shows the direction the current is heading. The default setting is OFF. Requires a current indicator.

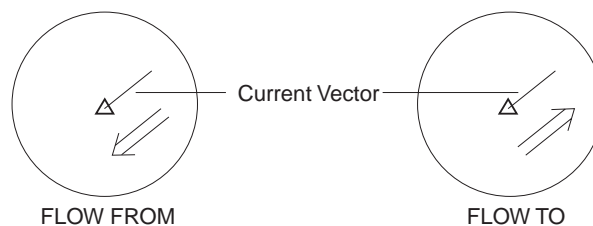

*Current vector*



**HEADING INDICATION:** Chooses heading indication format, true (default setting) or azimuth, for the echo sounder and vertical scan modes. The default setting is TRUE. Requires heading data.

**NORTH MARK:** Turns the north marker on or off (default setting). Requires heading data.

**CSE DATA:** Chooses heading data source, navigator or gyrocompass, to draw ship's track. The default setting is navigator. For heading sensor or gyrocompass connection, choose gyrocompass.

**NAV DATA:** Chooses source of position data, GPS, Loran C, Loran A, DR (Dead Reckoning), Decca or Others (for equipment not shown, receives talker only). Default setting is GPS.

**NAV2 BAUDRATE:** Sets the baud rate of the NMEA port on transceiver unit. Default setting is 4800 bps. For connection with satellite compass, choose 38400 bps.

**TVG CORRECTION:** This feature raises long-range sensitivity without disturbing short-range sensitivity, and it is particularly effective on high frequency. For dual frequency use, particularly when you feel that sensitivity on the high frequency is low compared to that on the low frequency, adjust TVG correction for the high frequency. The settings available are OFF, 1/2 and 1/1, in ascending order of strength. If the setting is too strong, noise will result. Watch the display while changing this setting.

If noise exists on short range or if the echo strength of like size fish from long and short ranges is different use the TVG feature. For further details, see 2.12.3, 3.12.1 and 4.10.1.

**UNIT:** Chooses unit of depth measurement: meters (default setting), feet, fathoms, passi/braza, Hiro.

**TEMP:** Chooses unit of water temperature measurement: °C (default setting), °F.

**TARGET L/L:** Turn on to output event marker position to external equipment. Requires heading and latitude and longitude data from external equipment. Default setting is OFF.

**CUSTOM KEY:** Chooses function of custom mode keys: preset (default setting) or short-cut. For details see paragraph 5.2.

**ETA MARK:** A vector line extends from the own ship marker in direction of ship's bow on the horizontal mode display. The tip of the line shows the estimated time of arrival after the selected ETA time elapses, using the current ship's speed. ETA is calculated every second considering tilt and detection range. This function requires speed input.

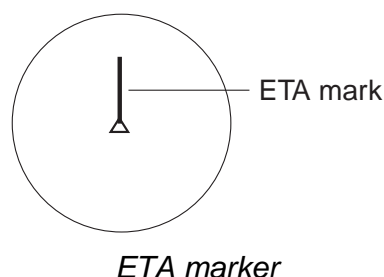

**SYSTEM SETTING 2 menu description**

\*\* SYSTEM SETTING 2 \*\*

**MENU** : 1 **2**

GAIN SETTING PROTECT :	OFF	<input type="button" value="ON"/>	
HORZ/HISTORY :	OFF	<input type="button" value="ON"/>	
HORZ/VERT :	OFF	<input type="button" value="ON"/>	
HORZ/VERT ZOOM :	OFF	<input type="button" value="ON"/>	
HORZ/PLOTTER :	OFF	<input type="button" value="ON"/>	
EMPHASIS MODE :	OFF	<input type="button" value="NORMAL"/>	<input type="button" value="RED"/>
STABILIZER :	OFF	<input type="button" value="MOTION SENSOR"/>	<input type="button" value="SAT. COMPASS"/>
AUTO RETRACTION :	<input type="button" value="OFF"/>	(OFF, 5-15 kt)	
SPEED ALARM/MESSAGE :	OFF	<input type="button" value="ON"/>	
SWEEP INDICATOR :	DOT	<input type="button" value="LINE"/>	
DEFAULT SETTING :	<input type="button" value="NO"/>	YES	

MAXIMUM ALLOWABLE SPEED IS 15 KNOTS WHILE SOUNDOME IS BEING RETRACTED. IF VESSEL HAS RAPID ACCELERATION CAPABILITIES, AUTO RETRACTION SETTINGS OF 10-12 KNOTS ARE MANDATORY TO AVOID CATASTROPHIC DAMAGE TO SOUNDOME ASSY. ANY PHYSICAL DAMAGE TO THE SOUNDOME ASSY. IS CONSIDERED ABUSE AND IS NOT A WARRANTY ISSUE.

▲ ▼ : SELECT   ◀ ▶ : CHANGE   MENU: END

*System setting 2 menu*

**GAIN SETTING PROTECT:** Prevents accidental adjustment of the gain. When ON the gain cannot be adjusted unless the GAIN control is first pushed. Default setting is ON. This feature is effective on the single-frequency displays and combination displays (mix display OFF).

**HORZ/HISTORY:** Enables/disables the horizontal/history display. Default setting is ON.

**HORZ/VERT:** Enables/disables the horizontal/vertical scan display. Default setting is ON.

**HORZ/VERT ZOOM:** Enables/disables the horizontal/vertical zoom display. Default setting is ON.

**HORZ/PLOTTER:** Enables/disables the horizontal/plotter display. Default setting is ON.

**EMPHASIS MODE:** Choose method of picture interpolation. OFF: Interpolation close to raw signal. NORMAL: Clarifies picture. EMPHASIS: Emphasizes strong signals.

**STABILIZER:** Choose the sensor to use to compensate for effects of ship's pitching and rolling. The choices are Motion Sensor MS-100, Clinometer BS-704 and Satellite Compass (SC-50/SC-110).

**AUTO RETRACTION:** Turn on to automatically retract the transducer when ship's speed exceeds the speed set here. The ship's speed range for automatic retraction is from 5 to 15 knots. The default setting is OFF (no automatic retraction). The transducer may be retracted at a speed other than the intended one when ship's speed data is erroneous.

**SPEED ALARM/MESSAGE:** Turn on (default setting) to display speed alarm message and sound the audio alarm when ship's speed exceeds allowable speed for a given transducer operation. The audio alarm can be silenced with the **R/B** key.

[↓] pressed to lower transducer	
Speed above 15 kts	Message 1 appears. Reduce speed below 15 kts to restore normal operation.
Transducer being lowered	
Speed over 15 kts	Message 1 appears and lowering continues.
Transducer lowered	
Speed above 20 kts	Message 2 appears accompanied with the aural alarm. Reduce the speed below 20 kts to restore normal operation.
[↑] pressed to raise transducer	
Speed above 15 kts	Message 1 appears accompanied with the aural alarm. Transducer is not raised. Reduce the speed below 15 kts to erase the message and restore normal operation. Then, press [↑] again to raise the transducer.
Transducer being raised	
Speed above 15 kts	Message 1 appears and raising continues. Reduce the speed below 15 kts to erase the message and restore normal operation.

SHIPS SPEED  
EXCEEDS 15 kt.  
(SLOW DOWN UNDER 15 kt WHEN  
MOVING TRANSDUCER UNIT.)  
  
PRESS R/B KEY TO SILENCE ALARM.

Message 1

TRANSDUCER REMAINS  
LOWERED.  
(REDUCE SHIP'S SPEED AND PRESS  
↑ TO RETRACT IT.)  
  
PRESS R/B KEY TO SILENCE ALARM.

Message 2

**SWEEP INDICATOR:** Shows train position in the horizontal mode and tilt angle in the vertical scan mode, with a line or a dot. (See the illustration on page 2-2 and 3-2.)

**DEFAULT SETTING:** Choose YES and press the **MENU** key to restore all default system menu settings. Several beeps sound while default settings are being restored and then normal operation is restored.

** FACTORY SETTING **	
ARE YOU SURE? :	[NO]      YES
NOTE! ALL THE SYSTEM SETTING WILL BE CHANGED TO FACTORY SETTING.	
◀▶ : CHANGE	MENU: END

*FACTORY SETTING dialog box*

### 5.4.3 Sonar (horizontal) mode range settings

The user may preset horizontal mode ranges as desired.

1. Choose RANGE-SONAR MODE at the SYS menu and then press ►.

** RANGE-SONAR MODE **		
1	:	<input type="text" value="20"/> (10-1600m)
2	:	<input type="text" value="40"/>
3	:	<input type="text" value="60"/>
4	:	<input type="text" value="80"/>
5	:	<input type="text" value="100"/>
6	:	<input type="text" value="120"/>
7	:	<input type="text" value="160"/>
8	:	<input type="text" value="200"/>
9	:	<input type="text" value="250"/>
10	:	<input type="text" value="300"/>
11	:	<input type="text" value="400"/>
12	:	<input type="text" value="500"/>
13	:	<input type="text" value="600"/>
14	:	<input type="text" value="800"/>
15	:	<input type="text" value="1200"/>
DEFAULT SETTING :		<input type="text" value="NO"/> YES
▲▼ : SELECT   ◀▶ : CHANGE   MENU: END		

*Range-sonar mode dialog box*

2. Press ▲ or ▼ to choose range number desired.
3. Press ◀ or ▶ to set range.
4. To restore default horizontal mode range settings, choose DEFAULT SETTING, press ► to choose YES and press the **MENU** key.
5. Press the **MENU** key to register settings and close the menu.

### 5.4.4 Vertical scan mode range settings

As with the horizontal mode, the user may preset the vertical scan mode's ranges.

1. Choose RANGE-VERTICAL MODE at the SYS menu and then press ►.

** RANGE-VERT MODE **		
1	:	<input type="text" value="10"/> (10-600m)
2	:	<input type="text" value="20"/>
3	:	<input type="text" value="30"/>
4	:	<input type="text" value="40"/>
5	:	<input type="text" value="60"/>
6	:	<input type="text" value="80"/>
7	:	<input type="text" value="100"/>
8	:	<input type="text" value="120"/>
9	:	<input type="text" value="160"/>
10	:	<input type="text" value="200"/>
11	:	<input type="text" value="250"/>
12	:	<input type="text" value="300"/>
13	:	<input type="text" value="400"/>
14	:	<input type="text" value="500"/>
15	:	<input type="text" value="600"/>
DEFAULT SETTING :		<input type="text" value="NO"/> YES
▲▼: SELECT   ◀▶: CHANGE   MENU: END		

*Range-vert mode dialog box*

2. Press ▲ or ▼ to choose range number desired.
3. Press ◀ or ▶ to set range.
4. To restore default vertical scan mode range settings, choose DEFAULT SETTING, press ► to choose YES and press the **MENU** key.
5. Press the **MENU** key to register settings and close the menu.

### 5.4.5 Echo sounder mode range settings

As with the horizontal and vertical scan modes, the user may preset the echo sounder mode's ranges.

1. Choose RANGE-E/S MODE at the SYS menu and then press ►.

\*\* RANGE-E/S MODE \*\*

1	:	<input style="width: 50px;" type="text" value="10"/>	(10-600m)
2	:	<input style="width: 50px;" type="text" value="20"/>	
3	:	<input style="width: 50px;" type="text" value="30"/>	
4	:	<input style="width: 50px;" type="text" value="40"/>	
5	:	<input style="width: 50px;" type="text" value="60"/>	
6	:	<input style="width: 50px;" type="text" value="80"/>	
7	:	<input style="width: 50px;" type="text" value="100"/>	
8	:	<input style="width: 50px;" type="text" value="120"/>	
9	:	<input style="width: 50px;" type="text" value="160"/>	
10	:	<input style="width: 50px;" type="text" value="200"/>	
11	:	<input style="width: 50px;" type="text" value="250"/>	
12	:	<input style="width: 50px;" type="text" value="300"/>	
13	:	<input style="width: 50px;" type="text" value="400"/>	
14	:	<input style="width: 50px;" type="text" value="500"/>	
15	:	<input style="width: 50px;" type="text" value="600"/>	

DEFAULT SETTING :            YES

▲▼ : SELECT    ◀▶ : CHANGE    MENU: END

*Range-E/S mode dialog box*

2. Press ▲ or ▼ to choose range number desired.
3. Press ◀ or ▶ to set range. The setting range depends on the transducer used.
4. To restore default echo sounder mode range settings, choose DEFAULT SETTING, press ► to choose YES and press the **MENU** key.
5. Press the **MENU** key to register settings and close the menu.

### 5.4.6 Track range settings

You may choose the video plotter display scale range as follows.

1. Choose RANGE-TRACK at the SYS menu and then press ►.

** RANGE-TRACK MODE **	
<b>1</b> :	<input type="text" value="500"/> (100-10000m)
2 :	<input type="text" value="1000"/>
3 :	<input type="text" value="2000"/>
4 :	<input type="text" value="4000"/>
5 :	<input type="text" value="8000"/>
DEFAULT SETTING : <input type="text" value="NO"/> YES	
▲▼ : SELECT   ◀▶ : CHANGE   MENU: END	

*Range-track mode dialog box*

2. Press ▲ or ▼ to choose range number desired.
3. Press ◀ or ▶ to set.
4. Press the **MENU** key to register settings and close the menu.

### 5.4.7 Color palette

The color palette lets the user change the color of echoes, background, text and menu as desired.

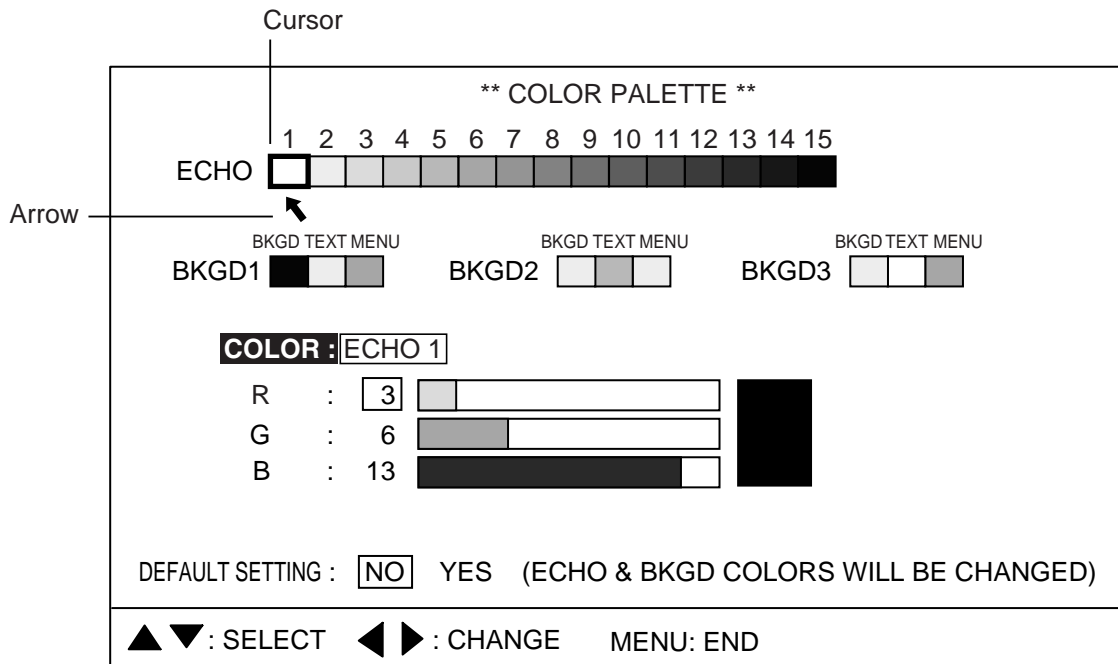

*Color palette dialog box*

1. Press ◀ or ▶ to place the cursor and arrow on the item to change. Pressing ▶ shifts the arrow and cursor from left to right and top to bottom.
2. Press ▲ or ▼ to choose R(red), G(green) or B(blue) as appropriate.
3. Press ◀ or ▶ to adjust color.
4. Press the **MENU** key to register your settings and close the menu.

**Note:** To restore default color settings, choose **DEFAULT SETTING**, press ▶ to choose **YES**, and press the **MENU** key. A few beeps sound while the default colors are being restored and then normal operation is restored.



### 5.4.8 Language

Menu language can be chosen from among the languages shown in the Language dialog box and the default language is English.

** LANGUAGE **				
<b>LANGUAGE:</b>	JAPANESE	<input type="text" value="ENGLISH"/>	FRANCAIS	ESPANOL
	ITALIANO	PORTUGUES	DANSK	NORSK
	SVENSK	THAI		
◀▶ : CHANGE    MENU: END				

*Language dialog box*

### 5.4.9 System backup

User settings can be backed up with the menu item SYSTEM BACKUP.

** SYSTEM BACKUP **	
<b>ARE YOU SURE?</b> :	<input type="text" value="NO"/> YES
NOTE: OVERWRITES PREVIOUS BACKUP DATA.	
◀▶ : CHANGE    MENU: END	

*System backup dialog box*

### 5.4.10 Loading backup data

System data may be loaded from the LOAD BACKUP DATA dialog box.

** LOAD BACKUP DATA **	
<b>ARE YOU SURE?</b> :	<input type="text" value="NO"/> YES
NOTE: OVERWRITES CURRENT SETTINGS.	
◀▶ : CHANGE    MENU: END	

*Load backup data dialog box*

### 5.4.11 Transducer frequency adjustment

If the CH-300 is receiving interference from a video sounder or other sonar on board your ship, adjust the frequency of the CH-300's transducer to reduce the interference.

** TX FREQ ADJUST **	
<b>FREQ SHIFT (L)</b> :	<input style="width: 50px;" type="text" value="85.0"/> kHz (85-95 kHz)
FREQ SHIFT (H) :	215.0 kHz (205-225 kHz)
▲ ▼ : SELECT ◀ ▶ : CHANGE MENU: END	

*TX frequency adjustment dialog box*

### 5.4.12 Demonstration mode

The demonstration mode provides a simulated sonar picture which helps you become acquainted with how your sonar works. Connection of the transducer is not required. All controls are operational.

1. Display the SYS menu.
2. Choose DEMO MODE.
3. Press ▶ to open the menu.

** DEMO MODE **	
<b>DEMO MODE</b> :	<input style="width: 50px;" type="text" value="OFF"/> ON
◀ ▶ : CHANGE MENU: END	

*Demo mode dialog box*

4. Choose OFF or ON as appropriate and press the **MENU** key. (DEMO) appears at the top of the screen when the demonstration mode is active.

### 5.4.13 Restoring all default settings

The item DEFAULT lets you restore all default menu settings. Choose YES and press the **MENU** key to restore all default settings. Note that SOUNDOME SER. NO (SYSTEM SETTING2 menu) and the contents stored by using the SYSTEM BACKUP feature (paragraph 5.4.9) are not disturbed.

** DEFAULT **	
<b>ARE YOU SURE?</b> :	<input type="checkbox"/> NO      YES
NOTE! RESET ALL THE SETTINGS INCLUDED IN SYSTEM MENU TO DEFAULT.	
◀ ▶ : CHANGE      MENU: END	

*Default menu*

 <b>CAUTION</b>
<p><b>All default settings will be restored. If necessary jot down settings which must be restored.</b></p>

**Note:** The following appears after the power-up following the restoration of default settings.

Please set language. ([▲/▼]: Select, [MENU]: Enter)  ... For Japanese Customer In Japanese)  (Japanese) <input checked="" type="checkbox"/> English <input type="checkbox"/> Francais
---

*Language selection screen*

## 5. MENU OPERATION

This page intentionally left blank.

# 6. MAINTENANCE, TROUBLESHOOTING

---

This chapter provides information necessary for keeping the equipment in good working order.

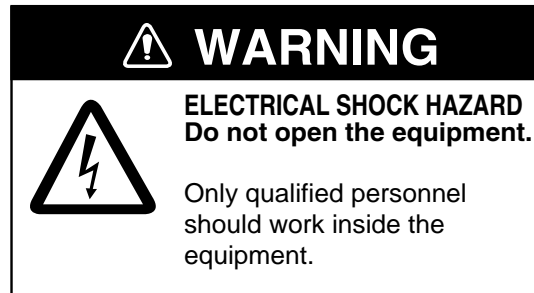

## 6.1 Preventive Maintenance

Check the following points monthly.

- Check all cables. If damaged, replace.
- Check connectors at rear of each unit. Clean if necessary.
- Check earth of each unit. Clean if necessary.
- Check voltage of ship's mains to be sure it is within the equipment's power rating.

## 6.2 Cleaning the Equipment

Dust or dirt can be removed from the equipment with a soft, dry cloth. Do not use chemical cleaners to clean the equipment – they can remove paint and markings. The LCD will, in time, accumulate a coating of dust which tends to dim the picture. Wipe LCD lightly with soft cloth to remove dust.

## 6.3 Hull Unit Maintenance

### 6.3.1 Lubrication

Grease the raise/lower screw shaft once a year. Also, grease the raise/lower main shaft (upper part of the grease cotton retainer) twice a year. These parts can be accessed by removing the raise/lower drive assembly cover.

### 6.3.2 Manually raising, lowering transducer

**⚠ WARNING**

**Turn off the power at the ship's mains switchboard before conducting the procedure below.**

Rotating motor can cause bodily injury.

1. Turn off the breaker on the hull unit.
2. Turn nut with 19 mm ratchet wrench.
3. Check that the transducer raises and lowers smoothly, from the upper to the lower limit positions. If the transducer cannot be raised smoothly, do not use excessive force; the shaft may bend, causing damage to other components.
4. Check soundome and tank. Remove marine life with fine sandpaper or piece of wood.

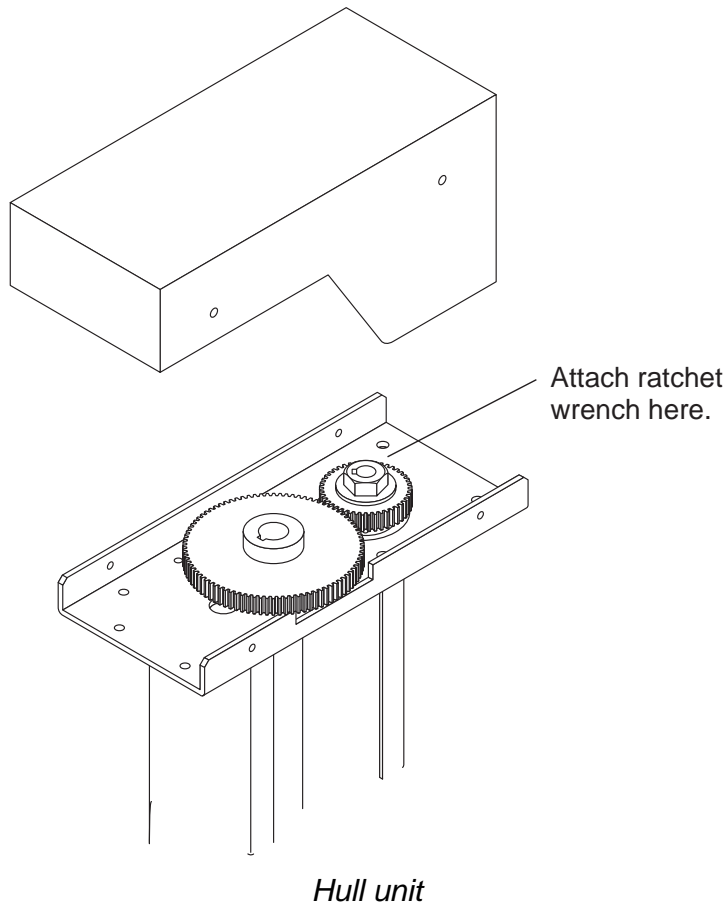

## 6.4 Transducer Maintenance

When the ship is dry-docked remove marine growth from the transducer with fine sandpaper or a piece of wood. Coat the transducer face with anti-fouling paint (Chugoku MarineStar 20 Red or the equivalent)

<b>NOTICE</b>
<p><b>Do not paint the transducer face.</b></p> <p>Loss of sensitivity will result.</p>
<p><b>Do not use plastic solvents to clean the transducer.</b></p> <p>They can damage the transducer.</p>

## 6.5 Fuse Replacement

The fuse in the hull and transceiver units protect them from overvoltage, equipment fault and reverse polarity of the ship's mains. If the power cannot be applied first check that the power cable between the transceiver unit and the monitor unit is firmly connected. If the power still cannot be applied, the fuse in the transceiver unit may have blown. Have a suitably qualified technician check the fuse.

Unit	Type	Code No.
Transceiver Unit	FGMB 10A AC125V	000-104-815
Hull Unit	FGMB 7A 125V	000-105-868
Monitor Unit	FGMB 3A 125V	000-104-909
Interface Unit	FGMB 0.2A 125V	000-121-723

 <b>WARNING</b>
<p><b>Use the proper fuse.</b></p> <p>Use of a wrong fuse can cause fire or damage the equipment.</p>

## 6.6 Troubleshooting

The table below provides common symptoms of equipment troubles and the means to rectify them.

Symptom	Check, Remedy
Cannot turn on the power.	<ul style="list-style-type: none"> <li>• Check cable between transceiver unit and monitor unit.</li> <li>• Check ship's mains.</li> <li>• Have a suitably qualified technician check the fuse in the transceiver unit.</li> </ul>
Bottom echo becomes irregular.	<ul style="list-style-type: none"> <li>• Rough seas. Distance to the bottom changes due to rolling and pitching.</li> <li>• Long range selected. Transmission period is longer so ship's pitching and rolling are apt to affect detection of echo.</li> </ul>
Weak echo	<ul style="list-style-type: none"> <li>• Output power set to minimum. Set to maximum, on the COM1 menu.</li> <li>• Excessive TVG. Readjust TVG on the appropriate menu (HORZ, VERT, ES). Note that readjustment of TVG is necessary when gain is adjusted.</li> </ul>
Somewhat strange color	<ul style="list-style-type: none"> <li>• Brilliance setting too low. Increase brightness with BRILL key (supplied monitor) or brilliance control on commercial monitor.</li> </ul>
Picture contains noise.	<ul style="list-style-type: none"> <li>• Equipment not grounded properly. Check equipment ground.</li> <li>• Power cable is too close to the signal cable. Relocate power cable or signal cable.</li> <li>• Debris may be on sea surface. Reject unwanted noise with the interference rejector on the COM1 menu.</li> </ul>
Picture does not change when tilt angle is changed. (Bottom is not displayed in vertical scan picture when bottom is flat.)	<ul style="list-style-type: none"> <li>• Problem in tilt mechanism or control line. Contact a FURUNO agent or dealer for advice.</li> </ul>



## 6.7 Error Messages

The table below shows the error messages which may appear on the display. All error messages are accompanied by an audio alarm, which you may silence with the **R/B** key.

Message	Meaning, Remedy
<b>Hull Unit</b>	
HULL UNIT POWER OFF (CHECK BREAKER AND FUSE.) PRESS R/B KEY TO SILENCE ALARM.	Hull unit is not powered. Silence the audio alarm with the <b>R/B</b> key, and then turn on the hull unit to erase the message and restore normal operation.
RAISE/LOWER FUNCTION HAS NOT BEEN COMPLETED. CHECK IF THE BREAKER AT THE HULL UNIT HAS BEEN ACTIVATED. MAXIMUM ALLOWABLE SPEED IS 15 KNOTS WHILE SOUNDOME IS BEING RETRACTED. PRESS R/B KEY TO SILENCE ALARM.	You attempted to raise or lower the transducer when the ship's speed is above 15 knots or the breaker on the hull unit tripped. Check the breaker and lower the ship's speed below 15 knots to execute function desired.
<b>Frequency Code Error</b>	
FREQUENCY CODE ERROR (CHECK TRANSCIVER UNIT.) PRESS R/B KEY TO SILENCE ALARM.	CPU does not receive frequency flag from transducer. Silence the audio alarm with the <b>R/B</b> key, and then check the transceiver unit.
<b>Train Error</b>	
TRAIN NG	CPU does not receive heading signal. Check source of heading signal.
<b>Excessive Speed</b>	
SHIPS SPEED EXCEEDS 15 kt. (SLOW DOWN UNDER 15 kt WHEN MOVING TRANSDUCER.) PRESS R/B KEY TO SILENCE ALARM.	See page 5-13 for details.
TRANSDUCER REMAINS LOWERED. (REDUCE SHIP'S SPEED AND PRESS ↑ TO RETRACT IT.) PRESS R/B KEY TO SILENCE ALARM.	

## 6.8 Diagnostics

1. Press the **MENU** key to open the menu.
2. Press **▲** to choose MENU, and then press **▶** to choose SYS.
3. Press **▼** to choose GO TO SYS MENU.
4. Press **◀** to choose YES.
5. Choose TEST and press **▶** to start the test. The lamps above the XDR switches light alternately for one second while the test is being conducted. In a few moments the results of the test appear.

```

MAIN PROGRAM NO. : 0650111-XX.XX
PANEL PROGRAM NO. : 0650112-XX.XX
ROM              : OK
RAM              : OK
VRAM            : OK
NMEA1           : *
NMEA2           : *
TX FREQUENCY    : 85/215 kHz†
ROLL            MS: 10   SC: ---
PITCH           MS: 10   SC: ---
                PULSES  NG
TRAIN           359     0
TEST COUNT=    : 10

PANEL                                REMOTE CONTROL
┌───────────────────────────────────┬───────────┐
│ 0 0 0 0 0 0 0 0 0 0 0 0 0 0 0 0 │ 0 0 │
│ 0 0 0 0 0 0 0 0 0 0 0 0 0 0 0 0 │ 0 0 │
│ 0 0 0 0 0 0 0 0 0 0 0 0 0 0 0 0 │ 0 0 │
│ 0 0 0 0 0 0 0 0 0 0 0 0 0 0 0 0 │ 0 0 │
└───────────────────────────────────┴───────────┘

```

\* Requires special test connector to test. Nothing displayed when plug is not connected.

† Or 60/153 kHz

XX.XX = Program Version No.

### *Test results*

#### **Interpreting the test results display**

- The program numbers of the MAIN and PANEL programs appear at the top of the display.
- The ROM, RAM, VRAM, NMEA1, NMEA2 and PANEL CPU are checked for proper operation and the results displayed as OK or NG (No Good). For NG contact a FURUNO agent or dealer for advice. The NMEA1/NMEA2 test checks the NMEA (monitor unit) / NMEA (transceiver unit) ports.
- The TX FREQUENCY of the transducer is measured and displayed.
- ROLL and PITCH values change with ship's pitching and rolling (range: -30° to +30°).

- TRAIN shows a figure between 355-359 if normal. NG appears in case of train error.
- TEST COUNT shows the number of times the test has been consecutively executed.
- At the bottom of the screen there are two major groups of zeroes (0), and they represent the keys and controls on the control panel and remote controller. Press a key and its on-screen location shows "1" while the key is pressed and "0" when it is released. Operate a control and its on-screen indication changes from 0-19. When the **BRILL** control is operated the panel dimmer increases or decreases with adjustment of the control.

To quit the test, press the **MENU** key three times.

## 6.9 Test Pattern

A test pattern can be displayed to check for proper display of colors.

1. Press the **MENU** key to open the menu.
2. Press **▲** to choose MENU, and then press **▶** to choose SYS.
3. Press **▼** to choose GO TO SYS MENU.
4. Press **◀** to choose YES.
5. Choose TEST PATTERN and press **▶** to display the test pattern. Press **▶** again to change the test pattern. The pattern changes in the sequence shown below with each press of **▶**.

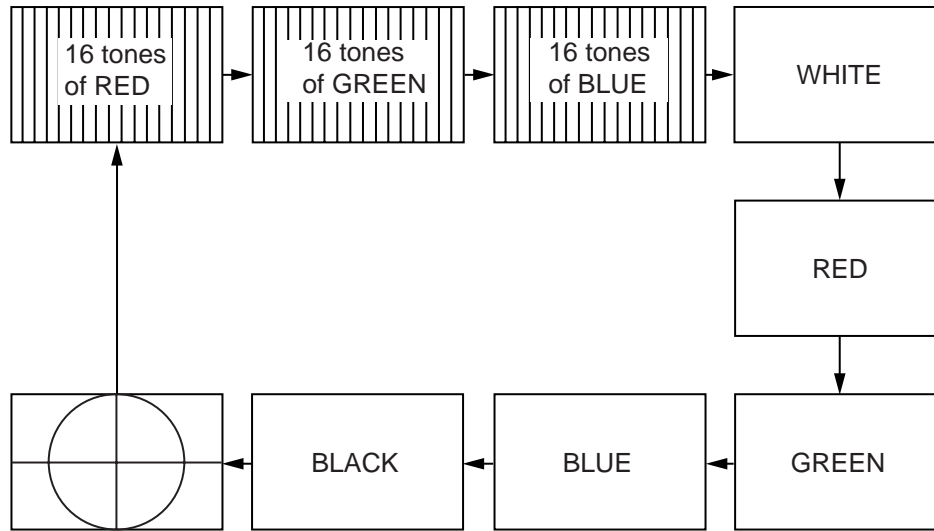

*Test pattern*

To quit the test pattern, press the **MENU** key.

# MENU TREE

[MENU] key

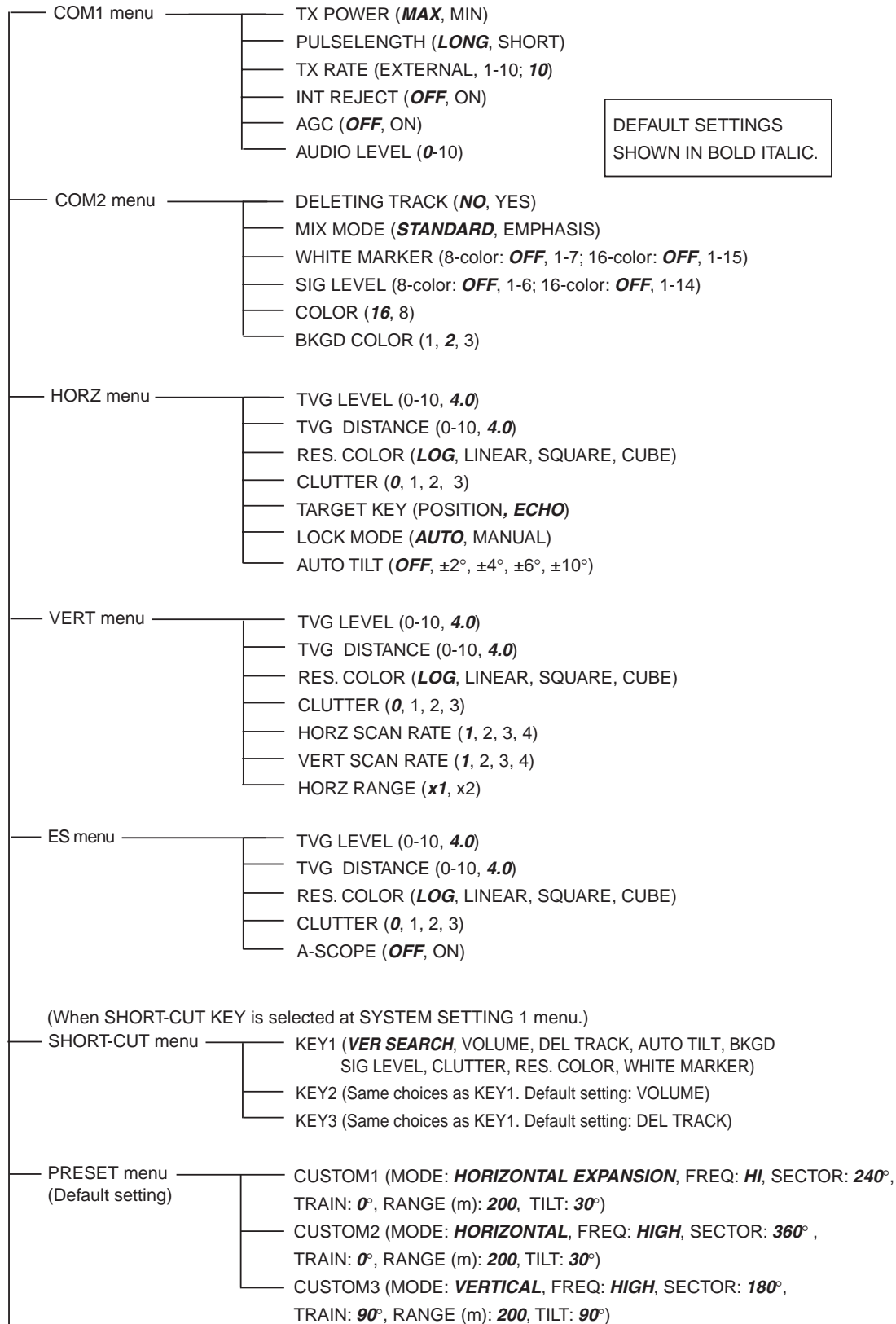

(CONTINUED ON NEXT PAGE)

# MENU TREE

(CONTINUED FROM PREVIOUS PAGE)

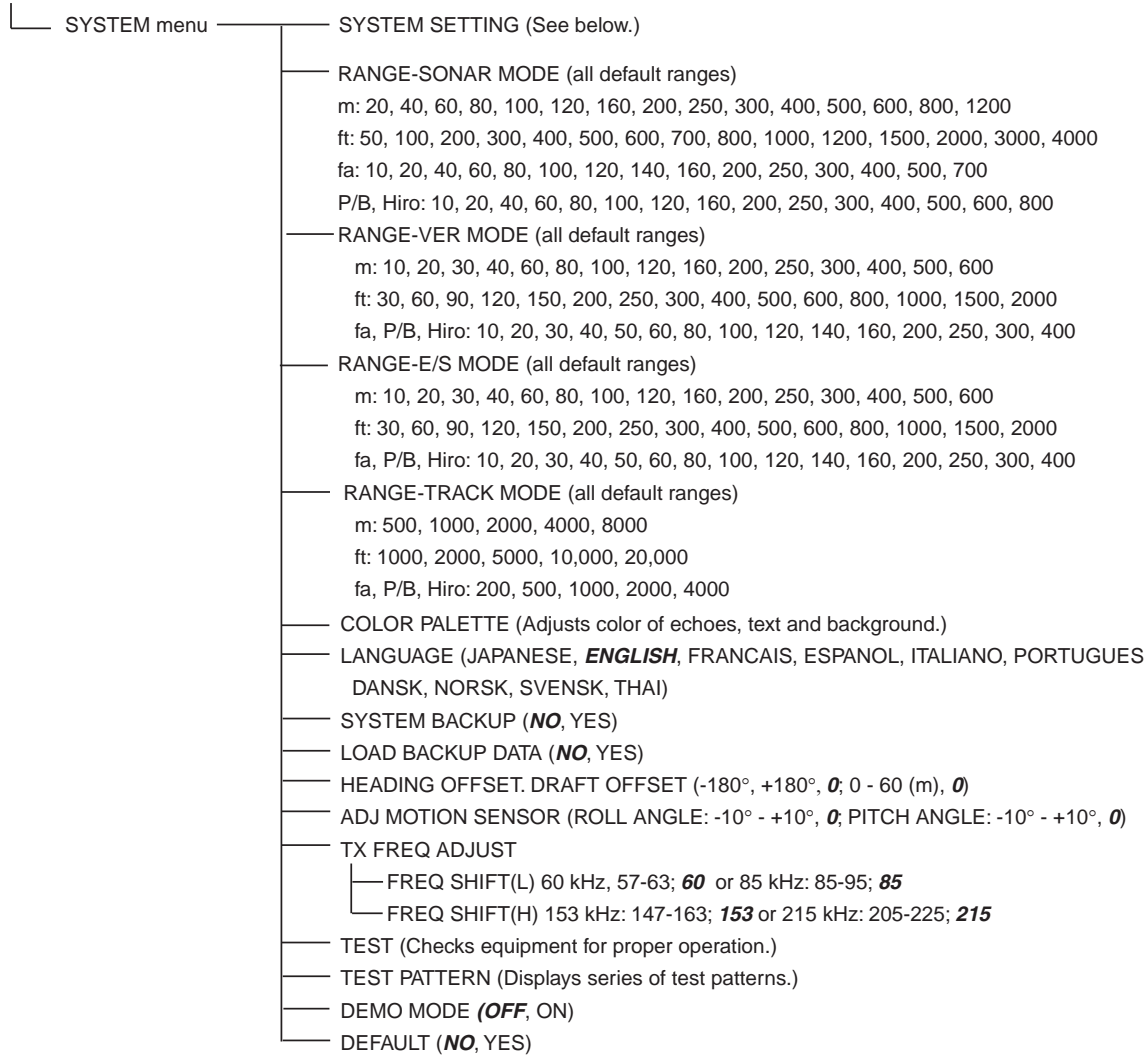

## SYSTEM SETTING 1

- POSITION (**SHIP'S L/L**, SHIP'S LOP, CURSOR L/L)
- TRACK (OFF, **ON**)
- CURRENT DATA (**OFF**, FLOW FROM, FLOW TO)
- HEADING INDICATION (**TRUE**, AZ)
- NORTH MARK (**OFF**, ON)
- CSE DATA (**NAV**, GYRO)
- NAV BAUDRATE (**4800**, 9600, 19200, 38400 (bps))
- NAV DATA (**GPS**, LoranC, LoranA, DR, DECCA, OTHERS)
- TVG CORRECTION (**OFF**, 1/2, 1/1)
- UNIT (**m**, ft, fa, HIRO, P/B)
- TEMP (°**C**, °F)
- TARGET L/L (**OFF**, ON)
- CUSTOM KEY (**PRESET KEY**, SHORT-CUT KEY)
- ETA MARK (**OFF**, 10sec, 30sec, 1min, 3min, 6min)

## SYSTEM SETTING 2

- GAIN SETTING PROTECT (OFF, **ON**)
- HORZ/HISTORY (OFF, **ON**)
- HORZ/VERT (OFF, **ON**)
- HORZ/VERT ZOOM (OFF, **ON**)
- HORZ/PLOTTER (OFF, **ON**)
- EMPHASIS MODE (OFF, **NORMAL**, RED)
- STABILIZER (OFF, **ON**)
- AUTO RETRACTION (**OFF**, 5-15kt(ON))
- SPEED ALARM/MESSAGE (OFF, **ON**)
- SWEEP INDICATOR (DOT, **LINE**)
- DEFAULT SETTING (**NO**, YES)

## DUAL-FREQUENCY SEARCHLIGHT SONAR CH-300

### 1. GENERAL

- 1.1 Display System                      10.4-inch color TFT LCD (or external monitor)
- 1.2 Transmit Frequency                Dual frequency, 60/153 kHz or 85/215 kHz
- 1.3 Output Power                        1.0 kW
- 1.4 Range (default setting)

Rng	Meter			Feet			Fathom			P/B			Hiro		
	Horz	Vert	ES	Horz	Vert	ES	Horz	Vert	ES	Horz	Vert	ES	Horz	Vert	ES
1	20	10	10	50	30	30	10	10	10	10	10	10	10	10	10
2	40	20	20	100	60	60	20	20	20	20	20	20	20	20	20
3	60	30	30	200	90	90	40	30	30	40	30	30	40	30	30
4	80	40	40	300	120	120	60	40	40	60	40	40	60	40	40
5	100	60	60	400	150	150	80	50	50	80	50	50	80	50	50
6	120	80	80	500	200	200	100	60	60	100	60	60	100	60	60
7	160	100	100	600	250	250	120	80	80	120	80	80	120	80	80
8	200	120	120	700	300	300	140	100	100	160	100	100	160	100	100
9	250	160	160	800	400	400	160	120	120	200	120	120	200	120	120
10	300	200	200	1000	500	500	200	140	140	250	140	140	250	140	140
11	400	250	250	1200	600	600	250	160	160	300	160	160	300	160	160
12	500	300	300	1500	800	800	300	200	200	400	200	200	400	200	200
13	600	400	400	2000	1000	1000	400	250	250	500	250	250	500	250	250
14	800	500	500	3000	1500	1500	500	300	300	600	300	300	600	300	300
15	1200	600	600	4000	2000	2000	700	400	400	800	400	400	800	400	400

#### 1.5 Minimum and maximum ranges

##### Horizontal mode

	Meter	Feet	Fathom	P/B	Hiro
Min. range	10	30	5	5	5
Max. range	1600	5000	800	1000	1000

##### Vertical scan mode, echo sounder mode

	Meter	Feet	Fathom	P/B	Hiro
Min. range	10	30	5	5	5
Max. range	600	2000	400	400	400

### 2. MONITOR/CONTROL UNIT

- 2.1 Display                                VGA (640x480)
- 2.2 Brilliance                            350cd/m<sup>2</sup> TYP
- 2.3 Display Colors                      16 or 8 colors, Background: 3 colors, selectable (user setting available)

- 2.4 Display Mode Horizontal1, Horizontal expansion1, Vertical scan1, Echo sounder1, Horizontal2, Horizontal expansion2, Vertical scan2, Echo sounder2, Combination (vertical scan port/starboard, vertical scan upward/downward, Strata, History)
- 2.5 Alphanumerical Indication Range, Tilt angle, Sensitivity, TVG, Interference rejection, Frequency (high, low), Transducer status, Tracking, Color
- 2.6 Data Indication L/L (Own ship or cursor), Depth, Bearing, Speed, Water temperature, Tide, Ship's track, North mark, Tide vector, ETA marker (External IEC-61162 data required, not shown on some displays),
- 2.7 Other Markers Offcenter, Signal level, White marker, Emphasis, Cursor, VRM, Event marker (5 pts.), Target lock, Clutter
- 2.8 Indication Unit Meter, Feet, Fathom, P/B, Hiro
- 2.9 Audio Monitor 2 W output (4 ohms), Freq. 1.0 kHz (external speaker required)
- 2.10 Language English and other languages

**3. TRANSCEIVER UNIT**

- 3.1 Transmission Dual frequency Tx/Rx, single frequency
- 3.2 Pulse Length 0.24 ms to 20.0 ms, according to range (up to 10 ms for each frequency in dual-frequency transmission)
- 3.3 TVG Level: 100 dB max. , Distance: 1000 m

**4. HULL UNIT**

- 4.1 Transducer Travel 400 mm or 250 mm
- 4.2 Raise/lower Time 30 s (400 mm travel)
- 4.3 Ship's Bow Adjustment ±180° offset on menu, set during installation
- 4.4 Horizontal Mode Control  
 Scanning angle: 6° to 360°, 24° step  
 Scanning center: 6° steps, 360° setting available  
 Scanning step angle: Normal: 6°, High speed: 12°  
 Elevation angle: +5° to 90°, 1° step  
 Auto tilt setting: ±2° to ±10°

4.5 Time to Train Full Circle (\* NS, Normal Speed, HS, High Speed)

Single frequency, horizontal mode

Range (m)		20	40	60	80	100	120	160	200	250	300	400	500	600	800	1200
Time (sec)	NS*	9	9	9	9	9	11	14	17	21	25	33	41	49	65	97
	HS*	9	9	9	9	9	11	12	14	16	18	22	26	30	38	54

Dual frequency, horizontal mode

Range (m)		20	40	60	80	100	120	160	200	250	300	400	500	600	800	1200
Time (sec)	NS*	11	11	11	11	11	12	15	18	22	26	34	42	50	66	98
	HS*	11	11	11	11	11	12	14	15	17	19	23	27	31	39	55



4.6 Vertical Scan Mode Control

Scanning angle: 6° to 180°, 12° step  
 Scanning center: 0° to 180°, 6° step  
 Scanning step angle: Normal: 3°, High speed: 6°  
 Time to train: 360°, 6° step

4.7 Transceiver Beam Width

<u>Frequency</u>	<u>Horizontal</u>	<u>Vertical</u>
60 kHz:	16°/22°	14°/20°
85 kHz:	11°/15°	10°/14°
153 kHz:	7°/9°	5°/8°
215 kHz:	5°/6°	4°/6°

4.8 Allowable Ship's Speed

20 knot or less (15 knot during raise/lower operation)

4.9 Stabilization

Within 30°, optional motion sensor required

**5. I/O INTERFACE**

5.1 Data Format

IEC61162-1 (NMEA0183 Ver 1.5/2.0)

5.2 Input

DBS, DBT, DPT, GGA, GLL, HDG, HDM, HDT, MDA, MTW, RMA, RMC, VDR, VHW, VTG, att (P sentence)

5.3 Output

SSTLL

**6 POWER SUPPLY**

6.1 MU-100C/Control Unit, Transceiver Unit

12-24 VDC: 7.0-3.5A

6.2 Control Unit, Transceiver Unit

12-24 VDC: 5.0-2.5A

6.3 Hull Unit

12/24 VDC: 4.7/2.3A (16.7/8.2-A, during raising and lowering)

**7. ENVIRONMENTAL CONDITIONS**

7.1 Ambient Temperature

-15°C to +55°C (Soundome: 0°C to +35°C)

7.2 Relative Humidity

Less than 95%

7.3 Waterproofing

Control unit: IPX5  
 Transceiver unit: IPX0  
 Hull unit: IPX2  
 MU-100C: IPX5

7.4 Vibration

2 Hz-5Hz to 13.2 Hz: Amplitude: ±1 mm ±10%  
 13.2 Hz to 100 Hz: Max. acceleration 7m/s<sup>2</sup>, fixed

**8. COATING COLOR**

8.1 Control Unit

Panel: N3.0, Chassis: 2.5GY5/1.5

8.2 Transceiver Unit

2.5GY5/1.5

8.3 MU-100C

Panel: N3.0 Newtone No.5, Chassis: 2.5GY5/1.5

This page is intentionally left blank.

# INDEX

## A

- AGC ..... 5-2
- A-scope display ..... 4-9
- Automatic tilt ..... 2-23

## B

- Background color ..... 5-2
- Backup data
  - loading ..... 5-19
  - saving ..... 5-19
- BRILL control ..... 1-5

## C

- Clutter
  - echosounder mode ..... 4-10
  - horizontal mode ..... 2-22
  - vertical scan mode ..... 3-12
- Color palette ..... 5-18
- Colors
  - background ..... 5-3
  - display ..... 5-3
- COM1 menu ..... 5-1
- COM2 menu ..... 5-3
- Control description ..... 1-1
- Course data ..... 5-11
- Current (tide) data ..... 5-10
- Cursor data
  - echo sounder mode ..... 4-5
  - horizontal mode ..... 2-10
  - vertical scan mode ..... 3-7
- Custom key ..... 5-11
- CUSTOM MODE keys
  - preset function ..... 5-5
  - selection of function ..... 5-4
  - short-cut function ..... 5-7

## D

- Default settings ..... 5-21
- Demonstration mode ..... 5-20
- Depth marker (horizontal mode) ..... 2-12
- Depth marker (vertical scan mode) ..... 3-9
- Diagnostics ..... 6-6
- Display modes
  - combination ..... 1-8
  - dual frequency ..... 1-7
  - single frequency ..... 1-6

## E

- Emphasis ..... 5-12
- Emphasis mode ..... 5-11
- Error messages ..... 6-5

- ES menu ..... 4-10
- ETA marker ..... 5-11
- EVENT key
  - echo sounder mode ..... 4-5
  - horizontal mode ..... 2-11
  - vertical scan mode ..... 3-8
- Event marker
  - deleting from echo sounder display ..... 4-6
  - deleting from horizontal display ..... 2-12
  - deleting from vertical scan display ..... 3-9
  - inscribing from echo sounder display ..... 4-6
  - inscribing from horizontal display ..... 2-11
  - inscribing from vertical scan display ..... 3-8
  - output on/off ..... 5-11

## F

- FAST SCAN key
  - echo sounder mode ..... 4-4
  - horizontal mode ..... 2-9
  - vertical scan mode ..... 3-7
- Frequency selection ..... 1-9
- FULL/HALF key
  - horizontal mode ..... 2-4
  - vertical scan mode ..... 3-5
- Fuse replacement ..... 6-3

## G

- GAIN control ..... 1-13
- Gain setting protection ..... 5-12

## H

- Heading indication ..... 5-11
- Horizontal range (vertical scan mode) ..... 3-13
- Horizontal range marker
  - (vertical scan mode) ..... 3-9
- Horizontal/history display ..... 2-30
- Horizontal/video plotter display ..... 2-31
- HORZ menu ..... 2-22
- Hull unit maintenance ..... 6-2

## I

- Interference rejector
  - echo sounder mode ..... 4-9
  - horizontal mode ..... 2-17
  - vertical scan mode ..... 3-11

## L

- Language ..... 5-19
- LF/HF key ..... 1-9

## INDEX

### **M**

MAIN/SUB key.....	2-31, 3-17
Maintenance	
hull unit.....	6-2
preventive.....	6-1
replacement of fuse.....	6-3
transducer.....	6-3
MENU key.....	1-15
Menu tree.....	1
Mix display.....	1-11
MIX key.....	1-11

### **N**

Navigation data.....	5-11
North marker.....	5-11

### **P**

Position display format.....	5-10
POWER switch.....	1-3
PRESET menu.....	5-5
Pulselength.....	2-14

### **R**

R/B key	
echo sounder mode.....	4-7
horizontal mode.....	2-12
vertical scan mode.....	3-9
Range	
echo sounder mode.....	4-3
horizontal mode.....	2-3
presetting for echo sounder mode.....	5-16
presetting for horizontal mode.....	5-14
presetting for vertical scan mode.....	5-15
track range preset.....	5-17
vertical scan mode.....	3-3
RANGE control	
echo sounder mode.....	4-3
horizontal mode.....	2-3
vertical scan mode.....	3-3
Range marker	
echo sounder mode.....	4-7
Remote controller.....	1-2
Resolution color	
echosounder mode.....	4-10
horizontal mode.....	2-23
vertical scan mode.....	3-12
REVERSE key.....	2-9, 3-7

### **S**

SECTOR control	
horizontal mode.....	2-4
vertical scan mode.....	3-5
SHORT-CUT menu.....	5-7
Signal level.....	5-3
Signal level.....	2-16
Speed alarm.....	5-13
Stabilizer.....	5-12
Sweep indicator.....	5-13
SYSTEM menu.....	5-9
SYSTEM SETTING 1 menu.....	5-10
SYSTEM SETTING 2 menu.....	5-12

### **T**

TARGET key.....	2-19, 2-20
Target lock	
echo mode.....	2-20
manual position mode.....	2-19
selection of mode.....	2-19
Test pattern.....	6-8
TILT control	
echo sounder mode.....	4-4
vertical scan mode.....	3-6
Track	
deleting.....	5-3
on/off.....	5-10
range preset.....	5-17
TRAIN control	
echo sounder mode.....	4-4
horizontal mode.....	2-5
vertical scan mode.....	3-4
Transducer	
automatic retraction.....	5-13
maintenance.....	6-3
Transducer (XDR) switches.....	1-3
Transmitter output power.....	2-13
Troubleshooting.....	6-4
TVG	
echo sounder mode.....	4-7
horizontal mode.....	2-14
vertical scan mode.....	3-10
TVG curve.....	5-11

### **U**

Unit of measurement	
depth.....	5-11
water temperature.....	5-11

### **V**

VERT menu.....	3-12
----------------	------

### **W**

White marker.....	5-3
-------------------	-----

## Free Manuals Download Website

<http://myh66.com>

<http://usermanuals.us>

<http://www.somanuals.com>

<http://www.4manuals.cc>

<http://www.manual-lib.com>

<http://www.404manual.com>

<http://www.luxmanual.com>

<http://aubethermostatmanual.com>

Golf course search by state

<http://golfingnear.com>

Email search by domain

<http://emailbydomain.com>

Auto manuals search

<http://auto.somanuals.com>

TV manuals search

<http://tv.somanuals.com>