

# FURUNO

# OPERATOR'S MANUAL

**COLOR SOUNDER**

---

**MODEL FCV-30**

---



**FURUNO ELECTRIC CO., LTD.**  
NISHINOMIYA, JAPAN



(Elemental Chlorine Free)

The paper used in this manual  
is elemental chlorine free.

© **FURUNO ELECTRIC CO., LTD.**

9-52 Ashihara-cho,  
Nishinomiya 662-8580, JAPAN

Telephone : 0798-65-2111

Fax : 0798-65-4200

FURUNO Authorized Distributor/Dealer

All rights reserved.

Printed in Japan

FIRST EDITION : FEB. 2005

D : MAY. 16, 2006

Pub. No. OME-23730

( DAMI ) FCV-30



\* 0 0 0 1 5 1 8 3 5 0 3 \*



\* O M E 2 3 7 3 0 D 0 0 \*

# IMPORTANT NOTICES

---

- No part of this manual may be copied or reproduced without written permission.
- If this manual is lost or worn, contact your dealer about replacement.
- The contents of this manual and equipment specifications are subject to change without notice.
- The example screens (or illustrations) shown in this manual may not match the screens you see on your display. The screen you see depends on your system configuration and equipment settings.
- This manual is intended for use by native speakers of English.
- FURUNO will assume no responsibility for the damage caused by improper use or modification of the equipment or claims of loss of profit by a third party.
- Dispose of the equipment according to appropriate regulations.



# SAFETY INSTRUCTIONS



## WARNING



### ELECTRICAL SHOCK HAZARD Do not open the equipment.

Only qualified personnel should work inside the equipment.

**Immediately turn off the power at the switchboard if water leaks into the equipment or something is dropped in the equipment.**

Continued use of the equipment can cause fire or electrical shock. Contact a FURUNO agent for service.

**Do not disassemble or modify the equipment.**

Fire, electrical shock or serious injury can result.

**Do not place liquid-filled containers on the top of the equipment.**

Fire or electrical shock can result if a liquid spills into the equipment.

**Immediately turn off the power at the switchboard if the equipment is emitting smoke or fire.**

Continued use of the equipment can cause fire or electrical shock. Contact a FURUNO agent for service.

**Make sure no rain or water splash leaks into the equipment.**

Fire or electrical shock can result if water leaks in the equipment.



## WARNING

**Keep heater away from equipment.**

A heater can melt the equipment's power cord, which can cause fire or electrical shock.

**Use the proper fuse.**

Fuse rating is shown on the equipment. Use of a wrong fuse can result in damage to the equipment.

**Do not operate the equipment with wet hands.**

Electrical shock can result.

### Warning Labels

**Warning labels are attached to the equipment. Do not remove the labels. If a label is missing or damaged, contact a FURUNO agent or dealer about replacement.**

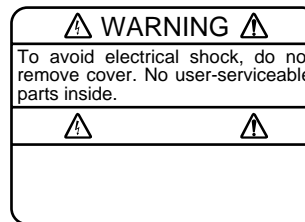

Name: Warning Label (1)  
Type: 86-003-1011-1  
Code No.: 100-236-231  
Location: Processor Unit,  
Junction Box

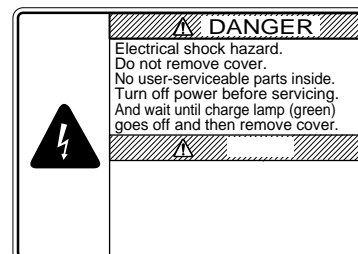

Name: Danger Label  
Type: 10-079-6144  
Code No.: 100-310-880  
Location: Transceiver  
Unit

 **CAUTION**

**Do not transmit when the transducer is out of water.**

The transducer may become damaged.

**The picture does not advance when the picture advance speed is set for "STOP".**

A dangerous situation may result if the vessel is navigated while monitoring the depth indication since it is not updated when the picture is stopped.

**Set the gain properly.**

No picture appears if the gain setting is too low, and noise appears when the gain is too high. If the gain is set improperly, the depth indication may be wrong, resulting in a potentially dangerous situation if the vessel is navigated by monitoring the depth indication.

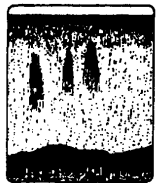

Gain too high



Proper gain



Gain too low

# TABLE OF CONTENTS

---

<b>FOREWORD .....</b>	<b>vi</b>
<b>SYSTEM CONFIGURATION .....</b>	<b>vii</b>
<b>1. OPERATIONAL OVERVIEW .....</b>	<b>1-1</b>
1.1 Controls.....	1-1
1.2 Menu Operation .....	1-2
1.2.1 How to use the main menu .....	1-2
1.2.2 How to use the pop-up menus .....	1-5
1.3 Turning the Power On/Off.....	1-6
1.4 Transmitting, Receiving .....	1-7
1.5 Displays .....	1-8
1.5.1 Choosing a display.....	1-8
1.5.2 Split-beam display.....	1-9
1.5.3 Three-beam display .....	1-10
1.5.4 Split-beam + two-beam display .....	1-11
1.5.5 User 1, User 2, User 3 display .....	1-12
1.6 Choosing a Display Range .....	1-13
1.7 Shifting the Display Range .....	1-15
1.8 Adjusting the Gain .....	1-16
1.9 Find Depth and Position of a Fish Echo.....	1-17
1.10 Inscribing Lines .....	1-18
1.11 Fish Size Histogram .....	1-18
1.12 Setting Measuring Area .....	1-20
1.12.1 Measuring fish in a specific location .....	1-20
1.12.2 Measuring fish in all areas .....	1-21
1.12.3 Measuring fish in a specific depth range .....	1-21
1.12.4 Measuring bottom fish.....	1-21
1.13 Suppressing Low Level Noise (Clutter suppression).....	1-23
1.14 Eliminating Weak Echoes .....	1-24
1.15 Suppressing Unwanted Noise .....	1-24
1.16 Picture Advance Speed .....	1-25
1.17 A-scope Display .....	1-27
1.18 Alarms.....	1-28
1.18.1 Alarm description .....	1-28
1.18.2 Enabling, disabling an alarm .....	1-29
1.18.3 Setting audio alarm volume.....	1-30
1.19 Function Keys .....	1-31
1.19.1 Using the function keys.....	1-31
1.19.2 Programming the function keys.....	1-31
1.20 Saving, Recalling User Settings .....	1-32
1.20.1 Saving user settings.....	1-32
1.20.2 Loading user settings.....	1-33
1.21 Recording, Replaying Data.....	1-35
1.21.1 Choosing where to record data .....	1-35
1.21.2 Recording data.....	1-37

1.21.3	Converting recorded data to HAC format.....	1-38
1.21.4	Playing back data .....	1-39
1.21.5	Saving screen shot.....	1-41
1.21.6	Loading a screen shot .....	1-42
<b>2.</b>	<b>WINDOW DISPLAYS.....</b>	<b>2-1</b>
2.1	Turning on Window Displays.....	2-1
2.2	Interpreting the Window Displays.....	2-3
2.2.1	Status window .....	2-3
2.2.2	Fish size histogram window.....	2-6
2.2.3	Target graph window .....	2-8
2.2.4	V-temperature graph window.....	2-10
2.2.5	Bottom-lock zoom window.....	2-11
2.2.6	Bottom zoom window .....	2-12
2.2.7	Marker zoom window.....	2-13
2.2.8	Bottom discrimination graph window .....	2-14
<b>3.</b>	<b>CHANGING SETTINGS .....</b>	<b>3-1</b>
3.1	Mode Dialog Box .....	3-1
3.2	Display Item Dialog Box.....	3-3
3.3	Echo Image Dialog Box .....	3-4
3.4	Multi beam Dialog Box.....	3-6
3.5	Temp Dialog Box.....	3-7
3.6	Color Dialog Box.....	3-8
3.7	Unit Dialog Box.....	3-10
3.8	Target Sphere Calibration Dialog Box .....	3-11
3.9	External Echo Sounder .....	3-13
3.9.1	Displaying image from external echo sounder .....	3-13
3.9.2	File menu .....	3-14
3.9.3	Display menu .....	3-15
3.9.4	Setting menu .....	3-17
3.9.5	System menu .....	3-19
<b>4.</b>	<b>MAINTENANCE &amp; TROUBLESHOOTING .....</b>	<b>4-1</b>
4.1	Maintenance .....	4-1
4.1.1	Check points.....	4-1
4.1.2	Cleaning.....	4-1
4.1.3	Replacing fuses.....	4-2
4.1.4	Transducer .....	4-2
4.1.5	Trackball.....	4-3
4.2	Troubleshooting .....	4-4
4.3	Restoring Default Settings .....	4-5
4.4	Finding Software Version .....	4-6
<b>APPENDIX .....</b>	<b>AP-1</b>	
Menu Tree.....	AP-1	
Screen Division.....	AP-7	
<b>SPECIFICATIONS.....</b>	<b>SP-1</b>	
<b>INDEX.....</b>	<b>IN-1</b>	

# FOREWORD

---

## Introduction

FURUNO Electric Company thanks you for considering and purchasing the FCV-30 Color Sounder. We are confident you will discover why the FURUNO name has become synonymous with quality and reliability.

For over 50 years FURUNO Electric Company has enjoyed an enviable reputation for quality and reliability throughout the world. This dedication to excellence is furthered by our extensive global network of agents and dealers.

Your equipment is designed and constructed to meet the rigorous demands of the marine environment. However, no machine can perform its intended function unless properly installed and maintained. Please carefully read and follow the operation and maintenance procedures set forth in this manual.

We would appreciate feedback from you, the end-user, about whether we are achieving our purposes.

Thank you for considering and purchasing FURUNO.

## Features

The FCV-30 is a high-performance echo sounder designed for fishing as well as oceanographic research. Its newly developed multi-beam transducer provides multi-directional and long-range detection. Consisting of a processor unit, control unit, transceiver unit and transducer, the FCV-30 provides high definition underwater images on the monitor of your choice.

The main features of the FCV-30 are

- Stabilization compensation in all directions (all directions  $\pm 20^\circ$ ) provides stable images in rough seas.
- Fish distribution and size can easily be found using the fish histogram display.
- Detection in multi-direction or desired direction to help discern fish school density.
- Target graph lets you monitor fish movement.
- Bottom hardness and roughness graph provides intuitive data on bottom composition.
- User programmable display (three types) divides the screen in two, three, four or five displays.
- Various alarms: bottom, bottom fish, fish, temperature, vertical temperature. (Temperature alarms requires appropriate sensor. The vertical temperature alarm additionally requires a net sonde or trawl sonar.)
- USB port provided to save data to USB hard disk.



# SYSTEM CONFIGURATION

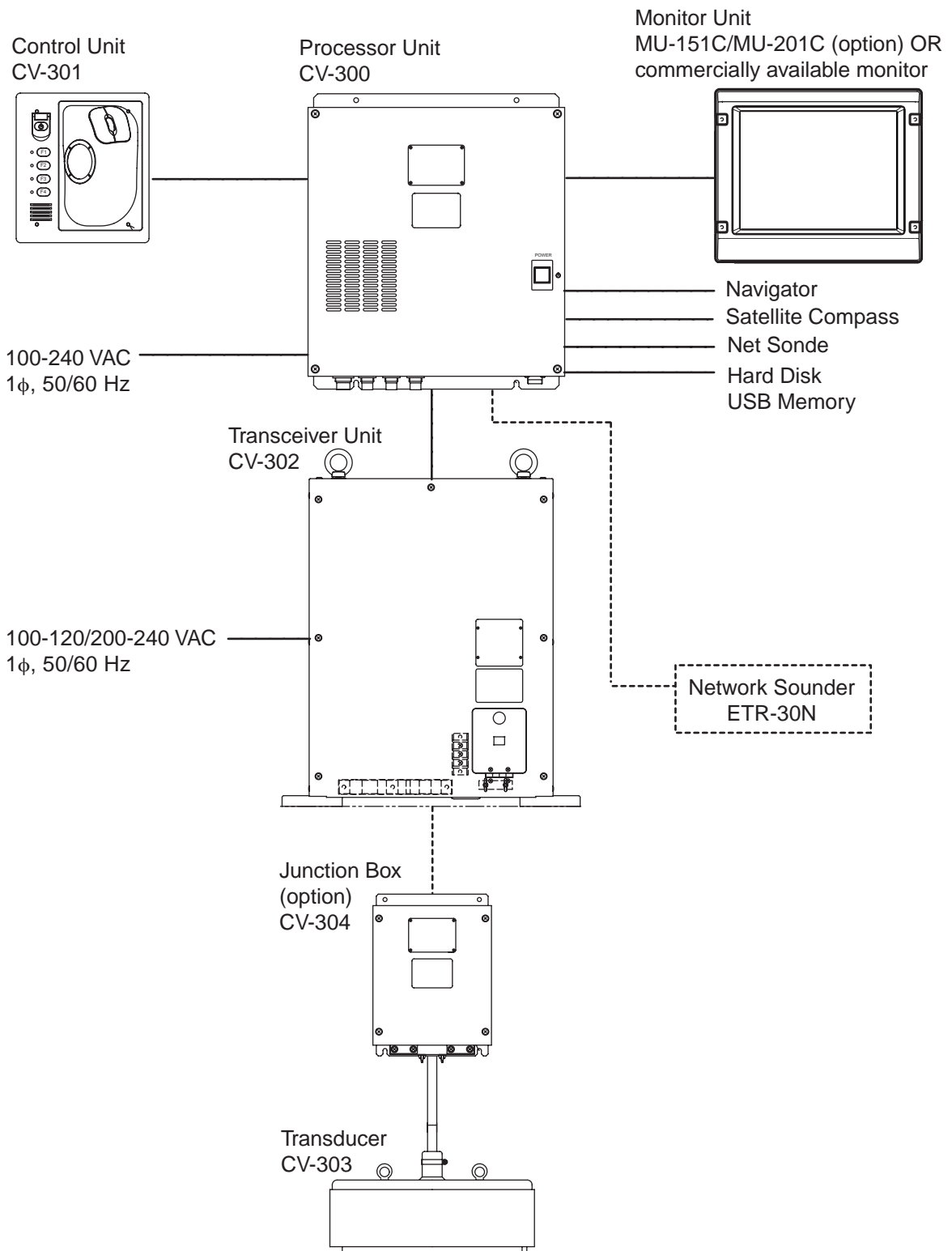

*System configuration*

This page intentionally left blank.

# 1. OPERATIONAL OVERVIEW

---

## 1.1 Controls

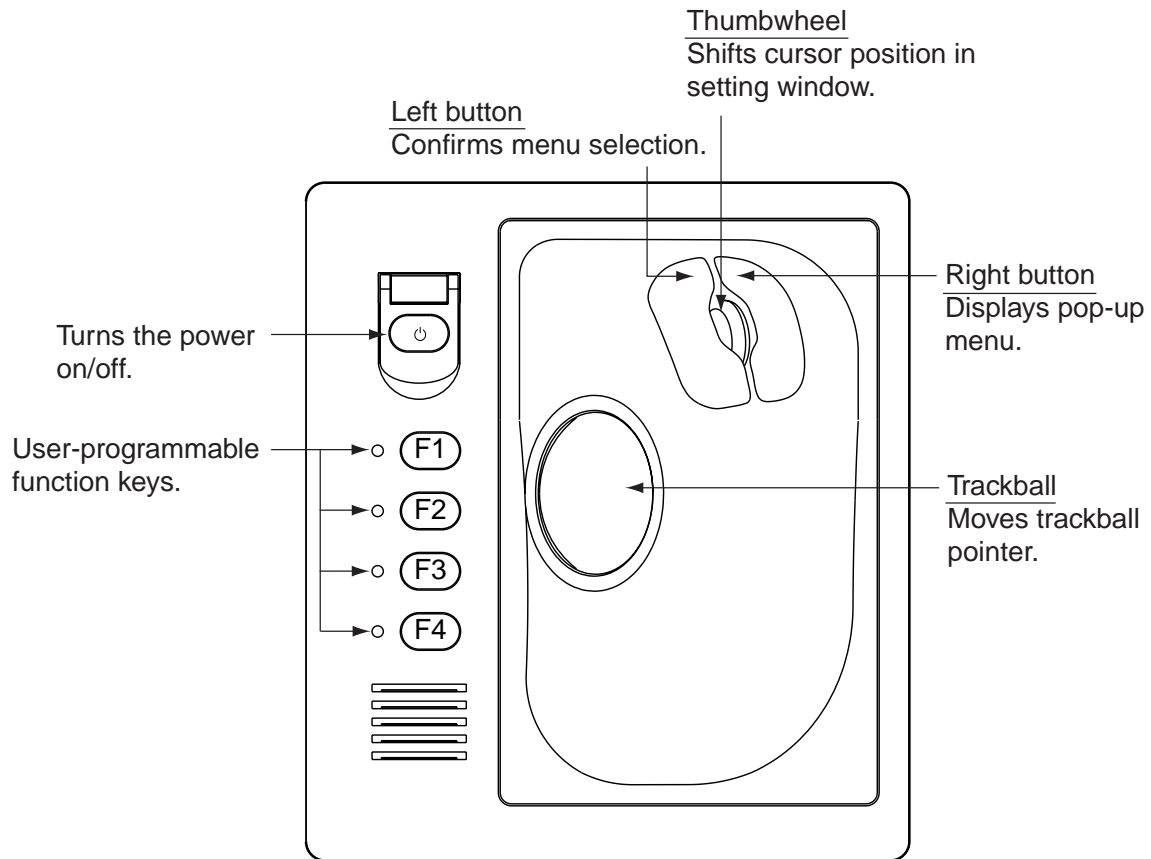

*Control unit*

## 1.2 Menu Operation

The FCV-30 is controlled from a menu system. Two types of menus are available:

Main menu: All menu options are contained in pull-down menus.

Pop-up menu: Contains most frequently used menu functions.

### 1.2.1 How to use the main menu

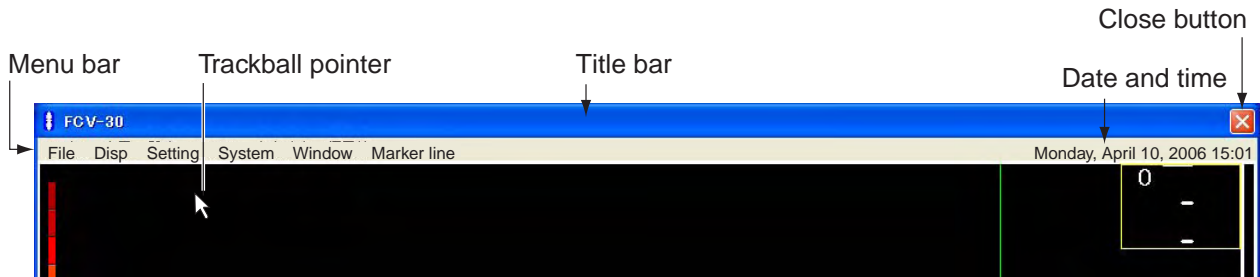

*Menu bar*

1. Roll the trackball to choose menu desired (File, Disp, Setting, System, etc.) from the menu bar at the top of the screen and the click it with the left button.

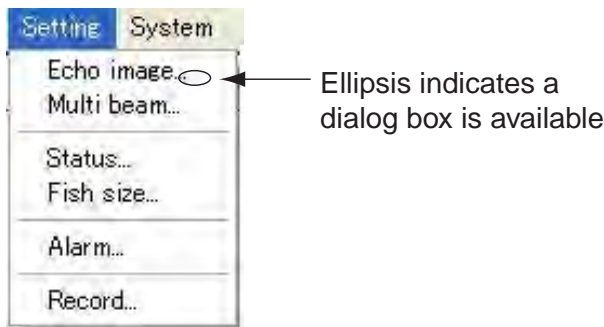

*Setting menu*

2. Roll the trackball to choose menu item desired and then click with the left button. A menu item which contains an ellipsis (...) indicates a dialog box is available.

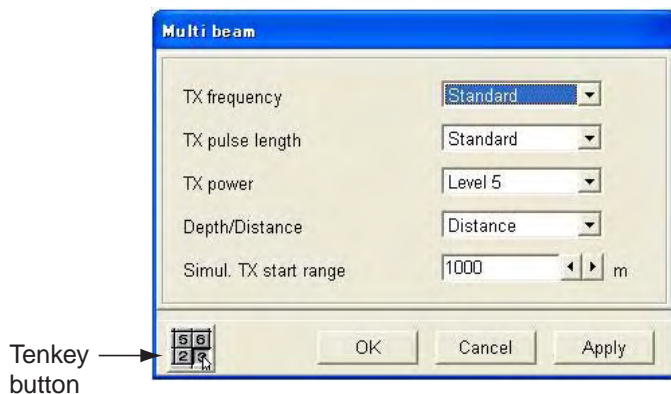

*Multi beam dialog box*

3. Change settings as appropriate, referring to the information below.
4. After changing settings, roll the trackball to place the pointer on the OK button and then push the left button to save settings and close the dialog box. (See Note 3 below.)

**Note 1:** To restore previous settings, click the Cancel button instead of the OK button at step 4.

**Note 2:** To see the result of a change without closing a dialog box, click the Apply button.

**Note 3:** Unless otherwise noted, the phrase “click...” means to click the object with the left mouse button.

### **Changing setting using radio buttons**

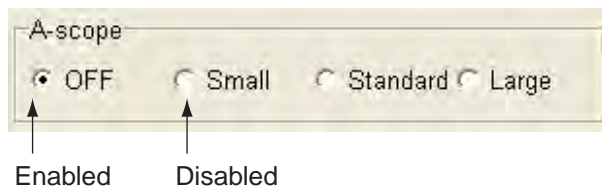

*Radio buttons*

Click the item desired. A black dot appears when the item selected is enabled.

### **Changing setting using a list box**

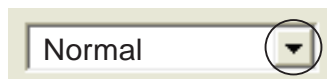

*List box*

1. Click ▼ in the list box or click the box itself to show a list of options.
2. Click the desired setting.

### **Changing setting using a spin box**



*Spin box*

A setting may be changed from a spin box two ways depending on contents of the spin box:

- 1) Click ◀ or ▶ successively in the spin box to choose the setting desired. Each click increments the setting downward or upward depending on arrow clicked.
- 2) Spin the thumbwheel to choose value with the cursor.

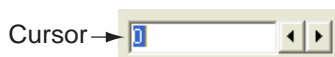

*Spin box*

Place the pointer on the “tenkey” button (  ) at the lower left-hand corner and then push the left button to show the tenkey panel.

## 1. OPERATIONAL OVERVIEW



### *Tenkey panel*

Place the cursor on the desired numeric key and then push the left button. Repeat to enter all data required.

### **Changing setting using a check box**

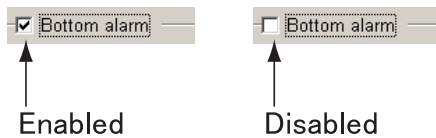

1. Place the pointer on the check box of the item you want to enable or disable.
2. Push the left button to remove or insert the check mark as appropriate. An item is enabled when the check mark is present.

### **Changing setting using a toggle button**



1. Click the item desired.
2. Each click enables or disables your selection alternately. When the item selected is enabled it is highlighted in dark blue and when disabled it is colored gray.

## 1.2.2 How to use the pop-up menus

1. Right-click anywhere on the screen, and a pop-up menu appears.

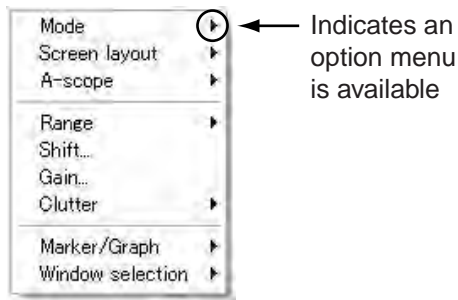

### Pop-up menu

2. Click the item desired. An item with ► indicates an option window; "..." (ellipsis) a setting window. Currently selected option is marked with a filled circle.

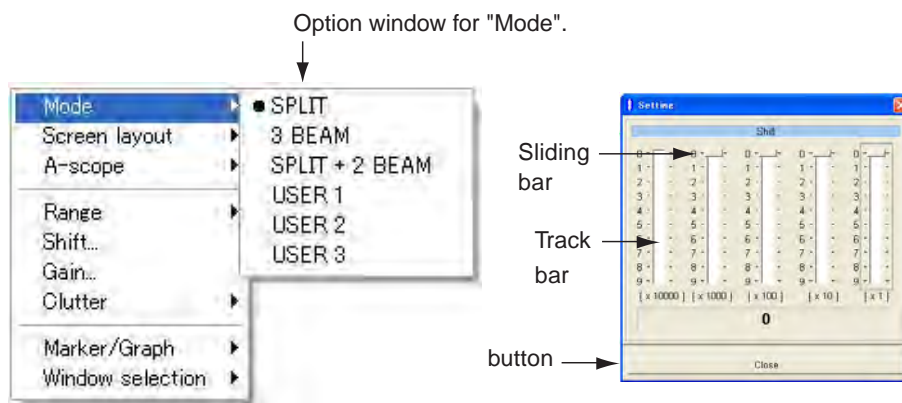

### Pop-up menu and shift setting window

3. Do one of the following according to item selected.

#### Operation from an options window

Roll the trackball to execute appropriate operation and then push the left button.

#### Operation from a setting window

There are three settings methods:

- Drag the sliding bar: Place the pointer on the sliding bar and hold down the left button while rolling the trackball.
- Place the pointer on the track bar and then click with the left button
- With the track bar selected, spin the thumbwheel and roll the thumbwheel downward to increment figure upward; upward to increment figure downward. If the drag bar is not selected, place the pointer on it and push the left button.

Finally, click the Close button.

## 1.3 Turning the Power On/Off

### Turning on the power

1. Turn on the monitor.
2. Open the power switch cover on the Control Unit and push the  switch. The power comes on, Windows®\* starts up, the FCV30 application launches and then the last-used display appears.





Windows is the registered trademark of Microsoft, Inc.

Note that the Windows® Help feature is not available with this equipment.

### Turning off the power

There are two methods to turn off the power.

- a) Press the  switch. **Do not press the switch more than four seconds; last-used settings will not be memorized.**
- b) Click the close button (). The following window appears. Then, click the Yes button to quit.

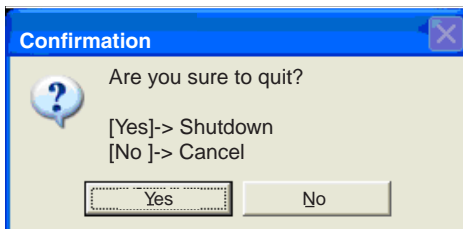

*Shutdown confirmation window*

**Note:** Power is automatically turned off anytime the processor unit is disconnected from the control unit.



## 1.4 Transmitting, Receiving

Follow the procedure below to start transmitting and receiving, after turning on the power.

1. Click File.

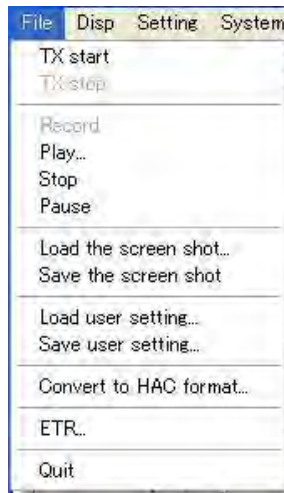

### *File menu*

2. Click TX Start. Transmission starts and images from underwater appear.

To stop transmission, choose TX Stop at step 2. It is recommended that, after stopping transmission, wait three seconds before using the menu.

## 1.5 Displays

### 1.5.1 Choosing a display

Six display modes are available. Choose the display mode which matches your current needs.

1. Click Disp.



#### *Disp menu*

2. Click Mode.

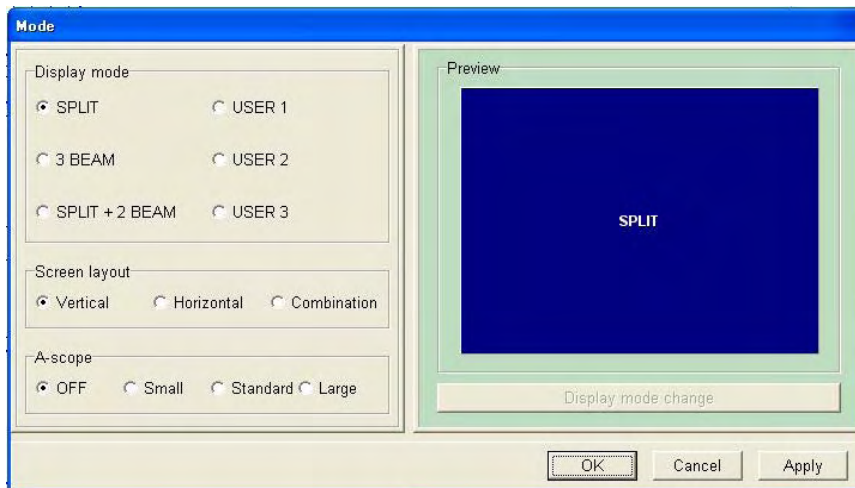

#### *Mode dialog box*

3. In the Display Mode window choose the mode you wish to use. See the next several sections for display descriptions. To divide the screen, go to step 4. Otherwise go to step 5.
4. In the Screen Layout window, click the screen division you wish to use. The Preview window shows the results of your selection. Note that the split-beam display cannot be divided.
5. Click the OK button to finish.

### 1.5.2 Split-beam display

The split-beam display shows the underwater images captured with the split-beam. With display of appropriate window you can discern single fish distribution (with the fish size histogram) and monitor fish movement (with the target graph).

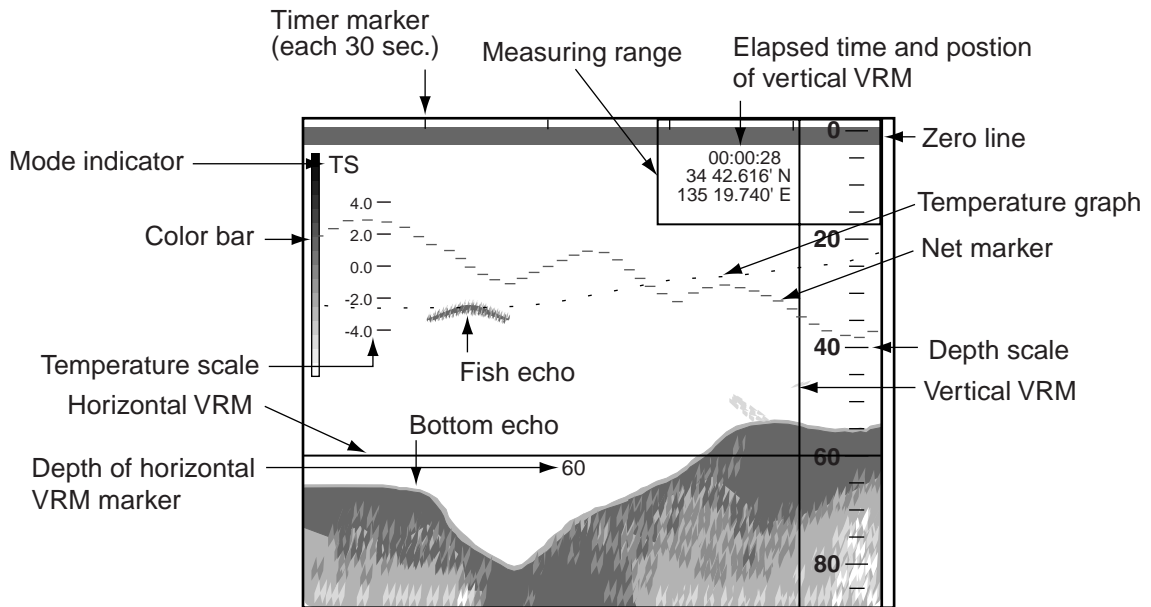

*Split-beam display*

**Note:** When the display range for the split-beam presentation is 500 m or higher, the indication “Deep mode” appears in the menu bar. To enable deep mode detection, click Deep Mode on the menu bar followed by clicking ON. The default deep mode detection range is 500 m. For further details, contact your dealer.

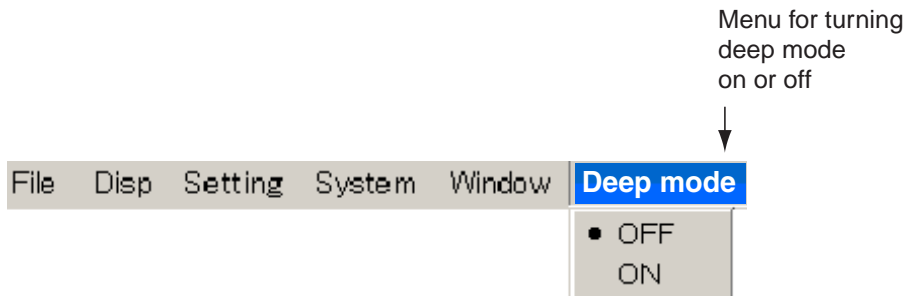

*Deep mode detection options*

## 1. OPERATIONAL OVERVIEW

### 1.5.3 Three-beam display

The three-beam display shows the images captured from the port, downward and starboard directions.

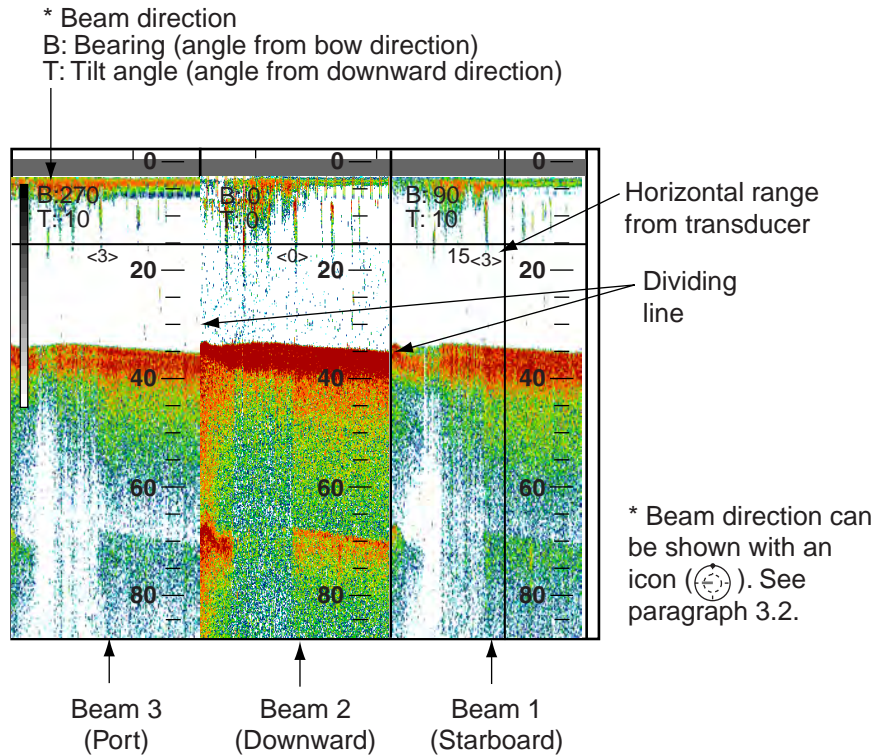

*Three-beam display*

#### Changing display area

The width of each display can be adjusted as follows:

1. Place the trackball pointer on a dividing line between displays, and the pointer changes to a double-ended arrow (↔).
2. Hold the left button while dragging the double-ended arrow with the trackball to adjust width.

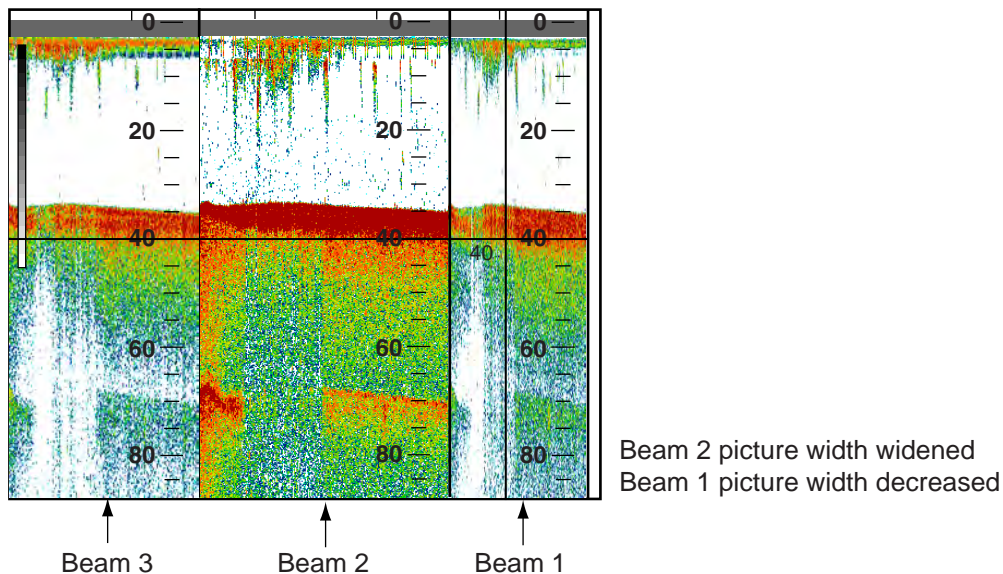

**Note:** Normally, pulses are fired from beam 1, beam 2 and beam 3 in that order and displayed on the screen as the port, downward and starboard images. When the display range of the 3-beam display is higher than 1000 m, the menu bar shows “Simul. TX”. To fire pulses from beam 1 – 3 simultaneously click the Simul TX indication to show ON. When this is done the picture advance speed quickens. However, the display becomes susceptible to unwanted echoes. The default Simul TX detection range is 1000 m. This value can be set between 100 and 5000 m. For further details, see page 3-6.

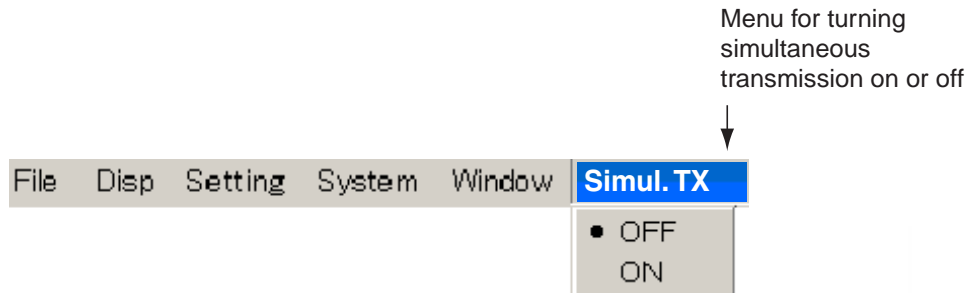

### *Simultaneous transmission options*

## 1.5.4 Split-beam + two-beam display

The split-beam + two-beam display provides a split-beam plus images captured from the port and starboard sides.

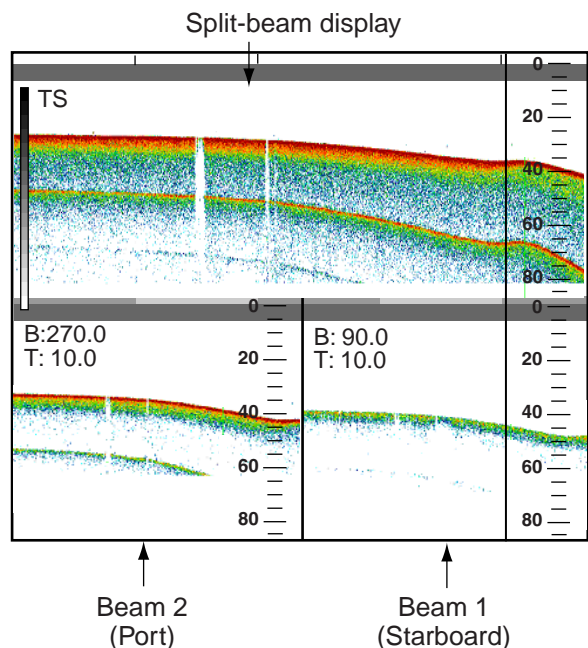

### *Split-beam + two-beam display*

**Note:** When the display range for the split beam + two beam presentation is 1000 m or higher, “Deep Mode” and “Simul Tx” appear in the menu bar. To enable the deep mode or simultaneous transmission, click the appropriate item on the menu bar followed by clicking ON.

## 1. OPERATIONAL OVERVIEW

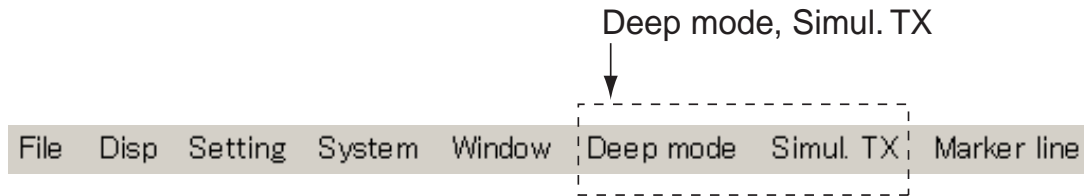

*Menu bar*

### **1.5.5 User 1, User 2, User 3 display**

These displays show the product of displays created with “Display mode change” button in the Mode window. The default settings are as follows:

User 1: Split beam display

User 2: 3-beam (port, starboard and downward directions)

User 3: Split beam + two-beam (port and starboard directions)

For how to customize the User displays see paragraph 3.1.

## 1.6 Choosing a Display Range

Choose the detection range (from the transducer to the bottom), in 12 preset choices. The default ranges are shown in the table below.

*Display ranges*

Unit	Display Range											
	1	2	3	4	5	6	7	8	9	10	11	12
m	10	20	40	80	150	300	500	1000	1500	2000	2500	3000

**Note:** You may set ranges as desired. For further details, see Chapter 3.

1. Click Setting.



*Setting menu*

2. Click Echo image.

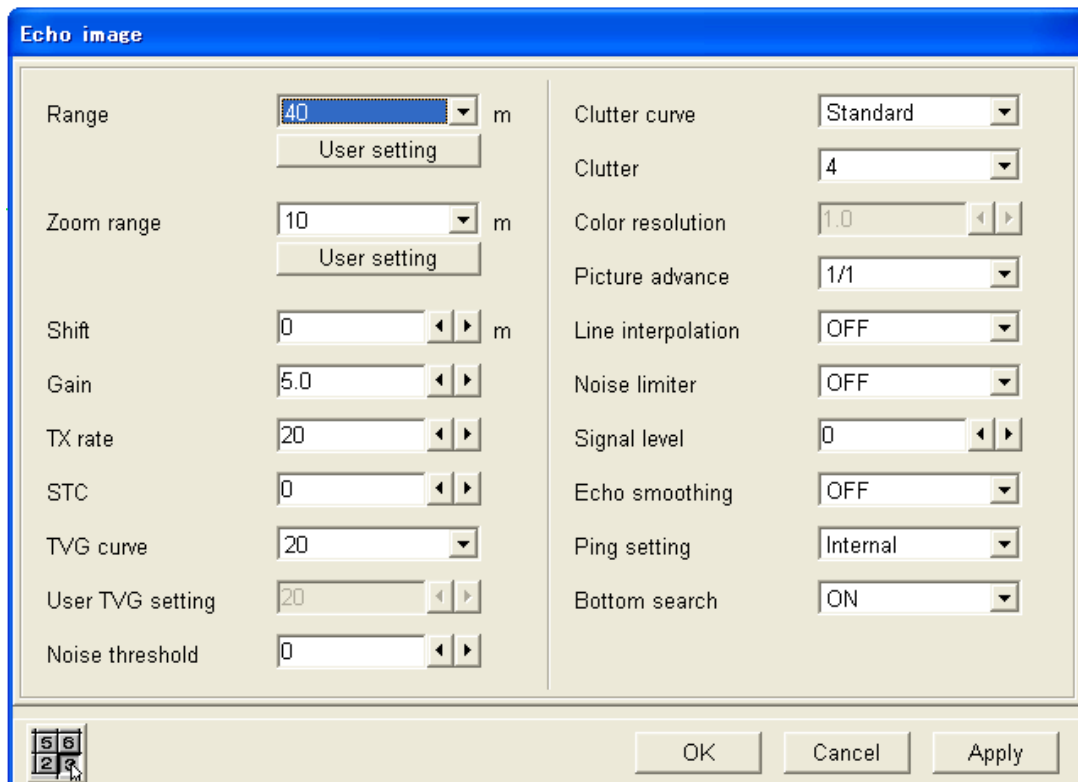

*Echo image dialog box*

## 1. OPERATIONAL OVERVIEW

3. Click ▼ in the Range box.

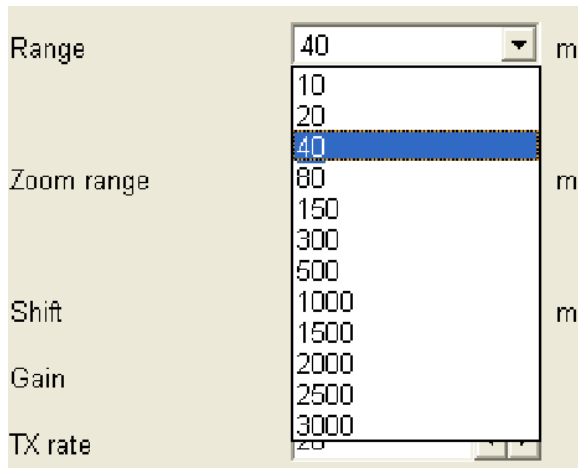

### *Range options*

4. Click the range you wish to use. For example, choosing “80”, the display will show underwater conditions from the transducer down to 80 m.
5. Click the OK button.



## 1.7 Shifting the Display Range

You may shift the display in order to look at a shallower or deeper depth without changing the current range.

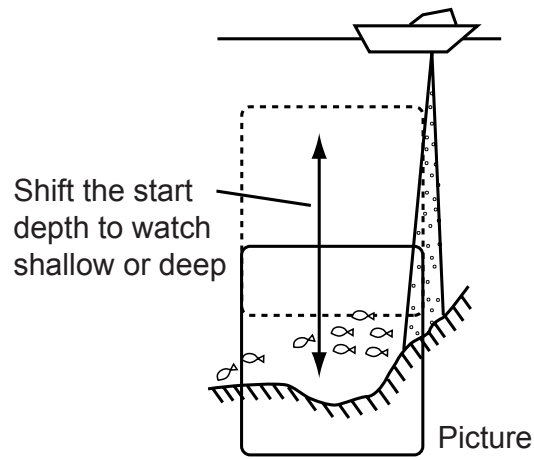

### *Shift principle*

1. Click Setting.
2. Click Echo image.
3. Click ◀ or ▶ in the Shift box to choose shift value.
4. Click the OK button.

## 1.8 Adjusting the Gain

Adjust the gain according to signal strength. Adjust so noise just disappears from the screen.

 <b>CAUTION</b>
<b>Use the proper gain setting.</b>  Incorrect gain may produce wrong depth indication, possibly resulting in a dangerous situation.

1. Click Setting.
2. Click Echo image.
3. Click ◀ or ▶ in the Gain box to choose the gain setting desired.

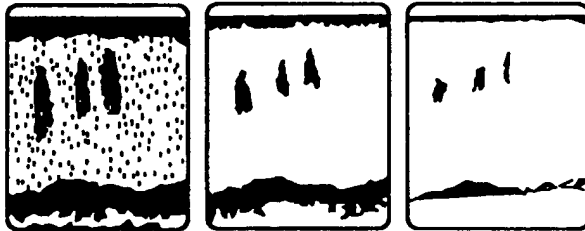

Gain too high

Gain proper

Gain too low

*Examples of gain settings and resulting pictures*

4. Click the OK button.

## 1.9 Find Depth and Position of a Fish Echo

You may measure the depth to a fish school or bottom with the horizontal line marker, called the horizontal VRM (Variable Range Marker) marker. Further, you may measure elapsed time with the vertical VRM. For example, you can measure how many minutes before the current time a fish echo appeared.

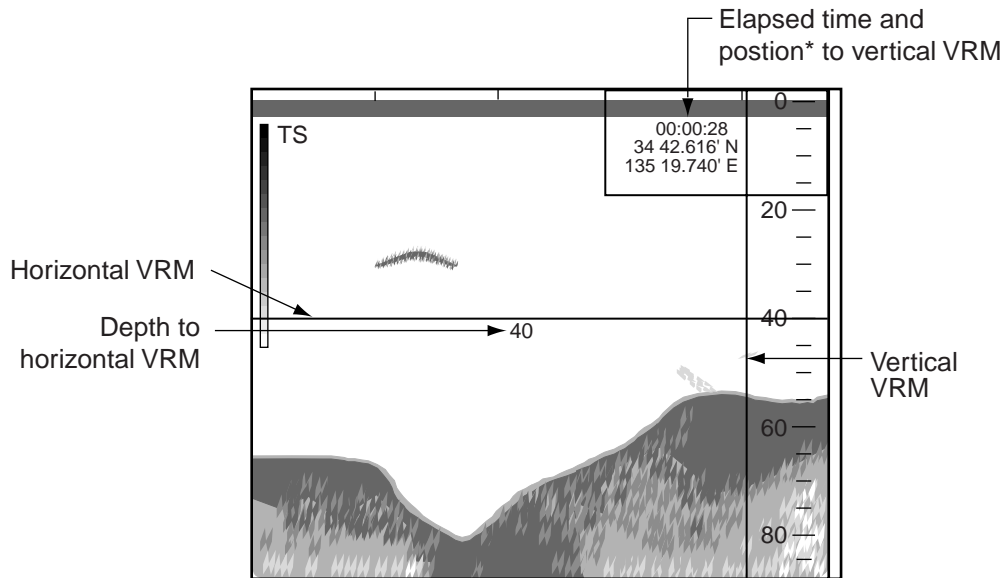

\* Position shown in red when position data is lost.

### *Measuring depth, elapsed time and position with the VRMs*

#### **Measuring depth**

1. Roll the trackball to place the pointer on the horizontal VRM. The shape of the pointer changes to (↓).
2. Hold down the left button while rolling the trackball upward or downward to place the horizontal VRM on the object that you wish to measure the depth.
3. Read the depth indication (on the horizontal VRM).

#### **Measuring elapsed time**

1. Roll the trackball to place the pointer on the vertical VRM.
2. Hold down the left button while rolling the trackball leftward or rightward to place the VRM on the object that you wish to find position.
3. Read the elapsed time and position (on the vertical VRM).

**Note 1:** The color of the VRMs can be changed. See paragraph 3.5

**Note 2:** You may change the location of the depth indication on the horizontal VRM. For further details see paragraph 3.2.

## 1.10 Inscribing Lines

You may inscribe vertical lines on the display to mark fish schools, shoals, etc.

When an echo of interest appears, click Marker line on the menu bar to inscribe a vertical line on the display. If TIMER is turned on in the Status window, elapsed time is counted from the moment the mark is inscribed.

Note that color of the marker line can be changed. For details, see paragraph 3.5.

## 1.11 Fish Size Histogram

The fish size histogram display shows single fish size within the area measured. You may set up this display as follows:

1. Display the split-beam display. See paragraph 1.5.
2. Click Disp.
3. Click Display Window.

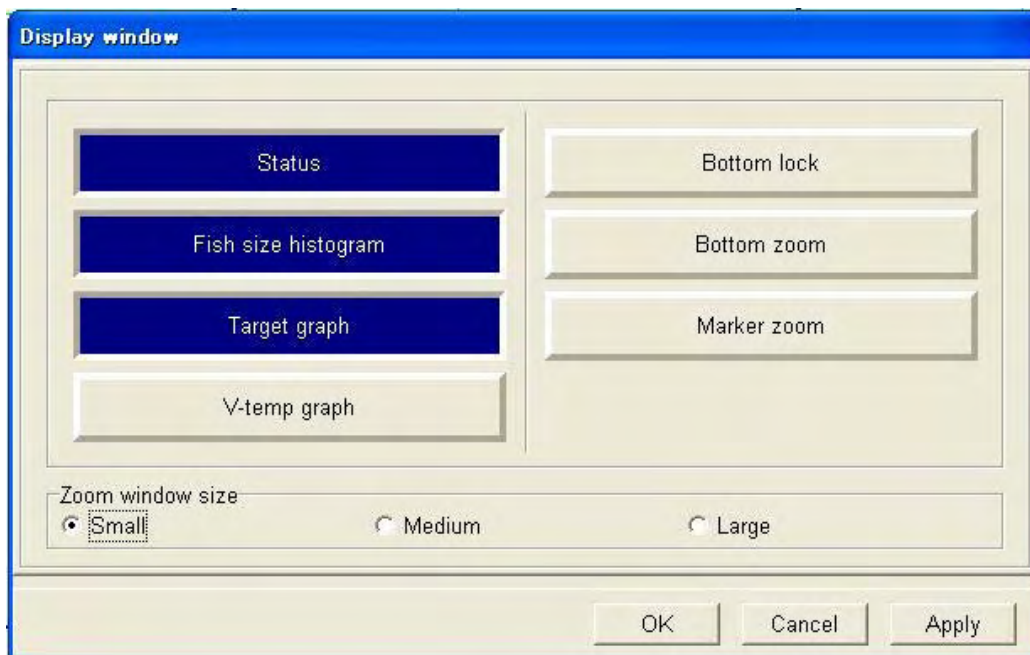

*Display window dialog box*

4. Click Fish size histogram. The toggle button is then colored in purple (ON state). Each click turns the display on or off alternately.
5. Click the OK button. The fish size histogram appears and measuring begins.

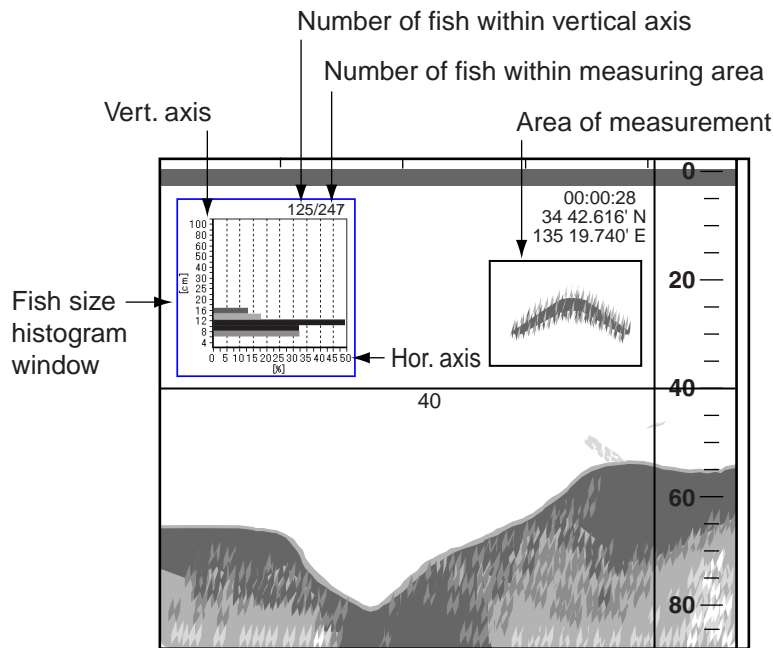

*Fish size histogram window*

**Note 1:** The fish size histogram window can be moved as desired. For details, see Chapter 2.

**Note 2:** When the fish size histogram window is closed, all data measured is deleted.

**How to read the fish histogram**

The bar graph shows size and proportion of fish in measuring area. The vertical axis shows fish length (default setting) and the horizontal axis shows distribution. In the fish size histogram display above, more than 50% of the fish in the measuring area are 10 cm in length.

## 1.12 Setting Measuring Area

There are four ways to set the measurement area for the fish size histogram:

- Measure fish at specific location
- Measuring depth shallower than bottom in all directions
- Measure specific depth range
- Measure bottom fish

### 1.12.1 Measuring fish in a specific location

1. Click Setting.
2. Click Fish size. Click the Fish size histogram tab if necessary to show the fish size dialog box.

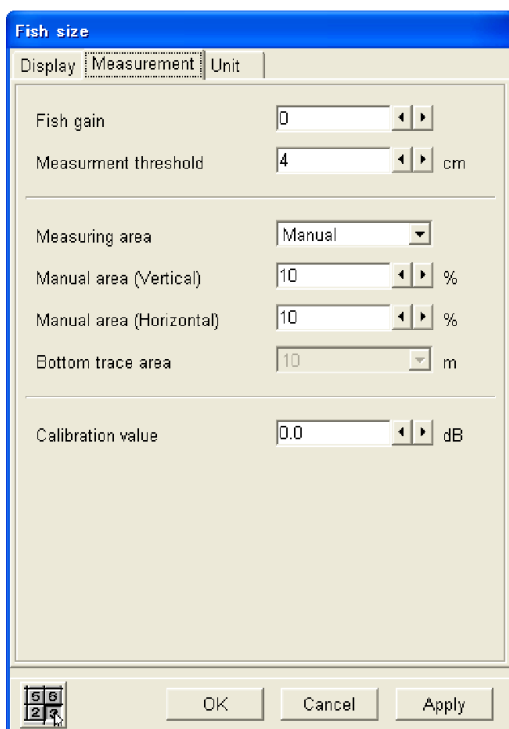

*Fish size dialog box, measurement*

If the Unit or Display dialog box is shown, click the Measurement tab.

3. Click ▼ in the Measuring area box.

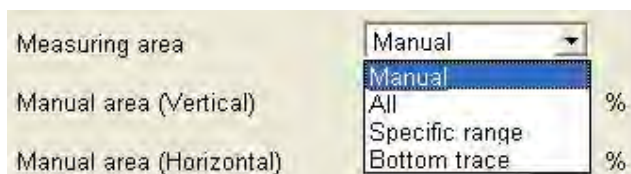

*Area options*

4. Click Manual.

5. Click ◀ or ▶ in the Area Vertical box to set the vertical width of the area marker. (Setting range: 10-100(%)). Represents the percentage of the vertical width of the fish histogram display.
6. Click ◀ or ▶ in the Area Horizontal box to set the horizontal width of the area marker. (Setting range: 10-100(%)). Represents the percentage of the horizontal width of the fish histogram display.
7. Click the OK button.
8. Use the trackball to place the pointer on the area marker (yellow frame). The shape of the pointer changes to (↕).
9. Hold down the left button while using the trackball to position the marker.

### 1.12.2 Measuring fish in all areas

1. Click Setting.
2. Click Fish size.
3. Click ▼ in the Measuring area box.
4. Click All.
5. Click the OK button.

### 1.12.3 Measuring fish in a specific depth range

1. Click Setting.
2. Click Fish size.
3. Click ▼ in the Measuring area box.
4. Click Specific range.
5. Click the OK button.
6. Use the trackball to place the pointer on the measurement area boundary line.
7. Hold down the left button while rolling the trackball upward or downward to position the boundary line where desired.

### 1.12.4 Measuring bottom fish

1. Click Setting.
2. Click Fish size.
3. Click ▼ in the Measuring area box.
4. Click Bottom trace.
5. Click ▼ in the Bottom trace area box.

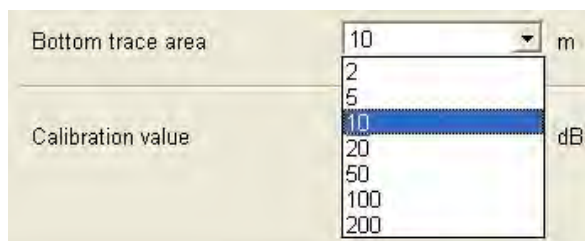

6. Click measurement range desired. The measurement range starts from the bottom.
7. Click the OK button Measurement range markers (1) and (2) appear as in the figure at the top of the next page.

## 1. OPERATIONAL OVERVIEW

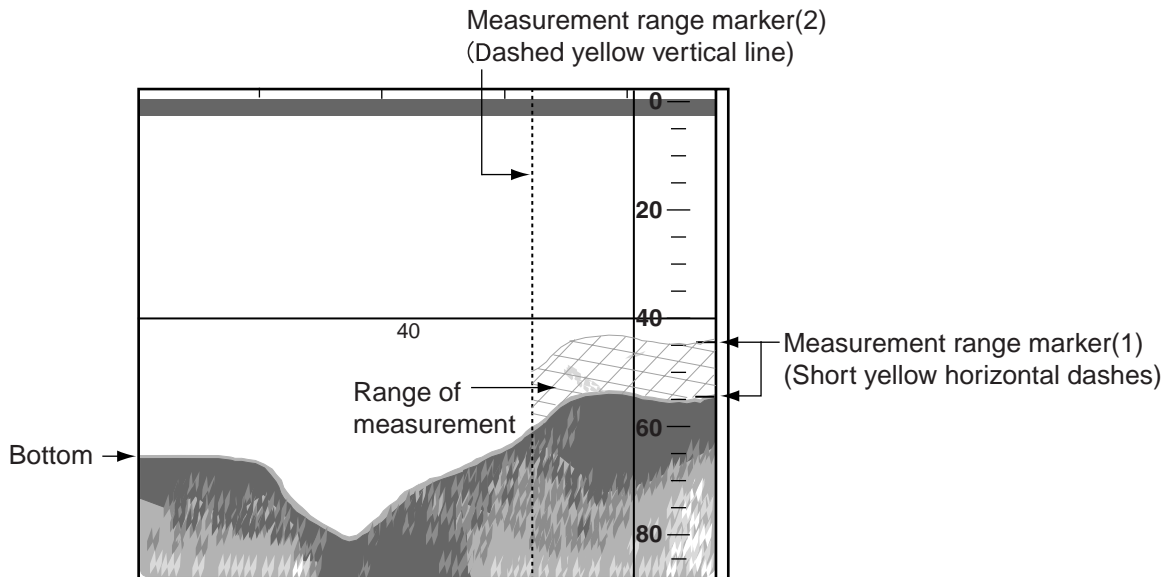

### *Measurement range markers on the fish size display*

8. Place the cursor on the measurement range marker(2) (yellow vertical line). The shape of the cursor changes from an arrow (↔) to double-ended arrow (↔)
9. Using the left button, drag the measurement range marker(2) to the location desired and release the left button. Measurement range marker(1) (short yellow horizontal dash) automatically traces the bottom.



## 1.13 Suppressing Low Level Noise (Clutter suppression)

Light-blue dots may appear over most of screen. This is mainly due to dirty water or noise. This noise can be suppressed by adjusting the Clutter suppression function.

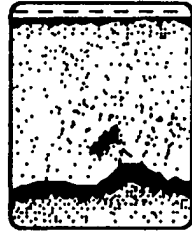

*Appearance of clutter on the display*

1. Click Settings.
2. Click Echo image.
3. Click ▼ in the Clutter curve box.

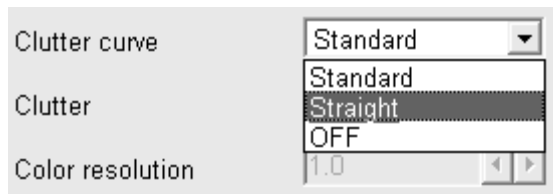

### *Clutter curve options*

4. Click the setting desired, referring to the description below.

**Standard:** With “high” clutter level setting, strong colors are untouched while weak echo colors are suppressed.

**Straight:** With “high” clutter level setting, weak-to-strong echoes are suppressed by averaging.

**OFF:** Clutter suppression function is disabled.

5. Click ▼ in the Clutter box.

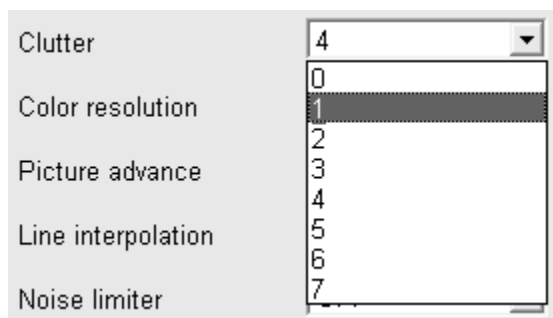

### *Clutter options*

6. Click the setting desired.
7. Click the OK button.

## 1.14 Eliminating Weak Echoes

Sedimented water or reflections from plankton may be painted on the display in green or light-blue. These weak echoes may be erased with the signal level function.

1. Click Settings.
2. Click Echo image.
3. Click ◀ or ▶ in the Signal level box to choose the echo strength you wish to erase. The higher the number the stronger the echo that will be erased.
4. Click OK button.

## 1.15 Suppressing Unwanted Noise

Noise from other echo sounder or electrical interference may show itself on the screen. Use the noise limiter to suppress unwanted noise.



Interference from other sounder

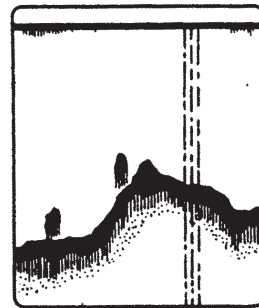

Electrical interference

### *Examples of noise*

1. Click Setting.
2. Click Echo image.
3. Click ▼ in the Noise limiter box.

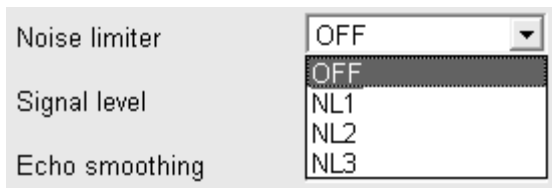

### *Noise limiter options*

4. Click the setting desired. The higher the number the greater the degree of suppression. Choose OFF when no noise exists, so as not to miss small targets.
5. Click the OK button.

## 1.16 Picture Advance Speed

The picture advance speed determines how quickly the vertical scan lines run across the screen. When selecting a picture advance speed, keep in mind that a fast advance speed will expand the size of the fish school horizontally on the screen and a slow advance speed will contract it.

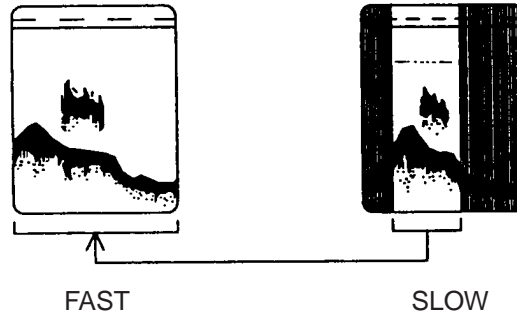

The advancement speed may be set independent of or synchronized with ship's speed.

1. Click Settings.
2. Click Echo image.
3. Click ▼ in the Picture advance box. The fractions in the window denote the number of scan lines produced per transmission. For example, 1/8 means one scan line is produced every eight transmissions. STOP freezes the display and it is convenient for observing an echo. SYNC advances the picture according to ship's speed. See the next page.

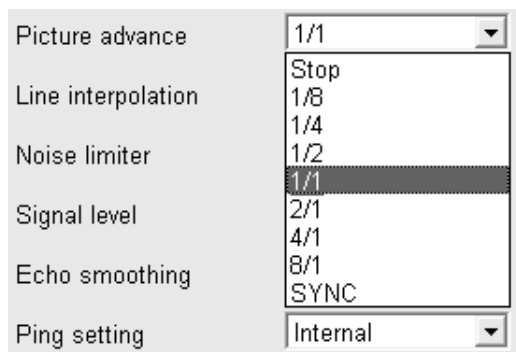

### *Picture advance options*

4. Click the setting desired.
5. Click the OK button.

**Ship's speed dependent picture advance**

With speed data provided by a speed-measuring device, picture advance speed may be set according to ship's speed, the ship's speed dependent mode. As shown in the figure below the horizontal scale of the display is not influenced by the change of ship's speed, thus the speed-dependent picture advance permits judgment of fish school size and abundance at any speed.

**Note:** This feature is available with ship's speed between 2 and 20 kts. If ship's speed is above or below those values, the picture is advanced using the upper or lower limit whichever is closest to the actual ship's speed.

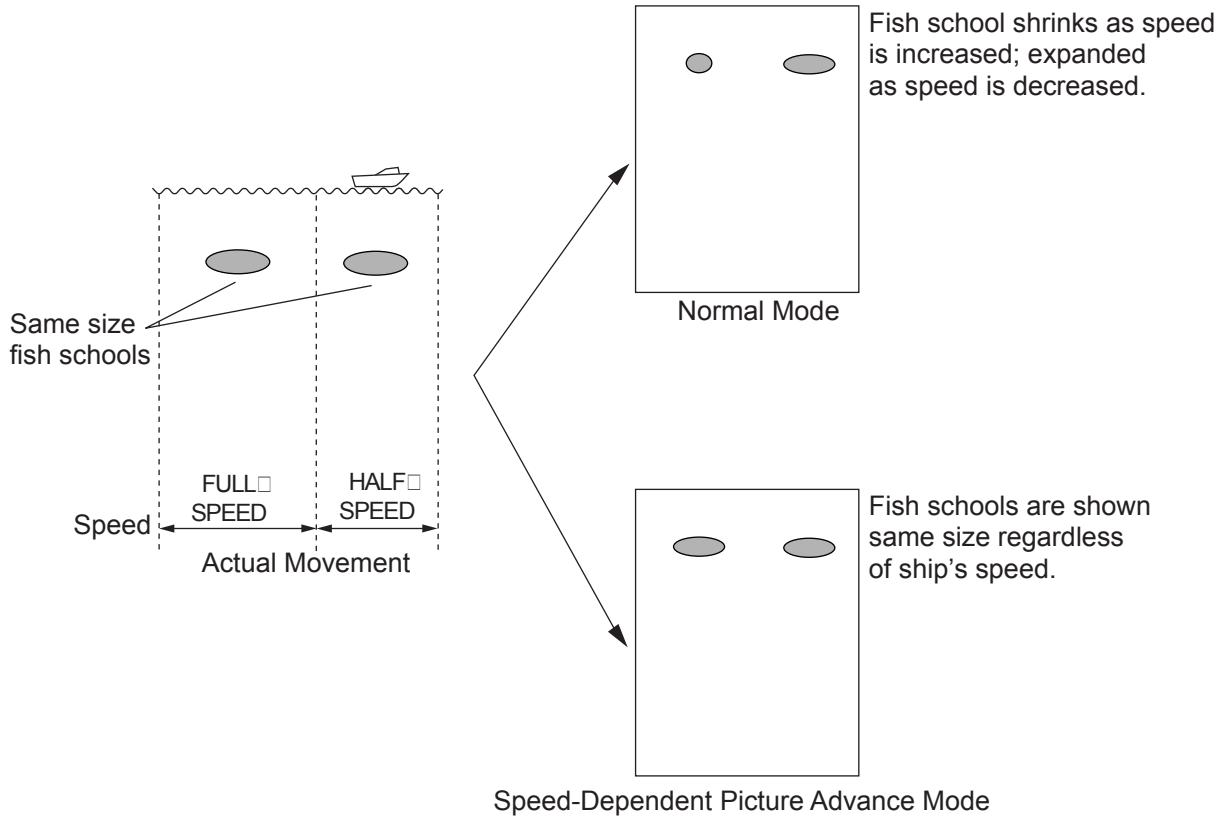

*How the ship's speed dependent picture advance mode works*

## 1.17 A-scope Display

The A-scope display shows echoes at least at each transmission with amplitudes and tone proportional to their intensities. It is useful for estimating fish species and bottom composition.

1. Click Disp.
2. Click Mode.
3. Use the trackball to choose the desired A-scope display and then push the left button.

**Small:** A-scope display shown on right 1/10 of the screen.

**Standard:** A-scope display shown on right 1/8 of the screen.

**Large:** A-scope display shown on right 1/6 of the screen.

4. Click the OK button.

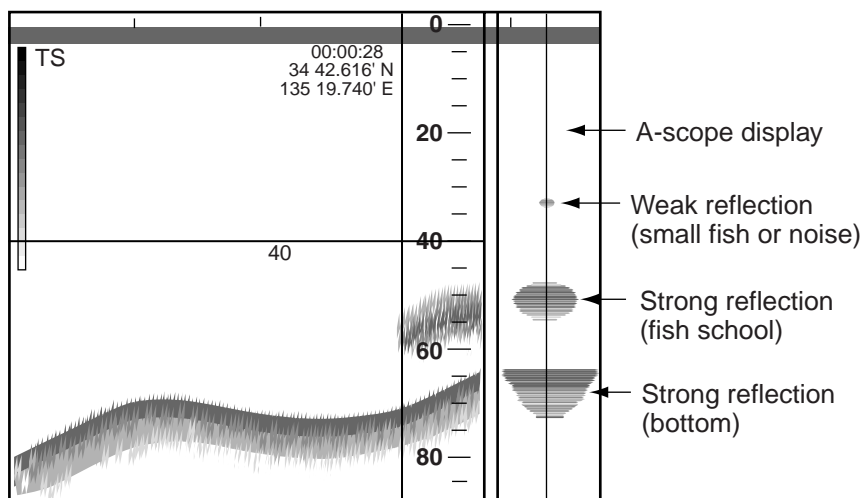

*A-scope display*

To turn off the A-scope display, choose OFF at step 3 in the above procedure.

## 1.18 Alarms

This sounder has four alarms: bottom alarm, bottom fish alarm, water temperature alarm and vertical temperature alarm. When the bottom echo or fish echo comes into the alarm range or the water temperature is within or out of the range of the temperature value set, the equipment generates audio and visual alarms to alert you. If “Alarm” is enabled on the Status window, the offending is shown in red, in reverse video. To silence the audio alarm, press any function key. The audio and video alarms will be released anytime the alarm conditions are violated.

### 1.18.1 Alarm description

#### **Bottom alarm**

The bottom alarm alerts you when the bottom echo enters the alarm area. The audio alarm sounds and the visual alarm “BOTTOM” appears in red reverse video and flashes when the bottom alarm is violated.

#### **Fish alarm**

The fish alarm alerts you when fish echoes enter into the set alarm range. The audio alarm sounds and the visual alarm “FISH” appears in red reverse video and flashes when the bottom alarm is violated. This alarm is useful when targeting a specific fish specie, since each fish specie is known to inhabit certain depths.

#### **Bottom fish alarm**

The bottom-fish alarm sounds when a fish echo is within a predetermined distance from the bottom. The audio alarm sounds and the visual alarm “BL-FISH” appears in red reverse video and flashes when the bottom fish alarm is violated.

#### **Temp alarm (requires temperature sensor)**

There are two types of temperature alarms: within range and out of range. The audio alarm sounds and the visual alarm “TEMP” appears in red reverse video and flashes when the temperature alarm is violated. The temperature alarm may be used to target specific fish species, as each fish specie is know to inhabit certain temperature ranges.

#### **V-temp alarm (requires net sonde or trawl sonar)**

There are two types of v-temp alarms: within range and out of range. The audio alarm sounds and the visual alarm “V-TEMP” appears in red reverse video and flashes when the v-temp alarm is violated.

## 1.18.2 Enabling, disabling an alarm

1. Click Settings.
2. Click Alarm.

The screenshot shows the 'Alarm' dialog box with the following settings:

- Volume: 3
- Bottom alarm:  (disabled)
- Temp alarm:  (disabled)
- Fish alarm:  (disabled)
- V-temp alarm:  (enabled)
- Temp limit: 20.0 C
- Alarm zone: 1.0 C
- Alarm zone: 1.0 C
- Within range:  (selected)
- Out of range:  (unselected)
- Within range:  (selected)
- Out of range:  (unselected)

### *Alarm dialog box*

3. Check the box in Bottom alarm, Fish alarm, Temp alarm or V-temp alarm as appropriate.
4. **For the Fish alarm**, choose alarm type with the radio buttons Fish or Bottom fish.  
**For the temp alarm or v-temp alarm**, choose alarm type with the radio buttons Out of range or Within range.
5. Click ◀ or ▶ in the Alarm depth box (for bottom alarm or fish alarm) or Temp limit box (for temperature alarm or v-temp alarm) to set alarm depth (or temperature limit).
6. Click ◀ or ▶ in the Alarm zone box to set the width of the alarm from the starting point.

## 1. OPERATIONAL OVERVIEW

7. Click the OK button.

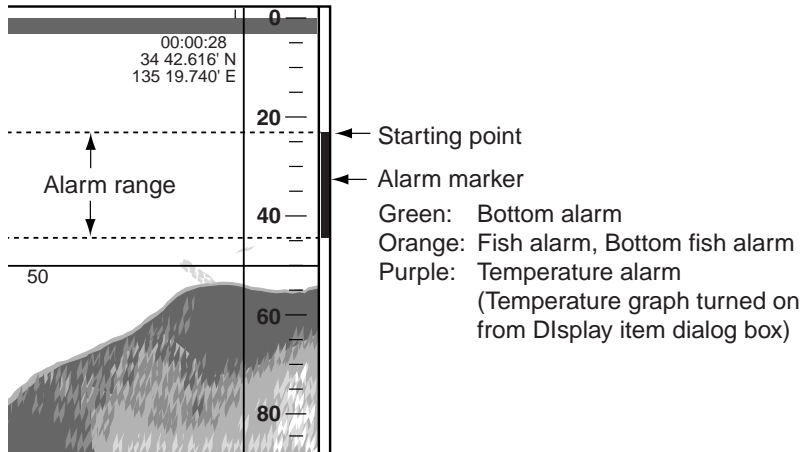

### *Alarm marker*

The alarm marker appears at the right edge of the display, and the color is green for the bottom fish alarm and orange for the fish alarm.

To disable an alarm, remove the check mark from the box at step 3 in the above procedure.

### **1.18.3 Setting audio alarm volume**

You may set the volume of the audio alarm as follows:

1. Click Settings.
2. Click Alarm.
3. Click ▼ in the Volume box.
4. Click the setting desired. (setting range: 0-7).
5. Click the OK button.



## 1.19 Function Keys

The function keys on the control unit provide for one-touch access to the setting window of your choice.

### 1.19.1 Using the function keys

The default program for each function key is as shown in the table below. Press the appropriate function to access the setting window programmed for it.

Function key	Default program displays;
F1	Echo image dialog box
F2	Shift dialog box
F3	Gain dialog box
F4	Mode dialog box

### 1.19.2 Programming the function keys

1. Press the appropriate function key until the menu title looks something like the one shown below.

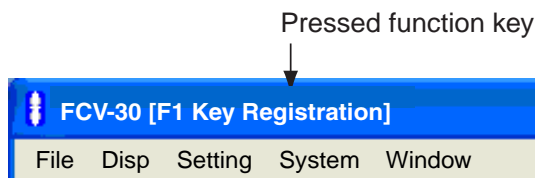

2. Click the item on the menu bar which you want to use. For example, "Alarm" in the Setting menu. Note that neither "Load user setting" nor "Save user setting" (in the File menu) can be used.)

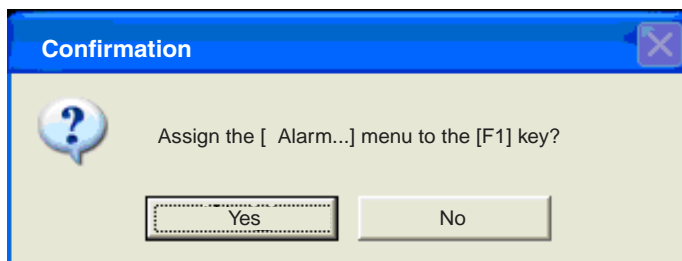

3. Click the Yes button. The item selected at step 2 appears.
4. Click the OK button.

## 1.20 Saving, Recalling User Settings

You may save echo sounder settings, and recall them when desired. This is useful when you want to set up the equipment quickly for a specific objective; for example, certain fish species.

### 1.20.1 Saving user settings

1. Adjust settings according to targeted fish or objective.
2. Click File.
3. Click Save user setting.

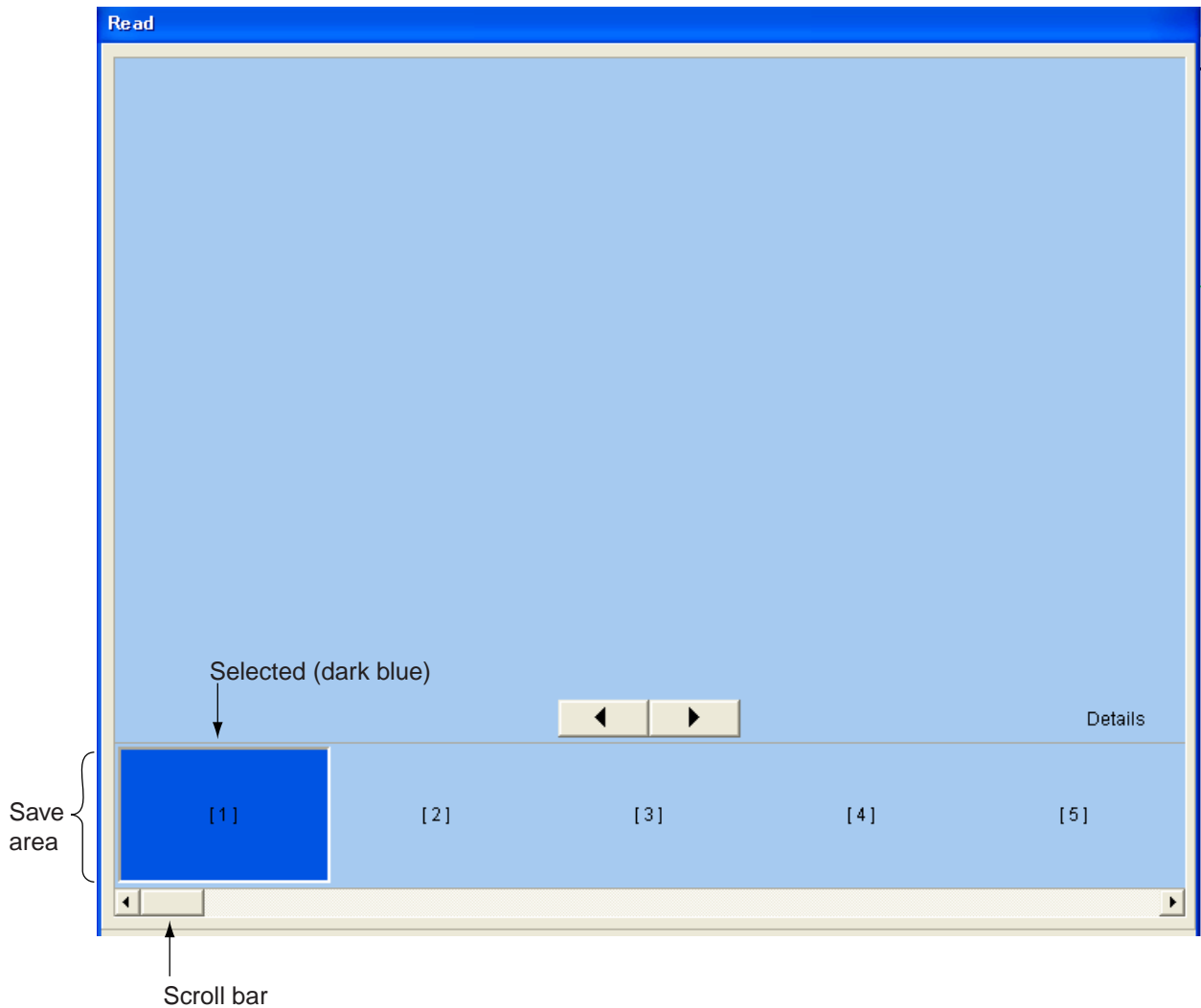

#### *Save user setting*

4. Click the ◀ or ▶ button to choose an empty save area. The chosen save area is highlighted in dark blue. You also may the scroll bar to choose a save.  
**Note:** If 20 areas are already saved, choose an unnecessary one to write over it.
5. Click the Save button.

## 1.20.2 Loading user settings

Note that you cannot load user settings while transmitting.

1. Click File.
2. Click Load user setting.

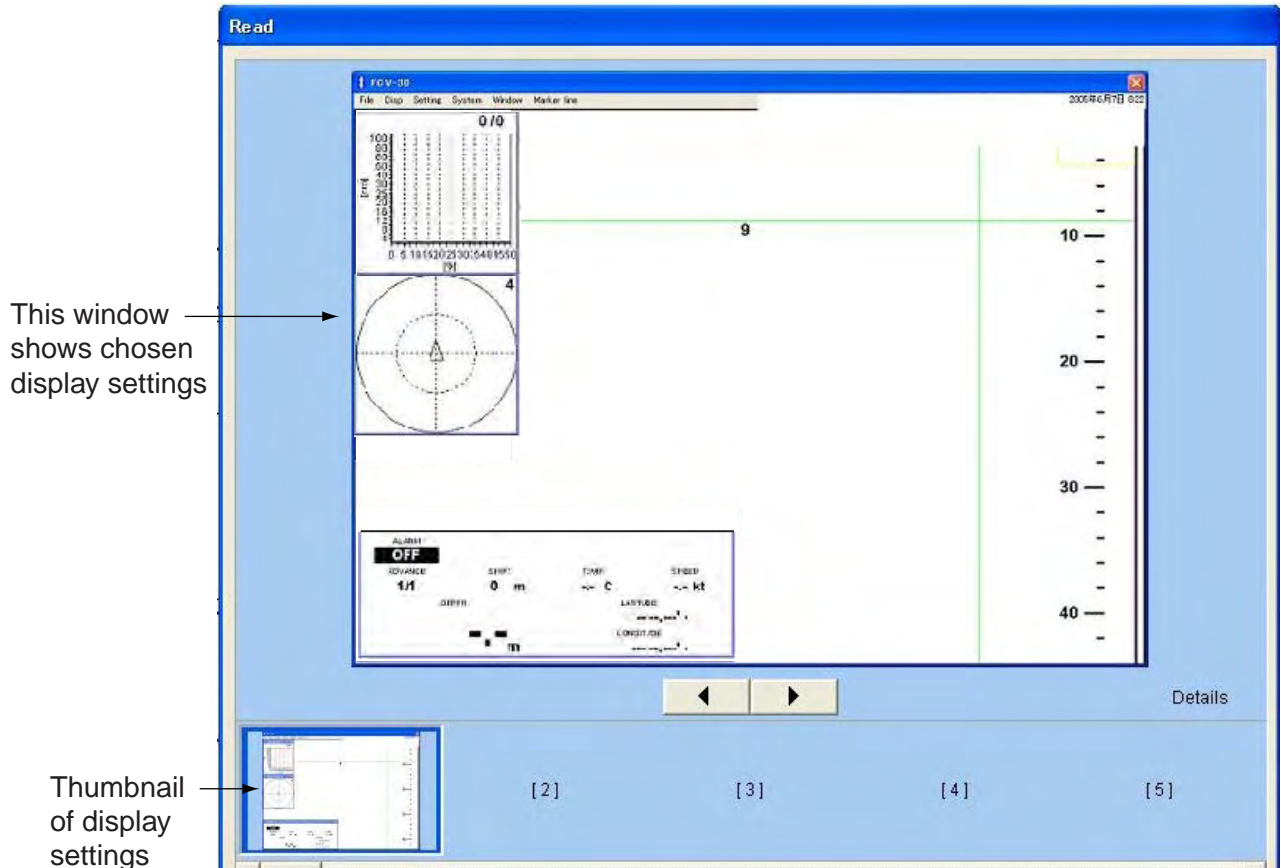

### *Read display*

3. Click the ◀ or ▶ button to choose the display settings you wish to display. The chosen display setting is highlighted in dark blue.

## 1. OPERATIONAL OVERVIEW

**Note:** You may use the Details button to display detailed information about the chosen display settings.

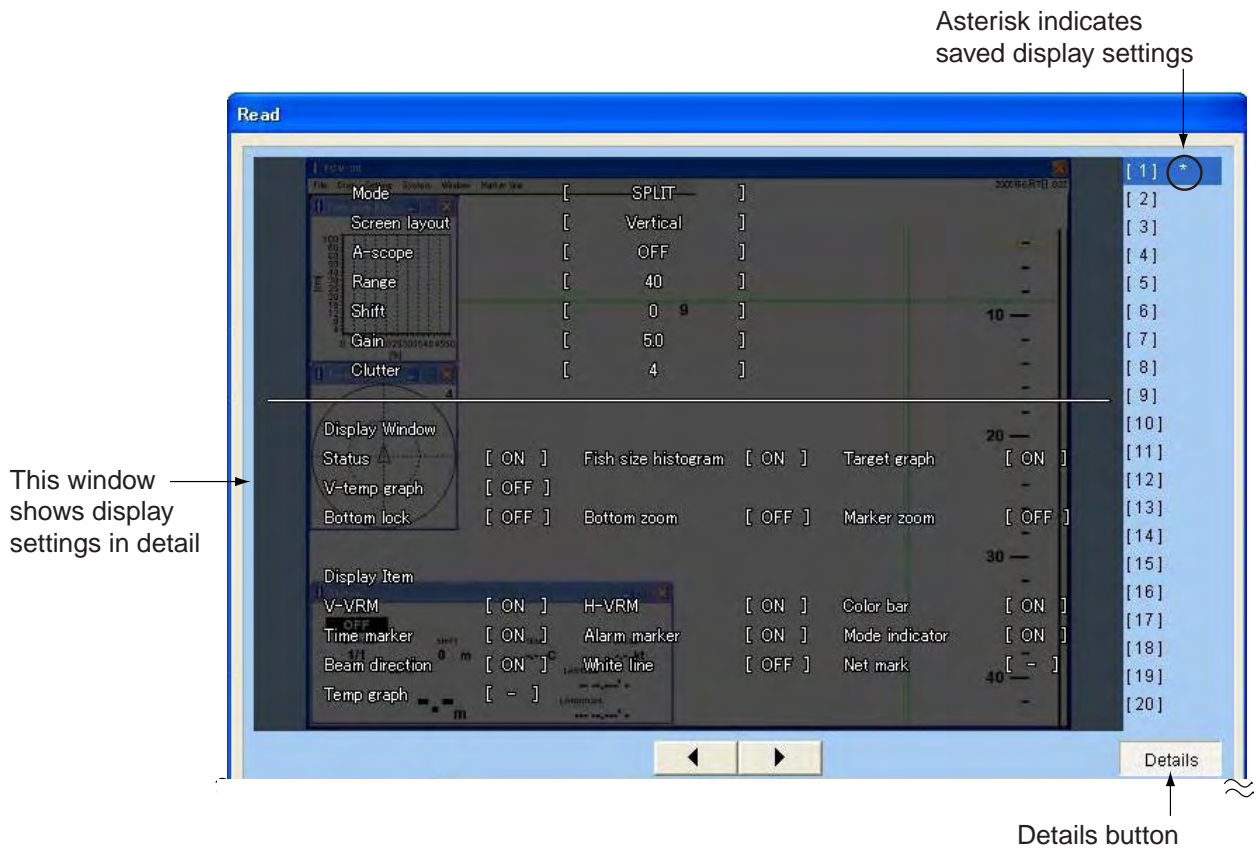

*Read display, details shown*

4. Click the Read button to activate chosen settings.

## 1.21 Recording, Replaying Data

The USB port on the processor unit connects to a USB 2.0 hard disk (user supplied) to record and replay raw data and picture data.

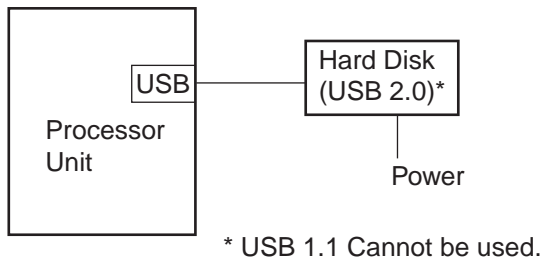

*Connecting a hard disk*

### 1.21.1 Choosing where to record data

1. Connect a USB hard disk to the USB port on the processor unit.
2. Click Setting.
3. Click Record.

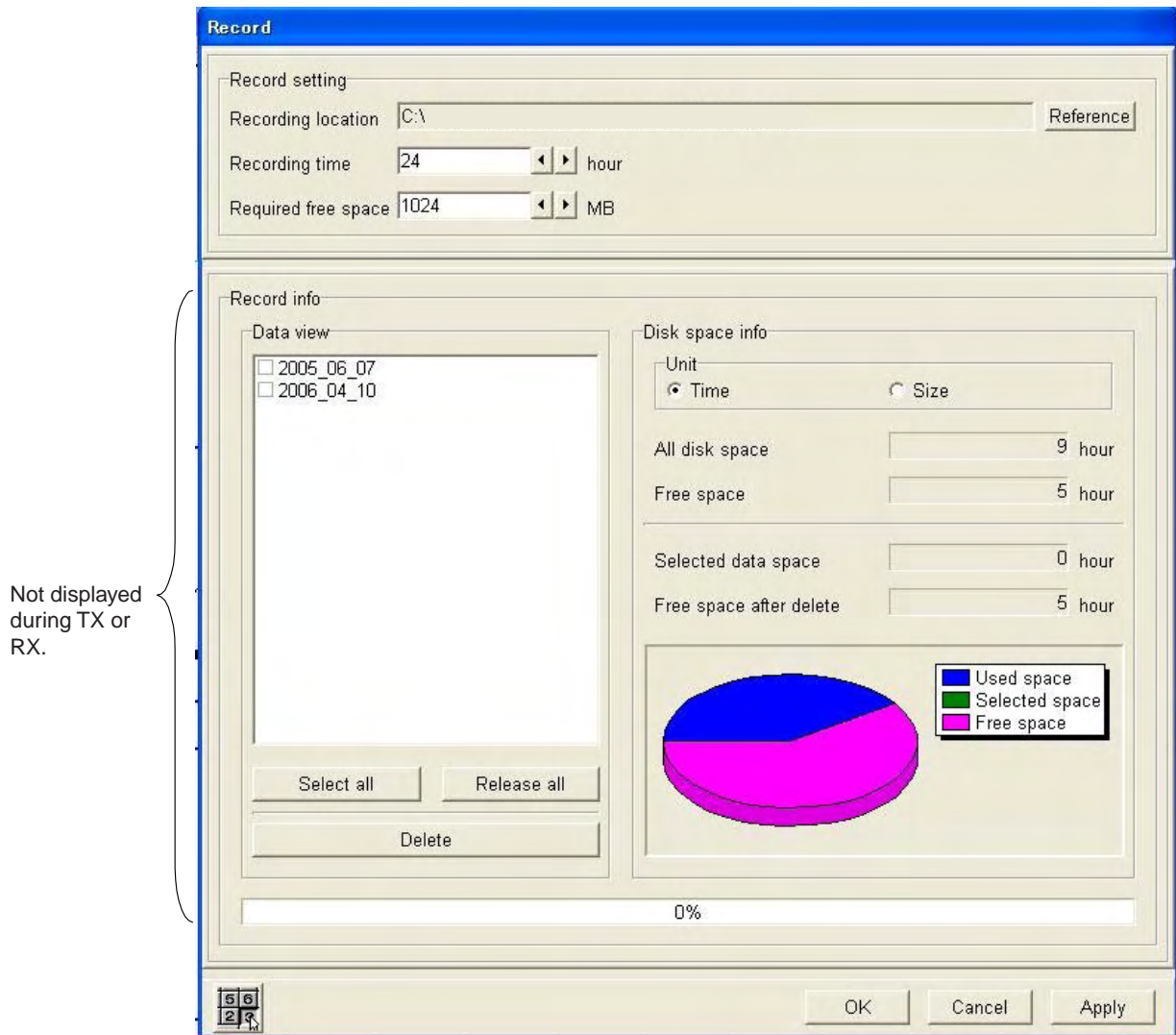

## 1. OPERATIONAL OVERVIEW

4. Click the Reference button.

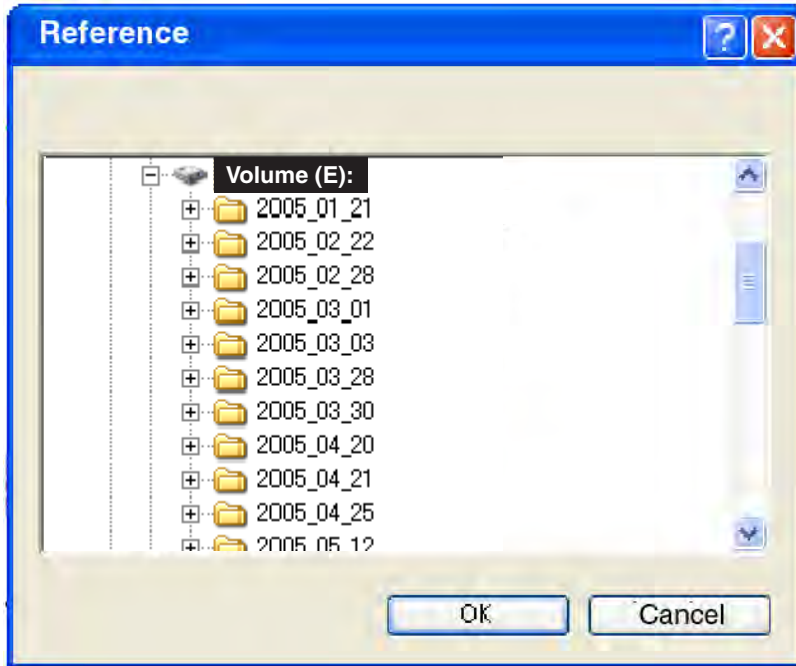

5. Choose location of data recording and then close the Reference window.

6. Click ◀ or ▶ successively in the Recording time box to set recording time (1-24 hours).

7. Click ◀ or ▶ successively in the Recording free space box to set required free space (512-32767 MB).

8. Click the OK button.

### **Data recording information**

Data recording information can be confirmed in the Record info sub window. In "Data view" in the Record info sub window, choose file to find its size or recording time by clicking its check box to show the check mark (✓). The size or recording time for the file selected appears in the Disk space info sub window. To change the display content, click Time or Size at "Unit" in the Disk space info sub window.

### **Deleting recorded data**

Data can be deleted from the Record window as follows:

1. In the Data view sub window, check the data you wish to delete. To delete all files, click the Select all button. To deselect all files, click the Release all button.
2. Click the Delete button. A confirmation window asks if it is OK to delete files.
3. Click the Yes button.
4. Click the Yes button. The bar at the bottom of the window now reads "100%".

## 1.21.2 Recording data

1. Connect a USB hard disk to the USB port on the processor unit.
3. Click File.

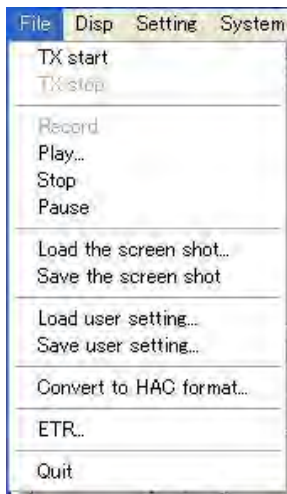

### *File menu*

3. Click Record.

When a file is recorded it is automatically assigned a file name comprised of date and time of the recording plus the extension .lst. An example file name is shown below.

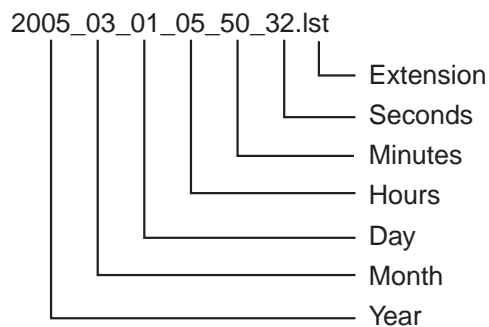

To stop recording data, choose Stop at step 3 in the above procedure.

## 1. OPERATIONAL OVERVIEW

### 1.21.3 Converting recorded data to HAC format

Recorded data can be converted to HAC format data, the standard archiving and playback format for fisheries acoustics data. This HAC format is nonrestrictive and independent of the computer platform. It can accommodate most echo sounders. Note that this feature is not available when transmitting or receiving.

1. Connect USB hard disk to the USB port on the processor unit.
2. Click File.
3. Click TX Stop.
4. Click File.
5. Click Convert to HAC format.

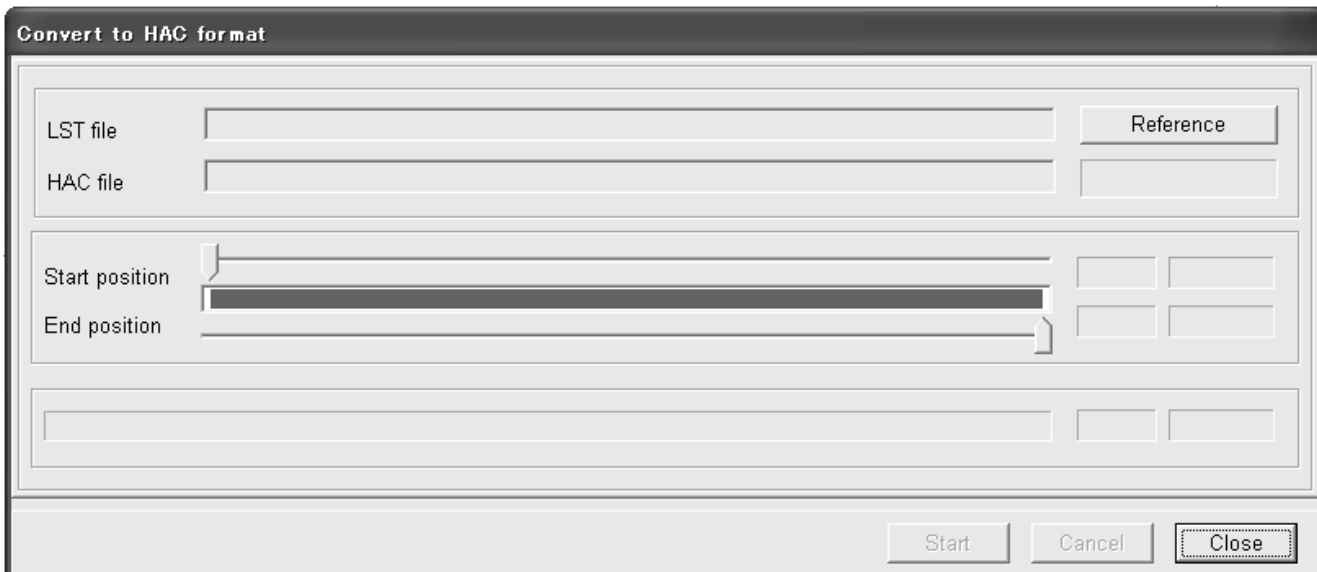

*Convert to HAC format dialog box*

6. Click the **Reference** button
7. Choose the file (LST file) you wish to convert.
8. Click the Open button.

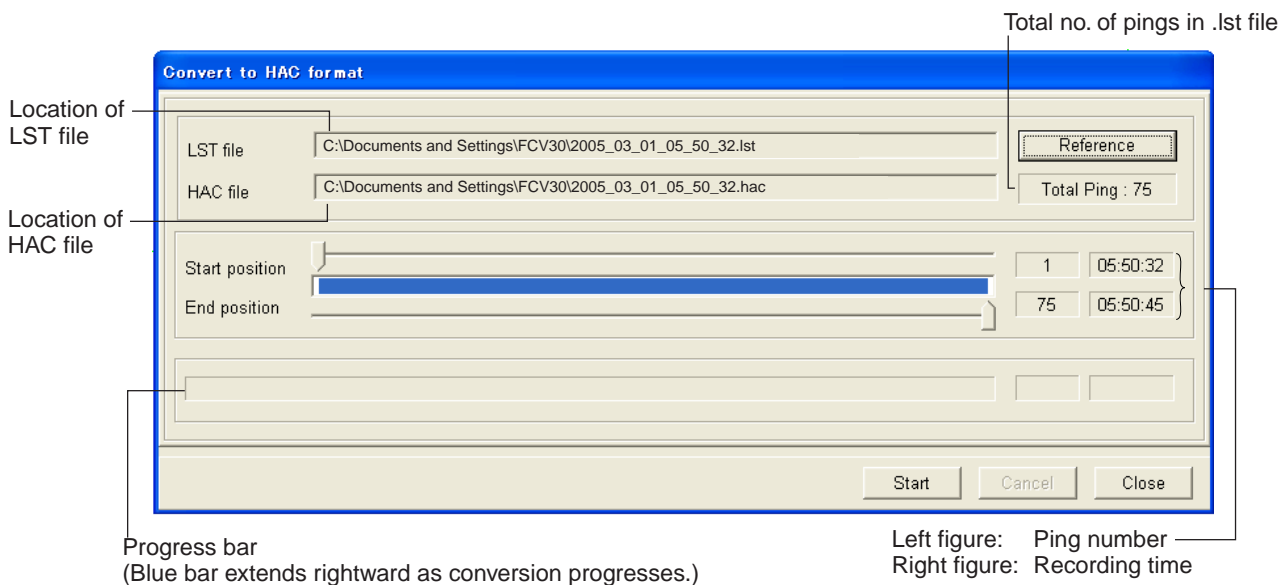



9. With the slider bars, choose start position and end position.
10. Click the Start button to start the conversion. The progress bar extends rightward as the conversion progresses. When the conversion has been completed the message “End of conversion” appears. Click the OK button to finish.
11. Click the Close button.

#### 1.21.4 Playing back data

1. Connect a USB hard disk to the USB port on the processor unit.
2. Click File.
3. Click TX Stop.
4. Click Play.

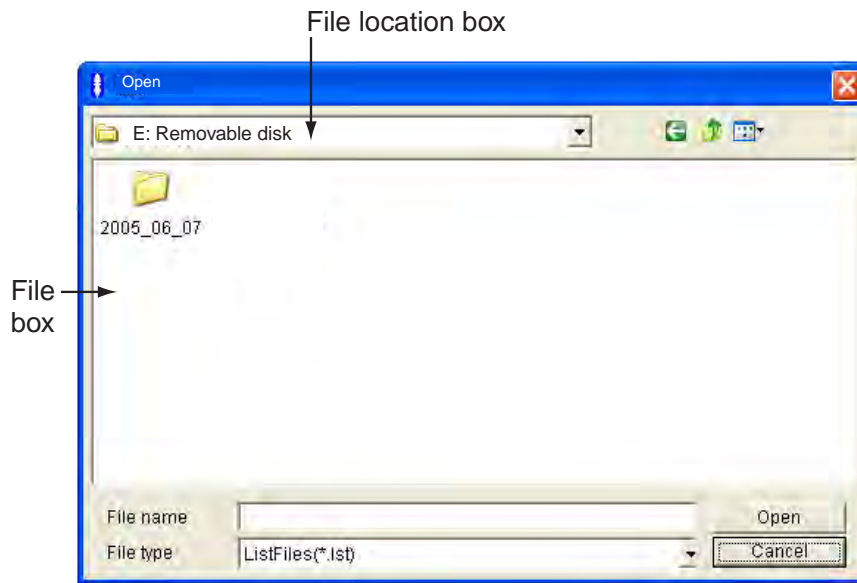

##### *Choosing file to replay*

5. Click ▼ in the file location box.
6. Click the hard disk drive connected to the FCV-30. Folder(s) showing year, month and as folder name appear.
7. Double-click desired folder, and “EchoData” folder appears.
8. Double-click the EchoData folder, and “hour, minute, second” folder appears.
9. Double-click the hour, minute, second folder you wish to playback. A list of LST files appears.
10. Click an LST file to show file name in reverse video. Chosen LST file appears in the file box.

## 1. OPERATIONAL OVERVIEW

11. Click the Open button to start playback.

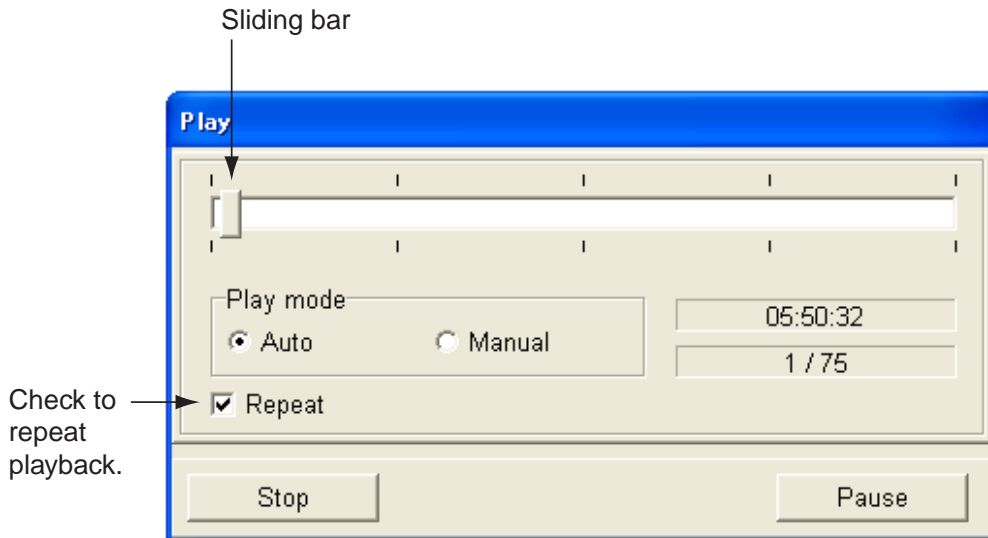

*Play dialog box*

### **Notes on playing back data**

- Use the Play Mode Manual and Play Mode Auto radio buttons to change setting data:  
Auto: Use settings used at the time of the recording.  
Manual: Apply current settings.
- To playback a file manually, use the sliding bar to choose the location where to start playback and then hit the Restart button.
- Click the Pause button to temporarily stop playback. To restart playback use the Restart button.
- Use the Stop button to stop playback.

### 1.21.5 Saving screen shot

You may take a screen shot to save the current window. Compared to raw data, the size of the screen shot is small, thus loading time is much shorter.

1. Connect a USB hard disk to the USB on the processor unit.
2. Click File.

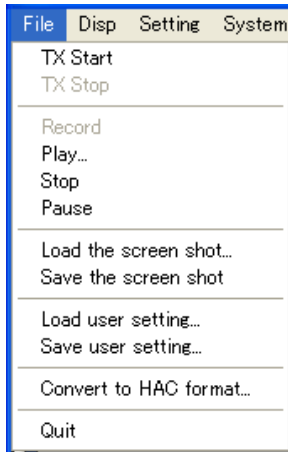

3. Click Save the screen shot.

The screen shot is saved to the location designated at step 5 in paragraph 1.21.1. This data is automatically assigned a file name and extension as below.

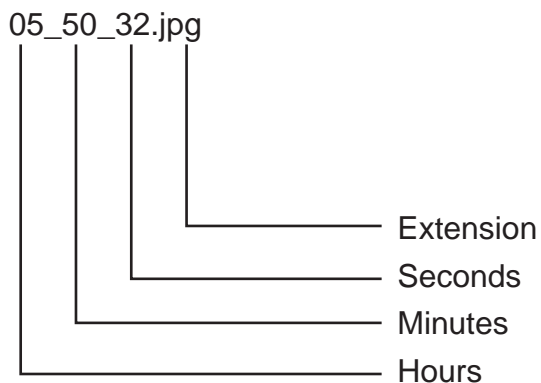

*File name for screen shot*

## 1. OPERATIONAL OVERVIEW

### 1.21.6 Loading a screen shot

1. Connect hard drive to the USB on the processor unit.
2. Click File.
3. Click Load the screen shot.

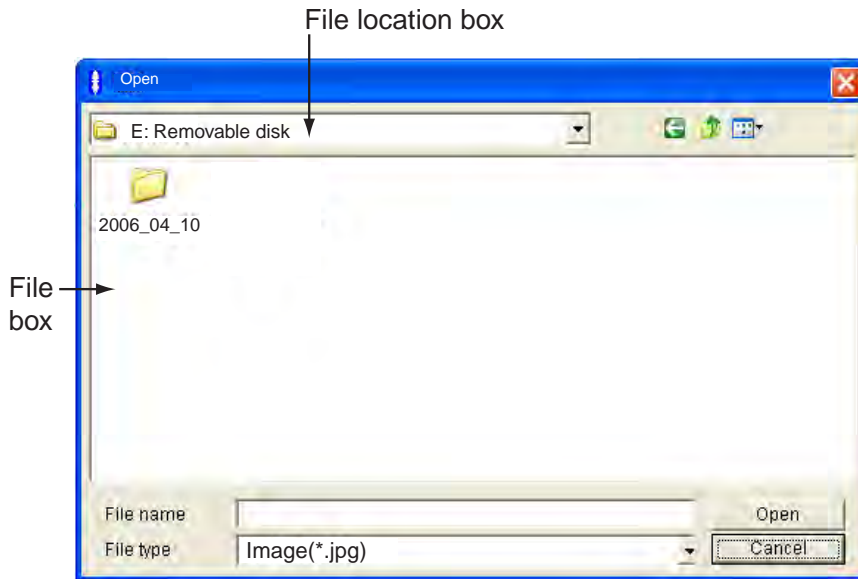

4. Click ▼ in the file location box.
5. Click the hard disk drive connected to the FCV-30. Folder(s) showing year, month and as folder name appear.
6. Double-click desired folder, and "ImageData" folder appears.
7. Double-click the EchoData folder, and "hour, minute" folder appears.
8. Double-click the "hour, minute" folder you wish to playback. A list of JPG files appears.
9. Click a JPG file to show file name in reverse video. Chosen JPG file appears in the file box.
10. Click the Open button to load the screen shot.

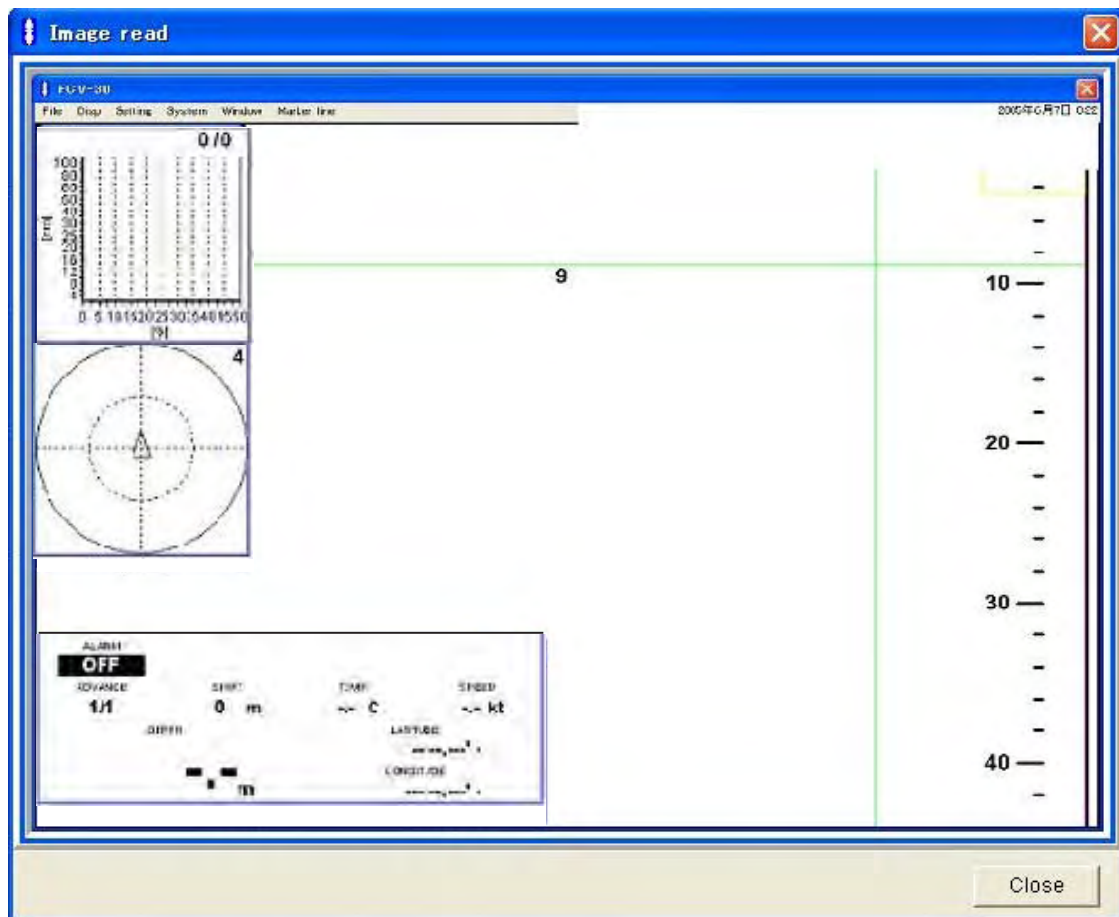

11. To erase the screen shot. click the Close button.

## 1. OPERATIONAL OVERVIEW

This page intentionally left blank.

## 2. WINDOW DISPLAYS

The FCV-30 has eight window displays: status, fish size histogram, target graph, V-temp graph, bottom zoom, bottom lock, marker zoom, and bottom discrimination.

You may locate these windows anywhere on the screen. Further, right clicking at the upper right side of a window displays associated pop-up menu.

### 2.1 Turning on Window Displays

1. Click Disp.

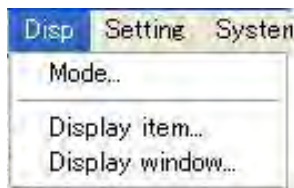

*Disp menu*

2. Click Display Window.

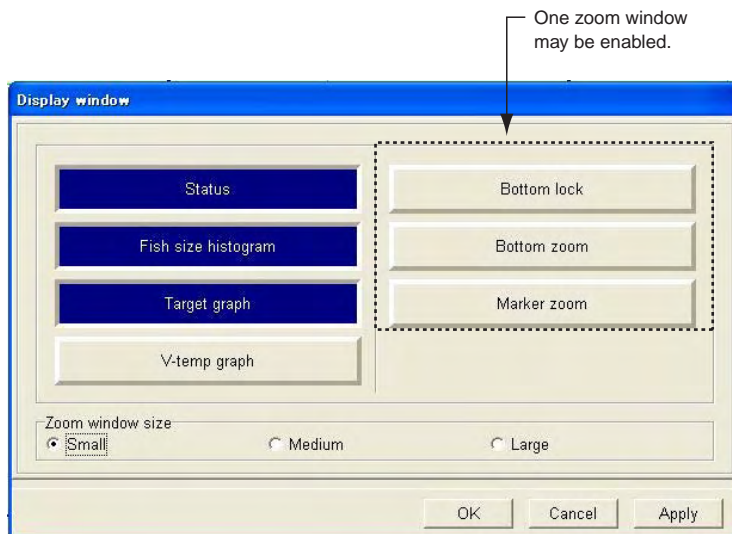

*Display window dialog box*

3. Choose item(s) to enable or disable in the Display item window and then push the left button. Items which are enabled are highlighted in blue and those which are disabled are grey.

**Note:** Only one among bottom lock, bottom zoom and marker zoom may be enabled.

4. To change size of bottom lock, bottom zoom and marker zoom windows, click appropriate radio button in the Zoom window size window.
5. Click the OK button.

## 2. WINDOW DISPLAYS

### **Automatically arranging windows**

1. Click Window on the menu bar.

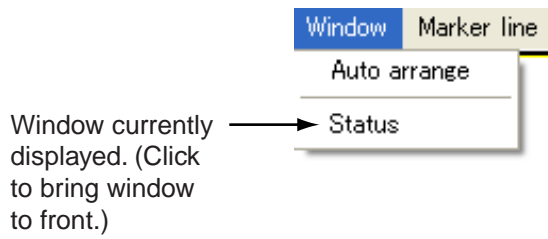

2. Click Auto arrange to relocate windows to their default locations.

### **Moving windows**

1. Use the trackball to place the pointer in the window.
2. Roll the trackball while holding down the left button to move the window.



## 2.2 Interpreting the Window Displays

### 2.2.1 Status window

The Status window shows current settings and data input from external sensors. You may choose the items to display in the Status window by selecting them from the status setting window. Depth is indicated at the lower left-hand corner regardless of Status window presence or absence.

ALARM	PICTURE	TIMER	COURSE	HEAVE		
OFF		00:10	275.0 deg	-32.77m		
GAIN	SHIFT	TEMPERATURE	SPEED	ROLL	PITCH	
		15.3 C	17.8	1.6 deg	2.1 deg	
	DEPTH		LATITUDE		P/B	
	<b>40.6</b>		34 21.5912' N		32.7m	265.1deg
			LONGITUDE		TD	
			136 08.4732' E		13234.5	32234.7

DEPTH	GAIN	SHIFT	ALARM	PICTURE	LATITUDE	LONGITUDE	TEMPERATURE
40.6			OFF		34 21.5912' N	136 08.4732' E	
SPEED	TIMER	COURSE	TD		P/B	ROLL	PITCH
17.8	00:10	275.0 deg	13234.5	32234.7	32.7m	1.6 deg	2.1deg
							HEAVE
							-32.77m

Status windows (Top: Enabled with Status in Display Window, Bottom: Fixed at screen bottom)

#### How to setup the Status window

1. Click Settings.
2. Click Status.

## 2. WINDOW DISPLAYS

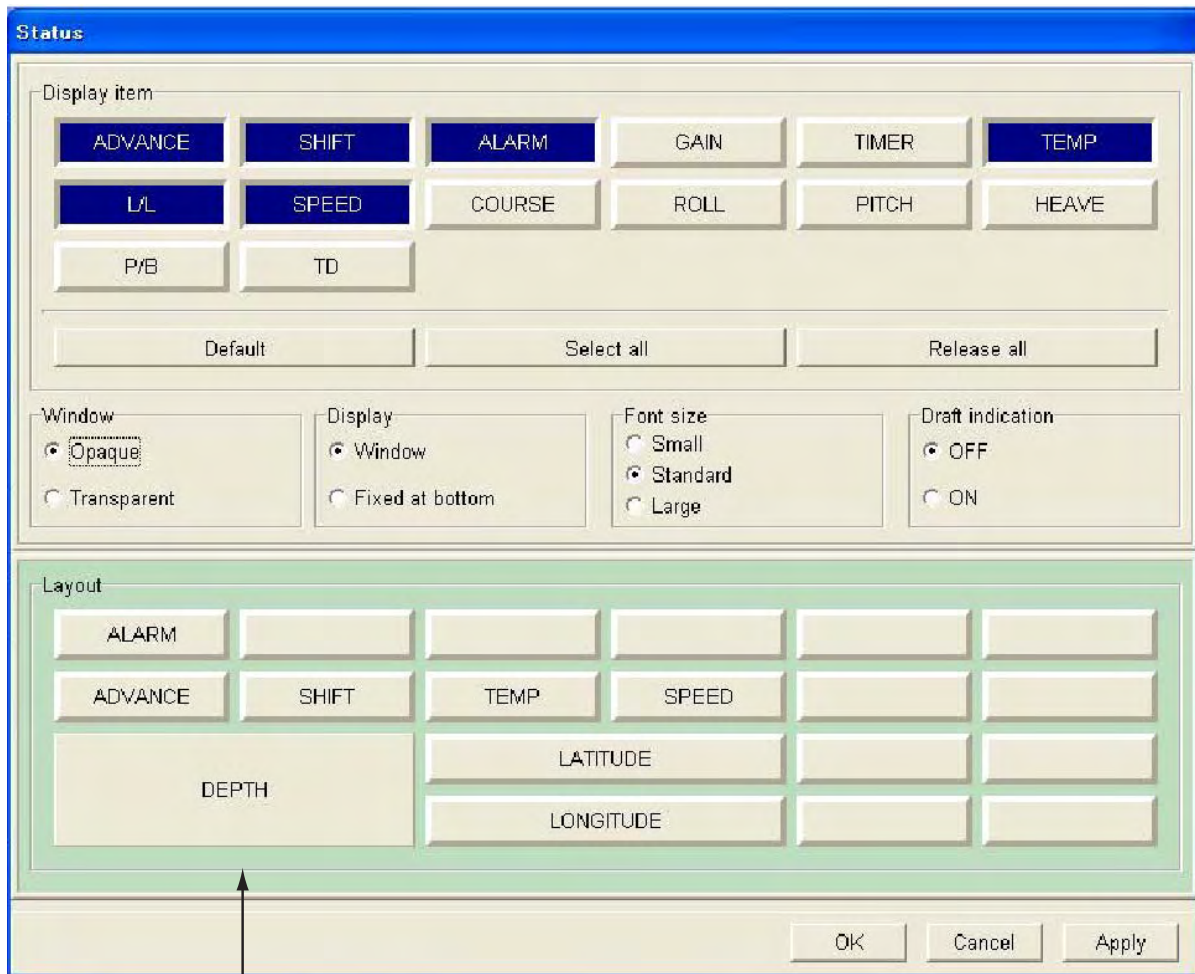

This window shows which indications are currently displayed.

### *Status dialog box*

3. Click items in the Display Item window as appropriate. Enabled items are highlighted in blue.

**Note 1:** “Default” restores default Status window items; “Select all” enables all items; Release all disables all items.

**Note 2:** You may change the location of items in the Status window freely:

- 1) Click the item in the Layout window which you want to change its location.
- 2) Click the box in the Layout window which corresponds to the location where you want to location the item clicked at step 1.

4. To change the transparency of the Status window, choose Opaque or Transparent from “Window”.
5. To choose Status window type, choose Window or Fixed at bottom in the Display window. Choose Window to get a moveable window, or Fixed at bottom to anchor the Status display at the bottom of the screen.
6. To choose the size of the characters for the Status window, click Small, Standard or Large in the Font size window.
7. To display the draft indication, click ON in the Draft indication window.
8. After setting up the Status window, click the OK button.

Data display description

Item	Description
Picture advance	Show current picture advance setting.
Shift	Show current shift value.
Alarm	Show current alarm content.
Gain	Show current gain setting.
Timer	Choose Marker line from the menu bar and push the left button. The timer then counts up the number of minutes (max. 99 min. 59 sec.) since the left button was pushed.
Temperature	Water temperature data, fed from external temperature sensor, is shown. Temperature range: -99.9°C to 99.9°C
L/L	Position data, fed from a navigator, is shown. Latitude and longitude range: Latitude: 90°00.000'S to 90°00.000'N Longitude: 180°00.000'W to 180°00.000'E
Speed	Speed, fed from speed log, is shown. Speed range: 0.0 kt to 99.9 kt
Course	Course, fed from a navigator, is shown. Course range: 0°-359°
Roll	Roll angle, fed from appropriate sensor, is shown. Roll angle range: -90.0° to 90.0°
Pitch	Pitch angle, fed from appropriate sensor, is shown. Pitch angle range: -90.0° to 90.0°
Heave	Heave, fed from a satellite compass, is shown. Heave range: -99.m to 99.0 m
Range/Bearing	Range and bearing to a TO waypoint, fed from a navigator, is shown. Range and bearing: 0°-360°
Time difference	Time difference, fed from a Loran C navigator, is shown Time difference range: 00000.0 to 99999.9
Draft	Draft calibration method is shown; below surface or below transducer.

### 2.2.2 Fish size histogram window

The fish size histogram shows fish size within the selected measuring area. The SPLIT (split beam) display must be active to show the fish size histogram window.

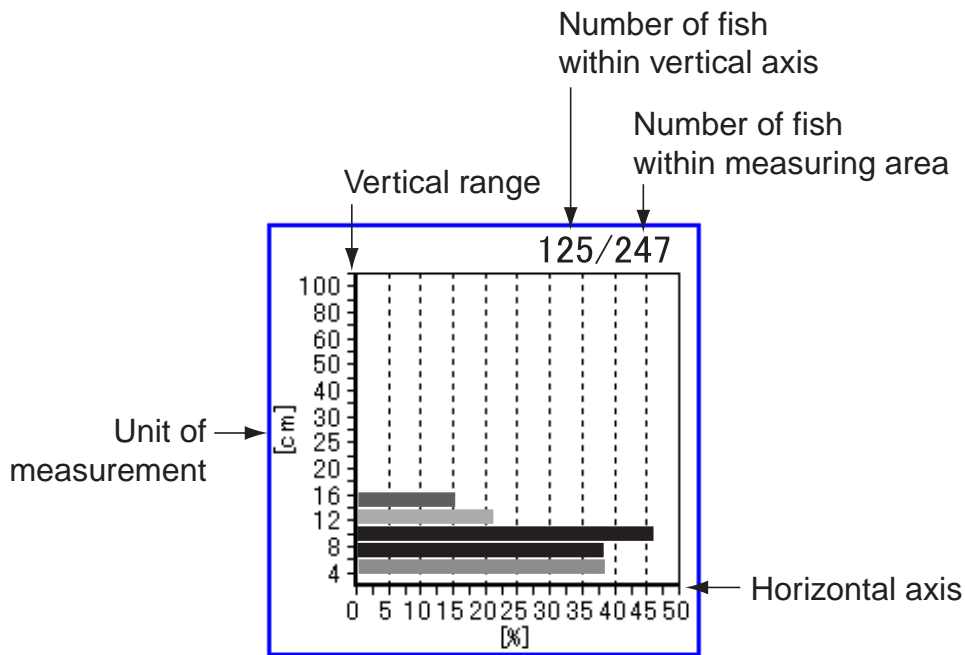

*Fish size histogram window*

#### Setting up the fish size histogram dialog box

1. Click Setting.
2. Click Fish size.

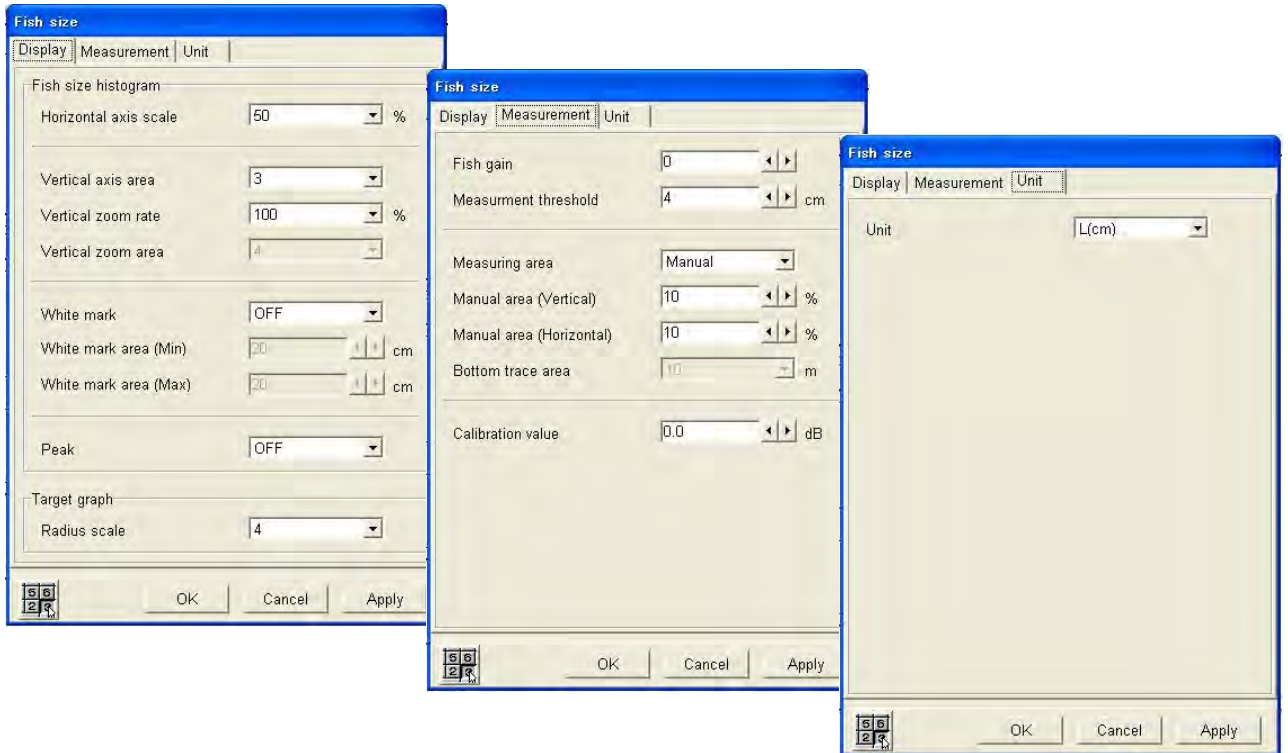

*Fish size histogram dialog box*

**Note:** If the Target graph dialog box appears, click the Fish size histogram tab.

Description of Fish size dialog box

Menu item	Description
<b>Display tab</b>	
Horizontal axis scale	Choose the horizontal axis scale, from 10-100(%).
Vertical axis area	Choose the vertical axis scale from 1-6.
Vertical zoom rate	Choose the vertical zoom rate for the fish histogram display from 100, 200 or 400(%).
Vertical zoom area	Choose center position of vertical zoom on the fish histogram display among 1-7. 1 is the shortest, 7 is the longest.
White mark	Turn the white mark on or off. When turned on, the bar graph within the white mark range is displayed in white if the background is black, or black if the background is white.
White mark area (Min and Max)	Choose the minimum and maximum range of the white mark. The setting range is 2-1000(cm)
Peak	Turn peak display on or off. When turned on, the representative peak value on the bar graph is displayed.
<b>Measurement tab</b>	
Fish gain	The strength of the returning echo varies with fish species. Adjust the fish gain according to fish species to get actual fish length distribution on the fish histogram display.
Measurement threshold	Set measurement threshold (2-20(cm)) for the fish histogram display. For example, if you do not want to measure fish less than 10 cm in length, enter 10.
Calibration value	Set TS (echo strength of individual fish) value. If a calibration sphere was used its value is shown. This value may be fine tuned. For further details, see paragraph 3.8. The larger the calibration figure the longer the length of individual fish, even if received signal is the same.
<b>Unit tab</b>	
Unit	Choose the unit of measurement for the fish size histogram; TS or L(cm) or L(inch). TS: Displays echo strength from single fish. L(cm): Displays fish length in centimeters. L(inch): Displays fish length in inches.

### 2.2.3 Target graph window

The target graph window plots fish echo position (latest three scans). It is available when the SPLIT display is active.

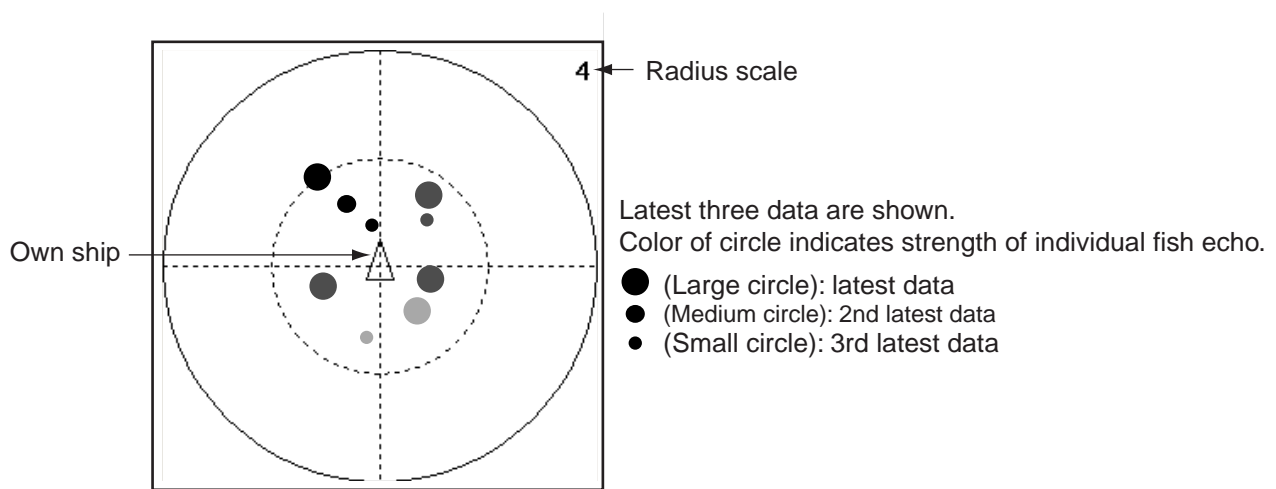

*Target graph window*

#### **Setting up the target graph window**

1. Click Setting.
2. Click Fish size. If the Fish size histogram dialog box is shown, click the Target graph tab to show the Target graph dialog box.

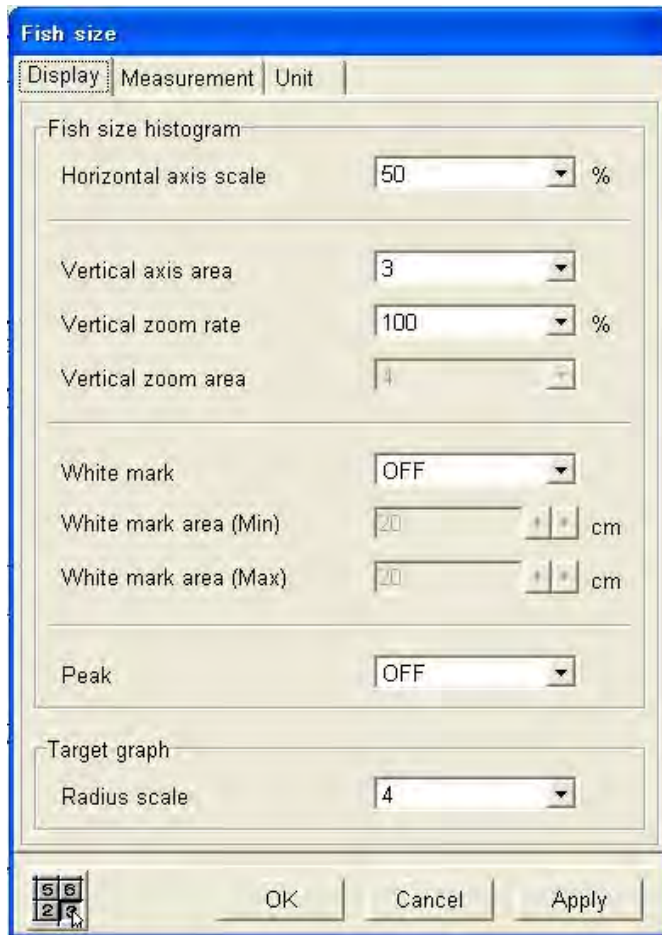

*Fish size dialog box, Display tab*

**Note 1:** If the Measurement or Unit dialog box appears, click the Display tab to open the Display dialog box.

**Note 2:** “Radius scale” sets the width of the area in degrees (2-5) to display below the transducer (beam center). The larger the figure, the greater the area in which a single fish can be tracked.

### 2.2.4 V-temperature graph window

The V-temperature graph window plots depth and water temperature data fed from a net sonde or trawl sonar. (Max. 6 units.) Water temperature is plotted on the horizontal axis; depth on the vertical axis. You may adjust the minimum and maximum horizontal axis figures on the Net dialog box. Further, the temperature/depth line color may be chosen on the Color dialog box. A pop-up window lets you adjust the horizontal axis figures (with sliding bars) and reset data; click the v-temp graph window with the right button to show the pop-up window.

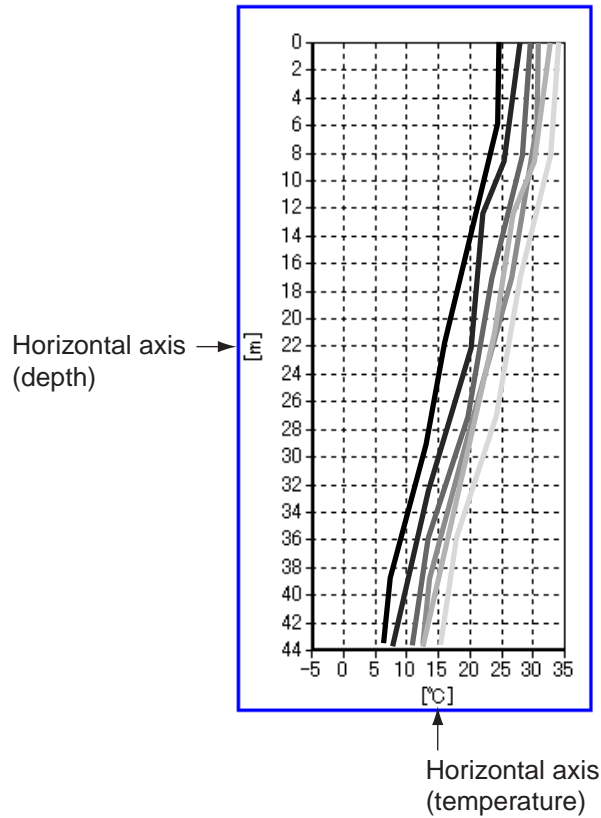

*V-temperature graph*



### Setting up the v-temp graph

1. Click System.
2. Click Net.

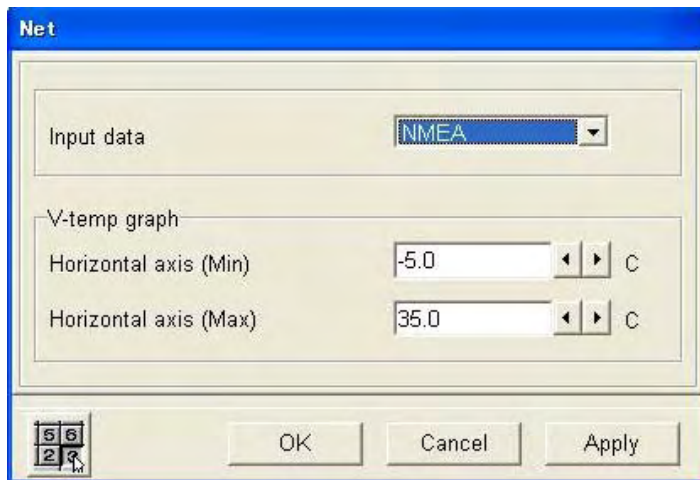

**Input data:** Choose the format of data fed from net sonde or trawl sonar.

CIF: Water temperature and net depth fed from net sonde.

NMEA: Water temperature and net depth fed from trawl sonar

**Horizontal axis Min and Horizontal axis Max:** These set the minimum and maximum temperature scale, and the range is  $-5$  to  $35(^{\circ}\text{C})$ .

### 2.2.5 Bottom-lock zoom window

The bottom-lock zoom window zooms echoes within the user-set distance from the bottom. Since the bottom is shown as flat, this window is useful for discriminating bottom fish from the bottom echo.

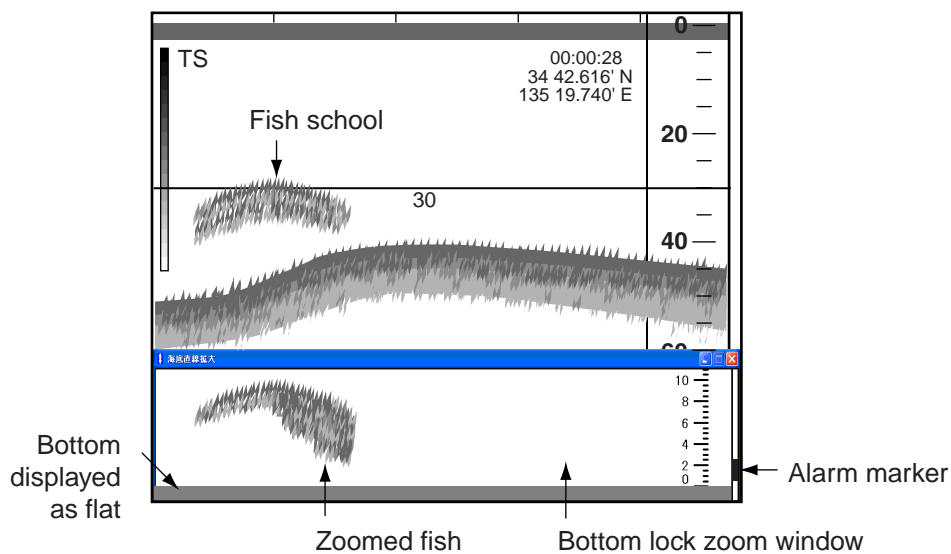

*Bottom-lock zoom window*

## 2. WINDOW DISPLAYS

### Setting bottom lock zoom range

1. Click Setting.
2. Click Echo image.
3. Click ▼ in the Zoom range box and push the left button.

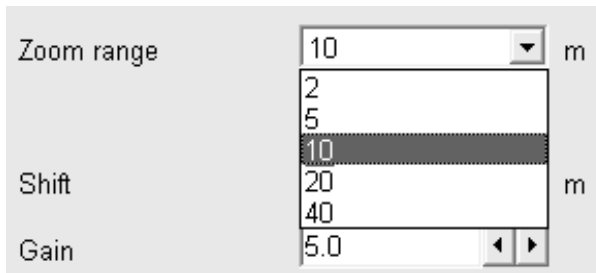

#### *Zoom range options*

4. Click the setting you wish to use.
5. Click the OK button.

### 2.2.6 Bottom zoom window

The bottom zoom window expands bottom and bottom fish echoes by the zoom range selected. It is useful for determining bottom hardness. A bottom displayed with a short echo tail usually means it is a soft, sandy bottom. A long echo tail means a hard bottom.

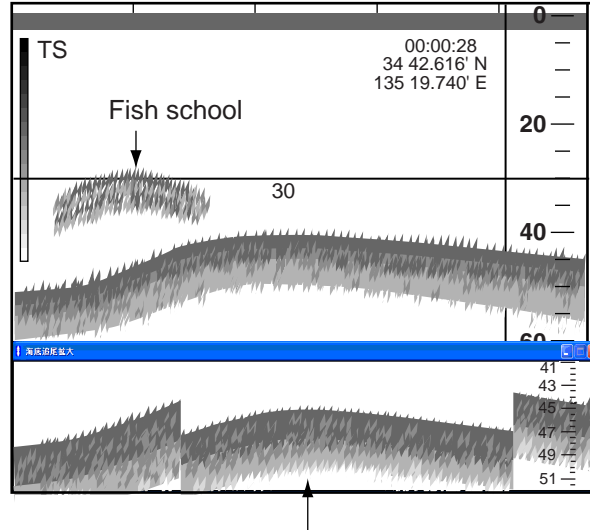

*Bottom zoom window*

## 2.2.7 Marker zoom window

The marker zoom window zooms echoes within the expansion marker (blue dashed line). This marker is operated the same as the horizontal VRM.

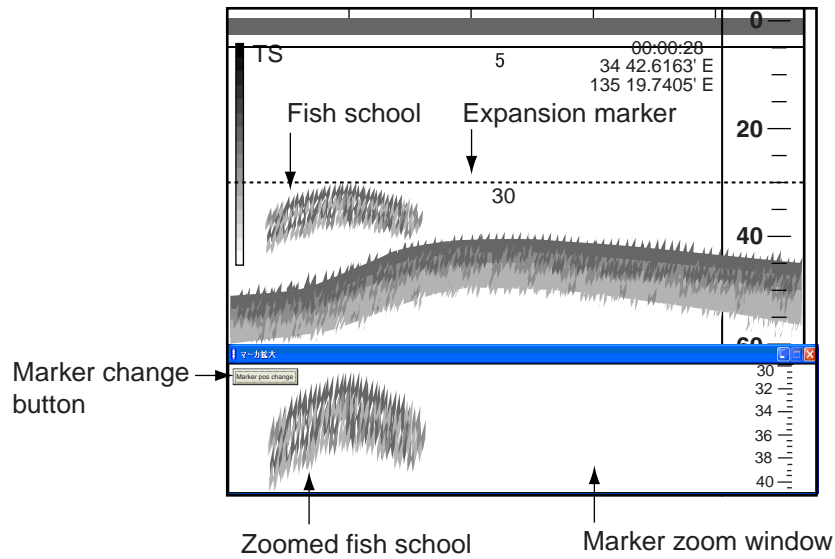

*Marker zoom window*

**Note:** When the divided screen is in use, click the Marker change button to shift the expansion marker between beams.

### 2.2.8 Bottom discrimination graph window

The bottom discrimination graph plots bottom nature, and it can be plotted on the bottom zoom, bottom lock and zoom marker windows. Right click one of those windows to show a pop-up menu, and choose (check) Hardness and/or Roughness from the menu to show respective graph.

**Hardness:** Plots bottom hardness. "H" appears at the left side of the window when the Hardness feature is active.

**Roughness:** Plots bottom roughness. "R" appears at the left side of the window when the Roughness feature is active.

The higher the figure, the harder or more uneven the bottom.

The color of the graph may be chosen from the Color dialog box. The icon color indicates color of respective graph.

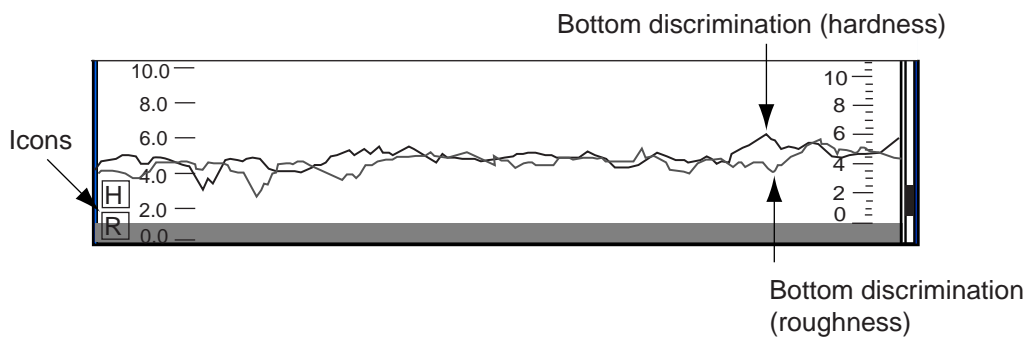

*Bottom discrimination graph*

# 3. CHANGING SETTINGS

This chapter provides the information necessary for changing equipment settings. For details about specific dialog boxes, see the table below.

Dialog box	See para.;
Display window	2.1
Status	2.2.1
Record	1.21
Fish size	2.2.2, 2.2.3
Alarm	1.18
External output, calibration, comm. settings, date	Installation manual
Net	2.2.4

## 3.1 Mode Dialog Box

The Mode dialog box lets you choose an A-scope format and the displays to show. The procedure below describes how to choose what settings to display on the User1-User3 displays.

1. Click Disp.
2. Click Mode.

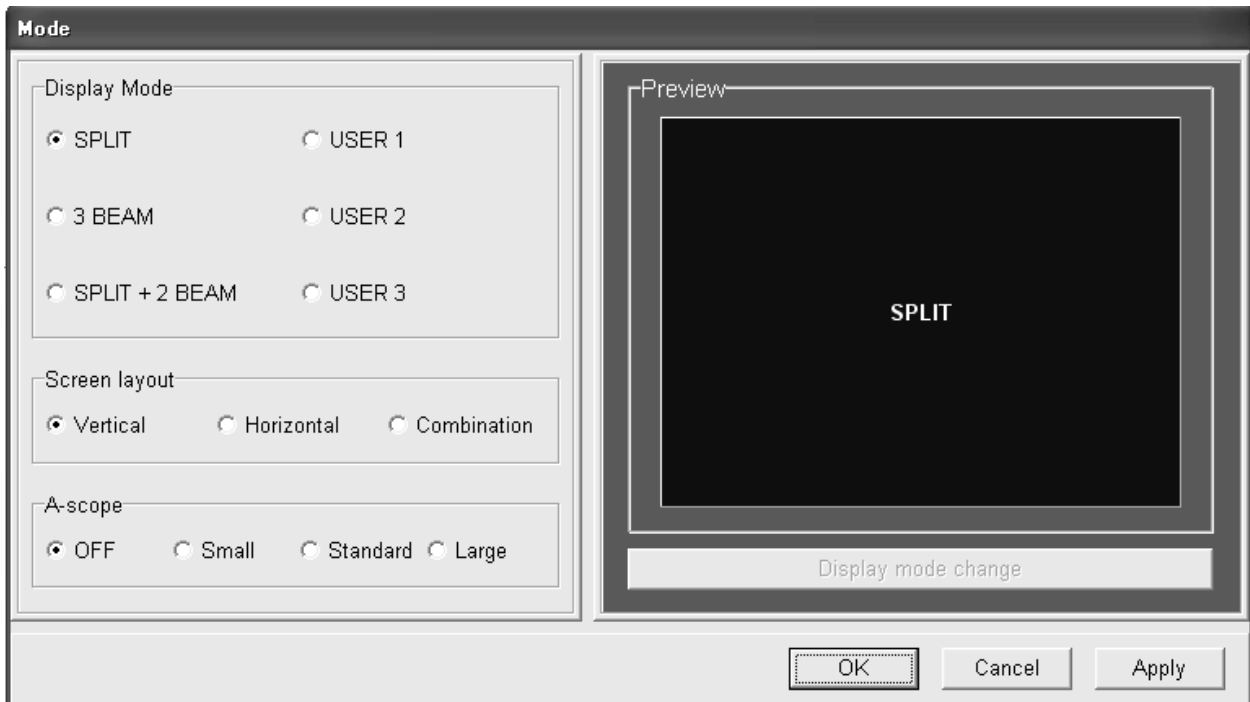

*Mode dialog box*

3. In the Display Mode window, enable User1, User2 or User3 as appropriate.

### 3. CHANGING SETTINGS

4. Click the Display mode change button.

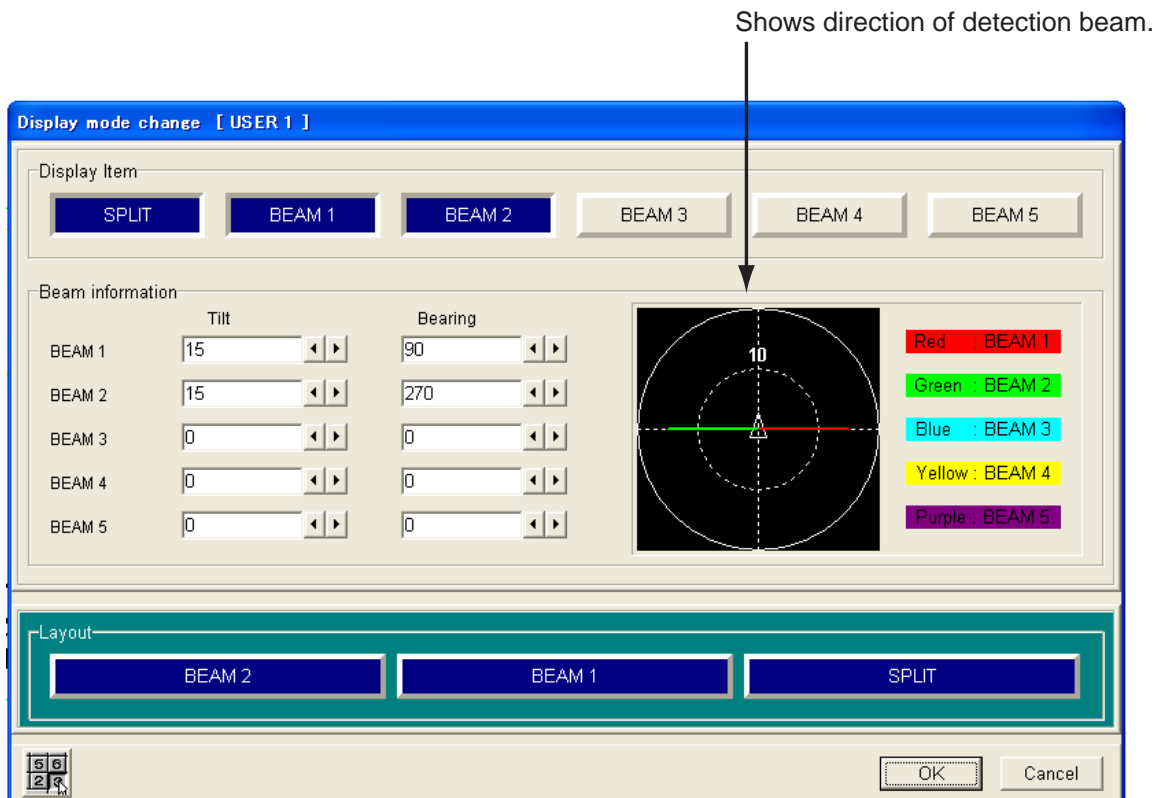

*Display mode change dialog box*

5. In the Display Item window, blue-highlight the display(s) you wish to use. In the Beam information window you may set the tilt angle and bearing for beams 1 through 5.
6. Click ◀ or ▶ successively in a Tilt box to set tilt angle (0-degree is vertical).
7. Click ◀ or ▶ successively in a Bearing box to set bearing (0-degree is ship's bow).
8. Repeat steps 6 and 7 to set tilt and bearing for other beams.
9. You can change the location of a display screen as follows:
  - a) In the Layout window, blue-highlight the display you want to change.
  - b) Blue-highlight the location in the Layout window where you want to move the display selected at a).
10. Click the OK button to close the display mode change dialog box.
11. If you want to change screen layout format, choose Vertical, Horizontal or Combination from the Screen layout window.
12. To choose the size of the A-scope display, choose OFF, Small, Standard or Large from the A-scope window.
13. Click the OK button.

## 3.2 Display Item Dialog Box

The Display Item dialog box lets you choose what indications to display.

1. Click Disp.
2. Click Display Item.

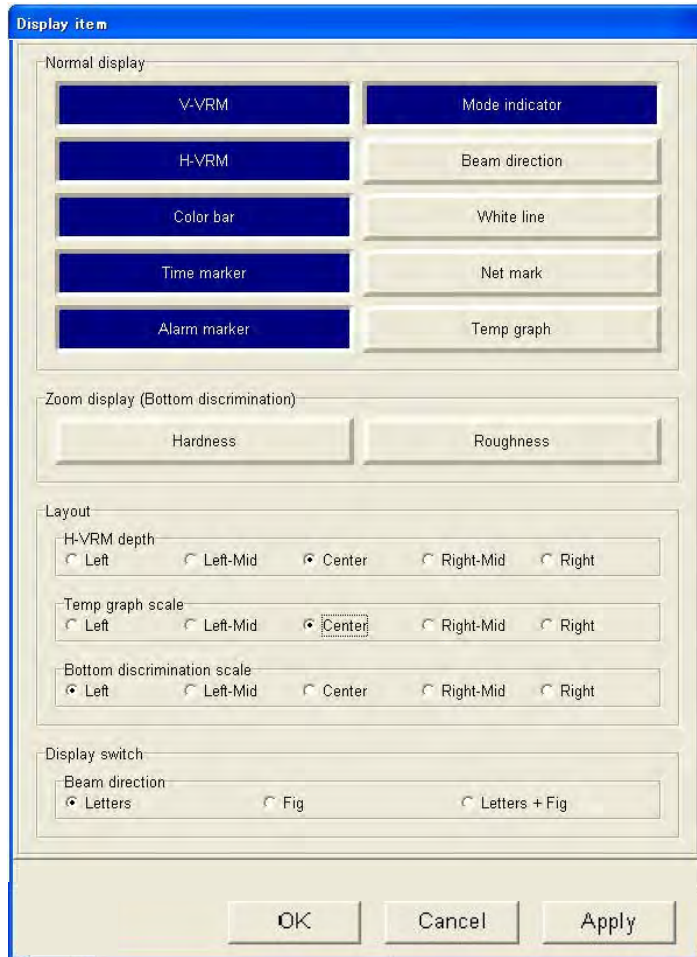

*Display item dialog box*

3. In the Display Item window, blue-highlight the items you wish to display..
4. Click the OK button.

### Display item dialog box description

**Normal display:** Choose items to show or hide: V-VRM, H-VRM, Color bar, Time marker, Alarm marker, Mode indicator, Beam direction, White line (marks bottom position), Net mark (requires net sonde or trawl sonar), Temp graph.

**Zoom display: (bottom discrimination graph):** Show Hardness and/or Roughness of bottom on bottom discrimination graph. Bottom zoom, Bottom lock or Marker zoom must be active.

**H-VRM depth:** Choose where to display the horizontal VRM depth indication: Left, Left-Mid, Center, Right-Mid, Right.

### 3. CHANGING SETTINGS

**Temp graph scale:** Choose where to display the temperature graph scale: Left, Left-Mid, Center, Right-Mid, Right.

**Bottom discrimination scale:** Choose where to display the bottom discrimination scale: Left, Left-Mid, Center, Right-Mid, Right.

**Beam direction:** Choose how to show beam direction: Letters, Figures or Letters + Figures.

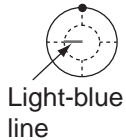

Line length: Shows default angle.  
10 deg: Radius of inner circle  
20 deg: Radius of outer circle  
Line direction: Shows bearing.

## 3.3 Echo Image Dialog Box

The Echo Image dialog box provides for control of echo sounder functions.

1. Click Setting.
2. Click Echo image.

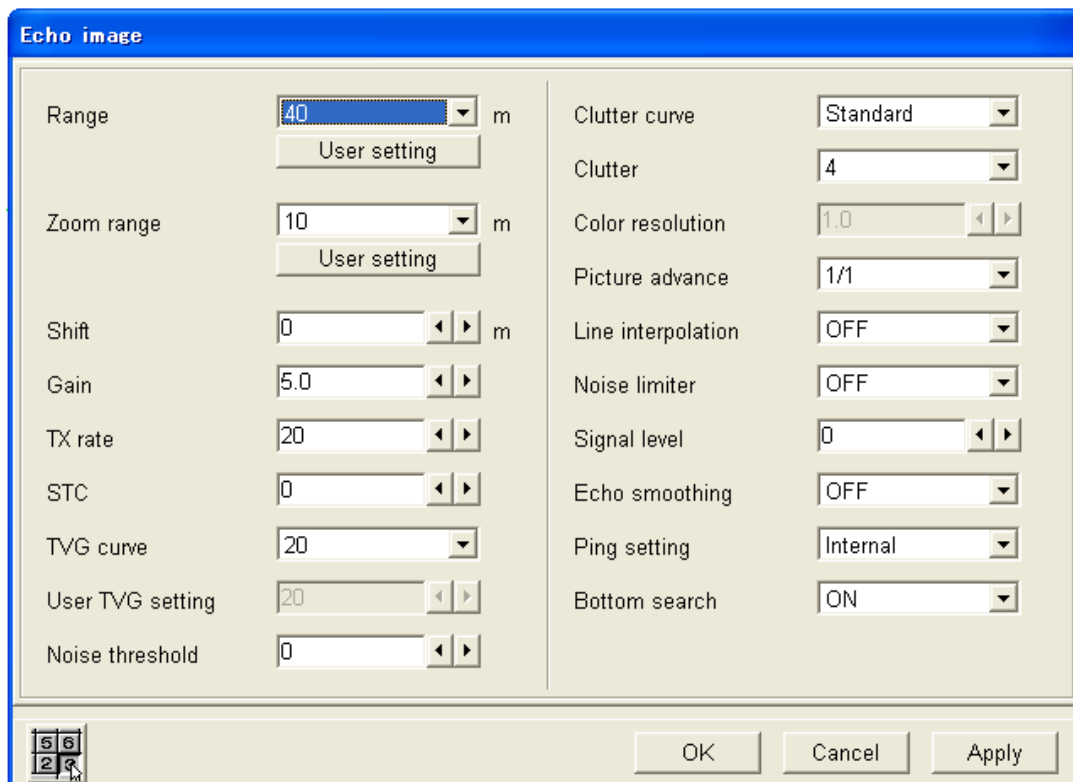

*Echo image dialog box*



### User ranges

If the factory-prepared display ranges or zoom ranges are not to your liking, you may use your own ranges, by following the procedure below.

1. Click the User Setting button below the Range box or Zoom range box.

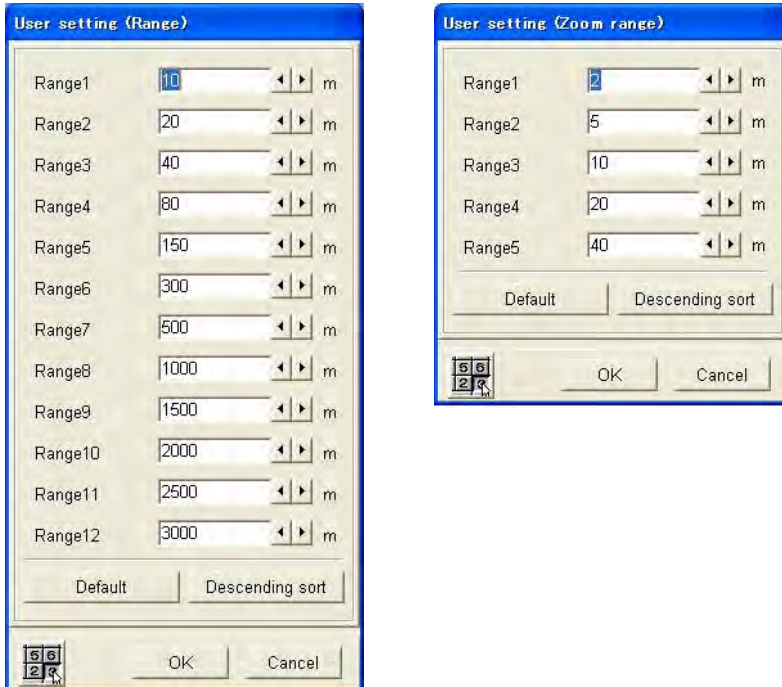

*User range dialog boxes*

2. Click ◀ or ▶ successively in the appropriate Range box to set range.

**Note:** To restore factory-prepared ranges, click the Default button. To sort ranges in order of low to high, click the Sort button.

3. Click the OK button.

### Echo image dialog box description

**TX rate:** 20 TX rates are available. Normally, the highest rate (20) is used. When in shallow waters second reflection echoes may appear between surface and actual bottom echo. In this case, lower the rate.

**STC:** STC is useful for suppressing surface noise (plankton or bubble, etc.) The setting range is 0-10; the higher the setting the greater the extent of suppression. Setting 10 suppresses noise up to 5 m. Turn off the STC when there is no noise on the screen, otherwise weak echoes may be missed.

**TVG curve:** Choose the TVG curve to use. The higher the numeric the higher the gain with depth.

**User TVG setting:** Effective when “TVG curve” is set for Manual. This allows you to set a different TVG from those provided.

**Noise threshold:** Adjusts noise present on long range (deep depth). The larger the figure, the more noise is erased.

### 3. CHANGING SETTINGS

**Color resolution:** Effective when “Clutter curve” is turned off. You may set display width dB for colors. Set display width dB for one color.

**Line interpolation:** Smooths picture when picture advance speed is 2/1, 4/1 or 8/1.

**Echo smoothing:** When echoes look “spotty”, adjust this setting. The higher the setting the greater the smoothing.

**Ping setting:** Chooses source of keying pulse, external (for use only when external echo sounder is used) or internal.

**Bottom search:** Turns bottom detection feature on or off. When turned off, “-.-“ appears as the depth indication in the status window.

## 3.4 Multi beam Dialog Box

This Multi beam dialog box sets up the multi-beam display.

1. Click Setting.
2. Click Multi beam.

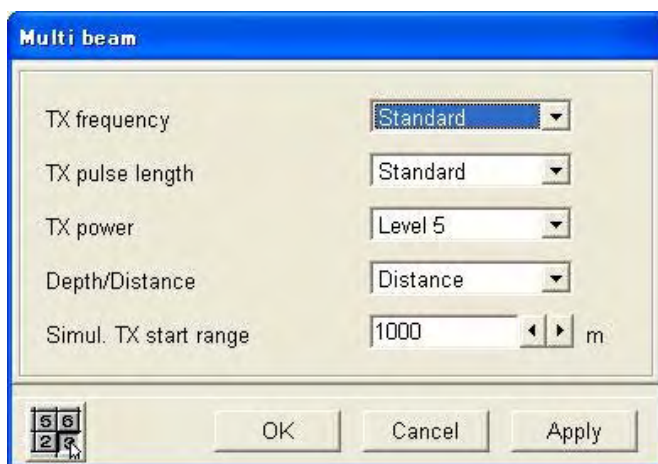

*Multi beam dialog box*

### Multi beam dialog box description

**TX frequency:** Sets Tx frequency, and the choices are Low, Standard and High. For normal use, choose Standard. When interference exists because your vessel is near another vessel whose echo sounder operates on the same frequency as the FCV-30, choose Low or High as appropriate to remove this interference.

**TX pulse width:** Pulse width is automatically changed with display range and shift. A shorter pulse offers better resolution, while a longer pulse is useful for long-range detection. Choose Standard for general sounding; Long, for longer detection range (about twice that of the Standard setting).

**Depth/Distance:** This function compensates for depth difference between the picture from the downward beam and other that from other directions when the sonar beam is oriented in a direction other than downward.

Depth: Compensation applied (range scale shows depth)

Distance: No compensation (range scale shows distance from transducer)

**TX power:** Sets output power. The higher the number the greater the output power.

**Simul. TX start Rng:** Sets start range for simultaneous transmission. The setting range is 100-5000 m. Note however that simultaneous transmission is not available with the 5000 m range.

### 3.5 Temp Dialog Box

The temp dialog box sets up temperature data (fed from temperature sensor). With connection of a temperature sensor, temperature change over time can be plotted on a graph.

1. Click System in the menu bar.
2. Click Temp.

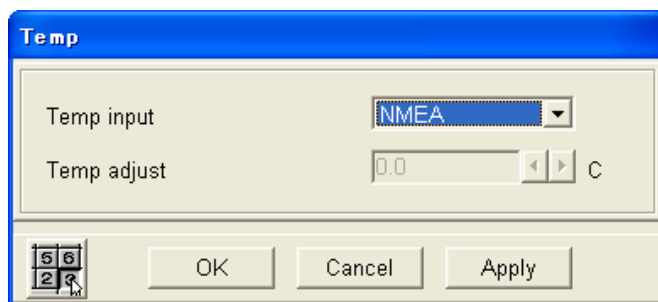

#### Temp dialog box description

**Temp input:** Choose the data format of temperature data.

CIF: Temperature data fed from net sonde

NMEA: Temperature data fed from navigation equipment.

**Temp adjust:** An offset may be applied CIF temperature data to correct it.

Offset range: -20.0°C - +20.0°C, -4°F - +68°F

### 3. CHANGING SETTINGS

## 3.6 Color Dialog Box

The Color dialog box lets you set the colors to use.

1. Click System.
2. Click Color.

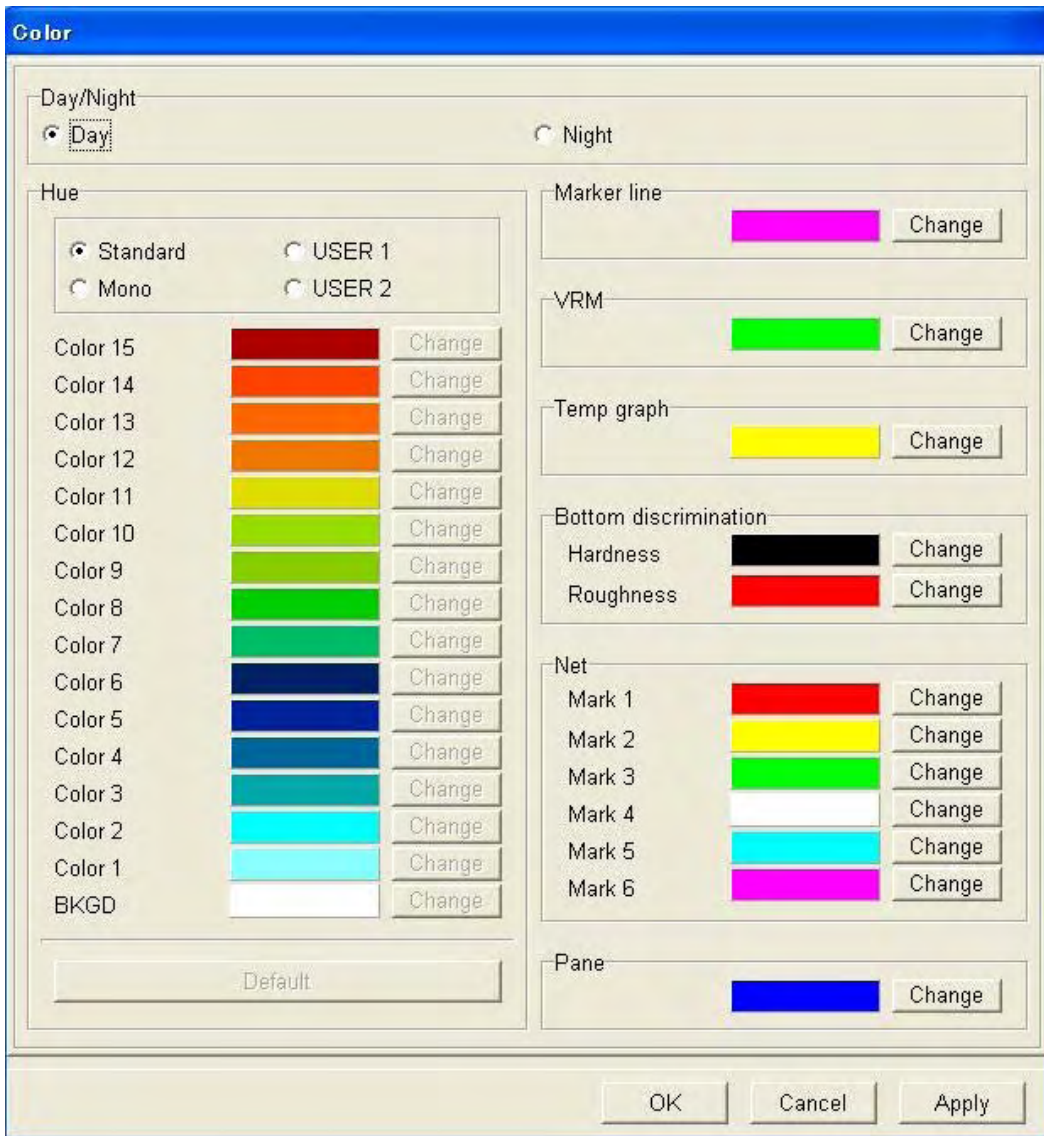

*Color dialog box*

### **Day/Night**

Chooses window background color. Daytime color provides a white background; Nighttime color a black background.

### **Hue**

You may adjust colors to meet various operating environments. User1 and User2 let you custom-adjust colors to suit your needs.

1. Choose User1 or User2 as appropriate.
2. Click the Change button corresponding to the color you want to adjust.



### *Standard color choices*

3. Choose a color from the Basic colors. If the color is suitable to you, go to step 7. To further customize the color, go to the next step.
4. Click the Define Custom Colors button.

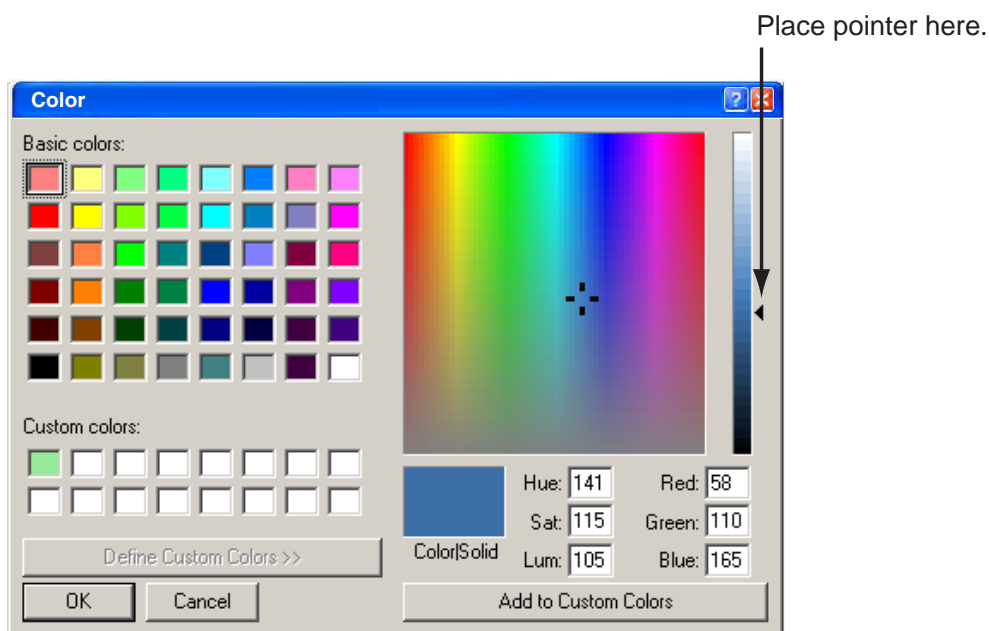

### *Custom colors*

5. Place the pointer on the arrow at right-hand side of the window.
  6. Hold down the left button while dragging the arrow to choose color desired.
  7. Click the OK button. The window closes and the color selected at step 2 is changed.
- Note:** To restore all default colors for a User color set, click the Default button.
8. Click the OK button.

**Marker line:** Choose color of marker line. The procedure is the same as for "Hue".

**VRM:** Choose the color of the VRM.

### 3. CHANGING SETTINGS

**Temp graph:** Choose the color of the graph line in temperature graph.

**Bottom discrimination:** Choose the color of the graph line in bottom discrimination graph.

**Net:** Choose the color of the color of each net sonde or trawl sonar marker.

**Pane:** Choose the color of the border around windows.

## 3.7 Unit Dialog Box

The Unit dialog box lets you choose various units of measurement.

1. Click System on the menu.
2. Click Unit.

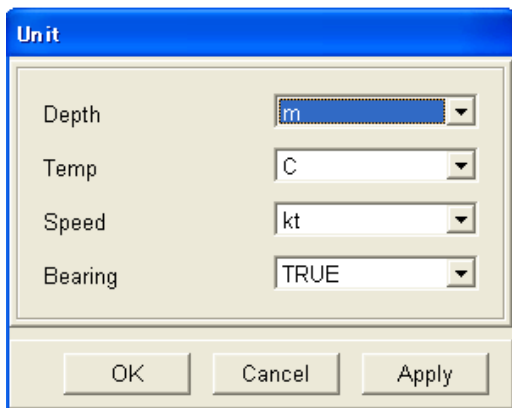

*Unit dialog box*

### Unit dialog box description

**Depth:** Choose unit of depth measurement from among meters, feet, fathoms, hiro, and passi/braza.

**Temperature:** Choose unit of temperature measurement between °C and °F.

**Speed:** Choose unit of speed measurement among knots, km/h and mph.

**Bearing:** Choose bearing format between True and Magnetic.

## 3.8 Target Sphere Calibration Dialog Box

To accurately analyze fish distribution, it is necessary to calibrate target strength using a calibration sphere. The calibration is done to jibe the target strength (TS) value displayed in the fish histogram dialog box with the TS of the calibration sphere.

Follow the procedure below to perform the calibration.

1. Suspend a calibration sphere at least 3 m directly below the transducer.
2. Open the fish histogram dialog box.
3. While observing the echo sounder image, adjust the area marker (yellow rectangle) to place the echo of the calibration sphere within the area marker. (See paragraph 1.12.1 for details.)  
Set the marker at the right edge of the screen in order to measure with most recent data. It is recommended to make the measuring area as small as possible to keep unwanted echoes out of the measuring area, however the calibration can be performed with any size measuring area.
4. Note the TS value in the fish histogram dialog box.  
There is no problem if the TS value and the TS value of the calibration sphere do not agree. Ideally, it is desirable if the distribution graph in the fish histogram window shows only one bar for the calibration sphere, however the calibration can be executed regardless of distribution.
5. Confirm that the echo from the calibration sphere appears in the area marker in consecutive scans.
6. Click System on the menu bar.
7. Click Test/Initialization.

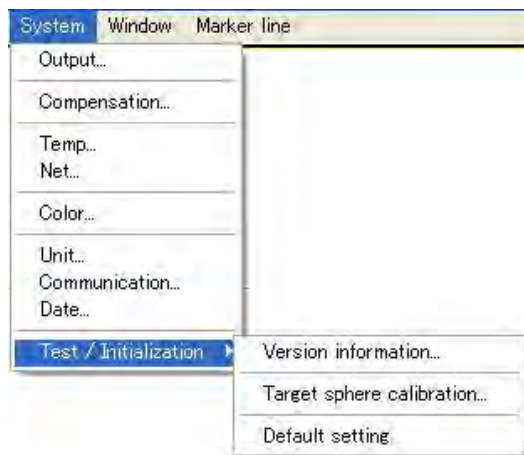

### 3. CHANGING SETTINGS

8. Click Target sphere calibration.

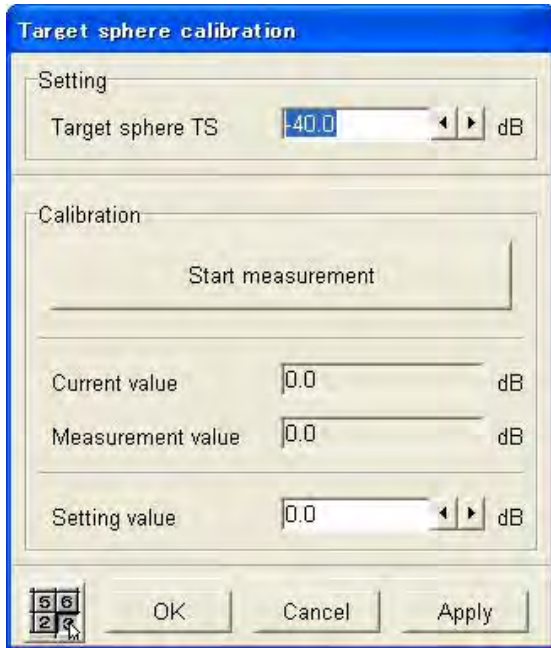

9. In the Target sphere TS box, use ◀ or ▶ to set the TS value (fixed value) of the target sphere.
10. Click the Start measurement button.  
The TS value of the calibration sphere inside the area marker is calculated and is displayed in the Setting value box.
11. If necessary you may fine tune the found value.
12. Click the OK button to finish.



## 3.9 External Echo Sounder

This equipment can show the image from the FURUNO echo sounder ETR-30N.

### 3.9.1 Displaying image from external echo sounder

1. Click File on the menu bar.
2. Click ETR. The ETR-30N starts transmitting and the image from it appears in the "external echo sounder" window. The message "ETR connection confirmed..." appears at the top of the window until transmission starts.

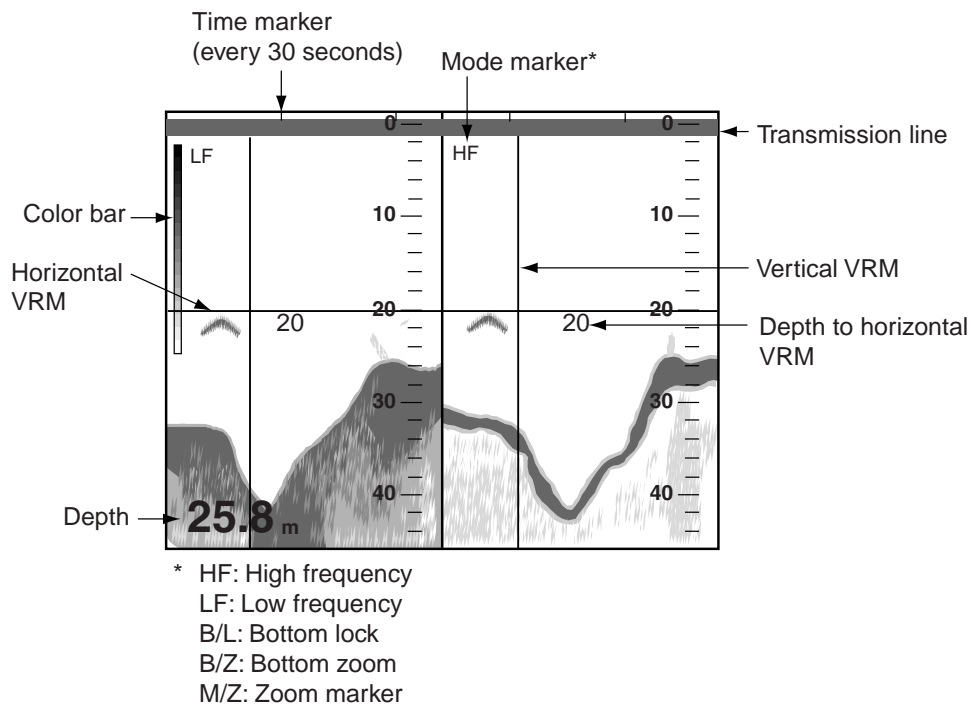

**Note:** A pop-up menu for the external echo sounder display is available by right clicking that display.

See the next several paragraphs for menus available with the external echo sounder display.

### 3. CHANGING SETTINGS

#### 3.9.2 File menu

Click File on the external echo sounder window's menu bar.

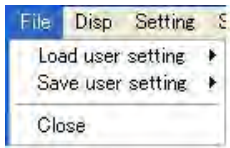

**Load user setting:** Recall saved user settings.

**Save user settings:** Three sets of user settings can be saved. For further details, see paragraph 1.20.1.

**Close:** Stop Tx/Rx by ETR-30N and close external echo sounder window.

### 3.9.3 Display menu

Click Display on the external echo sounder window's menu bar.

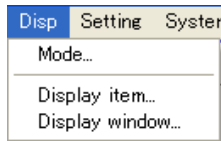

#### ETR setting window



**Display mode:** Choose display mode among High frequency-single, Low frequency-single, Dual frequency, High frequency-zoom and Low frequency-zoom.

**Zoom mode:** Choose the zoom mode among Bottom lock, Bottom zoom and Marker zoom. The display mode must be high frequency zoom or low frequency zoom, otherwise this feature is inoperative.

**Screen layout:** Show the external echo sounder image in horizontal or vertical split. The low frequency-zoom, high frequency-zoom display or dual frequency display must be active, otherwise this feature is inoperative.

**A-scope:** Turn the A-scope display on or off.

### 3. CHANGING SETTINGS

#### **ETR display item dialog box**

Show or hide Color bar, Time marker, Mode indicator, V-VRM, H-VRM and Depth indication.

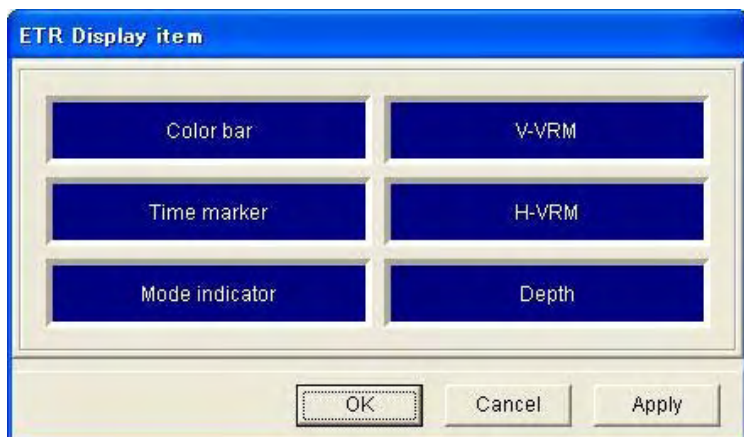

**Display item:** Choose to display or hide color bar, time marker, mode indicator, horizontal VRM, vertical VRM and depth.

**Display size:** The size of the external echo sounder window may be set to small, medium or large.

### 3.9.4 Setting menu

1. Click Setting on the echo sounder window's menu bar.
2. Click Echo image.

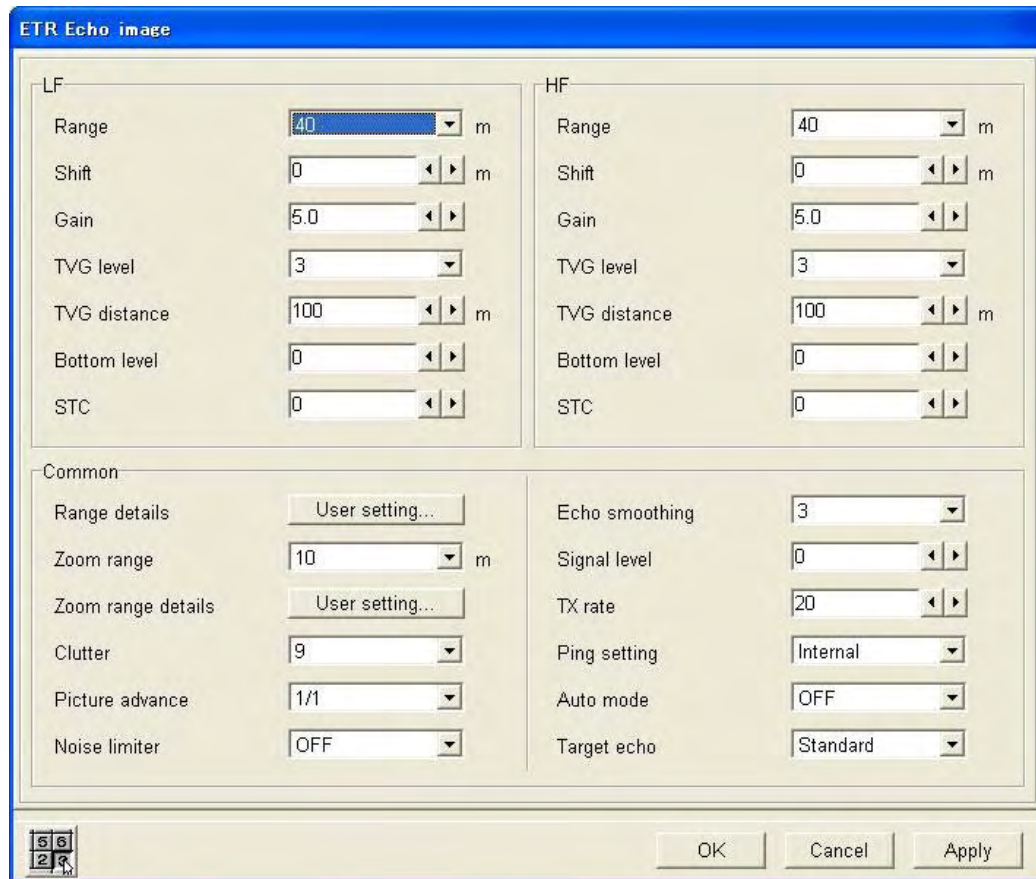

**Range:** Choose display range among eight ranges. Display range is automatically chosen when the Auto mode (Fishing or Cruising) is active.

**Shift:** Set amount of display range shift.

**Gain:** Set gain. Gain is automatically chosen when the Auto mode (Fishing or Cruising) is active.

**TVG level:** Compensate for propagation attenuation of the ultrasonic waves. It does this by equalizing echo presentation so that fish schools of the same size appear in the same density in both shallow and deep waters. The higher the figure, the lower the gain on near range.

**TVG distance:** Set effective range of TVG.

**Bottom level:** If the depth indication is unstable in automatic or manual gain adjustment, adjust bottom level to get stable depth indication.

### 3. CHANGING SETTINGS

**STC:** Help distinguish surface fish from surface echoes. The setting range is 0-10; the higher the setting the greater the extent of suppression. Setting 10 suppresses noise up to 5 m. Turn off the STC when there is no noise on the screen, otherwise weak echoes may be missed.

**Range details:** If the factory-set ranges are not to your liking, you may change them as desired.

**Zoom range:** Set zoom ranges.

**Zoom range details:** If the factory-set zoom ranges are not to your liking, you may change them as desired.

**Clutter:** Adjust to suppress on-screen clutter. The higher the figure, the stronger the amount of clutter suppression. "0" turns off the clutter feature. Clutter is automatically adjusted when the Auto mode (Fishing or Cruising) is active.

**Picture advance:** Choose the speed of picture advancement.

**Noise limiter:** Turn on to reject noise. The settings are OFF, NL1, NL2 and NL3, and NL3 provides the highest degree of noise suppression.

**Echo smoothing:** Adjust this item when echoes appear "spotty". The higher the setting the greater the smoothing.

**Signal level:** Sedimented water or reflections from plankton may be painted on the display in green or light-blue. These weak echoes may be erased with the signal level function.

**Tx rate:** Choose the interval between transmissions. The smaller the figure the longer the time between transmissions and thus the longer an image remains on the screen.

**Ping setting:** Interference from another echo sounder or a scanning sonar may be suppressed by synchronizing transmission with the offending echo sounder or scanning sonar. Choose External to synchronize transmission. Select Internal when no echo sounder or scanning sonar is connected, or to synchronize and transmit with the TX signal from this equipment.

**Auto mode:** Turn the auto mode ON or OFF. When activated display range, gain and clutter are automatically adjusted, for virtually hands-free operation.

**Display range:** Adjusted to display bottom echo on the screen.

**Gain:** Adjusted to display the bottom echo in reddish-brown color.

**Clutter:** Adjusted to suppress weak echoes (such as those from sedimented water).

Two auto modes are available: Cruising and Fishing. "Cruising" suppresses weak echoes to show the bottom echo clearly. "Fishing" displays weak echoes clearly.

**Target echo:** The default setting is "Standard", which is useful for general fishing. If the objective is whitebait, choose "Surface".

### 3.9.5 System menu

1. Click Setting on the menu bar
2. Click System.



#### ETR TX/RX dialog box

Click TX/RX on the System menu to show this dialog box.

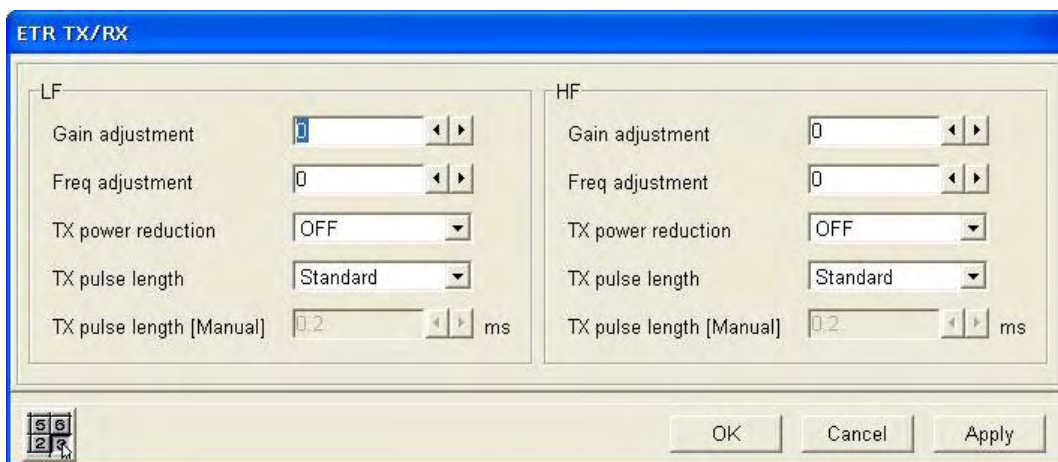

**Gain adjustment:** Compensate for too high or too low gain and adjust gain balance of low and high frequency. Setting range: -50 to 50.

**Freq adjustment:** Fine tune the Tx frequency when interference cannot be rejected otherwise. Setting range: -10.0 to 10.0.

**TX power reduction:** This setting is normally “OFF”. However, if an echo sounder of the same frequency as your own is being operated nearby, interference may appear on your display. In this case, both parties should lower their TX power to remove the interference. Turn this item ON to lower TX power.

**Tx pulse length:** Pulse length is automatically selected according to display range and display shift settings. For manual selection, choose a short pulse when resolution is important and choose a long pulse when long-range detection is your objective. To improve resolution on zoom displays, choose the pulse length setting Short1, Short 2 or Manual.

**Short1:** Detection resolution is improved, however detection range is shorter (1/4 of standard) compared to Short2.

**Short2:** Detection resolution is improved, however detection range is shorter (1/2 of standard).

**Standard:** Use for general fishing operations.

**Long:** Detection resolution is lower, however detection range is longer (2x normal). Depending on the range, the Tx rate is 1/2 of the normal.

**Manual:** Operator chooses pulse length.

### 3. CHANGING SETTINGS

**Tx pulse length (Manual):** Operative when TX pulse length is set to Manual. The pulse length range is 0.2-5(ms). The smaller the figure, the better the resolution, however the detection range is shorter. Conversely the larger the figure, the better the detection but the lower the resolution.

#### **ETR Compensation dialog box**



**Draft:** To get depth from the sea surface (rather than the transducer), enter ship's draft. Setting range: -15.0-60.0(m).

**Sound velocity:** Adjust the sound velocity of the Tx pulse if the depth indication is incorrect. Setting range: 200-2000(m/s).

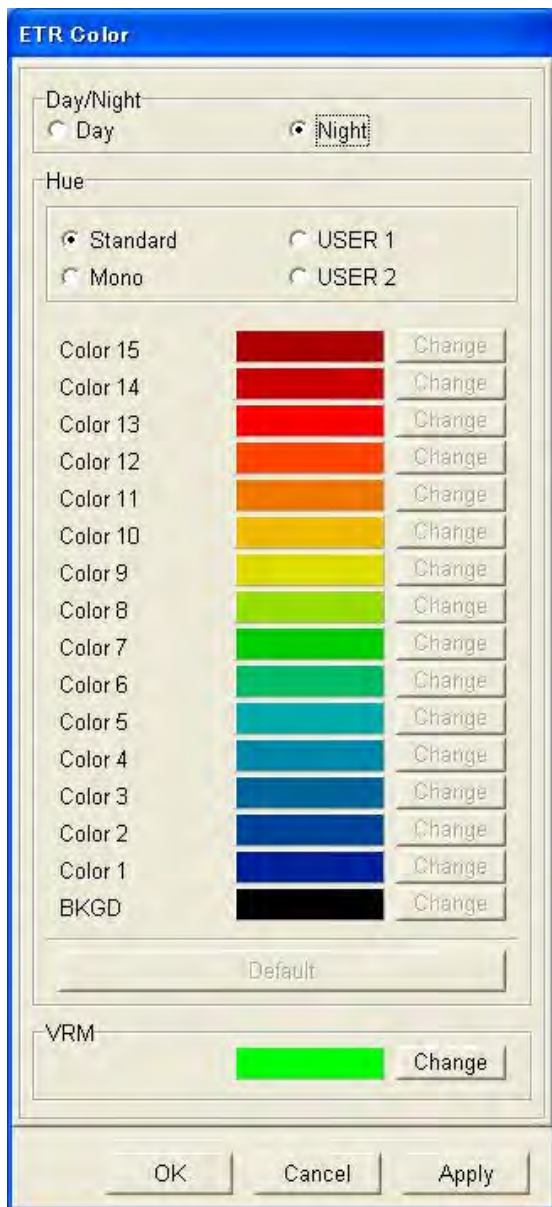

**ETR Color dialog box**

**Day/Night:** Choose background color of the echo sounder window. Choose “Day” for white background; “Night” for black background.

**Hue:** Choose color arrangement for the echo sounder image. The procedure is the same as that shown in paragraph 3.6.

**VRM:** Choose color for the horizontal and vertical VRMs.

### 3. CHANGING SETTINGS

#### **Unit menu**

Choose unit of depth measurement.

#### **Test/Initialization menu**

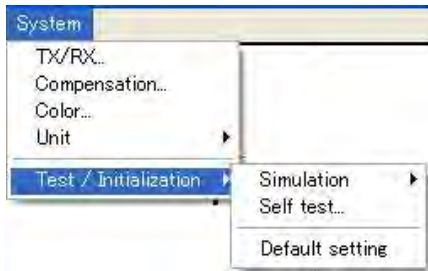

**Simulation:** The simulation mode provides simulated echo sounder operation to help acquaint with the features of this equipment, without the need for connecting the transducer. The echo sounder image stored in the memory is played back on the echo sounder window. "Demo" appears on the title bar of the echo sounder window when the simulation mode is active.

**Self test:** Display the program no. of the ETR-30N's ROM, RAM and E2PROM and the depth.

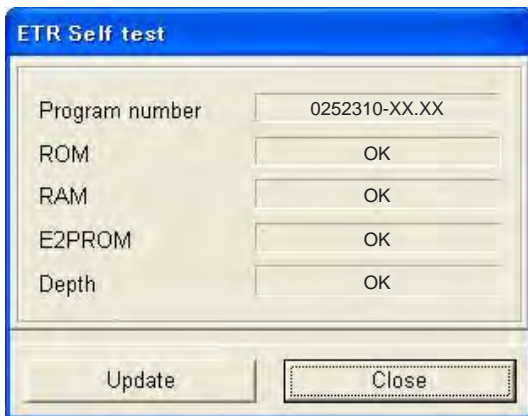

**Default setting:** Restore the ETR-30N's default settings.

# 4. MAINTENANCE & TROUBLESHOOTING

---

## 4.1 Maintenance

Regular maintenance is important for maintaining good performance. Follow the recommended procedures to keep the equipment in good working order.

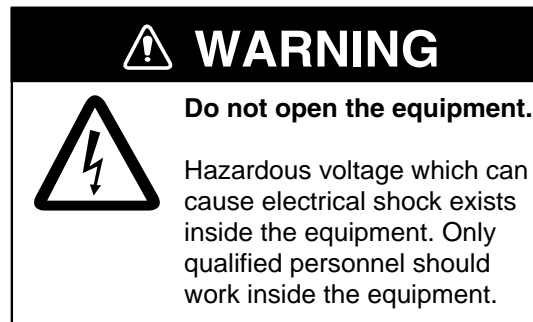

### 4.1.1 Check points

The items to check on a regular basis are tabulated below.

Check point	Action, remedy	Frequency
Cabling	Check for damage. Replace if damaged.	Monthly
Connectors on units	Check for tight connection. Reconnect as necessary.	Monthly
Ground on units	Check for corrosion. Remove corrosion as necessary.	Monthly

### 4.1.2 Cleaning

Dust on the equipment should be removed with a soft, dry cloth. For stubborn dirt, water-diluted mild detergent may be used. DO NOT use chemical cleaners to clean the equipment; they can remove paint and markings.

### 4.1.3 Replacing fuses

Fuses protect the processor unit and transceiver unit from overvoltage and internal fault. If a fuse blows find the cause before replacing it. If it blows again after replacement, request service.

 <b>WARNING</b>
<p><b>Use the proper fuse.</b></p> <p>Use of a wrong fuse can result in damage to the equipment or cause fire.</p>

Unit	Location of fuse	How to replace	Rating	Code No.
Processor unit	In fuse holder	Unscrew the fuse holder (on rear panel) and replace fuse. Screw in fuse holder	FGMB 5A AC250V	000-148-280
Transceiver unit	In fuse holder	Open the power switch cover at bottom of unit. Unscrew the fuse holder and replace fuse. Screw in fuse holder	100 VAC: FGMB 10A 250 VAC	100 VAC: 000-104-815
			200 VAC: FGMB 5A AC125V	200 VAC: 000-148-280

### 4.1.4 Transducer

Remove marine life and growth from the transducer face, using a piece of wood. DO NOT paint the transducer face. Handle the transducer carefully.

### 4.1.5 Trackball

If the trackball does not roll smoothly it may require cleaning. Do the following to clean the trackball.

1. Turn the ring on the trackball 45°.

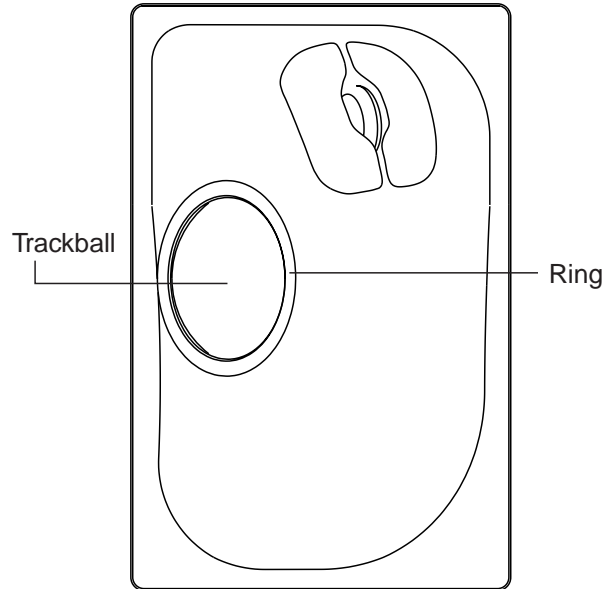

*Trackball*

2. Clean the ball with a soft lint-free cloth, and then blow carefully into the ball-cage to dislodge dust and lint.
3. Look for a build-up of dirt on the metal rollers. If dirty, clean the rollers using a cotton swab moistened lightly with isopropyl-rubbing alcohol.
4. Make sure that fluff from the swab is not left on the rollers.
5. Replace the ball and retainer ring. Be sure the retainer ring is not inserted reversely.

## 4.2 Troubleshooting

The section provides information which the user can follow to restore normal operation. If normal operation cannot be restored, do not attempt to check inside any unit. Any repair work is best left to a qualified technician.

### Troubleshooting

Symptom	Cause	Remedy
No echo sounder image or depth scale	Battery may be dead.	Check battery voltage.
	Fuse may have blown.	Check fuse in processor and transceiver units.
	Power cable may have become disconnected.	Connect power cable firmly.
No echo sounder image but characters and markers appear.	Picture advance may have been stopped.	Set picture advance speed to other than STOP.
	Transducer cable may have become disconnected.	Reconnect transducer cable.
Echo sounder image appears but no zero line.	Display start position may have been shifted.	Set scale to show zero line.
Sensitivity is low.	Gain setting is too low.	Raise the gain.
	Marine life is adhering to transducer face.	Clean the transducer face.
	Vessel is in heavily sedimented water	No remedy available.
	Bottom is too soft to return an echo.	No remedy available
No depth indication	Bottom is off the screen.	Change the range in order to display the bottom echo.
	Bottom search is turned off.	Turn on Bottom Search, in the Echo image dialog box.
Heavy noise and interference	Transducer located too close to engine.	Relocate the transducer.
	Earth connection has loosened.	Reconnect earth.
	Same-frequency echo sounder being operated nearby.	Contact the vessel and request that they lower the gain on their sounder. Activate the noise limiter.
Position is wrong or is not shown (external input of said data)	Connector from navigator may have become disconnected.	Reconnect cable
	Navigator may be malfunctioning	Check navigator.

## 4.3 Restoring Default Settings

You may wish to restore all default settings to start operation afresh or to clear stray data. If you want to restore your previous settings, jot them down and restore them after clearing the memory.

1. Click System.



### *System menu*

2. Click Test/Initialization.

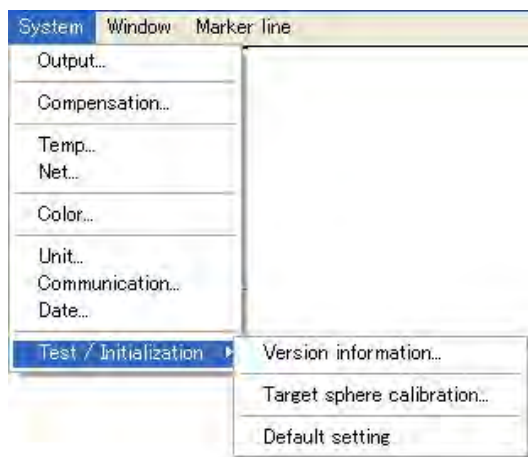

3. Click Default setting.

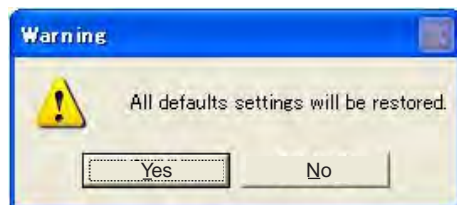

#### 4. MAINTENANCE & TROUBLESHOOTING

4. Click the Yes button.

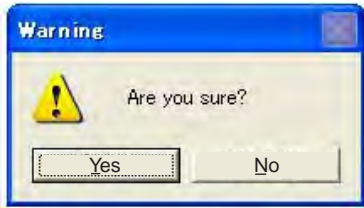

5. Click the Yes button to restore all default settings.

### 4.4 Finding Software Version

1. Click System > Test/Initialization > Version Information.

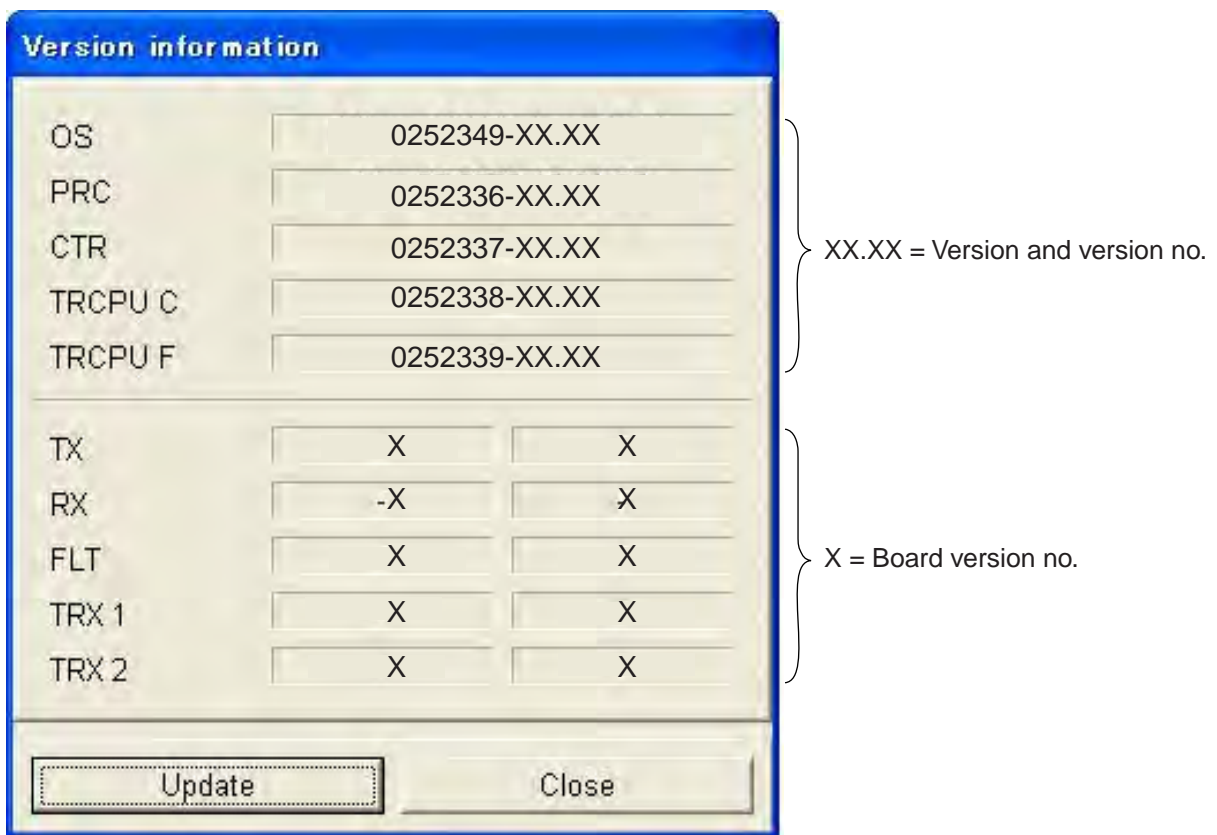

#### *Version information*

2. Click the Close button to quit.



# APPENDIX

## Menu Tree

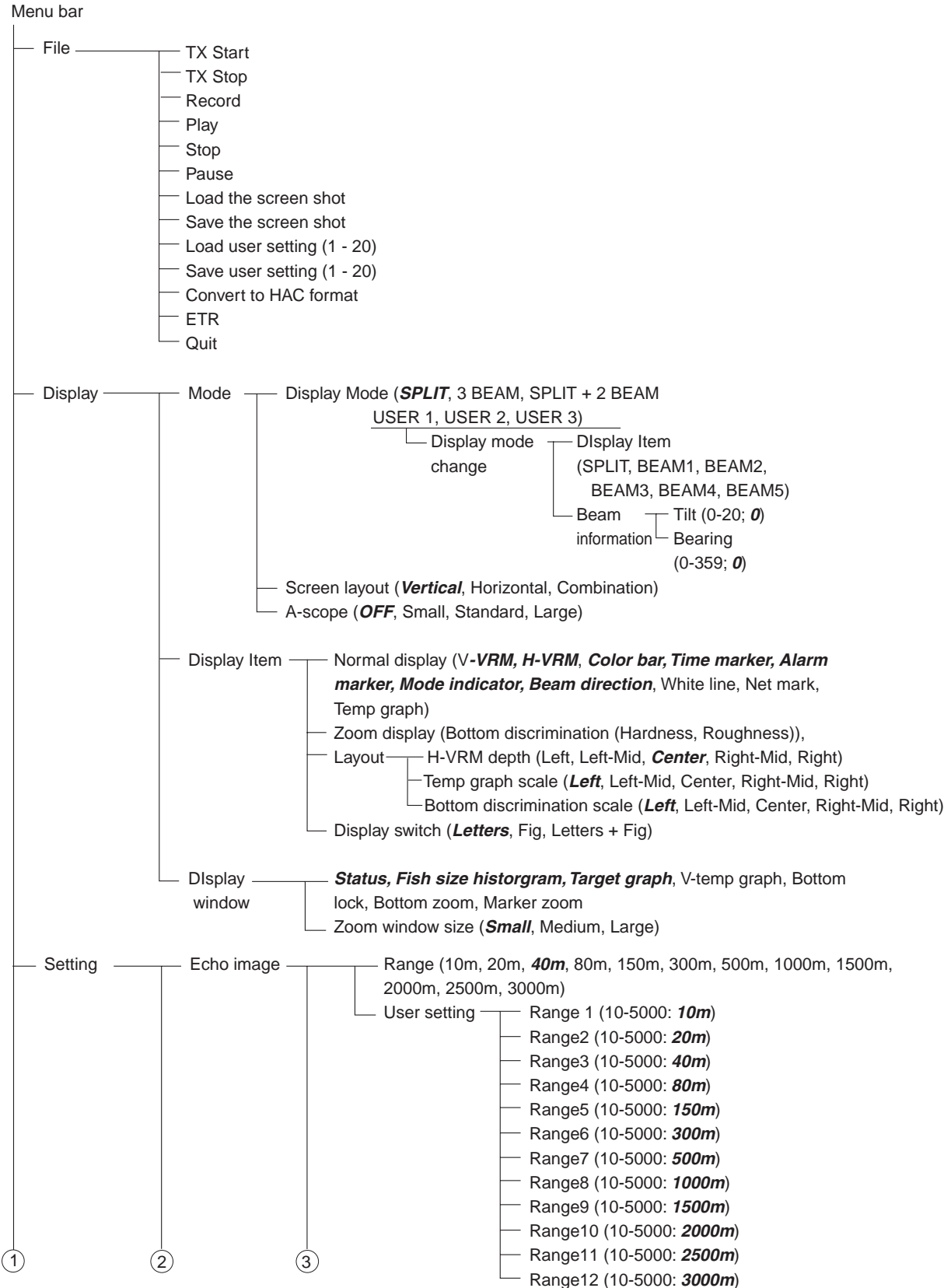

①

②

③

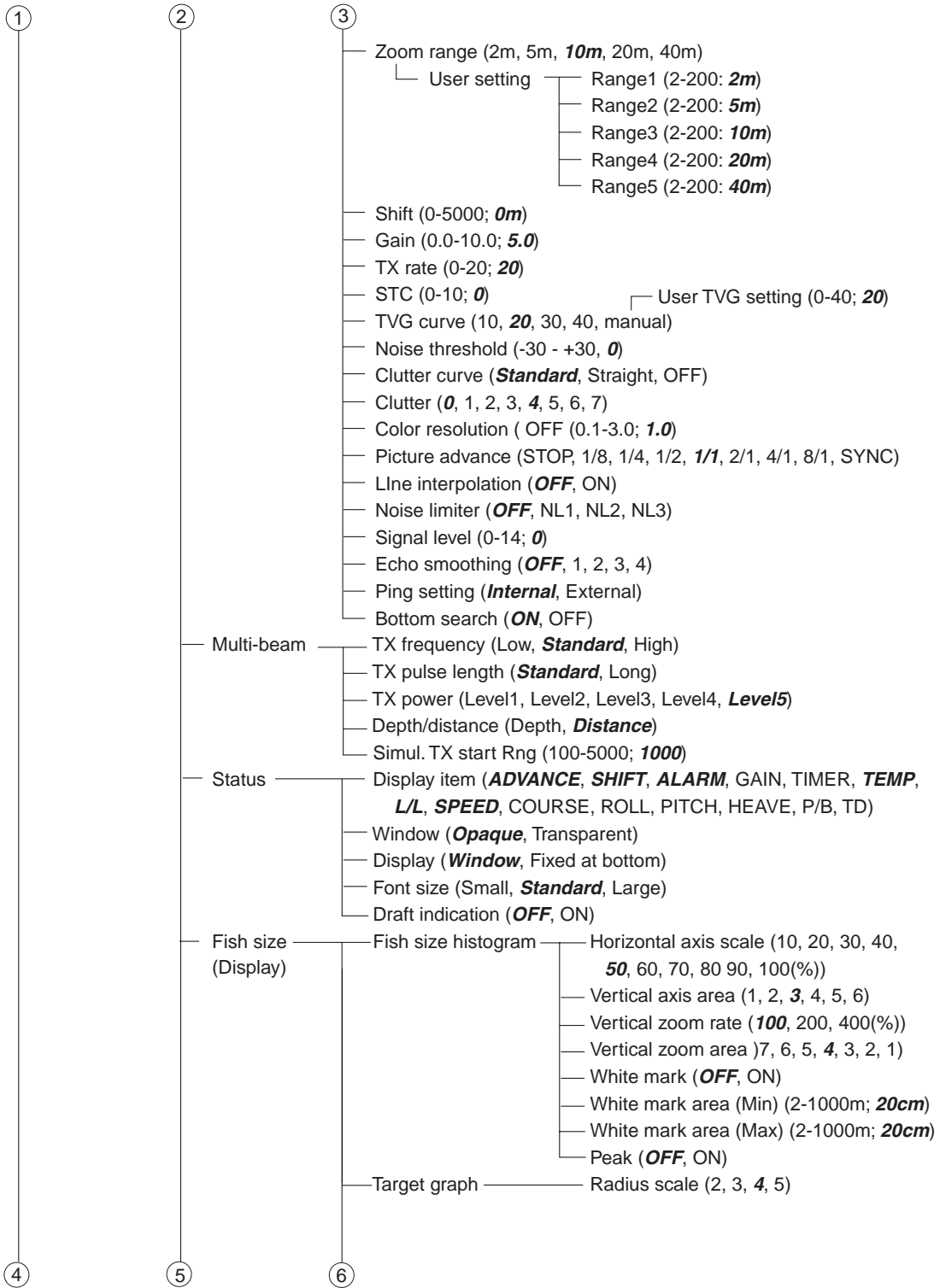

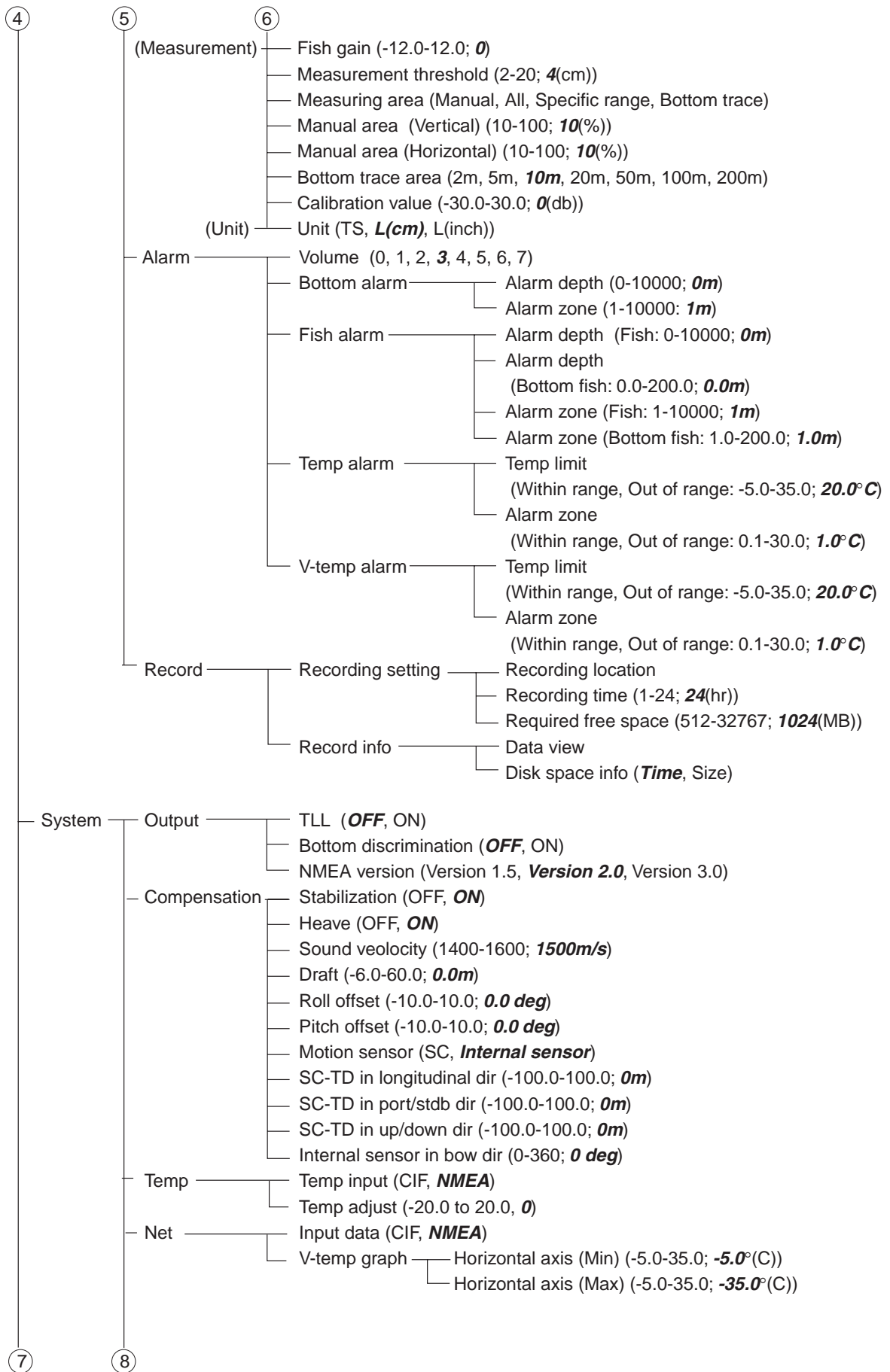

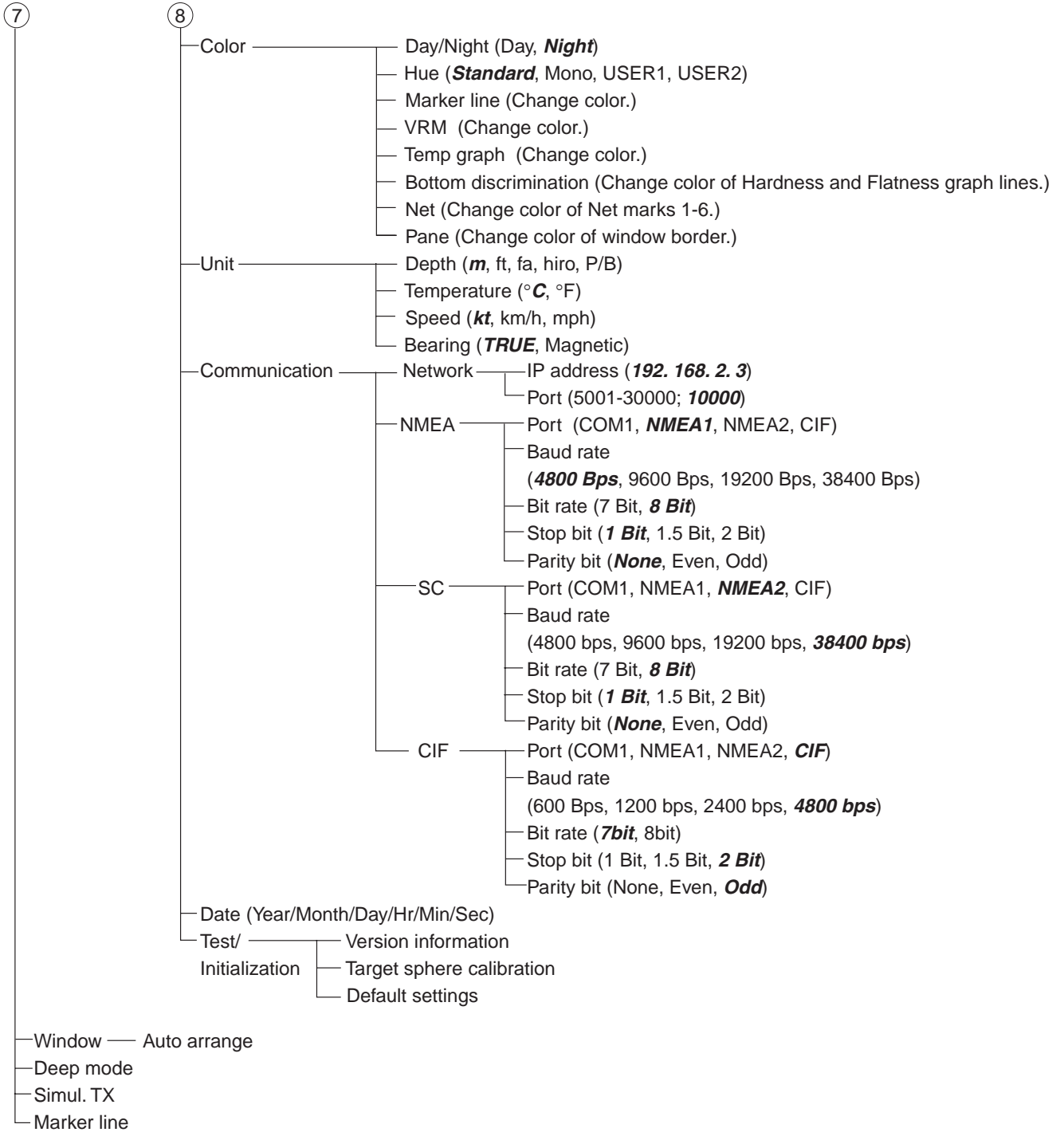

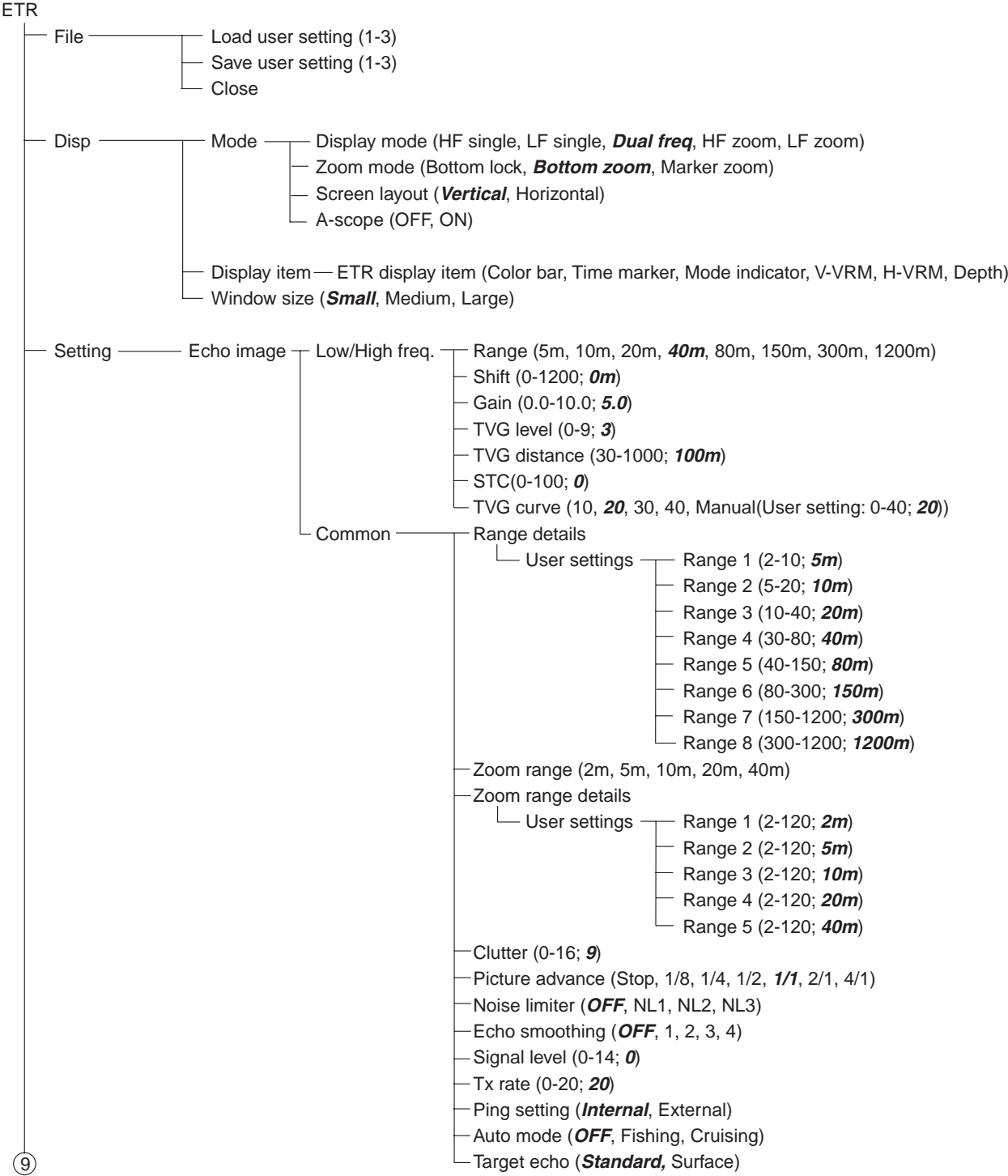

# APPENDIX

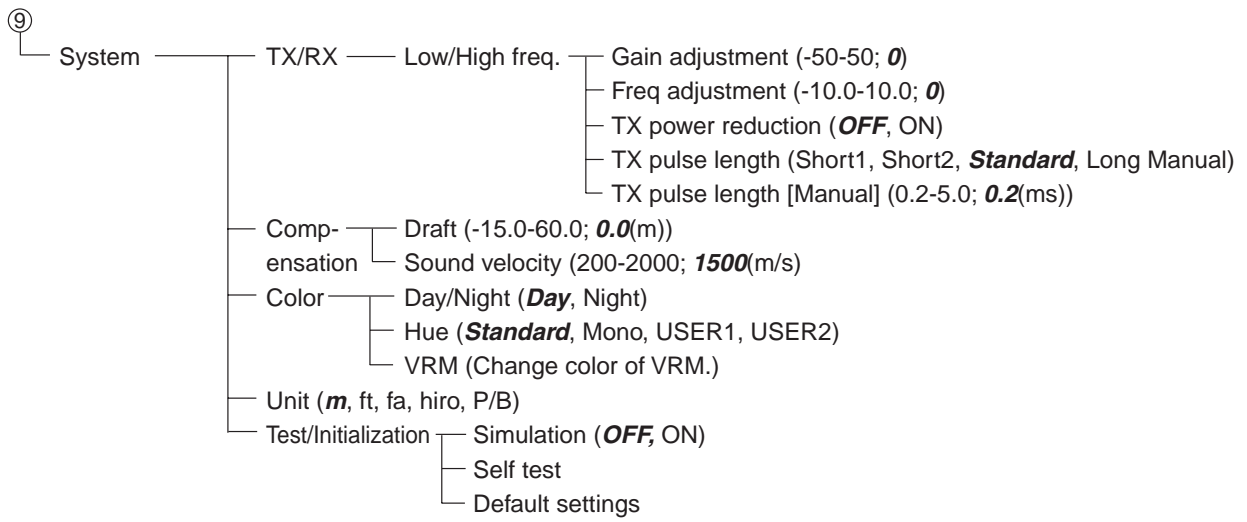

# Screen Division

## A-scope display ON

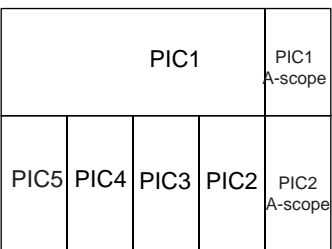
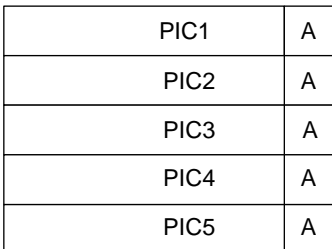
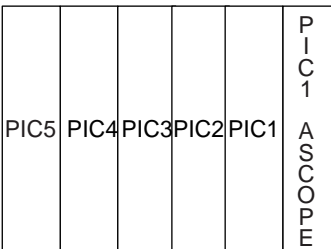
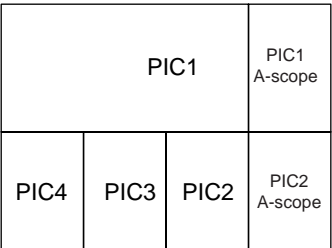
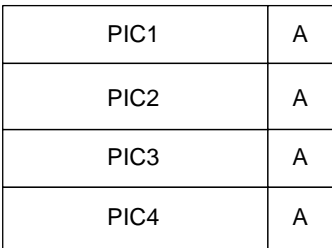
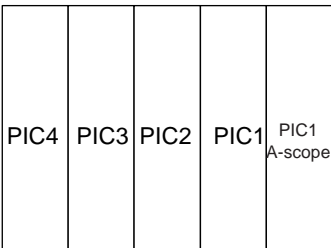
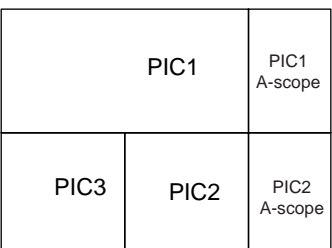
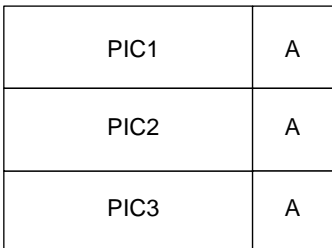
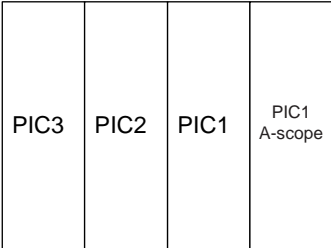
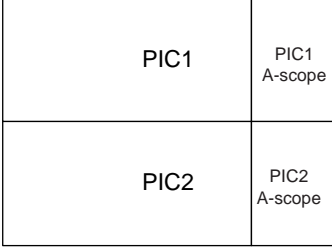
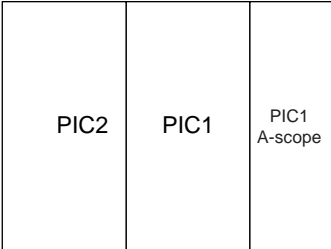
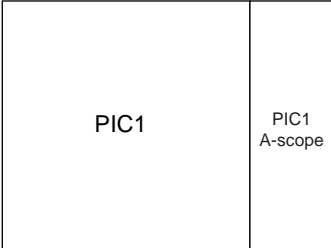

Division: Left, Right

Division: Up, Down

Division: Combination

### A- scope display OFF

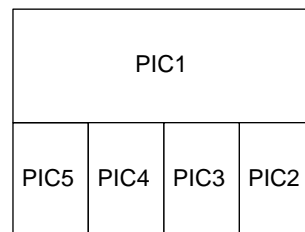
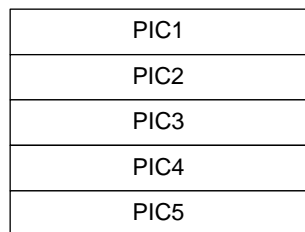
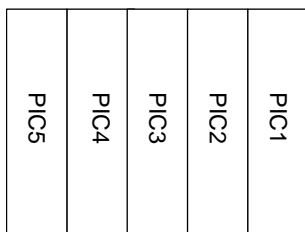
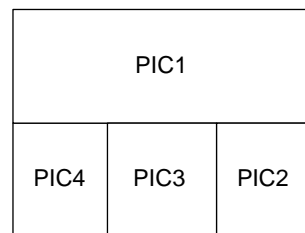
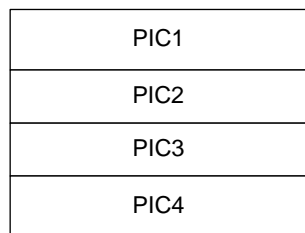
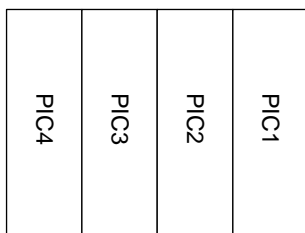
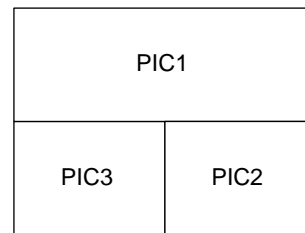
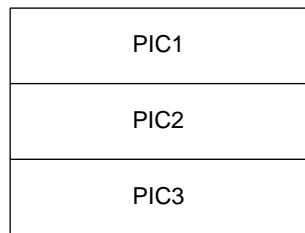
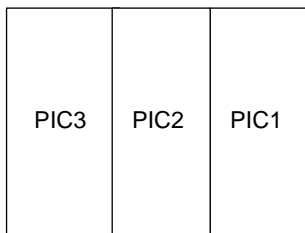
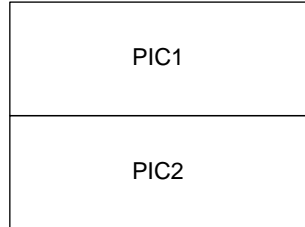
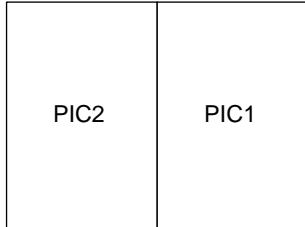
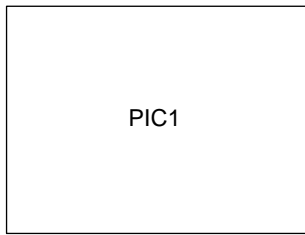

Division: Left, Right

Division: Up, Down

Division: Combination



## **SPECIFICATIONS OF THE COLOR VIDEO SOUNDER FCV-30**

### **1. DISPLAY**

- |                           |  |
|---------------------------|--|
| 1.1 Display               | Optional supply or commercial monitor<br>XGA (1024x768), SXGA (1280x1024)  |
| 1.2 Display Range         | Range: 10-5000 m, Shift: 0-5000 m, Zoom range: 2-200 m   |
| 1.3 Display Mode          | SPLIT, 3 beam, SPLIT + 2 beam, User1, User2, User3   |
| 1.4 Display Window        | Status, Fish size histogram, Target position graph, V-temp graph,<br>Bottom lock, Bottom zoom, Marker zoom, Bottom discrimination<br>graph |
| 1.5 Display Advance Speed | 8 settings (Freeze, 1/8, 1/4, 1/2, 1/1, 2/1, 4/1, 8/1, SYNC)   |
| 1.6 Alarm                 | Bottom alarm, Fish alarm, Bottom fish alarm, Temperature alarm,<br>V-temp alarm  |
| 1.7 A-scope               | Display selectable among 1/6, 1/8 or 1/10 of screen width. Each<br>transmission is displayed on A-scope.                                   |
| 1.8 Record                | Raw data, image data   |

### **2. TRANSCEIVER**

- |                        |  |
|------------------------|--|
| 2.1 Output Power       | 4 kW                                   |
| 2.2 TX Rate            | Max. 600 pulse/min                     |
| 2.3 TX Frequency       | 38 kHz                                 |
| 2.4 Beam Control Range | Bow, stern, port, starboard within 20° |

### **3. DATA I/O**

- |                           |  |
|---------------------------|--|
| 3.1 I/O Port              | NMEA, CIF, USB (2.0), LAN (10 BASE-T/100BASE-TX)   |
| 3.2 NMEA Input Sentences  | IEC61162-1, NMEA 0183 Ver. 2.0/3.0<br>BWC, GGA, GLC, GLL, GNS, GTD, MTW, RMA, RMB,<br>RMC, VHW, VTG, ZDA, att, hve |
| 3.3 CIF Input Data        | Water temperature, Net depth, Sonde number   |
| 3.4 NMEA Output Sentences | IEC61162-1, NMEA 0183 Ver. 1.5/2.0/3.0<br>SDDBS, SDDBT, SDDPT, SDTLL, YCMTW, SDvrm, SDbtm                          |

### **4. POWER SUPPLY**

- |                      |                            |
|----------------------|----------------------------|
| 4.1 Processor Unit   | 100-240 VAC: 3A-2A         |
| 4.2 Transceiver Unit | 100-120/200-240 VAC: 5A-3A |

**5. ENVIRONMENTAL CONDITION**

## 5.1 Useable Temperature Range

Processor Unit	0°C to +40°C
Transducer	-5°C to +35°C
Transceiver Unit	-15°C to +45°C (with Motion Sensor) -15°C to +55°C (no Motion Sensor)
Control Unit	-15°C to +55°C

5.2 Relative Humidity Less than 95% (at 40°C)

## 5.3 Water Resistance

Processor Unit	IP20 (not waterproof)
Control Unit	Front panel: IP22, Other than front panel: IP20
Transceiver Unit	Not waterproof

5.4 Vibration (IEC60945 Ed. 4) From 2 Hz-5 Hz to 13.2 Hz: Amplitude  $\pm 1$  mm  $\pm 10\%$   
(max. acceleration at 13.2 Hz is  $7\text{m/s}^2$ )  
13.2 Hz to 100 Hz: Max. acceleration  $7\text{m/s}^2$  (fixed)

**6. COATING COLOR**

6.1 Processor Unit 2.5GY5/1.5

6.2 Transceiver Unit 2.5GY5/1.5

6.3 Control Unit N2.0

# INDEX

---

## **A**

- Alarms
  - audio volume ..... 1-30
  - bottom alarm ..... 1-28
  - bottom fish alarm ..... 1-28
  - enabling, disabling ..... 1-29
  - fish alarm ..... 1-28
  - temperature alarm ..... 1-28
  - vertical temperature alarm ..... 1-28
- A-scope display ..... 1-27

## **B**

- Bottom alarm ..... 1-28
- Bottom discrimination graph window
  - ..... 2-14
- Bottom fish alarm ..... 1-28
- Bottom zoom window ..... 2-12
- Bottom-lock zoom window ..... 2-11

## **C**

- Cleaning ..... 4-1
- Clutter ..... 1-23
- Color dialog box ..... 3-8
- Control description ..... 1-1
- Control unit ..... 1-1

## **D**

- Default settings ..... 4-5
- Depth measurement ..... 1-17
- Display item dialog box ..... 3-3
- Display mode ..... 1-8

## **E**

- Echo image dialog box ..... 3-4
- Elapsed time measurement ..... 1-17

## **F**

- Fish alarm ..... 1-28
- Fish size histogram
  - displaying ..... 1-18
  - measuring area ..... 1-20
  - setting up ..... 2-6
- Function keys ..... 1-31
- Fuse replacement ..... 4-2

## **G**

- Gain ..... 1-16

## **L**

- Line marking ..... 1-18
- Loading user settings ..... 1-33

## **M**

- Main menu ..... 1-2
- Maintenance
  - check points ..... 4-1
  - cleaning ..... 4-1
  - fuse replacement ..... 4-2
  - trackball ..... 4-3
  - transducer ..... 4-2
- Marker zoom window ..... 2-13
- Menu tree ..... AP-1
- Mode dialog box ..... 3-1
- Multi beam dialog box ..... 3-6

## **N**

- Noise limiter ..... 1-24

## **P**

- Picture advance ..... 1-25
- Pop-up menu ..... 1-5
- Power on/off ..... 1-6

## **R**

- Range
  - basic range ..... 1-13
  - shift range ..... 1-15
- Receiving ..... 1-7
- Recording
  - choosing data to record ..... 1-35
  - recording data ..... 1-37
- Replaying data ..... 1-39

## **S**

- Saving user settings ..... 1-32
- Screen shot
  - loading ..... 1-42
  - saving ..... 1-41
- Signal level ..... 1-24
- Software version ..... 4-6
- Split beam display ..... 1-9
- Status window ..... 2-3
- System configuration ..... vii

## INDEX

### *T*

Target graph window .....	2-8
Temperature alarm .....	1-28
Three-beam display.....	1-10
Trackball maintenance .....	4-3
Transducer maintenance .....	4-2
Transmitting.....	1-7
Troubleshooting.....	4-4

### *U*

Unit dialog box .....	3-10
Units of measurement .....	3-10
User display.....	1-12

### *V*

Vertical temperature alarm.....	1-28
VRM.....	1-17

V-temperature window.....	2-10
---------------------------	------

### *W*

#### Window displays

auto arrange.....	2-2
bottom discrimination graph window .....	2-14
bottom zoom window .....	2-12
bottom-lock zoom window .....	2-11
fish size histogram window.....	2-6
marker zoom window .....	2-13
moving .....	2-2
status window .....	2-3
target graph window .....	2-8
turning on/off.....	2-1
V-temperature window .....	2-10

Furuno Electric Co., Ltd. Terms (EULA)

- You have acquired a device (“DEVICE”) that includes software licensed by Furuno Electric Co., Ltd from an affiliate of Microsoft Corporation (“MS”). Those installed software products of MS origin, as well as associated media, printed materials, and “online” or electronic documentation (“SOFTWARE”) are protected by international intellectual property laws and treaties. Manufacturer, MS and its suppliers (including Microsoft Corporation) own the title, copyright, and other intellectual property rights in the SOFTWARE. The SOFTWARE is licensed, not sold. All rights reserved.
- This EULA is valid and grants the end-user rights ONLY if the SOFTWARE is genuine and a genuine Certificate of Authenticity for the SOFTWARE is included. For more information on identifying whether your software is genuine, please see <http://www.microsoft.com/piracy/howtotell>.
- IF YOU DO NOT AGREE TO THIS END USER LICENSE AGREEMENT (“EULA”), DO NOT USE THE DEVICE OR COPY THE SOFTWARE. INSTEAD, PROMPTLY CONTACT FURUNO ELECTRIC CO., LTD. FOR INSTRUCTIONS ON RETURN OF THE UNUSED DEVICE(S) FOR A REFUND. **ANY USE OF THE SOFTWARE, INCLUDING BUT NOT LIMITED TO USE ON THE DEVICE, WILL CONSTITUTE YOUR AGREEMENT TO THIS EULA (OR RATIFICATION OF ANY PREVIOUS CONSENT).**
- **GRANT OF SOFTWARE LICENSE.** This EULA grants you the following license:
  - You may use the SOFTWARE only on the DEVICE.
  - If you use the DEVICE to access or utilize the services or functionality of Microsoft Windows Server products (such as Microsoft Windows Server 2003), or use the DEVICE to permit workstation or computing devices to access or utilize the services or functionality of Microsoft Windows Server products, you may be required to obtain a Client Access License for the DEVICE and/or each such workstation or computing device. Please refer to the end user license agreement for your Microsoft Windows Server product for additional information.
  - **NOT FAULT TOLERANT.** THE SOFTWARE IS NOT FAULT TOLERANT. FURUNO ELECTRIC CO., LTD. HAS INDEPENDENTLY DETERMINED HOW TO USE THE SOFTWARE IN THE DEVICE, AND MS HAS RELIED UPON FURUNO ELECTRIC CO., LTD. TO CONDUCT SUFFICIENT TESTING TO DETERMINE THAT THE SOFTWARE IS SUITABLE FOR SUCH USE.
  - **NO WARRANTIES FOR THE SOFTWARE.** THE SOFTWARE is provided “AS IS” and with all faults. THE ENTIRE RISK AS TO SATISFACTORY QUALITY, PERFORMANCE, ACCURACY, AND EFFORT (INCLUDING LACK OF NEGLIGENCE) IS WITH YOU. ALSO, THERE IS NO WARRANTY AGAINST INTERFERENCE WITH YOUR ENJOYMENT OF THE SOFTWARE OR AGAINST INFRINGEMENT. **IF YOU HAVE RECEIVED ANY WARRANTIES REGARDING THE DEVICE OR THE SOFTWARE, THOSE WARRANTIES DO NOT ORIGINATE FROM, AND ARE NOT BINDING ON, MS.**
  - **No Liability for Certain Damages.** EXCEPT AS PROHIBITED BY LAW, MS SHALL HAVE NO LIABILITY FOR ANY INDIRECT, SPECIAL, CONSEQUENTIAL OR INCIDENTAL DAMAGES ARISING FROM OR IN CONNECTION WITH THE USE OR PERFORMANCE OF THE SOFTWARE. THIS LIMITATION SHALL APPLY EVEN IF ANY REMEDY FAILS OF ITS ESSENTIAL PURPOSE. IN NO EVENT SHALL MS BE LIABLE FOR ANY AMOUNT IN EXCESS OF U.S. TWO HUNDRED FIFTY DOLLARS (U.S.\$250.00).
  - **Restricted Uses.** The SOFTWARE is not designed or intended for use or resale in hazardous environments requiring fail-safe performance, such as in the operation of nuclear facilities, aircraft navigation or communication systems, air traffic control, or other devices or systems in which a malfunction of the SOFTWARE would result in foreseeable risk of injury or death to the operator of the device or system, or to others.
  - **Limitations on Reverse Engineering, Decompilation, and Disassembly.** You may not reverse engineer, decompile, or disassemble the SOFTWARE, except and only to the extent that such activity is expressly permitted by applicable law notwithstanding this limitation.
  - **SOFTWARE as a Component of the DEVICE - Transfer.** This license may not be shared, transferred to or used concurrently on different computers. The SOFTWARE is licensed with the DEVICE as a single integrated product and may only be used with the DEVICE. If the SOFTWARE is not accompanied by a DEVICE, you may not use the SOFTWARE. You may permanently transfer all of your rights under this EULA only as part of a permanent sale or transfer of the DEVICE, provided you retain no copies of the SOFTWARE. If the SOFTWARE is an upgrade, any transfer must also include all prior versions of the SOFTWARE. This transfer must also include the Certificate of Authenticity label. The transfer may not be an indirect transfer, such as a consignment. Prior to the transfer, the end user receiving the SOFTWARE must agree to all the EULA terms.
  - **Consent to Use of Data.** You agree that MS, Microsoft Corporation and their affiliates may collect and use technical information gathered in any manner as part of product support services related to the SOFTWARE. MS, Microsoft Corporation and their affiliates may use this information solely to improve their products or to provide customized services or technologies to you. MS, Microsoft Corporation and their affiliates may disclose this information to others, but not in a form that personally identifies you.
  - **Internet Gaming/Update Features.** If the SOFTWARE provides, and you choose to utilize, the Internet gaming or update features within the SOFTWARE, it is necessary to use certain computer system, hardware, and software information to implement the features. By using these features, you explicitly authorize MS, Microsoft Corporation and/or their designated agent to use this information solely to improve their products or to provide customized services or technologies to you. MS or Microsoft Corporation may disclose this information to others, but not in a form that personally identifies you.

- **Internet-Based Services Components.** The SOFTWARE may contain components that enable and facilitate the use of certain Internet-based services. You acknowledge and agree that MS, Microsoft Corporation or their affiliates may automatically check the version of the SOFTWARE and/or its components that you are utilizing and may provide upgrades or supplements to the SOFTWARE that may be automatically downloaded to your DEVICE. Microsoft Corporation or their affiliates do not use these features to collect any information that will be used to identify you or contact you. For more information about these features, please see the privacy statement at <http://go.microsoft.com/fwlink/?LinkId=25243>.
- **Links to Third Party Sites.** You may link to third party sites through the use of the SOFTWARE. The third party sites are not under the control of MS or Microsoft Corporation, and MS or Microsoft are not responsible for the contents of any third party sites, any links contained in third party sites, or any changes or updates to third party sites. MS or Microsoft Corporation is not responsible for webcasting or any other form of transmission received from any third party sites. MS or Microsoft Corporation are providing these links to third party sites to you only as a convenience, and the inclusion of any link does not imply an endorsement by MS or Microsoft Corporation of the third party site.
- **Notice Regarding Security.** To help protect against breaches of security and malicious software, periodically back up your data and system information, use security features such as firewalls, and install and use security updates.
- **No Rental/Commercial Hosting.** You may not rent, lease, lend or provide commercial hosting services with the SOFTWARE to others.
- **Separation of Components.** The SOFTWARE is licensed as a single product. Its component parts may not be separated for use on more than one computer.
- **Additional Software/Services.** This EULA applies to updates, supplements, add-on components, product support services, or Internet-based services components ("Supplemental Components"), of the SOFTWARE that you may obtain from Furuno Electric Co., Ltd., MS, Microsoft Corporation or their subsidiaries after the date you obtain your initial copy of the SOFTWARE, unless you accept updated terms or another agreement governs. If other terms are not provided along with such Supplemental Components and the Supplemental Components are provided to you by MS, Microsoft Corporation or their subsidiaries then you will be licensed by such entity under the same terms and conditions of this EULA, except that (i) MS, Microsoft Corporation or their subsidiaries providing the Supplemental Components will be the licensor with respect to such Supplemental Components in lieu of the "COMPANY" for the purposes of the EULA, and (ii) TO THE MAXIMUM EXTENT PERMITTED BY APPLICABLE LAW, THE SUPPLEMENTAL COMPONENTS AND ANY (IF ANY) SUPPORT SERVICES RELATED TO THE SUPPLEMENTAL COMPONENTS ARE PROVIDED AS IS AND WITH ALL FAULTS. ALL OTHER DISCLAIMERS, LIMITATION OF DAMAGES, AND SPECIAL PROVISIONS PROVIDED BELOW AND/OR OTHERWISE WITH THE SOFTWARE SHALL APPLY TO SUCH SUPPLEMENTAL COMPONENTS. MS, Microsoft Corporation or their subsidiaries reserve the right to discontinue any Internet-based services provided to you or made available to you through the use of the SOFTWARE.
- **Recovery Media.** If SOFTWARE is provided by Furuno Electric Co., Ltd. on separate media and labeled "Recovery Media" you may use the Recovery Media solely to restore or reinstall the SOFTWARE originally installed on the DEVICE.
- **Backup Copy.** You may make one (1) backup copy of the SOFTWARE. You may use this backup copy solely for your archival purposes and to reinstall the SOFTWARE on the DEVICE. Except as expressly provided in this EULA or by local law, you may not otherwise make copies of the SOFTWARE, including the printed materials accompanying the SOFTWARE. You may not loan, rent, lend or otherwise transfer the backup copy to another user.
- **End User Proof of License.** If you acquired the SOFTWARE on a DEVICE, or on a compact disc or other media, a genuine Microsoft "Proof of License"/Certificate of Authenticity label with a genuine copy of the SOFTWARE identifies a licensed copy of the SOFTWARE. To be valid, the label must be affixed to the DEVICE, or appear on Furuno Electric Co., Ltd.'s, software packaging. If you receive the label separately other than from Furuno Electric Co., Ltd., it is invalid. You should keep the label on the DEVICE or packaging to prove that you are licensed to use the SOFTWARE.
- **Product Support.** Product support for the SOFTWARE is not provided by MS, Microsoft Corporation, or their affiliates or subsidiaries. For product support, please refer to Furuno Electric Co., Ltd. support number provided in the documentation for the DEVICE. Should you have any questions concerning this EULA, or if you desire to contact Furuno Electric Co., Ltd. for any other reason, please refer to the address provided in the documentation for the DEVICE.
- **Termination.** Without prejudice to any other rights, Furuno Electric Co., Ltd. may terminate this EULA if you fail to comply with the terms and conditions of this EULA. In such event, you must destroy all copies of the SOFTWARE and all of its component parts.
- **EXPORT RESTRICTIONS.** You acknowledge that SOFTWARE is subject to U.S. and European Union export jurisdiction. You agree to comply with all applicable international and national laws that apply to the SOFTWARE, including the U.S. Export Administration Regulations, as well as end-user, end-use and destination restrictions issued by U.S. and other governments. For additional information see <http://www.microsoft.com/exporting/>.

## Free Manuals Download Website

<http://myh66.com>

<http://usermanuals.us>

<http://www.somanuals.com>

<http://www.4manuals.cc>

<http://www.manual-lib.com>

<http://www.404manual.com>

<http://www.luxmanual.com>

<http://aubethermostatmanual.com>

Golf course search by state

<http://golfingnear.com>

Email search by domain

<http://emailbydomain.com>

Auto manuals search

<http://auto.somanuals.com>

TV manuals search

<http://tv.somanuals.com>