

## INSTALLATION MANUAL GPS PLOTTER GP-1800

---

1. Display Unit	2
1. Mounting Considerations	2
2. Mounting	2
2. Antenna Unit	3
1. Mounting	3
2. Example of Mounting Location	3
3. Extending Antenna Cable Length	4
3. Wiring	6
1. Grounding	6
2. External Equipment	6
4. Initial Setting	7
1. Procedure	7
2. Entering Antenna Height	8
3. Entering Time Difference/Geodetic Datum	8
4. Setting for External Navigation Equipment	8
5. Connecting DGPS Receiver	
Providing RS-422 Level Data	9
Equipment List	14
Interconnection Diagram	S-1
Schematic Diagrams	S-2 thru 4
Outline Drawings	D-1

# 1. Display Unit

## 1. Mounting Considerations

Install the unit where the LCD can be easily viewed and the keyboard can be easily operated. Be sure to leave sufficient space on the sides and the rear of the unit for maintenance purposes. Leave a sufficient slack in cables so the unit can be dismantled from the hanger with the connectors connected.

In addition to the aforementioned points, observe the following precautions.

- Keep the display unit out of direct sunlight or at least shaded to maintain display tone control by an excess heat that can build up inside the cabinet.
- The temperature and humidity change should not be extreme around the unit.
- Locate the unit away from exhaust pipes and vents.
- The mounting location should be well ventilated.
- Mount the unit where shock and vibration are minimal.

## 2. Mounting

Mount the unit by referring to drawings on pages D-2, D-3 or D-4.

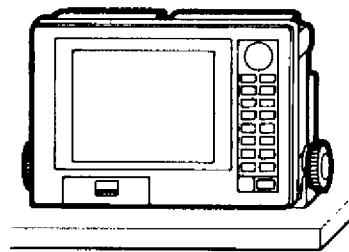
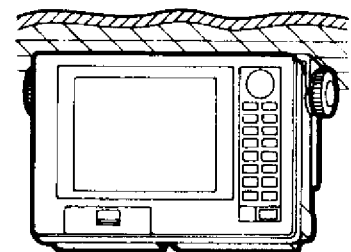
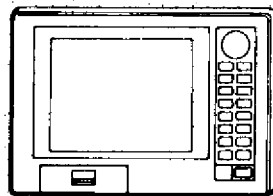

TABLE TOP



OVERHEAD



FLUSH MOUNT  
(S-TYPE)

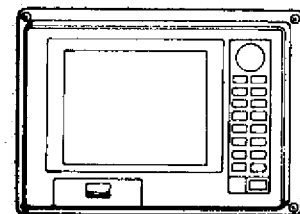

FLUSH MOUNT  
(F-TYPE)

*Figure 1 Display unit mounting methods*

## 2. Antenna Unit

### 1. Mounting

Mount the antenna unit by referring to the drawing on page D-1. When selecting a mounting location for the antenna unit keep in mind the following points.

- **Select a location out of the radar beam.** The radar beam will obstruct or prevent reception of the GPS satellite signal.
- **Be sure the location offers a clean line-of-sight to satellite.** Objects within line-of-sight to a satellite, for example, a mast or funnel, block reception and cause prolonged acquiring time or interruption of position fix.
- **Mount the unit as high as possible.** Mounting the antenna as high as possible keeps it free of water spray, which can intercept reception of GPS satellite signal, if water spray is frozen.

### 2. Example of mounting location

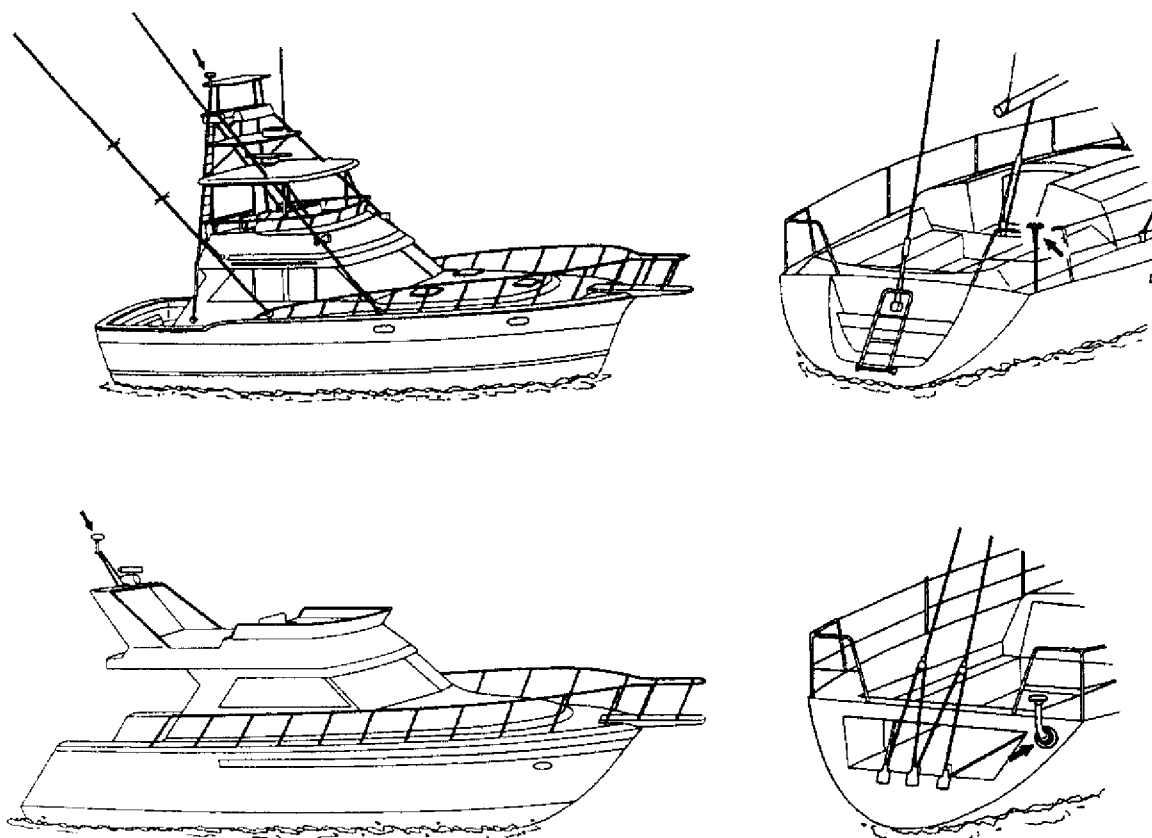

*Figure 2 Antenna unit mounting location*

### 3. Extending antenna cable length

The standard cable is 15m long. 30m and 50m long extension cables are optionally available.

Name	Type	Code No.
30m Antenna Cable Set	CP20-01700	004-372-110
50m Antenna Cable Set	CP20-01710	004-372-120

Each set includes extension cable, two connector conversion cables, coaxial connector, vulcanizing tape and vinyl tape.

#### ◆ Extension cable line-up

- 1) Cut the 30m or 50m antenna cable to appropriate length, if necessary.
- 2) Fabricate the end of antenna cable and attach the coaxial connector. Details are shown on next page.

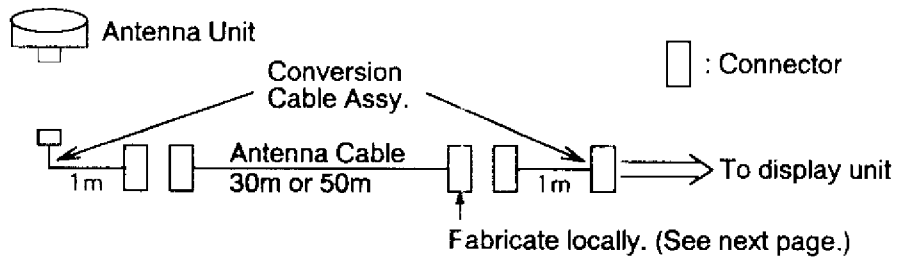

*Figure 3 Extension Cable Line-up*

#### ◆ Waterproofing the connector

Wrap connector with vulcanizing tape and then vinyl tape. Bind the tape end with cable-tie.

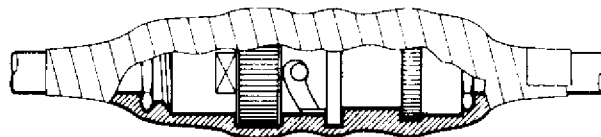

*Figure 4 How to waterproof the antenna connector*

### How to attach the N-P-8DFB connector

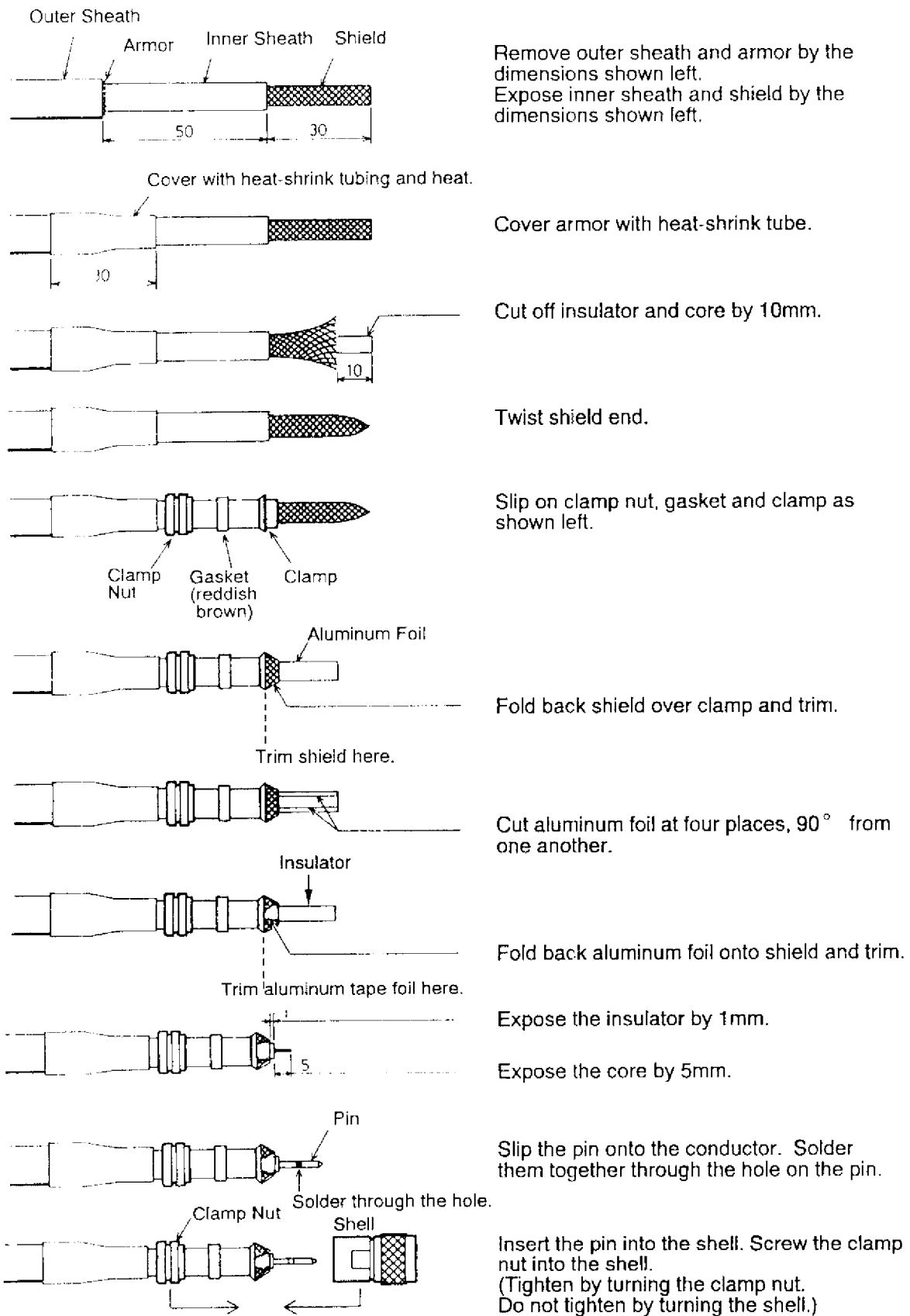
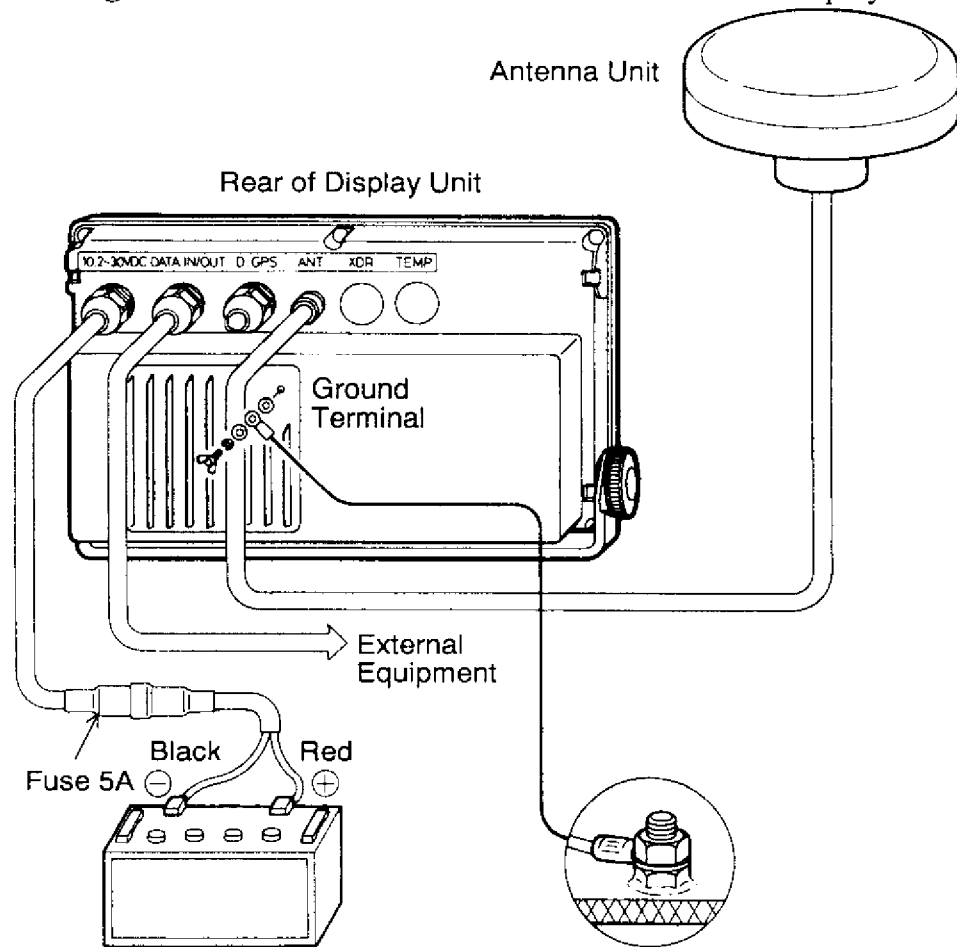

Figure 5 How to attach the N-P-8DFB connector

### 3. Wiring

Figure 6 shows the connection of cables on rear of display unit.



*Figure 6 Connection of cables on display unit*

#### 1. Grounding

The display unit contains several CPUs. While they are operating, they radiate noise, which can interfere with other radio equipment. Ground the unit as follows to prevent it.

- The grounding wire should be 1.25sq or larger.
- The grounding wire should be as short as possible.
- Connect the grounding wire to ship's ground by silver-alloy brazing.

#### 2. External Equipment

The DATA IN/OUT port and D. GPS port are used to connect an external equipment such as autopilot, remote display, navigation equipment, DGPS beacon receiver. The interconnection cable is optionally available as shown in the table of page 14.

## 4. Initial Setting

After installing the unit, turn the unit on and set the SYSTEM SETUP menu as follows.

### 1. Procedure

- 1) Press the **MENU** key, and the MAIN menu appears.
- 2) Press **9** to select the SYSTEM SETUP menu.
- 3) Set the items using the arrow keys and numeral keys according to the user's requirements. The figure below shows factory settings. Items explained on the following pages require presetting after installation.

SYSTEM SETUP 1/2		▲▼ : Next, Previous Page	
Memory Apportion	Trk=	1000pt/8000pt	
Unit of Distance	nm	km	sm
Unit of Depth	m	ft	Fa ヒロ PB
Unit of Temp	°C	°F	
Navaid	Int GPS	Ext GPS	LC DC All
Scale/ Range	Scale	Range	
Rec Resolution	02		
Pos Display	Lat/Long	LOP	
LOP Display	LA	LC	No
LA Chain	00-01	△+000.0 μ	△+000.0 μ s
LC Chain	00:01-26	△+000.0 μ s	△+000.0 μ s
Smoothing Factor	00	(0-15)	
Speed Average Time	01	minute	
Bearing Ref.	True Brg	Mag Brg	
Mag. Variation	Auto (07° W)	Man (00° E)	
Output Data Fmt	NMEA-180	NMEA-183V1.5	NMEA-183V2.0
External Device	Autopilot	Remote Display	Navaid
▲▼◀▶ : Select		ENT: End	MENU: Escape

SYSTEM SETUP 2/2		▲▼ : Next, Previous Page	
Time Difference	+00:00		
GPS Posn Smooth	00	(00-99)	
GPS Speed Smooth	05	(00-99)	
Antenna Height	± 005m		
DOP Threshold	20	(2-99)	
Fix Mode	2D	3D	2/3D
Geodetic Datum	Tokyo	WGS-84	WGS-72 Other (___)
Position Offset	00.000' N	00.000' E	
Disabled Satellite	Rstr	Disable (___)	Enable (___)
DGPS Mode	On	Off	
RTCM Version	1.0	2.0	
Byte Format	8-6	8-8	
First Bit	MSB	LSB	
Parity Bit	Even	Odd	None
Stop Bit	1	2	
Bit Rate	7	8	
Baud Rate	9600(300	◀▶ 9600)	
Clear Memory	No	PLT	GPS All
▲▼◀▶ : Select		ENT: End	MENU: Escape

Note: Factory settings are restored when the CLEAR MEMORY "ALL" is selected by the arrow keys and the ENT key is pressed. This item is useful when your selection becomes in wild disorder.

## 2. Entering Antenna Height

- 1) Select the ANT HEIGHT item using the arrow keys.
- 2) Enter the antenna height (3 digits) of the GPS antenna above sea level using the numeral keys.
- 3) Press the ENT key.

## 3. Entering Time Difference/Geodetic Datum

- 1) Time Difference: + for eastern longitude, - for western longitude
- 2) Geodetic datum referring to nautical chart for your operating area.

## 4. Setting for External Navigation Equipment

The following settings are required when an external navigation equipment; autopilot, remote display, etc. is connected to the DATA IN/OUT jack.

- 1) "Navaid" selection  
Normally INT GPS position is selected. If the internal GPS receiver becomes defective, select the EXT GPS, LC (Loran C) or DC (Decca navigator) position which is connected. The selected navigation equipment is indicated on the upper right of the display.
- 2) "Output data" format selection  
Set a communication format according to the connected navigation equipment.

### NMEA 0180 data format

Cross track error is output.

### NMEA 0183 version 1.5 or 2.0 data format

Output Data

Talker	Sentence	Remarks
GP	AAM, APA (version 1.5), GLL, VTG, XTE, APB (version 2.0), BOD, BWC	For autopilot.
GP	BWR, GLL, RMC, VTG, ZDA	For remote display.
GP	GLL, RMC, VTG, BWR, ZDA	For navaid



## Input Data

Talker	Sentence	Remarks
PFEC	AGFPA	For autopilot.
GP, LC, LA, DE or any	GGA, GLL, BWC, RMA, WPL	
GP	VTG	
GP, LC, LA, DE or any	BWR, GGA, GLL, MTW, RMA, RMC, WPL	For remote display.
GP	VTG	
Any	DBT(version 1.5)	
	DPT(version 2.0)	
GP, LC, LA, DE or any	GGA, GLL, MTW, RMA, RMC, WPL	For navaid
GP	VTG	

## 5. Connecting DGPS Receiver Providing RS-422 Level Data

### Changing to RS-422

The GP-1800 is preset to accept DGPS correction data in RS-232C level. To apply RS-422 level data, change the jumper wires as follows. Note that some initial sets have no jumper wires on the GDC board. Confirm the jumper wire settings according to the table on page 11.

- 1) Unfasten six screws (A) to dismount rear chassis.
- 2) Lay cushioning material on a tabletop. Lay the display unit front panel down on the cushioning material. Orient the unit so the knob bolts are toward you. Separate chassis.  
If the GDC/GB-92 assy. and its metal plate do not come free, insert thin blade screwdriver in one of screw holes of screw (A) and push down to release them.

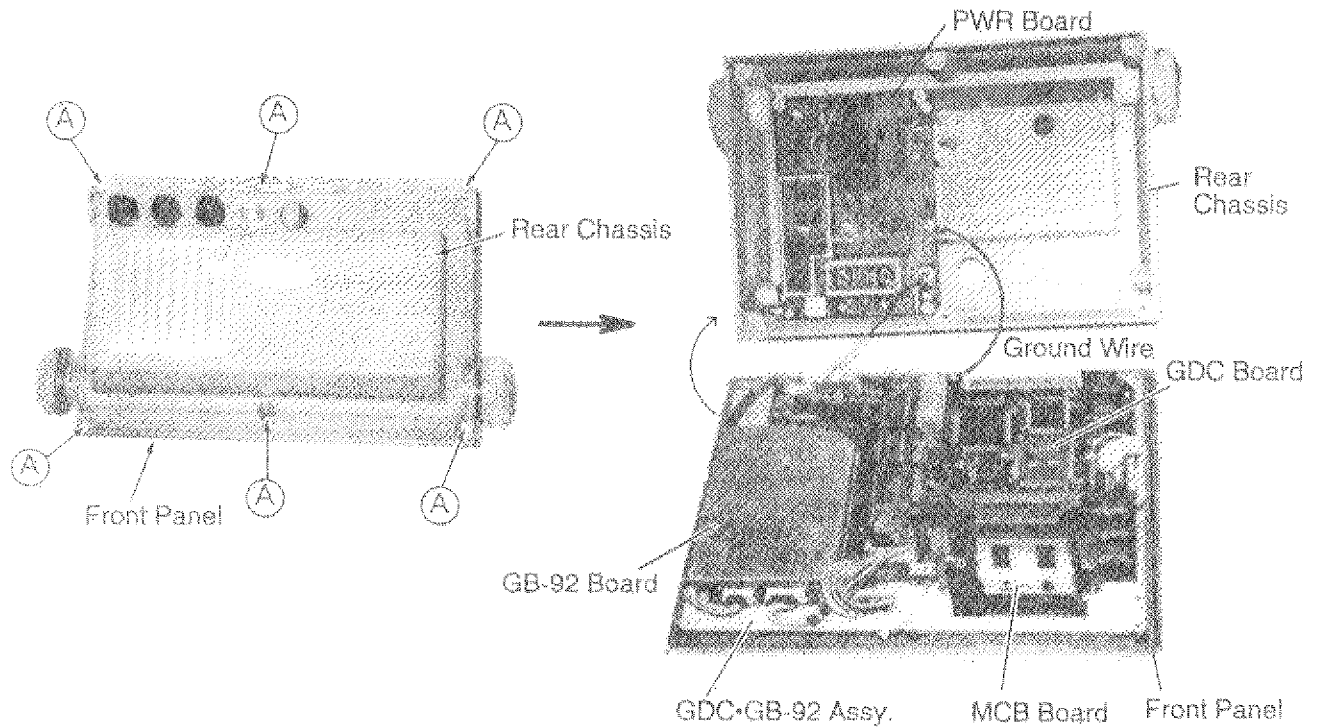
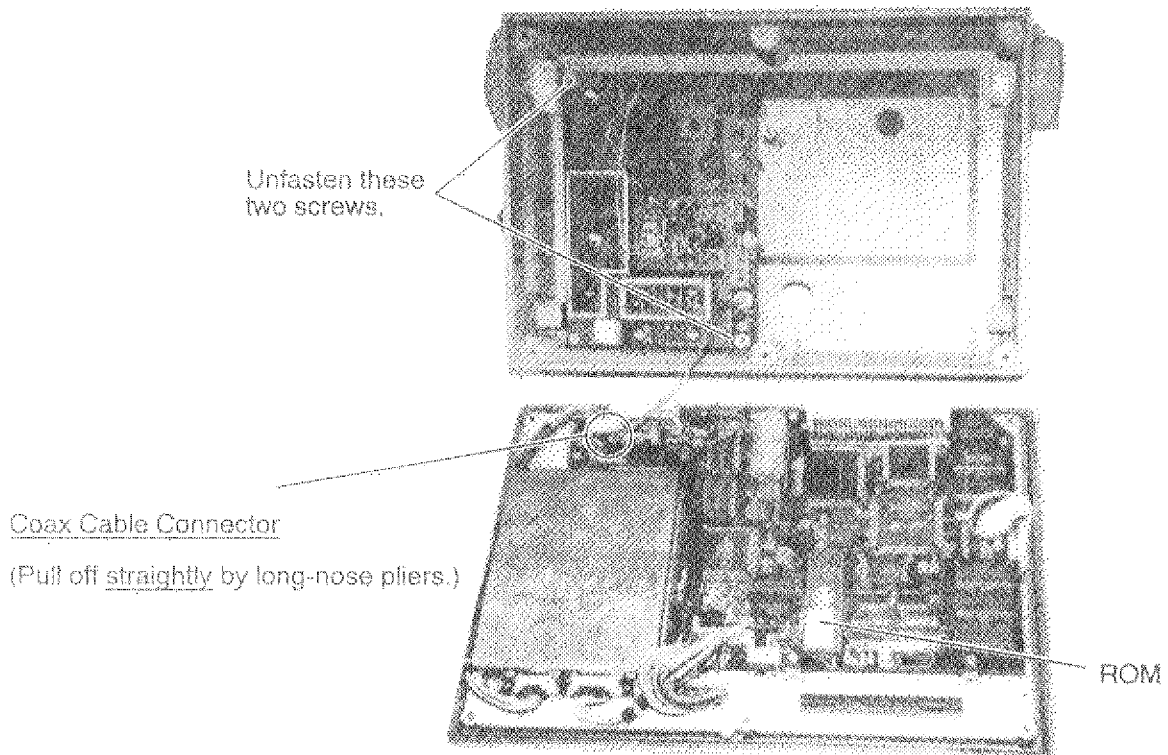
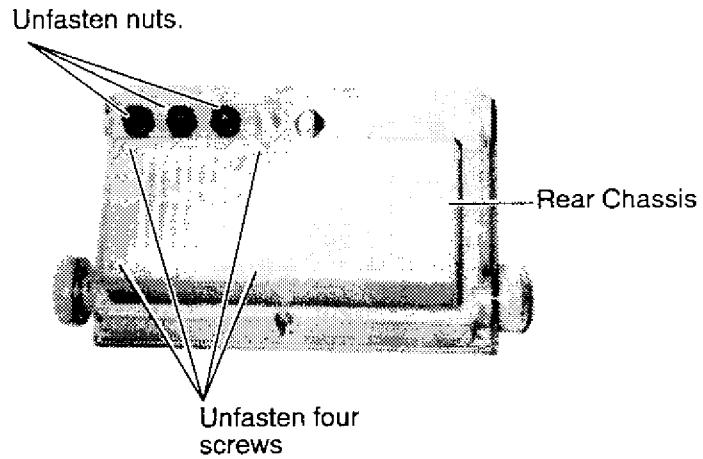

Figure 7 How to separate the chassis

- 3) Disconnect coaxial cable on GB-92 Board.
- 4) Unfasten two screws on the rear chassis. Dismount the PWR Board by unfastening connector nuts and screws.

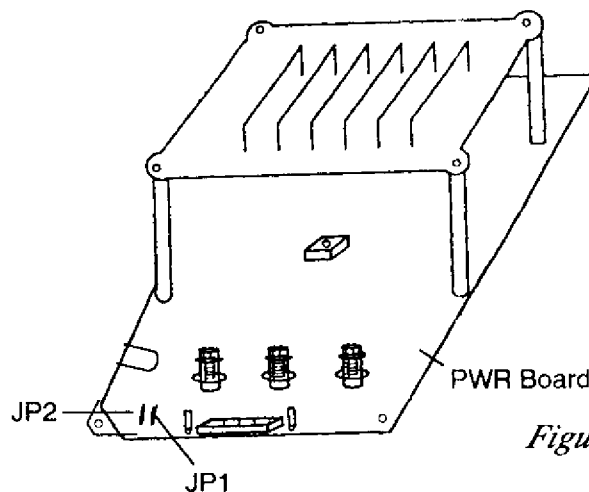



*Figure 8 GP-1800, rear view*

- 5) Dismount the GDC Board by unfastening screws.
- 6) Change the jumper wires as follows;

Level pcb	RS-232C (Default setting)	RS-422
PWR Board Fig. 9	<ul style="list-style-type: none"> <li>• JP1: Open</li> <li>• JP2: Short</li> </ul>	<ul style="list-style-type: none"> <li>• JP1: Short</li> <li>• JP2: Open</li> </ul>
GDC Board Fig. 10	<ul style="list-style-type: none"> <li>• JP7: Open</li> <li>• JP8: Open</li> <li>• Short between JP7 and U3 #11.</li> <li>• Short between JP8 and U3 #10.</li> <li>• Short between J1 #7 and J1 #14.</li> </ul>	<ul style="list-style-type: none"> <li>• JP7: Short</li> <li>• JP8: Short</li> <li>• Cut trace between JP7 and U3 # 11.</li> <li>• Cut trace between JP8 and U3 # 10.</li> <li>• Cut trackbetween J1 #7 and J1 #14.</li> </ul>



*Figure 9 PWR Board*

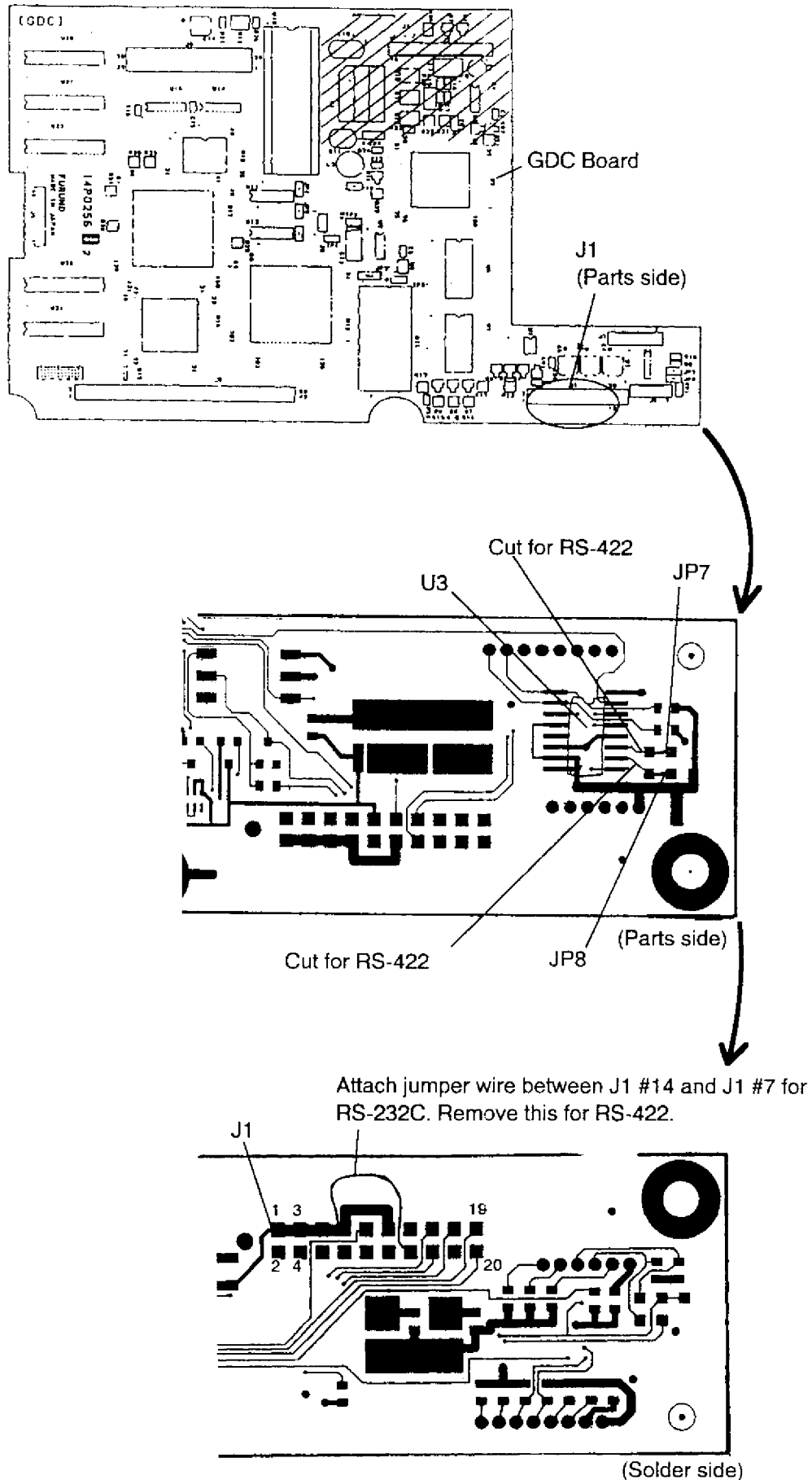

Figure 10 GDC Board

---

### Setting for DGPS Receiver

- 1) Press the **MENU** key. The MAIN menu appears.
- 2) Select the SYSTEM SETUP using the up-down arrow keys followed by the **ENT** key.
- 3) Set the DGPS MODE to the ON position using arrow keys and set the following items.
  1. DGPS Mode
  2. RTCM Version
  3. Byte Format
  4. First Bit
  5. Parity Bit
  6. Stop Bit
  7. Bit Rate
  8. Baud Rate

## Equipment List

### Standard Supply

	Name	Type	Q'ty	Mass (kg)	Remarks
1	Antenna Unit	GPA-015	1	0.3	
2	Display Unit	GP-1800-E	1	2.4	
3	Installation Materials	CP20-01500	1		
		CP20-01510			
4	Spare Parts	SP20-00600	1 set		
5	Accessories	FP20-00700	1 set		

### Options

	Name	Type	Code No.	Remarks
1	Antenna Cable Set	OP20-01700	004-372-110	30m
2	Antenna Cable Set	OP20-01710	004-372-120	50m
3	Flush Mount Kits S	OP14-30	004-031-070	For display unit
4	Flush Mount Kits F	OP14-31	004-031-080	
5	Right Angle Antenna Base	No.13-QA300	000-803-239	For antenna unit
6	L-Type Antenna Base	No.13-QA310	000-803-240	
7	Handrail Antenna Base	No.13-RC5160	000-806-114	
8	Mast Mount Kit	CP20-01111	004-370-100	
9	RAM Card	OP00-002	008-105-140	32KB
		00RAM256C-001	004-321-070	256KB
		00RAM512C-002	004-322-230	512KB
10	Signal Cable	20S0093-0	000-117-603	

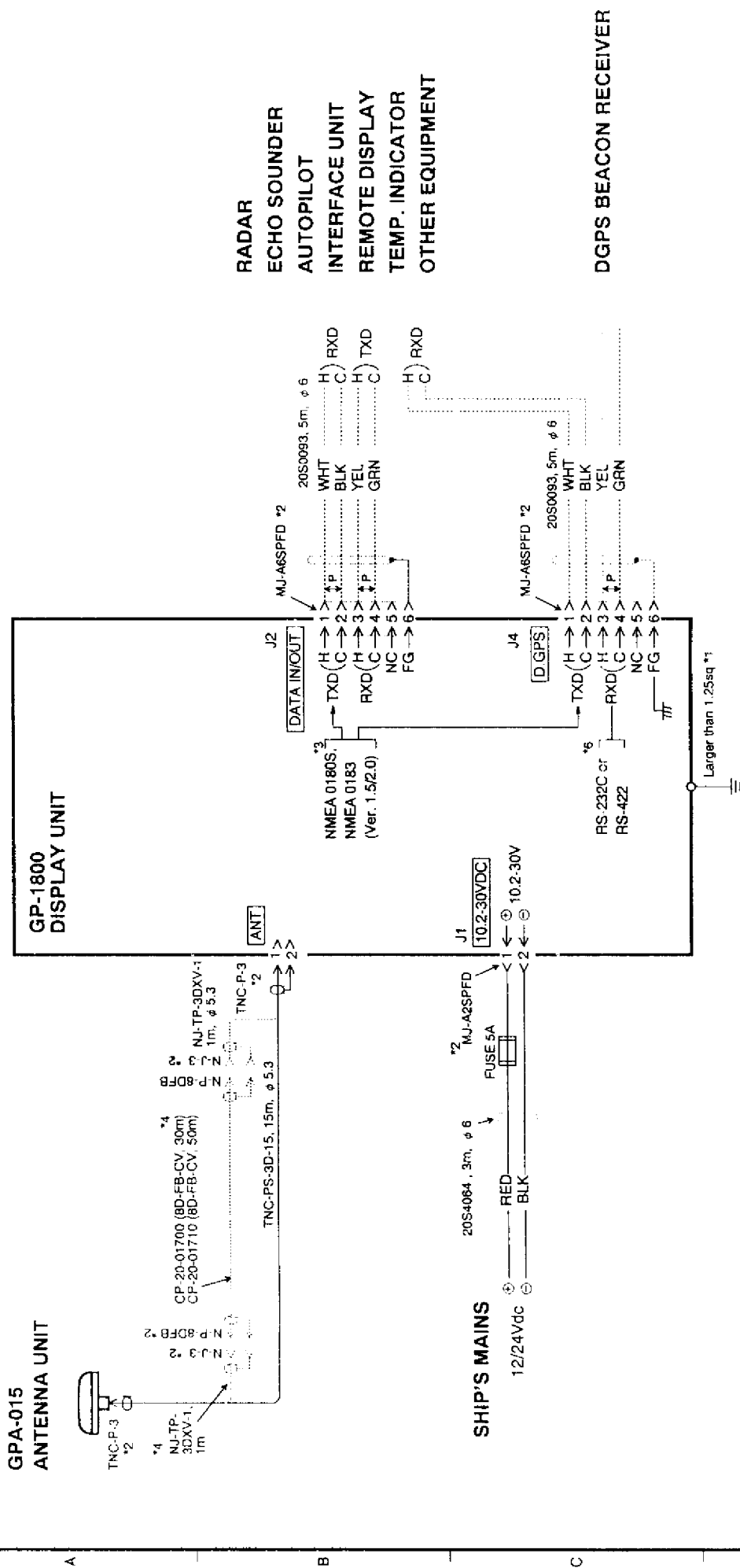

**NOTE**

- \*1: To be supplied locally.
- \*2: Factory-wired.
- \*3: Selectable on MENU.
- \*4: Optional supply.
- \*5: Connectors XDR and TEMP on the rear of the display unit are not used.
- \*6: Selectable by jumper wires.

名 称 TITLE	GPS PLOTTER INTERCONNECTION DIAGRAM
型 号 DWG. NO	GP-1800 E4363-C01-C

0 1 2 3 4 5

A B C D

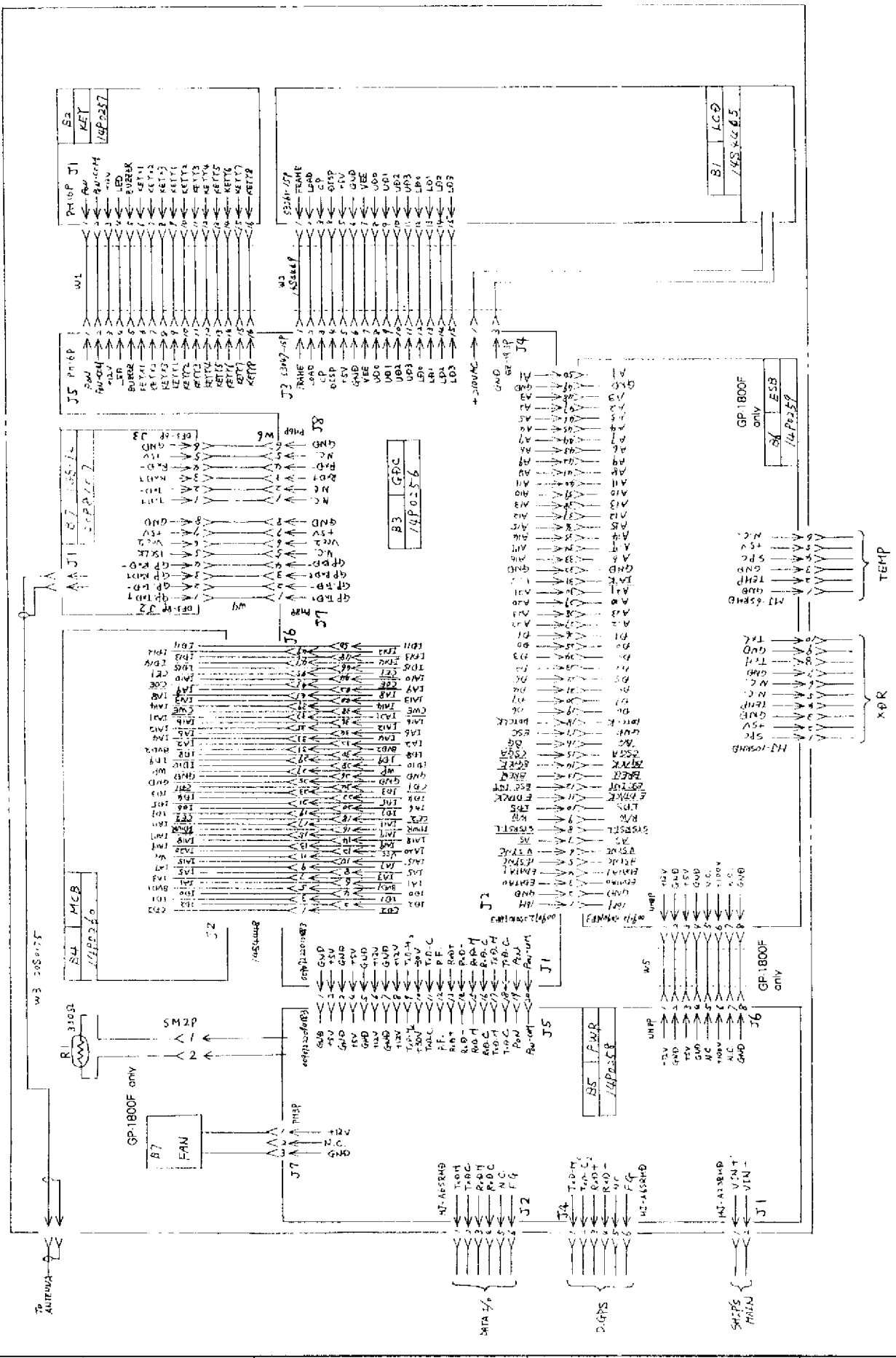

REVISIONS	APPROVED A4-12-94 Y.S.	GP1800M2 GP1800F GP1800	TYPE GP1800-J/E
DATE	1/27/94	NAME GENERAL	名称 様合





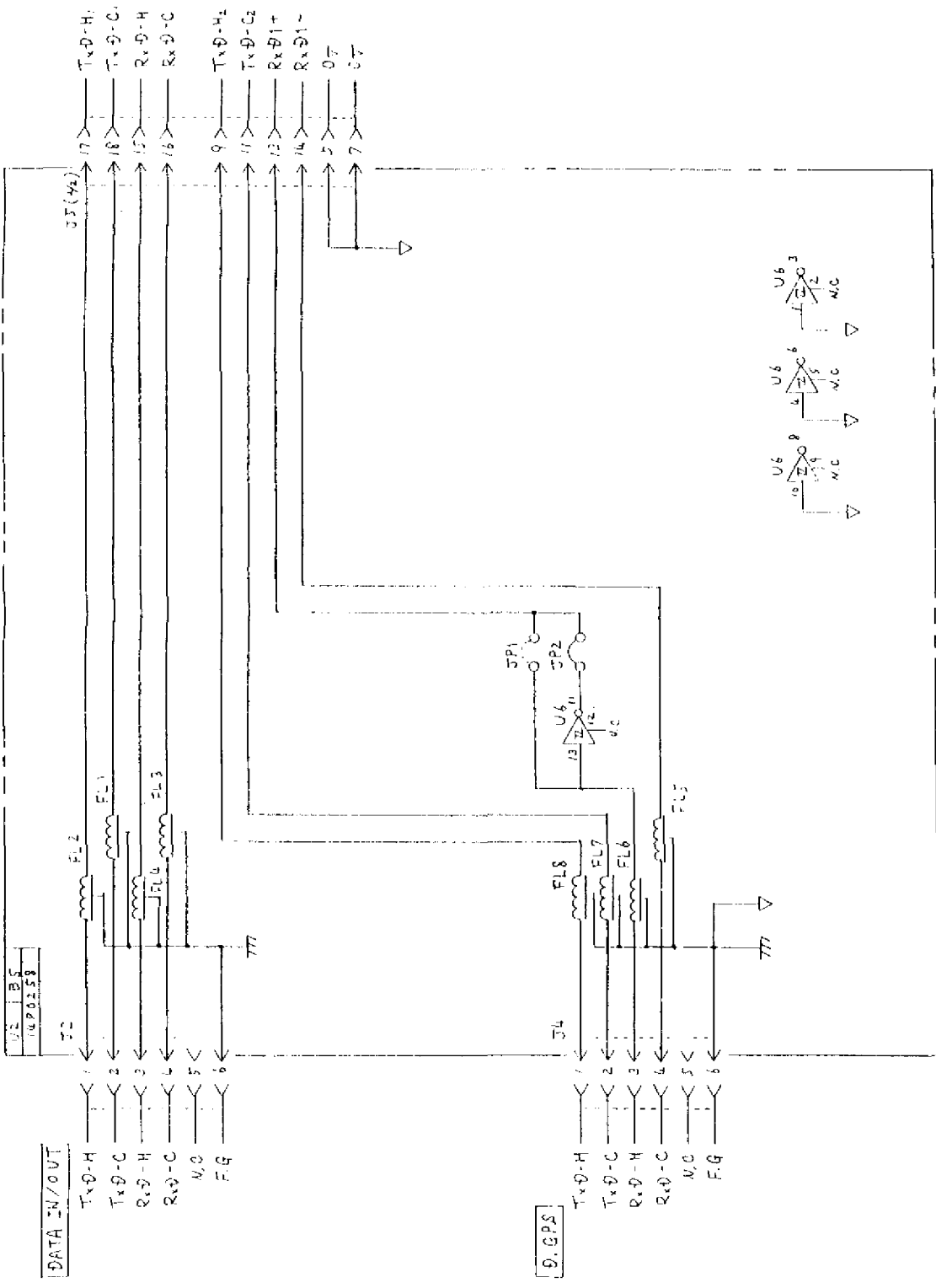

REMARKS

TYPE 14P0258  
名称 电源基板 (2/2)  
NAME PWR\_BOARD (2/2)

GP1800M2  
GP1800F  
GP1800

APPROVED: 2012.7.7  
Y.S. I.K.O.G.

B 5  
B 5  
B 5

# ***GPS PLOTTER GP-1800***

## ***Modification to Comply with EMC Directive***

---

To comply with EMC directive, attach EMI core to power cable close to the connector as shown below.

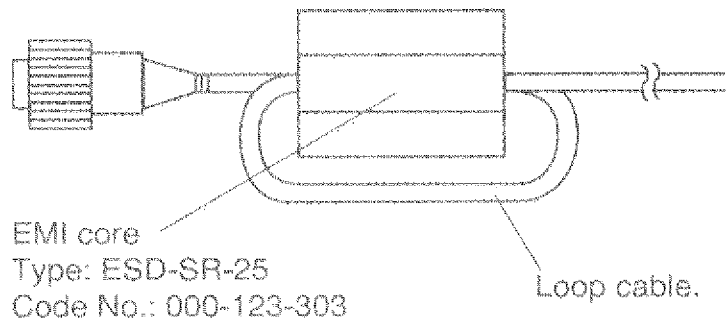
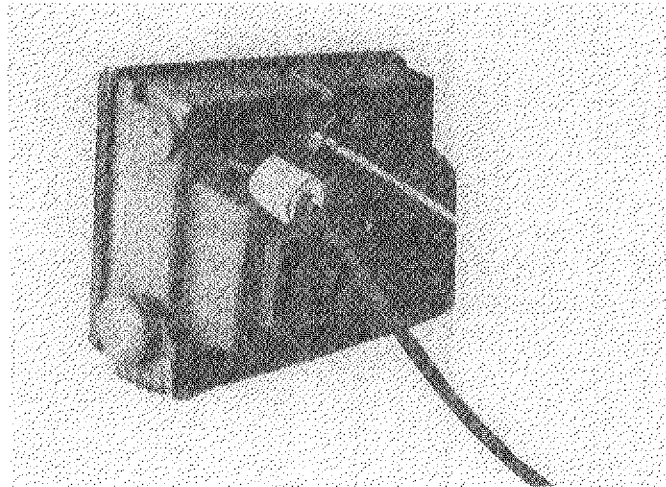

## 空中線部（アンテナユニット）の変更

---

空中線部（アンテナユニット）の型式がGPA-015からGPA-016に変更になりました。  
取付要領は、添付の取付要領図を参照してください。

### 変更前

名称	型名	コード番号	質量 (kg)
空中線部	GPA-015	000-040-835	0.3

### 変更後

名称	型名	コード番号	質量 (kg)
空中線部	GPA-016	000-040-537	0.1

## Replacement of GPS Antenna Unit

---

GPS antenna unit GPA-016 has replaced type GPA-015. Refer to the installation instructions attached for the GPA-016.

### Before

Name	Type	Code No.	Wt. (kg)
Antenna Unit	GPA-015	000-040-835	0.3

### After

Name	Type	Code No.	Wt. (kg)
Antenna Unit	GPA-016	000-040-537	0.1

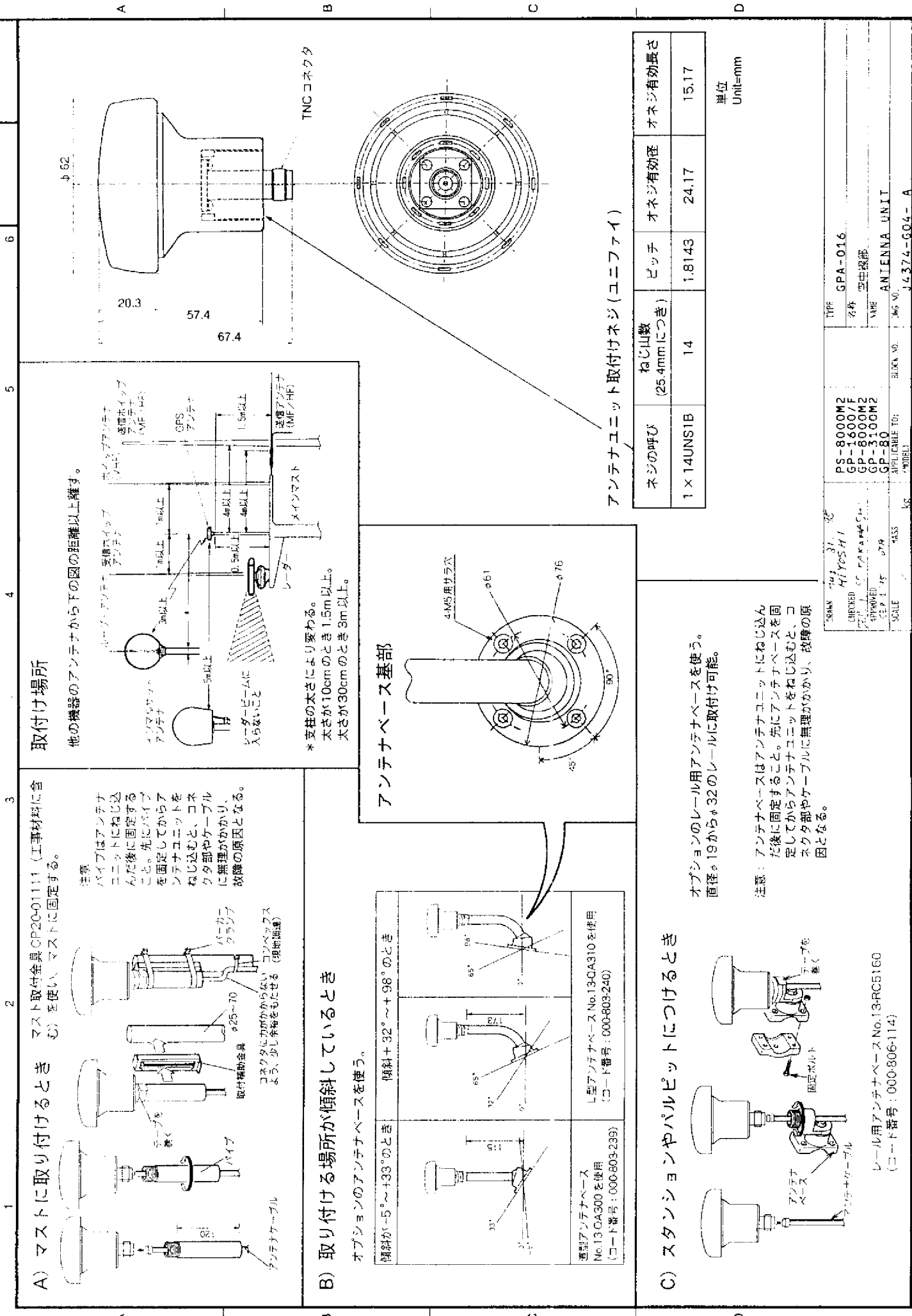

**A) マストに取り付けるとき** マスト取付金具 CP20-0111 (工事材料に含む) を使い、マストに固定する。

**注意**  
パイプはアンテナユニットにねじ込んだ後に固定すること。先にパイプを固定してからアンテナユニットをねじ込むと、コネクタ部やケーブルに無理がかかり、故障の原因となる。

アンテナケーブル  
パイプ  
取付補助金具 φ25~70  
バーガンクランプ  
コネクタに力が加からないよう、少し余裕をもたせる (現地調整)

**B) 取り付け場所が傾斜しているとき**  
オブションのアンテナベースを使う。

傾斜が -5° ~ +33° のとき	傾斜が 32° ~ +98° のとき
--------------------	--------------------

傾斜が 32° ~ +98° のとき

傾斜が -5° ~ +33° のとき

L型アンテナベース No.13-QA310 を使用 (コード番号: 000-803-240)

変型アンテナベース No.13-QA300 を使用 (コード番号: 000-803-239)

**C) スタンションやパルピットにつけるときの**

オブションのレール用アンテナベースを使う。直径φ19からφ32のレールに取り付け可能。

**注意:** アンテナベースはアンテナユニットにねじ込んだ後に固定すること。先にアンテナベースを固定してからアンテナユニットをねじ込むと、コネクタ部やケーブルに無理がかかり、故障の原因となる。

レール用アンテナベース No.13-RCS160 (コード番号: 000-806-114)

**取付け場所**  
他の機器のアンテナから下の図の距離以上離す。

\* 支柱の太さにより変わる。太さが10cmのとき1.5m以上。太さが30cmのとき3m以上。

**アンテナベース基部**

アンテナユニット取付けネジ (ユニファイ)

ネジの呼び	ねじ山数 (25.4mmにつき)	ピッチ	オネジ有効径	オネジ有効長さ
1 × 14UNS1B	14	1.8143	24.17	15.17

単位  
Unit=mm

TYPE	GPA-016
名称	空中線部
VME	ANTENNA UNIT
図号	4374-G04-A
SCALE	1/1
APPLICABLE TO:	PS-8000M2 GP-1600/F GP-8000M2 GP-3100M2 GP-80
BLOCK NO.	
MODEL	

## A) Mast mounting

Use mast mounting kit CP20-01111.

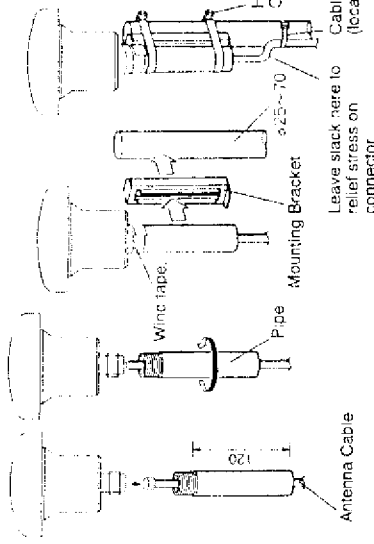

### NOTES

- 1) Fasten pipe to antenna first then fix them to mast.
- 2) When fixing antenna to pipe, turn pipe, not the antenna. Turning the antenna may twist the cable and place stress on connector.

## B) Antenna base mounting

Use optional antenna base No.13-QA300 or No.13-QA310.

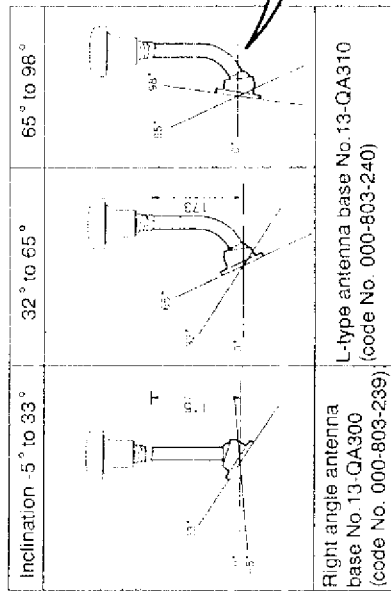

## C) Handrail mounting

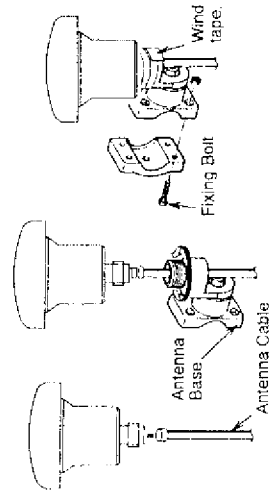

Use handrail mounting base No.13-RCS160 (Code No. 000-861-114, option). The diameter of the handrail may be from  $\phi 19\text{mm}$  to  $\phi 32\text{mm}$ .

### NOTES

- 1) Fasten antenna base to antenna first then fix them to handrail.
- 2) When fixing antenna to antenna base, turn antenna base, not the antenna. Turning the antenna may twist the cable and place stress on connector.

## Mounting location

The figure below shows the recommended separation distances from other antennas to avoid mutual interference.

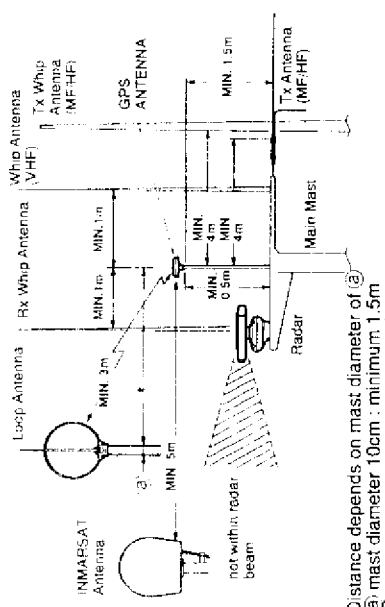

\* Distance depends on mast diameter of (a)  
(a) mast diameter 10cm : minimum 1.5m  
(b) mast diameter 30cm : minimum 3m

## Mounting dimensions of antenna base (option)

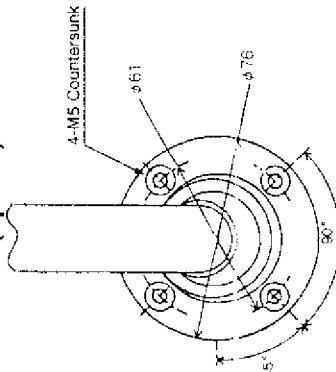

Thread Type	Threads per 25.4 mm (1 inch)	Pitch	Thread Length	Pitch Diameter
1 X 14UNS1B	14	1.8143 mm	15.17 mm	24.17 mm

TYPE	GP-50MK3
PS-8000M2	
GP-1600/F	
GP-8000M2	
GP-3100M2	
GP-80	
APPLICABLE TO:	ANTENNA UNIT
SCALE	0.1kg
DATE	2014.01
CHECKED	Y. S. YAMAMOTO
APPROVED	Y. S. YAMAMOTO
DESIGN NO.	GP-016
WORK NO.	
NAME	GP-016
社名	富士電機
図名	天線部品
図尺	A1
図番	
図種	ANTENNA UNIT
図例	

© FURUNO ELECTRIC CO., LTD.

9-52, Ashihara-cho,  
Nishinomiya, Japan 662

Telephone: 0798-65-2111  
Telefax: 0798-65-4200

•Your Local Agent/Dealer

All rights reserved. Printed in Japan

FIRST EDITION : FEB 1994  
D : NOV. 14, 1994

(TATA)

PUB. No. IME-43630-D  
GP-1800



## Free Manuals Download Website

<http://myh66.com>

<http://usermanuals.us>

<http://www.somanuals.com>

<http://www.4manuals.cc>

<http://www.manual-lib.com>

<http://www.404manual.com>

<http://www.luxmanual.com>

<http://aubethermostatmanual.com>

Golf course search by state

<http://golfingnear.com>

Email search by domain

<http://emailbydomain.com>

Auto manuals search

<http://auto.somanuals.com>

TV manuals search

<http://tv.somanuals.com>