

# FURUNO

## OWNER'S MANUAL

LORAN-C PLOTTER

MODEL LP-1000



M Photo No.2365



**FURUNO ELECTRIC CO., LTD.**  
NISHINOMIYA, JAPAN

8807100KS(8807, tuyu)  
PRINTED IN JAPAN



## **FURUNO ELECTRIC CO., LTD.**

No. 9-52, ASHIHARA-CHO,  
NISHINOMIYA-CITY, JAPAN

TELEPHONE : 0798-65-2111

CABLE : FURUNO NISHINOMIYA

TELEX : 5644-325/326 FURUNO J

TELEFAX : 0798-65-4200 (G II / G III)

YOUR LOCAL AGENT/DEALER

## WARNING AGAINST HIGH TENSION

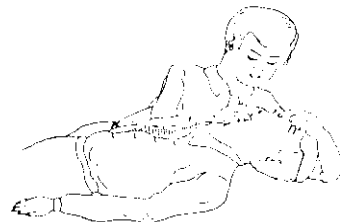
The operation of this equipment involves the use of high voltage, which endangers human life. Although the design of the equipment has been made in due consideration of measures to insure the operator's safety, adequate precaution must be exercised when reaching inside the equipment for the purpose of maintenance and service. Do not change a component or inspect the equipment with the voltage applied. A residual charge may exist in some capacitors with the equipment turned off. Always short all supply lines to the chassis with an insulated screwdriver or a similar tool prior to touching the circuit.

## FIRST AID IN CASE OF ELECTRIC SHOCK

When a victim struck by electricity is found, first switch off the equipment via the main switch on the equipment or the ship's distribution board. If this is not possible, protect yourself with dry insulating material (a wooden plate or rod, cloth, your belt, etc.) and pull the victim clear of electricity. If the victim is not breathing himself, apply artificial respiration according to the "Method of Artificial Respiration." Do not give up halfway. Perseverance and continual efforts are important in artificial respiration.

## METHOD OF ARTIFICIAL RESPIRATION

Lay the victim on his back. Position yourself beside the victim's head and pinch his nose by your thumb and forefinger to prevent air leakage. Insert the thumb of your other hand between the victim's teeth and lift his chin up. Then, place the arm (the one closing the victim's nose) on the victim's forehead and press the head down so that the victim's head is given a maximum backward tilt with the chin prominent and the neck bent back. Seal the victim's mouth with your mouth and blow therein about half of the deeply inhaled air every time. After exhaling, turn your head to watch for a chest contraction, whilst inhaling deeply in readiness for the next blowing. Repeat the movements faster for the first 1 to 2 minutes and 12 times per minute thereafter.



## INTRODUCTION

Congratulations on your choice of the Furuno LP-1000 Loran-C Plotter. We are confident that you will enjoy many years of operation with this fine piece of equipment.

For over 35 years Furuno Electric Company has enjoyed an enviable reputation for quality and reliability throughout the world. This dedication to excellence is furthered by our extensive global network of agents and dealers.

The LP-1000 Loran-C Plotter is the culmination of a long line of Furuno developments in the field of navigation. In one remarkably tiny cabinet is virtually all the navigation capabilities most voyagers will ever need while they are within the coverage area of the Loran-C navigation system.

Because the unit is so tiny there may be a tendency to forget just how sophisticated this machine really is, and perhaps to disregard the fact that no machine can perform its intended function unless it is installed properly. The desirability of a professional installation and a thorough checkout cannot be overemphasized!

A word about the organization of this manual: it is laid out in as "user-friendly" a manner as possible. We realize that a sophisticated instrument such as this, with its many, many functions can be very intimidating to the first-time user. It is our intention to guide the user along in the use of the gear as gently and as comfortably as possible in a series of sections that start at a very basic level and proceed forward in complexity in a logical manner.

We would appreciate feedback from you, the end-user, about whether we are achieving our purposes in this manual.

Thank you for considering and purchasing Furuno equipment.

## CAUTION

Although your Loran-C receiver is capable of providing very accurate position data, no single navigational device should ever be solely relied upon. Position information obtained from Loran-C should always be double-checked against other sources such as radar, visual and celestial sightings, sounding measurements, etc. to verify the reliability of the data.

FEATURES  
\*\*\*\*\*

The LP-1000 is an integrated navigator which contains a Loran-C receiver and a 7-inch CRT plotter in a single, splash-proof cabinet.

- \* Two pages of concurrently-plotted chart screens plus two pages of nav. data screens
- \* A wide variety of functions to cope with any kind of situation
- \* User-friendly operation by the latest man-to-machine interface
- \* Large and versatile memory partitions to plot/save ship's course line
- \* Storage of ship's course line and waypoints, using optional RAM card
- \* Artificial coast line presentation, using optional ROM card
- \* Routing and waypoint navigations
- \* Built-in real time clock, alarms, on-screen calculator, etc.
- \* Built-in lithium battery (3 years) for memory back-up
- \* Plotter-only operation, being connected to an external Loran-C, satnav, Decca or GPS
- \* Water temperature and depth indications from an external video sounder, or output of cross-track error for autopilot
- \* Morse-code XTE audible alarm.

\*\*\*\*\*  
\* TABLE OF CONTENTS \*  
\*\*\*\*\*

SPECIFICATIONS ..... 1

INSTALLATION

DISPLAY UNIT INSTALLATION

Mounting ..... 4  
Cable Connections ..... 6  
How to Combine with Auxiliary Equipment ..... 7

ANTENNA COUPLER INSTALLATION ..... 10

OPERATION

ELEMENTARY THEORY

Basic Navigation ..... 12  
How Loran-C works ..... 14

THE LP-1000 BASICS

Keyboard Descriptions ..... 17  
Power-on/off Keys [PWR] & [OFF] ..... 18  
Keyboard Dimmer [DIM] ..... 18  
Data Entry Keys ..... 19  
Plotter-related Keys ..... 19  
Handling Memory Cards ..... 20  
ROM Card ..... 20  
RAM Card ..... 20  
Three Presentation Modes ..... 21  
Plotter Screen ..... 21  
Monitor Screen ..... 29  
Menu Screen ..... 30  
Menu Tree & Interactive Operation ..... 30

[ TOPICS ]

Turning ON-OFF

* Power-on/off Procedure .....	18
* Economy Mode Operation .....	17

Technical Terms

* WPT & Event Marks .....	20
* FROM WPT & TO WPT .....	22
* ROUTE .....	22
* SPD, VTD, BRG, HDG, RNG, TTG, C.ER .....	23
* XTE .....	24

Key Usages

* [EVT] Event Mark & Waypoint .....	27
* [ENT] & [CLR] .....	33
* [↔] & [↔] .....	27
* [CTR] .....	27
* [PLT] & [MON] .....	34

Indications

* "WPT PLT OPT ALM CLC INIT ASF" .....	31
* "↑: BACKWARD ↓: FORWARD" .....	32
* "↑: BACKWARD ↓: SELECT" .....	33
* "SIG.ERR" & "RCV.ERR" .....	24

Others

* Shifting Chart .....	27
* Marks on Plotter Screen .....	22
* Legends on Plotter Screen .....	23, 26
* Erasing Event Marks .....	28
* Path List .....	33

NAVIGATING WITH LP-1000

Initial Operation .....	35
Noise Test after Initial Installation .....	36
Displaying/Erasing Coast Line .....	39
Plotting/Erasing Ship's Course Line .....	40
Entering/Recalling/Erasing Waypoints .....	41
Waypoint Navigation .....	43
Route Navigation .....	44
Erasing Track-line/Waypoint Marks .....	46
Using Alarm Function .....	46

## MORE ABOUT LP-1000

Storing/Recalling Ship's Course Line .....	49
Using RAM Card .....	50
Corrections .....	51
Selecting GRI/Slaves Manually .....	54
Using On-screen Calculator .....	55
Turning on-off LAT/LON Grid Presentation .....	56
Changing Chart Scale Indication Mode (1/[ ] [ ] [ ] [ ] -> [ ] [ ] [ ] [ ] NM) .....	56
Changing Chart Scale at Arrival Automatically .....	56
Calling up Help Screen .....	56
Setting Notch Filters Manually (eliminating interference) .....	57
Selecting Communication Data Format .....	57
Conducting Self-test .....	58
"SIG.ERR" Indication and Loran Signal Status .....	59
<u>MENU LIST OF LP-1000</u> .....	61

## APPENDIX

Loran-C Chains in the World and Recommended TD Pairs .....	APA-1
Modification for RS232C Interfacing .....	APB-1
Standard and Furuno's Current Loop Systems .....	APC-1
LP-1000's Communication Data Format (NMEA 0183) .....	APD-1
Changing Tracking Speed .....	APE-1
Schematic Diagram .....	APF-1
How to recover from "MEMORY ERROR" .....	APG-1
How to replace the back-up battery .....	APH-1
How to replace the ROM chips .....	API-1
Ship's movement and picture scrolling .....	APJ-1
Handling Memory Partitions .....	APK-1
Erasing All Event Marks .....	APL-1
Mechanical Exploded View .....	APM-1



## SPECIFICATIONS OF LP-1000

### RECEIVER CHARACTERISTICS

1. Receiving Frequency 100 kHz
2. Interference Rejection 6 automatic notch filters
3. Tracking Speed 80 knots maximum

### PROCESSOR/DISPLAY CHARACTERISTICS

1. Picture Tube 7-inch flat-face yellow-green CRT
2. Alphanumeric Data

Ship's position in lat/lon, chart scale, bearing/range to a waypoint, ship's speed and course, water temperature and depth (sensor required), L/L of cursor position, range/bearing to a cursor position, event marks, XTE, year/date/time.

3. Course Plotting

Map Scale: 1/2,000 to 1/5,000,000 in 1/1,000 steps or 0.14 to 385 n.m. in 0.08 n.m. steps of horizontal range (operator presetting)  
provided with 2 pages of plotting picture in different chart scales.

Projection: Mercator Projection  
Usable Ground: 85° latitude or below  
Waypoints: 99 points max., identified by 3 alphanumerics  
Plot Interval: The most used 5 intervals may be preset from Hold, 10, 15 ... 50, 55 sec., 1, 2 ... 58, 59 min. or 0.01 n.m. to 9.99 n.m. in 0.01 n.m. steps

4. Alarms

Arrival or Anchor Watch, XTE, Border and Alarm Clock

5. Memory

Built-in RAM chip retaining course/line (1800 points) and Event (1524 points). May be divided into 2, 3 or 6 partitions. Each block may be displayed superimposed on another. (Back up for 3 years)

### OPTIONAL MEMORY CARD

1. RAM Card (backed-up for 3 years by lithium battery)

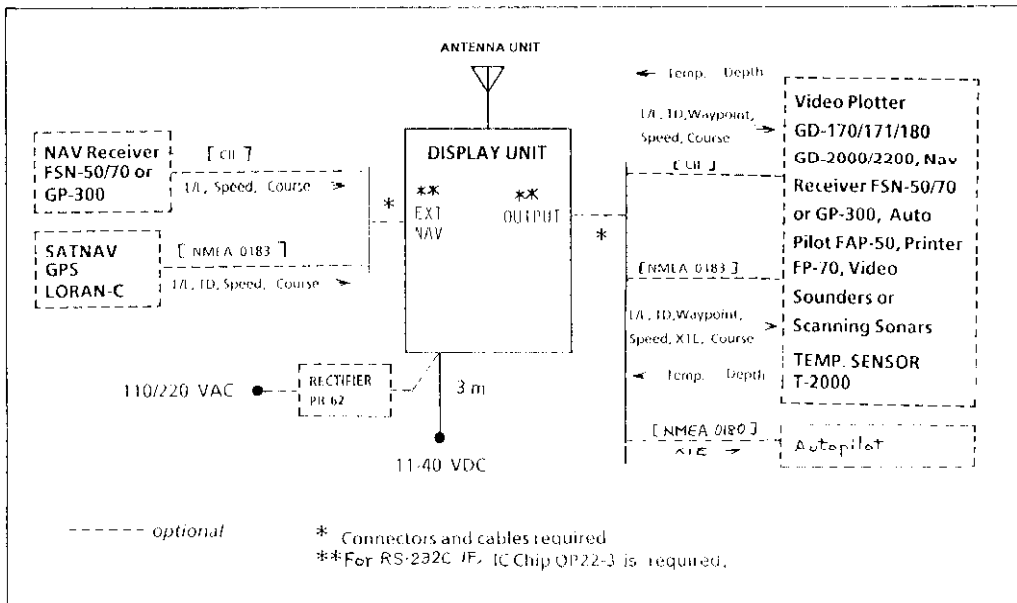
Memory capacity: Duplicates the built-in RAM chip. 1800 course/line points and 1524 event points. (May be divided into 2, 3 or 6 blocks)

### POWER SUPPLY

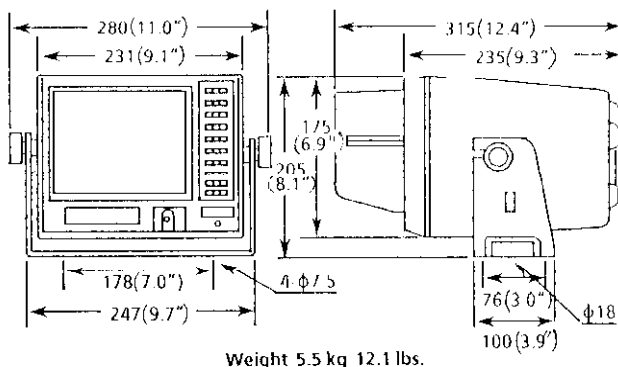
- . 11-40 VDC, 19 W approx. (12 W approx. in economy mode)
- . 110/220 VAC, 50-60 Hz, 26 VA approx. with optional rectifier PR-62

OPTIONAL

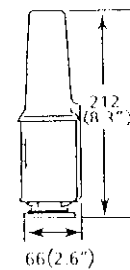
1. 4.0M Antenna OP04-1 [000-041-157]  
2.6M Antenna 04S4176 [000-112-845]
2. 110VAC Rectifier PR-62 [000-013-485]  
220VAC Rectifier PR-62 [000-013-486]
3. RAM Card OP22-5 [004-027-220]
4. RS232C Interface IC (LT1080) OP22-3 [004-026-790]
5. Connector Kit for connection to external equipment  
OP22-1 [004-026-760] for Port "OUTPUT"  
OP22-2 [004-026-770] for Port "EXT NAV"



**DISPLAY UNIT**





**ANTENNA COUPLER  
AC-100C**


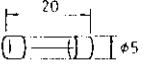
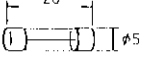


Unit=mm (inch)


PACKING LIST

NAME	OUTLINE	DESCRIPTION/CODE No.	QTY
DISPLAY UNIT		LP 1000	1
ANTENNA COUPLER		AC-100C 004-026-530	1



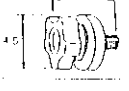

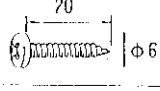

SPARE PARTS

CONNECTOR		XJ8A-0211 000-107-770	2	for RS-232C i/f
FUSE		FGMA 3A 125V (UL) 000-111-848	2	for display unit
FUSE		FGMA 1.6A 125V (UL) 000-111-849	1	for CRT assembly

INSTALLATION MATERIALS

POWER CABLE		22S0019-2 000-109-000	1
-------------	---	--------------------------	---

ACCESSORIES

HOOD		22-001-0123 100-082-410	1	
BRACKET ASSY.		FP-22-00110 004-026-880	1	
KNOB BOLT ASSY.		FP22-00120 004-026-890	2	
GASKET		22-001-0202 100-082-400	1	for flush mounting
+ TAPPING SCREW		6x20 SUS304 000-800-701	4	
FLAT WASHER		M6 SUS304 000-864-129	4	

# DISPLAY UNIT INSTALLATION

## Mounting

### Mounting Location

The display unit is carefully constructed to be able to withstand the humidity and corrosive atmosphere common in the marine environment, but it is not designed to be used outside, directly exposed to that environment. Salt water spray will most assuredly cause damage to the sensitive components inside. Keep these and the following factors in mind when planning the installation of the display unit.

### CAUTION

Furuno will assume no responsibility for the damage caused by exposure to either fresh or salt water.

- 1) The display unit consumes very little power, so there is no need of forced air ventilation. However it is necessary to provide at least some circulation of cooling air by allowing sufficient space around the unit.
- 2) Many owners will undoubtedly use the LP-1000 on small boats, many with center consoles. The display unit must be mounted inside an enclosed cabinet, completely shielded from salt water spray, and from fresh water spray if the boat is usually hosed down after a day's outing. Most small center console boats are equipped with such an enclosed cabinet behind the wheel, and most have clear doors so that equipment may be seen behind them.
- 3) Even though the picture is quite legible even in direct sunlight, it is recommended to keep the display unit out of direct sunlight or at least shaded because of heat that can build up inside the cabinet.
- 4) Consideration should be made to provide space for access to the mounting hardware on the side and connectors behind the display unit. Also allow at least a foot or so of "service loop" in the cables to allow the unit to be pulled forward for servicing or internal adjustment.

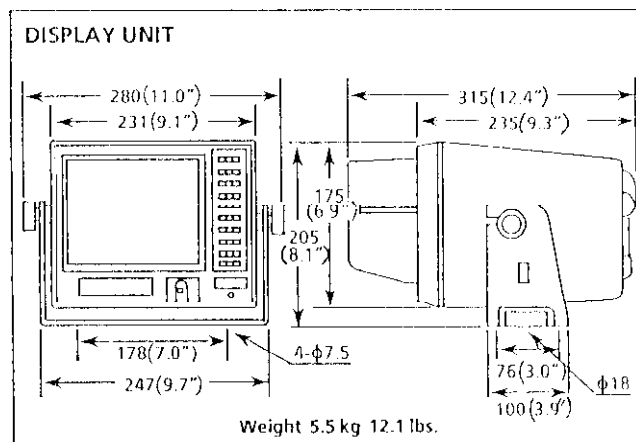


Fig. 1

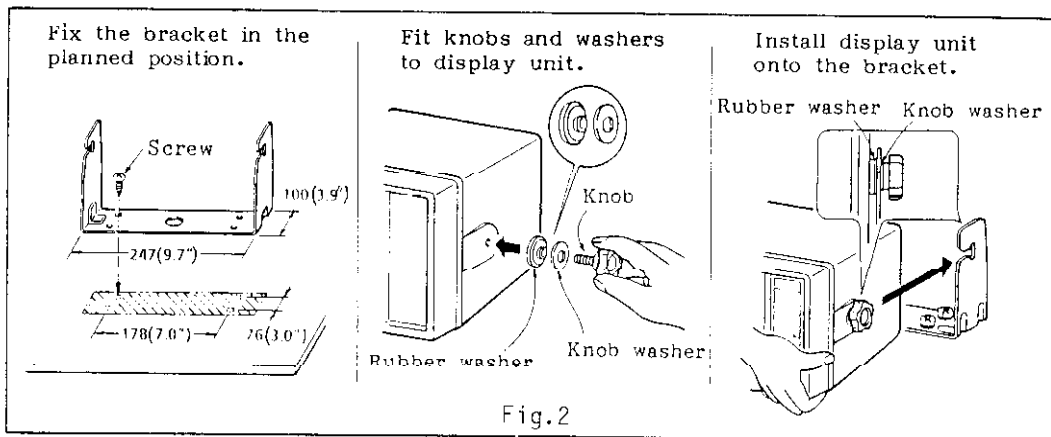
- 5) The display unit can be mounted on either a tabletop, bulkhead or overhead. Make sure that the selected location is strong enough to support the unit under the conditions of continued vibration or shock which will be normally encountered on the boat. If necessary, appropriate reinforcement measures should be taken in the mounting area.
- 6) The display unit should be mounted apart from equipment(s) emitting heat. Also, do not put thing(s) on the top of the unit.

### Mounting the Display Unit

1. Mark the screw locations by using the bracket as a template.

As was stated before, make sure you allow enough clearance both to get to the connectors behind the unit and to allow you to get your hands in on both sides to loosen or tighten the mounting knobs. Make sure you leave at least a foot or so of "service loop" of cables behind the unit so that it can be pulled forward for servicing or easy removal of the connectors.

2. Drill four pilot holes for the bracket.
3. Install the bracket by using the screws supplied.
4. Fit knobs, rubber washer and knob washers to the display unit.
5. Install the display unit in the bracket. Tighten the knobs securely.



## Cable Connections

Cable connections to the LP 1000 display unit are made at the connectors located at the rear of the unit. The following illustration shows the cable connections.

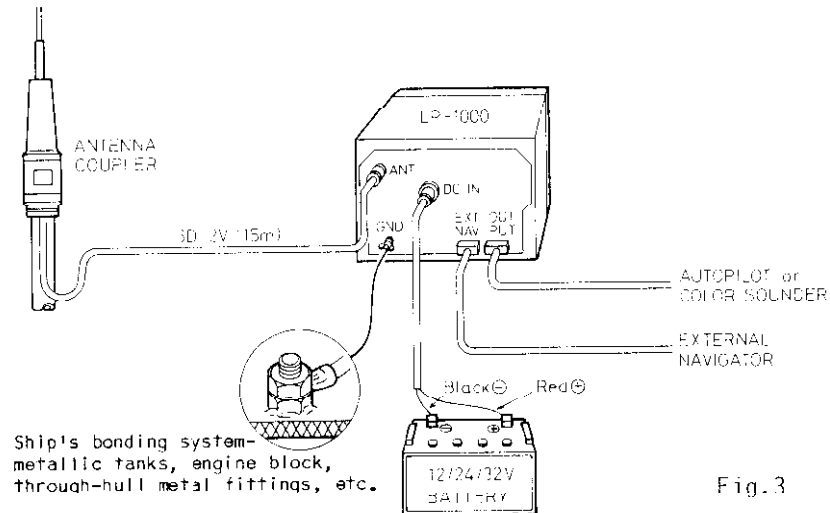


Fig.3

## Power Connection

Ship's power lines are notorious for being "dirty" electrically. The voltage can go all over the place as various heavy loads are placed on the line, and the power wiring is a prime source for interfering electrical signals (from such sources as alternators or generators, and other electronics equipment, like radars or echosounders.)

The LP-1000 is a very forgiving machine since it has a built-in universal D.C. power supply that can take input voltages from 11 to 40 V.D.C. However, a piece of gear of this quality deserves to have a circuit breaker dedicated to it alone. The size of the wire feeding power to the unit should be no less than AWG 16 gauge (0.75 mm square).

## Ground Connection

No less important for proper operation is the ground for the Display Unit. On a steel boat, a good connection to the hull is sufficient. On a wood or fiberglass boat, it is best to use a ground plate mounted on the hull exterior; if this is not practical the engine block can be used. Do not "share" ground leads that go to other equipment in the console, but instead run a separate heavy-duty wire for the LP-1000 alone.

## Antenna Cable

The antenna cable is delivered with the connectors soldered to both ends. But, if you find it necessary to remove the antenna connector that goes to the display, follow the directions in the drawing below. If you don't know how to solder or if you don't know how to do it well, it's best you leave this part to a competent service technician. In perhaps 50 percent of installation problems, poor soldering or wrong wiring of the connectors is where the problem lies. DO NOT SHORT THE ANTENNA CABLE!

### BNC Connector Assembling

- 1) Remove vinyl jacket of 3C2V for 10mm(0.4").
- 2) Slide nut, washer, packing and clamp over braid.
- 3) With clamp in place, comb out braid, fold back smoothly and trim it.
- 4) Remove the dielectric leaving 3mm (0.12"). Do not damage inner conductor.
- 5) Tin inner conductor carefully.
- 6) Slip male conductor in place, butt against dielectric and solder. Be sure cable dielectric is not heated excessively and swollen so as to prevent dielectric from entering into conductor body.
- 7) Push assembly into body as far as it will go. Slide nut into body and screw in place with wrench until tight. For this operation, hold cable and shell rigid and rotate nut.

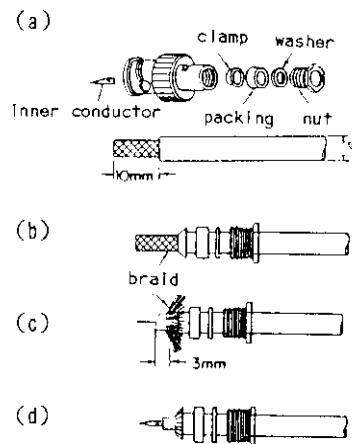


Fig. 4

Unless you are also connecting optional peripheral equipment (external navigator/autopilot/color sounder), the only wiring necessary is for the power connection and the antenna cable.

### How to Combine with Auxiliary Equipment

This machine is provided with two ports (connectors on the rear panel) for connections to external devices:

#### EXT. NAV: Input-Only-Port (SIMPLEX)

When this machine is operated as a display device without using the built-in loran receiver, external position-fixing equipment is connected here. The data format acceptable is FURUNO CIF or NMEA 0183 for either loran-C, NNSS(satnav), Decca or GPS.

NOTE: To use the external navigator, do not forget to select it on the plotter and menu screens. See pages 28 and 57.

#### OUTPUT : Input-And-Output Port (full DUPLEX)

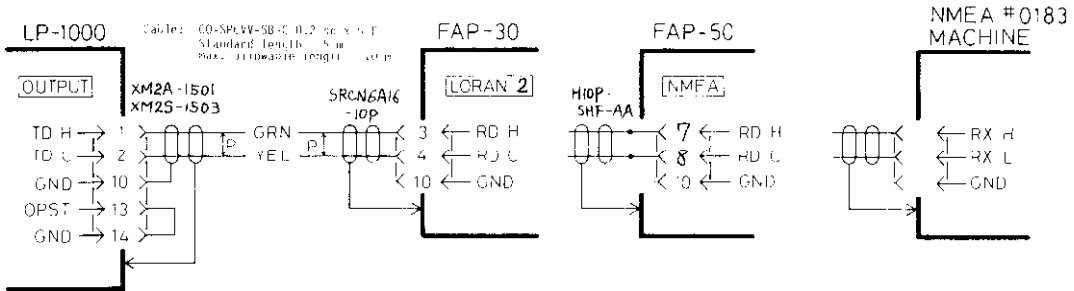
Usually an autopilot or color video sounder is connected to this port. The data format is FURUNO CIF, NMEA 0183 or NMEA 0180 (cross-track error.)

Carry out wiring in accordance with the following diagrams.

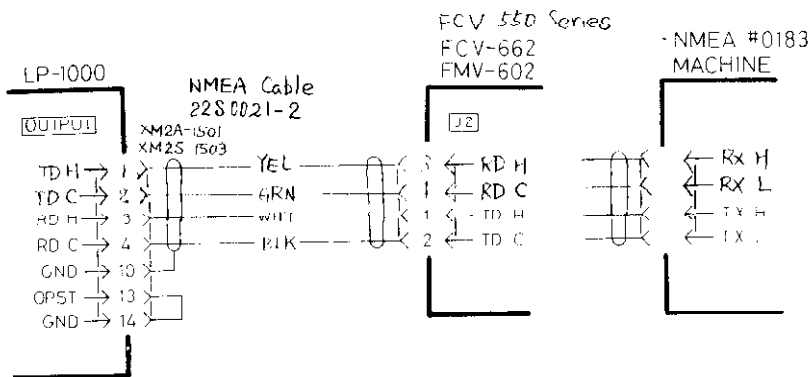
- [Reference Pages]
- P.57 Selecting Communication Data Format
  - P.APB-1 : RS-232C I/F
  - P.APC-1 : 20mA Current-loop with negative logic
  - P.APD-1 : NMEA 0183 Formats

\*\*\*\*\*  
 \* CONNECTION \*  
 \* OF \*  
 \* AUTOPILOT & COLOR SOUNDER \*  
 \*\*\*\*\*

AUTOPILOTS



COLOR SOUNDERS

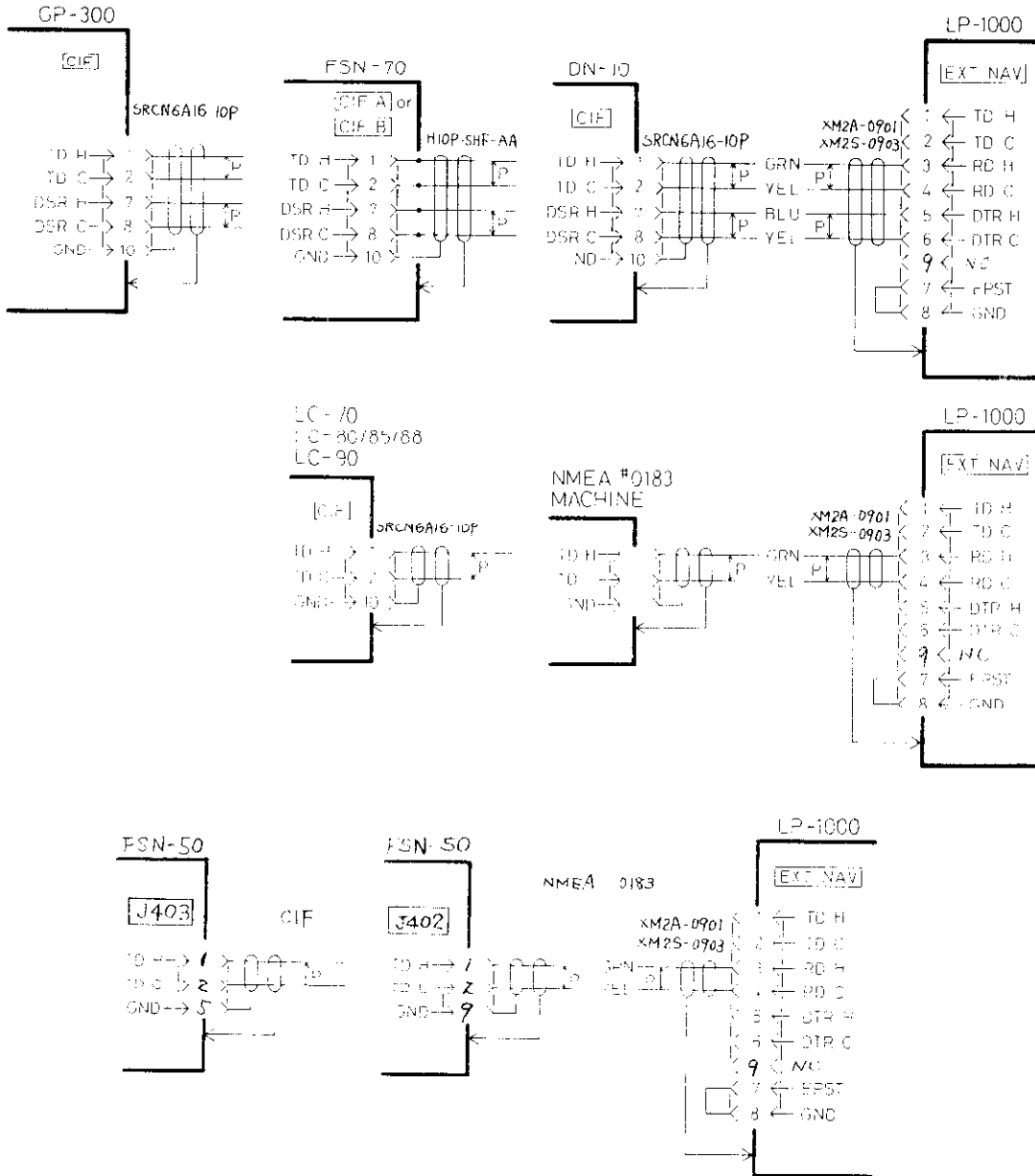


- NOTE
1. The driving capability of this port is 20mA, and the number of the units connectable to this port varies depending on their input impedances. In the worst case where the input impedance is 500 ohm each (specified by NMEA 0183), max. two units may be parallel-driven. (HIGH level +4V specified by NMEA 0183 is ensured because the driving capability 20mA is greater than the total load 16mA ( $4V \div 500 \text{ ohm} \times 2 \text{ units}$ )).
  2. If the "OUTPUT" port is occupied by an auto pilot (NMEA 0180), no other device (NMEA 0183) may be additionally connected to this port even though the driving capability is large enough.
  3. "OP22-1 Connection Kit" (optional) is required. This kit includes the plug for LP-1000 end only. Use the cable included in the options for the autopilot or color sounder.
  4. Do not forget to strap a jumper between pin #13 and #14 on LP-1000.
  5. Ground unused twisted pairs. Floating wire causes noise.



\*\*\*\*\*  
 \* CONNECTION \*  
 \* OF \*  
 \* EXTERNAL NAVIGATOR \*  
 \*\*\*\*\*

Cable: CO-SPEVV-SB-C 0.2 sq x 5 P or 04S41670  
 Standard length = 5 m  
 Max. allowable length = 10 m



- NOTE:
- "OP22-2 Connection Kit"(optional) is required. This kit includes the plug for LP-1000 end only. Procure the cable separately.
  - Do not forget to strap a jumper between pin #7 and #8 on LP-1000.
  - Ground unused twisted pairs. Floating wire causes noise.

## ANTENNA COUPLER INSTALLATION

The antenna coupler unit is completely watertight when installed correctly. It should be mounted as high as possible on the boat, free from the influences of nearby antennas, rigging, and masts. Since it is rarely possible to avoid nearby metallic objects, especially on small boats, a compromise must be struck on most boats.

Most skippers prefer to have their VHF antenna on the highest mast because this is their primary means to signal a distress situation. The second most critical piece of electronics on the boat however should be the Loran-C antenna, and if this must be on the same mast as the VHF antenna, at least try to mount it on a crosstree on the other side of the mast from the VHF antenna. A separation between antennas of at least 3 feet is needed.

Loran-C antennas can perform adequately on sailboats with transom installations, but in marginal signal areas the performance may not be satisfactory. The presence of stays and other metallic rigging can cause the reception pattern to be somewhat more favorable in certain directions, instead of being omnidirectional like it should be. Obviously, it is a real nuisance to have to point the boat in a particular direction in order to find out where you are! There are many sailboat installations where an insulated stay works adequately but a separate whip antenna up in the clear is still preferable.

Antenna siting is not all science, but neither is it all "black magic" either. To determine the best location on your own boat it is suggested that you temporarily mount the antenna in a likely location and try it out. Later on page 36 the recommended test method will be given to determine if the installation site is OK.

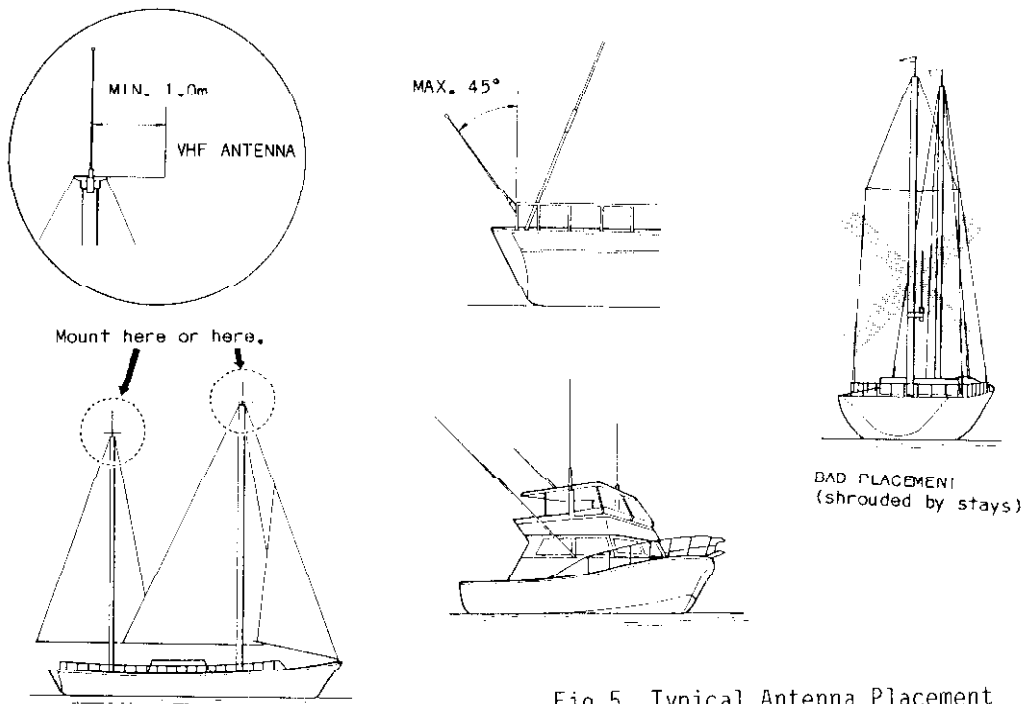


Fig.5 Typical Antenna Placement

The Antenna Coupler uses a standard 96 inch fiberglass marine "CB" whip, which is screwed into the top fitting. (NOTE: so-called "loaded" whips which are much shorter than 96 inches are not suitable as a whip for the LP-1000.)

The body of the Antenna Coupler can be mounted in two ways:

1. The bottom of the coupler is designed to accept a threaded extension mast (recommended height no longer than about 5 feet to prevent undue flexing of the mast in heavy winds). The thread should be 1 inch diameter, with a pitch of 14 threads per inch.
2. The side of the coupler has a molded channel so that it may be mounted directly to a stub mast with the two stainless steel hose clamps provided in the installation material. See the drawing below.

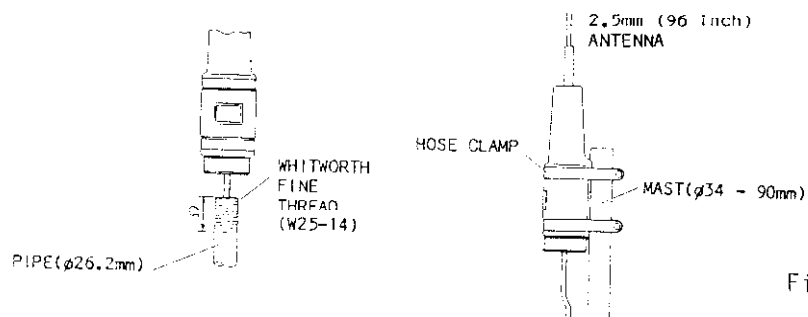


Fig.6

The Antenna Coupler Unit comes with the interconnecting cable already prewired into it from the factory. You may however find it necessary to deal with the display end of the cable since the connector is supplied already wired to the display end. The connector may not fit through holes and wireways, and it may have to be removed and reinstalled later after the antenna cable has been routed through the boat.

When a 4m whip antenna (option-used in fringe reception areas) is used, its installation should be as in the drawing below. Note that the coupler is not designed to withstand the strain of such a large whip directly. Instead, a mounting plate for the 4m whip must be provided, with a wire to the antenna coupler from the bottom of the whip.

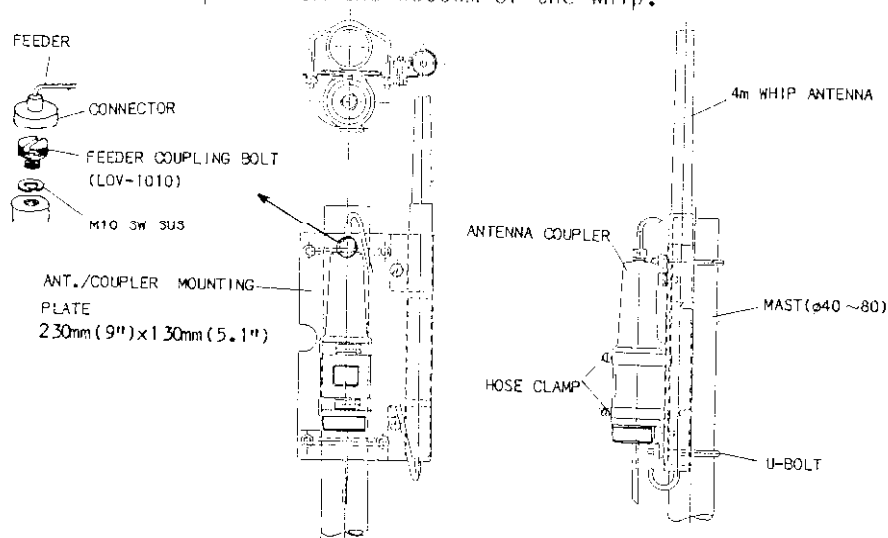


Fig.7

## ELEMENTARY THEORY

The word "LORAN" is an acronym meaning Long Range Navigation. The basic principles of Loran were developed during World War II, and the system implemented during that time was known as the Loran A system. The superior Loran C system was developed later during the 1960's and was put into widespread service during the late 1970's.

Loran-C is one of several important radionavigation systems in use by mariners throughout the world today. Loran-C may be thought of as a medium-range system since it usually covers out to a maximum of 1200 miles from the transmitting station.

For very close-in, precision work, portable microwave positioning systems are often employed by such users as the offshore oil industry, and for short range medium-accuracy work, Decca navigation systems are used in some parts of the world.

For transoceanic voyages, Satellite Navigation and/or Omega receivers are used to provide the sort of coarse accuracy that is suitable on the open sea. In other words, it is rarely necessary to know your position down to the nearest meter when on an ocean voyage, provided that you are reasonably certain that you are within the shipping lane and not in any danger of running aground on some nearby atoll.

The Loran-C system was designed and established to provide excellent accuracy in the region known as the "Coastal Confluence Zone," or CCZ as it is often called. This region extends from the shoreline seaward to the 100 fathom curve, or 50 nautical miles, whichever is greater.

Loran-C system accuracy is often capable of providing a reliable fix within 30 meters of one's actual position, but more typically, accuracy of about 100-200 meters is possible throughout the coverage area. However, system repeatability, that is, the ability to return to the same spot consistently, is usually on the order of 20-30 meters. Quite often it is even better than that.

---

### Basic Navigation

---

The essential idea behind a scheme of positioning on the globe is that any particular point on the earth's surface can be uniquely described by the intersection of two lines: Latitude, girdling the earth horizontally (laterally) and Longitude, girdling the earth vertically.

Examine the section of chart shown next page (Fig. 8) depicting an area off Yokohama Japan. One can see the parallels of Latitude running East and West horizontally, and the meridians of Longitude running vertically North and South. Overprinted on this chart are so-called Loran-C Lines Of Position or TD's (Time Differences) as they are more commonly known. (We'll get into why they are called TD's later; suffice it to say for now that a Loran-C receiver will give you these numbers and that you can use these numbers to find your position.)

Note that the TD lines run at a variety of angles with respect to the lines running North/South or East/West. They are in fact actually curved lines, segments of hyperbolas, but this is difficult to see on this small section

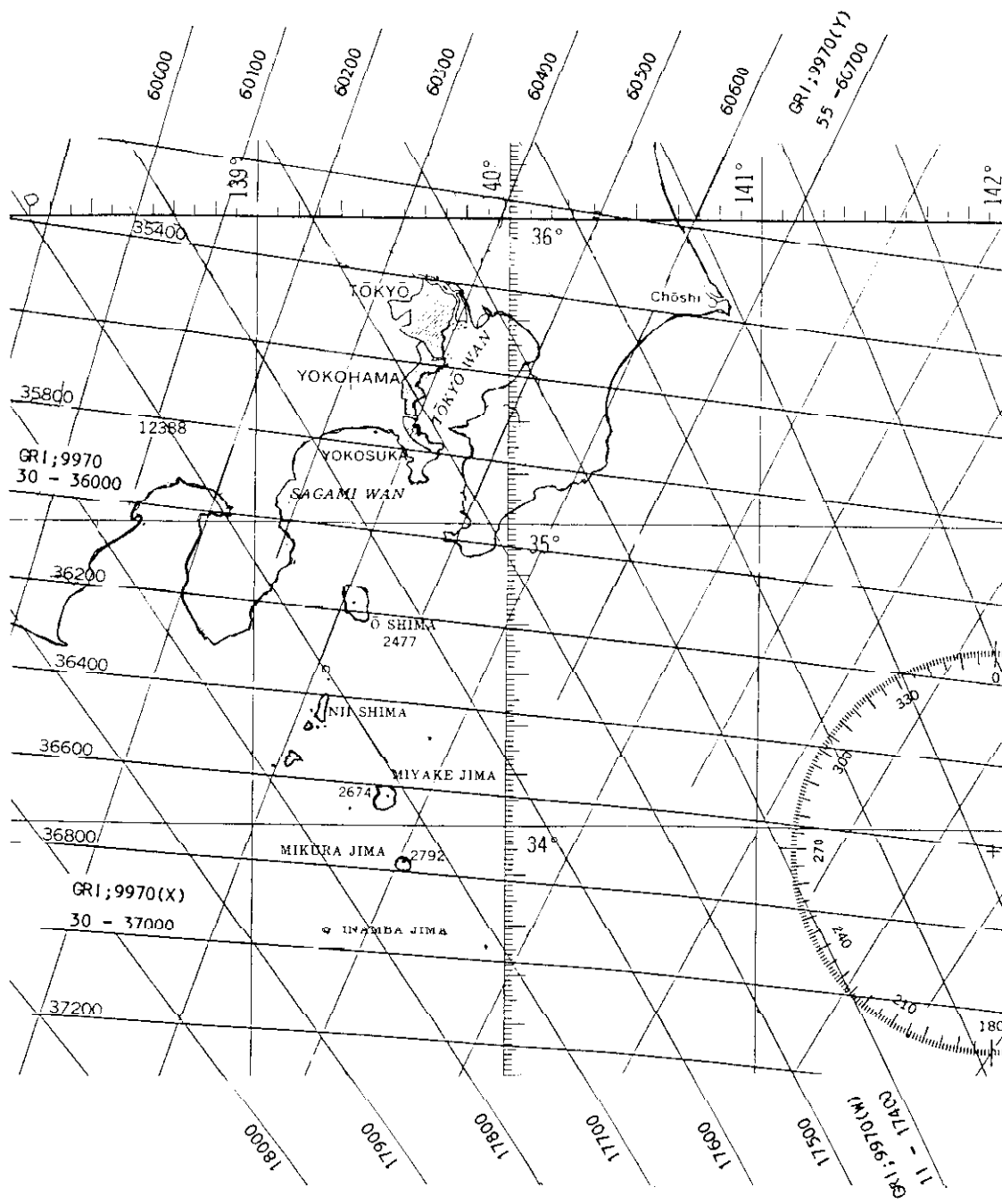


Fig.8 Loran-C Chart of Yokohama

of chart. These TD lines are labeled with numbers in units of microseconds on the outer edges of the chart. The spacing between adjacent TD's will vary depending on the scale of the chart as well as the section of geography being covered. Don't worry about these details just yet, but note that in this particular example the spacing between adjacent TD's is either 100 or 200 microseconds.

Just note that for any one position on the chart (that is, at any one particular Latitude and Longitude) there is at least one pair of Loran-C TD's that cross each other. There may in fact be more than one pair of TD's that cross each other at our one point of interest. Some of them may give you better accuracy than others. Again, we'll delve into that in more detail later.

As an example, let's find a point on the chart and compare the position both by Latitude/Longitude and by Loran-C TD's. At a Latitude of 33 degrees, 52 minutes North and a Longitude of 139 degrees, 35 minutes East you should find the Southeast corner of Mikura Jima Island. This position corresponds to the crossing of the two TD's lines of 36800 microseconds and 60600 microseconds. Note that a third TD crosses this position also, but that the exact line isn't printed on the chart explicitly--it is necessary to interpolate between lines that actually are printed in order to get this TD, and by so doing we would come up with a TD of approximately 17750 microseconds.

Now, let's consider in more detail the way Loran-C actually works.

#### How Loran-C works

The Loran-C system is a "pulsed" system whose fundamental assumption is that the speed of propagation of a radio wave is constant anywhere in the area of coverage of the system. This assumption is actually subject to some corrections, but we will assume for the sake of this discussion that the speed of a Loran-C signal is actually constant.

Since distance, time and speed are all related, and since we have assumed that the speed of the signal is constant, if we can devise some means to measure the time that it takes for a signal to arrive from a distant transmitter, we can easily calculate the distance the signal has travelled to get to us. Thank goodness for modern electronics, for it provides means for making very precise time measurements, down to the order of tenths of millionths of seconds.

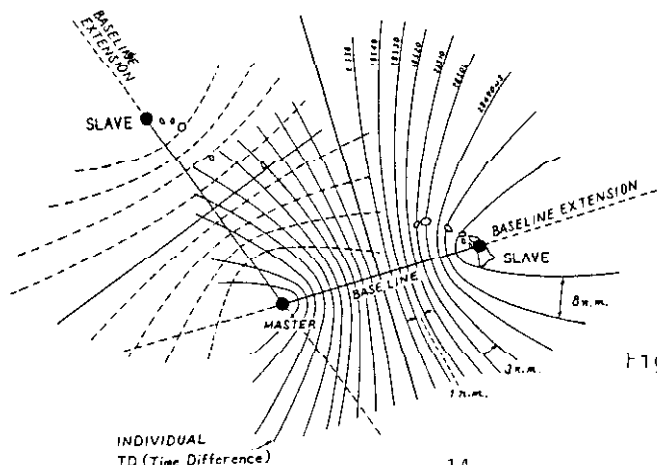


Fig. 9 Simple Loran-C System

A simple Loran-C system is shown in Fig. 9, consisting of a "master" transmitting station and two "slave" stations. This is the simplest configuration used. In practice, most of the chains in the world consist of three or four slave stations associated with each master. Note that the lines drawn connecting the master and each of the two slaves are known as "baselines."

To illustrate the basic idea behind the Loran-C system let us take a simple case, where the boat with the Loran-C receiver is located on one of the baselines and is in the middle between the master and the slave. If the transmitters were both to transmit simultaneously, the time taken for the signals from the master transmitter to arrive will be the same as that for the signals from the slave to arrive. In other words, the difference in arrival time will be zero.

If the boat is moved so that the time difference of signal arrival from master and slave is kept constant at zero, then the plot of these movements will be a straight line halfway between the slave and the master stations. This line will be perpendicular to the baseline. The line of constant time difference is known as a Line of Position, or LOP for short.

Other LOP's can be generated for conditions where the time difference isn't exactly zero, and these LOP's will form hyperbolas rather than the straight line in our simple case. (Radio navigation systems such as Loran-C are often referred to as "hyperbolic navigation" systems for this reason.)

If the master and its associated slaves were all to transmit simultaneously on the same frequency, the receiver would not be able to distinguish which station it was listening to in the resulting uproar. The stations therefore are arranged to transmit in a specific sequence of pulses, with very precisely defined time delays between the transmissions. So, for our simple case above where the LOP is in the middle of the baseline, the time difference is no longer zero, but is some specific value of TD.

The receiver's job is to use the start of reception of the master signal as a reference time to start its internal stopwatch. When the start of the slave signal is detected, the receiver in essence stops its internal stopwatch, notes the time difference, and displays it to the operator as a TD.

In order to determine where one is located on any particular Line of Position, another LOP is needed to intersect the first one. The Loran-C receiver thus must track more than one slave at the same time. Most modern receivers are capable of tracking all slaves available in the chain simultaneously.

The interval of time between the start of the master transmission, the series of slave transmissions and the next master transmission that repeats the whole sequence is called the Group Repetition Interval, or GRI. Each Loran-C chain in the world has a unique GRI assigned to it, and even though all Loran-C transmitters work on the same frequency (100 KHz), they can all be sorted out by GRI.

You will remember that the Time Difference's (TD's) are measured in microseconds (millionths of a second). Further, the designers of the Loran-C system have assigned an identifying letter code to each slave station in a chain. These are called either X, Y, W, or Z.

Now look back at the section of chart in Fig. 8 that shows part of the area near the coast of Japan. You can now better appreciate why the TD's are labeled as they are. The GRI in the label comes first, then the identifying code letter, and then the time difference in microseconds.

Your Loran-C receiver is considerably more sophisticated than the simple TD-only receivers we have been describing here. It is capable of computing Latitude and Longitude directly from these TD's.

This is a complex calculation, and again the fundamental assumption made is that the velocity of propagation of the signal is constant. While this is true for propagation over seawater, the velocity is altered slightly when the signals travel over land. Over land, the velocity is affected by such factors as the conductivity of the soil and the features of the terrain. These effects are all lumped together under the title of "Additional Secondary Factors," or ASF. These factors cannot be modeled exactly in the TD to Latitude/Longitude mathematical conversion.

The LC-90 however has TD offsets built-into it, describing deviations from the ideal grid. The offsets were actually measured at sea. The LC-90 can automatically take these warpages into account to give more accurate computation of Latitude and Longitude than can a receiver without this automatic ASF correction.

Note that the TD grids on a Loran-C overlaid chart can be shifted when the chart is printed and thus compensated to take care of actual observed readings from the field. One should still be careful when using Latitude/Longitude numbers directly from a Loran-C receiver, especially when near land since this is where significant errors can occur. (Note that the charts don't even show Loran-C grids over inland areas because of the extreme distortions in the lattices over land.) Also, Loran-C is not meant to be used in harbors or ports since these are usually surrounded by land masses.

Well, enough theory for now. Let's get down to how you actually operate your new machine. Some advanced concepts and further cautions on the use (and misuse) of the system will be given later.



# THE LP-1000 BASICS

The LP-1000 is basically a rather simple unit to operate, although at first glance it may be a little intimidating to someone who has never used a Loran-C navigator or computer-aided machine. Try to operate your own machine as guided in this section, and you will find the operation is quite simple once you become acquainted with several rules of operation.

This section also presents basic ideas of navigation. After having finished this section, you will surely feel like sailing out with your new machine.

## Keyboard Descriptions

All the operations of this machine, except for the screen brilliance, are carried out through the keyboard.

Screen brilliance is adjusted with the knob which is located below the CRT. When the knob is turned fully CCW (click point), the machine operates in the economy mode i.e., the CRT is turned off completely, but the internal electronics continue working.

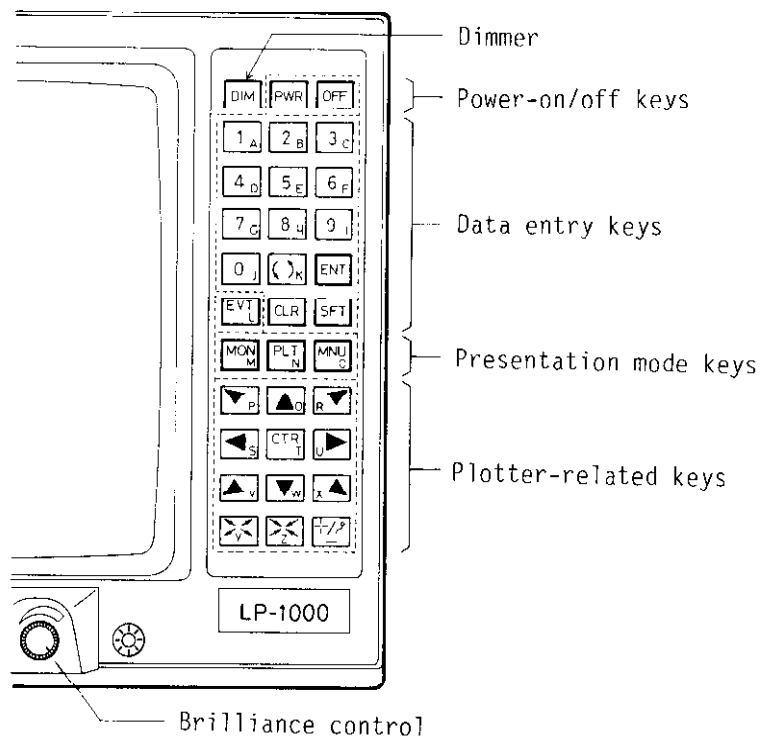


Fig. 10

Hit of any key is followed by a short beep for acknowledgement. And, when an illegal key stroke is detected by the machine, a low-pitched beep is released.

The following tables brief all the key functions. Do not worry if you do not understand some items. Detailed explanation of each key function is provided in the later sections.

#### Power-on/off keys [PWR], [OFF]

##### Power-on procedure

When [PWR] is hit, (1) power is applied to the machine (2) a beep is released, and (3) the self-test is conducted. If no fault is detected, self-test results will be presented as shown left, and a little later the monitor screen will appear as shown right. Now you may start operation!

##### Self-test Screen

```
08/24/87
09 15 30

STARTUP STATUS

RAM SYSTEM AREA : OK
RAM USER AREA   : OK
MEMORIES        : OK

ROM1 NO.225-0101-104
ROM2 NO.225-0101-204
NOW STARTING UP!
```

##### Monitor Screen

```
08/24/87      NAV:K  D: [RECRIN]
09 15 59

TD1 : 36378.6
TD2 : 59112.0

ASF : 'ON'      DEV : 18
MACV : 'AJIO'   TRK : 000
TR-LL : OFF

SNR  FID
MASTER = 99    2 :
TD1 = 99      0 :
TD2 = 99      0 :
PLEASE ENTER +/- VALUE FROM 10
TO 30 MICRO SECONDS.
CORRECT MASTER : +DIG MICRO SEC?
```

Fig. 11

NOTE: When "MEMORY ERROR" is presented on the bottom line of the self-test screen and the monitor screen does not show up, conduct the operations on page APG-1 (end part of this manual).

##### Power-off procedure

To turn off the machine, hit [OFF] while pressing [PWR]. (This arrangement prevents unintended turning-off of the machine.)

Even when the machine is turned off, all the information (including the plotting picture and the various data which you entered) are kept "alive" in the machine. Therefore, you may restart operation with the same condition when the machine is turned on again.

**CAUTION:** Engine ignition generally causes considerable fluctuation of the supply voltage and may result in erratic operation of this machine. Start the engine with the machine turned off.

##### Keyboard dimmer [DIM]

Every hit of this key alternately turns on and off the keyboard back-light.

#### Data entry keys

[0], [1] --- [9] (Numeric keys)

These keys serve to input numerals.

[SFT] (Shift)

The keys with small alphabets marked on them may be used as alphabetic keys. If you want to input an ID code (3-digit identification code of data) with alphabets, hit [SFT]. The "SHIFT" indication will appear at the lower right corner of the screen, and you may input alphabets by hitting those keys.

To return to the normal key mode hit [SFT] again, and the "SHIFT" indication will disappear. Note should be taken that SHIFT is automatically cleared when [ENT] is hit.

[↔] (Polarity changeover)

By hitting this key, you may change the polarity of the datum (LAT/LONG for example) which you have input with the numeric keys.  
(+ ↔ -, NORTH ↔ SOUTH, WEST ↔ EAST)

[CLR] (Clear)

When you have hit wrong alphanumeric key(s), you may cancel the datum by hitting [CLR].

Hit of this key also silences the alarm.

[ENT] (Enter)

After having input a correct datum with the above-mentioned keys, hit [ENT], and the datum will be formally accepted by the machine.

#### Plotter-related keys

[↔], [↔] (Chart scale changer keys)

Depression of these keys expands or shrinks the chart scale.

[+/-] (Cursor presentation on-off key)

Every hit of this key alternately turns on and off the cursor "+" presentation.

[↑], [↗], [→], [↘], [↓], [↙], [←], [↖], [CTR] (Cursor/chart shift keys)

You may shift the cursor "+" on the chart by pressing these keys.

If the cursor presentation is turned off, depression of these keys scrolls the chart on the screen.

[EVT] (Event)

Hit of this key puts an event mark at the cursor or on the ship's LAT/ LONG position. You may also put a waypoint at the cursor position.

#### WPT (waypoint) and Event Marks

In navigational terminology, a particular location is known as a "waypoint" whether it be a starting point, a destination or an intermediate point on a voyage. You may register up to 99 waypoints in various ways (explained on page 41), and may use some of them for navigation.

As for the event mark, it is a reference mark which is put on the chart screen electronically when some event is encountered during navigation.

#### Handling Memory Cards (optional)

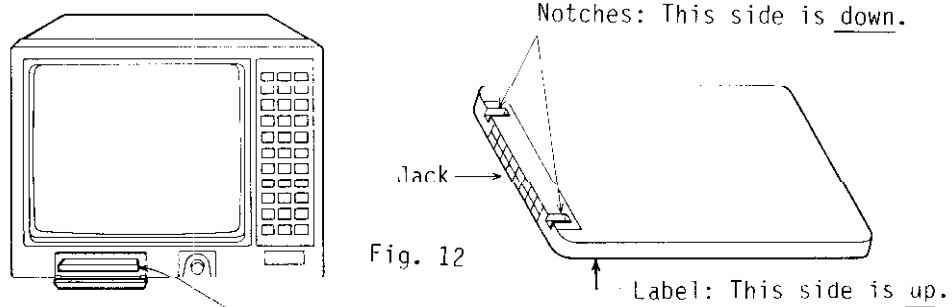


Fig. 12

Flip down the lid, and insert the card into the slit gently, leaving about an inch of the card end outside of the drive.

There are two types of memory cards:

#### ROM (Read-only-memory) card

Usually a coast line is factory-recorded, and it may be called onto the screen.

#### RAM (Random-access-memory) card

This type of memory card is utilized to save ship's course line/event marks and waypoints which were created during operation. The contents may be reloaded on the machine.

The memory card should be inserted into the memory card drive (located below the CRT) with its jack end facing forward and the notch side down. As the memory card receptacle is very delicate, do not apply excessive force when inserting a card.

If the operation which involves a memory card is done without inserting a card properly, <NO CARD!> will be presented on the lower part of the screen.

#### Handling Precaution on Memory Card

1. To prevent data destruction of the RAM card, turn on or off the machine with the card pulled out from the drive.
2. Do not leave the card in direct sunlight. Do not place it in hot, wet or dusty environment. Keep it away from electrified material. (Do not put it in a plastic bag, the pocket of a nylon jacket, etc.) Keep the card-edge connector clean.
3. Do not strike, bend nor disassemble the card.
4. A lithium battery in the RAM card preserves the memory contents for about 4 years. To ensure important information will not be lost, record on the card the date of purchase, and transfer the card contents onto a new card well before the expiration date of the battery. (To copy card contents, load the old card contents onto a memory partition, and save it onto the new card. See page 50.) (The built-in battery can not be replaced.)

#### Three Presentation Modes

Three types of presentations (PLOTTER, MONITOR and MENU) are available with this machine, and they may be called on the CRT at any time by hitting [PLT], [MON] and [MNU] respectively.

#### Plotter screen [PLT]

- NOTE 1. If this is the first time for your machine to be operated after installation, ship's position may not be fixed even if you turn on the machine. But do not be worried. This is because a special operation (initial operation mentioned on page 35) has not been done.

In this case, it might be better to skip this and the next sections and start reading from MENU TREE & INTERACTIVE OPERATION (page 30). Return to this section again after having finished the initial operation on page 35. (Or, if you are anxious to know the basic part of this machine soon, continue reading this section straightly. Note however that several items may not be presented on the screen.)

2. When you call up the plotter screen for the first time after turning-on of the machine, plotting operation cannot start immediately, i.e., ownship mark will remain at the screen center. Wait until "SIG.ERR" disappears from the top right corner of the screen and the LAT/LON readouts become reasonable. (These signs indicate that the built-in Ioran receiver has locked on the Ioran signal.) Now hit [PLT] again, and plotting will start. This arrangement prevents the screen from being filled with random plotting marks before the machine starts position fixing.

Interpreting the plotter screen (graphic marks/lines)

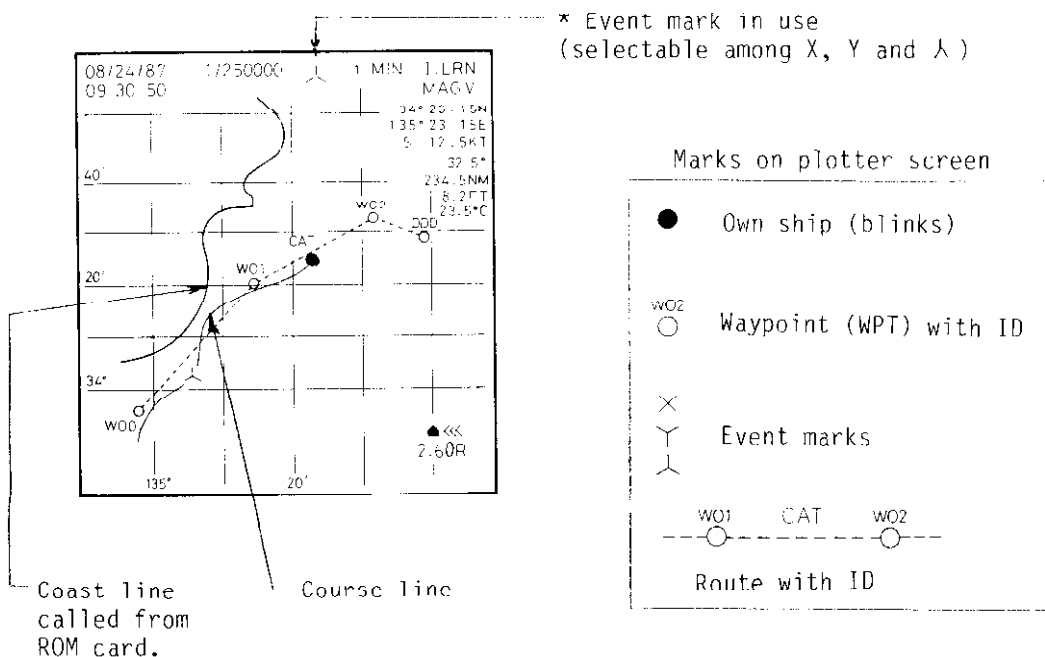


Fig. 13

ROUTE

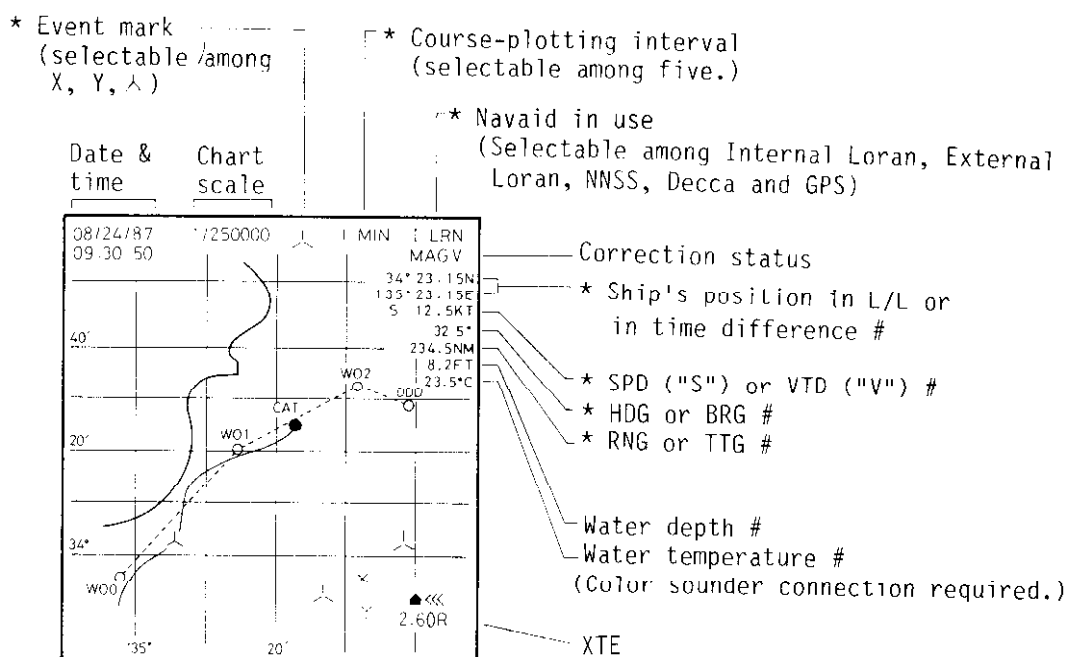
In many cases, a voyage from the origin to the final destination involves several course changes, requiring a series of waypoints which you navigate to, one after another. The sequence of waypoints leading to the final destination is called a "route."

FROM WPT & TO WPT

As mentioned above, navigation is achieved by passing over waypoints one after another. The waypoint which you are presently sailing for is called the "TO WPT" and the one which you have just left is called the "FROM WPT."

In most short-range navigations, we leave the origin and sail to the destination straightly without making course changes. In this case, FROM WPT is the origin, and TO WPT is the destination.

## Interpreting the plotter screen (text)



NOTE: The chart scale indicated on the top line is for reference only; it is not intended for strict use.

\* may be selected. # may be magnified. (See P.28.)

Fig. 14

SPD: ship's speed	VTD: velocity-to-destination
HDG: ship's heading	BRG: bearing to TO WPT
RNG: range to TO WPT	TTG: time-to-go to TO WPT
C.ER: course error	

HDG discussed here is the ship's moving direction which is calculated through position fixings. HDG is not always equal to the ship's bow direction, which is typically measured by using a compass. This is because the ship can be moved off the bow direction due to current, drift, wind, uneven load condition, etc. Imagine an extreme case where your boat is stationary and is drifting to starboard with the bow directed to north. The compass reading would be zero though your boat is moving in a 90° direction.

SPD is the ship's true speed measured in the above-mentioned HDG direction. This value is also calculated through position fixings. Thus, SPD is the ground-tracking speed. It should be noted that the speed which is measured by a speed log is the water-tracking speed in ship's fore-aft. direction. The log indicates the true speed only when the water is still and the ship is moving exactly in the bow direction.

The deflection of HDG from the TO WPT direction is termed C.ER (Course Error). See the left figure on the next page. If negative C.ER is indicated, the TO WPT is in the port direction. Unless the sign "-" is given to the C.ER indication, the TO WPT is to the starboard.

SPD may be broken into two components as shown in the right figure below. One is the component which serves to carry the ship toward the TO WPT, and is termed VTD (velocity-to-destination). The other is the component which is at right angle to VTD and does not go to the destination. When HDG exactly coincides with the TO WPT direction, i.e., C.ER is zero, VTD gets equal to SPD and the invalid speed component becomes zero. As C.ER increases, VTD decreases and the invalid component increases. When the boat is getting far from the TO WPT, negative VTD is presented.

TTG (time-to-go) is obtained by dividing RNG (range to TO WPT) by VTD at the present moment. When the boat is getting far from the TO WPT, negative TTG is presented.

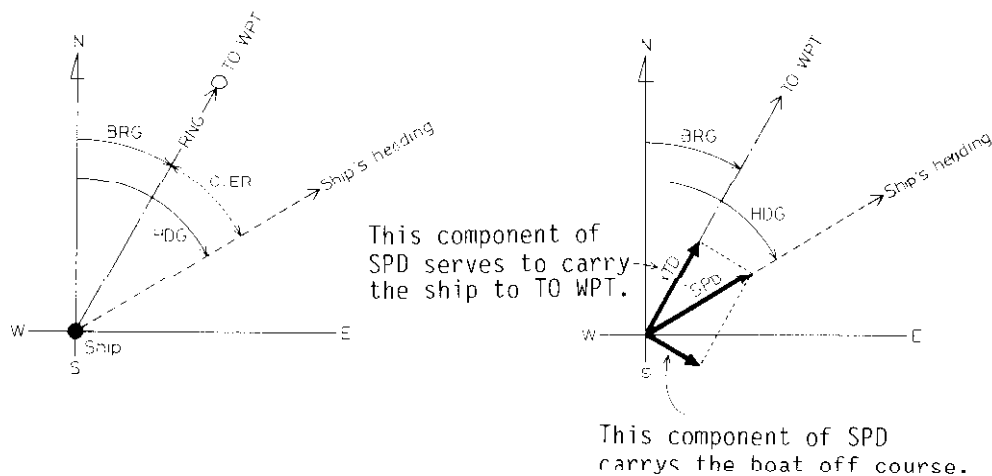


Fig. 15

#### "SIG.ERR"(signal error) & "RCV.ERR"(data link error)

Once the internal Loran has locked up, "SIG.ERR" rarely appears on the screen. The meaning of this sign is that the Loran signal is received with unfavorable condition and the ship's position currently indicated may be unreliable. (Detailed description is given on page 59.) The external Navaid can also cause this message provided that position data is fed with Furuno CIF format.

On the other hand, "RCV.ERR" appears when this machine is used as a plotter for an external navigator but position data is not coming in.

#### XTE (Cross-track error)

On a voyage between FROM WPT and TO WPT, a straight line drawn between the two points is known as a "track." It could just as well be termed the "intended track" because although it is the user's intention to follow this course faithfully, in reality, he never can do so perfectly due to wind, current, etc.



The amount which the boat is thrown off the intended track is termed the "cross-track error," and is presented on the lower part of the screen along with the wheel-steering instruction:



Fig. 16

As detailed on page 47, you may set a safety-lane on both sides of the intended course. And, the number of "<" or ">" mark indicates what percent of the lateral lane width the cross-track error amounts to. One point of the mark equals one third of the lateral lane width.

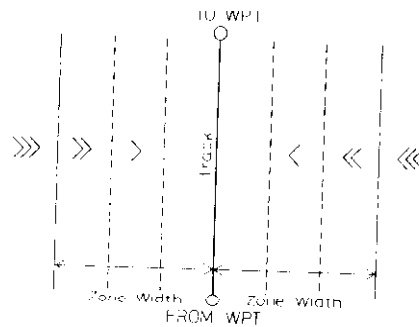


Fig. 17

When the ship goes outside the safety-lane, three points of the marks appear and an alarm is released. (The Morse-coded audible alarms are ". . . ." (R) for STEER RIGHT and ". . . ." (L) for STEER LEFT. Be careful not to confuse them.)

Interpreting the plotter screen (cursor)

When [+/ $\bullet$ ] is hit, a cursor "+" and following data are additionally presented.

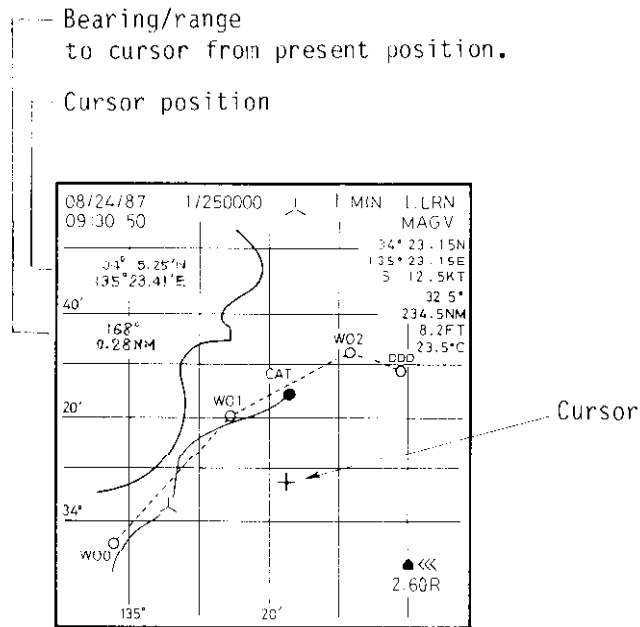


Fig. 18

Dual page plotting

This machine is provided with two pages of plotting pictures, and either page may be called on the screen. To switch the page on the screen, simply hit [↔].

The two pages are essentially equal to each other, but note that a different section of a chart may be projected on the CRT with a different scale (by using arrow and [X]/[X] keys) as shown below. It may be advised to use one page with a large scale to grasp the general situation occasionally.

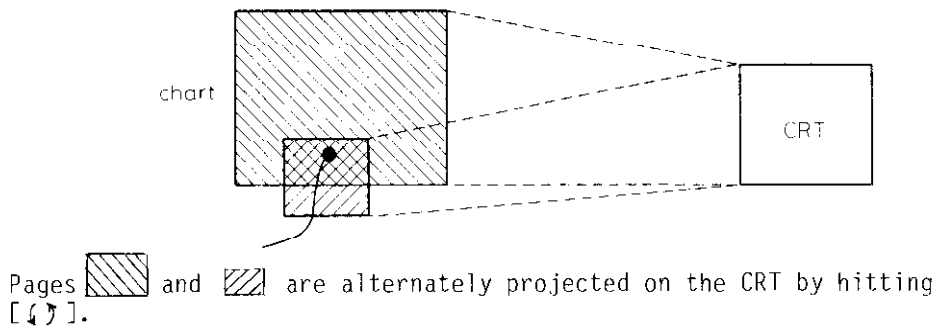


Fig. 19

The plotter screen will be the most often-used mode, and the following operations may be conducted here.

- (1) Turning on-off the cursor presentation. [+/P]
- (2) Changing the chart scale. [X<], [X>]

If these keys are depressed with the cursor presented on the screen, (i) the cursor-pointed location (LAT/LON) becomes the screen center and (ii) the chart expands/shrinks.

If the keys are depressed without the cursor, (i) own ship's L/L becomes the screen center and (ii) the chart expands/shrinks.

- (3) Shifting the cursor or chart. [↑], [↗], [→], [↘], [↓], [↙], [←], [↖] & [CTR]

#### Scrolling Chart

When the cursor is absent from the screen, depression of an arrow key scrolls the chart on the screen. When the chart stops shifting and beep is repeated, release the key and depress it again. The chart will be scrolled further.

For the automatic scrolling due to the ship's movement, see page APJ-1.

#### [CTR]

If [CTR] is hit with the cursor presented on the screen, the LAT/LONG of the cursor becomes the screen center. (The cursor itself remains at the same position on the screen.)

If [CTR] is hit without the cursor presented, the own ship position becomes the screen center.

- (4) Putting event mark or waypoint on the ship's position or cursor position.

#### [EVT] Event mark & waypoint

Turn on or off the cursor presentation. If the cursor is presented, the following operations will put an event mark or waypoint on the cursor position. If not, it will be put on the present ship's position.

1. Hit [EVT], and the machine will prompt you to enter an ID (identification code) on the bottom line of the screen.
2. To put an event mark, just hit [ENT] without hitting any other key.

If you want to put a waypoint, enter an alphanumeric ID.

#### Erasing event marks

To erase an event mark, (1) move the cursor onto the intended event mark and (2) hit [CLR].

You may erase all the event marks. See P.APL-1.

#### Choosing item indications and parameters

The following items, which are presented at the upper right corner of the screen (with "\*" marks on Fig. 14), may be chosen as instructed below.

- \* Event mark
- \* Course-plotting interval

You may choose an interval among five which were registered beforehand (detailed on page 40).

- \* Navigator

You may choose the Internal Loran or External Navaid. (One external navaid should be selected beforehand among Ext. Loran, NNSS (satnav), Decca and GPS. See P. 57.)

- \* Ship's position (in LAT/LON or in time differences)
- \* SPD or VTD
- \* BRG or HDG
- \* RNG or TTG

#### [Procedure]

- (1) Every hit of [SFT] lights up the character indication item by item. Hit [SFT] until your intended item lights up. If you want to use a different event mark for example, hit [SFT] to light the event mark indication on the top line.
- (2) Now, you may change the item by hitting [↵]. (In this example, every hit of [↵] will change the event mark among "X", "Y", and "A".)
- (3) After having changed the item, hit [CLR] to return to the normal indications of the item. (You may omit this step as the indications become normal automatically in 15 seconds.)

#### Changing character size

The indication of the above-mentioned items (# mark in the same figure) may be doubled in size by:

- (1) Select an item with [SFT] in the same manner as above.
- (2) Now, you may magnify the item indication by [⌘], or return it to the normal size by [⌘].
- (3) Hit [CLR]. (you may omit this step.)

**Monitor screen** [MNT]

Detailed navigational alpha-numeric data are presented as shown below.

Date & Time	Page ID
08/24/87 09:15:53	NAV: ◀ ▶ : TD CRTN
LAT : 37° 49.01' N	} LAT/LON or TD's is presented alternately at every hit of [↔]
LON : 122° 21.52' W	
NAV : (ROUTE ID = ABC) 090 --▶ 100	} (Route ID) FROM WPT --▶ TO WPT
RNG : 2.98 N.M.	} Nav. data (explained on page 23.)
TTG : 2H 7M	
BRG : 36°	VTD = 1.1 KT
HDG : 58°	SPD = 1.3 KT
C.ER : -22°	DEP = 8.0 FT
XTE : 2.65R	TMP = 23.4°C
	Water depth
	Water temperature

With the above screen presented, you may put an event mark on the ship's present position by hitting [EVT].

Bear in mind that navigational data are presented over two pages, "NAV" (Navigation) and "TD CRTN" (TD Correction). The top line of the above screen indicates that "NAV" page is presently selected and that [←] and [→] are available for page change. Hit [→], and "TD CRTN" page will be presented as shown below. (Hitting [MNT] also changes the page alternately.)

08/24/87 09:15:59	NAV : ◀ ▶ : TD CRTN	} Same as NAV page
TD1 : 36378.6		} Time differences
TD2 : 59112.3		
ASF : 'ON'	DEV. : 18	} Loran sig. status and prompt for correction data entry (page 59)
MAGV : 'AUTO'	TRK. : 000	
TD-LL : 'OFF'		} Correction status (page 51)
SNR	ECD	
MASTER = 99 ? :		
TD1 = 99 0 :		} You may enter TD correction values. (page 51)
TD2 = 99 0 :		
PLEASE ENTER +/- VALUE FROM 10 TO 30 MICRO SECONDS.		
CORRECT MASTER : +00 MICRO SEC ?		

Fig. 21

**Menu screen** [MNU]

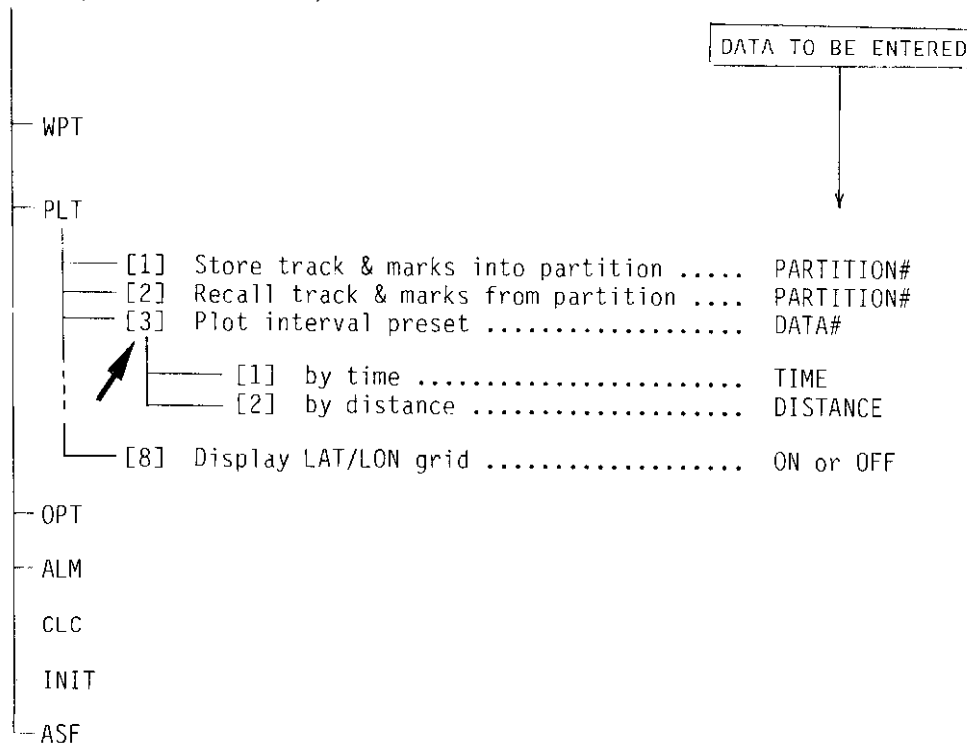
Various data may be entered through this screen, and the method to communicate with this screen is described in the following section.

Menu Tree & Interactive Operation

Virtually every navigation function conceivable has been programmed into this single unit. However, you may rest assured that operation is rather easy thanks to the object-oriented, systematically structured menu system.

The MENU LIST starting from page 61 shows the entire menu structure, but only one part of it is sampled below. This section shows you the operational concept, referring to this sample. At this stage, it is not necessary to understand the meanings of the technical terms presented on the screen. Simply learn how to communicate with the machine.

[MNU] ("START" is here!)



- (1) As shown above, there are seven sub-menus (WPT, PLT, OPT, ALM, CLC, INIT and ASF), and the first step of the dialogue is to call your intended sub-menu on the screen. If the plotter or monitor screen is presented, hit [MNU]. Now you will see one of the seven sub-menus on the screen. The following figure shows sub-menu PLT.

```

08/24/87      Δ : BACKWARD  ▽ : FORWARD
10:27:42
( * PLOTTER FUNCTIONS X )
[1] STORE TRACK & MRKS INTO PARTITION
[2] RECALL TRACK & MRKS FROM PARTITION
[3] PLOT INTERVAL PRESET
      : 1.11 NM,      1 MIN,      10 SEC.
      : 0.50 NM,      1.00 NM
[4] MARK FOR EVENTS
[5] MEMORY PARTITION TYPE & ERASE
      600*3      NOW
[6] SCALE AT ARRIVAL
      1/10000    'OFF'
[7] CHANGE SCALE UNIT (NM: 1/X)
      RANGE
[8] DISPLAY LAT/LON LINE
      'ON'

==CHOOSE MENU== [?]
WPT  [PLT]  OPT  ALM  CLC  INIT  ASF

```

← Item-choice keys

← On-menu items (Sub-menu)

← Prompt line

← Main menu line

Fig. 22

Look at the main menu on the bottom line. Abbreviations of the seven sub-menus are presented there, and only "PLT" is lit since sub-menu PLT is now on the screen. Such a main menu line appears on every sub-menu screen.

"WPT PLT OPT ALM CLC INIT ASF"

When the main menu is presented on the bottom line as shown above, you may call one of the sub-menus by hitting [←] or [→]. (Hittings of [MNU] also select a sub-menu.)

- WPT : Waypoint
- PLT : Plotter functions
- OPT : Options (=memory card)
- ALM : Alarm
- CLC : On-screen calculator
- INIT: Initial operation
- ASF : Additional Secondary Factor (=various corrections, etc.)

In this exercise operation, we will enter a plot interval. Call "PLOTTER FUNCTION" screen by hitting [←] or [→] if a different sub-menu is presented.

- (2) Notice that you are requested to choose one of the on-menu items and enter its item# on the prompt line. The keys which serve to choose an item are indicated on the top line.

"↑ : BACKWARD ↓ : FORWARD"

When the above indication is presented on the top line, you may choose one of the on-menu items by hitting [↑] or [↓] and then [ENT].

### Item choice by numeric keys

Instead of hitting [↑] or [↓], you may directly input your intended item number on the prompt line by hitting a numerical key. In this case you need not hit [ENT].

Hit [↑] or [↓] until your intended on-menu item indication ([3]) PLOT INTERVAL PRESET for example) is lit, and finally hit [ENT].

```
08/24/87      Δ : BACKWARD  ▽ : FORWARD
10:27:42

(* PLOTTER FUNCTIONS *)
[0] STORE TRACK & MRKS INTO PARTITION
[2] RECALL TRACK & MRKS FROM PARTITION
[3] PLOT INTERVAL PRESET
      : 1.00 NM,      1 MIN      10 MIN,
      : 0.50 NM,      1.00 NM
[4] MARK FOR EVENTS
[5] MEMORY PARTITION TYPE & ERASE
      500*1      NOW
[6] SCALE AT ARRIVAL
      1/10000      OFF
[7] CHANGE SCALE MODE
      RANGE
[8] DISPLAY LAT/LON LINE
      ON

== CHOOSE MENU == [?]
WPT  [PLT]  OPT  ALM  CLC  INIT  ASF
```

Fig. 23

- (3) When [ENT] is hit in the preceding step, lower-level menu which is related to the chosen item will be displayed.

```
08/24/87      Δ : BACKWARD  ▽ : SELECTION
10:28:32

(* PLOT INTERVAL PRESET *)

NO.1 :  9.50 NM
NO.2 :  11 MIN
NO.3 :  10 NM
NO.4 :   5 MIN
NO.5 :  30 SEC

YOU MAY ENTER 5 KINDS OF DATA BY
'TIME' OR 'DISTANCE' PREVIOUSLY.
PLEASE CHOOSE ONE OF THESE ON THE
PLOTTER SCREEN BY [SHIFT] & [0].

CHOOSE NO. : 0 ?

WPT  [PLT]  OPT  ALM  CLC  INIT  ASF
```

} Five plot intervals  
} Comments

Fig. 24



In this example, you now stay at the point in the menu tree which is pointed to by "↖" on page 30, and the screen should be something like above.

Again, choose one of the on-menu items by hitting [↓] and [ENT].

"↑ : BACKWARD    ↓ : SELECTION"

When the above indication is presented on the top line, you may choose an on-menu item by hitting [↓](or numeric key) and then [ENT].

If [↑] is hit, the pre-presented screen will be restored, i.e., you will be taken back to the preceding point in the menu tree.

[ENT] & [CLR]

As you hit [↓] or a numeric key, a numeral will appear on the prompt line. But, note that it is not really entered till [ENT] is hit, and you may cancel the numeral by hitting [CLR]. If [ENT] is hit without hitting any alphanumeric key, the existing datum/function do not change, but the prompt line will change to the next item. (You may omit an entry item by hitting [ENT] only.) If any data is presented on the prompt line before you hit keys, you may enter the presented data by hitting [ENT] only. If you want to change the data, clear it by [CLR] and enter a new data.

- (4) When item-choice operation is conducted in the above-mentioned manner, you will arrive at one of the ends (bottoms) of the menu tree where you can enter data.

The following is the example of the "data-entry" screen which shows up after the following item-choice sequence.

```
[MNU]
PLT (Plotter functions)
[3] (Plot interval preset)
[2] (No. 2 interval)
[1] (by time) ..... TIME
```

} These were done in the preceding steps.

Path List

In order to call a "data-entry" screen and enter data there, a series of item-choice operations are required. Description of the item-choice sequence, such as the one shown above, is referred to as PATH LIST (or simply PATH) in this manual. Item choice operation is conducted by hitting arrow keys or [ENT] as mentioned before. However, descriptions of such routine key strokes are omitted in the path list.

# NAVIGATING WITH LP-1000

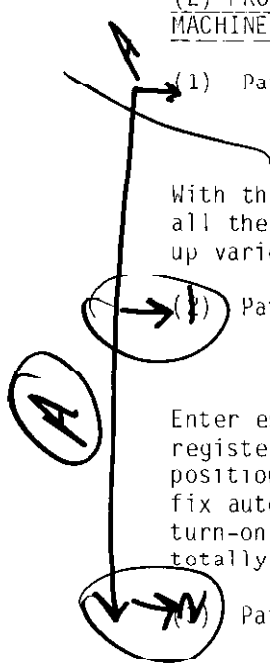
In the preceeding chapter, the basics of the LP-1000 were presented. Now, let's see how it is used in the actual operation.

If you are using the machine for the first time, there are routine works which should be conducted in order. This chapter explains those operations step by step.

## Initial Operation

If this is the first time for your machine to be operated after installation, you must conduct the following five steps in order and wait for 10 minutes. The built-in notch filters will acquire and lock on the interfering signals in this period. As the built-in loran receiver may be tracking the interfering signals, turn off and on the machine. Now interfering signals are eliminated by the notch filters, and the loran receiver can lock on the loran signals without fail.

EVEN IF YOUR MACHINE HAS BEEN INITIALIZED, YOU MUST CONDUCT STEP (2) PROVIDED THAT YOUR BOAT HAS MOVED MORE THAN 60 MILES WITH THE MACHINE TOTALLY TURNED OFF.



(1) Path List: [MNU]  
INIT  
[7] All memories clear

With the ALL MEMORY CLEAR screen presented, turn off the machine. Now all the memory contents have been cleared. Turn on the machine, and set up various parameters newly through the following steps.

(2) Path List: [MNU]  
INIT  
[1] Initial LAT & LON setting .... LAT, LON

Enter estimated ship's position (allowance  $\pm 1^\circ$ ). The position registered here is referred to by the machine at the first-time position fixing after power-on. As this data is replaced by loran-fix automatically, you may neglect this operation from the second-time turn-on. (If your boat has moved more than 60 NM with the machine totally turned off, excluding economy mode, this operation is must.)

(3) Path List: [MNU]  
INIT  
[2] GRI & TD1/TD2 setting  
[1] Auto ..... GRI, TD1, TD2

You need not enter GRI, TD1 nor TD2 if you just select "Auto" mode.

The best master/slave combination for position fixing differs with respect to sea areas. When "Auto" is selected here, the machine will search for the best one for the above-entered LAT/LON coordinates. Once the best combination is found, the machine locks on it until the combination is changed manually or the machine is turned off. So long as "Auto" is selected, this sequence is initiated automatically at every turn-on of the machine.

```

08/24/87      ^ : BACKWARD  ▽ : SELECTION
10:30:21

(* PLOT INTERVAL PRESET *)

NO.1 : 9.50 NM
NO.2 : 11 MIN
NO.3 : 10 NM
NO.4 : 5 MIN
NO.5 : 30 SEC

THE RANGE FROM 5 SEC. TO 60 MIN.
IS AVAILABLE FOR TIME PRESET.
THE DATA LESS THAN 1 MIN. IS A
MULTIPLE OF 5 SECONDS.

- NO.2 SELECTED -
 _ MIN __ SEC ?

WPT   [PLT]  OPT  ALM  CLC  INIT  ASF

```

Fig. 25

Now, you may enter a new plot interval in "NO. 2" position (11 MIN is preset now) by hitting numeric keys and [ENT].

- (5) To return to the plotter (or monitor) screen, hit [PLT] (or [MON]). Or, if you want to continue plot interval preset, return to the pre-presented screen by hitting [↑] (BACKWARD).

#### [PLT] & [MON]

Hit of [PLT] (or [MON]) instantly takes you back to the plotter (or monitor) screen from any point in the menu tree. These keys may be utilized when you want to escape from the menu screen.

As shown on the table on page 59, the larger the SNR value, the better the signal quality. The maximum SNR value is "99." For test, it is important that you have at least one station whose SNR is less than 99 so that you can easily observe any small degradation of SNR as various machines on your boat are turned on one by one.

If at least one station exhibits an SNR lower than 99, you may skip the following step and proceed to step 3. Before doing that however, write down the SNR values for the three stations, preferably in the back of this manual so that you will have a permanent record of SNR values.

Otherwise, go to step 2.

2. In the extremely unlikely situation where all three stations have SNR's of 99, you must manually select a station for lower SNR value.

Call the following screen, and you will find the master and slaves which were selected automatically.

```
Path List: [MNU]
           [INIT]
           [2] GRI & TD1/TD2 setting
```

```
08/24/87      Δ : BACKWARD  ▽ : FORWARD
09:20:31

(*GRI & TD1 & TD2 SETTING*)

GRI : 9940    'AUTO'
TD1 :   27
TD2 :   40

1 : AUTO
2 : MANUAL

CHOOSE : #□ ?

WPT  PLT  OPT  ALM  CLC  [INIT]  ASF
```

} In this example (San Francisco), "27" and "40" secondaries are selected as the optimum slaves.

Fig. 27

Look in appendix A at the back of this book for the chart that describes your geographic area. You will note that any particular area has two slave secondaries associated with it that are the optimum choices. However, most Loran chains have other secondary stations available that do not represent optimum choices, usually because they are far removed from that area, and thus would be rather weak in signal strength. In the case of San Francisco example, the optimum slave secondaries are the "27" and the "43" secondaries. However there is a third secondary station in the chain: the "11" station, and it is located in Washington state, far from the San Francisco area and hence probably rather weak.

- NOTE 1. Sometimes the best combination which the machine finds may not match the one which is known through experience as the best combination. When such a case is encountered or the automatically selected pair gives unsatisfactory results, select the combination manually as instructed on page 54. (You may manually select the combination by entering GRI, TD1 and TD2 through the above-mentioned path, too.)
2. Do not take for granted that the machine switches master/slave combination one after another automatically as the boat moves on the sea. If the machine is kept ON for many days and your boat has sailed a long distance, it would be better to re-select the combination, i.e., turn the machine off and on to trigger "Auto" master/slave-finding function or select the combination manually.

(4) Path List: [MNU]  
 INIT  
 [3] Date & time setting ..... DATE, TIME

Set the on-screen clock to GMT, your local time, etc.

It will take a few minutes for the machine to start position fixing. Do not forget that plotting starts at the second hit of [PLT].

#### NOISE TEST AFTER INITIAL INSTALLATION

The best way to check for the adequacy of an installation, and for the presence of noise aboard the boat which might hamper Loran-C reception, is to measure SNR (Signal to Noise Ratio) on the monitor screen. Make sure all electrical and electronic machinery on your boat is turned off before starting this test. This includes the engine and any auxiliaries as well.

1. Call the second page of the monitor screen by hitting [MON] and [→] in order, and you will see SNR's for the master and slave stations as shown below.

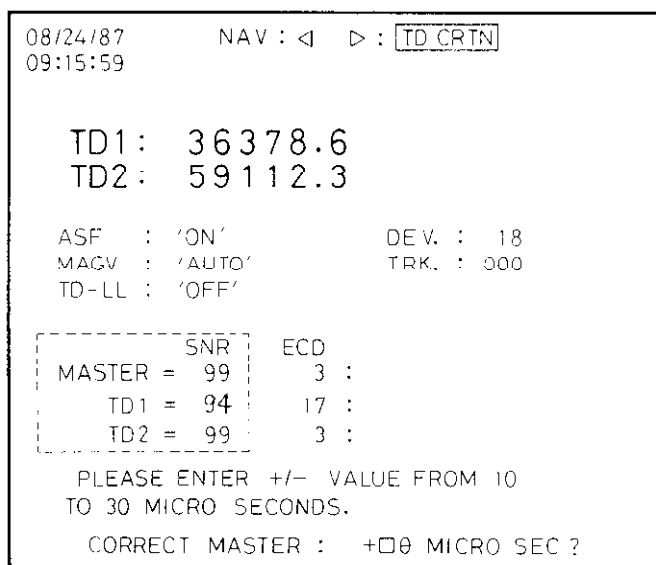


Fig. 26

The negative terminal of the capacitor should go to a mounting bolt used to secure the alternator to its mounting frame. This lead also must be kept shorter than 4 inches or so in order for the capacitor to do its job.

Do Not connect the capacitor to the Field terminal of the alternator, at the risk of destroying the alternator itself.

Hopefully, the electrolytic capacitor will do the job for you, and if that is the case you can proceed to mount it securely to the alternator, perhaps by using "tie-wraps." Make sure the capacitor isn't able to move around under vibration, since the leads could be broken off.

If you have any doubts about what you are doing, it is time to call in a qualified electronics technician, especially if the simple capacitor treatment doesn't do the trick.

Color TV's: One other particularly nasty interference source is the typical home-grade color television, although sometimes a regular black and white TV will wreak havoc on Loran-C reception. Unfortunately, the only solution to this sort of interference is to turn the offending TV off, or else purchase a commercial grade TV receiver which is better shielded than the home-quality units.

#### Displaying/Erasing Coast Line

(1) Insert the ROM card into the memory card driver.

(2) Path List: [MNU]  
OPT (Options)  
[1] Recall chart from media ..... FILE ID

Enter the ID (identification code) of the coast line which you want to call from the ROM card.

(3) Path List: [MNU]  
OPT (Options)  
[8] Chart display ON/OFF ..... ON (default)

Choose "ON," and the coast line will be presented on the screen. (If "OFF" is chosen, the coast line is not presented.)

(4) Path List: [MNU]  
OPT (Options)  
[9] Chart selection ON/OFF ..... AUTO

When the ship moves beyond the chart area, the machine will search the ROM card for the next chart. If a suitable chart is found, it will be loaded onto the machine automatically.

NOTE: For the automatic chart loading, the ROM card must be inserted before the chart area is exhausted. Do not pull out the ROM card during auto-loading.

Go back to the above screen again. You should choose MANUAL mode and change one of the slave stations (TD1 or TD2) to the one which you found in the appendix ("11" in this example).

Call the monitor screen again, and write the SNR values for all three stations down in the back of this manual. Now you can proceed to step 3.

3. Now, turn on the other electronics on the boat (radar, echosounder, etc.) one at a time and observe the SNR readings over a period of several minutes. Make sure you operate the other equipment in all possible modes. For example, make sure that the radar is used in both standby and then transmit modes, with the scanner turning and turned off, etc. Write down the resulting SNR's for each piece of gear, and then shut it off and do the next piece of equipment. If the SNR reading drops from, say, 90 to 85, then you are probably OK, but if it drops from 90 to 60 or lower, you have a definite interference problem that a qualified electronics technician is going to have to fix before you can obtain proper Loran-C performance. Your written record of SNR values will be helpful to him.

If you are quite fortunate you will find that no other piece of electronics on board your boat interferes badly with your new Loran-C. Assuming that your luck is with you and that this is indeed the case, let's go on to test a device that in at least 90 percent of Loran-C installations does cause an interference problem: the alternator.

There are several technical reasons why alternators seem to be antagonistic toward Loran-C receivers, but going into the why's and wherefore's isn't as important as figuring out how to cure the little beast of this nasty habit. Start your engine and increase engine speed until your charging ammeter goes upscale. You will probably now notice that the SNR indication of your Loran-C begins to plummet.

Not all alternators respond to interference-removal techniques in the same manner. Some alternators, it is sad to say, cannot be suppressed at all, and these must be replaced or rebuilt if you wish to have useable Loran-C operation. Don't blame the Loran-C receiver! It is a sensitive instrument, and it is simply responding to the noise broadcast by the alternator.

The first step to take when alternator noise is discovered is to try a large electrolytic capacitor mounted right at the output terminals of the alternator. The capacitor must be rated for the nominal output voltage of the alternator, plus a 50% safety factor. For example, if the alternator is a nominal 32 V.D.C. unit, you should use a capacitor rated for no less than  $32 + 32/2$ , or 48 Volts. A 50 V.D.C. unit should suffice.

This capacitor should be a "computer-grade" unit, that has internal vents in case it should overheat and possibly explode, and the capacity of the electrolytic capacitor should be about 10,000 microfarads or so. Be careful to observe the polarity of the capacitor. Reverse polarity will destroy the capacitor, and could damage the charging system as well. The positive lead of the capacitor is connected with a short lead (less than 4 inches long) to the Output terminal of the alternator, using a large crimp lug to go under the terminal, in parallel with the heavy lead going to the battery bank.

Path List: [MNU]  
ASF  
[4] Smoothing ..... SMOOTHING INDEX  
("0" to "9", "0" = no smoothing)

NOTE: HDG should be still chaotic while SPD gets more stable, e.g. nearly zero. This is because a minute position fluctuation can change HDG by 180 degrees.

You may rest assured that both HDG and SPD readouts will get steady as the boat speeds up. This is because change in position (fixed by Loran) is mainly caused by the ship's actual movement rather than the random error. Thus, the optimum index value should be determined through actual navigation.

The trade-off of the smoothing process is that sudden change of ship's course and speed delay to appear on the screen. So, you will be obliged to make a compromise between smooth indication and quick response. In general, an index of "2" or below will be practical for most people.

(3) ASF (additional secondary fractor) (U.S. and Canadian coasts only)

When Loran-C wave propagates over a land mass, its speed slightly changes and it can cause an error in position fixing. This kind of data have been collected by the U.S. and Canadian Coast Guards, and this machine contains in itself the "correction table." If your boat navigates near the U.S. or Canadian coast, enable the automatic ASF correction through the following path.



Path List: [MNU]  
ASF  
[1] Auto ASF ..... ON

You will now see "ASF" indication on the upper part of the plotter screen. When the boat goes out of the area covered by the "correction table," the indication will blink to inform you that the correction is not applied any more.

#### Erasing ship's course line

Path List: [MNU]  
PLT  
[5] Memory partition type & erase ..... FRASF NO.1  
(COURSE LINE)

Ship's course line is cleared by entering PARTITION #1.

#### Entering/Recalling/Erasing Waypoints

You may enter up to 99 waypoints through the plotter or menu screen:

#### Entry through the plotter screen

(1) Hit [+/ $\rho$ ] to turn on the cursor presentation, (2) move the cursor to your intended position with the arrow keys, and (3) hit [EVT]. The machine will then prompt you to enter an ID (identification code) on the bottom line as shown below.



## Plotting/Erasing Ship's Course Line

### Plotting ship's course line

- (1) Path List: [MNU]  
                  PLT  
                  [3] Plot interval preset ..... DATA #(1 - 5)  
                  |  
                  |--- [1] By time ..... TIME  
                  |   [2] By distance ..... DISTANCE

Up to 5 intervals may be registered by time or by distance through the above path, and you may switch the interval among the five through the plotter screen:

Path List: [PLT]  
          [SFT] ... [SFT] (Light a plot interval indication.)  
          [↕] ... [↕] (Choose an interval among five.)  
          [CLR]            (Return to the normal character presentation.)

If a longer plot interval is used, the ship's course will appear as succession of straight line segments when the chart is expanded. Thus, for precise course plotting, a shorter plotting interval is preferable. The trade-off of a short plot interval is that the course line disappears from its oldest end quickly, resulting in shorter course line presentation on the screen. Refer to page 49.

Generally speaking, 5 minutes' interval should be suitable for open sea navigation, and 5 to 10 seconds' interval may be necessary for precision close-in work.

### (2) Smoothing

The signal strength of Loran-C wave changes every moment, depending on the condition of the propagation path, and this introduces a small error into position fixing operation.

If your boat is moored in the harbor, you may observe this error clearly; keep watch on the ships heading (HDG) and speed (SPD) indications on the monitor screen, and you will find the readouts changing quickly.

NOTE: Under unfavorable receiving condition (ex. on the border of Loran-c coverage, etc.), not only HDG/SPD readouts but also the ship's course plotting appears at random when the chart is expanded.

Be aware that HDG and SPD are calculated from change in ship's position and that the position change in this particular case is purely caused by the fluctuation of Loran-fix since the boat itself is stationary.

A solution for this problem is to add smoothing (averaging) process to the raw position data which were fixed by the built-in Loran receiver. Enter a larger index number through the following path, and examine that the situation is improved.

```

08/24/87      Δ : BACKWARD      ▽ : SELECTION
11:05:47

( * RECALL & ERASE WAYPOINT * )

<1> PIG      ***      ***      ***      ***
      DOG      ***      ***      ***      ***
      CAT      ***      ***      ***      ***
      W01      ***      ***      ***      ***
      W02      ***      ***      ***      ***
      ***      ***      ***      ***      ***
      ***      ***      ***      ***      ***
      ***      ***      ***      ***      ***
      ***      ***      ***      ***      ***
      ***      ***      ***      ***      ***
      ([~] KEY CHANGES PAGE.)
WPT ID : W01
LAT : 25°34.12'N
LCN : 135°23.11'E

WPT ID : W01
ERASE [?] (YES:[ENT], NO:[CLR])

[WPT]  PLT   OPT   ALM   CLC   INIT   ASF

```

← WPT list may be presented over two pages. Hit [4?] for page change.

Fig. 29

Hit [ENT] to erase the waypoint, or hit [CLR] to escape.

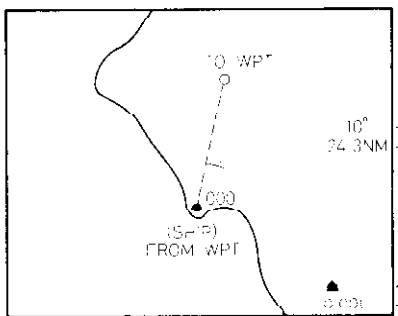
Waypoint Navigation

```

Path List: [MNU]
           WPT
           [1] Select WP for navigation
           [1] Waypoint navigation ..... FROM WPT ID
                                           TO WPT ID

```

Enter "000" as FROM WPT ID (origin), and the present ship's position is registered as FROM WPT. Enter the destination waypoint as TO WPT ID, and you will find a track line running between the two points.



- Bearing of TO WPT or ship's heading direction.
- Distance or time-to-go to TO WPT
- Track line between FROM WPT and TO WPT
- Steering instruction
- Cross track error

Fig. 30

Now, you may navigate to WPT by following the track line. Nav. data necessary to follow the track are available on the screen. Immediately after entering "000" as FROM WPT, the cross-track error is zero. However, as you leave WPT "000" and the ship's course deviates, non-zero value will be indicated along with steering instruction. See the figure below.

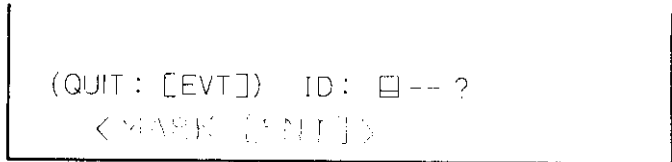


Fig. 28

Enter any 3-digit alphanumeric ID code, and the cursor position will be registered as a waypoint. No event mark appears on the screen in this case. If you want to escape, hit [EVT] again instead of [ENT].

NOTE: If the above-mentioned operations are done with the cursor erased, a waypoint is entered on the ship's present position.

Entry through menu screen

You may register a waypoint in the following four ways:

- (1) Path List: [MNU]  
WPT  
[3] Enter WPT by lat/lon ..... WPT ID  
LAT  
LON

- (2) Path List: [MNU]  
WPT  
[4] Enter WPT by present position ... WPT ID  
[ENT]

Upon hitting [ENT], the ship's present position will be registered as a waypoint.

- (3) Path List: [MNU]  
WPT  
[5] Enter WPT by range/bearing ..... RANGE  
BEARING  
WPT ID

This mode is useful to register as a waypoint a target which you found on the radar screen. Assuming that the target distance (VRM readout) and relative bearing (EBL readout) are 3.4NM and 135° off your starboard respectively, enter "3.4NM" as "RANGE" and "135° plus compass readout" as BEARING.

- (4) Path List: [MNU]  
WPT  
[6] Enter WPT by time differences ... WPT ID  
TD1  
TD2

Calling up the WPT list and erasing WPT

- Path List: [MNU]  
WPT  
[2] Recall & erase waypoint ..... WPT ID

When WPT ID is entered, its latitude and longitude are presented, and the machine will request your confirmation on erasing it as shown on the next page.

(3) Arrival-zone setting & route navigation

You may set a arrival alarm zone on a waypoint:

```
Path List: [MNU]
           ALM (Alarm)
           [1] Arrival or anchor watch alarm
           [1] Arrival alarm ..... LIMIT (range of zone)
                                   ON or OFF (beep)
```

When the ship comes within the zone on any waypoint, the machine recognizes it and automatically switches both the FROM WPT and the TO WPT.

Look at Fig.32. At present, FROM WPT is "000"(own-ship) and TO WPT is "WP1". But, they will change as shown below as the ship moves on the route. You may visually confirm this transition on the monitor screen as shown in Fig. 34.

Ship's position	FROM WPT	TO WPT
000 - WP1	000	WP1
WP1 - WP2	WP1	WP2
WP2 - WP3	WP2	WP3
WP3 - WP4	WP3	WP4

Note that the nav. data indicated in the following figures are calculated based on FROM WPT and TO WPT which are switched automatically.

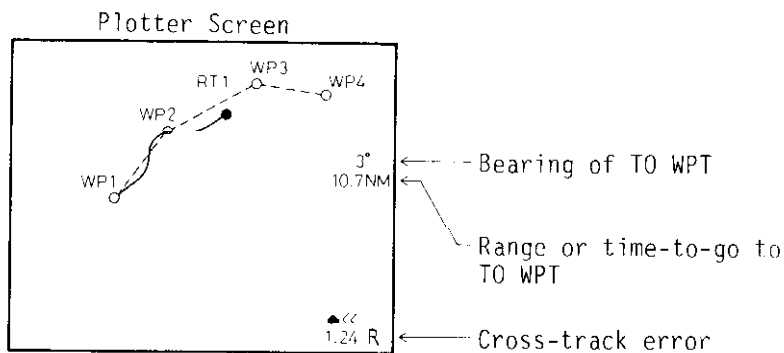


Fig. 33

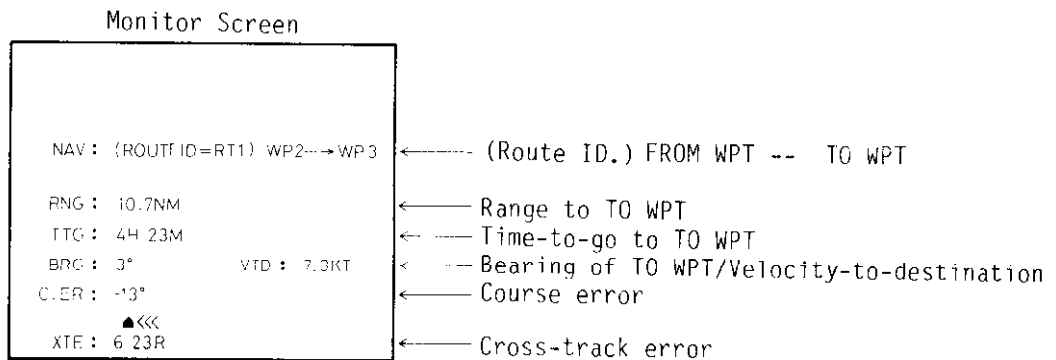


Fig. 34

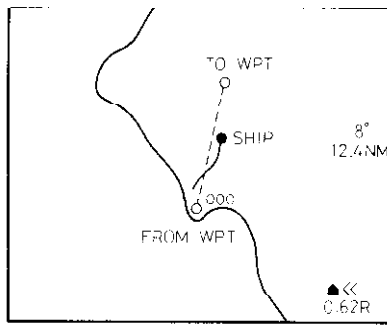


Fig. 31

If you wish, you may enter a waypoint other than "000" as FROM WPT.

---

Route Navigation

---

(1) Making a route plan

Path List: [MNU]  
 WPT  
 [7] Recall & specify route ..... ROUTE ID  
 WPT ID'S

Enter any 3-digit alphanumeric route ID first and then waypoint ID's (max. 10 points) which exist on the route.

(You may register up to 10 routes beforehand, and may choose one of them as mentioned below.)

(2) Calling a route on the plotter screen

Path List: [MNU]  
 WPT  
 [1] Select WP for navigation  
 [2] Route navigation ..... ROUTE ID

Enter the ROUTE ID which you want to see, and the route will be presented on the plotter screen as shown below.

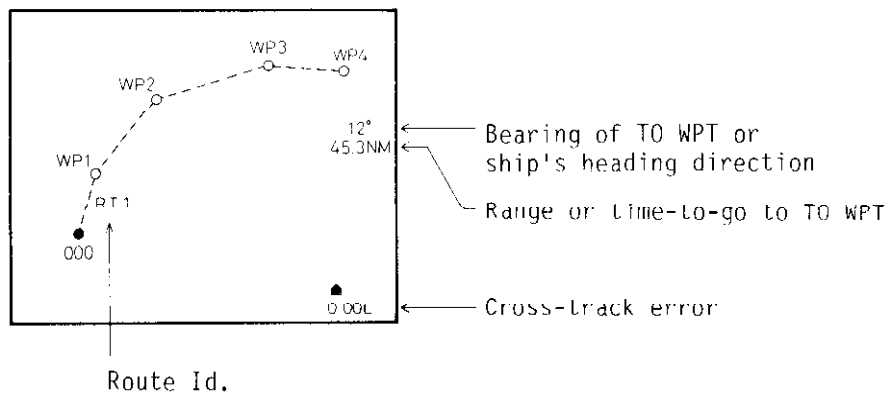


Fig. 32

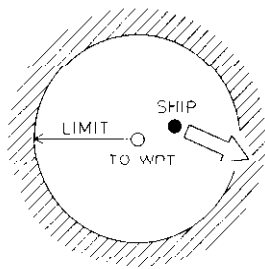


Fig. 36

This is the reverse of the above-mentioned arrival alarm; the alarm is triggered when the ship goes out of the preset zone. If you want to register the position of the ship's anchor as the TO WPT, (i) register the ship's position as a waypoint through the following path, and (ii) register this waypoint as TO WPT.

```
Path List: [MNU]
           WPT
           [4] Enter WPT by present position ..... WPT ID
           [ENT]
```

```
(3) Path List: [MNU]
           ALM
           [2] Cross-track error alarm .. LIMIT
                                     ON or OFF (beep)
```

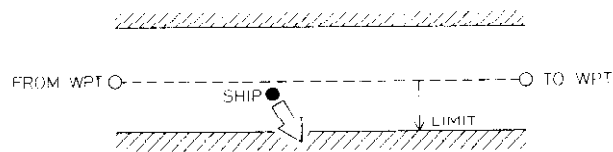


Fig. 37

Set your intended lateral lane width by entering LIMIT, and the alarm will be triggered when the ship deviates from the lane. Refer to page 24.

```
(4) Path List: [MNU]
           ALM
           [3] Border alarm ..... LIMIT
                                     ON or OFF (beep)
```

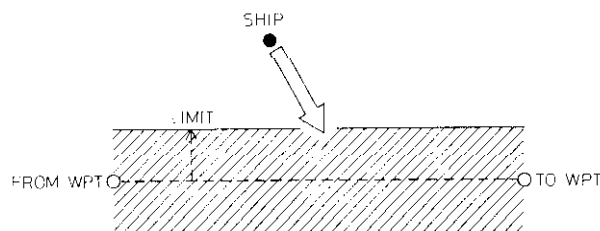


Fig. 38

(4) Erasing a route

```
Path List: [MNU]
           WPT
           [8] Erase route ..... ROUTE ID
```

Enter the route ID, which you want to delete from registration.

---

Erasing Track-line/Waypoint Marks

---

```
Path List: [MNU]
           WPT
           [1] Select WP for navigation
           [3] Turn off navigation
```

In daily short-range navigation, you will not use any waypoint. In such a case you may erase them from the screen through the above path.

---

Using Alarm Function

---

There are five conditions that can trigger the alarm. The visual alarm is presented on the second line of any screen and a unique beep sound (Morse-coded) is released if the buzzer is turned on in the following paths. To silence the beep, hit [CLR]. (The audible alarm is breached even under economy condition.)

```
(1) Path List: [MNU]
              ALM
              [1] Arrival or anchor watch alarm
              [1] Arrival alarm ..... LIMIT
                   ON or OFF (beep)
```

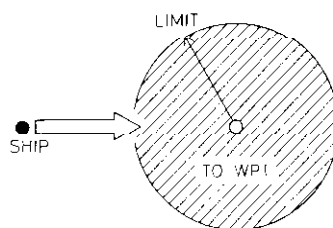


Fig. 3b

Set a circular arrival zone by entering LIMIT, and the alarm will be emitted when the ship approaches within LIMIT from TO WPT.

```
(2) Path List: [MNU]
              ALM
              [1] Arrival or anchor watch alarm
              [2] Anchor watch alarm ..... LIMIT
                   ON or OFF (beep)
```

## MORE ABOUT LP-1000

---

### Storing/Recalling Ship's Course Line

---

As mentioned on page 40, the oldest end of the ship's course line disappears as the ship moves on the sea, and as a result only a limited length of course line can remain on the plotter screen. This is because a course line consists of a number of points and the memory capacity to store those locations is limited (1,800 points). If the plotting interval is 5 minutes for example, 150 hours' (= 5min x 1800 pts/60min) course line can be presented.

If you do not need such a long course line, you may split the memory into several partitions and plot a course line on one of them (PARTITION #1). The trade-off for shorter course presentation is that the other partitions (PARTITION #2-up) are available as back-up pages; you may copy PARTITION #1 (present course line) there, and superimpose it on the screen in future. This feature is useful to follow the past course line, etc.

#### (1) Configuring memory partitions

Path list: [MNU]  
          PLT  
          [5] Memory partition type & erase ----- PARTITION TYPE

The following four configurations are available, and you may choose one of them through the above path.

300\*6: 300 points' course line on each of 6 partitions  
600\*3: 600 points' course line on each of 3 partitions (default)  
900\*2: 900 points' course line on each of 2 partitions  
1800\*1: 1800 points' course plotting on a single partition

#### (2) Storing present course line

Path list: [MNU]  
          PLT  
          [1] Store track & marks into partition ----- PARTITION#

Enter the partition number on which you want to copy PARTITION #1.

Note: Event marks are stored along with the course line.

#### (3) Superimposition

Path list: [MNU]  
          PLT  
          [2] Recall track & marks from partition --- PARTITION#

Enter the partition number which you want to call on the screen.

#### (4) Ceasing superimposition mode

Path list: [MNU]  
          PLT  
          [2] Recall track & marks from partition -- PARTITION #1



This is the reverse of the above-mentioned cross-track error alarm.

First, draw the border line by assigning appropriate waypoints as FROM WPT and TO WPT, and set your intended buffer lane width by entering LIMIT. The alarm will be triggered when the ship breaches the buffer lane.

- (5) Path List: [MNU]  
ALM  
[4] Wake-up alarm ..... TIME  
ON or OFF (beep)

This is an on-screen alarm clock.

#### Interpreting visual alarms

When the above-mentioned alarms are triggered, the corresponding visual alarm appears blinking on the second line. The visual alarm can not be turned off by [CLR] unlike the audible alarm. It will keep blinking until its cause is removed.



Fig. 39

### Reloading waypoints

Path list: [MNU]  
OPT  
[4] Recall WPT data from media ----- FILE ID

The waypoints specified by the FILE ID are reloaded.

CAUTION 1. The existing waypoints in the machine will be replaced with the reloaded ones. If necessary, save them beforehand.

2. If new waypoints are loaded during the WAYPOINT or ROUTE navigation, the mode will automatically change to "NAVIGATION OFF" state because the waypoints in use are all discarded.

### (4) Erasing file in RAM card

Path list: [MNU]  
OPT  
[6] Erase data on media ----- FILE ID

---

### Corrections

#### (1) Automatic ASF (U.S. coasts only)

You will remember that in the Elementary Theory Section that we said that this machine has a built-in capability of using TD offsets to compensate for warpage of the TD grid occurring due to ASF (Additional Secondary Factors) caused by propagation of the Loran signals over part-land, part-sea paths. This automatic ASF compensation will yield better accuracy of the calculated Latitude/Longitude than will the raw calculation using uncompensated TD numbers.

When this machine is first used after the memory has been cleared, the default setting for automatic ASF compensation is "off." For most operations using latitude/longitude it is desirable to have the automatic compensation engaged all the time. Only when TD numbers (perhaps from a fishing buddy or your own old records from another Loran-C receiver) are used, will it be necessary to disable automatic ASF compensation.

This machine contains a built-in table of ASF compensation values for geographic areas where these warpages have been measured by the U.S. and Canadian Coast Guards, but other areas of the world have not been measured as of this time. If your boat operates near the U.S., activate the automatic ASF compensation through the following path:

Path list: [MNU]  
ASF  
[1] Auto ASF --- ON

When auto ASF is turned on, you will see "ASF" indication on the second line of any screen.



1866/1800" or "Bessel 1841." The position calculated by this machine may not be the same as the expected position on these older types of charts.

For example, reprinted below is a comment found on an older U.S. DMA chart. On this chart it is necessary to add corrections of 11.49 seconds South ( $11.49/60 = 0.19$  minutes South) and 10.33 seconds East ( $10.33/60 = 0.17$  minutes East. Remember that this machine uses tenths of minutes rather than seconds.)

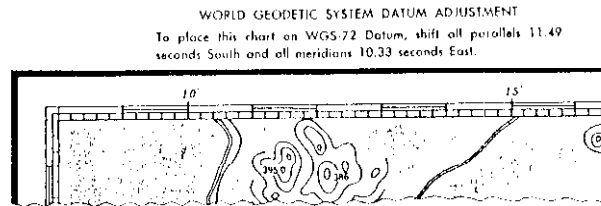


Fig. 40

### TD corrections

Normally, you will be using the machine with automatic ASF corrections so that the L/L readout will be as accurate as possible. You may however enter your own TD correction factors if you want to do so, or if your particular geographic area doesn't have ASF compensation values available for it.

```
Path list: [MNU]
           ASF
           [2] Manual TD/LL corrections ----- PAGE
                                           GRI
                                           TD1
                                           TD2
                                           CORRECTION TO TD1
                                           CORRECTION TO TD2
                                           CORRECTION TO LAT
                                           CORRECTION TO LON
```

To register correction values, (1) choose one of 10 PAGES, on which you want to write the data, (2) specify the loran chain (GRI, TD1 & TD2) and enter the correction values in time differences (CORRECTIONS TO TD1/TD2) or in latitude/longitude (CORRECTIONS TO LAT/LON).

NOTE: You may make only one PAGE for each GRI.

### (3) Magnetic variation

The location of the magnetic north pole is a little deviated from the geographical one. This makes a difference between the true and magnetic north direction. This difference varies with respect to the observation point on the earth. You will find such an information on your sea chart. This machine also keeps such data. If "Auto" is chosen in the following path, the variation which is assigned to the ship's existing area is automatically referred to, and various bearing indications are presented as magnetic bearings. On the other hand, if "Manual" mode is chosen, you must enter the magnetic variation in accordance with the sea area where your boat stays.

(2) Giving offset of TD/LL manually

This machine is capable of storing L/L correction and/or TD corrections internally for compensation of the L/L readout so that it more closely matches the actual position of the vessel as shown on a navigation chart. This manual compensation facility is in addition to the automatic ASF compensation function. You must thus be careful that you don't inadvertently call up both functions (ASF and manual corrections) simultaneously, because then you will be in effect making a double compensation you probably didn't intend to invoke.

This machine has ten "pages" into which correction information either by L/L and/or by TD may be entered. These pages are identified by the exact GRI and slave TD's that are entered into each page, and are invoked by the computer only once, after power has been turned on and Loran signals have been first acquired. For example, if you specify a set of correction values in page 01 using a GRI of 4990 (Central Pacific chain), with slaves of 11 and 29, then this page will be invoked only when the first two digits of the slave TD's after acquisition are equal to 11 and 29, and when the GRI in use is 4990. This is true for both Automatic or Manual selection of GRI/S1/S2.

This manual position offset correction facility should be specified only for areas where automatic ASF corrections are not available. At present this machine has correction values built in for the entire U.S. and Canadian coasts, but since correction values are presently not available anywhere else in the world, the ASF corrections outside these areas are absent.

L/L correction

Variations in signal propagation velocity can cause constant errors in the computed Lat/Long position. In geographic areas where automatic ASF corrections aren't available you may want to enter manual L/L corrections.

In other cases, you may want to further refine the absolute accuracy of L/L coordinates to match a particular chart, where the chart has been drawn using a different datum reference than the WGS-72 datum used by this machine.

In either of these cases, you must first determine the amount (CORRECTION TO LAT and CORRECTION TO LON) by which you need to shift the L/L readings. This is done by comparing the displayed L/L with the actual L/L that you want the unit to read, or by using the correction data printed on the chart itself.

In the first case where you are presently located at a position whose L/L coordinates are accurately known, you may compute the difference in L/L between what the machine is showing and what you know to be the actual coordinates. Then you would enter the differential values as manual L/L corrections.

The second case is where you want to match up your L/L coordinates with that of a chart printed using a different datum reference. This machine calculates Latitude/Longitude coordinates according to the "WGS-72" (World Geodetic System 1972) datum model. Many older charts are drawn using other datum models, for example, "Clarke

Y slave, which would otherwise be chosen to cross with the X TD's. The W signal thus might be weaker and thus less reliable than the Y signal, even with the less desirable gradient characteristics of the Y station. However, stations sometimes will go off the air for scheduled maintenance or because of a problem. At these times it may be necessary to choose manually another slave station in spite of the fact that it may show less than optimum geometry or signal strength in your area.

Angle of crossing

In an ideal Loran-C world all TD's would cross at an angle of 90 degrees. Unfortunately, we don't live in such a world, so we must consider the angle of crossing that actual TD's create. The closer the angle of crossing is to a right angle, the better the accuracy of positioning will be. Close examination of Fig. 8 shows that the X and the Y TD's cross at a better angle than do the X and the W TD's or the W and Y TD pair, and thus are a better choice to use. Note that the differences in angles of crossing of the X-Y, X-W, and Y-W pairs is really not dramatic. Sufficiently accurate navigational accuracy for most purposes actually could be obtained by use of any of these pairs of TD's. It is merely better to use the more optimum X-Y pair. It is a general rule of thumb that you should be very wary of using TD pairs that cross at an angle less than 30 degrees.

This machine will automatically select the preferred GRI as well as the preferred slaves for the desired position without user intervention if the Automatic function is in use; however, you may choose to use another GRI and/or slaves in your area if available. This is done through the following path.

```

Path list: [MNU]
           INIT
           [2] GRI & TD1/TD2 setting
           [2] Manual ----- GRI
                                   TD1
                                   TD2

```

---

Using On-screen Calculator

---

(1) Point-to-point range/bearing

Specify two points by L/L's or by waypoint ID's, and the range/bearing between the two locations will be presented on the screen.

```

Path list: [MNU]
           CLC
           [1] Calc. from LAT/LON to LAT/LON ----- FROM LAT/LON
                                                         TO   LAT/LON

```

```

Path list: [MNU]
           CLC
           [2] Calc. from WP to WP ----- FROM WPT ID
                                                         TO   WPT ID

```

(2) L/L to TD conversion

Path list: [MNU]  
ASF  
[3] Magnetic variation  
    [1] Auto  
    [2] Manual ----- MAGNETIC VARIATION

When the auto mode is selected or non-zero MAGNETIC VARIATION is entered in the manual mode, you will see "MAGV" indication on the second line. ("MAGV" blinks when the ship goes outside of the coverage of the built-in correction table.)

For the TRUE BEARING INDICATIONS (relative to the geographical north) choose "Manual" mode and enter zero value as MAGNETIC VARIATION.

---

### Selecting GRI/Slaves Manually

---

So far you have been using your machine on one Loran-C chain, and have been using the pair of slave stations selected automatically for you by the machine. In many geographic areas however there may be more than one pair of slave stations available.

The most important factors to consider when selecting slaves manually are: (1) TD Gradients, (2) Angle of Crossing, (3) Baseline Extension, and (4) Signal Strength. The operator should choose the best combination of TD's, taking into account all of these factors to obtain the best accuracy when operating the machine manually. The values for GRI and the slave station selection chosen automatically by the machine are derived from considerations of station geometry and signal strength for each geographic area. We are going to have to look again briefly at some basic Loran-C theory to give you some insight into how these considerations were derived.

#### TD gradients

Take a look again at Fig.8 on page 13, where a section of chart was given showing an area off Yokohama, Japan. We determined that for the island of Mikura Jima there were three LOP's (TD's) that all crossed at its Southwestern corner, the 9970-X-36800, 9970-Y-60600 and 9970-W-17750 microsecond lines.

The spacing between adjacent TD's for the 9970-X TD's is 200 microseconds. The spacing between adjacent TD's for the 9970-Y TD's is also 200 microseconds. The spacing between adjacent TD's for the 9970-W TD's however is only 100 microseconds. What this means is that for any given change in position, the X and Y TD's change more than does the W TD. This phenomenon is known as "gradient," and denotes the amount of change of position for a given change of Time Difference.

Conversely, for any change in TD's for the X and Y TD's there would be a greater change in position than for the W TD's. Obviously, the smaller the position shift for a given change in TD's, the better the accuracy we can expect in determining our exact position.

There is however a fly in the ointment. While the W slave station would be a better choice (on the basis of gradient alone) in the area we are considering near Yokohama, the station is located farther away than the

---

### Setting Notch Filters Manually (eliminating interference)

---

Loran-C receivers are vulnerable to interference in the region of 60 KHz to 140 KHz coming from sources such as Decca chain transmitters or military low frequency communication transmitters. This machine contains six notch filters to notch out and eliminate such interfering local signals.

Normally, these filters are used automatically, since they will seek out and notch offending signals very accurately all by themselves. These may be very rare occasions when you may wish to notch out an interfering signal manually. To do this, you must know the frequency of the interference. For example, there is a very strong military transmitter operating on the frequency of 88 KHz in the mid-Atlantic region of the U.S. This transmitter can cause problems when a vessel comes close to its location near Annapolis, Maryland. In this case it may be necessary to put two notch filters on the same frequency of 88 KHz in order to knock down the level of this transmitter sufficiently for the receiver to operate properly.

```
Path list: [MNU]
           ASF
           [5] Notch filters ----- FILTER#
           [2] Manual ----- FREQUENCY
```

Specify FILTER# and enter FREQUENCY ("88" in this example).

Usually use the AUTO mode because this mode eliminates interferences more efficiently.

---

### Selecting Communication Data Format

---

This operation is required only when an external device is newly connected or changed.

```
Path list: [MNU]
           INIT
           [4] Interface port setting ----- PORT#
                                           DATA FORMAT
```

This machine is provided with two ports (connectors on the rear panel) for connections to external devices:

Port #1: "EXT. NAV" (Input-Only-Port)

When this machine is operated as a display device without using the built-in loran receiver, an external position-fixing equipment is connected here. The data format acceptable is FURUNO CIF or NMEA 0183 for either loran-C, NNSS(satnav), Decca or GPS.

Port #2: "OUTPUT" (Input-And-Output Port)

Usually an autopilot or color video sounder is connected to this port. The data format is FURUNO CIF, NMEA 0183 or NMEA 0180 (cross-track error output).



Enter any L/L, and it will be converted into a pair of TD's on the screen.

Path list: [MNU]  
          CLC  
          [3] Calc. from LAT/LON to TD's ----- LAT & LON

NOTE: TD's are computed based on the GRI in use.

---

#### Turning on-off LAT/LON Grid Presentation

---

Path list: [MNU]  
          PLT  
          [8] Display LAT/LON line ----- ON or OFF

---

#### Changing Chart Scale Indication Mode (1/[ ]/[ ]/[ ] --- [ ]/[ ]/[ ] NM)

---

In the default condition the chart scale (1/2,000 - 1/5,000,000) is presented on the top of the plotter screen. If you wish, you may display there the mileage (0.14NM - 385NM) measured across the screen horizontally.

Path list: [MNU]  
          PLT  
          [7] Change scale mode

NOTE: Both the scale and mileage indications are for reference only. They are not intended for strict use.

---

#### Changing Chart Scale at Arrival Automatically

---

When your boat nears a TD WPT, it may be helpful to observe ship's movement on the expanded chart screen. If you preset the desired chart scale and turn the function on through the following path, the machine will do it for you when the ship goes into the arrival zone. (For arrival zone setting, see page 46.)

Path list: [MNU]  
          PLT  
          [6] Scale at arrival

One minute after your boat has exited the zone, the machine recognizes this and return the scale to the previous one.

---

#### Calling up Help Screen (key usage)

---

Path list: [MNU]  
          INIT  
          [8] Help

Key usage is presented.

## "SIG. ERR"(Signal Error) Indfcation and Loran Signal Status

If "SIG. ERR" is presented on the second line of any screen, it means that the loran signal is received with unfavorable condition and the loran fix may not be correct. To see the details of the loran signal status, call up the 2nd page of the monitor screen.

08/24/87 09:15:59	NAV : ◀ ▶ : TD CRTN SIG ERR	
TD1: 36378.6 TD2: 59112.3		
ASF : 'ON'	DEV : 18	} DEV: Deviation } TRK: Tracking points
MAGV : 'AUTO'	TRK : 010	
TD-LL : 'OFF'		
	SNR ECD	} SNR: Signal to noise ratio } ECD: Envelope to Cycle Difference } CYC: Cycle
MASTER = 99	3 :	
ID1 = 99	17 : CYC	
ID2 = 99	3 :	
PLEASE ENTER +/- VALUE FROM 10 TO 30 MICRO SECONDS.		
CORRECT MASTER : 100 MICRO SEC ?		Prompt line

Fig. 43

DEV: The amount that the internal reference oscillator in this machine has drifted from its preset value is called the Deviation. This machine compares the frequency of its own internal oscillator with that transmitted by the Loran-C stations, all of which have extremely precise master oscillators.

The nominal value for DEV is 000, set at the factory. If the oscillator drifts too far, signal acquisition time may increase and tracking accuracy may be affected. If this should occur the unit must be serviced.

The following table lists the numerical values for DEV.

DEV READING	DESCRIPTION	"SIG. ERR"
-99 to 99	Normal acquisition/ tracking attainable	OFF
Less than -99 or more than +99	It may not acquire signals, or even once acquired, might lose tracking easily.	ON

TRK: All modern receivers track on the fourth cycle of the pulse. The signal amplitude at this point is not terribly high, so in weak areas, the receiver might become confused and lock onto the fifth rather than the fourth cycle, since the fifth cycle is stronger. If this occurs on the Master signal alone, the slave signals will be 10 microseconds lower, and the position data (TD's) obtained will be in error; by as much as 3 n.m.

In accordance with the type of the external device, select a data format for each port. If an external position fixing equipment is used, do not forget to choose it on the plotter screen. See page 28.

Note: If the device type indication blinks at the top-right corner of the plotter screen, it means that nav. data is not being fed to Port #1.

---

### Conducting Self-test

---

```
Path list: [MNU]
           INIT
           [6] Self test
```

When the above operation is conducted, the machine will request your confirmation as shown below.

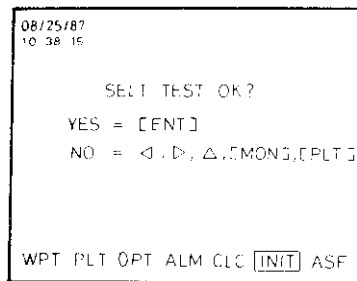


Fig. 41

Hit [ENT] for self-test, or hit [←], [→], [↑], [MON] or [PLT] to escape. When [ENT] is hit, the self-test screen will appear as shown below.

The machine checks itself, and the check results are presented as shown below.

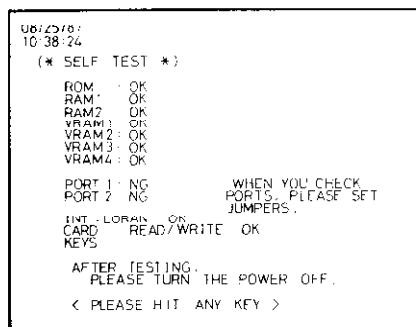


Fig. 42

- Memories
- Input/output ports for ext. equipment  
For service technician only. "NG"(No Good) will be displayed unless jumpers are connected.
- Built-in Ioran receiver
- Memory card driver
- Keys  
(Hit keys one by one while "PLEASE HIT ANY KEY" is displayed, and check if proper key symbol is presented.)

After testing, turn the power off. (You have no choice to escape from the self-test but to turn the power off.)

\*\*\*\*\*  
 \* MENU LIST OF LP-1000 \*  
 \*\*\*\*\*

[MENU] ("START" is here!)

DATA to be entered

[WPT (Waypoint)]

- [1] Select WP for navigation
  - [1] Waypoint navigation ..... FROM WPT ID  
TO WPT ID
  - [2] Route navigation ..... ROUTE ID
  - [3] Turn off navigation
- [2] Recall & erase waypoint ..... WPT ID
- [3] Enter WPT by lat/lon ..... WPT ID  
LAT  
LON
- [4] Enter WPT by present position ..... WPT ID
- [5] Enter WPT by range/bearing ..... RANGE  
BEARING  
WPT ID
- [6] Enter WPT by ID's ..... WPT ID  
TD1  
TD2
- [7] Recall & specify route ..... ROUTE ID  
WPT ID's
- [8] Erase route ..... ROUTE ID

[PLT (Plotter functions)]

- [1] Store track & marks into partition ... PARTITION#
- [2] Recall track & marks from partition .. PARTITION#
- [3] Plot interval preset ..... DATA#
  - [1] By time ..... TIME
  - [2] By distance ..... DISTANCE
- [4] Mark for events (comments only)

This machine employs sophisticated mathematic algorithms to reduce the possibility of a 10 microsecond error caused by weak signals, but if the shape of the Loran-C pulse is distorted by passage over land, or by reflection from other vessels, or even from masts or conductors on your own vessel, cycle locking problems could occur.

The three-digit figures from left to right indicate the tracking points for the Master, Slave 1 and Slave 2 signals, respectively; "0" indicates that the receiver thinks it is tracking on the correct cycle and "1" indicates that the receiver suspects that it is tracking on the wrong cycle. For example, in Fig. 43, the slave 1 signal is shown as tracking on the wrong cycle.

#### Entry of correction data

If "1" is indicated in any digit of TRK and you can estimate how many cycles the tracking point is deviating, enter correction value on the prompt line (bottom line). You may enter the correction value for each MASTER, TD1 and TD2, at 10 microsecond step. (10 microseconds corresponds to one cycle deviation of the tracking point.)

SNR: SNR means "Signal to Noise Ratio" and is a relative measure of the quality of the signal in the presence of noise, either generated locally on the boat or generated in the ionosphere.

The table below lists the numerical values for SNR, and shows what the various values mean.

SNR READING	DESCRIPTION	"SIG. ERR"
00 to 09	Too weak to track (signal lost)	ON
10 to 99	Auto-aquisition/tracking OK	OFF

ECD: The definition of "ECD" is "Envelope to Cycle Difference." This (CYC) refers to the distortion of an actual pulse received off the air as compared to the theoretical shape.

ECD READING	DESCRIPTION	"CYC"	"SIG. ERR"
-17	Tracking on earlier cycle	ON	ON
-16 to -11	Signal distorted, might be tracking on earlier cycle.		
-10 to 10	Tracking on correct cycle.	OFF	OFF
11 to 16	Signal distorted, might be tracking on later cycle.		
17	Tracking on later cycle.	ON	ON
--	Signal too weak to measure ECD.	OFF	ON

CLC (on-screen Calculator)

- [1] Calc. from LAT/LON to LAT/LON ..... FROM LAT  
(Point-to-point range/bearing) FROM LON  
TO LAT  
TO LON
- [2] Calc. from WP to WP ..... FROM WPT ID  
(Point-to-point range/bearing) TO WPT ID
- [3] Calc. from LAT/LON to TD's ..... LAT  
LON

INIT (Initial operation)

- [1] Initial LAT & LON setting ..... LAT  
LON
- [2] GRI & TD1/TD2 setting
  - [1] Auto ..... GRI  
TD1  
TD2
  - [2] Manual ..... GRI  
TD1  
TD2
- [3] Date & time setting ..... DATE  
TIME
- [4] Interface port setting ..... PORT#  
DATA FORMAT
- [5] Special setting (Reserved for future)
- [6] Self-test
- [7] All memories clear
- [8] Help (Key usage)

ASF (Additional Secondary Factor)

- [1] Auto. ASF (TD correction) ..... ON or OFF
- [2] Manual TD/LL corrections ..... PAGE  
GRI  
TD1  
TD2  
CORRECTION TO TD1  
CORRECTION TO TD2  
CORRECTION TO LAT  
CORRECTION TO LON

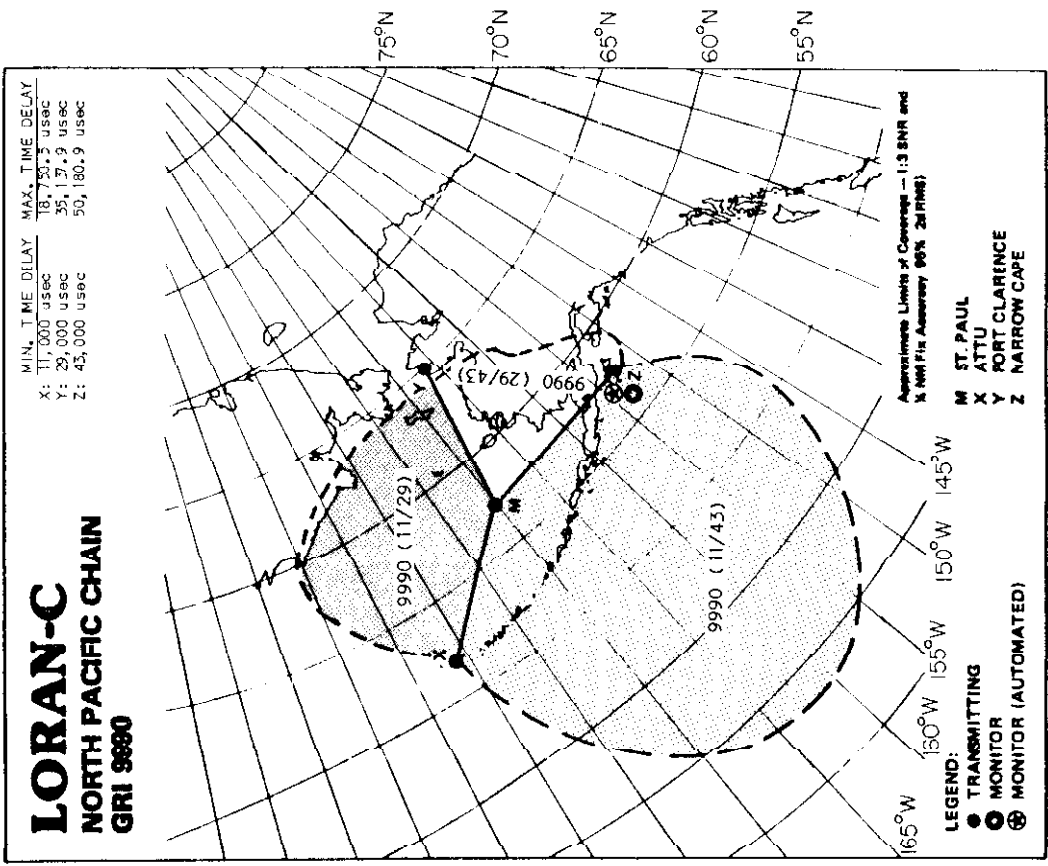
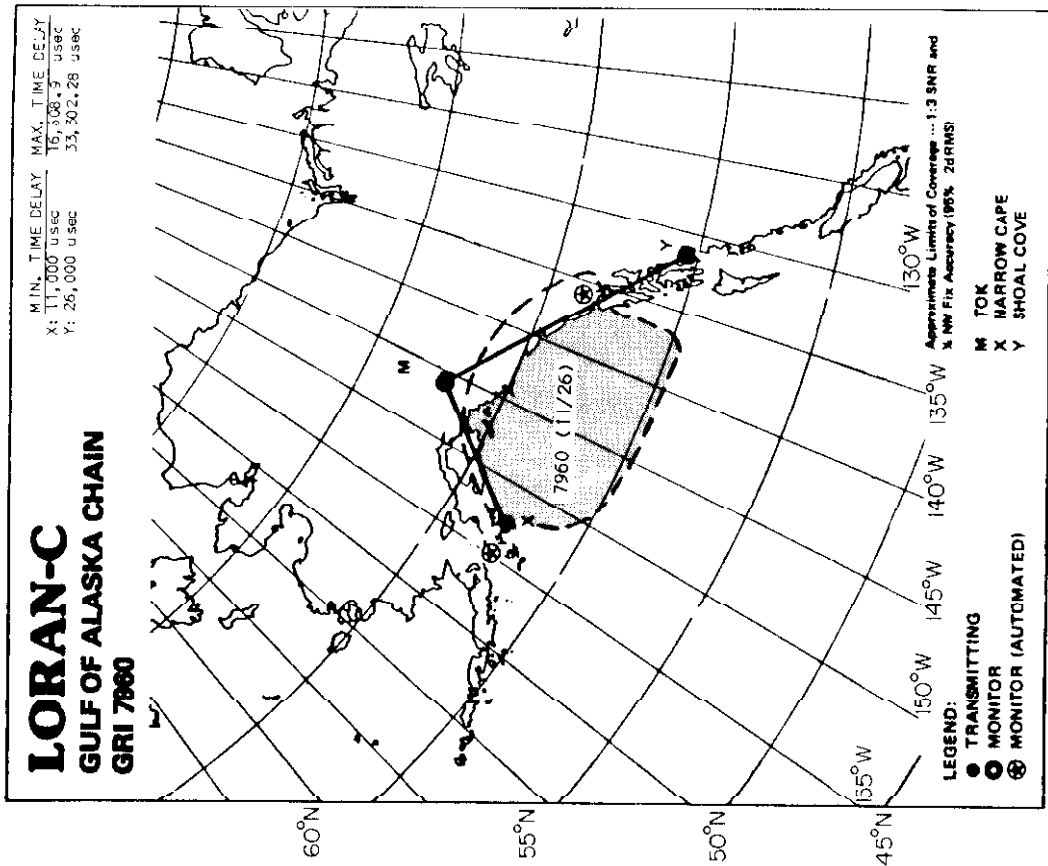
- [5] Memory partition type & erase ..... PARTITION TYPE  
ERASE NO.1 (COURSE LINE)  
ERASE NO.1 (EVENT MARKS)
- [6] Scale at arrival ..... SCALE  
ON or OFF
- [7] Change scale mode ..... BY SCALE or  
BY RANGE
- [8] Display LA1/LUN line ..... ON or OFF

**OPT (Options = memory card)**

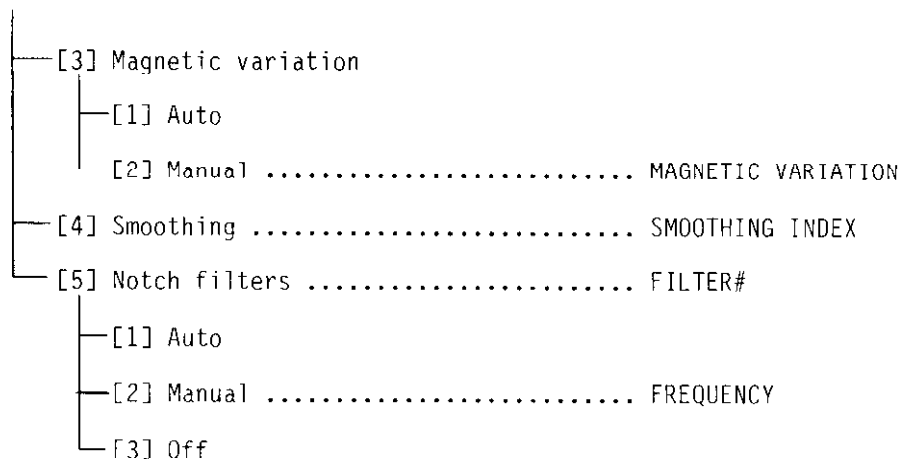
- [1] Recall chart from media ..... FILE ID
- [2] Recall data from media ..... FILE ID  
PARTITION#
- [3] Store data into media ..... PARTITION#  
FILE ID  
MEMO
- [4] Recall WPT data from media ..... FILE ID
- [5] Store WPT data into media ..... FILE ID  
MEMO
- [6] Erase data on media ..... FILE ID
- [7] Initialize media
- [8] Chart display ON/OFF ..... ON or OFF
- [9] Chart selection ON/OFF ..... AUTO or MANUAL

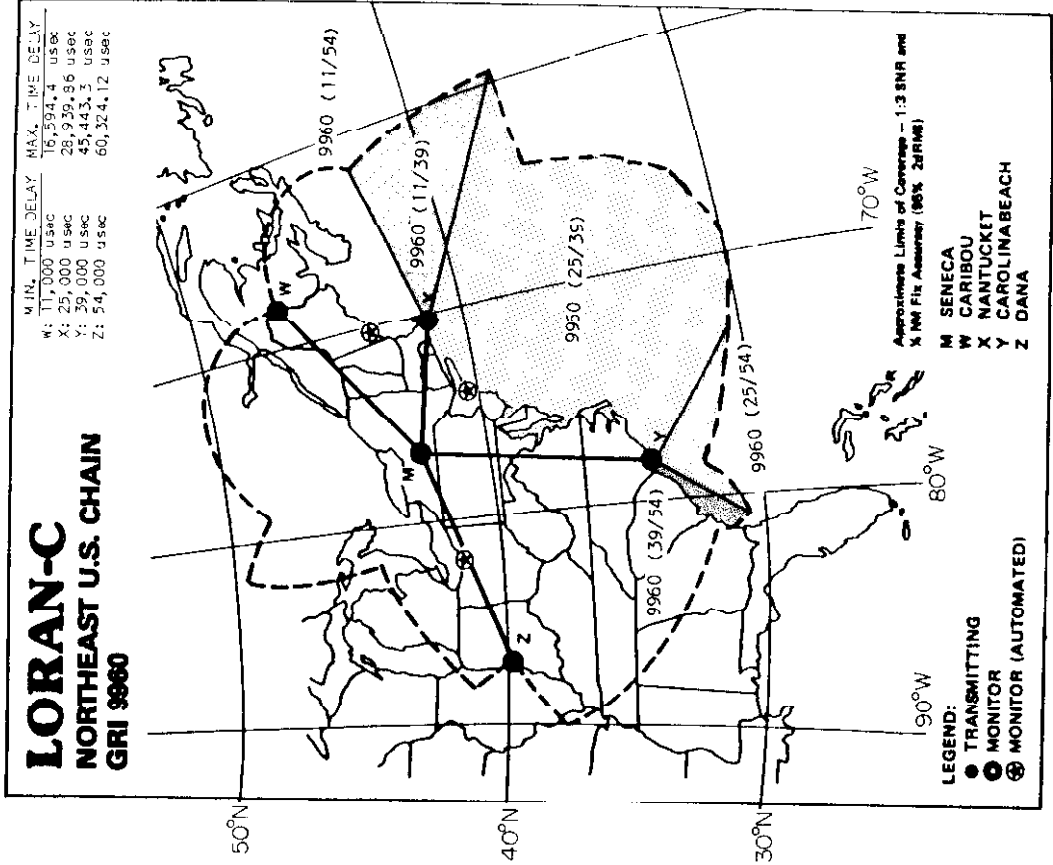
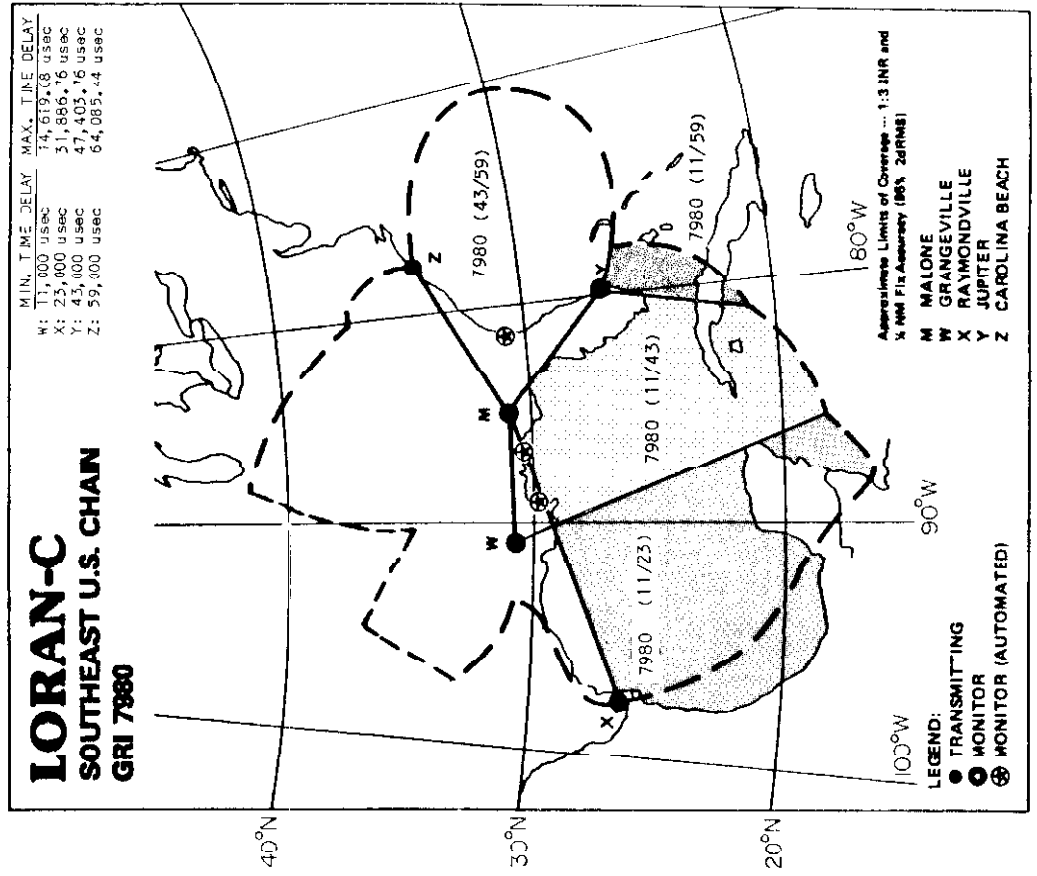
**ALM (Alarm)**

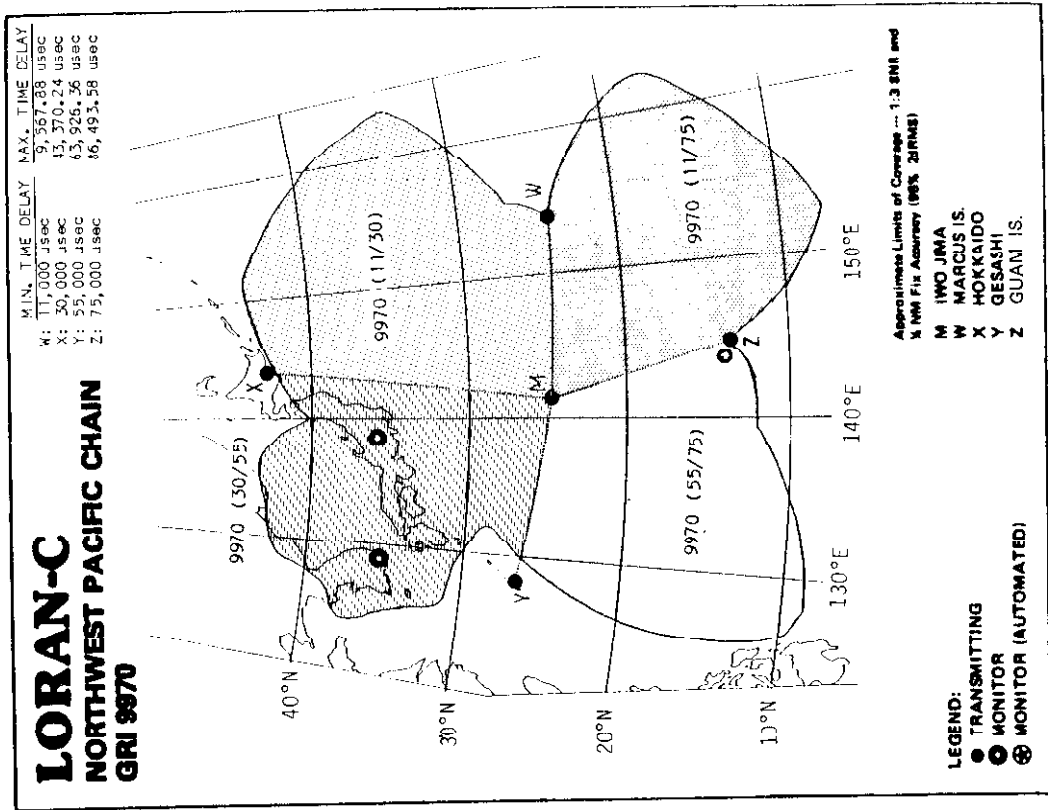
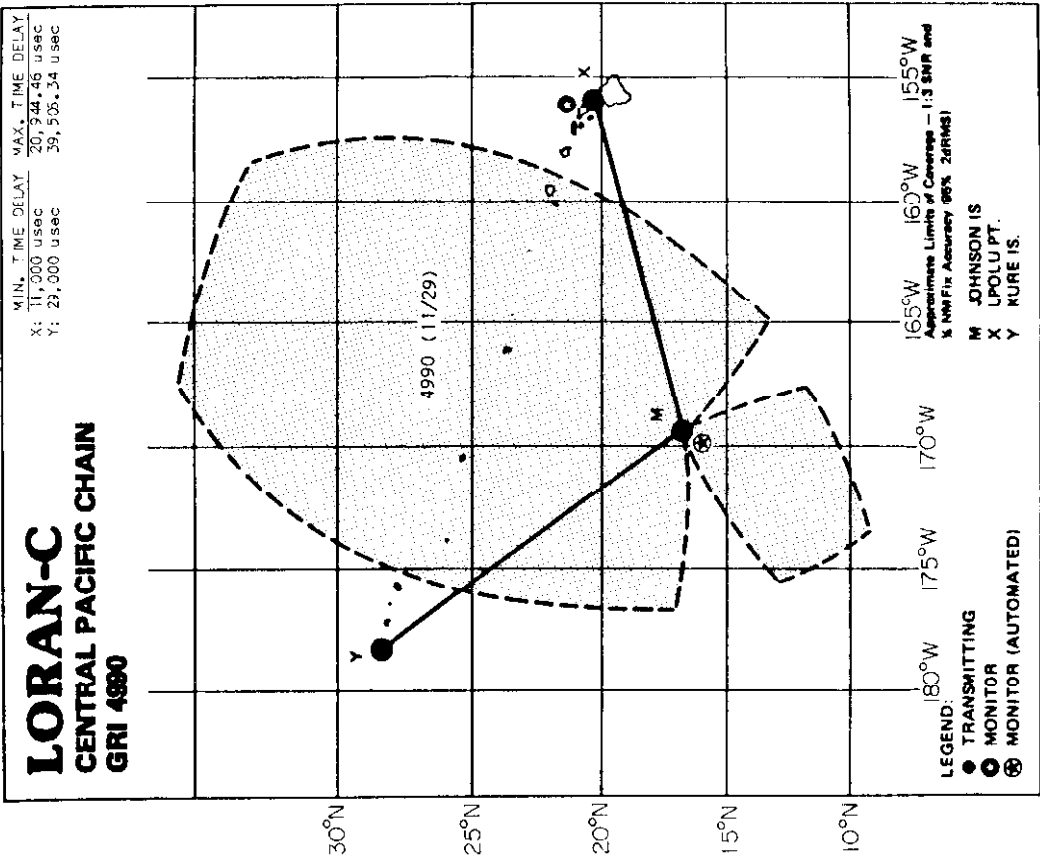
- [1] Arrival or anchor watch alarm
  - [1] Arrival alarm ..... LIMIT  
Beep ..... ON or OFF
  - [2] Anchor watch alarm ..... LIMIT  
Beep ..... ON or OFF
- [2] Cross-track error alarm ..... LIMIT  
Beep ..... ON or OFF
- [3] Border alarm ..... LIMIT  
Beep ..... ON or OFF
- [4] Wake-up alarm ..... TIME  
Beep ..... ON or OFF

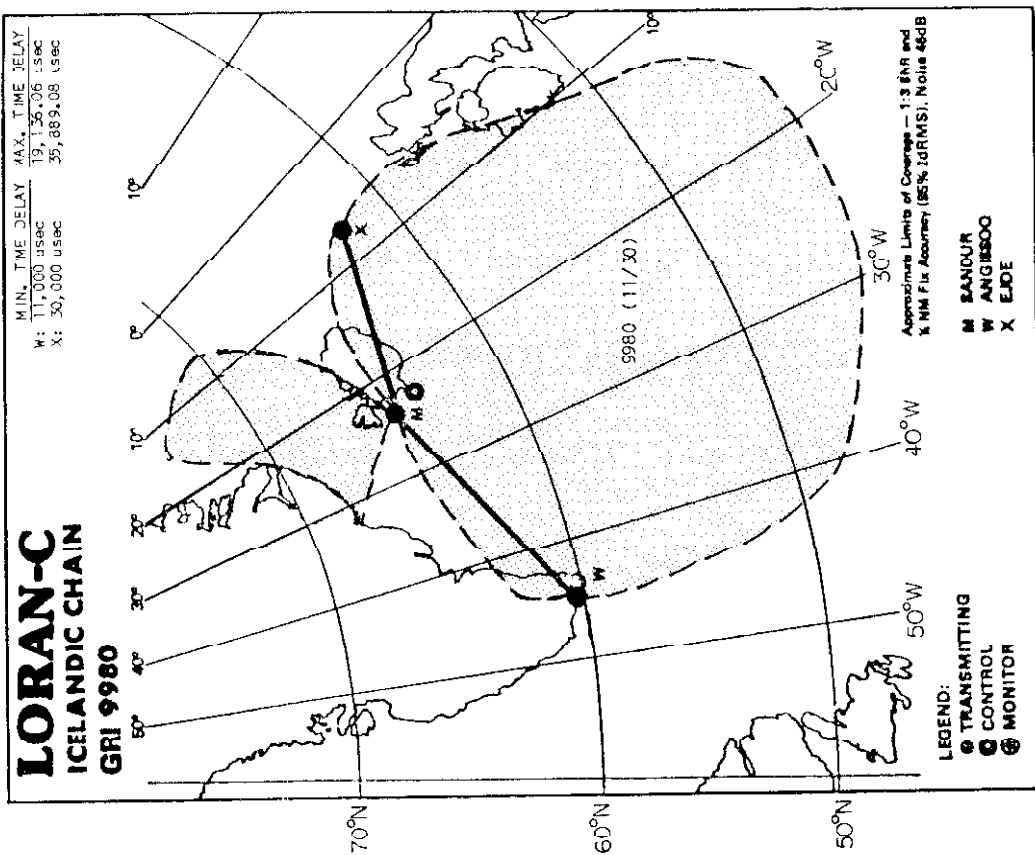
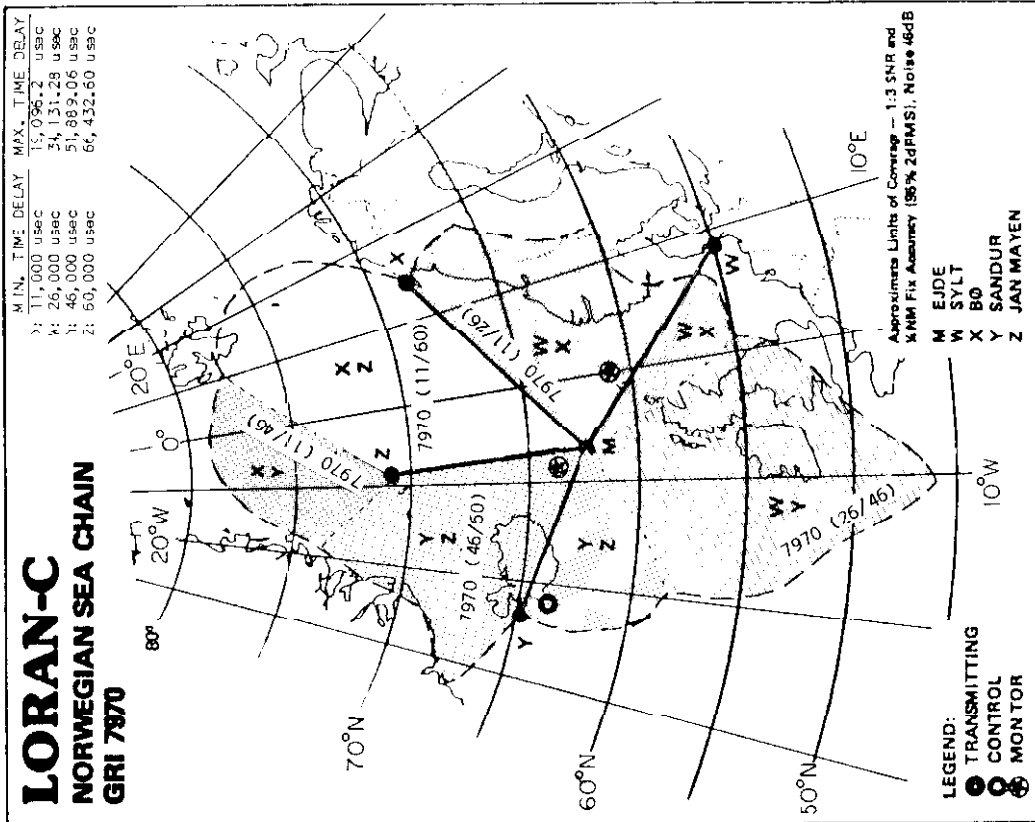


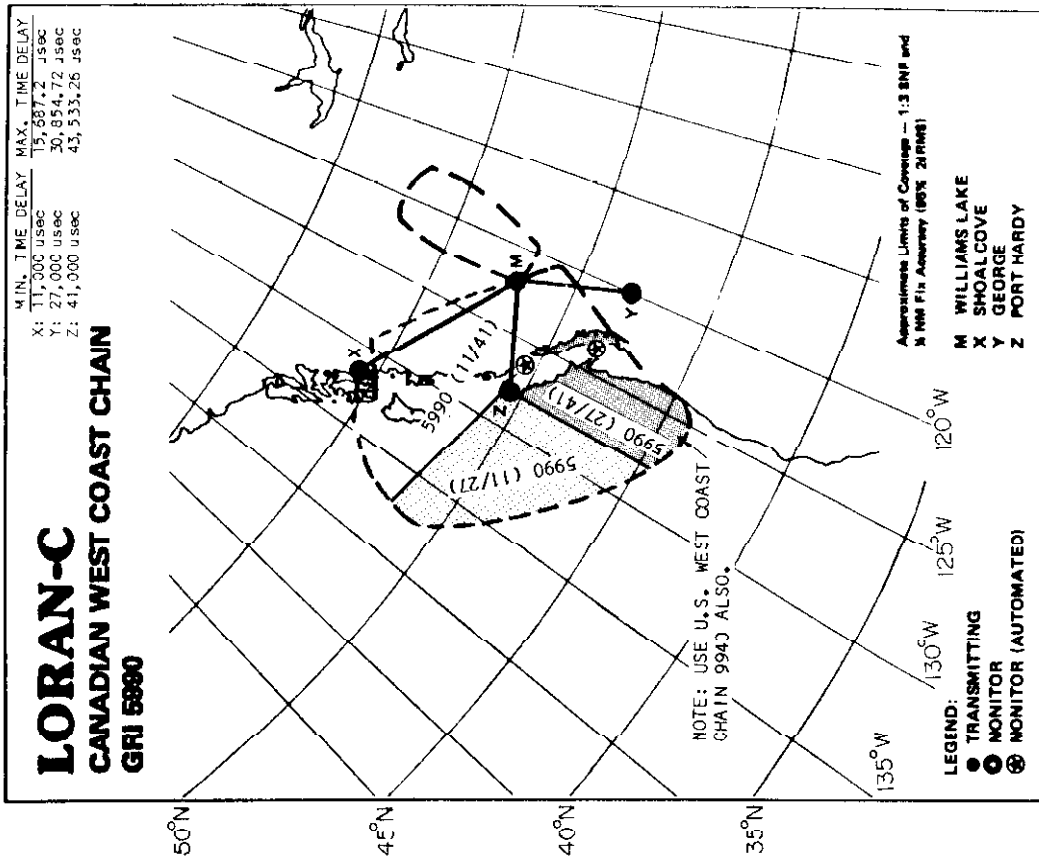
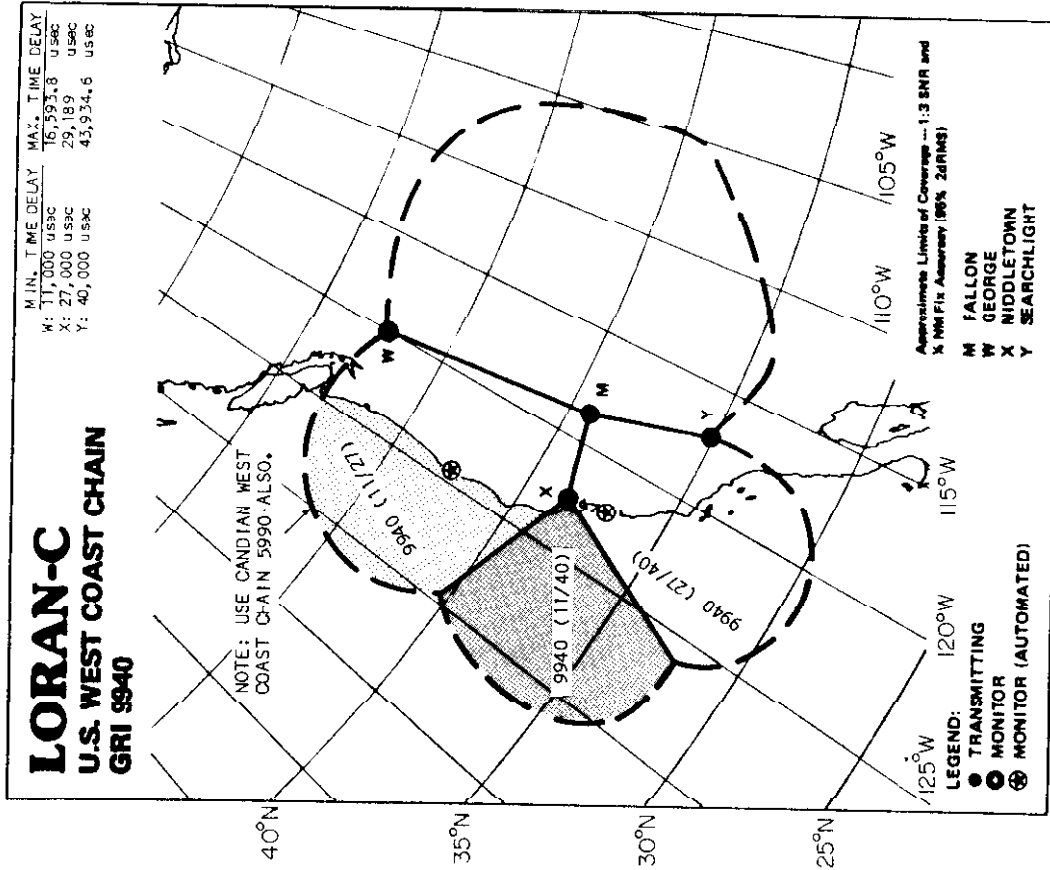


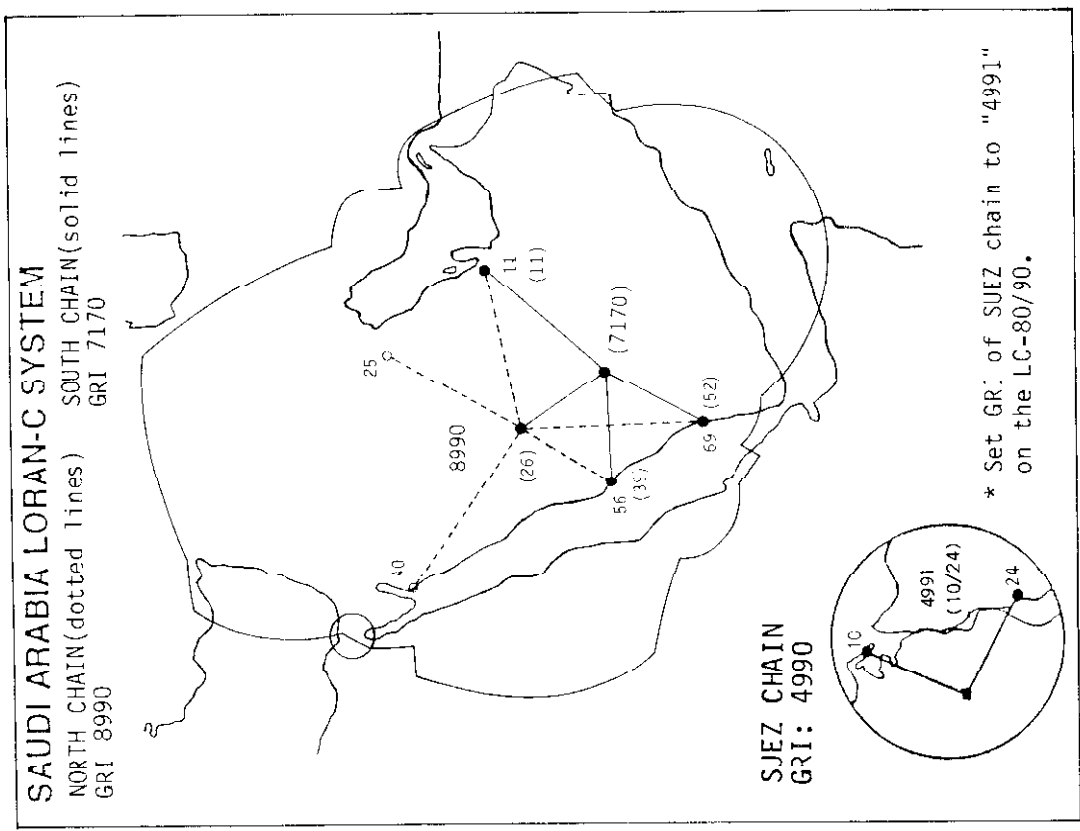
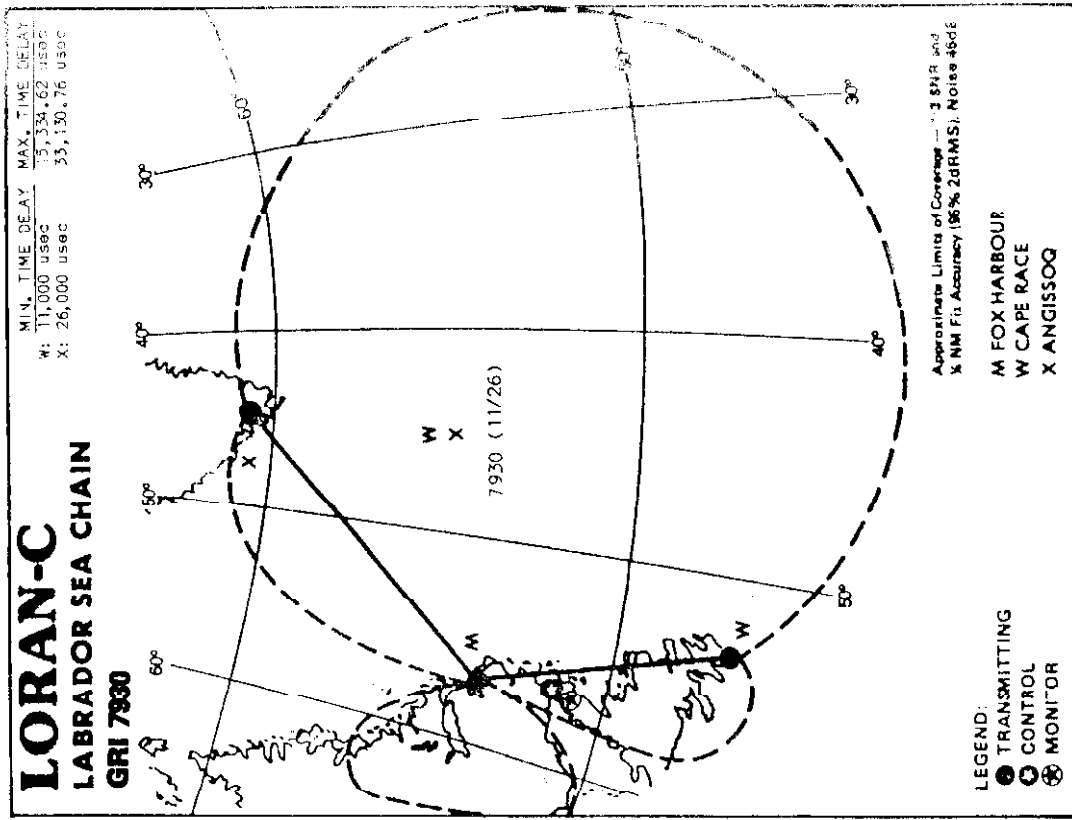


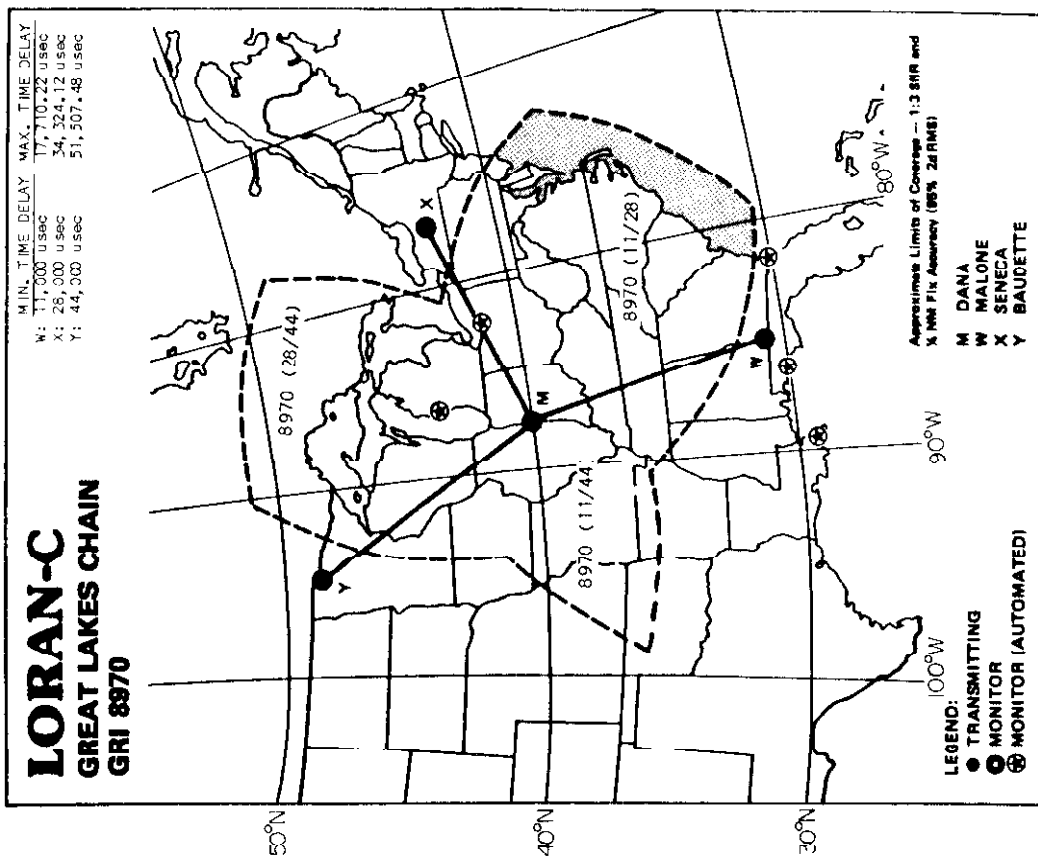
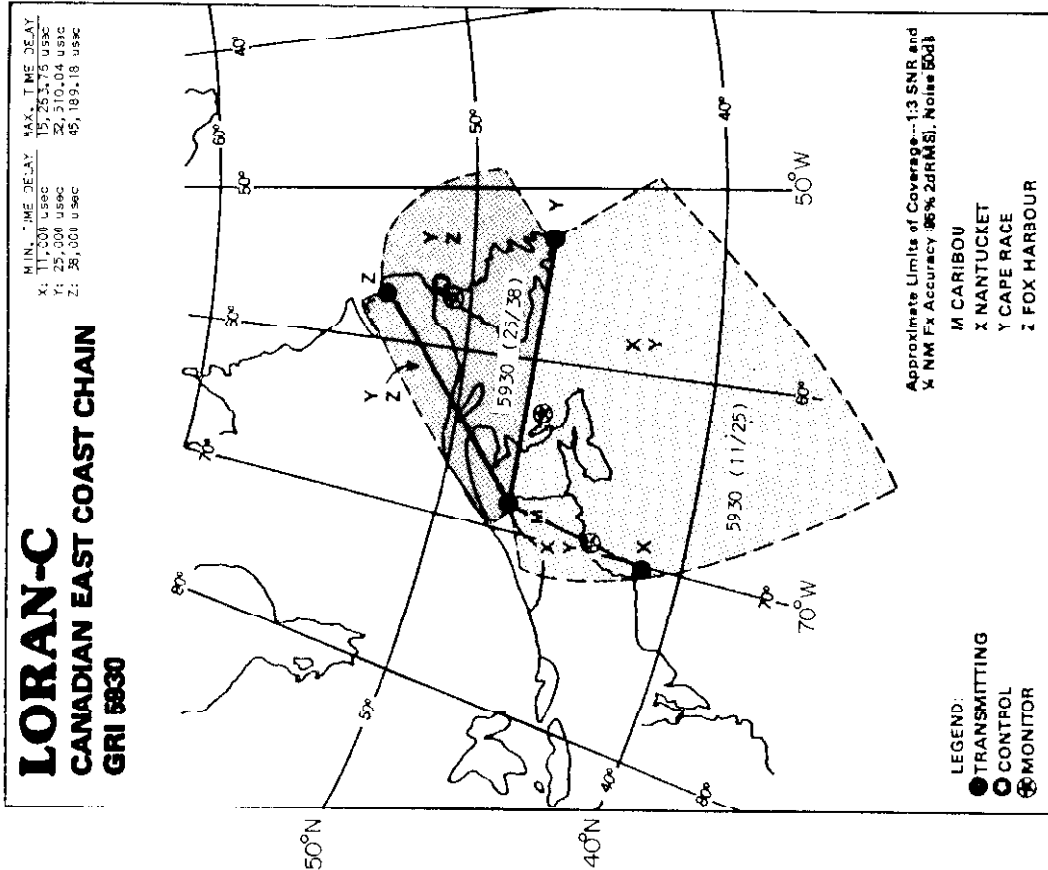












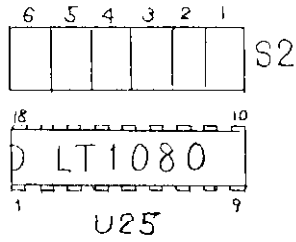


Fig.B-2

(4) Set the jumper plugs on post S2 on the GDC board (22P0003), and carry out wiring as instructed below.

**Case-1** EXT NAV port: RS-232C      OUTPUT port: CURRENT LOOP

S2	#1	#2	#3	#4	#5	#6
plug	ON	off	ON	off	off	ON

S1	#2
plug	ON

LP-1000                                      Ext. machine

"EXT NAV"                                      "RS-232C"

RXD 4 ----- 2 TXD  
 DTR 6 ----- 6 DSR  
 GND 10 ----- 7 GND  
 FPST 7 ]  
 GND 8 ]

**Case-2** EXT NAV port: CURRENT LOOP      OUTPUT port: RS232C

S2	#1	#2	#3	#4	#5	#6
plug	off	ON	off	ON	ON	off

S1	#2
plug	off

LP-1000                                      Ext. machine

"OUTPUT"                                      "RS232C"

TXD 2 ----- 3 RXD  
 DSR 8 ----- 20 DTR  
 GND 10 ----- 7 GND  
 OPST 13 ]  
 GND 14 ]

**Case-3** EXT NAV/OUTPUT ports: RS232C

S2	#1	#2	#3	#4	#5	#6
plug	ON	ON	ON	off	ON	off

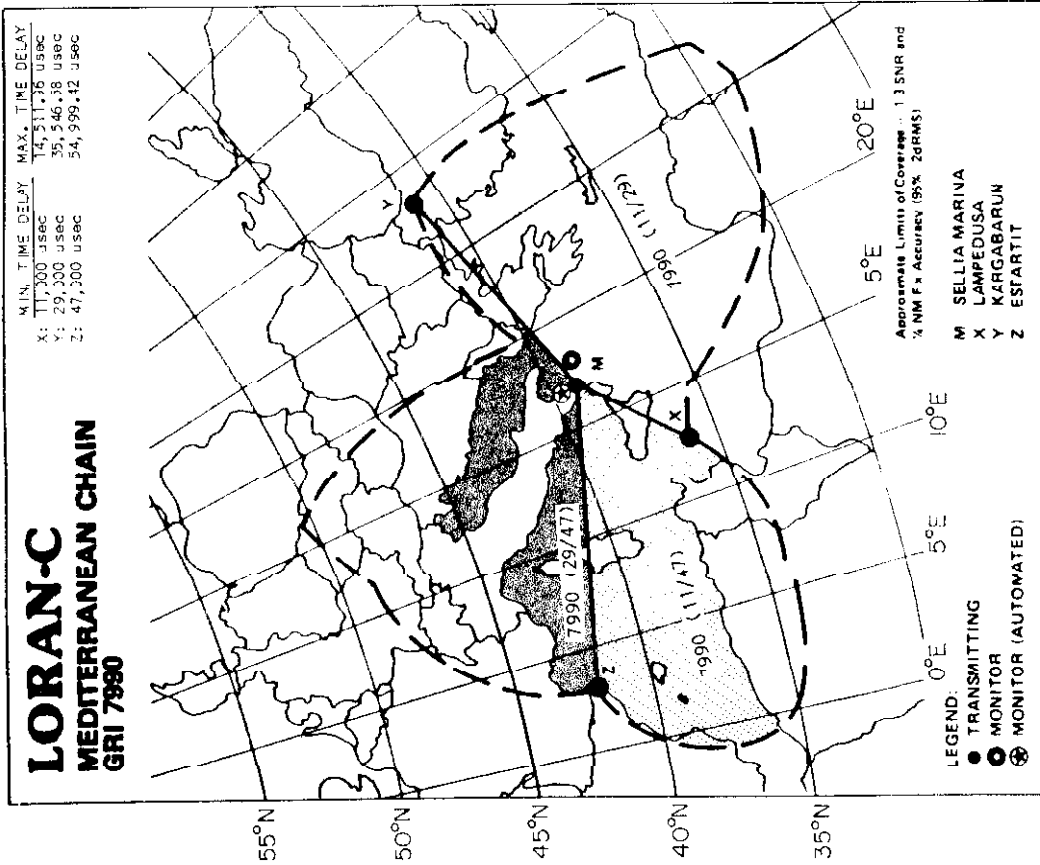
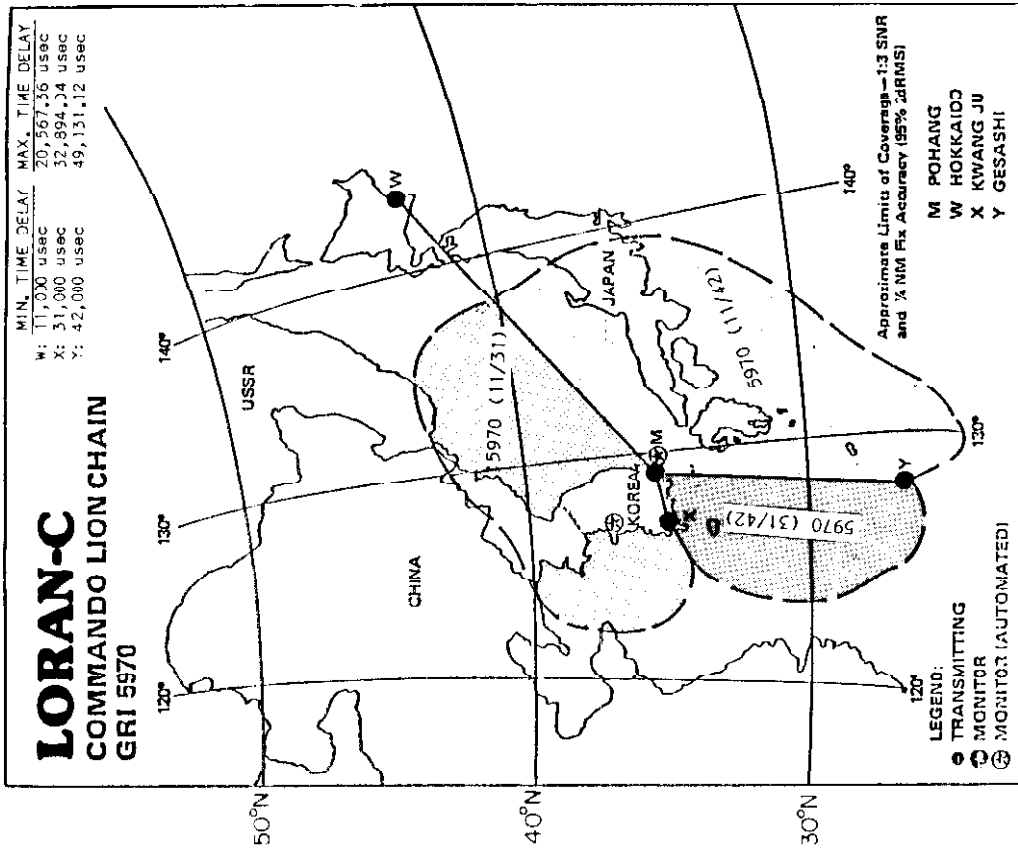
S1	#2
plug	ON

LP-1000                                      Ext. machine

"EXT NAV"                                      "RS232C"

RXD 4 ----- 2 TXD  
 DTR 6 ----- 6 DSR  
 GND 10 ----- 7 GND  
 EPST 7 ]  
 GND 8 ]





```

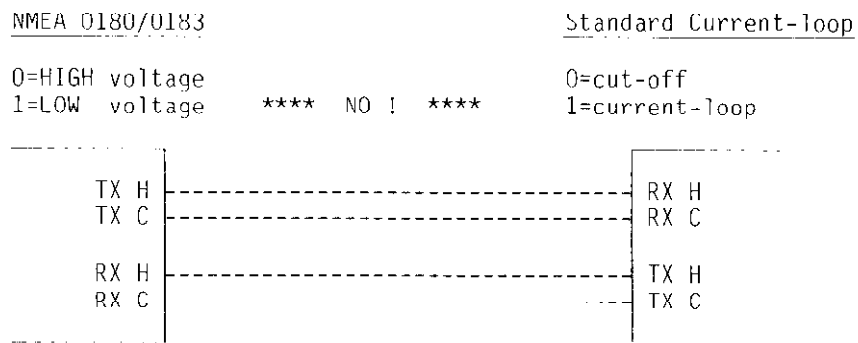
*****
*                               *
*               APPENDIX C      *
*                               *
*  STANDARD AND FURUNO'S CURRENT-LOOP SYSTEMS  *
*                               *
*****

```

20mA Current-loop System with NEGATIVE Logic is employed in this machine.

NMEA 0180/0183 vs. Standard Current-loop

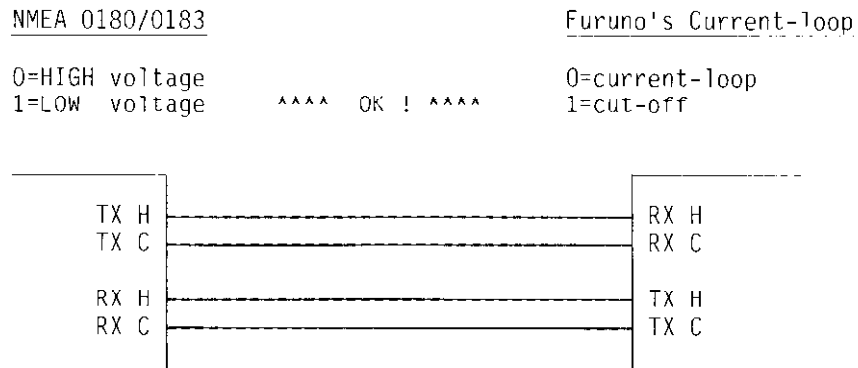
In the standard current-loop system, cut-off and current-loop conditions correspond to logical ZERO and ONE respectively. Imagine that such a system is interfaced with NMEA 0180/0183 in which ZERO and ONE are specified as HIGH and LOW voltage conditions respectively.



When the NMEA 0180/0183 side sends out "0"(HIGH voltage), for example, current will flow through the transmission line. This condition is recognized as "1" by the current-loop side. Thus, both systems can not be interfaced without adding logic inverters.

NMEA 0180/0183 vs. Furuno's Current-loop

Negative logic is employed in Furuno's current-loop system; "0" and "1" correspond to current-loop and cut-off conditions respectively. In most cases both systems may be interfaced, though Furuno's handles current signal and NMEA does voltage signal. Supposing that the NMEA 0180/0183 side outputs "0"(HIGH), for example, current will flow in the photo coupler which is located at the Furuno side e.g. logical ZERO.



\*\*\*\*\*  
 \* APPENDIX B \*  
 \* \*  
 \* MODIFICATION FOR RS232C INTERFACING \*  
 \*\*\*\*\*

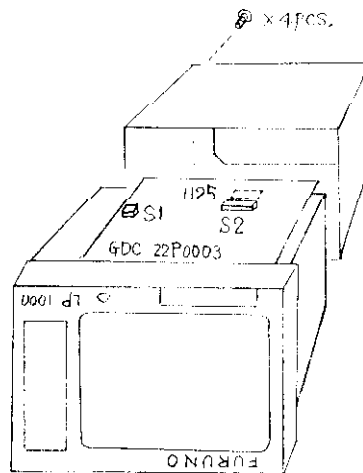
As mentioned on page 7, this machine is provided with FURUNO CIF, NMEA 0180 (Cross-track error output only) and NMEA 0183.

It may also be interfaced with an RS232C machine by adding the following modification.

NOTE: This modification does not affect any logical characteristics of data exchange, such as serial data formatting, protocol, etc. Only the physical characteristics of the signal is changed from the 20mA current-loop to the voltage level which swings between positive and negative voltages.

Modification

- (1) Place the display unit on a tabletop upside down.
- (2) Remove the cabinet cover after loosening the four screws as illustrated below.



- (3) Find mark "U25" by the jumper plug post S2 on the GDC (22P0003) board. Solder there the RS232C interface IC (LT1080, Mfd by LINEAR TECHNOLOGY, optionally available from Furuno as OP22-3). We recommend you to solder it from the component side of the pcb because the chassis/panels must be disassembled to considerable extent to gain access to the soldering side. Soldering work should be carried out with the utmost care not to damage neighboring components. It is recommended to remove the jumper plugs from post S2, and use a good soldering iron of 20W or so and high-grade soldering lead. It is also important to clean the pins of the IC beforehand.

```

*****
*                               *
*           APPENDIX D           *
*                               *
* LP-1000'S COMMUNICATION DATA FORMAT *
*                               *
*           (NMEA 0183)         *
*                               *
*****

```

(1) EXT NAV port (input)

LCGLL	DEGLL	TRGLL	GPGLL	IIGLL
LCVTG	DEVTG	TRVTG	GPVTG	IIVTG

(2) OUTPUT port (i/o)

input

\*\*MTW  
\*\*DBT

NOTE: \*\* may be any talker identifier. (Wildcard)

output

LCGLL	DEGLL	TRGLL	GPGLL	IIGLL
LCGTD				
LCVTG	DEVTG	TRVTG	GPVTG	IIVTG
LCAAM	DEAAM	TRAAM	GPAAM	IIAAM
LCWPL	DEWPL	TRWPL	GPWPL	IIWPL
LCBOD	DEBOD	TRBOD	GPBOD	IIBOD
LCBWC	DEBWC	TRBWC	GPBWC	IIBWC
LCXTE	DEXTE	TRXTE	GPXTE	IIXTE

NOTE: LCGTD is output only when the built-in loran receiver is selected.

```

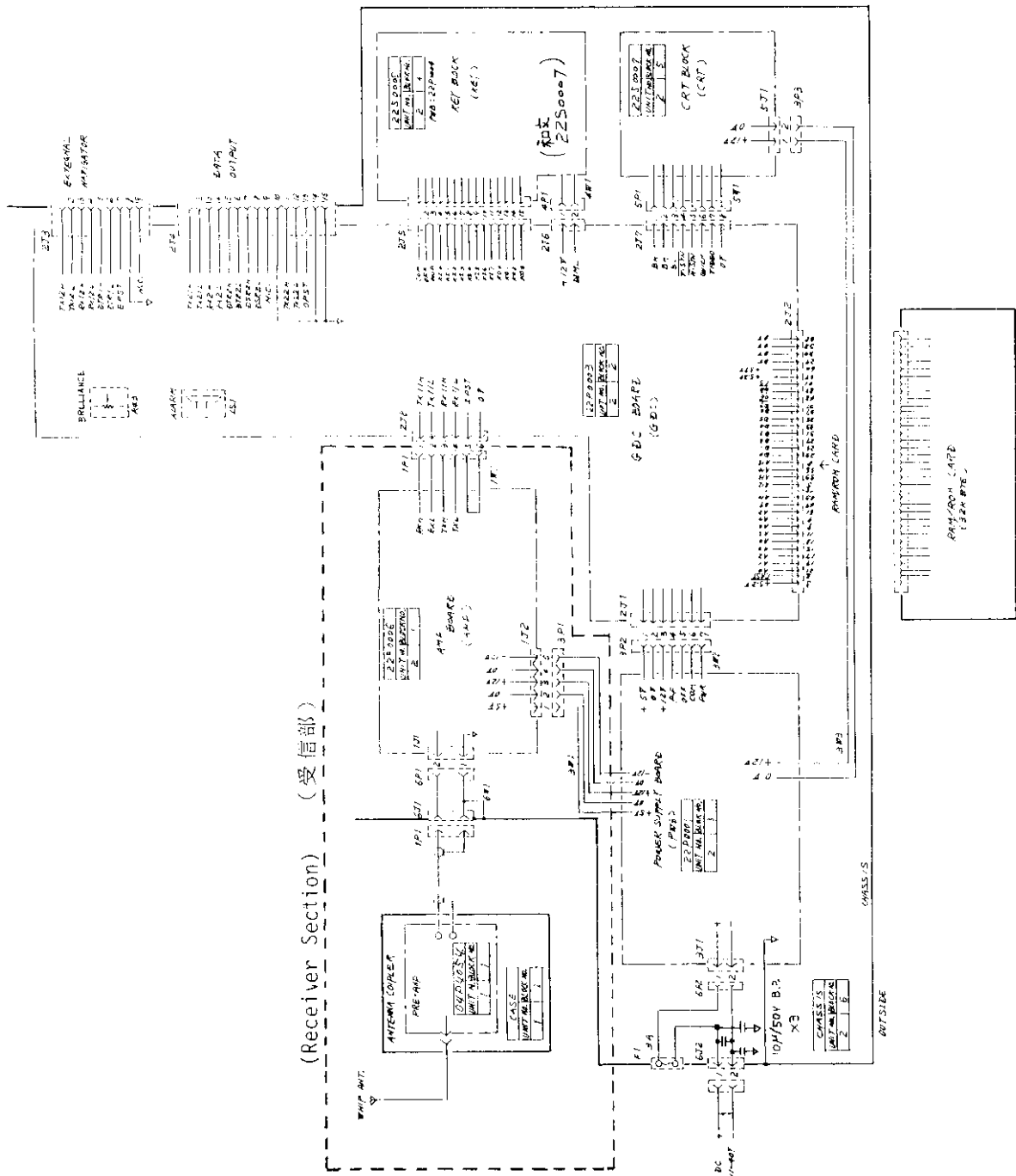
"OUTPUT"                "RS232C"
TXD  2  ----- 3  RXD
DSR  8  ----- 20 DTR
GND 10  ----- 7  GND
OPST 13  -]
GND 14  -]

```

Case 4 EXT NAV/OUTPUT ports: CURRENT LOOP (factory setting)

S2	#1	#2	#3	#4	#5	#6		S1	#2
plug	off	off	off	ON	off	ON		plug	off

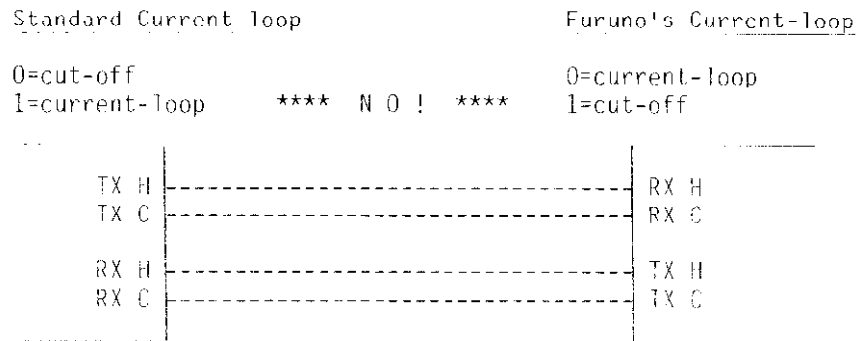
For connection diagrams, see pages 8 and 9.



APF-1

Standard Current-loop vs. Furuno's Current-loop

Problem occurs when interfacing the Furuno equipment with the standard current-loop which is employed in personal computers, etc. Furuno's logic is negative, but their logic is positive.



NOTE: Though IL is regulated by NMEA 0180/0183 to exchange information by using voltage-level signal, current-loop system is popular among many marine electronics. So long as negative logic is used in their "CURRENT-LOOP VERSION of NMEA 0180/0183", they may be interfaced with Furuno's equipment. If not, the above-mentioned problem arises.

```

*****
*           APPENDIX G           *
*   HOW TO RECOVER FROM        *
*   "MEMORY ERROR"            *
*****

```

Normally, when [PWR] is hit, (1) power is applied to the machine, (2) a beep is generated, (3) the self-test is conducted, and (4) the monitor screen is presented. If the machine is turned on with the back-up memory contents volatilized, the self-check result will be presented as shown below (either left or right illustration), but monitor screen does not appear.

If the self-test result is presented as shown right, turn off and on the machine. The left-shown screen will be presented.

```

08/24/87
09 15:30

STARTUP STATUS
RAM SYSTEM AREA : OK
RAM USER AREA   : OK
MEMORIES        : SOME ERRORS
ROM1 NO.225-0101-104
ROM2 NO.225-0101-204
PLEASE CHOOSE EITHER ONE BELOW.
[1] KEY: SAVE WAYPOINTS
[2] KEY: ALL MEMORIES CLEAR

```

```

08/24/87
09 15:30

STARTUP STATUS
RAM SYSTEM AREA : OK
RAM USER AREA   : OK
MEMORIES        : OK
ROM1 NO.225-0101-104
ROM2 NO.225-0101-204
NOW STARTING UP!

(MEMORY ERROR!)

```

When the self-test result is presented as shown left, conduct the following operations:

If you do not mind erasing all the memory contents including the waypoints, hit [2].

If you want to erase all the data excluding the waypoints;

- (1) Hit [1].
- (2) While calling up the waypoint one by one through the WPT [2] (Recall & erase waypoint) path, record those data in a log.
- (3) Erase all the memory contents through the INIT [7] (All memories clear) path.
- (4) Referring to the log, reenter the waypoints through the WPT [3] (Enter WPT by lat/lon) path.

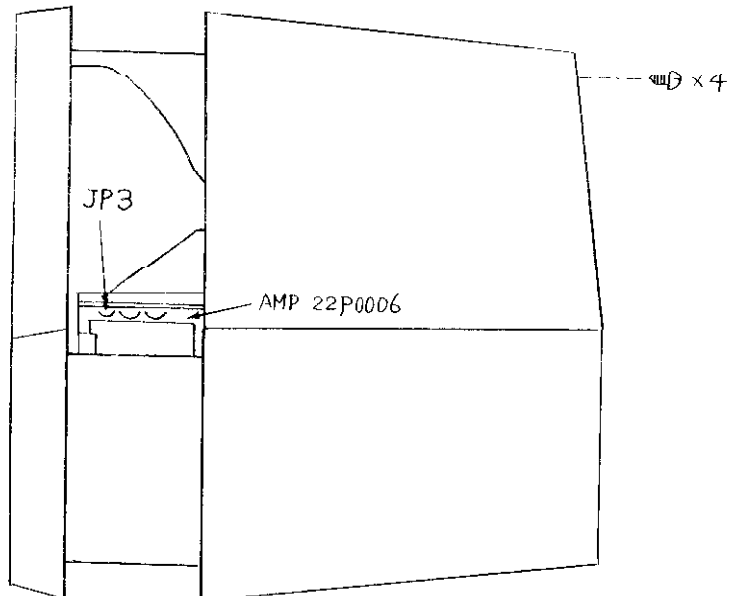
After the above-mentioned operations, set up various parameters through the INIT, PLOT menus, etc.



\*\*\*\*\*  
\* APPENDIX E \*  
\* CHANGING TRACKING SPEED \*  
\*\*\*\*\*

This machine can perform position fixing until the ship's speed exceeds 80KTS.

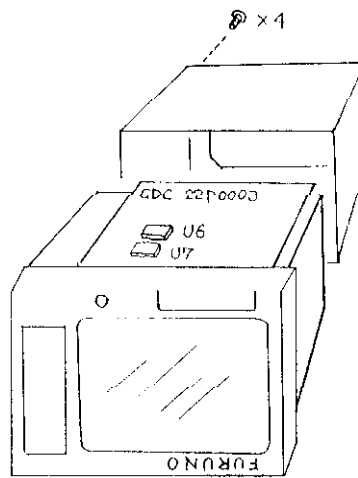
By cutting jumper wire JP3 on the 22P0006 board (shown below), you may change the max. tracking speed down to 40KTS. If the ship's max. speed is below 40KTS, you may conduct this modification. Loran fix will become more stable (the course line will be plotted more smoothly) when compared with the 80KTS setting (with the jumper).



\*\*\*\*\*  
 \* APPENDIX I \*  
 \* HOW TO REPLACE \*  
 \* ROM CHIPS \*  
 \*\*\*\*\*

[CAUTION] Even if the machine is turned off, some circuits are kept "alive" by the back-up battery. Do not touch the circuits unless instructed below. Shortcircuit may result in defect of the component or destruction of the back-up memory contents.

- (1) Put the machine on the table upside-down.
- (2) Loosen the four screws, and remove the cabinet cover as illustrated below.



- (3) Extract the ROM's (U6 and U7) from the GDC (22P0003) board, by using an IC extractor.
- (4) After inserting the new ROM's into the sockets, fix them with a plastic binder.

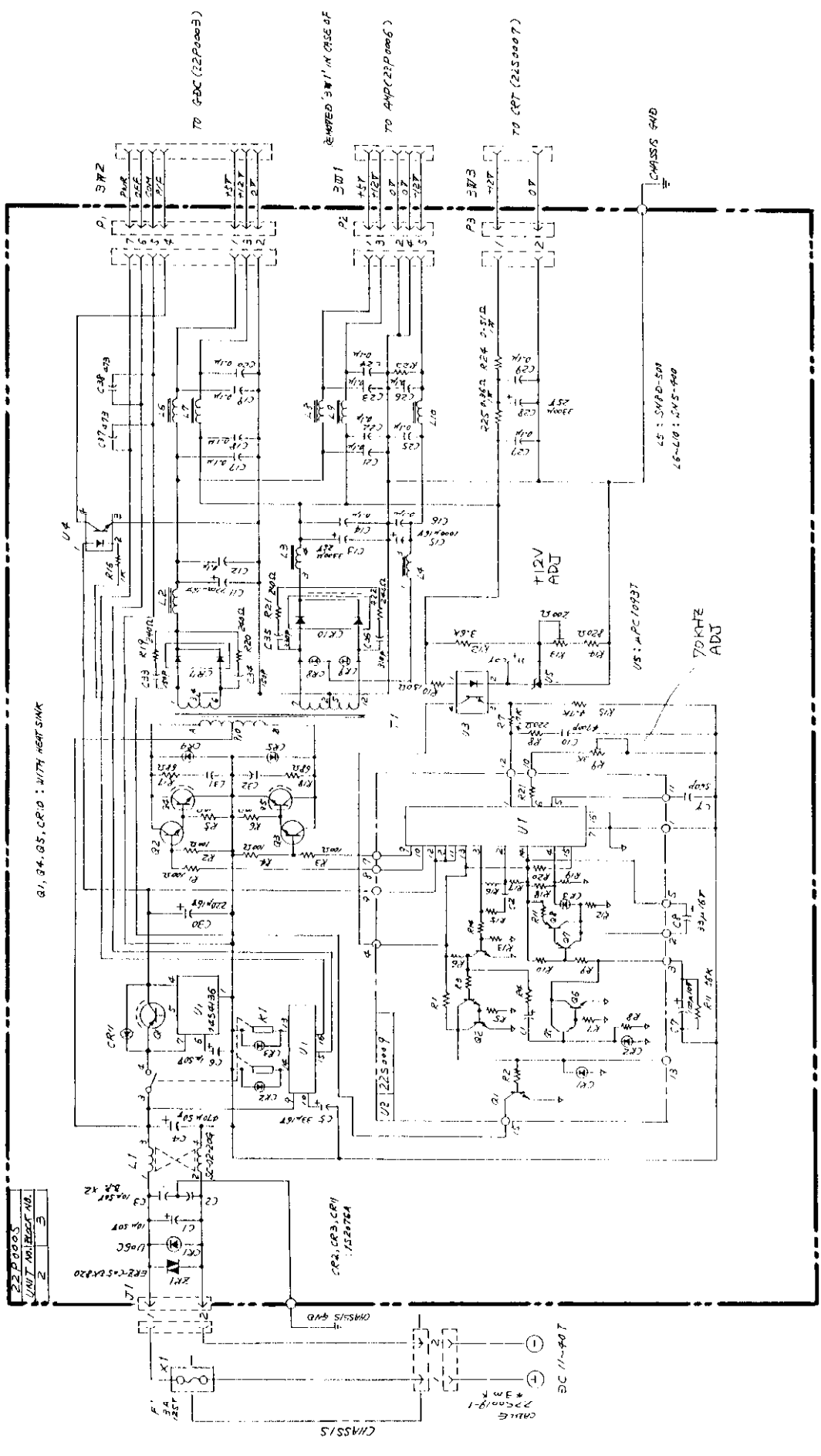
Program Nos.

U6: 225-0101-1XX

U7: 225-0101-2XX

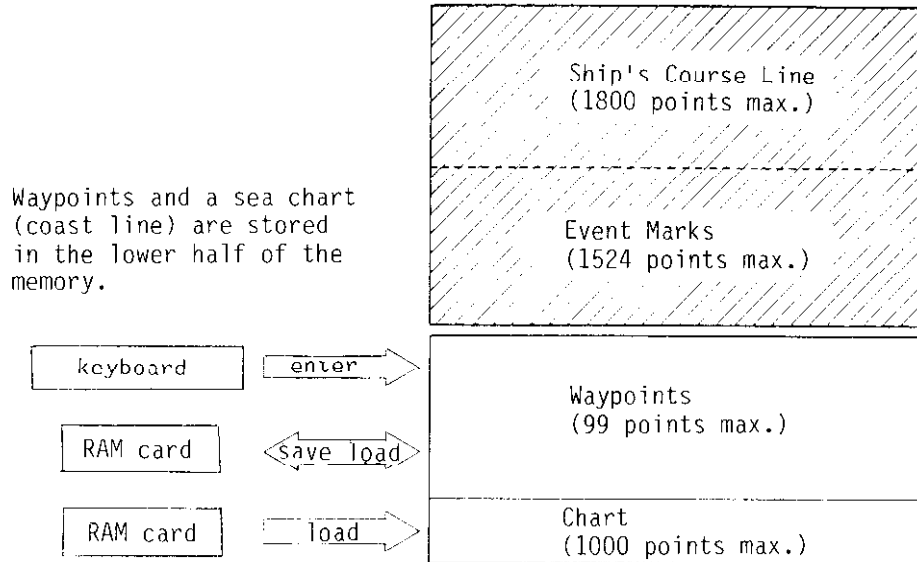
↑ Version No.


- (5) Turn on the machine, and confirm that the memory contents are not volatilized. See page APG-1.

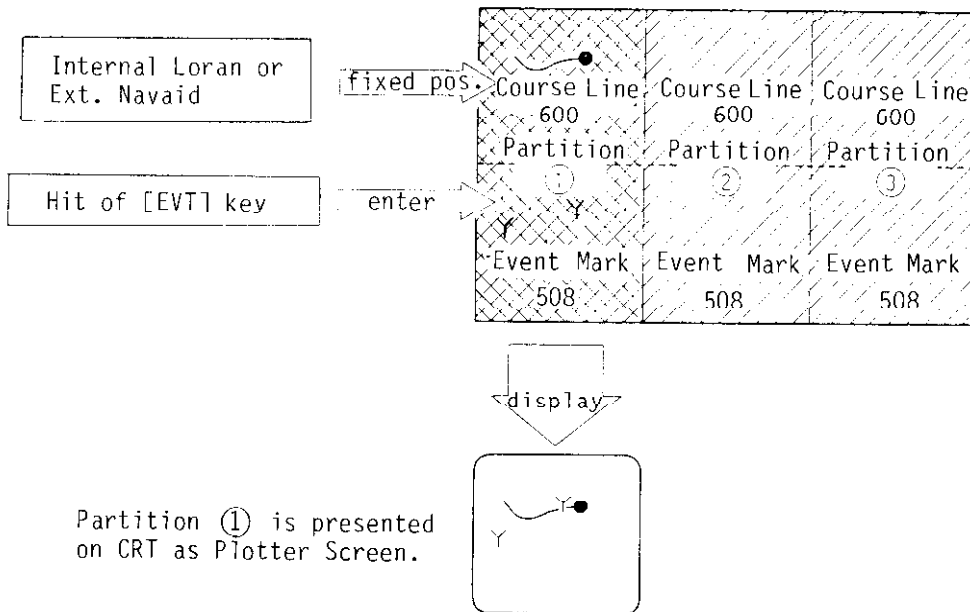


\*\*\*\*\*  
 \* APPENDIX K \*  
 \* \*  
 \* HANDLING MEMORY PARTITIONS \*  
 \* \*  
 \*\*\*\*\*

This machine can memorize up to 4423 geographical locations (=1800+1524+99+1000) as illustrated below.



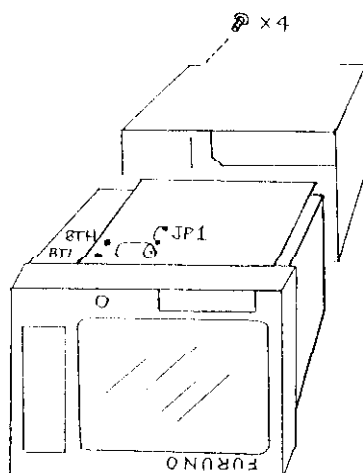
The  area is divided into three partitions (①, ②, ③) at the factory. Locations fixed by a navaid are stored into partition ① in succession. New event marks are also stored in partition ①.



\*\*\*\*\*  
\* APPENDIX H \*  
\* HOW TO REPLACE BACK-UP BATTERY \*  
\*\*\*\*\*

[CAUTION] Even if the machine is turned off, some circuits are kept "alive" by the back-up battery. Do not touch the circuits unless instructed below. Shortcircuit may result in defect of the component or destruction of backed-up memory contents.

- (1) After disconnecting the power cable, put the machine on the table upside-down.
- (2) Loosen the four screws, and remove the cabinet cover as illustrated below.

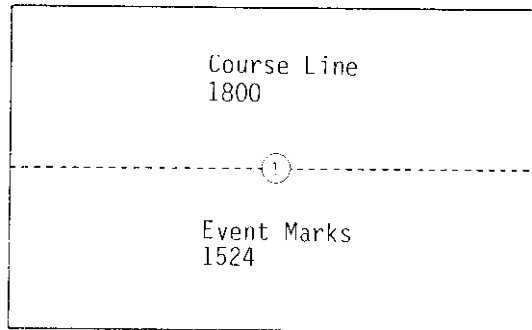
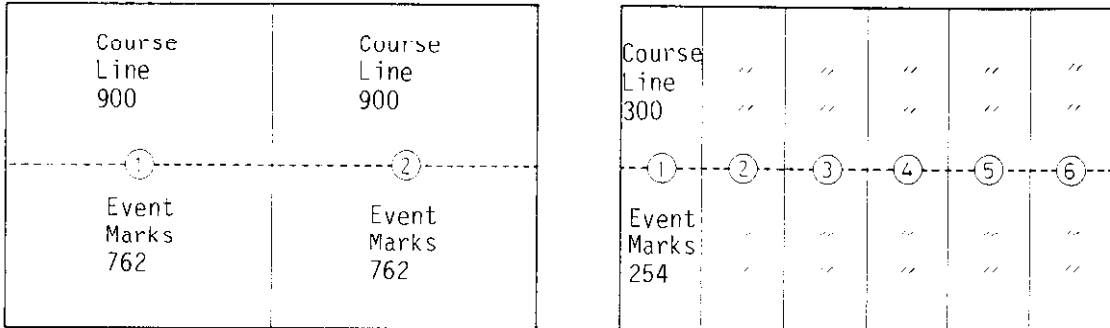


- (3) Measure the battery voltage between the "BTH" (+) and "BTL" (-) terminals on the GDC (22P0003) board. If the voltage is below 2.5Vdc, replace the battery as instructed in the following steps. (Unless you mind loosing the memory contents, you may omit the steps with "\*" marks.)

Lithium Battery : CR2/3 6-LF1FR5S 22S0062-0  
[000-111-787]  
Life = 3 years approx.

- \* (4) In order to hold the memory contents during the battery replacing work, temporarily connect a dry battery between the "BTH" (+) and "BTL" (-) terminals, using leads. (Any type battery may be used so long as the voltage is 3 to 5 Vdc.) (Be careful about the polarity.)
- \* (5) Cut jumper "JP1" on the same pc board.
- (6) Remove the battery fixing metal, and replace the existing lithium battery with a new one. (Be careful about the polarity.)
- \* (7) Reconnect jumper "JP1".
- \* (8) Remove the dry battery which was connected in step (4) for temporary back-up.
- (9) Fix the newly connected lithium battery with the fixing metal.
- (10) Turn on the machine, and confirm that the memory contents are not volatilized. See page AGP-1.

- As mentioned earlier, the memory is factory-divided into three partitions. If you wish, you may divide it into two or six, or use the whole area as one partition. Refer to P.49 (1).

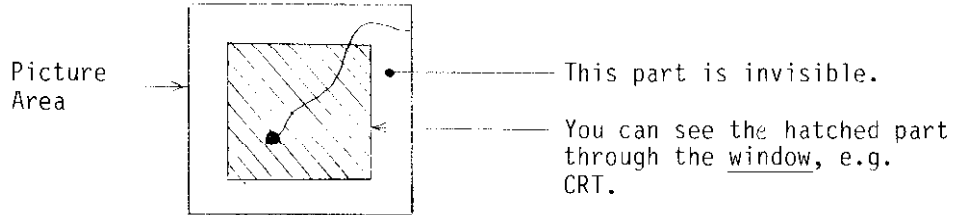


- When the whole area is used as one partition, a long course line (1800 points) may be presented and many event marks (1524 points) may be entered. However, a course line/event marks can not be copied onto another partition. (You may store them onto a RAM card, but the current course line/event marks will be erased when the RAM card contents are reloaded.)

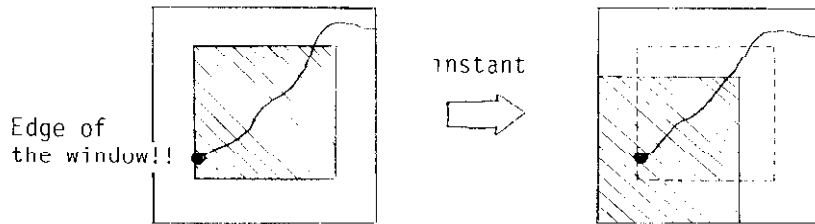
[NOTE] When the configuration (division) of the memory partition is changed, the contents in all the partitions are erased.

\*\*\*\*\*  
 \* APPENDIX J \*  
 \* SHIP'S MOVEMENT \*  
 \* AND \*  
 \* PICTURE SCROLLING \*  
 \*\*\*\*\*

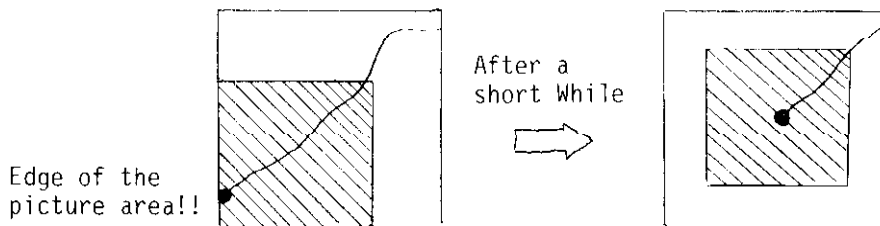
This machine has a large picture area, and you can see about 50% of it through the window, e.g. CRT. See the following illustration.



When the own ship reaches the edge of the "window" area, the window shifts itself not to miss the own ship. (This operation is done instantly.) See the illustrations below.



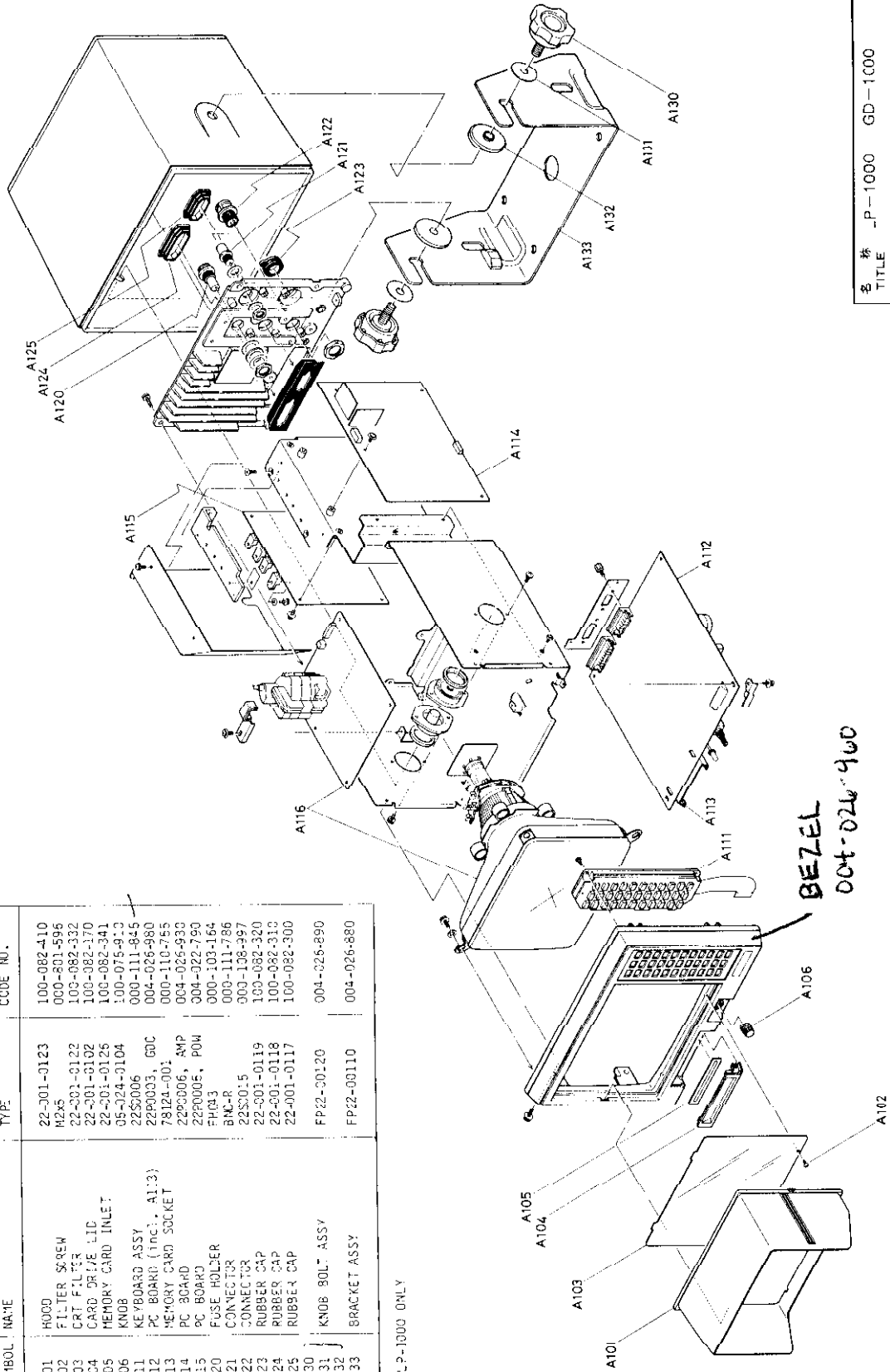
When the own ship finally reaches the edge of the picture area, the machine re-paints the entire picture with the own ship and the "window" positioned at the center part of the picture area. See the following illustrations.



Remember that this machine is provided with two pages of such picture areas. If you assign different chart scales to both pages, picture re-painting takes place alternately between page 1 and 2, resulting that you may observe the ship's course on either page 1 or 2 without interruption.

SYMBOL	NAME	TYPE	CODE NO.
A101	HOOD	22-001-0123	100-082-110
A102	FILTER SCREW	M2x5	000-801-595
A103	CAT FILTER	22-001-0122	100-082-332
A104	CARD DRIVE LID	22-001-0102	100-082-170
A105	MEMORY CARD INLET	22-001-0125	100-082-341
A106	KNOB	05-024-0104	100-075-913
A111	KEYBOARD ASSY	22S006	000-111-845
A112	PC BOARD (incl. A113)	22P003, G0C	004-026-980
A113	PC BOARD	78124-001	000-110-755
A114	PC BOARD	22PC006, SMP	004-026-930
A115	PC BOARD	22P000E, POW	004-022-790
A120	FUSE HOLDER	FP043	000-103-164
A121	CONNECTOR	BMC-R	000-111-786
A122	RUBBER CAP	22S015	000-108-997
A123	RUBBER CAP	22-001-0119	100-082-320
A124	RUBBER CAP	22-001-0118	100-082-310
A125	RUBBER CAP	22-001-0117	100-082-300
A130	KNOB 80L" ASSY	FP42-C0120	004-026-890
A131	BRACKET ASSY	FP42-00110	004-026-880
A132			
A133			

\* L.P-1000 ONLY



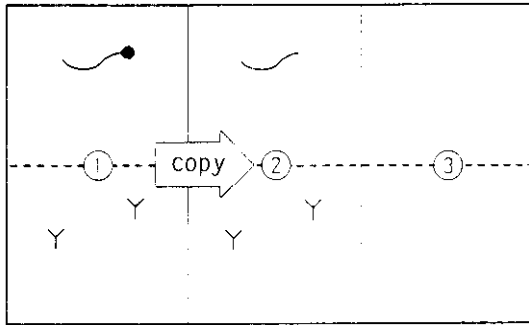
名称	_P-1000	GD-1000
TITLE	MECHANICAL EXPLODED VIEW	
图番	E4316-005-A	
DWG. NO.		

APM-1

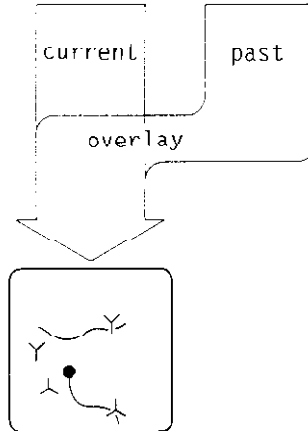
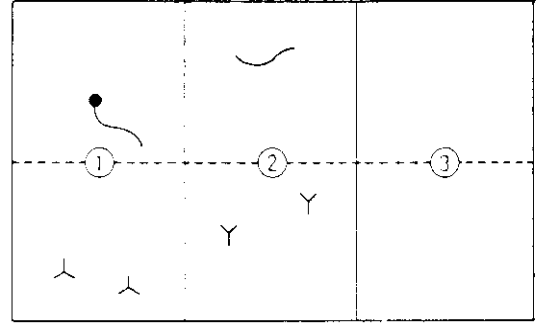


Partitions (2) and (3) are used as mentioned below.

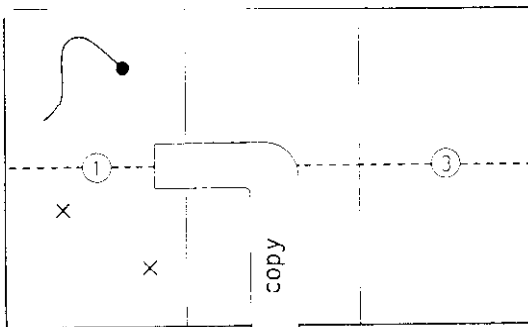
(A) You may copy from 1 to 2 (or 3). Refer to P.49 (2).



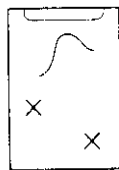
(B) You may overlay (1 (current course line and event marks) with 2 (or 3)). Refer to P.49 (3).



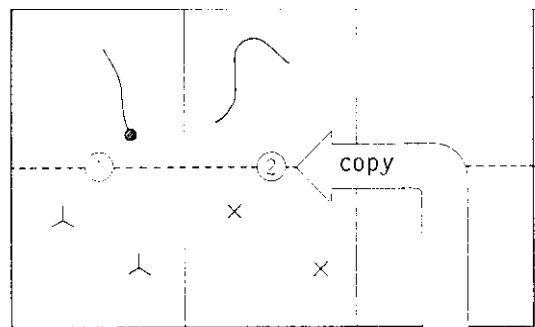
(C) You may save the contents of any partition into a RAM card. Refer to P.50 (2).



RAM card



(D) You may reload the contents of a RAM card onto any partition. Refer to P.50 (3).



RAM card

You may see the reloaded contents as mentioned in (B).

```
*****
*           APPENDIX L           *
*           ^                   *
* ERASING ALL EVENT MARKS *
*****
```

As mentioned on page 28, all the event marks may be erased.  
Follow the path list below.

```
[MNU]
PLT
[5] Memory partition type & erase
```

```
----- ERASE NO.1 (EVENT MARKS)
```

## Free Manuals Download Website

<http://myh66.com>

<http://usermanuals.us>

<http://www.somanuals.com>

<http://www.4manuals.cc>

<http://www.manual-lib.com>

<http://www.404manual.com>

<http://www.luxmanual.com>

<http://aubethermostatmanual.com>

Golf course search by state

<http://golfingnear.com>

Email search by domain

<http://emailbydomain.com>

Auto manuals search

<http://auto.somanuals.com>

TV manuals search

<http://tv.somanuals.com>