

No. : OM-E3327-0C

# FURUNO

# OPERATOR'S MANUAL

MARINE RADAR

MODEL FR-7010D



**FURUNO ELECTRIC CO., LTD.**  
NISHINOMIYA, JAPAN

900310T (9003, yoha)  
PRINTED IN JAPAN

## WARNING AGAINST HIGH TENSION

The operation of this equipment involves the use of high voltage, which endangers human life. Although the design of the equipment has been made in due consideration of measures to insure the operator's safety, adequate precaution must be exercised when reaching inside the equipment for the purpose of maintenance and service. Do not change a component or inspect the equipment with the voltage applied. A residual charge may exist in some capacitors with the equipment turned off. Always short all supply lines to the chassis with an insulated screwdriver or a similar tool prior to touching the circuit.

## FIRST AID IN CASE OF ELECTRIC SHOCK

When a victim struck by electricity is found, first switch off the equipment via the main switch on the equipment or the ship's distribution board. If this is not possible, protect yourself with dry insulating material (a wooden plate or rod, cloth, your belt, etc.) and pull the victim clear of electricity. If the victim is not breathing himself, apply artificial respiration according to the "Method of Artificial Respiration." Do not give up halfway. Perseverance and continual efforts are important in artificial respiration.

## METHOD OF ARTIFICIAL RESPIRATION

Lay the victim on his back. Position yourself beside the victim's head and pinch his nose by your thumb and forefinger to prevent air leakage. Insert the thumb of your other hand between the victim's teeth and lift his chin up. Then, place the arm (the one closing the victim's nose) on the victim's forehead and press the head down so that the victim's head is given a maximum backward tilt with the chin prominent and the neck bent back. Seal the victim's mouth with your mouth and blow therein about half of the deeply inhaled air every time. After exhaling, turn your head to watch for a chest contraction, whilst inhaling deeply in readiness for the next blowing. Repeat the movements faster for the first 1 to 2 minutes and 12 times per minute thereafter.

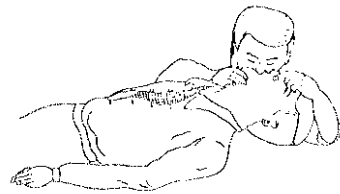
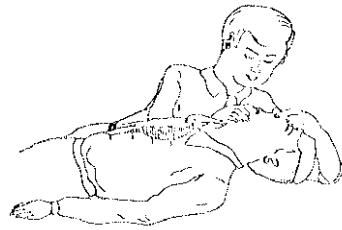

## RADIATION HAZARD

Radiation emitted from the scanner can be harmful, particularly to the eyes. To avoid harmful radiation, ensure the radar is set to either ST-BY or OFF before beginning work on the scanner. Under no circumstances should you look directly into the scanner from a distance of less than 2 feet when the radar is in operation.

## A WORD TO FURUNO FR-7010D OWNERS:

Congratulations on your choice of the FURUNO FR-7010D Radar. We are confident that you will enjoy many years of trouble-free operation with this fine piece of equipment.

For over 40 years FURUNO Electric Company has enjoyed an enviable reputation for quality and reliability throughout the world. This dedication to excellence is furthered by our extensive global network of agents and dealers.

The FR-7010D is just one of the many Furuno developments in the field of radar. The compact, lightweight but rugged unit is easy to install and operate and is suitable for use on a wide variety of vessels.

This unit is designed and constructed to give the user many years of trouble-free operation. However, to obtain optimum performance from this unit, you should carefully read and follow the recommended procedures for installation, operation and maintenance. No machine can perform to the utmost of its ability unless it is installed and maintained properly.

We would appreciate feedback from you, the end-user, about whether we are achieving our purposes.

Thank you for considering and purchasing Furuno equipment.

## CAUTION

No one navigational aid should be relied upon exclusively for the safety of vessel and crew. The navigator has the responsibility to check all aids available to confirm his position. Electronic aids are not a substitute for basic navigational principles and common sense.

# CONTENTS

	Page
SPECIFICATIONS .....	1 to 4
PRINCIPLE OF OPERATION .....	5
INSTALLATION .....	6 to 23
GENERAL MOUNTING CONSIDERATIONS .....	6
DETAILED INSTRUCTIONS .....	6
SCANNER UNIT INSTALLATION .....	6
DISPLAY UNIT INSTALLATION .....	12
CHECKING THE INSTALLATION .....	15
INITIAL PROCEDURES .....	16
RELATIVE BEARING ALIGNMENT .....	16
SWEEP TIMING ADJUSTMENT .....	18
PRESET GAIN ADJUSTMENT .....	18
TUNING & TUNING INDICATOR SENSITIVITY ADJUSTMENT .....	19
PANEL ILLUMINATION ADJUSTMENT .....	19
A/C SEA ADJUSTMENT .....	19
A/C RAIN ADJUSTMENT .....	20
MAGNETRON HEATER VOLTAGE ADJUSTMENT .....	20
MEASUREMENT OF BLIND SHADOW SECTORS .....	20
OPERATIONAL OVERVIEW .....	24 to 40
THE FRONT PANEL .....	24
TURNING THE UNIT ON AND OFF .....	26
SETTING UP .....	26
MEASURING RANGE AND BEARING .....	30
REDUCING OR ELIMINATING INTERFERENCE .....	33
BETTER DISTINCTION OF ECHOES .....	34
SETTING/DELETING THE ALARM .....	34
USING THE CURSOR .....	36
SHIFTING THE DISPLAY .....	37
ZOOM FUNCTION .....	38
PLOTTING .....	39
DISPLAYING NAV DATA (OPTION) .....	40
APPLICATION .....	41 to 50
FACTORS AFFECTING MINIMUM RANGE .....	41
FACTORS AFFECTING MAXIMUM RANGE .....	41
INTERPRETING THE DISPLAY .....	43
POSITION FIXING WITH RADAR .....	47
COLLISION AVOIDANCE .....	49
AIDS TO NAVIGATION .....	50
MAINTENANCE .....	51
GENERAL .....	51
SCANNER UNIT .....	51
DISPLAY UNIT .....	51
TROUBLESHOOTING .....	52 to 56
BASIC TROUBLESHOOTING .....	52
MORE EXTENSIVE TROUBLESHOOTING .....	52
CHECKING THE MAGNETRON .....	54
SCHEMATIC DIAGRAMS .....	S-1 to S-8
OUTLINE DRAWINGS .....	D-1 to D-2

## NOTICE TO

### USERS OF FURUNO RADARS MODEL 1730/1760/1830/1930, FR-7010D/7040D

Two 5A fuses have been added to the spare parts from the production in September 1990. These fuses are for use with 24VDC or 32VDC power supplies. (The two 10A fuses are for 12VDC power supply.)

To show this addition in your manual please update it with the information tabulated below. We apologize for the inconvenience.

Items to be added						Pertinent pages					
						M1730	M1760	M1830	FR- M1930	FR- 7010	FR- 7040
<b>SPARE PARTS:</b>						0-6	0-7				
No.	Name	Type	Code No.	Q'ty	Remarks						
1	Fuse	FGMB 10A 125VAC	000-104-815	2	for 12VDC ship's mains						
2	Fuse	FGMB 5A 125VAC	000-112-785	2	for 24/32VDC ship's mains						
-----								4	3	4	
No.	Name	Type	Code No.	Q'ty	Remarks						
1	Fuse	FGBO 10A 125VAC	000-549-065	2	for 12Vdc mains						
2	Fuse	FGBO-A 5A 125VAC	000-549-064	2	for 24/32Vdc mains						
<b>Fuse replacement</b>						4-1	4-1	49	51	51	
To protect the equipment from serious damage, a 10A (for 12Vdc mains) or 5A (for 24/32Vdc mains) fuse is provided on the rear panel. The fuse protects against overvoltage/reverse polarity of the ship's mains or internal fault of the equipment. If the fuse has blown, first find the problem before replacing it with a new one. A fuse rated for more than 10A or 5A must not be used, since it may cause serious damage to the equipment. OVER FUSING WILL VOID WARRANTY.											
<b>Fuse Exchange For 24/32VDC Power Supplies</b>						6-8	6-8	15	15	15	
The display unit is shipped with a 10A fuse (F1351) fitted in the fuse holder on the rear panel. This fuse is for use with 12VDC power supply. For 24VDC or 32VDC power supplies, please exchange the fuse with the 5A fuse supplied.											
<b>CHECKING THE INSTALLATION</b>						6-9	6-9	15	15	15	
☐ 8) Check that fuse F1351 on the rear panel is 10A (for 12Vdc) or 5A (for 24/32Vdc).											

## FEATURES

The FR-7010D has a large variety of functions, all contained in a rugged plastic case.

All controls respond immediately to the operator's command and each time a touchpad is depressed, the corresponding change can be seen on the screen.

- \* Daylight viewing radar specially designed for small craft and sailing yachts.
- \* Traditional FURUNO reliability and quality in a compact, lightweight and low-cost radar.
- \* Newly designed compact and lightweight radome antenna with precision 54cm center-fed radiator.
- \* High definition 12" raster-scan display.
- \* 4 levels of target quantization for high target definition without problems associated with single-level quantization systems.
- \* On-screen alpha-numeric readout of all operational information.
- \* 8 ranges from 0.25 to 24 nm.
- \* 3 pulselengths and pulse repetition rates automatically selected, for optimum short-range to long-range performance.
- \* Guard zone alarm, for use as an anti-collision aid, provided as standard feature.
- \* EBL (Electronic Bearing Line), VRM (Variable Range Marker), Guard Alarm, x2 Zoom, Shift, Cursor and the cross-hair are controlled by a trackball.
- \* Operates on 10.2 to 40.0VDC power supply and consumes only 50W. Protection against reverse polarity and excessive voltage provided.
- \* Ship's position in latitude/longitude, ship's speed and range/bearing to a waypoint optionally shown in the bottom text area from external navigator having NMEA 0183 (or FURUNO CIF) output format.

## SPECIFICATIONS OF FR-7010D

### SCANNER UNIT

1. Radiator: Slotted Waveguide Array (housed in radome)
2. Radiator Length: 54cm
3. Horizontal Beamwidth: 4°
4. Vertical Beamwidth: 25°
5. Sidelobe Attenuation:
  - Within + 20° of mainlobe: -18dB or less
  - Outside + 20° of mainlobe: -23dB or less
6. Polarization: Horizontal
7. Antenna Rotation: 24 r.p.m. nominal

### TRANSCIVER MODULE (contained in radome)

1. Transmitting Tube: Magnetron 9M302/E3513
2. Frequency & Modulation: 9410MHz ± 30MHz, PON
3. Peak Output Power: 3kW nominal
4. Pulselength & Pulse Repetition Rate:

Item \ Range (nm)	0.25	0.5	0.75	1.5	3	6	12	24
Pulse Repetition Rate	Approx. 2100Hz			Approx. 1200Hz			Approx. 600Hz	
Pulselength	0.08us (Short)			0.3us (Mid.)			0.8us (Long)	

5. Modulator: FET Switching Method
6. I.F.: 60MHz
7. Tuning: Manual
8. Receiver Front End: MIC (Microwave IC)
9. Bandwidth: 7MHz (short/mid. pulses)  
3MHz (long pulse)
10. Duplexer: Circulator with diode limiter

### DISPLAY UNIT

1. Indication System: Raster scan, Daylight display
2. Picture Tube: 12-inch rectangular CRT

3. Range (nm):	0.25	0.5	0.75	1.5	3	6	12	24
4. Range Ring Interval (nm):	0.05	0.1	0.25	0.25	0.5	1	2	4
5. Number of Rings:	5	5	3	6	6	6	6	6

6. Bearing Resolution: 4.5°
7. Bearing Accuracy: Better than 1°

8. Minimum Range: Better than 29m  
 9. Range Ring Accuracy: 0.9% or 8m, whichever is the greater.  
 10. VRM Accuracy: 0.9% or 8m, whichever is the greater.  
 11. Mark Indication: Heading Mark, Bearing Scale, Range Ring, VRM, EBL, Tuning Bar, Cursor, Alarm Zone, Cross-Hair, WP Mark (Option)  
 12. Numeral/Character Indication: Range, Range Ring Interval, EBL, VRM, Interference Rejection (IR), ST-BY, Rain Clutter Rejection (FTC), Echo Stretch (ES), Radar Alarm (GUARD), Plotting Interval/Timer, Bearing/Range to Cross-Hair (I), ZOOM, GYRO (Option), Nav Data (Option)  
 13. Interference Rejector: Built-in

ENVIRONMENT CONDITION

1. Vibration:
- | Vibration Freq. | Total Amplitude |
|-----------------|-----------------|
| 1 to 12.5 Hz    | + 1.6 mm        |
| 12.5 to 25 Hz   | + 0.38 mm       |
| 25 to 50 Hz     | + 0.10 mm       |
2. Ambient Temperature: Scanner Unit ----- -25°C to +70°C  
 Display Unit ----- -15°C to +55°C  
 3. Humidity: Relative humidity, 95% or less at +40°C

POWER SUPPLY & POWER CONSUMPTION

10.2VDC - 40.0VDC, 50W  
 100/110/220/230VAC, 50/60Hz, 1ϕ (rectifier required)

COMPASS SAFE DISTANCE

	Standard Compass	Steering Compass
Display Unit	0.8 m	0.6 m
Scanner Unit	3.1 m	1.75 m

COMPLETE SET:

No.	Name	Type	Code No.	Q'ty	Remarks
1	Scanner Unit	RSB-0034	000-083-691	1	8 kg
2	Display Unit	RDP-079-S	000-088-611	1	12.5 kg
3	Installation Materials	CP03-06400	000-083-066	1 set	w/10m Sig. Cable Assy.
4	Accessories	FP03-03310	000-080-914	1 set	
5	Spare Parts	SP03-05300	000-080-915	1 set	

INSTALLATION MATERIALS:

No.	Name	Type	Code No.	Q'ty	Remarks
1	Plug	HS16P-2	000-503-281	1	For Power cable
2	Signal Cable Assy. (10m)	S03-21-10	008-239-050		Select one. Connectors fitted.
	Signal Cable Assy. (15m)	S03-21-15	008-239-060		
	Signal Cable Assy. (20m)	S03-21-20	008-239-070		
	Signal Cable Assy. (30m)	S03-21-30	008-239-080		
3	Slotted Hex. Bolt	M10x25 SUS304	000-862-308	4	For Scanner Unit Mounting
4	Flat Washer	M10 SUS304	000-864-131	4	
5	Spring Washer	M10 SUS304	000-864-261	4	

ACCESSORIES:

No.	Name	Type	Code No.	Q'ty	Remarks
1	Hood Assy.	FP03-02910	008-233-520	1	
2	Filter	FP03-02920	008-224-760	1	

SPARE PARTS:

No.	Name	Type	Code No.	Q'ty	Remarks
1	Fuse	FGBO 10A 125VAC	000-549-065	2	
2	Label	03-038-1033	100-105-600	1	For bulkhead or overhead mount
3	Spare Parts Box		000-831-610	1	

OPTION:

No.	Name	Type	Code No.	Q'ty	Remarks
1	Rectifier	RU-3423	000-030-443	1	for AC mains
2	External Buzzer	OP03-21	000-030-097	1	
3	Power Cable	VV-S 2.0x2C	000-104-818	1	5m
4	Dust Cover	03-038-9001	000-801-826	1	For display unit
5	NMEA Cable	22S0021	000-109-517	1	Connector fitted, 5m
6	Gyro Cable	22S0022	000-109-506	1	Connector fitted, 8m
7	X-Band MIC	RU-8014	000-115-556	1	RF amp built in.
8	Antenna Bracket			1	For sailboat

## PRINCIPLE OF OPERATION

The term "RADAR" is an acronym meaning RAdio Detection And Ranging. Although the basic principles of radar were developed during World War II, primarily by scientists in Great Britain and the United States, the use of echoes as an aid to navigation is not a new development.

Before the invention of radar, when running in fog near a rugged shoreline, ships would sound a short blast on their whistles, fire a shot, or strike a bell. The time between the origination of the sound and the returning of the echo indicated how far the ship was from the cliffs or the shore. The direction from which the echo was heard indicated the relative bearing of the shore.

Today, the method of determining the distance to a target is much more accurate because of pulse-modulated radar. Pulse-modulated radar determines the distance to the target by calculating the time difference between the transmission of a radar signal and the reception of the reflected echo. It is a known fact that radar waves travel at a nearly constant speed of 162,000 nautical miles per second. Therefore the time required for a transmitted signal to travel to the target and return as an echo to the source is a measure of the distance to the target. Note that the echo makes a complete round trip, but only half the time of travel is needed to determine the one-way distance to the target. This radar automatically takes this into account in making the range calculation.

The bearing to a target found by the radar is determined by the direction in which the radar scanner antenna is pointing when it emits an electronic pulse and then receives a returning echo. Each time the scanner rotates pulses are transmitted in the full 360° circle, each pulse at a slightly different bearing from the previous one. Therefore, if we know the direction in which the signal is sent out we know the direction from which the echo must return.

Note that the speed of the radar waves out to the target and back again as echoes is extremely fast compared to the speed of rotation of the antenna. By the time radar echoes have returned to the scanner, the amount of scanner rotation after initial transmission of the radar pulse is extremely small.

The range and bearing of a target is displayed on what is called a Plan Position Indicator or PPI. This display is essentially a polar diagram, with the transmitting ship's position at the center. Images of target echoes (sometimes called a "pip") are received and displayed at their relative bearings, and at their distance from the PPI center. With a continuous display of the images of targets, the motion of the transmitting ship is also displayed.

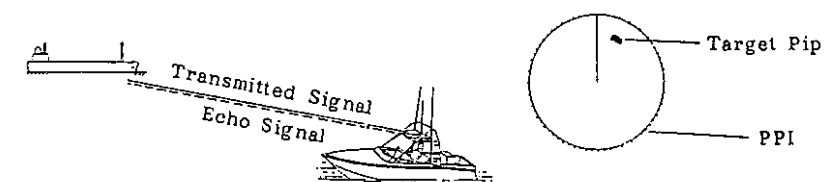

Fig.1 How Radar Works

## INSTALLATION

As was pointed out in the Introduction to this manual, this machine can do its intended functions only if it is installed properly.

### GENERAL MOUNTING CONSIDERATIONS

This radar consists of two units: the Display Unit and the Scanner Unit. The scanner unit has been designed to withstand all the rigors of the marine environment, and if installed properly, is thoroughly waterproof. A "domed" type of scanner unit, where the scanner mechanism is enclosed in a thermoplastic resin dome, ensures that halyards and other rigging won't get tangled up in the rotating scanner.

The display unit is carefully constructed to be able to withstand the humidity and corrosive atmosphere common in a pilothouse, but it is not designed to be used outside, directly exposed to the environment! Salt water spray will most assuredly cause damage to the sensitive components inside. Keep these factors in mind when planning the installation of the display unit.

Many owners will undoubtedly use this radar on small boats. The display unit may be mounted inside an enclosed cabinet. Corrosion can occur, especially on the rear connectors exposed to salt spray, unless these are taped and thoroughly sealed with putty compounds made especially for this purpose. Most small boats are equipped with such an enclosed cabinet, and most have clear doors so that equipment may be seen behind them.

The display unit consumes only a moderate amount of power, so there is no need for forced air ventilation. However it is necessary to provide adequate space behind and around the display unit to allow some circulation of cooling air and to provide convenient access to the rear connectors.

Even though the picture is quite legible even in bright sunlight, it is a good idea to keep the display unit out of direct sunlight or at least shaded because of heat that can build up inside the cabinet.

### DETAILED INSTRUCTIONS

#### SCANNER UNIT INSTALLATION

The scanner unit is completely watertight when installed correctly. It should be placed where there is a good all-round view with, as far as possible, no part of the ship's superstructure or rigging intercepting the scanning beam. Any obstructions will cause shadow and blind sectors. A mast, for instance, with a diameter considerably less than the width of the scanner, will cause only a small blind sector, but a horizontal spreader or crosstrees in the same horizontal plane as the scanner unit would be a much more serious obstruction and the scanner unit would need to be placed well below or above it.

It is rarely possible to place the scanner unit where a completely clear view in all directions can be obtained. Thus, the angular width and relative bearing of any shadow sectors should be determined for their influence on the radar at the first opportunity after fitting. (The method of determining shadow and blind sectors is shown later in this section.)

The scanner unit should be generally mounted as high as possible on the boat to ensure best performance at the maximum range. But this is perhaps not as important as might be supposed for a small boat. For example, increasing the height from 10 feet to 13 feet off the water won't net very much if you are looking for another boat which also only rises 10 feet off the water. Doing so would increase the range capability from 7.7 nautical miles to 8.3 nautical miles, an increase that may not be worth the serviceability problems involved in mounting the scanner higher on the boat.

In addition, if your boat is equipped with a radio direction finder, its antenna should not be positioned in close proximity to the scanner unit, since the DF would be adversely affected. A separation of more than 2 meters is recommended.

The compass safe distance (3.1m (10.17 feet) standard compass and 1.75m (5.74 feet) steering compass) should be also observed. If the distance is not enough, deviation of the magnetic compass will result.

On a sailboat, the scanner unit is normally mounted up on the mast. An antenna bracket may be optionally supplied to mount it with ease. See page 10. On power boats, it is usually installed on a framework above the flying bridge. However, in many cases, the unit can be installed directly on the top of the wheelhouse near the ship's centerline.

When this radar is to be installed on larger vessels, take care to consider the following points.

1) The interconnection cable is run between the scanner unit and the display unit. If additional interconnection cable is required for a particular installation, an unbroken length of cable must be used (i.e., no splices allowed!), and maximum length of the interconnection cable is 30 meters. On a sailboat where it will be necessary to step the mast for maintenance, a junction box may be installed at the base of the mast, under the floorboards. The junction box must be watertight and the wire breakout must be kept as short as possible.

2) Deposits and fumes from a funnel or other exhaust vents can adversely affect the performance of the antenna, since hot gases may warp the radome. The scanner unit must not be mounted in a position where it may be subjected to temperatures in excess of 70°C (158°F.)

The figure below shows typical scanner unit placement.

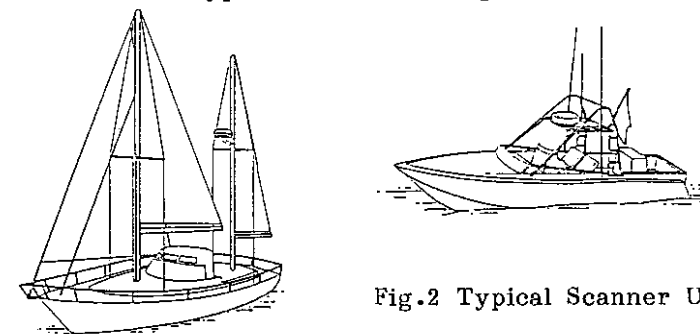

Fig.2 Typical Scanner Unit Placement

### Scanner Unit Preparation:

After deciding the location of the scanner unit, preparation of the scanner unit is necessary. Use the following procedure.

1. Open the radome package carefully. Remove the four M10 bolts together with spring and flat washers on the bottom of the radome base assembly. These bolts, spring and flat washers may be discarded, but do not use the bolts in step 4.

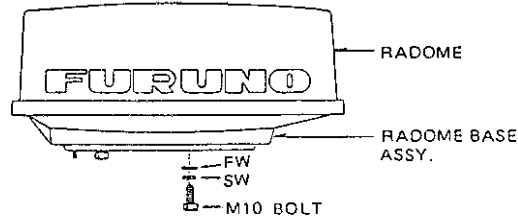

Fig.3 Preparing the Radome Base for Mounting

2. Unbolt the four fixing bolts used to hold the white radome cover to the blue radome base and carefully lift the radome up. Remove the antenna stoppers. This will release the antenna from its shipping preparation position, and allow it to rotate freely.

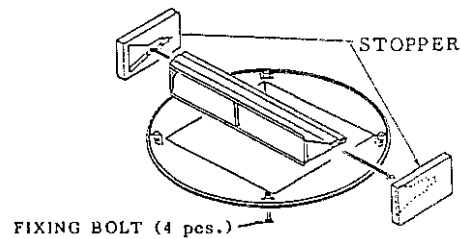

Fig.4 Removing the Radome Cover

### Scanner Unit Mounting:

The mounting surface must be parallel with the ship's waterline and provided with six holes whose dimensions are shown in Fig.5: Four 12mm (1/2") holes for fixing, one 27mm (1.1") hole for the cable entry, and one 20mm (3/4") hole for the vent tube.

There is a vent tube on the base of the scanner unit which should face the stern direction. The unit is adjusted so that a target echo returned from the bow direction will be shown on the 0° (Heading Marker) position on the screen. When drilling holes, take care that the holes are parallel with the fore and aft line.

In very hot and humid climates, moisture may condense inside the radome, causing corrosion. To prevent this, the vent tube is fitted. This tube is designed to allow the radome to "breathe" while not allowing entry of water from outside into the radome. Therefore, make sure the tube is kept free of foreign materials and is not pinched or kinked. The vent tube extends downward by 27mm (1.1") from the radome base. Ensure the vent tube extends downward before installing the radome. See Fig.6.

3. Now install the radome base on the platform having 5-10mm (1/5"-2/5") in thickness. Find the vent tube on the radome base. Next, position the radome base so that the vent tube faces the stern direction. This alignment should be carried out as accurately as possible.

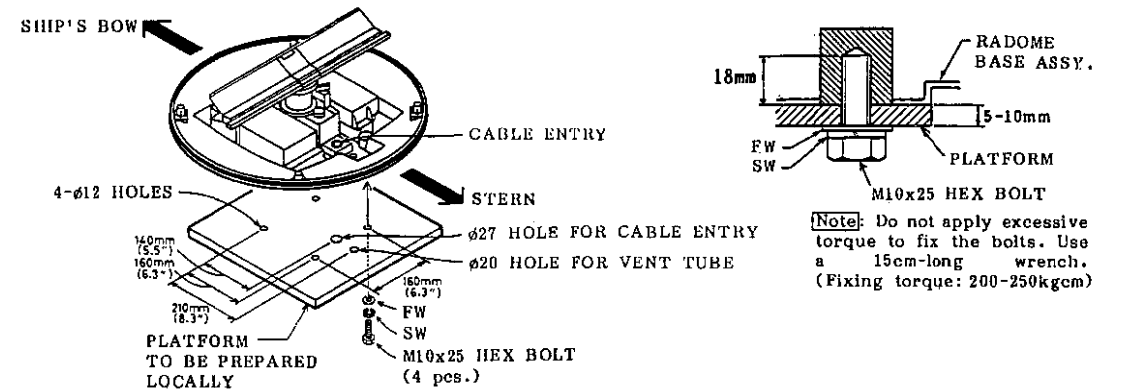

Fig.5 Installing the Scanner Unit

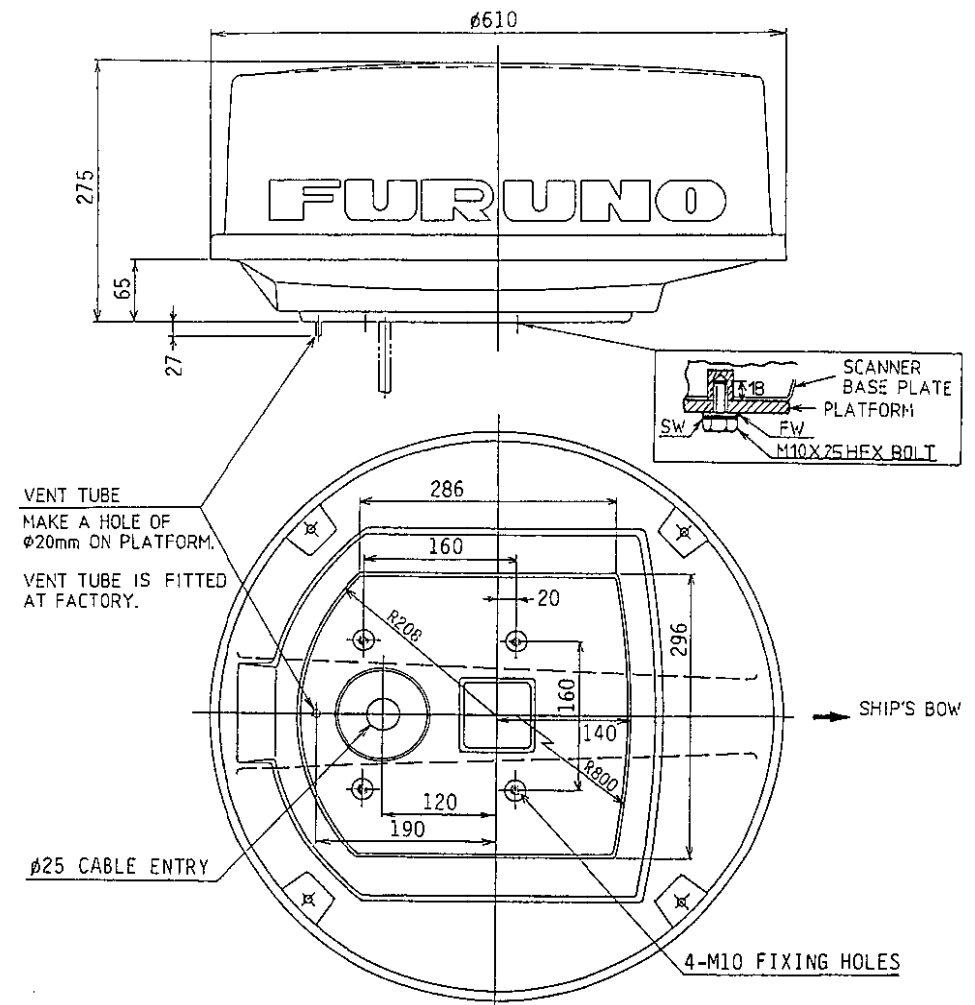

Fig.6 Scanner Unit Outline Drawing

Weight : 8kg

4. After making sure that the vent tube is in the correct position, fix the radome base to the mounting surface with the four M10 x 25 hex bolts, flat and spring washers supplied as the installation materials.



## Optional Antenna Bracket Installation For Sailboat

### (A) Setting Up Antenna Bracket

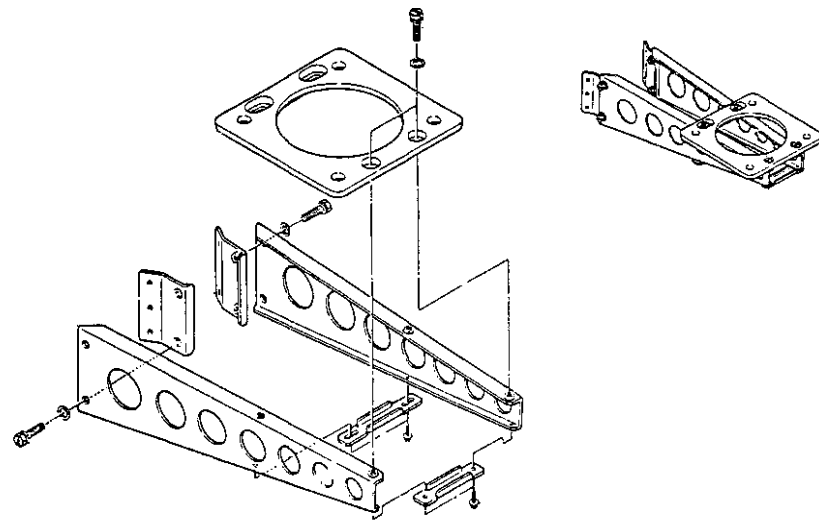

### (B) Fixing Radome To Platform

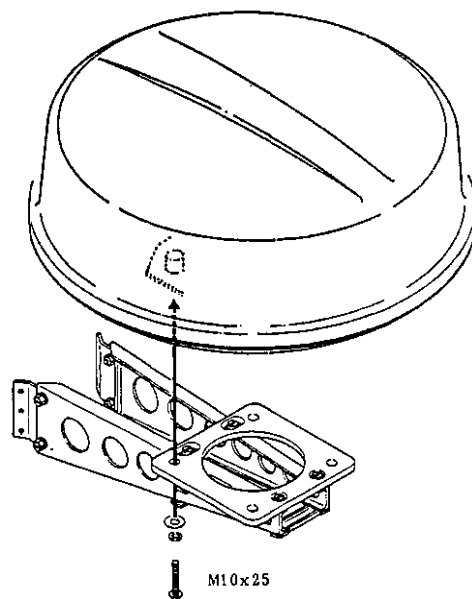

## Wiring and Final Preparation of Scanner Unit:

- Run the interconnection cable from the display unit to the scanner unit. A hole of at least 20mm (3/4") dia. must be drilled through the deck or bulkhead for cable entry. After the cable is passed through the hole, a sealing compound should be applied to this hole for waterproofing.

In order to minimize the chance of picking up electrical interference, avoid where possible routing the interconnection cable near other onboard electrical equipment. Also avoid running the cable in parallel with power cables.

- Remove the cable clamping plate by loosening four M4 screws and two gaskets at the radome base. See Fig.7.
- Pass the cable through the hole at the bottom of the radome base. Three plugs are provided on the end of the interconnection cable for connection inside the scanner unit.

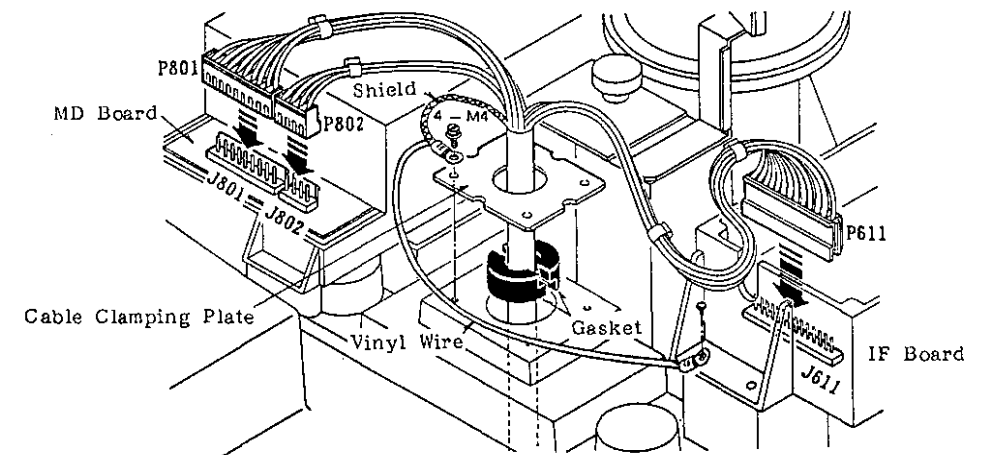

Fig.7 Cable Connection and Grounding

- Secure the cable with the cable clamping plate and gaskets. Ground the shield and vinyl cables by using one of the fixing screws for the cable clamping plate and for the IF amp. chassis. See Fig.7.
- Mate the two plugs (9 and 4 ways) to the MD board. Remove the lid of the IF board and mate the plug (14 ways), referring to Fig.7.
- Put the radome on the radome base assembly, taking note of that the narrower recessed part should face in the direction of the bow. Fig.8.

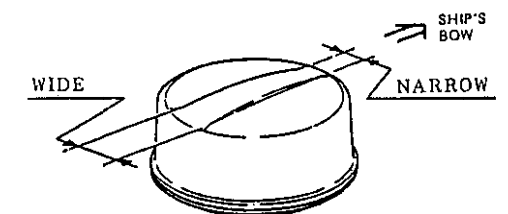

Fig.8 Radome Cover Placement

- Tighten the radome fixing bolts temporarily, because it may have to be opened again for adjustment after installation.

## DISPLAY UNIT INSTALLATION

Locate the display unit in a position where it can be viewed and operated conveniently but where there is no danger of salt or fresh water spray or immersion.

**Compass Safe Distance;** The magnetic compass may be affected if the display unit is placed too close, because of fields generated in the radar. The compass safe distance (approximately 0.8m (2.63feet) standard compass and approximately 0.6m (1.97feet) steering compass) must not be disregarded.

The orientation of the display unit should be so that the radar screen is viewed while the operator is facing in the direction of the bow. This makes determination of your position much easier.

The mount can be installed either on a tabletop, on a bulkhead or on an overhead. The mounting dimensions for this unit are shown on page D-1. You can use the mounting cradle itself as template for marking the mounting bolt holes. Since the unit weights 12.5 kg reinforce the mounting place, if necessary.

Make sure you allow enough clearance to get to the connectors behind the unit. Leave at least a foot or so of "service loop" of cables behind the unit so that it can be pulled forward for servicing or easy removal of the connectors. The recommended clearances for servicing ease are given on page D-1.

### Tabletop Mounting:

1. Remove two M8x40 bolts fixing the display unit to the mounting cradle.
2. Drill four mounting holes (12mm dia.) through the tabletop.
3. Secure the mounting cradle to the tabletop by using M10 bolts, nuts and washers. 9mm radius coach screws may be substituted for the M10 bolts.
4. Place the display unit on the mounting cradle and secure them at the front of the display unit with two bolts removed at step 1.

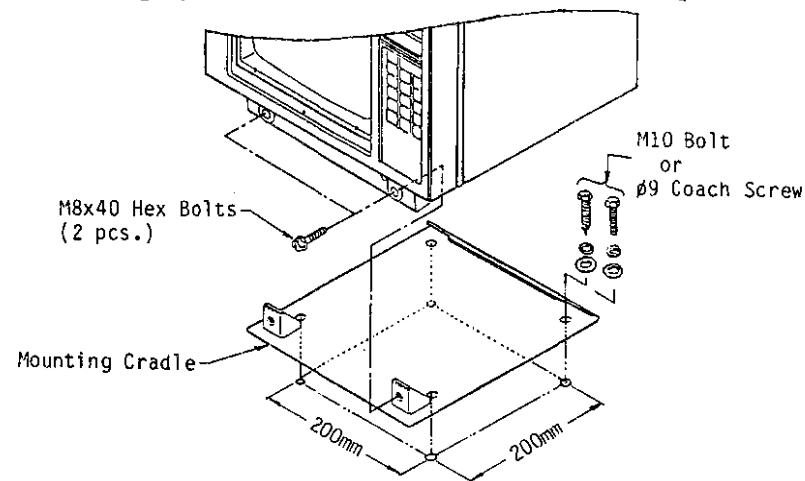

Fig.9 Tabletop Mounting

### Bulkhead/Overhead Mounting:

1. Take the top cover off by loosening six M4x10 cosmetic screws.
2. Loosen two M8x40 hex bolts at the front of the display unit, and the mounting cradle comes free. Secure the mounting cradle to the bulkhead/overhead.
3. After disconnecting flying connector P/J1354, loosen four M6x16 hex bolts and separate the ramp base with the bottom plate from the display unit.
4. Loosen four M3x6 screws to separate the bottom plate from the ramp base.
5. Loosen the lock nut for the SCANNER switch on the ramp base and turn the switch upside down. Secure the lock nut. Attach the label supplied as spare parts to the ramp base.
6. Refix the bottom plate to the ramp base.
7. Connect the flying connector, and fix the ramp base to the top of the display unit with four M6x16 hex bolts removed in step 3.
8. Fix the top cover to the bottom of the display unit.
9. Fix the unit to the mounting cradle.

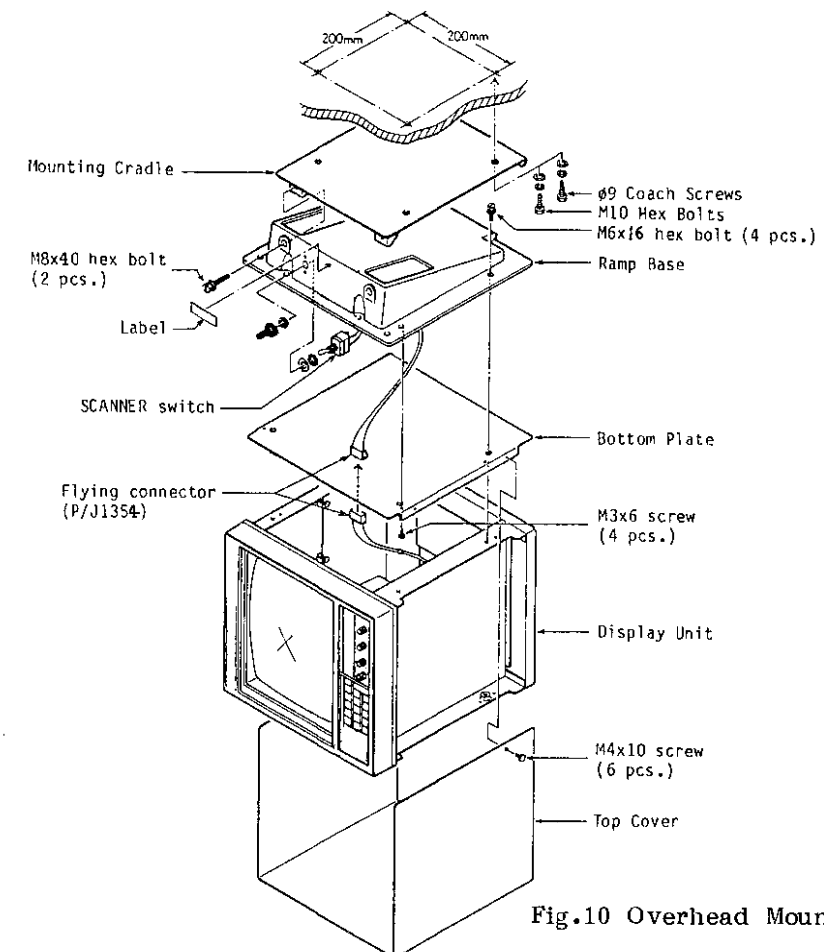

Fig.10 Overhead Mounting

Now comes the wiring part. The only wiring necessary is for power connection and the interconnection cable.

### Antenna Connection

The interconnection cable from the scanner unit is connected to the back of the display unit.

### Power Connection

This radar is designed for 12, 24 or 32 volt battery systems. No internal wiring changes are needed for input voltages from 10.2 to 40.0Vdc. A piece of gear of this quality deserves to have a circuit breaker dedicated to it alone. The size of the wire feeding power to the unit should be no less than AWG #14 (2.0mm square.) Refer to the figure below for assembly of the power connector supplied as the installation materials.

- 1) Strip off 35mm of the vinyl sheath, taking care not to nick the shielding mesh, and slide the mesh back.
- 2) Strip off 10mm of the inner sheath, and remove about 3mm of the insulation from both ends of the lead wires.
- 3) Slide connector's housing over the cable.
- 4) Solder the lead wires to the connector, taking note of the polarity, i.e., #1 (+) and #2 (-).
- 5) Assemble the connector, and tighten two set screws.
- 6) Fold back the shielding mesh and clamp the connector over top of it.
- 7) Wrap the mesh with vinyl tape.

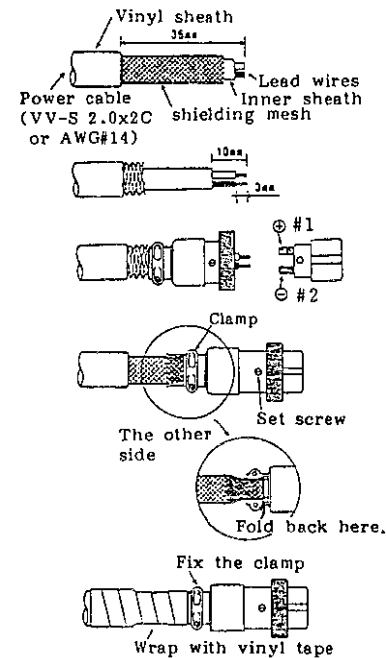

Fig.11 Power Connector Assy.

### Ground Connection

Run heavy duty ground wire from the grounding terminal at the rear panel of the display unit to the nearest grounding point on the boat.

Follow the drawing below for detailed wiring information.

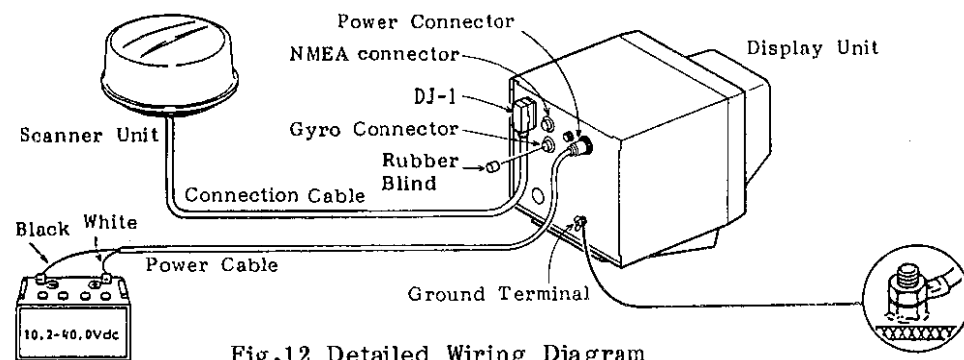

Fig.12 Detailed Wiring Diagram

### Gyrocompass Connection (Option)

If an AC synchro or DC step type gyrocompass is installed on your boat, the true bearing of your ship's heading, of the cross-hair, and of the EBL (Electronic Bearing Line) may be seen on the radar display.

A gyro cable fabricated with a connector and an A-D Converter AD-10S are optionally supplied. Remove the gyro connector cap on the rear panel, and a jack may be seen. Mate the connector with this jack. Fabrication of the other end of the cable and connection to the A-D Converter are given in the Operator's Manual for AD-10S (Publication No. OM-E4280.)

### External Navigational Receiver Connection (Option)

If your navigation receiver has NMEA 0183 (or FURUNO CIF) format, the own ship's position in latitude/longitude, ship's speed and the range/bearing to waypoint may be sent to this radar, and be seen in the bottom text area.

An NMEA cable fabricated with a connector is optionally supplied. Remove the NMEA connector cap on the rear panel, and a jack for NMEA 0183 may be seen. Mate the connector with this jack. Fabrication of the other end of the connection cable should be left to a competent service technician, because it is difficult to find the point to be connected.

[For service technician] J1352 #1, #2 : No connection  
 J1352 #3 : RD-Hot  
 J1352 #4 : RD-Cold

### CHECKING THE INSTALLATION





After completing the installation, it is a good idea to recheck to ensure that all the steps of the installation were accomplished in accordance with the instructions. Use the following check list.

Table 1 Installation Check List

Check Items	Tick here.
1) The vent tube on the radome base is on the side of the stern direction correctly.	<input type="checkbox"/>
2) Four radome base fixing bolts are fully tightened.	<input type="checkbox"/>
3) The connection cable is waterproof at the radome base.	<input type="checkbox"/>
4) The cable is securely retained against the mast or mounting and is free of interference from running rigging.	<input type="checkbox"/>
5) Check that the cable gland or entry on the deck is waterproof, if provided.	<input type="checkbox"/>
6) The power connections to the battery are of correct polarity.	<input type="checkbox"/>
7) Check that the plugs at the rear of the display are inserted correctly and are secure.	<input type="checkbox"/>
8) Carry out the following adjustment after the above checks.	<input type="checkbox"/>

Now is the time to turn on the unit and carry out the necessary tuning and presetting adjustments.

### INITIAL PROCEDURES

1. Press the  touchpad on the display unit, and the control panel will light up. In approximately 2 minutes and 30 seconds, the message "ST-BY" will appear at center of the screen. While this warmup is in process, pry off the VR panel on the front panel of the display unit. See Fig.19. This will expose the potentiometers for post installation adjustments. Push in the front panel TUNE control and release it to bring it out. Set the control to 12 o'clock, the GAIN control at 2 o'clock, and the A/C RAIN and A/C SEA controls at fully counterclockwise.
2. When the screen indicates "ST-BY" press the  touchpad. The radar will start transmitting on the 3-mile range, and you will probably see a number of targets around you, even though the gain, tuning and other adjustments have yet to be optimized.
3. Press the  touchpad three times so that the radar is on the 24-mile range. Bring up the GAIN control until a small amount of noise appears on the screen. At this point, unless the tuning just happens to be at the optimum point, slowly adjust the coarse "TUNE" control accessible through the VR panel, watching the screen for radar targets. (See Fig.19.) You must patiently adjust this coarse-tuning control in very small increments, allowing the sweep to go around completely in order to observe the effect of a single small change in its setting. When you are finished optimizing the coarse tuning control behind the VR panel, verify that the fine TUNE control on the front panel peaks up for maximum radar echoes at 12 o'clock, or at least close to that point.
4. Adjust the GAIN control on the front panel, for a little background noise showing on the screen, and then hit the  touchpad several times to bring you down to the 0.25-mile range. Without disturbing the front panel GAIN control, adjust the A/C SEA control until nearby radar targets are clearly shown on the screen. Too much A/C SEA action will eliminate small targets, and too little A/C SEA action will cause the screen to be so full of targets and noise that it is hard to determine which target is which as compared to visual sightings. Note that adjusting the GAIN and A/C SEA controls in this manner (GAIN at long range, A/C SEA at short range) will equalize the picture at all ranges, and you will not have to jockey back and forth with the GAIN control especially when you change range scales.

### RELATIVE BEARING ALIGNMENT

You have mounted the scanner unit facing straight ahead in the direction of the bow. Therefore, a small but conspicuous target dead ahead visually should appear on the heading mark (Zero degree).

In practice, you will probably observe some small error on the display for most installations because of the difficulty in achieving accurate initial positioning of the scanner unit. The following adjustment will compensate for this error. If you don't know how to do it well, it's best you leave this part to a competent service technician. (Remember that the top radome fixing bolts remain untightened. They should now be secured if the following alignment is not necessary.)

1. Identify a suitable target (e.g., ship or buoy) at a range between 1/8 to 1/4 miles, preferably located on or around the heading mark. To minimize errors of bearing you should generally keep echoes in the outer half of the picture by changing the range scale.

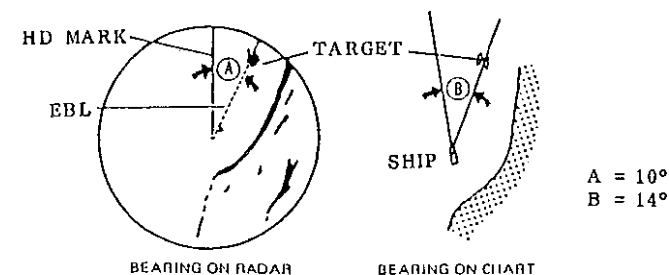



Fig.13 Relative Bearing Alignment

(When the relative bearing of a target measured on the radar screen (A) does not agree with that measured on the navigation chart (B).)

2. Move the cross-hair with the trackball so that the intersection of the cross-hair bisects the center of the target, and press the  touchpad.
3. Read the EBL bearing at the bottom left on the screen.
4. Find the relative bearing to the target from the ship's bow visually, using a pelorus.
5. Compare the bearing measured in step 3 and 4 above, and calculate the direction and magnitude of the bearing error. If the error is within  $\pm 5^\circ$ , adjust rotary code switch S1 ("HEAD", clockwise rotation shifts the picture CW, Fig.19.)
6. If the error is more than  $\pm 5^\circ$ , set S1 to "0" and then adjust the position of heading mark key S801 (Fig.20) located inside the scanner unit.
7. Remove the radome and slightly loosen the two screws which secure the heading mark key mounting plate. If the screws are loosened excessively, fine adjustment will be more difficult.
8. Adjust the position of the heading mark key, moving to the aft (or fore) direction if the bearing "A" is greater (or smaller) than "B", respectively.
9. Adjust S1 at the display unit as in step 5.
10. After adjustment, tighten the heading mark key fixing screws securely.
11. Install the radome on the radome base assembly, being careful of its direction. The narrower recessed part should face the bow direction. See Fig.8.
12. Tighten the radome fixing bolts securely.
13. As a final test, move the boat towards a small buoy and ensure that the buoy shows up dead ahead on the radar when it is visually dead ahead.

## SWEEP TIMING ADJUSTMENT

This adjustment is carried out to ensure proper radar performance, especially on short ranges. The radar measures the time required for a transmitted echo travel to the target and return to the source, and the received echo is displayed on the CRT based on this time. Thus, at the instant the transmitter is fired, the "Sweep" should start from the center of the CRT (sometimes called sweep origin.)

A "trigger" pulse generated in the display unit is sent to the scanner unit through the interconnection cable to trigger the transmitter (magnetron.) The time taken by the signal to travel up to the scanner unit varies, depending largely on the length of interconnection cable. During this period the display unit should wait before starting the sweep. When the display unit is not adjusted correctly, the echoes from a straight local object, e.g., a harbor wall, straight pier, etc. will not appear with straight edges -- i.e., they will be seen as "pushed out" or "pulled in" near the picture center. The range of objects will also be incorrectly shown. Therefore, the following adjustment should be carried out after installation.

### Procedure

1. Set the unit at 0.25 nm range and adjust the GAIN and A/C SEA controls properly.
2. Visually, select a straight object, e.g., a harbor wall, straight pier, etc.
3. Adjust the "TIMING" potentiometer (VR6, Fig.19) so that a straight object will appear straight with no "pushing" or "pulling" near the picture center.



(A) improper, pulling inward



(B) proper



(C) improper, pushing outward

Fig.14 Sweep Timing Adjustment

## PRESET GAIN ADJUSTMENT

Preset gain is preadjusted at the factory. However if the receiver gain is too high or low, adjust it again.

### Procedure

1. Set the controls: : max. range; GAIN: fully CW (max.); A/C RAIN and A/C SEA: fully CCW (min.); : off; : off; : off, and : on.
2. Set VR4 at the position where a little background noise appears on the screen. See Fig.19 for the location of VR4.
3. Confirm that the noise increases when the IR circuit is not activated. ( touchpad: off)

## TUNING & TUNING INDICATOR SENSITIVITY ADJUSTMENT

Tuning and its indicator sensitivity are preadjusted at the factory. However if the best tuning condition is not obtained with the TUNE control set at its mid-travel, execute the following procedure.

### Procedure

1. Transmit the radar on maximum range (long range) with the TUNE control set at its mid-travel and wait about 10 minutes for magnetron oscillation to stabilize.
2. Adjust potentiometer VR1 ("TUNE", Fig.19), located behind the VR panel of the display unit, so that a comparatively weak long range echo is discerned with maximum definition.
3. Adjust potentiometer VR8 ("PEAK", Fig.19) for the maximum number of tuning bars.
4. If all the tuning bars light up, turn potentiometer VR7 ("IND") CCW so that about four bars light up, and then adjust VR8 ("PEAK") as in step 3.
5. Adjust VR7 ("IND") so that the fifth tuning bar lights up.

## PANEL ILLUMINATION ADJUSTMENT

The illumination of the touchpad panel can be adjusted to suit your needs, by adjusting the "DIM" potentiometer (VR5) located behind the VR panel of the display unit. See Fig.19 for the location of VR5.

## A/C SEA ADJUSTMENT

A/C SEA is preadjusted at the factory. However if the following conditions are not satisfied with the A/C SEA control, adjust potentiometer VR3 ("A/C SEA"), located behind the VR panel of the display unit (Fig.19.)

### Procedure

1. Transmit the radar on 12-mile range and adjust the TUNE control.
2. Set the controls: : off; : off; : off; : on; A/C SEA: fully CCW (min.); A/C RAIN: fully CCW (min.)
3. Adjust the GAIN control on the front panel so that a small amount of background noise appears on the screen.
4. Turn the A/C SEA control fully CW and confirm that no background noise appears in the range of 0 to 3 nm (min.) or 0 to 6 nm (max.)

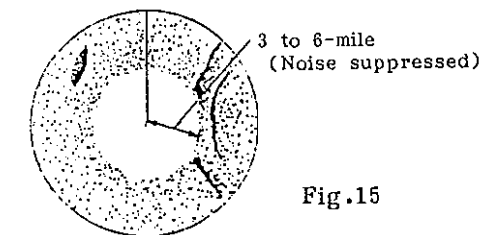





Fig.15

## A/C RAIN ADJUSTMENT

A/C RAIN is preadjusted at the factory. However if the following conditions are not satisfied with the A/C RAIN control, adjust potentiometer VR2 ("RAIN"), located behind the VR panel of the display unit (Fig.19.)

### Procedure

1. Transmit the radar on 24-mile range and adjust the TUNE control.
2. Set the controls: A/C RAIN: fully CW (max.); A/C SEA: fully CCW (min.);  : off;  : off;  : off;  : on
3. Adjust the GAIN control so that a small amount of background noise (rain clutter) appears on the screen.
4. Turn the A/C RAIN control fully CW and confirm that background noise (rain clutter) is effectively suppressed in the range of 0 to 12 nm (min.) or 0 to 20 nm (max.)

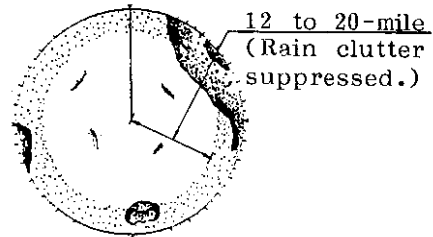

Fig.16

## MAGNETRON HEATER VOLTAGE ADJUSTMENT

Magnetron heater voltage is formed at the MD board of the scanner unit and preadjusted at the factory. Therefore no adjustment is required even though the cable length between the display unit and the scanner unit is changed. Execute the following procedure to confirm.

### Procedure

1. Suspend the antenna rotation by turning off the SCANNER switch.
2. Connect a multimeter, set to 10VDC range, between #4 (+) and #6 (-) of test point TP803 on the MD board. See Fig.20.
3. Confirm that the multimeter shows  $7.5V \pm 0.1V$ . If not, adjust potentiometer VR801 (Fig.20) on the MD board.

## MEASUREMENT OF BLIND SHADOW SECTORS

In some shadow sectors, it should be remembered that there may not be sufficient intensity to obtain an echo from very small targets even at close range, despite the fact that a large vessel may be detected at a much greater range in non-shadowed sectors. For these reasons the angular width and relative bearing of any shadow sectors should be determined. This section describes how to do this. In the case of a new vessel this should be done during sea trials. In other ships it should be done at the first opportunity after fitting a new radar set.

It should be realized that even a small shadow sector may hide another vessel if she is on a collision course. The bearing will remain constant in the shadow area and the approach of the other vessel may remain undetected until it is too late to avoid a dangerous situation.

Two methods of determining the angular width of a shadow sector are;

- 1) Turn the boat very slowly through  $360^\circ$  while a small but clearly defined target is observed at a distance of a mile or so. (Do not use a buoy with a reflector as this target is too powerful to achieve the required result.)

If the echo disappears while the boat is turning, the target has entered a shadow sector and it will again become visible when the target emerges from the shadow. Very quiet conditions of wind and sea are essential to ensure reliable results when this operation is carried out on a small craft since a rough sea can cause a buoy to be lost in the clutter or to be temporarily submerged or hidden by waves. An unsteady movement may cause the boat to swing through a shadow sector before the scanner has completed one revolution. In any case an average of several observations of each shadow sector should be taken. It is a waste of time to attempt the operation in anything other than very smooth water with little wind.

- 2) Another method is to observe the shadow sector against a background of sea clutter. Any shadows show as dark sectors in the clutter. See Fig.17.

Note that a shadow cannot be fairly estimated in heavy clutter, as echoes from either side of the sector may be spread into it and give an illusion that objects in the sector are being observed. Nor can it be satisfactorily determined in confined waters, because of the probability of indirect, false or multiple echoes being produced from nearby buildings or other vessels.



Shadow caused by mast

Fig.17 Appearance of a Shadow Sector on the Display Screen

The result of the above measurement should be recorded on a blind shadow sector diagram. Fig.18(B) is an example of a shadow sector diagram for the scanner unit sited as in Fig.18(A). The blind shadow sector diagram should be fixed near the display unit.

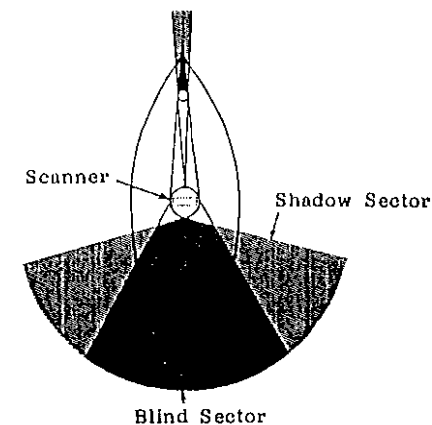

(A) Shadows caused by objections

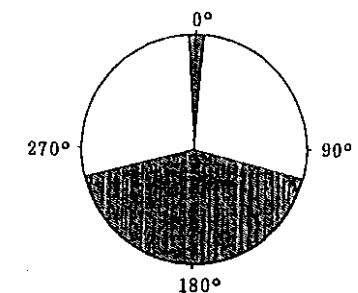

(B) Shadow Sector Diagram for Scanner sited as in left figure

Fig.18

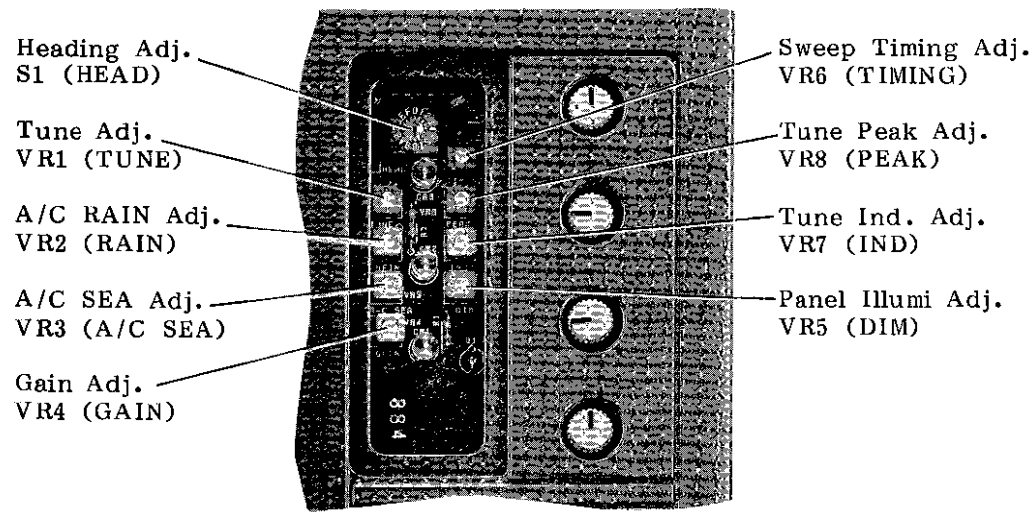

Potentiometer Compartment

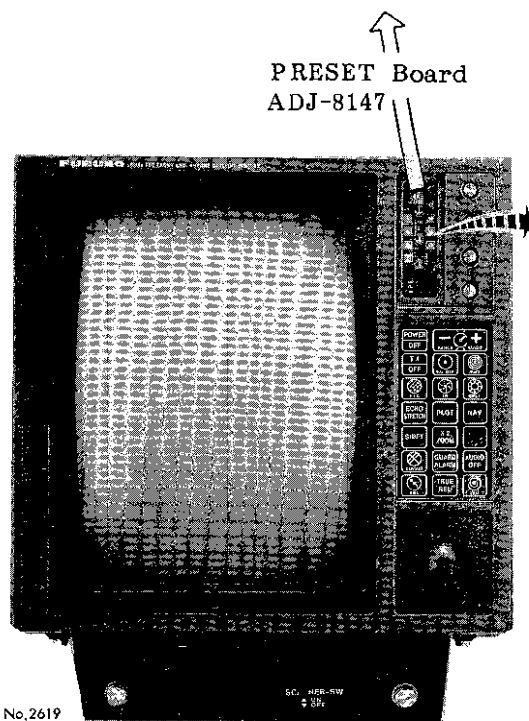

Fig.19 Display Unit with VR Panel Removed

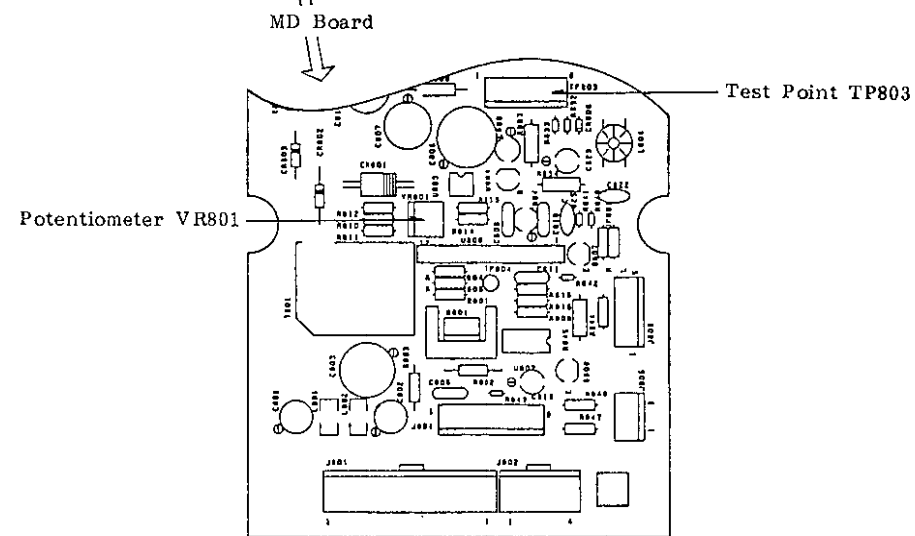
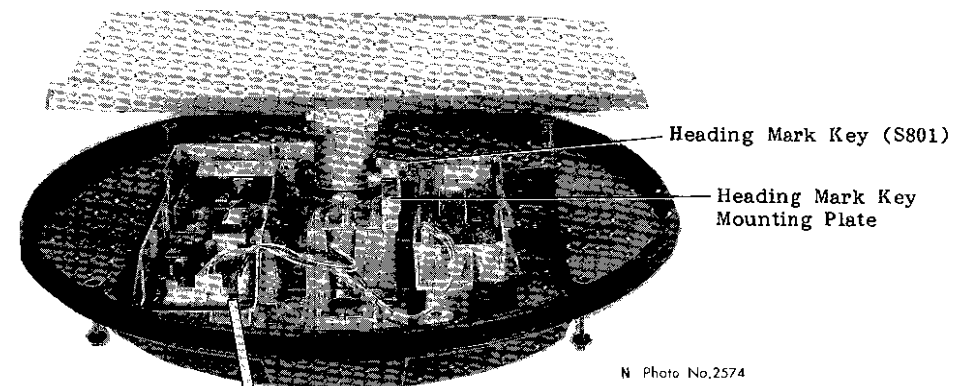

Fig.20 Scanner Unit

## OPERATIONAL OVERVIEW



### THE FRONT PANEL

This radar is basically very easy to operate. If you change a control setting you will see the associated reaction almost immediately on the screen. Most touchpads carry abbreviated names to show their functions. The same nomenclature appears on the screen for confirmation.











Examine the display unit. You will notice that most controls except for the SCANNER switch are on the right-hand side, and the CRT (display screen) is on the left-hand side.







The SCANNER switch is provided on the ramp base to turn on/off the scanner radiator. This switch is usually left "ON" except for field servicing. When turning it off, the radar stops transmitting and the message "ST-BY" (standby) appears on the screen.

The TUNE, A/C RAIN, A/C SEA, and GAIN controls are grouped together because they control the radar receiver. To prevent accidental alteration of the settings, all controls in this group may be locked by pushing in the control. When readjustment is necessary, push in and release the control to bring it out again.



























The  and  touchpads turn on/off power and transmission.

The  touchpads change the range scale in use.

The , , , , , , , ,  and  touchpads are mostly on/off controls. Adjusting the brightness of the CRT, reducing radar interference, and temporarily erasing the heading mark are some of the functions of this group of touchpads.

The , , , ,  and  touchpads are used with the trackball. The trackball, whose motion is followed by the cross-hair, is used to set an off-center position, set an expansion area, rotate the cursor, set a guard zone and measure a target's range and bearing. The function of these touchpads can be turned off by pressing and holding a corresponding touchpad for two to three seconds.

To familiarize yourself with the controls of your unit, turn it on (presuming that it has already been installed) and try operating some of the controls as you review this section. The controls described in "Turning the Unit On and Off" and "Setting Up" appear in the order they should be operated when turning on the radar.

-  : This control keeps the receiver tuned to the transmitter.
-  : Used to reduce precipitation clutter in drizzle. A/C RAIN stands for anti-clutter rain.
-  : Used to suppress sea clutter caused by waves. A/C SEA stands for anti-clutter sea.
-  : Adjusts the sensitivity of the receiver.
-  : Turns on the system. Press this and  touchpads simultaneously to turn off the system.
-  : Sets the radar to either transmit or standby.
-  : Selects the range. The "+" and "-" touchpads select a higher and lower range, respectively.
-  : Temporarily erases the heading mark.
-  : Displays/erases the fixed range rings.
-  : Mainly used to suppress precipitation clutter in heavy rain.
-  : Eliminates or reduces interference caused by other nearby operating radars.
-  : Adjusts the brightness of the CRT.
-  : Activates/releases the echo stretch function, which stretches echoes lengthwise for better distinction.
-  : Plots/cancels the relative movement of all targets to own ship.
-  : Displays/erases navigation data; own ship's position and speed and waypoint's bearing and range. This function is effective only when optional navigation equipment is connected.
-  : Shifts/resets the own ship's position to any position.
-  : Magnifies/resets the area between own ship and an arbitrary location by two times.
-  : Changes range unit for VRM and cross-hair between NM and KM. Press this with holding down  touchpad.
-  : Displays/erases the cursor.
-  : Displays/erases the guard zone.
-  : Silences/actuates the audible alarm.
-  : Displays/erases the Electronic Bearing Line.
-  : Selects true/relative bearing readout, provided that a gyrocompass is connected.
-  : Displays/erases the Variable Range Marker.

Trackball : Moves the cross-hair on the radar screen.





Fig.21 Front Panel Controls







## TURNING THE UNIT ON AND OFF

After having confirmed that the SCANNER switch is turned on, press the  touchpad and power is applied to all circuits of the radar system. The touchpad panel will light up, the antenna will begin to rotate, but no targets appear on the CRT. This is because the magnetron needs approximately 2 min. and 30 sec. to warm up before the radar can be operated. The time remaining for warm up of the magnetron is displayed at the center of the CRT, from 2:29 to 0:01.

Press both the  and  touchpads at the same time to turn the system off.

## SETTING UP

After power is applied and the magnetron has warmed up, the message "ST-BY" (Standby) will appear at center of the display screen, indicating the radar is ready to transmit. However, no targets will appear on the screen until the radar is put into transmit by pressing the  touchpad (TX is short for "transmit"). In ST-BY the radar is available for use at anytime--the scanner is rotating, but no radar waves are being transmitted.

Press the  touchpad to begin transmission; the display screen will light up, and the status of the indicators on the display screen will default to the following:  3nm; , ON, and all other indicators, OFF. Fig.22 shows the location of the indicators. Additionally, the screen brilliance will be medium-bright and the heading mark, the cross-hair, the distance/bearing to the cross-hair and the tuning bar are displayed. (The ship's heading is also displayed if a gyrocompass is connected.) When the radar is transmitting, any echoes from targets are displayed on the CRT.

At this time you may want to take a closer look at the display screen. Every one degree on the ring is marked by a short dashed line, and every ten degrees by a longer dashed line.

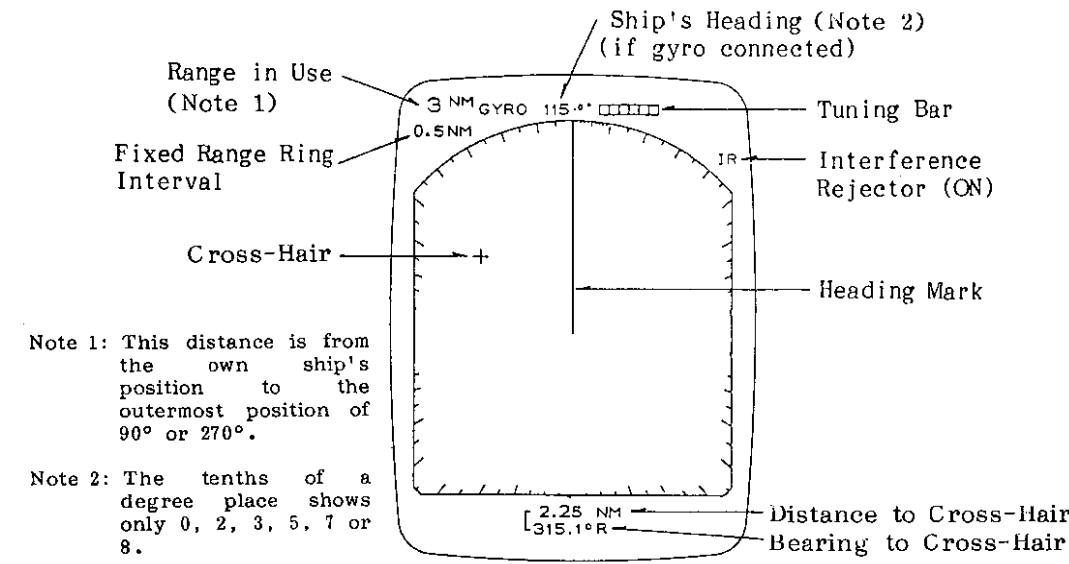



Fig.22 Location of Display Screen Indicators

The solid radial line at 0° is the heading mark. The heading mark is always on the screen and indicates the ship's heading. You may temporarily erase the mark by holding down the  touchpad.

The nearly invisible line rotating radially around the screen is called the "sweep." The sweep rotates synchronously with the scanner, so at any given time the direction in which the scanner is pointing is known. With every rotation echoes appear on the sweep as brighter spots of light, thus presenting a complete picture of the surrounding area.

Placing the radar in standby helps extend component life. Therefore, when the radar will not be used for an extended period of time, but you want to keep it in a state of readiness, set it to "ST-BY" mode by pressing the  touchpad again.

## Range Selection

The range selected automatically determines the fixed range ring interval, the number of fixed range rings, pulselength, and pulse repetition, for optimal detection in both short and long ranges (see the table below). Most ranges are either half or twice their neighbor for easy identification of targets when changing the range. The present range and its ring interval are displayed at the top left corner of the CRT.

The range chosen varies depending on circumstances. When navigating in or around crowded harbors, it is best to select a range between 0.5 and 1.5nm to watch for possible collision situations. If you select a lower range while on open water, increase the range occasionally to watch for vessels that may be heading your way. Remember that the maximum range a radar can see is dependent on many factors. Factors affecting maximum range are discussed in the Application section.





There are eight ranges available: 0.25, 0.5, 0.75, 1.5, 3, 6, 12 and 24nm. To select a range, press the  or  touchpad, depending on whether you want to select a higher range or a lower range. It is possible to increment or decrement the range setting automatically by holding down the  or  touchpad.

Table 2 Range Setting and Corresponding Fixed Range Ring Interval and Number of Fixed Range Rings

Range (nm)	0.25	0.5	0.75	1.5	3	6	12	24
Range Ring Interval (nm)	0.05	0.1	0.25	0.25	0.5	1	2	4
No. of Fixed Range Rings	5	5	3	6	6	6	6	6

## Setting the Gain Control



The GAIN control is used to adjust the sensitivity of the receiver, and thus the strength of echoes as they appear on the screen. It is adjusted so that a speckled noise background is just visible on the CRT.

To become acquainted with the way the GAIN control works, try rotating it between its fully counterclockwise and clockwise position as you observe the display. To properly set the gain, one of the higher ranges (12nm or 24nm) should be used--the speckled noise background is more apparent on these ranges. As you slowly turn the GAIN control clockwise you should be able to see the speckled background appear when the position of the control is between 2 and 3 o'clock. If you set up for too little gain, weak echoes may be missed. If you turn the GAIN control too far clockwise, yielding too much speckled noise background, strong targets may be missed because of the poor contrast between desired echoes and the background noise on the display. Fig.23 illustrates examples of gain settings which are too high, proper, and too low.

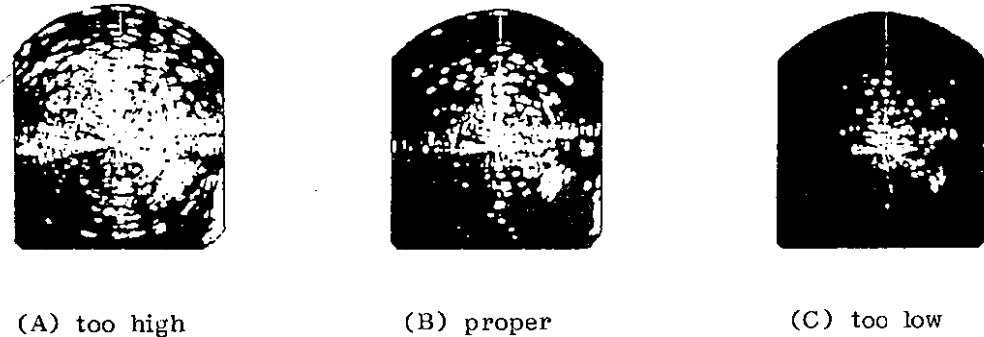

Fig.23 Setting the Gain Control

In certain circumstances it is useful to slightly reduce the gain to improve range resolution; clear up the picture; or reduce clutter caused by rain or snow.

Range resolution is a measure of the capability of a radar to display as separate pips the echoes received from two targets which are on the same bearing, and are close together radially. With reduction in the gain setting, the echoes may be made to appear as separate pips on the display screen.

When sailing or cruising in crowded regions a slight reduction in gain often helps to clear up the picture. This should be done carefully, otherwise weak targets may be missed.

Echoes from ships inside a squall or storm may be obscured if the gain is at its normal setting, since the clutter may have masked, but not completely, echoes from the targets.

In all cases, the gain should be returned to its original position after any temporary reduction is no longer required.

## Adjusting the A/C SEA Control



Echoes from waves can be troublesome, covering the central part of the display with random signals known as "sea clutter." The higher the waves, and the lower the scanner above the water, the further the clutter will extend. Sea clutter appears on the screen as a large number of small echoes which might affect radar performance (see Fig.24A). The action of the A/C SEA is to reduce the amplification of echoes at short ranges (where clutter is the greatest) and progressively increase amplification as the range increases, so that amplification will be normal at those ranges where sea clutter is not experienced. The control is only effective up to a maximum of about 4 miles.

The proper setting of the A/C SEA is such that the clutter is broken up into small dots, and small targets become distinguishable. If the control is not sufficiently advanced, other targets will be hidden in the clutter, while if it is set too high, sea clutter and targets will both disappear from the screen. As a general rule of thumb, turn the control clockwise until clutter has disappeared to leeward, but a little is still visible windward. Fig.24 illustrates how to adjust the A/C SEA control.

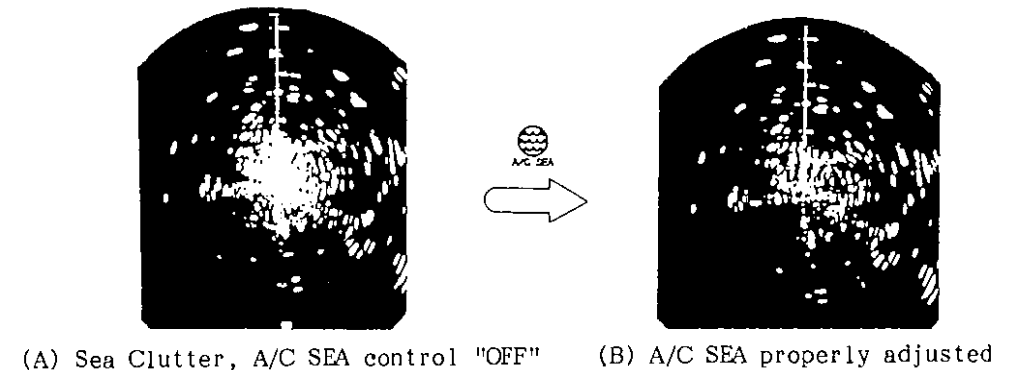



Fig.24 Adjusting the A/C SEA

A common mistake is to over adjust the control so that all the clutter is removed. By rotating the control fully clockwise you will see how dangerous this may be; a dark zone is created near the center of the screen. This dark zone can be dangerous (targets may be missed), especially if the gain has not been properly adjusted. Always leave a little clutter visible on the screen, this ensures weak echoes will not be suppressed. If no clutter is visible on the screen, leave the control in the fully counterclockwise position.

As mentioned before (in the procedure to set up the GAIN and A/C SEA when the radar is first initialized after installation), the GAIN is normally set to the point where there is a trace of noise speckles showing on the screen on the 12 or 24 mile range, and then the A/C SEA is adjusted on the 0.25 mile range scale so that close-in targets in a harbor situation are clearly seen. This equalizes the GAIN and A/C SEA characteristics for all ranges, short and long.

In moderate conditions on the open sea, where there are no definite targets to be seen on the shorter ranges, you should still adjust the GAIN on the 12 or 24 mile range for some noise speckles on the CRT, and then go down to the 0.5 or 0.75 mile range to adjust the A/C SEA until a bit of sea clutter is observed close to the boat.

### Adjusting the Brightness of the CRT

The  touchpad is used to adjust the brightness of the CRT. As a general rule of thumb, choose a brighter setting for daytime use, and a lower setting for nighttime operation. However, note that with too little brilliance the display becomes difficult to see, and excessive brilliance decreases the life of the CRT.

There are four levels of illumination: dim, medium, medium-bright, and bright. Each time the  touchpad is pressed the level will change in the above sequence. The status of this touchpad defaults to medium-bright when turning on the system.



### Tune Control Adjustment



This control tunes the receiver to the exact frequency of the transmitter. For the first 30 minutes of operation the tuning should be checked periodically to ensure that the radar is operating properly. Readjustment after the first 30 minutes is normally not required.

The tuning is made by moving the control slowly through the limits of its travel to find the position where a comparatively weak long range echo is discerned on the screen with maximum definition. The tuning condition can be monitored by observing the tuning bar at the top right corner of the CRT. The best tuning position is usually found at a point close to where the control is advanced 50% of its travel and the greatest number of tuning bars are displayed.

### MEASURING RANGE AND BEARING

In the basic radar system your ship is in the center of the screen, and any target received is displayed in a map-like projection throughout 360°. This allows the bearing and range from your boat to a target appearing on the screen to be measured.



Range is measured with the fixed range rings (rough estimate), the cross-hair (accurate and easy, but temporary method) or the Variable Range Marker (VRM; accurate and continuous indication of its range). Bearing is measured with the cross-hair on the Electronic Bearing Line (EBL; continuous indication of its bearing). If you want to know momentarily the range and the bearing to a target pip, you may use the cross-hair with the trackball. To know and indicate the data continuously, press the  and the  touchpads after operating the trackball. All the data mentioned above are displayed at the lower part of the screen.

The EBL and/or VRM are erased from the screen by pressing and holding the  and/or  touchpads for two to three seconds.

### Range Measurement , or +

To obtain a rough measurement of the range to a target pip, the fixed range rings are used. The fixed range rings are the solid rings appearing on the CRT. These rings are activated/deactivated by pressing the  touchpad. The range to a target using the fixed range rings is determined by counting the number of rings between the center of the CRT and the target. Check the fixed range ring interval (this value appears at the second top left corner of the CRT) and judge the distance of the echo from the inner edge of the nearest ring. For example, the 12nm range scale has six fixed range rings, each at a 2nm interval. Therefore if a target is positioned close to the 5th ring from the center of the display, the range to the target would be 10nm.

To obtain a more accurate reading of the distance to a target the cross-hair or the VRM and the cross-hair should be used. Now try measuring the range of the same target pip with the cross-hair and the VRM in this order. Using the trackball, locate the intersection of the cross-hair on the inside edge of the pip. Now you can read the range at the first lower center of the screen. Next, press the  touchpad. The VRM is presented on the screen as a dashed ring so as to distinguish it from the fixed range rings, and its range is shown at the lower right-hand side of the screen.

The range unit measured by the cross-hair and/or the VRM can be changed between "NM (nautical mile)" and "KM (kilometer)" by pressing the  touchpad while holding down the  touchpad.

The range to the cross-hair varies with trackball operation, while the VRM and its indicator remain on the screen until the VRM is reset.

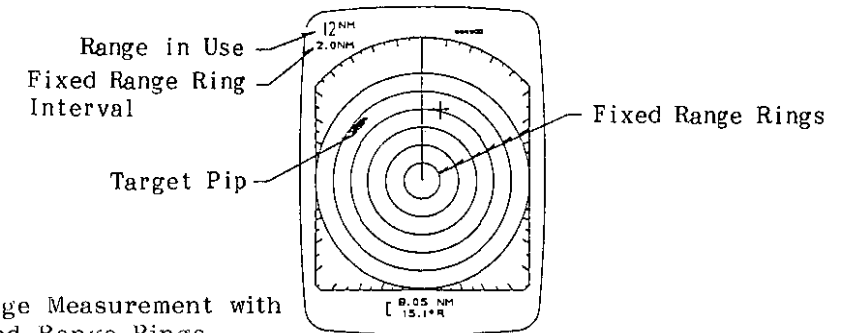

Fig.25 Range Measurement with Fixed Range Rings

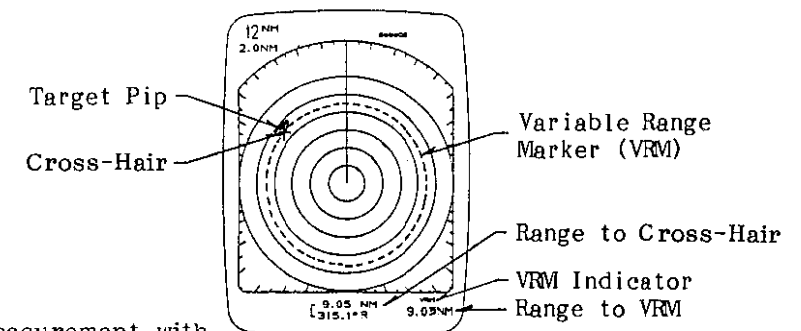

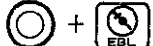



Fig.26 Range Measurement with Cross-Hair and VRM

Bearing Measurement  or 

To measure the bearing of a target pip, you can use either the cross-hair or the EBL plus cross-hair. Move the cross-hair with the trackball so that the intersection of the cross-hair bisects the center of the target. Now you can read the bearing at the second lower center of the screen. Next, press the  touchpad. The EBL is presented on the screen as a dashed radial line so as to distinguish it from the heading mark, and its bearing is shown at the lower left-hand side of the screen.

The bearing measured by the cross-hair and/or the EBL can be changed between "relative bearings (abbreviated R)" and "true bearings (abbreviated T)" by pressing the  touchpad, if a gyrocompass is connected to this radar. Relative bearings are relative to the bow of the vessel. And true bearings are relative to the True North.

If a gyrocompass is connected, the indicator "GYRO" and its bearing, i.e., your ship's bearing, are always shown at the top of the screen.

The bearing to the cross-hair varies with trackball operation, while the EBL and its indicator remain on the screen until the EBL is reset.

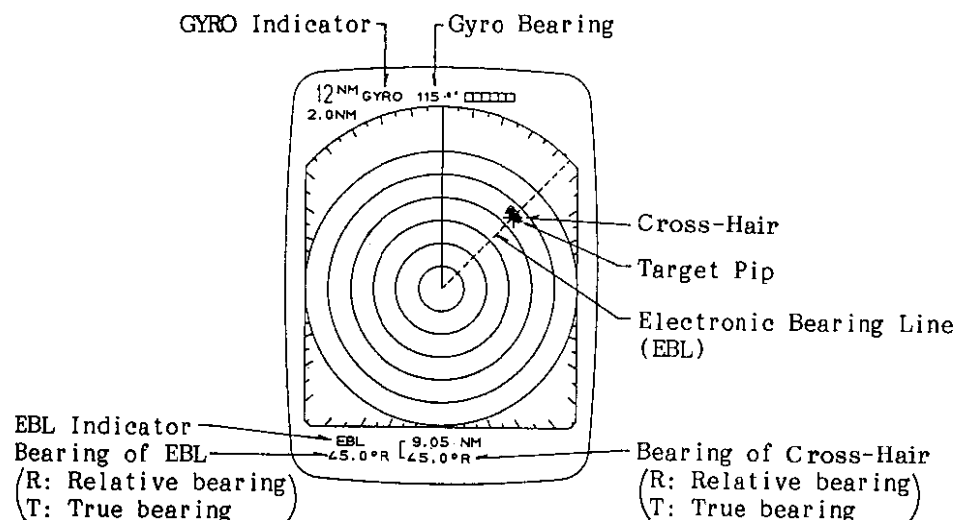



Fig.27 Bearing Measurement with Cross-Hair and EBL



To ensure accurate bearing measurement, keep in mind the following points.



- 1) Bearing measurements of smaller targets pips are more accurate; the center of larger target pips is not as easily identified.
- 2) Bearings of stationary or slower moving targets are more accurate than bearings of faster moving targets.
- 3) To minimize errors of bearing you should generally keep echoes in the outer half of the picture by changing the range scale; angular difference becomes difficult to resolve as a target approaches the center of the CRT.

REDUCING OR ELIMINATING INTERFERENCE

Basically there are three types of interference which hinder radar reception: sea clutter, due to echoes off waves (mentioned earlier); precipitation clutter and interference from other shipborne radars operating nearby and on the same frequency band. This radar can eliminate or reduce these types of interference.

Precipitation Interference  and/or 

The vertical beamwidth of the scanner is designed to see surface targets even when the ship is rolling. However, this design also has its disadvantages: rain storms, snow, or hail are detected in the same manner as normal targets. Precipitation clutter is easily recognizable by its wool-like appearance on-screen (see Fig.28). When this type of interference obscures a large area of the screen, you may use the  control and/or the  touchpad to eliminate or reduce the interference.

The FTC (Fast Time Constant) circuit works by splitting up these unwanted echoes into a speckled pattern, making recognition of solid targets easier. When only a slight amount of clutter is visible on the screen, turn the  control clockwise to distinguish target from the clutter. In heavy storms or partial clutter, press the  touchpad ("FTC" appears at the upper right-hand side of the screen), and then adjust the  control to reduce the clutter.

In addition to reducing clutter, the  touchpad may be used in fine weather to clarify the picture (namely, to distinguish targets) when navigating in confined waters. However, with the circuit activated the receiver is less sensitive, weaker echoes may be missed. The circuit is switched off by pressing the touchpad again.

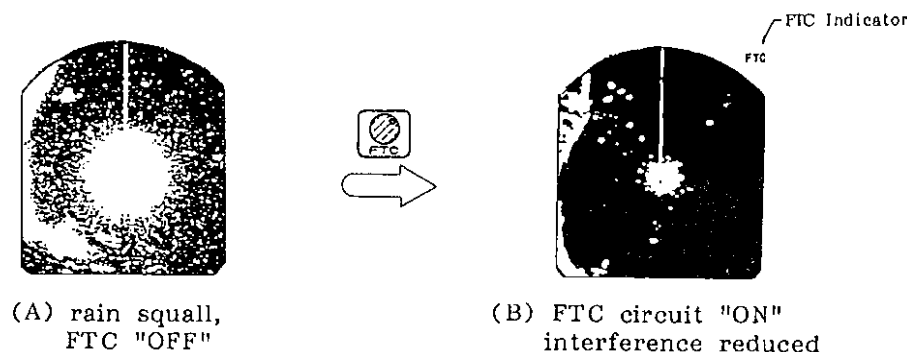



Fig.28 Precipitation Interference

Radar Interference 

Radar interference may occur when in the vicinity of another shipborne radar operating in the same frequency band. It usually is seen on the display screen as a large number of bright dots either scattered at random or in the form of dotted lines extending from the center (or the edge) to the edge (or the center) of the display screen. Fig.29 illustrates interference in the form of curved spokes. Interference effects are easily distinguished from normal echoes because they do not appear in the same place on successive rotations of the scanner.

This type of interference is reduced by activating the Interference Rejector circuit. Press the  touchpad to activate the circuit, and you will see the indicator "IR" appears at the upper right-hand side of the screen. Press the touchpad again to switch off the circuit when no interference exists, otherwise weaker targets may be missed. Note that the IR circuit is defaulted to on when turning on the power.

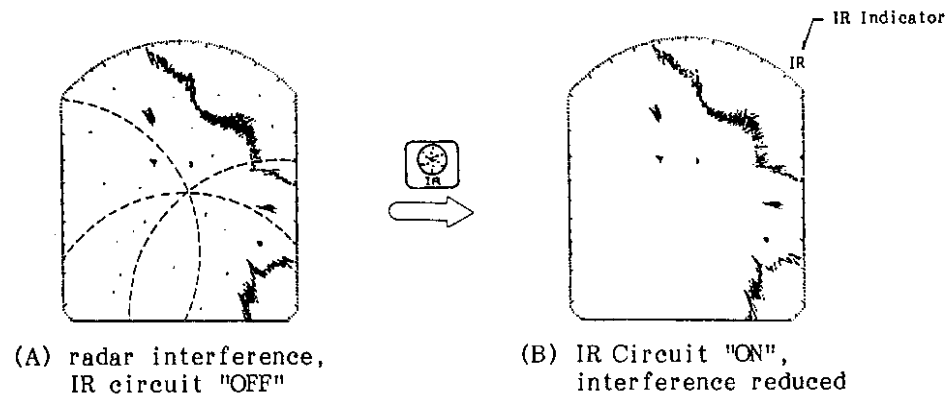



Fig.29 Radar Interference

#### BETTER DISTINCTION OF ECHOES

As a general rule of thumb, the reflected echoes from long distance targets are displayed on the screen as weaker and smaller blips even though they are compensated by the radar's internal circuitry.

The  touchpad is provided to magnify small blips in middle and long ranges, i.e., 1.5 to 24 mile ranges. Now press the  touchpad. The indicator "ES" appears at the upper right-hand side of the screen, and the echoes are doubled lengthwise. Note that this function is inactive on the 0.25, 0.5 and 0.75 mile ranges; the ES indicator is shown in inverse video to call your attention.

Press the touchpad again to turn off this function.

#### SETTING/DELETING THE ALARM +

The alarm function allows the operator to set the desired range (0 to maximum range) and bearing (0 to 360°) for a guard zone. Should ships, islands, landmasses, etc. come into the guard zone an alarm will be generated. The alarm is very effective as an anti-collision aid when using an autopilot or navigating in narrow channels.

Although the alarm is useful as an anti-collision aid, it does not relieve the operator of the responsibility to watch out for possible collision situations. The alarm should not be used as a primary means to detect possible collision situations.





Now the procedure to set the alarms.

#### Procedure

Before setting the alarm, ensure the gain is set properly because the audible alarm is triggered when third or fourth level quantization echoes come into the guard zone.

1. Mentally create the guard zone you want to display on-screen. See Fig.30 (1).
2. Designate the upper (lower) left edge of the guard zone with the cross-hair. Press the  touchpad, and the indicator "\*GUARD" (asterisk blinking) appears at the upper right-hand side of the screen. The asterisk indicates the guard zone is partially set; but the alarm function has been actuated. See Fig.30 (2).
3. Rolling the trackball clockwise, designate the lower (upper) right edge of the guard zone. The guard zone (fan-shaped) now appears on the display screen. See Fig.30 (3).

Note: The cross-hair may be moved counterclockwise to create a 360° guard zone area (doughnut-shaped appearance), in which case the guard zone is contracted as the cross-hair is moved.

4. Press the  touchpad again. The asterisk disappears, indicating the guard zone is completely actuated. See Fig.30 (4).
5. Any ships, landmasses, etc. coming into the guard zone will trigger the audible alarm, telling the operator to proceed with caution. If the audible alarm sounds, it can be silenced with the  touchpad. When this is done the indicator "GUARD" is displayed in inverse video; but the guard zone remains on the screen.
6. Press the  touchpad again to restore the audible alarm.
7. To cancel both the guard zone and the audible alarm, press and hold the  touchpad for two to three seconds.

Note 1: When "UP RANGE" indication appears instead of "GUARD" indication at the upper right-hand side of the screen, select a higher range to display the guard zone on the screen.

Note 2: A target echo does not always mean a landmass, reef, ships or surface objects but can imply returns from sea surface or precipitation. As the level of these returns varies with environment, the operator is required to properly adjust the A/C SEA (anti-clutter sea), AC/RAIN (anti-clutter rain), FTC and GAIN to ensure that target echoes within the guard zone are not overlocked by the alarm system.

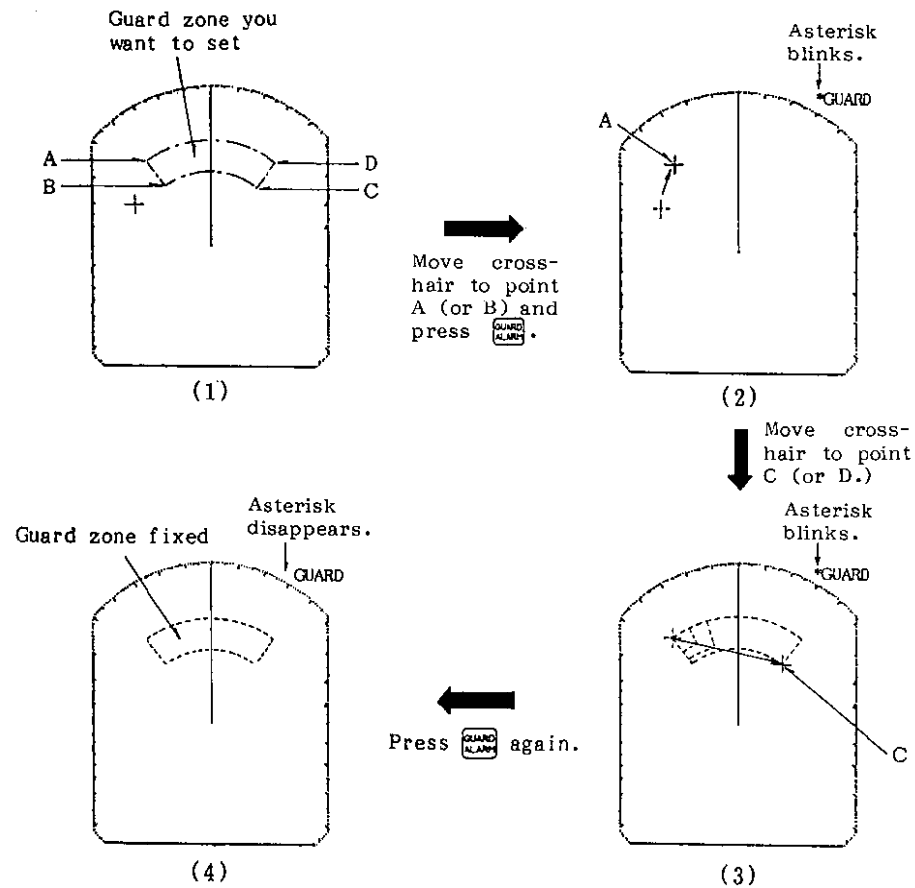





Fig.30 Setting Guard Zone

### USING THE CURSOR +

This unit incorporates an electronic parallel cursor. The parallel cursor is comprised of a series of lines parallel to the line inscribed through the screen center, and it is used for maintaining a constant distance between own ship and a coastline or a partner ship.

Press the  touchpad to display the cursor. Roll the trackball to the right (or left) and the cursor rotates clockwise (or counterclockwise). To erase the cursor, press and hold the  touchpad for two to three seconds.

Note 1. The range selected automatically determines the number of parallel cursors.

Note 2. To control other functions with the trackball while the cursor is displayed, press the  touchpad again.

### SHIFTING THE DISPLAY +

The own ship's position can be shifted to any position within the range in use. See Fig.31(1). The primary advantage of the shifted (off-center) display is that for any particular range setting the view ahead, behind or on the sides of own ship can be extended without changing the range in use.

#### Procedure

1. Place the cross-hair on the L/L position to where you want to shift your own ship's position. See Fig.31 (2).
2. Press the  touchpad, and the own ship's position is off-centered. See Fig.31 (3).

Note: If the cross-hair is placed beyond the valid screen area; namely, the range in use, when the  touchpad is pressed, successive beep tones are generated and the outermost fixed range ring flickers twice even if the fixed range rings are turned off, telling you that the cross-hair should be placed within the range in use.

3. Press the touchpad again to cancel this function.

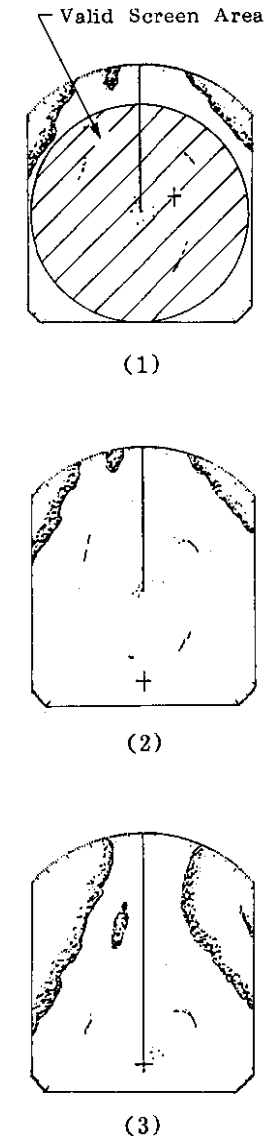

Fig.31 Shifting the Display

**ZOOM FUNCTION**  + 

The area between own ship and an arbitrary location can be doubled with the zoom function. This function lets you take a closer look at an area of interest without changing the range in use.



Note that this function is not available when the shift function is on. If you attempt to activate it when the shift function is on, successive beep tones are generated, informing you of unacceptable key entry.

**Procedure**

1. Roll the trackball and move the cross-hair near the target. See Fig.32(1) and (2).

2. Press the  touchpad to activate the zoom function. The own ship will shift to an opposite position to the cross-hair in reference to the screen center, thereby producing a doubled screen size for the same range between the own ship and the cross-hair. See Fig.32 (3). The message "ZOOM" flashes at the top left-hand side of the screen.

Note: If the cross-hair is placed beyond the valid screen area; namely, the range in use, when the  touchpad is pressed, successive beep tones are generated and the outermost fixed range ring flickers twice even if the fixed range rings are turned off, telling you that the cross-hair should be placed within the range in use.

3. Press the  touchpad again to cancel this function. The zoom function can also be cancelled by pressing the  touchpad or changing the range.

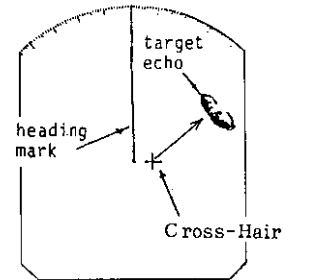

(1)

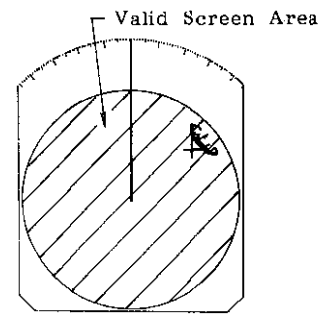

(2)

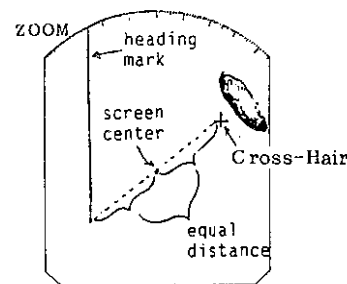



(3)

Fig.33 Zoom Function

**PLOTTING** 

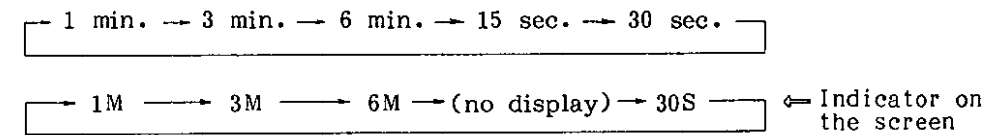
This function plots the movement of other ships relative to your own ship on the screen. Press the  touchpad, and plotting of moving targets takes place at intervals of 15 seconds. The indicator "PLOT" and the time elapsed after starting the plot operation are displayed at the upper right-hand side of the screen, counting up to 99 minutes and 59 seconds. If the touchpad is pressed again within 10 seconds, the plotting interval changes to 30 seconds and "30S" is displayed at the same place. Further, pressing it successively within 10 seconds changes the plotting interval in the following sequence.



Press the  touchpad again after 10 seconds passed, and the plot function is canceled and the normal radar picture is restored.

If the  touchpad is pressed during this operation, the present plot is erased, and plotting is restarted with the newly selected range.

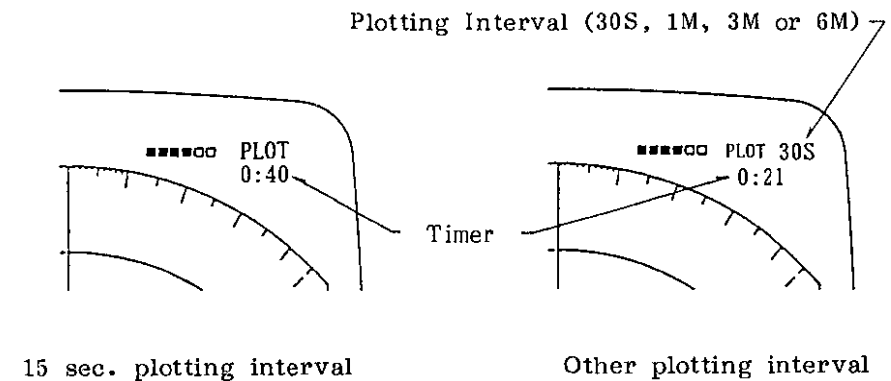

Fig.33 Indicators on Plotting

Collision Course?

To ascertain another ship as a hazardous target place the EBL on it. If the extension of its latest tracks is on the EBL, it can be a hazardous one. In Fig.34, ship A can be on collision course and ship B will pass clear to starboard.

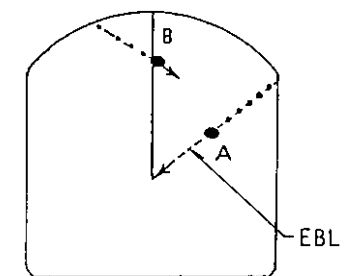

Fig.34 Plotting

## DISPLAYING NAV DATA (OPTION)



If an external Loran-C navigator having NMEA 0183 output format is connected, LL data, i.e., own ship's position in latitude and longitude, WP (stands for waypoint) data, i.e., bearing and range to a waypoint selected on the nav aid, and SPD data, i.e., own ship's speed, are displayed at the lower part of the screen by pressing the touchpad. If a gyrocompass is also connected, a waypoint mark is drawn as a dashed ring, and a dashed line is drawn from the own ship's position to the waypoint mark.

Press the touchpad again to cancel the navigation data display.

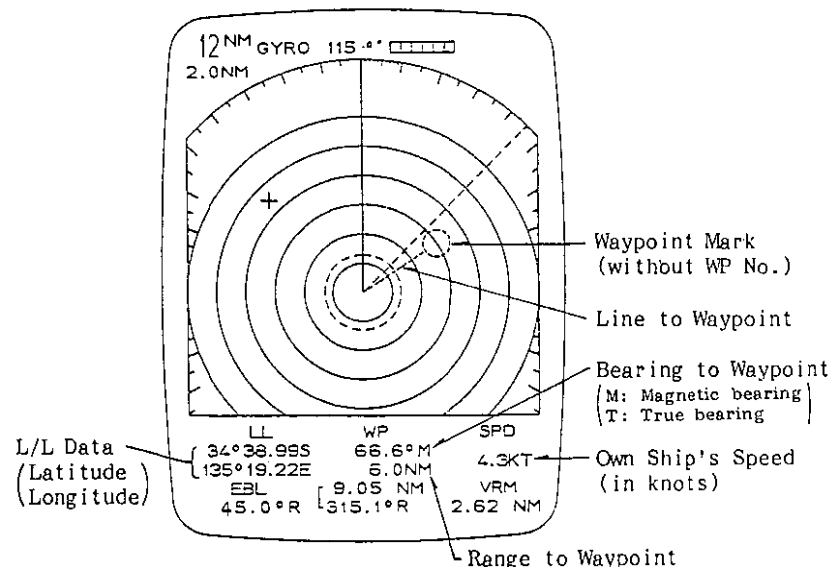

Fig.34 Nav Data on the Screen

Note: When the output format of an external navigator is not NMEA 0183 but FURUNO CIF format, it is necessary to connect a jumper wire to "JMP4" on PROCESSOR board SPU-7880. When CIF format is used, bearing measurement method (Magnetic or True) for bearing to waypoint data is not displayed (see figure above).

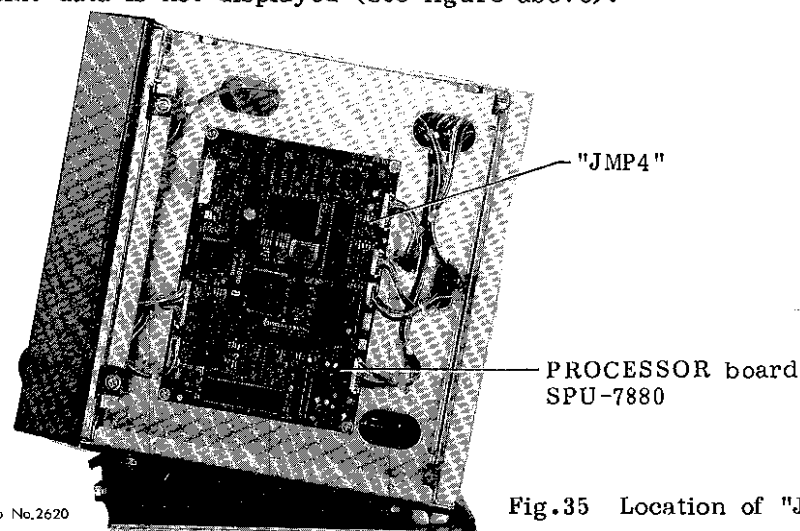

Fig.35 Location of "JMP4"

N Photo No.2620

## APPLICATION

As an aid to navigation, radar can be a very valuable tool. No other navigation aid can give you the ability to spot vessels coming at you in the fog, or tell you the location of the inlet to the harbor in the pitch black of night. To help you understand better what your radar can and cannot do for you this section covers the characteristics and limitations of radar, picture interpretation, position fixing with radar and aids to navigation.

### FACTORS AFFECTING MINIMUM RANGE

Targets disappearing from the screen when at close ranges can be dangerous. For this reason, detection of targets at short ranges is very important. Minimum range is determined primarily by transmitter pulselength. The shorter the transmission time, the sooner the return echoes can be received and their distance measured. This radar automatically determines the pulselength for both short and long ranges, for optimal detection of targets at short as well as long range.

### Sea Return

Sea clutter echoes received from waves may hamper detection of targets beyond the minimum range set by the pulselength and recovery time. (Recovery time is the time required for the receiver to recover to half sensitivity after the end of a transmitted pulse, so it can receive a return echo.) Proper adjustment of the A/C SEA control may alleviate some of the problem.

### Vertical Beamwidth

The ability to see targets very close to the boat is decreased if the antenna is mounted too high off the water, since the bottom of the vertical beam of the scanner cuts off nearby targets. Fig.37 illustrates the effects of a scanner mounted too high off the water.

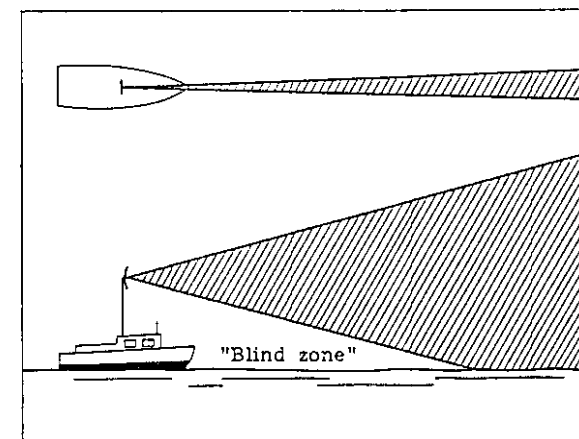

Fig.37 Effects of a Scanner Mounted too High off the Water

### FACTORS AFFECTING MAXIMUM RANGE

It is nearly impossible to state that a radar has a maximum range. The maximum range a radar will "see" is dependent on many factors, not just the



range marked on the screen. Not only does the sensitivity of the receiver and power of the transmitter but also the height above the water of both the scanner and target, the size, shape and composition of the target, and atmospheric conditions contribute to increase or decrease the maximum detectable range.

### Radar Horizon

Radar is by its very nature essentially a "line-of-sight" phenomenon. That means that you have just about the same range to the horizon with a radar as you do with your own eyes. However under normal atmospheric conditions, the radar horizon is 6% greater than the optical horizon. Therefore, if the target does not rise above the horizon the radar beam cannot be reflected from the target.

Just as you can see a low-to-the-water speedboat only up relatively close to your boat, the radar can see a target high off the water farther than it can see an object which is close to the water. Further, the higher the antenna is mounted over the water the farther it is capable of seeing other targets. However a possible negative effect with mounting the antenna too high off the water is that due to the finite vertical beamwidth of the scanner, the amount of sea clutter due to reflections from nearby waves is increased to a greater distance from the boat.

Thus it is not at all uncommon to see a 3000 foot high mountain 50 miles away (provided the radar has a 50nm detection capability), while at the same time being only able to see a small power boat 3 or 4 miles away. (See Fig.38.)

The distance to the horizon from the scanner, under normal conditions, is calculated by the following formula.

$$R_{max} = 2.2 \times (\sqrt{h_1} + \sqrt{h_2})$$

Where  $R_{max}$ : Radar horizon (mile)  
 $h_1$ : Antenna height (meters)  
 $h_2$ : Target height (meters)

For example, to find the distance to the horizon in Fig.38, if the antenna height is 8 meters (26 feet) and the target height is 15.2 meters (50 feet) the maximum range is (when the cliff begins to appear on the radar),

$$R_{max} = 2.2 (\sqrt{8} + \sqrt{15.2}) = 14.8 \text{ miles.}$$

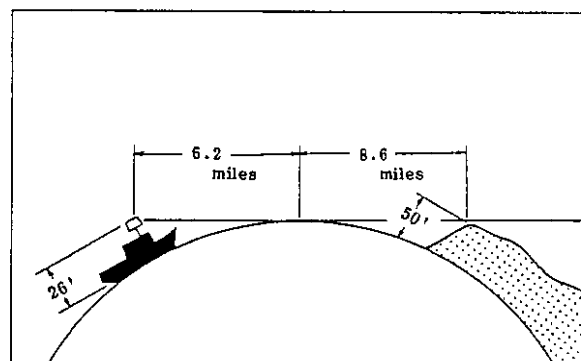

Fig.38 Radar Horizon

### Target Properties

As a general rule of thumb, larger targets can be seen on the radar display at greater ranges, provided line-of-sight exists between the scanner and target. However, a large target with poor reflecting properties may not be detected as easily as a smaller target with better reflecting properties.

Since one of the main functions of radar is to detect other ships, the composition of a target ships' hull affects the detection range. A ship whose hull is made of conducting materials, such as a steel, return relatively strong echoes.

On the other hand, hulls made from wood or fiberglass return much weaker echoes.

Vertical surfaces, such as a cliff, are good targets provided they face the radar. Inversely, horizontal and smooth surfaces such as mudbanks, sandy beaches, and gently sloping hills make poor targets because they disperse rather than reflect most of the energy that strikes them.

The strongest radar echoes known come from built-up areas, docks, etc., because these targets are less subject to changes in aspect. These types of targets have three flat, smooth surfaces mutually at right angles. This type of arrangement is used on some radar buoys to increase their detection range.

### INTERPRETING THE DISPLAY

In the previous section some of the characteristics and limitations of radar were discussed. Now its time to take a look at what you can expect to see on the radar screen. What shows up on the screen isn't likely to match exactly what is seen on a navigation chart. A radar cannot see through a mountain in the path between your boat and the harbor, nor can it see a small boat directly behind a large ship, since both the mountain and the larger vessel effectively shield the radar from the desired target.

To aid you in target identification, the echoes appearing on the display are quantized in four levels, according to their intensity. The brightest intensity echoes are probably from steel ships, or piers, or other "good" targets. Poor targets, for example wooden boats, appear in the weakest intensities.

The ability to interpret a radar picture comes through practice and experience. Practice should be done during clear weather in daytime, since you can compare the picture with what you actually see around you. Go to an area you are familiar with and compare the way coastlines, buoys and other targets are displayed on the screen and the way they are drawn on a navigation chart. To observe the movement of an echo in relation to your position, try running your boat at various speeds and headings.

### LAND TARGETS

Landmasses are readily recognizable because of the generally steady brilliance of the relatively large areas painted on the display. Knowledge of the ship's navigational position will also tell you where land should be. On relative motion displays (this radar), landmasses move in directions and at rates opposite and equal to the actual motion of your own ship. Various

factors such as distortion from beamwidth and pulselength make identification of specific features difficult. However, the following may serve as an aid to identification.

- 1) High, steep, rocky and barren landmasses provide good reflecting surfaces.
- 2) Low, vegetation covered lands make poor radar targets.
- 3) Submerged objects do not produce echoes.
- 4) Mud flats, marshes, sandspits, and smooth, clear beaches make poor targets because they have almost no area that can reflect energy back to the radar.
- 5) Smooth water surfaces such as lagoons and inland lakes appear as blank areas on the display--smooth water surfaces return no energy.
- 6) Although you might expect an object as large as a lighthouse to be a good radar target, in actuality the return echo is weak since the conical shape diffuses most of the radiated energy.

#### SHIP TARGETS

A bright, steady, clearly defined image appearing on the display is in all likelihood the target pip of a steel ship. There are several clues which can aid you in identification of a ship. Check your navigational position to overrule the possibility of land. Land and precipitation echoes are much more massive in appearance, whereas the target pips of ships are relatively small. The rate of movement can eliminate the possibility that the pip is an aircraft.

A target pip may brighten and become dim due to changes in aspect, etc. In most cases however a pip will fade from the display only when the range becomes too great.

#### ECHO SIZE

As the radar beam rotates, the painting of the pip on the display begins as soon as the leading edge of the radar beam strikes the target, and continues until the trailing edge of the beam is rotated beyond the target. Thus, a target cannot appear less wide than the beamwidth. As the beam widens with distance from the scanner, so also will the widths of targets vary on the display. Fig.39 illustrates the relationship between beamwidth and the appearance of a target pip.

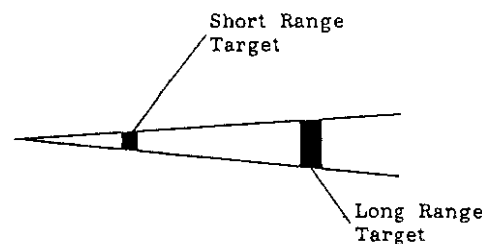

Fig.39 Beamwidth vs. Target Appearance

#### FALSE ECHOES

Occasionally false echoes appear on the screen at positions where there is no target. In some cases the effects can be reduced or eliminated. The operator should familiarize himself with the appearance and effects of these false echoes, so as not to confuse them with echoes from legitimate contacts.

##### Multiple Echoes

Multiple echoes occur when a short range, strong echo is received from a ship, bridge, or breakwater. A second, a third or more echoes may be observed on the display at double, triple or other multiples of the actual range of the target as shown in Fig.40. Multiple reflection echoes can be reduced and often removed by decreasing the gain or properly adjusting the A/C SEA.

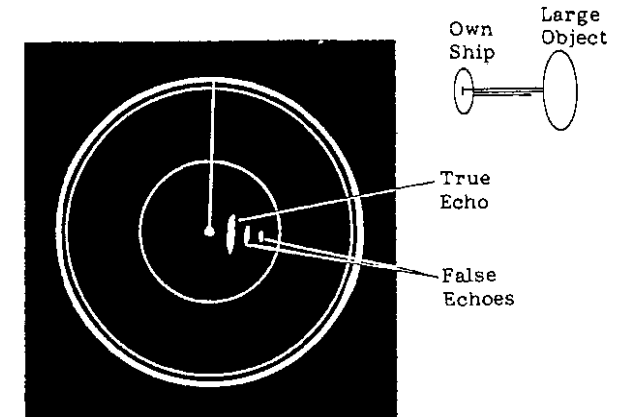

Fig.40 Multiple Echoes

##### Side-Lobe Echoes

Every time the scanner rotates, some radiation escapes on each side of the beam--called "side-lobes." If a target exists where it can be detected by the side lobes as well as the main lobe, the side echoes may be represented on both sides of the true echo at the same range, as shown in Fig.41. Side lobes show usually only on short ranges and from strong targets. They can be reduced through careful reduction of the gain or proper adjustment of the A/C SEA control.

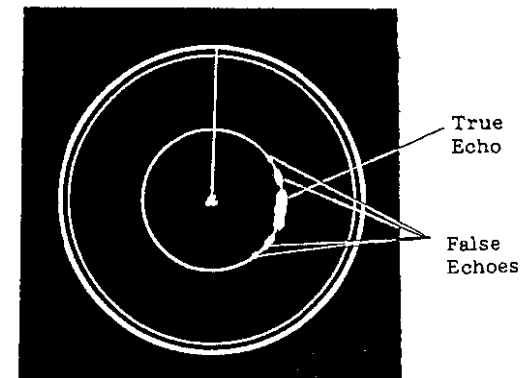

Fig.41 Side-Lobe Echoes

##### Blind and Shadow Sectors

Funnels, stacks, masts, or derricks in the path of antenna may reduce the intensity of the radar beam. If the angle subtended at the scanner is more than a few degrees a blind sector may be produced. Within the blind sector small targets at close range may not be detected while larger targets at much greater ranges may be detected. See Fig.42.

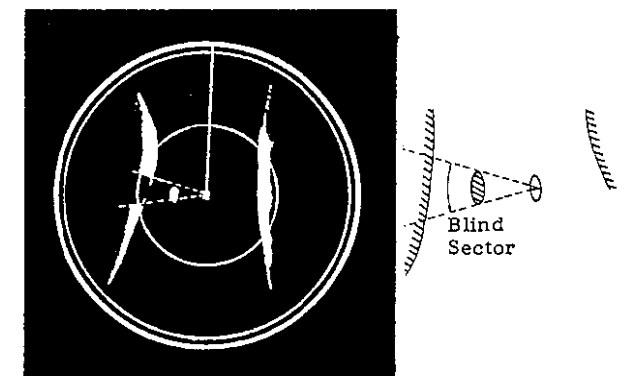

Fig.42 Blind and Shadow Sector

## Indirect Echoes

Indirect echoes may be returned from either a passing ship or returned from a reflecting surface on your own ship, for example, a stack. In both cases, the echo will return from a legitimate contact to the antenna by the same indirect path. The echo will appear on the same bearing of the reflected surface, but at the same range as the direct echo. Fig.43 illustrates the effect of an indirect echo. Indirect echoes may be recognized as follows. (1) they usually occur in a shadow sector; (2) they appear on the bearing of the obstruction but at the range of the legitimate contact; (3) when plotted, their movements are usually abnormal, and (4) their shapes may indicate that they are not direct echoes.

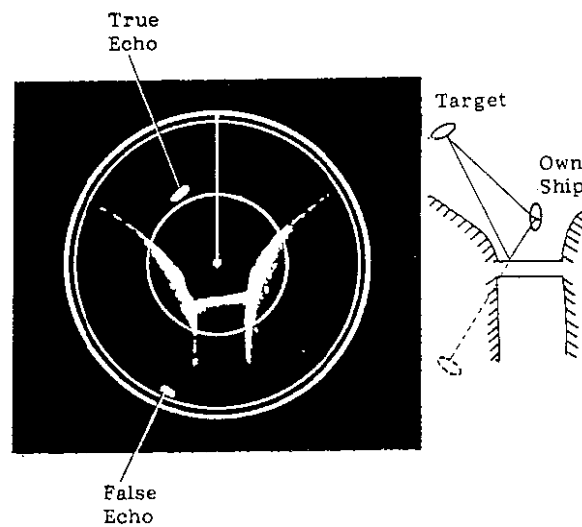

Fig.43 Indirect Echoes

## RADAR PICTURE AND CORRESPONDING CHART

Under normal conditions, a picture which is very similar to a chart can be obtained on the radar display. The radar picture and corresponding chart shown in Fig.44 are from the Kada Inland Sea, south of Osaka Bay, in Southwestern Japan.

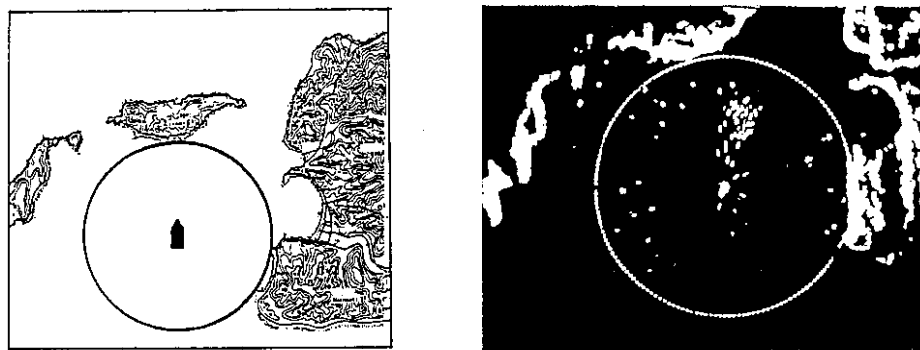

Fig.44 Navigation Chart and Corresponding Radar Picture

## POSITION FIXING WITH RADAR

Position fixing with radar can be accurate and easy once you become familiar with the different methods. The three most common methods will be discussed in this section. Take a compass, and a navigation chart to try to fix your position while reviewing this section.

### By Radar Range

The simultaneous measurement of the ranges to two or more fixed objects is normally the most accurate method of obtaining a fix with radar alone. Preferably at least three ranges should be used. However the use of more than three range arcs may introduce excessive error because of the time lag between measurements, i.e., you will be moving as you take successive measurements.

When obtaining a fix, it is best to measure the most rapidly changing range last because of a smaller time lag in the radar plot from the ship's actual position. For greater accuracy, the objects selected should provide arcs with angles of cut as close to  $90^\circ$  as possible. Small, isolated, radar-conspicuous fixed objects whose associated range arcs intersect at angles approaching  $90^\circ$  provide the most reliable and accurate position fixes. Objects at longer ranges are less accurate for position fixing because they may be below the radar horizon and because the width of the radar beam increases with range.

To fix your position, first, measure the range to two or more prominent navigational marks which you can identify on the chart. (The method for measuring range is found on page 31.) Next, with the compass sweep out the ranges from the charted positions. The point of intersection of the arcs is your estimated position. The correct method of position fixing when using radar range is illustrated in Fig.45.

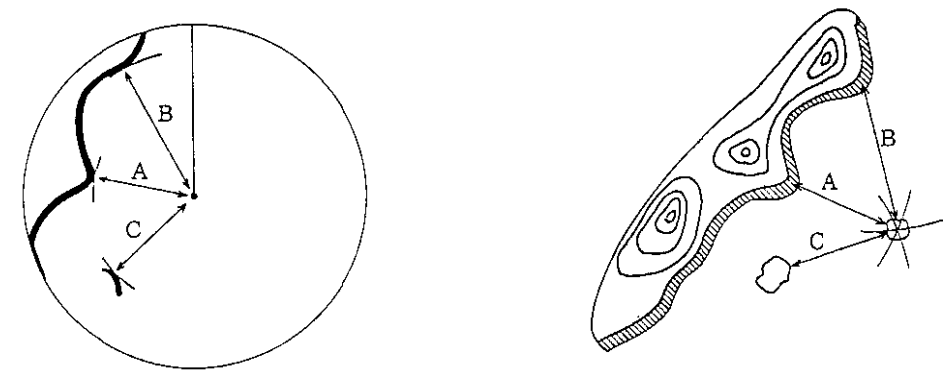

Fig.45 Position Fixing Using Radar Ranges

### By Range and Bearing to a Point of a Land

The advantage of position fixing by range and bearing to a point of land is the speed with which a fix can be obtained. A distinct disadvantage however is that this method is based upon only two intersecting position lines, a bearing line and range, obtained from two points of land. If possible, the object used should be small, isolated and identified with reasonable certainty. To fix your position using range and radar bearing,

first, measure the relative bearing of the target with the EBL, noting the exact direction of the ship's heading when doing so. Next, make allowance for compass deviation (true or magnetic) and find the true bearing of the target unless the gyrocompass is connected. Sweep out the range to the target with the compass on the chart and plot the true bearing of the target. The point of intersection is your approximate position. Fig.46 illustrates the correct method of position fixing using a range and bearing to a point of land.

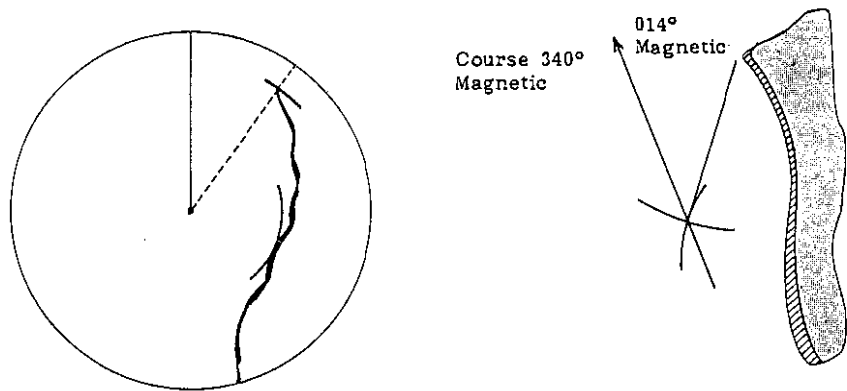

Fig.46 Position Fixing Using Range and Bearing to a Point of Land

By Two Bearings

Generally, fixes obtained from radar bearing are less accurate than those obtained from intersecting range arcs. The accuracy of fixing by this method is greater when the center bearings of small, isolated radar-conspicuous objects can be observed. Similar to position fixing using range and bearing, this method affords a quick means for initially determining approximate position. The position should then be checked against other means to confirm reliability.

Position fixing using two bearings is determined by measuring the relative bearings for the two targets and then determining their true bearings. Plot the two bearings on the chart; the point of intersection of the two bearings is your approximate position. Fig.47 illustrates the correct method of position fixing using two bearings.

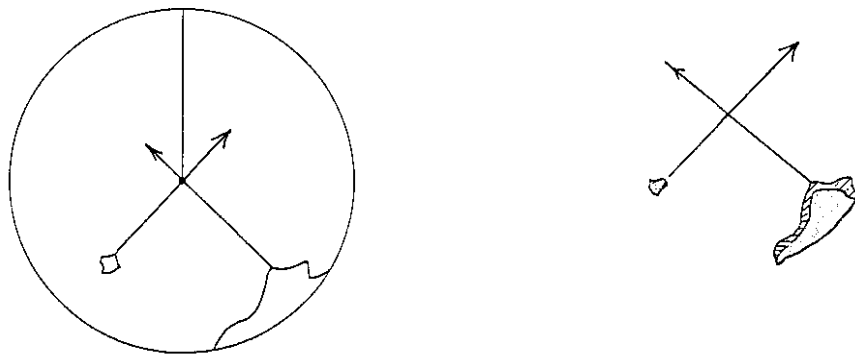

Fig.47 Position Fixing Using Two Bearings

**COLLISION AVOIDANCE**

Collisions at sea sometimes occur because the radar picture doesn't match the information provided by the eye in clear weather and because of the misunderstanding of relative motion.

In a relative motion display your ship is represented by the spot of light fixed at the center of the screen, whatever the speed of your own ship. With both your own ship and the target in motion, the successive pips of the target do not indicate the actual or true movement of the target. If own ship is in motion, the pips of fixed objects, such as landmasses, move on the display at a rate equal to and in a direction opposite to the motion of own ship. Only when your ship is stopped or motionless do target pips move on the display in accordance with their true motion. Fig.48 illustrates the relative and true motion of a target contacted by radar.

In Fig.48, ship A, at geographic position A1 on true course of 001° at 14 knots initially observes ship B on the PPI at bearing 179° at 4.1 nm. The bearing and distance to the ship changes as ship A proceeds from position A1 to A3. The changes in the position of ship B relative ship A are illustrated in the successive PPI presentations corresponding to the geographic positions of ships A and B. Likewise, ship B at geographic position B1, on true course 25° at 21 knots initially observes ship A on bearing 001° at 4.1 nm.

The radar operator aboard ship A will determine that relative movement of ship B is approximately 66.5°, whereas the operator aboard ship B will determine that the relative movement of ship A is approximately 238°. These figures were obtained using a maneuvering board.

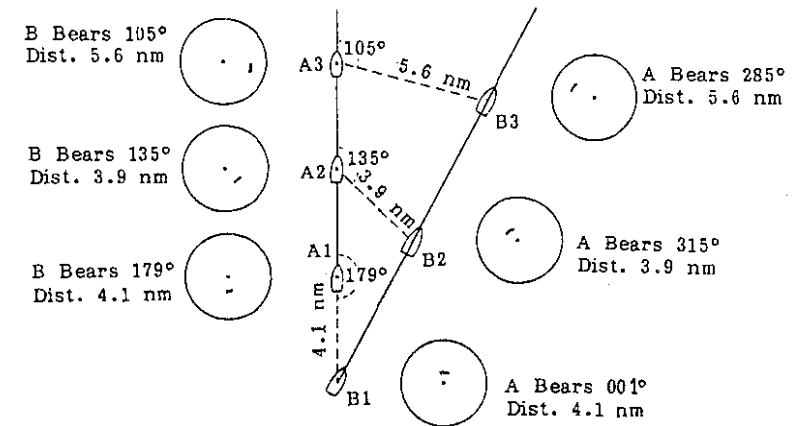

Fig.48 Relative Motion vs. True Motion

Assessing the Risk

The moment an echo appears on the screen its range and relative bearing should be measured and its true or magnetic bearing noted. This is best done on a chart or plot. Collision risk can be assessed by carefully watching the true or magnetic bearing of an approaching vessel. If the bearing of the target does not appreciably change a possibility of collision may exist. You should take proper action in accordance with the Regulations for Preventing Collisions at Sea.

## AIDS TO NAVIGATION

Various aids have been developed to aid the navigator in identifying radar targets.

### RADAR BEACONS

Radar beacons are transmitters operating in the marine frequency band which produce distinctive indications on the radar displays of ships within range of these beacons. There are two classes of beacons: racon and ramark.

#### Racon

A racon is an omnidirectional transmitter which emits a distinctive signal when triggered by the pulse from a ship's radar. Both range and bearing to the target can be extracted from the signal. Because the beacon's signal travels at the same time as the echo arriving the ship's range to the target can be determined. Since the signal will be received only when the scanner is pointing directly at the beacon, bearing is shown as well as the range and the vessel's position is thus determined. The range and bearing of the racon signal is measured in exactly the same manner as a normal target pip. The racon signal appears on the display as either a radial line originating at a point just beyond the radar beacon or as a Morse code signal displayed radially from just beyond the beacon. See Fig.49. Note that with the FTC or IR circuit switched on, the racon marker line may partially disappear.

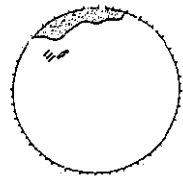

(A) Coded Racon Signal

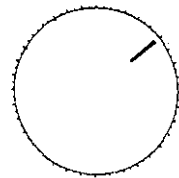

(B) Racon Signal

Fig.49 Racon Signal Appearance

#### Ramark

A similar type of beacon is known as a ramark. It transmits continuously on a frequency constantly varying so as to sweep through the entire radar band. The ramark signal appears as a radial line from the center of the CRT. The radial line may be a continuous narrow line, a series of dashes, a series of dots, or a series of dots and dashes. Fig.50 illustrates the appearance of a ramark signal, as a dotted line, and as a dashed line. Although the ramark flash shows only the bearing to the beacon, if the ramark is mounted on the coast and this can be also seen on the screen, a fix can be obtained from the ramark.

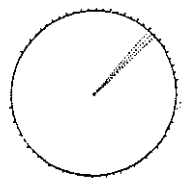

(A) as a dotted line

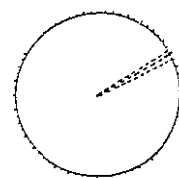

(B) as a dashed line

Fig.50 Ramark Signal Appearance

## MAINTENANCE

### GENERAL

Satisfactory operation of the radar depends in large measure on periodic maintenance as outlined below.

#### CAUTION

DISCONNECT POWER BEFORE PERFORMING ANY MAINTENANCE PROCEDURES.

- 1) Keep the equipment as free as possible from dirt, dust and water splashes.
- 2) Inspect whether the screws securing the components are properly tightened.
- 3) Inspect the connection at the rear panel.

### SCANNER UNIT

#### Radome

Wipe the surface of the radome with a clean soft cloth. Check that there is no dirt or caked salt on the surface. A heavy deposit of dirt or caked salt on the painted surface of the upper radome will cause a considerable drop in radar performance. Do not use chemical cleaners except for alcohol. Check for cracks or deterioration of the rubber packing and replace it if necessary. Do not paint the surface of the radome.

#### Mounting

Check that the radome base and the radome cover fixing bolts are secured tightly.

### DISPLAY UNIT

#### Cleaning the screen

The face of the cathode-ray tube will, in time, accumulate a coating of dust which tends to dim the picture.

Clean lightly with a soft cloth (flannel or cotton), moistened with alcohol or cleaning fluid if desired. Do not use excess pressure; you may scratch the surface.

#### Fuse replacement

To protect the equipment from serious damage, a 10A fuse is provided on the rear panel. The fuse protects against overvoltage/reverse polarity of the ship's mains or internal fault of the equipment. If the fuse has blown, first find the problem before replacing it with a new one. A fuse rated for more than 10A must not be used, since it may cause serious damage to the equipment. OVER FUSING WILL VOID WARRANTY.

## TROUBLESHOOTING

In this section, troubleshooting is arranged in two parts: one for the user and the other for the service shop. "Basic troubleshooting" for user includes simple tests of the equipment which the user can handle, such as operation, installation and visual checks. The "More extensive troubleshooting" is considerably more complicated and must be done by a qualified technician. If something appears wrong with your unit, check the equipment referring to the "Basic troubleshooting." In case the trouble is not found after performing these checks, and the unit still appears to be faulty, call your electronics technician for service.

### BASIC TROUBLESHOOTING

In most cases when the unit fails to operate properly the cause is very simple. Before calling for service or sending out the unit for repairs, check the following.

#### 1) Nothing appears on screen

(Check that the front panel is illuminated. If not, check the following.)

- \* Is the battery dead?
- \* Is the fuse blown?
- \* Supply voltage is normal?
- \* Corrosion on battery terminals?
- \* Poor contact of power cable?

#### 2) No echo but numerical and character indicators

- \* Is the antenna plug loose?

#### 3) Low sensitivity

- \* Is the GAIN setting too low?
- \* Is the A/C SEA setting too high?
- \* Is the FTC set to ON?
- \* Is the BRILL set too low?
- \* Is the receiver detuned? (Coarse TUNE setting wrong.)
- \* Is the radome dirty?

#### 4) Heavy noise

- \* Is the unit grounded?

#### 5) Sweep not rotating

- \* Is the SCANNER switch turned on?
- \* Is the antenna plug loose?
- \* Is the 4-way connector (P/J802) inside the radome loose?

### MORE EXTENSIVE TROUBLESHOOTING

Any replacement of defective parts (except for fuse) should be carried out by a qualified serviceman. The most common troubles you may experience and their possible causes are listed below.

### WARNING AGAINST HIGH TENSION

At several places in the unit there are high voltages, enough to kill anyone coming into direct contact with them. Do not change components or inspect the equipment with the voltage applied. A residual charge may exist in some capacitors with the equipment turned off. Always short all supply lines to the chassis with an insulated screwdriver or a similar tool prior to touching the circuit.

Typical Problems/Its Causes (See to pages 55 and 56 for the parts location.)

#### 1) Nothing appears on CRT.

- \* CRT assembly  
Check if the CRT heater lights up or not. If not, check fuse F201(2A). If it is normal, adjust potentiometers VR101 ("CONT1") and VR204 ("BRIGHT") on the Deflection board.
- \* Defective SPU board (SPU-7880)

#### 2) Scanner does not rotate or rotates too fast/slow.

- If a bearing pulse is not sent from the scanner unit, NO BP indication blinks at the upper left-hand side of the screen at "ST-BY" mode.
- \* Jammed scanner rotating mechanism
  - \* Defective scanner motor (B801)
  - \* Defective motor control circuit on MP board (MP-8070)

#### 3) Picture synchronization is abnormal.

- \* Defective SPU board (SPU-7880)
- \* Deflection board of CRT assembly  
Adjust potentiometers VR401 ("V-HOLD") and VR202 ("H-HOLD") for horizontal and vertical synchronization, respectively.

#### 4) Sweep rotation is not synchronized with antenna rotation.

- \* Defective scanner motor (B801)
- \* Defective MD board (MD-7918)
- \* Defective SPU board (SPU-7880)

#### 5) Marks and legends appear but no echo nor noise appear.

- \* Discontinuity or shortcircuit of video signal coaxial cable
- \* Defective SPU board (SPU-7880)
- \* Defective IF board (IF-7758)

## 6) Poor sensitivity

\* Deteriorated magnetron (V801)  
Refer to "CHECKING THE MAGNETRON" below.

\* Detuned MIC (U801)

## 7) Noise appears but no echo.

\* Defective MD board (MD-7918)

\* Defective IF board (IF-7758)

\* Magnetron heater voltage not applied  
Refer to "MAGNETRON HEATER VOLTAGE ADJUSTMENT" on page 20.

\* Defective magnetron (V801)  
Refer to "CHECKING THE MAGNETRON" below.

## 8) Best tuning is not obtained at mid-travel of TUNE control.

\* Frequency deviation of the magnetron  
Refer to "TUNING & TUNING INDICATOR SENSITIVITY ADJUSTMENT" on page 19.

## 9) Heading mark is not displayed.

The message NO HD blinks at the upper left-hand side of the screen when a heading pulse is not received.

\* Defective heading mark key S801

\* Defective SPU board (SPU-7880)

## CHECKING THE MAGNETRON (Measuring the Magnetron Current)

The life of the magnetron largely depends on how many hours it is used. Fewer target echoes appear on the screen when the magnetron gets "old." To determine magnetron suitability, use the following procedure to measure the magnetron current.

1. Turn off the SCANNER switch to temporarily stop antenna rotation.
2. Connect a multimeter, set to 10VDC range, to pin #5(+) and #6(-) of TP803 on the MD-7918 modulator board. See Fig.53.
3. Pull out jumper JMP2 on the SPU-7880 processor board, and operate the radar for transmission on 0.25nm range. See Fig.52
4. Confirm that the magnetron current (voltage) is 0.5 to 1.2Vdc. The magnetron current is measured as a voltage.
5. Change the range setting to 24 nm and confirm that the voltage is 0.9 to 1.1Vdc.

If the voltage is far out of the range specified above, the magnetron may be faulty. Never forget to put back jumper JMP2 after checking.

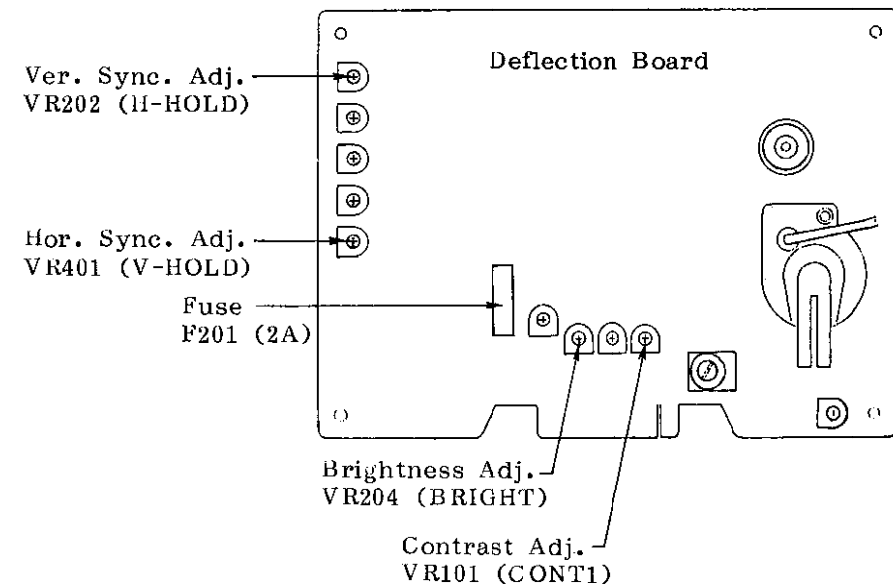

Note: Since the CRT is turned 90°, the indications "V" and "H" correspond to "horizontal" and "vertical", respectively.

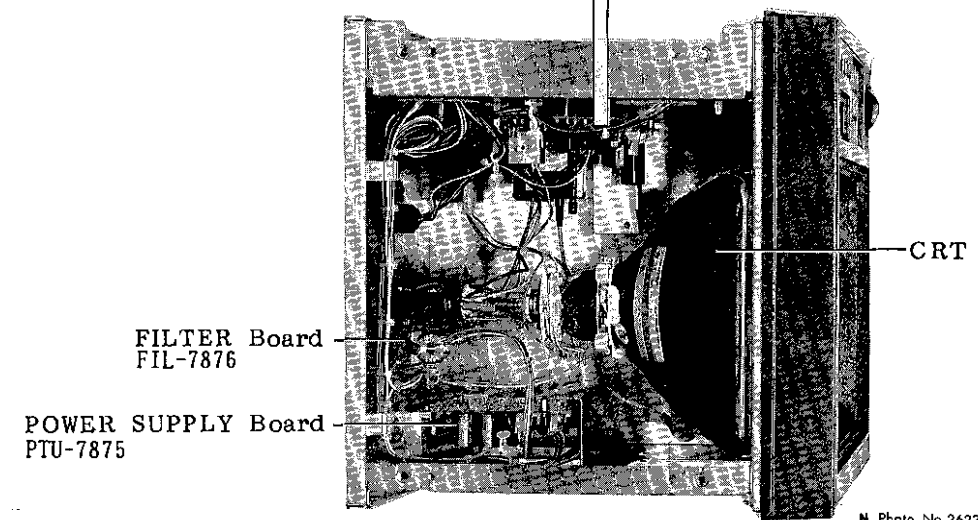

Fig.51 Display Unit Top View

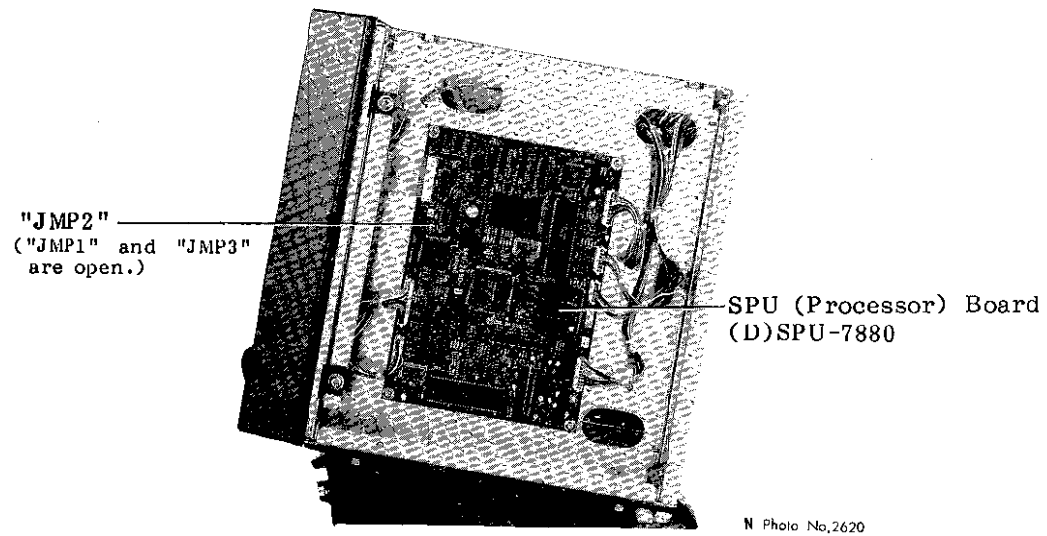

Fig.52 Display Unit Side View

### SCHEMATIC DIAGRAMS

No.	Title	Type	Dwg. No.	Page
1	INTERCONNECTION DIAGRAM		C3327-C01	S-1
2	DISPLAY UNIT		C3327-K01	S-2
3	POWER SUPPLY	PTU-7875	C3319-K02	S-3
4	PRESET CONT./POT. ASSY.	ADJ-8147/ VOL-8148	C3327-K04	S-4
5	TRACKBALL	EUA-FTF814	C3327-K03	S-5
6	CRT DISPLAY	MG-1252SFR	C3328-K05	S-6
7	SCANNER UNIT		C3319-K05	S-7
8	IF AMPLIFIER	IF-7758	C3319-K07	S-8

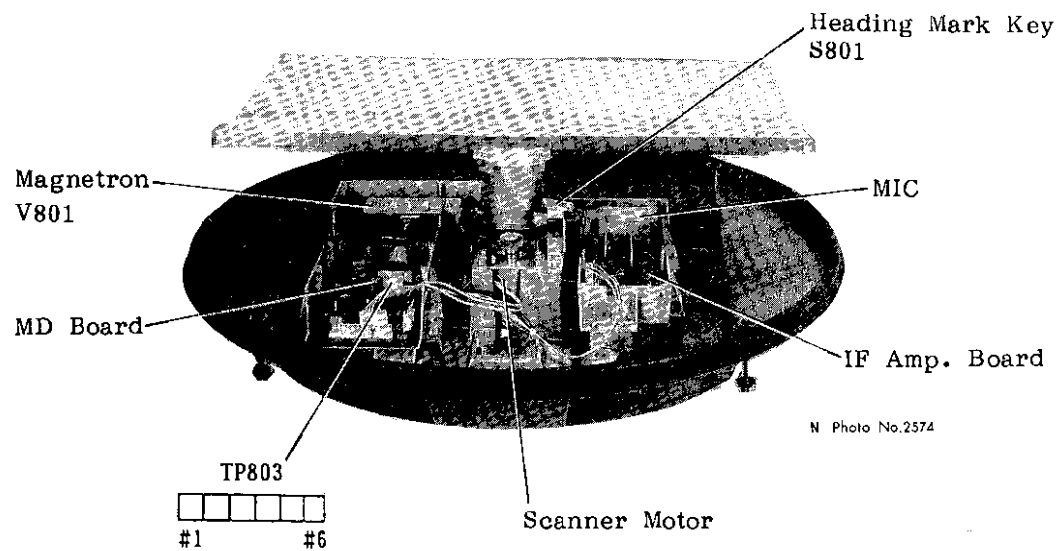
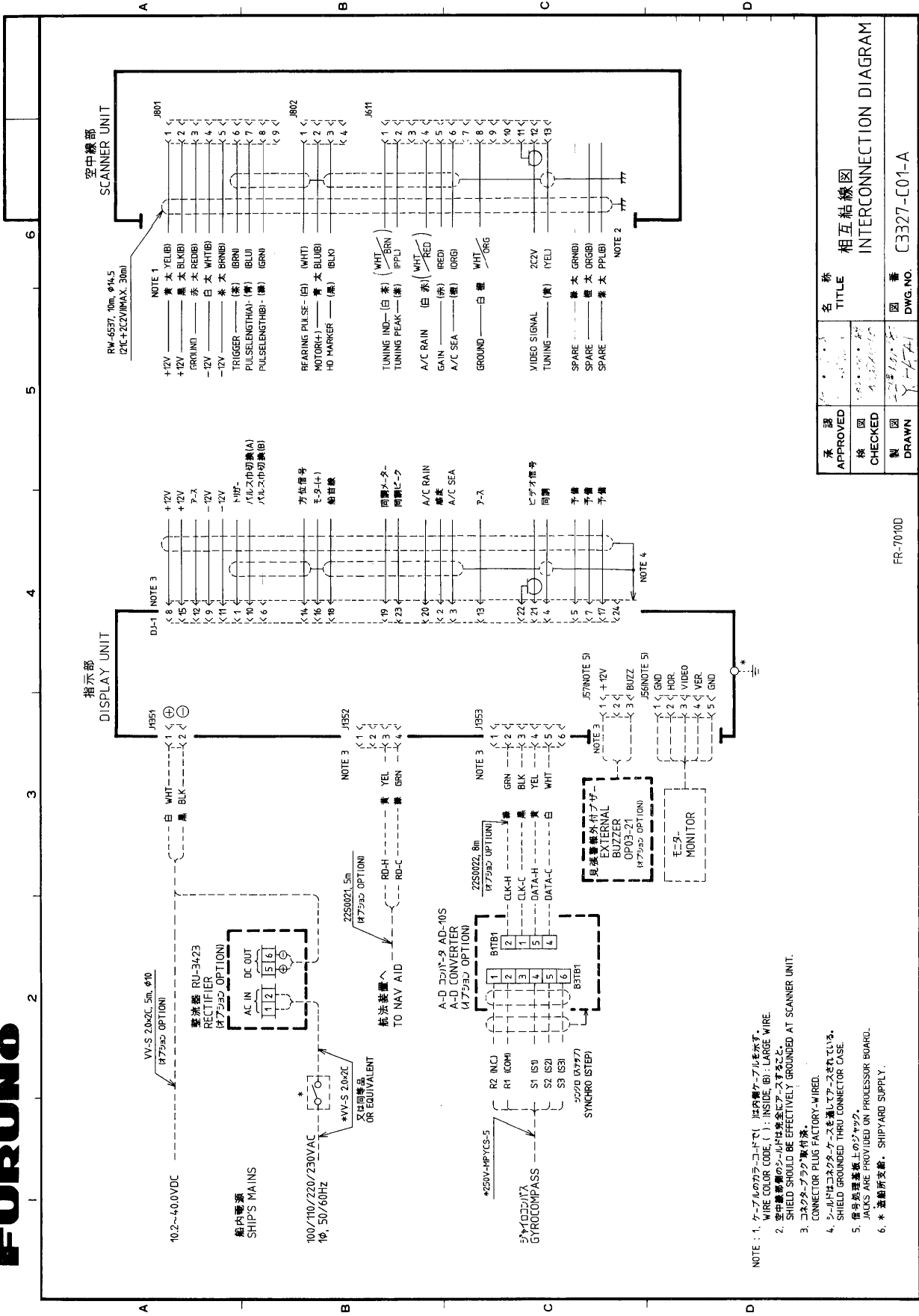

Fig.53 Scanner Unit Inside View

### OUTLINE DRAWINGS

No.	Title	Type	Dwg. No.	Page
1	RADAR DISPLAY UNIT	RDP-079	C3327-G01	D-1
2	RADAR SCANNER UNIT	RSB-0034	C3319-006	D-2





- NOTE : 1. プラグのカラーコードは、社内標準マニュアルを示す。  
WIRE COLOR CODE ( ) : INSIDE, (B) : LARGE WIRE.  
2. 空中機部のシールドは完全にアースすること。  
SHIELD SHOULD BE EFFECTIVELY GROUNDED AT SCANNER UNIT.  
3. コネクタプラグは本廠製。  
CONNECTOR PLUG FACTORY-WIRED.  
4. シールドはコネクタケースを通してアースされている。  
SHIELD GROUNDED THRU CONNECTOR CASE.  
5. 信号処理基板上のジャック。  
JACKS ARE PROVIDED ON PROCESSOR BOARD.  
6. \* 造船所支給。SHIPYARD SUPPLY.

FURUNO ELECTRIC CO., LTD.

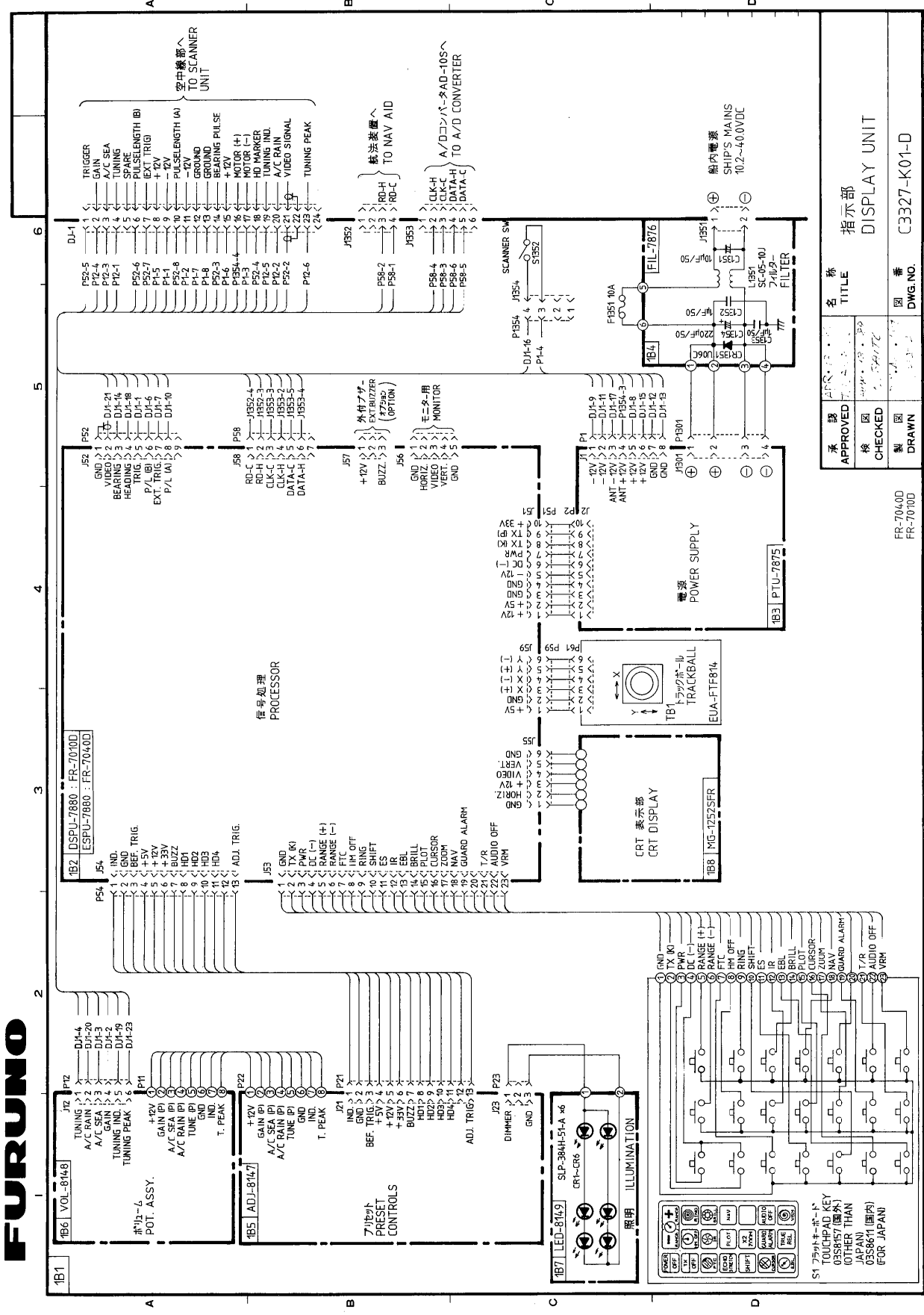

FURUNO ELECTRIC CO., LTD.

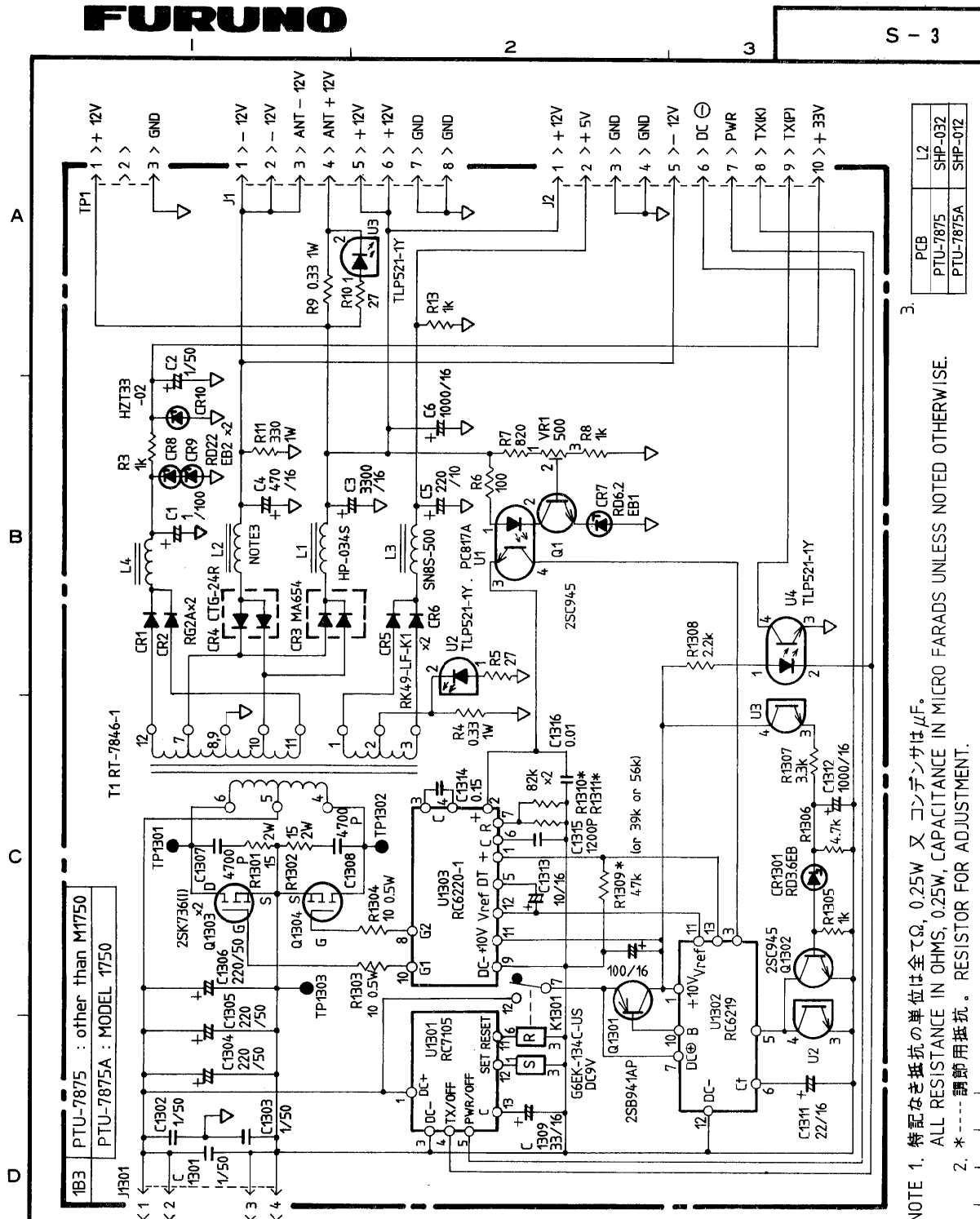

NOTE 1. 特記なき抵抗の単位は全てΩ, 0.25W 又コンデンサはμF.  
 ALL RESISTANCE IN OHMS, 0.25W, CAPACITANCE IN MICRO FARADS UNLESS NOTED OTHERWISE.  
 2. \* ---- 誘電用抵抗。RESISTOR FOR ADJUSTMENT.

FIL基板より FROM FIL PCB  
 MODEL 1730/1750/1760  
 FR-7010D/7040D  
 MODEL 1830/1930/1940

承認 APPROVED	検図 CHECKED	製図 DRAWN	品番 ITEM	品名 NAME	材質 MATERIAL	数量 Q'TY	図番 DWG. NO.	摘要 REMARKS
				三角法 THIRD ANGLE PROJECTION				名称 TITLE PTU-7875 電源基板 POWER SUPPLY
				尺 SCALE				重量 WEIGHT
							図番 DWG. NO. C3319-K02-F	

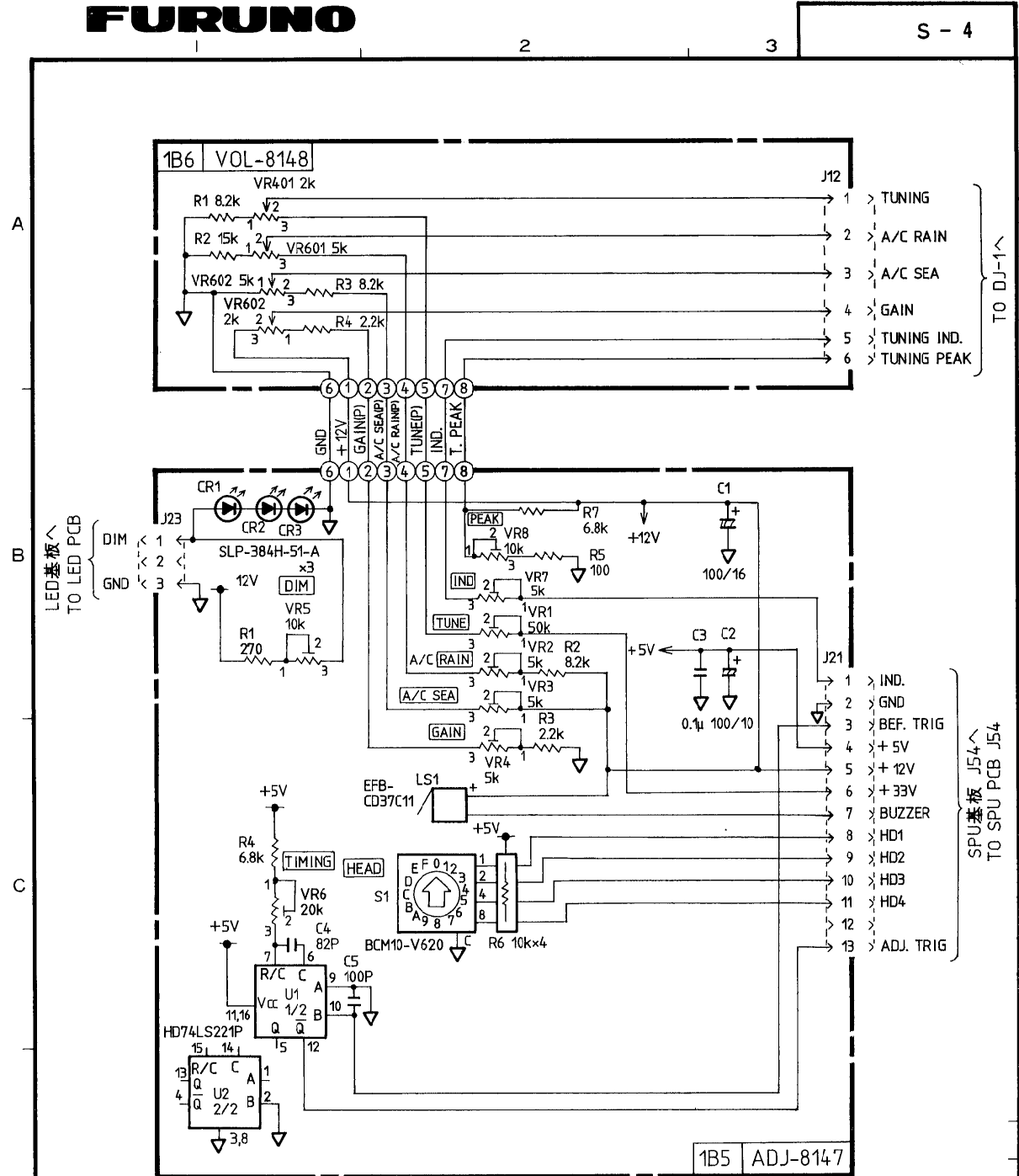

NOTE 1. 特記なき抵抗の単位は全てΩ, 0.25W 又コンデンサはF.  
 ALL RESISTANCE IN OHMS, 0.25W, CAPACITANCE IN FARADS UNLESS NOTED OTHERWISE.

承認 APPROVED	検図 CHECKED	製図 DRAWN	品番 ITEM	品名 NAME	材質 MATERIAL	数量 Q'TY	図番 DWG. NO.	摘要 REMARKS
				三角法 THIRD ANGLE PROJECTION				名称 TITLE ADJ-8147 プリセット基板 PRESET CONTROLS
				尺 SCALE				重量 WEIGHT
							図番 DWG. NO. C3327-K04-A	



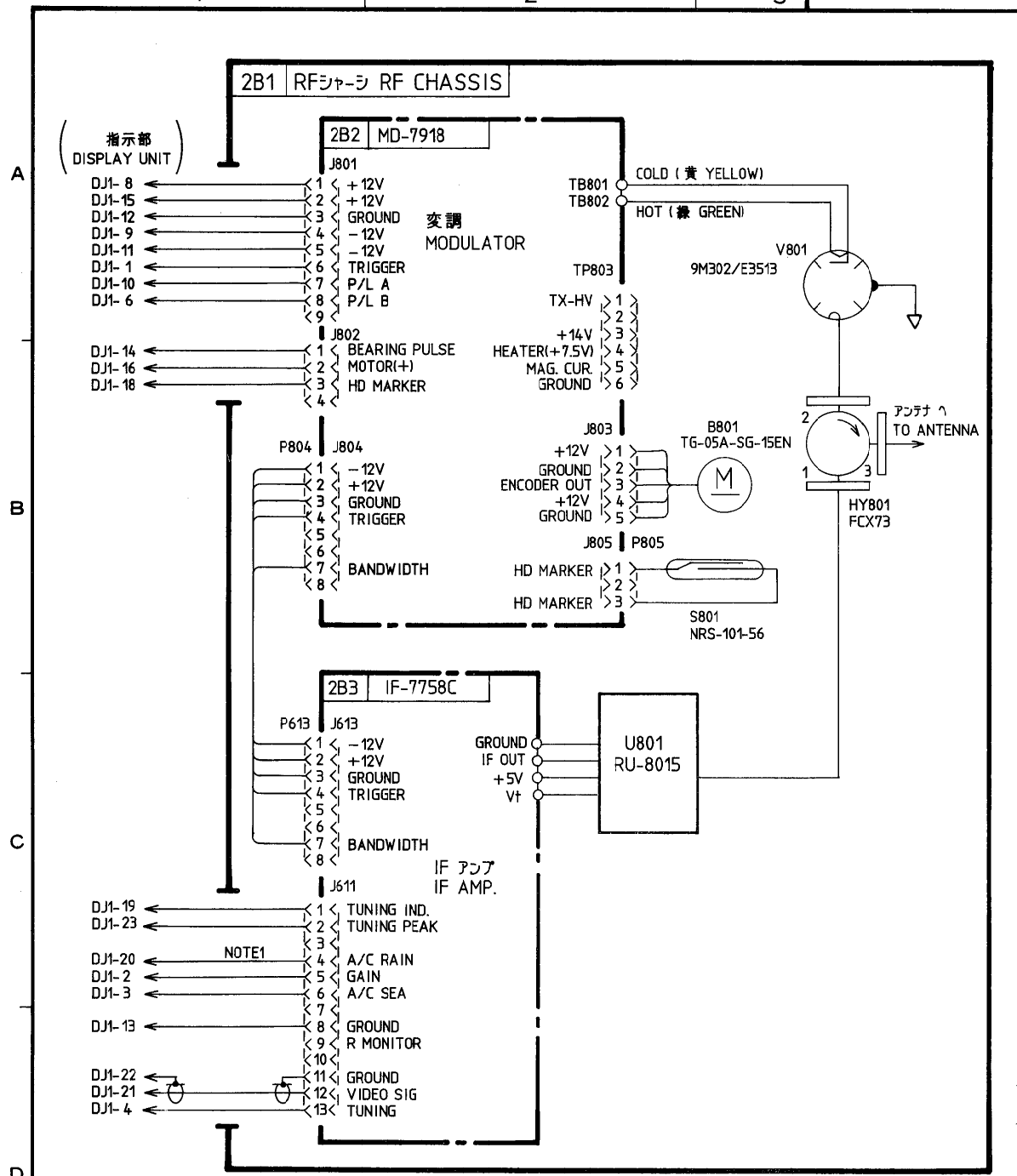

NOTE1. FR-7010Dの場合のみ。MODEL1830/1730時は空き。  
ONLY FOR FR-7010D, WHILE NO CONNECTION FOR MODEL 1830/1730.

MODEL 1730  
FR-7010D  
MODEL 1830

承認 APPROVED	検図 CHECKED	製図 DRAWN	品番 ITEM	品名 NAME	材質 MATERIAL	数量 Q'TY	図番 DWG. NO.	摘要 REMARKS
Feb. 28. 89	Feb. 28. 89	Y. HATAI		三角法 THIRD ANGLE PROJECTION				名称 TITLE 空中線部 SCANNER UNIT
				尺度 SCALE				重量 WEIGHT
				kg			図番 DWG. NO.	C3319-K05-E

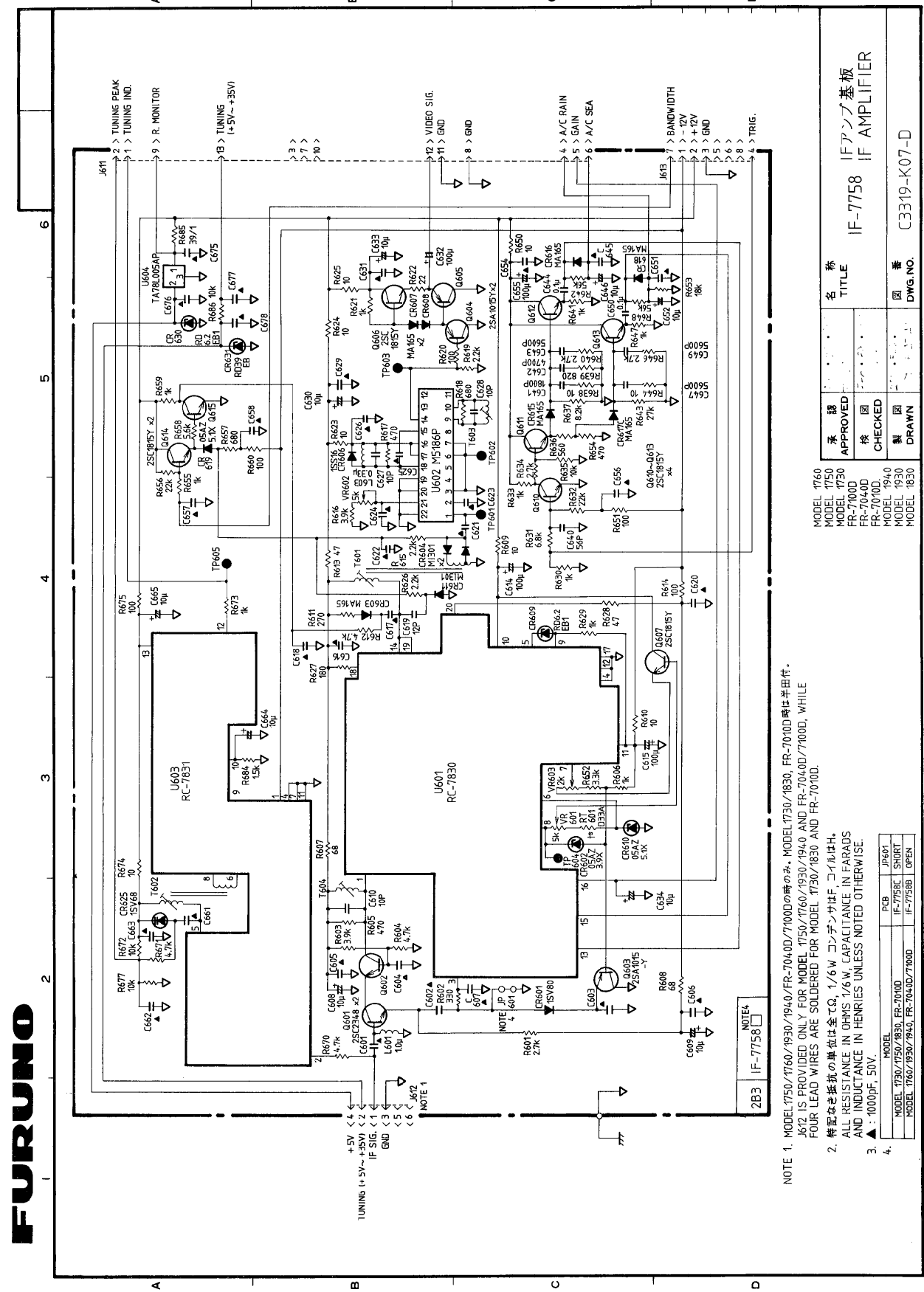

承認 APPROVED	検図 CHECKED	製図 DRAWN	品番 ITEM	品名 NAME	材質 MATERIAL	数量 Q'TY	図番 DWG. NO.	摘要 REMARKS
MODEL 1760	MODEL 1730	MODEL 1830		IFアンプ基板 IF AMPLIFIER				名称 TITLE IFアンプ基板 IF AMPLIFIER
				尺度 SCALE				重量 WEIGHT
				kg			図番 DWG. NO.	C3319-K07-D

NOTE 1. MODEL1750/1760/1930/1940/FR-7040D/7100Dの場合のみ。MODEL1730/1830、FR-7010D時は半田付。  
J612 IS PROVIDED ONLY FOR MODEL 1750/1760/1930/1940 AND FR-7040D/7100D, WHILE  
FOUR LEAD WIRES ARE SOLDERED FOR MODEL 1730/1830 AND FR-7010D.

2. 特配なき抵抗の単位は全て、1/6W。コンデンサは、コイルは、  
ALL RESISTANCE IN OHM'S 1/6W, CAPACITANCE IN FARADS  
AND INDUCTANCE IN HENRIES UNLESS NOTED OTHERWISE.

3. ▲ : 1000PF, 50V.  
4.

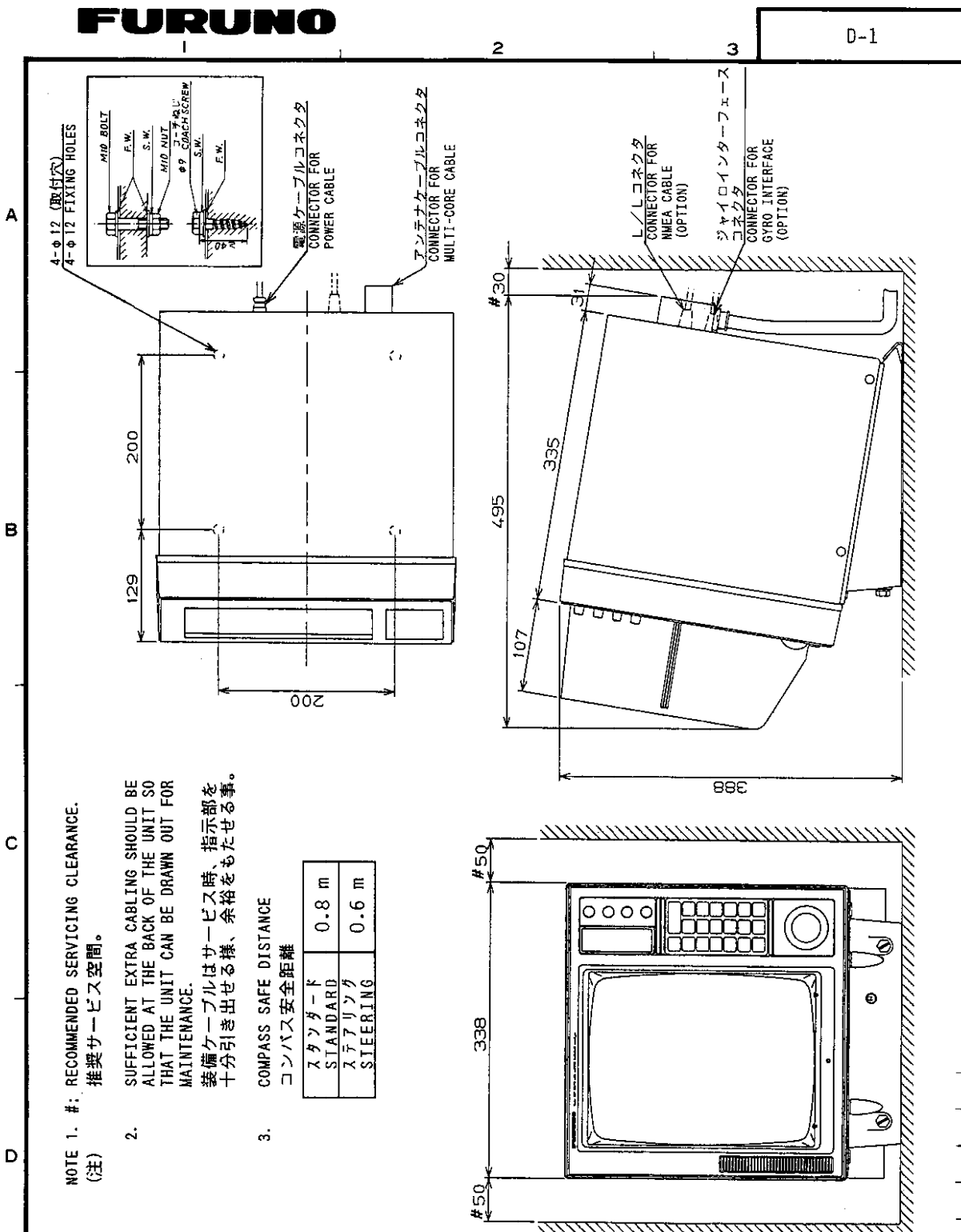

NOTE 1. #: RECOMMENDED SERVICING CLEARANCE.  
推奨サービス空間。

2. SUFFICIENT EXTRA CABLING SHOULD BE ALLOWED AT THE BACK OF THE UNIT SO THAT THE UNIT CAN BE DRAWN OUT FOR MAINTENANCE.  
装備ケーブルはサービス時、指示部を十分引き出せる様、余裕をもたせる事。

3. COMPASS SAFE DISTANCE  
コンパス安全距離

スタンダード	0.8 m
ステアリング	0.6 m

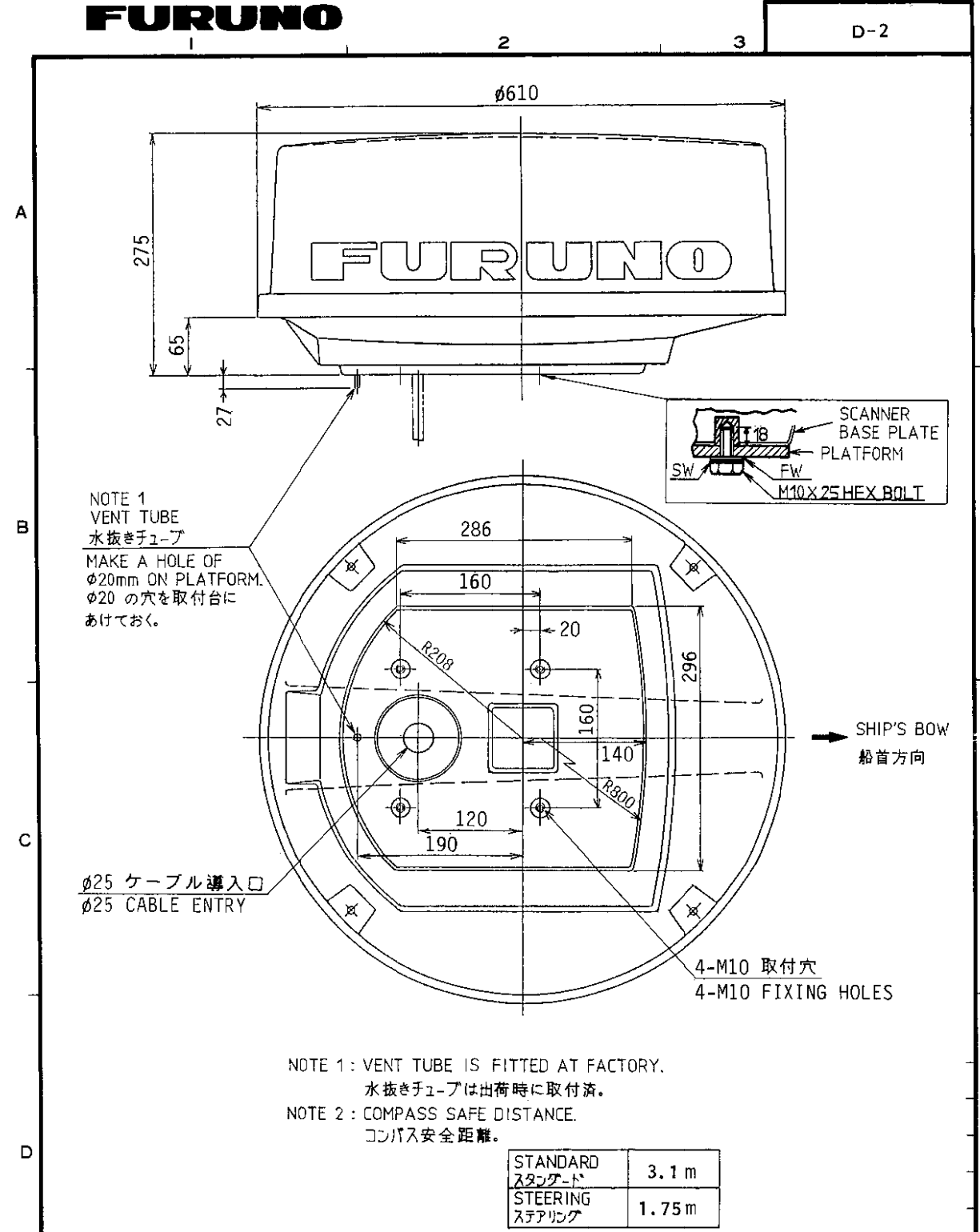

NOTE 1  
VENT TUBE  
水抜きチューブ  
MAKE A HOLE OF  
φ20mm ON PLATFORM.  
φ20 の穴を取付台に  
あけておく。

NOTE 1: VENT TUBE IS FITTED AT FACTORY.  
水抜きチューブは出荷時に取付済。

NOTE 2: COMPASS SAFE DISTANCE.  
コンパス安全距離。

スタンダード	3.1 m
STEERING	1.75 m

## Free Manuals Download Website

<http://myh66.com>

<http://usermanuals.us>

<http://www.somanuals.com>

<http://www.4manuals.cc>

<http://www.manual-lib.com>

<http://www.404manual.com>

<http://www.luxmanual.com>

<http://aubethermostatmanual.com>

Golf course search by state

<http://golfingnear.com>

Email search by domain

<http://emailbydomain.com>

Auto manuals search

<http://auto.somanuals.com>

TV manuals search

<http://tv.somanuals.com>