

# FURUNO

# OPERATOR'S MANUAL

MARINE RADAR

---

MODEL FR-8051/8111/8251



**FURUNO ELECTRIC CO., LTD.**  
NISHINOMIYA, JAPAN



(Elemental Chlorine Free)

The paper used in this manual  
is elemental chlorine free.

© **FURUNO ELECTRIC CO., LTD.**

9-52 Ashihara-cho,  
Nishinomiya 662-8580, JAPAN

Telephone : 0798-65-2111

Fax : 0798-65-4200

FURUNO Authorized Distributor/Dealer

All rights reserved.

Printed in Japan

Pub. No. OME-34240

( AKMU ) FR-8051/8111/8251

FIRST EDITION : NOV. 1995

G3 : MAY. 07, 2005



\* 0 0 0 8 0 7 3 5 2 1 1 \*



\* O M E 3 4 2 4 0 G 3 0 \*



# SAFETY INFORMATION

"**DANGER**", "**WARNING**" and "**CAUTION**" notices appear throughout this manual. It is the responsibility of the operator of the equipment to read, understand and follow these notices. If you have any questions regarding these safety instructions, please contact a FURUNO agent or dealer.



**DANGER**

This notice indicates a potentially hazardous situation which, if not avoided, will result in death or serious injury.



**WARNING**

This notice indicates a potentially hazardous situation which, if not avoided, could result in death or serious injury.

**CAUTION**

This notice indicates an unsafe practice which, if not avoided, could result in minor or moderate injury, or property damage.



# DANGER



This equipment uses high voltage electricity which can shock, burn or cause death.

Only qualified personnel should work inside the enclosures.

**Do not disassemble or modify the equipment.**

Fire, electrical shock or serious injury can result.



# DANGER



Turn off the radar power switch before servicing the antenna unit. Post a warning sign near the switch indicating it should not be turned on while the antenna unit is being serviced.

Serious injury or death can result if the radiator starts rotating and strikes someone near the scanner unit.



**Wear a safety belt and hard hat when working on the antenna unit.**

Serious injury or death can result if someone falls from the scanner mast.

# WARNING

## Radio Frequency Radiation Hazard

The radar antenna emits electromagnetic radio frequency (RF) energy which can be harmful, particularly to your eyes. Never look directly into the antenna aperture from a close distance while the radar is in operation or expose yourself to the transmitting antenna at a close distance.

Distances at which RF radiation levels of 100 and 10 W/m exist are given in the table below.

Model	Radiator type	Distance to 100 W point	Distance to 10 W point	RF power density on antenna aperture
FR-8051 (X-band, 6 kW)	XN2 (4')	Nil	Nil	Not measured
	XN3 (6.5')	Nil	Nil	
	XN3A (6.5')	Nil	Nil	
	XN4A (8')	Nil	Nil	
FR-8111 (X-band, 10 kW)	XN2 (4')	Worst case 0.25 m*	Worst case 2.3 m*	11.0 W/m <sup>2</sup>
	XN3 (6.5')			9.6 W/m <sup>2</sup>
	XN3A (6.5')			9.6 W/m <sup>2</sup>
	XN4A (8')			6.7 W/m <sup>2</sup>
FR-8251 (X-band, 25 kW)	XN2 (4')	Worst case 0.6 m*	Worst case 3.25 m*	29.0 W/m <sup>2</sup>
	XN3 (6.5')			23.8 W/m <sup>2</sup>
	XN3A (6.5')			23.8 W/m <sup>2</sup>
	XN4A (8')			20.6 W/m <sup>2</sup>

**Note:** If the antenna unit is installed at a close distance in front of the wheel house, your administration may require halt of transmission within a certain sector of antenna revolution. This is possible—Ask your FURUNO representative or dealer to provide this feature.

\* UK DRA measured on FR-2810/2820. Other values by FURUNO.



# WARNING

**Turn off the power at the mains switchboard if metallic object or liquid falls into the equipment.**

Continued use can result in electrical shock or fire.

**Use the correct fuse.**

Use of the wrong fuse can cause fire or electrical shock.

**Ensure no water splash or rain leaks into the equipment.**

Water in the equipment can result in fire or electrical shock.

**Turn off the power at the mains switchboard if the unit is emitting smoke or fire.**

Continued use can result in fire or electrical shock.

**Do not place liquid-filled containers on the top of the equipment.**

Fire or electrical shock can result if a liquid leaks into the equipment.

**Keep heaters away from the equipment.**

Heat can melt the power cord, which can result in fire or electrical shock.

# CAUTION

**Immediately turn off the power whenever you feel the equipment is abnormal.**

Continued use can cause equipment damage.

**Keep magnets and magnetic fields (speaker, transformer, etc.) way from the equipment.**

Magnets and magnetic fields can cause equipment malfunction.

## **COMPLIANCE WITH R&TTE DIRECTIVE 1999/5/EC**

This radar complies with the R&TTE Directive 1999/5/EC. In accordance with Article 6-3 of this directive, FURUNO intends to put this radar on the market of the following countries in EU as well other markets.

Austria, Belgium, Cyprus, Denmark, Estonia, Finland, France, Germany, Greece, Hungary, Ireland, Italy, Latvia, Lithuania, Malta, Poland, Portugal, Slovenia, Spain, Sweden, The Netherlands, United Kingdom, Iceland, Norway

# TABLE OF CONTENTS

SAFETY INFORMATION .....	i
FOREWORD .....	viii
CONFIGURATION OF FR-8051/8111/8251 .....	ix
SPECIFICATIONS .....	x
EQUIPMENT LISTS .....	xii
CATEGORIZATION BY SPECIFICATION .....	xiv

## Chapter 1 OPERATION

Control Description .....	1-1
Display Indications .....	1-2
1.1 Turning the Radar On/Off .....	1-4
1.2 Transmitting, Stand-by .....	1-4
1.3 Selecting Range .....	1-4
1.4 Presentation Mode .....	1-5
1.5 Menu Overview .....	1-7
1.6 Tuning the Receiver .....	1-10
1.7 Adjusting Sensitivity .....	1-10
1.8 Adjusting Picture Brilliance .....	1-10
1.9 Adjusting Brilliance of Control Panel and Markers .....	1-11
1.10 Adjusting Range Ring Brilliance .....	1-11
1.11 Suppressing Sea Clutter .....	1-11
1.12 Suppressing Rain Clutter .....	1-12
1.13 The Heading and North Markers .....	1-12
1.14 Measuring the Range .....	1-12
1.15 Measuring Bearing .....	1-13
1.16 Collision Assessment by the Offset EBL .....	1-14
1.17 Measuring Range and Bearing Between Two Targets .....	1-14
1.18 Index Lines .....	1-15
1.19 Off-centering the Picture .....	1-15
1.20 Zoom .....	1-16
1.21 Inscribing Marks on the Display .....	1-16
1.22 The FUNCTION key .....	1-16
1.23 Own Ship Speed .....	1-17
1.24 Ship's Graphic .....	1-18
1.25 Interference Rejector .....	1-18
1.26 Echo Trails .....	1-18
1.27 Electronic Plotting (E-plot) .....	1-20
1.28 Setting a Guard Alarm Zone .....	1-22
1.29 Watch Alarm .....	1-23
1.30 Echo Average .....	1-23
1.31 Suppressing Second-Trace Echoes .....	1-24
1.32 Echo Stretch .....	1-25
1.33 Noise Rejection .....	1-25
1.34 Selecting Pulselength .....	1-25
1.35 Waypoint Display .....	1-26



1.36 Outputting Cursor Position (TLL data) .....	1-26
1.37 Selecting Unit of Range Measurement, Bearing Reference .....	1-27
1.38 Sector Blanking .....	1-27
1.39 Alarm Output Signal On/Off .....	1-27

## **Chapter 2 RADAR OBSERVATION**

2.1 Radar Picture, Target Properties and Radar Pulse .....	2-1
2.2 Range Resolution .....	2-1
2.3 Bearing Resolution .....	2-2
2.4 False Echoes .....	2-2
2.5 Minimum and Maximum Ranges .....	2-3
2.6 Locating a Ship or Survival Craft in Distress by SART .....	2-4

## **Chapter 3 MAINTENANCE**

3.1 Periodic Maintenance Schedule .....	3-2
3.2 Life Expectancy of Major Parts .....	3-2

## **Chapter 4 TROUBLESHOOTING**

4.1 Simple Troubleshooting .....	4-1
4.2 Advanced-level Troubleshooting .....	4-2
4.3 Diagnostic Test .....	4-5

## **Chapter 5 LOCATION OF PARTS**

5.1 Antenna Unit .....	5-1
5.2 RF Transceiver Unit.....	5-2
5.3 Display Unit (common to all models) .....	5-4

## **Appendix A DESCRIPTION OF OPTIONAL EQUIPMENT**

A.1 Performance Monitor .....	A-1
A.2 Auto Plotter ARP-15 .....	A-2
A.3 Video Plotter RP-15 .....	A-2
A.4 Fluxgate Heading Sensor C-2000 .....	A-2

## **Declaration of Conformity**

# FOREWORD

---

## A Word to FR-8051/8111/8251 Owners

FURUNO Electric Company thanks you for purchasing the FR-8051/8111/8251 Marine Radar. We are confident you will discover why the FURUNO name has become synonymous with quality and reliability.

For over 40 years FURUNO Electric Company has enjoyed an enviable reputation for quality and reliability throughout the world. This dedication to excellence is furthered by our extensive global network of agents and dealers.

Your radar is designed and constructed to meet the rigorous demands of the marine environment. However, no machine can perform its intended function unless properly installed and maintained. Please carefully read and follow the operation and maintenance procedures set forth in this manual.

We would appreciate feedback from you, the end-user, about whether we are achieving our purposes.

Thank you for considering and purchasing FURUNO.

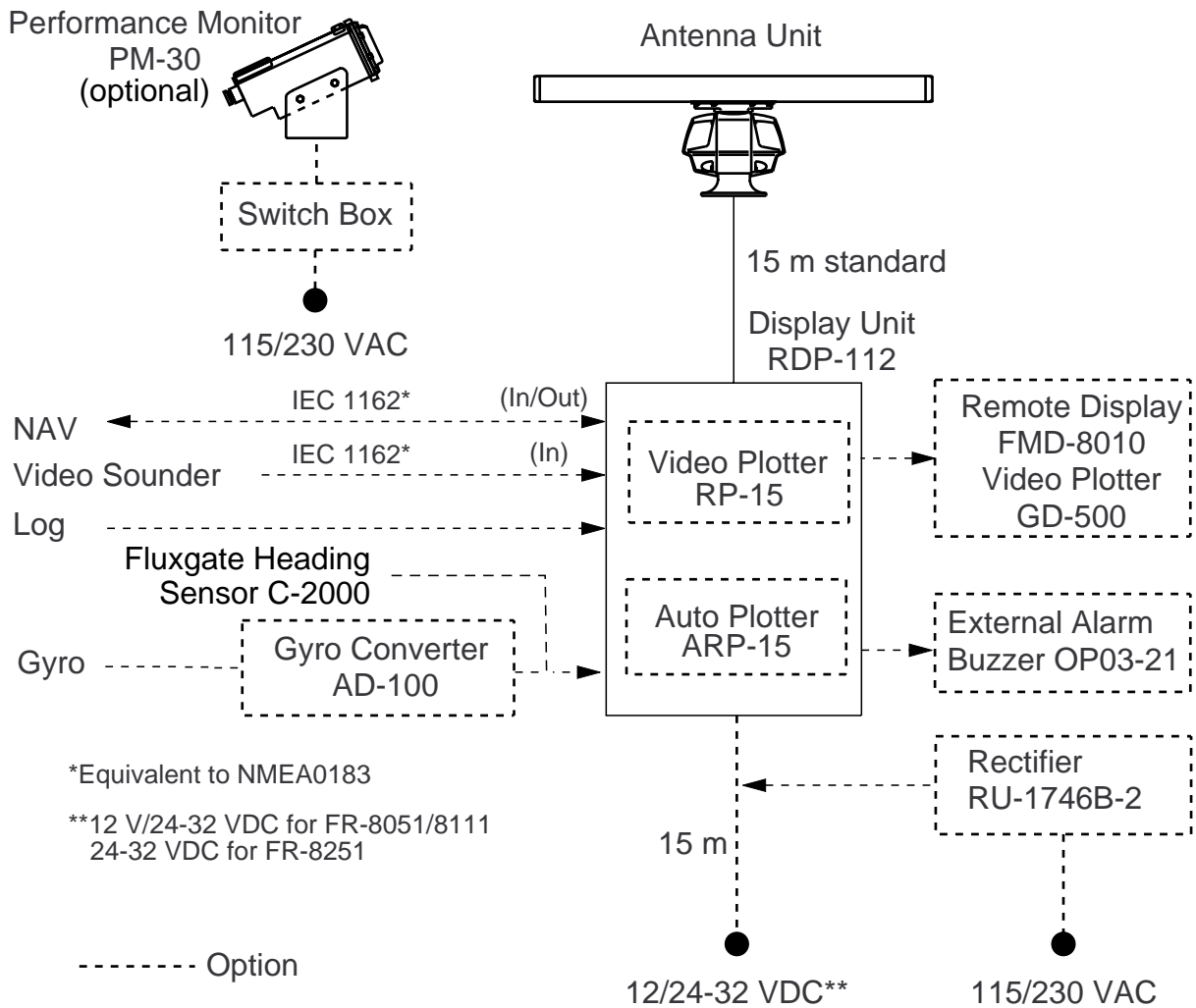
## Features

The FR-8051/8111/8251 has a large variety of functions, all contained in a rugged case.

All controls respond immediately to the operator's command and each time a key is pressed, the corresponding change can be seen on the screen immediately.

- High definition 12-inch raster-scan display.
- Precision slotted waveguide antenna capable of withstanding 100 knot wind velocity.
- Eight levels of target quantization for high target definition.
- On-screen alphanumeric readout of all operational information including ship's position and speed.
- Unique function key automatically sets up for optimum performance with environments and targets.
- Automatic suppression of sea and rain clutter.
- Echo trails to assess targets' speeds and courses.
- Presentation modes: Head-up, Course-up, North-up and True Motion.
- Aural alarm alerts when targets enter (or exit) an area.
- Floating EBL provides measurements of range and bearing between two targets.
- Electronic target plotting.
- Waypoint data from external navigator.
- Dual VRMs and EBLs.

# CONFIGURATION OF FR-8051/8111/8251



# SPECIFICATIONS

## Antenna Unit

Type	Slotted waveguide array			
Polarization	Horizontal			
Length	4 ft(XN2)	6.5 ft(XN3)	6.5 ft (XN3A)	8 ft(XN4A)
Beamwidth	1.8 x 25°	1.2 x 25°	1.23 x 20°	0.9 x 20°
Rotation speed	24 rpm (36 rpm optional)			

## Transceiver Module

Frequency	9410 MHz ± 30 MHz (X-band)
Peak output power	FR- 8051: 6 kW FR- 8111: 10 kW FR- 8251: 25 kW
Transmitting tube	FR- 8051: MAF1422B FR- 8111: MAF1425B FR- 8251: 9M752 or M5187F

## Pulselength (PL) & Pulse Repetition Rate (PRR)

		Range (nautical miles)												
PL	PRR	0.125	0.25	0.5	0.75	1.5	3	6	12	24	48	72	96	
SP	2100Hz	0.08 microseconds												
MP1	2100Hz				0.3 microseconds									
MP2	1200Hz						0.6 microseconds							
LP	600Hz*							1.2 microseconds						

\* 500 Hz on 72, 96 nm range

500 Hz when 2nd trace echo rejection is off (MP1, MP2, LP only)

Modulator	FR-8051/8111: FET switching method FR-8251: Line Pulse
I/F amplifier	Logarithmic, IF 60 MHz Bandwidth: 25MHz (0.08 μs), 2.5 MHz (0.3 μs, 0.6 μs, 1.2 μs)
Tuning	Automatic or manual
Receiver front end	MIC (Microwave IC)
Duplexer	Circulator with diode limiter

## Display Unit

Picture tube 12-inch rectangular green phosphor CRT, 640(H) x 481(V) dots  
 Effective display diameter 180 mm  
 Range (nm), Range ring interval (nm), Number of range rings

Range (nm)	0.125	0.25	0.5	0.75	1.5	3	6	12	24	48	72	96
Ring intvl (nm)	0.025	0.05	0.1	0.25	0.25	0.5	1	4	4	8	12	16
No. of rings	5	5	5	3	3	6	6	6	6	6	6	6

† Can be set to 1, 2, 4, 8, 16 or 32 nm when interfaced with video plotter.

\* Maximum ranges: FR-8051, 48 nm; FR-8111, 72 nm, FR-8251, 96 nm

Minimum range 25 m on 0.25 nm scale  
 Range discrimination 20 m on 0.75 nm scale  
 Accuracy Range: 1% of range in use or 8 m, whichever is the greater  
 Bearing: 1°

## Environmental Conditions

Standards IEC 945  
 Ambient temperature Antenna unit: -25°C to +70°C  
 Display unit: -15°C to +55°C  
 Humidity Relative humidity 95% at +40°C  
 Waterproof test Pressure 3.6 kg/cm<sup>2</sup> (antenna unit)

## Power Supply and Power Consumption

12 V(FR-8051/8111), 24 V, 32 VDC, or  
 100 V, 110 V, 115 V, 220 V, 230 VAC, 50/60 Hz, 1ø (rectifier required)  
 FR-8051, 75 W; FR-8111, 90 W; FR-8251, 130 W

## Others

Nav Data Input/Output **Input** (IEC 1162\*) - - GP, LC, or any talker  
 BWC, DTP, GLL, GLC, HDG, MDA, RMA, RMB, RMC, VTG, DBK,  
 DBS, DBT, GTD, HDM, HDT, MTW, BWR, VHW, ZDA  
 AD-100 format heading data  
**Output** (IEC 1162) TLL, RSD, and TTM (w/ARP  
 \*:IEC 1162 is equivalent to NMEA0183, V2.0

Coating color Antenna unit: Munsell N9.5 (white)  
 Display unit housing: 2.5GY5/1.5 (light gray)  
 Panel: N3.0 (black)

Compass safe distance	Standard compass	Steering compass
Display unit (RDP-112):	1.3 m	1.0 m
Antenna unit (C2P7N2N, 6 kW):	3.4 m	2.2 m
(C2P7N2N, 10 kW):	3.8 m	2.4 m
(RSB-0014, 25 kW):	4.3 m	2.5 m

# EQUIPMENT LISTS

## Standard Set

No.	Name	Type	Qty	Remarks
1	Scanner unit (FR-8051)	C2P7N2N(RSB-0063)	1	24 rpm (36 rpm optional) RF unit: RTR-0043
	Scanner unit (FR-8111)	C2P7N2N(RSB-0063)		24 rpm (36 rpm optional) RF unit: RTR-0044
	Scanner unit (FR-8251)	RSB-0014(RSB-0064)		24 rpm (36 rpm optional) RF unit: RTR-0045
2	Display unit	RDP-112-*	1	* A, FR-8051; B, FR-8111; C, FR-8251
3	Accessories	FP03-05310	1 set	Viewing hood and filter
4	Display unit installation materials	CP03-15101	1 set	For display unit
5	Scanner unit installation materials	CP03-14401	1 set	For antenna unit
6	Signal cable	S03-53-†	1 set	†: 15 m (20, 25, 30 m optional)
	ML connector assy	CP03-14202		For high voltage line
7	Display unit spare parts	SP03-11901	1 set	
8	Scanner unit spare parts	SP03-11102	1 set	

## Optional Equipment

No.	Name	Type	Code No.	Remarks
1	Signal cable	S03-55-5	008-455-160	w/XH-5P connector, 5 m CO-2P cable
2	Interswitch unit	RJ-2	000-030-062	
3	Rectifier unit	RU-1746B-2	000-030-439	115 VAC
			000-030-440	230 VAC
4	Power cable	CVV-S 8 x 2C 15m	000-560-634	
5	Color display	CD-140	000-000-507	
		CD-141	000-000-508	
6	Slave display	FMD-8010		
7	Remote display	FMD-1800		
8	Video plotter	GD-500/500 Mark 2		
9	External buzzer	OP03-21	000-030-097	
10	Vinyl cover	03-034-0401	000-801-657	
11	Auto plotter	ARP-15		
12	Video plotter	RP-15		
13	EMI filter	FP03-05500	008-456-990	
14	Hood w/lens	OP03-120	000-030-097	
15	Performance monitor	PM-30		
16	Gyro converter	AD-100		

## Spare Parts

No.	Name	Type	Code No.	Qty	Remarks
1	Fuse	FGBO 10 A 125 VAC	000-549-065	2	24 V/32 V
2	Fuse	FGBO 20 A 125 VAC	000-549-015	2	12 V
3	Carbon brush for scanner motor	MG120-5X6X11 D8G	000-631-716	2	

# CATEGORIZATION BY SPECIFICATION

---

This series of marine radars are designed to comply with the standards of various national rules and regulations. Operational convenience is enhanced with the two categories as below although the basic design approach is the same.

<b>Function</b>	<b>R-type</b>	<b>N-type</b>
Guard zone alarm	"In" or "Out" alarm	"In" alarm only
VRM/cursor unit of readout	nm, km, sm	nm only
EBL/cursor bearing readout	True/relative, selectable in any mode	Head-up: relative CU, NU, TM: true
Own ship mark	Available (symbol or dot)	Not available (dot only)

R-type: For fishing boats, pleasure boats, non-Convention cargo ships

N-type: For non-Convention ships in the Netherlands and other countries where the radars must be approved based on IMO A.477(XII), although not wholly.



# Chapter 1

## OPERATION

### Control Description

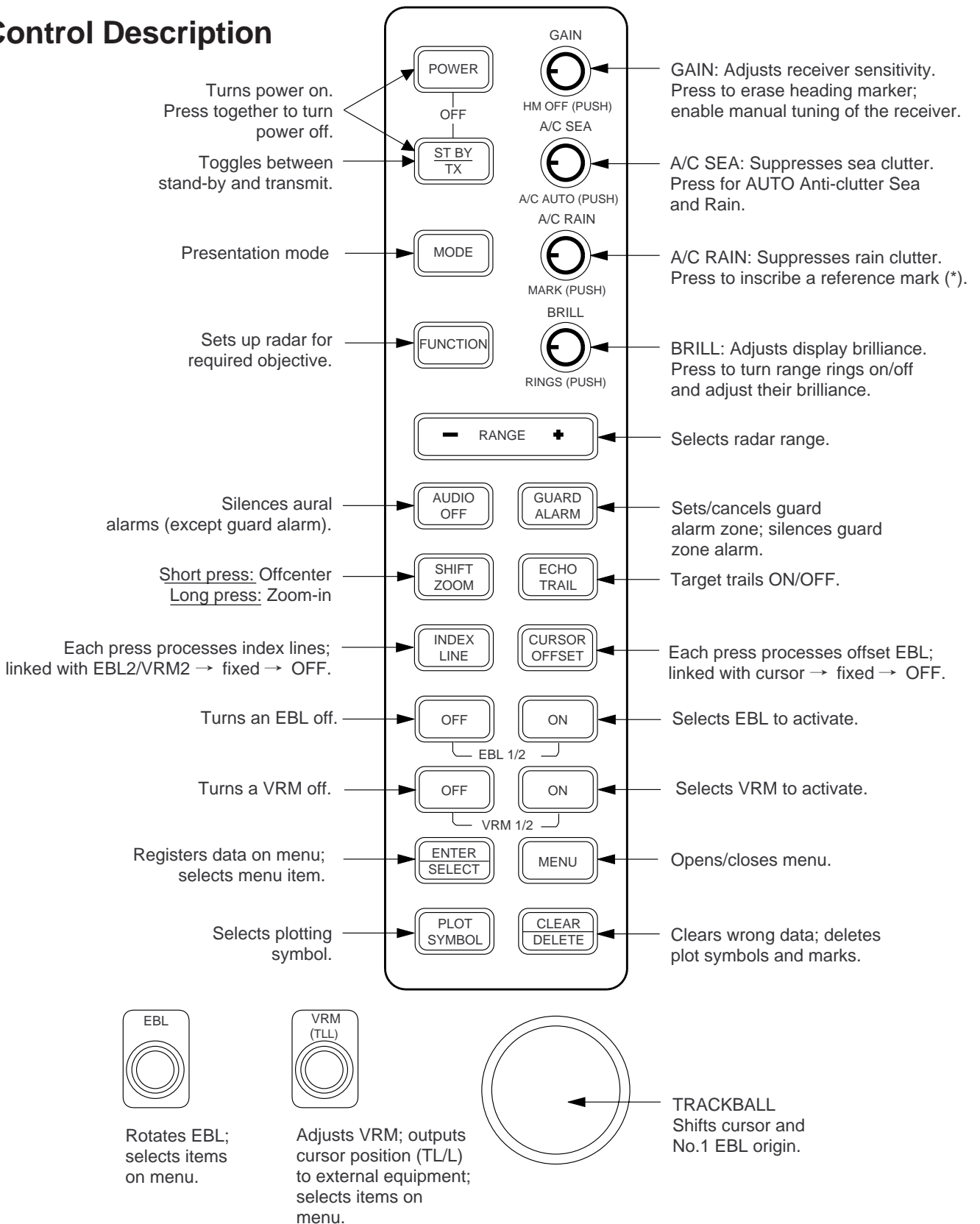


Figure 1-1 Control description

# Display Indications

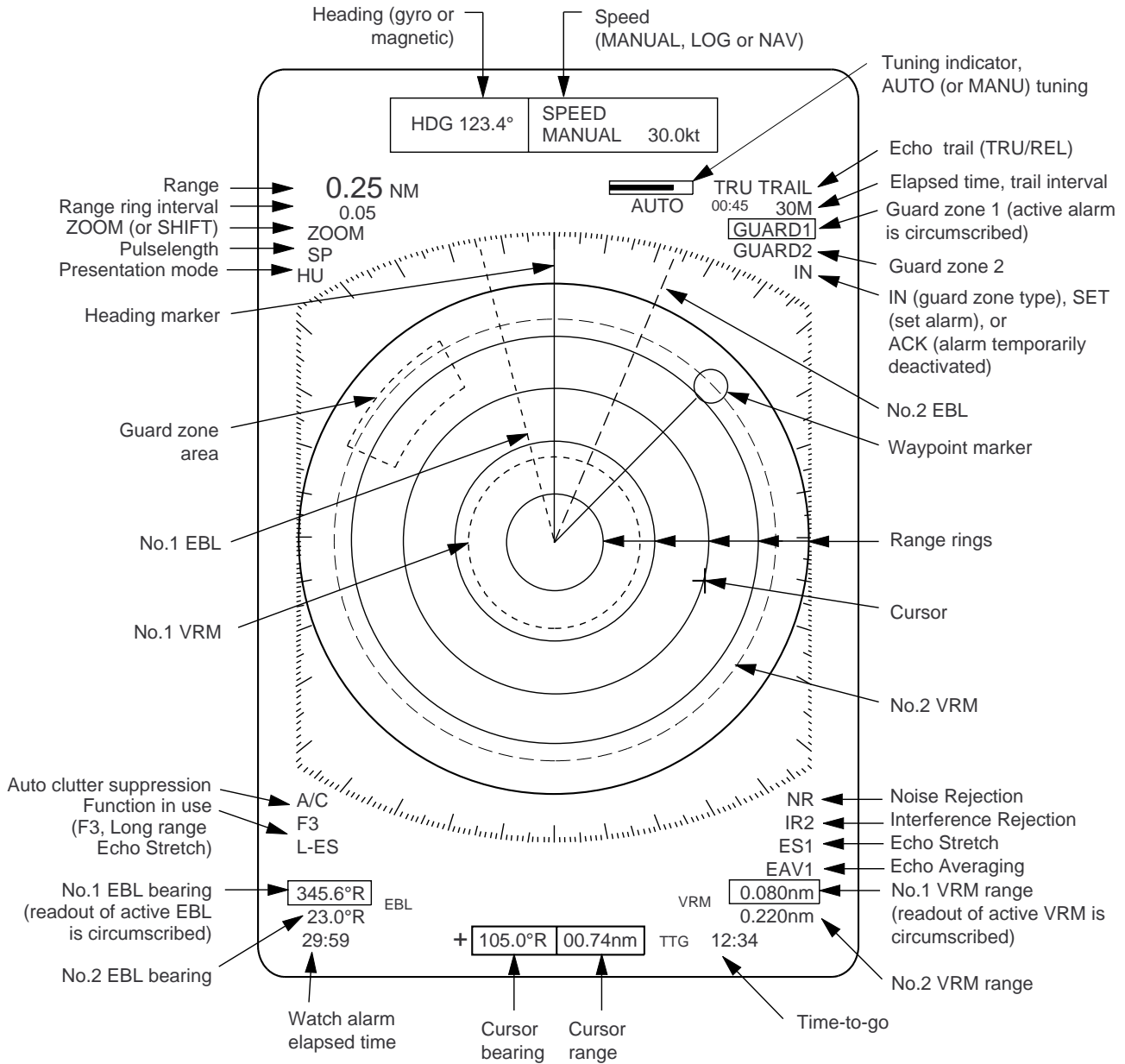


Figure 1-2 Display indications

A/C F3 L-ES	EBL	VRM	NR IR2 ES3 EAV1
18.0°T		1.829nm	
290.0°R		10.87nm	
99:99	+ 93.7°R 13.82nm	TTG 12:34	
<input type="radio"/> TRUE VECTOR	BRG 332.7°T	COURSE 198.5°T	} PLOT Data
30MIN	RNG 12.5nm	SPEED 92.8kt	
TIME 01:28	CPA 8.89nm	TCPA 05:11	

**Normal + PLOT**  
Select PLOT on  
DISP DATA menu.

A/C F3 L-ES	EBL	VRM	NR IR2 ES3 EAV1
18.0°T		1.829nm	
290.0°R		10.87nm	
OWN 34° 39.46N SHIP 135° 23.08E	+ 93.7°R 13.82nm	WAY POINT 321.6° 18.23nm	} NAV Data (Requires position, depth and water temperature data.)
COURSE 216.1°	34°39.46N	TTG 35:42	
DATE APR. 08 20:31 99:99 (GPS)	135°23.08E TTG 12:35	DEPTH 265.2m	
		TEMP 23.5°C	

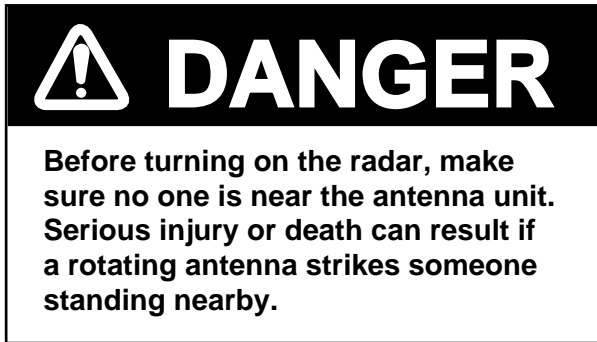
**Normal + NAV**  
Select NAV on  
DISP DATA menu.

A/C F3 L-ES	EBL	VRM	NR IR2 ES3 EAV1
18.0°T		1.829nm	
290.0°R		10.87nm	
OWN 34° 39.46N SHIP 135° 23.08E	+ 93.7°R 13.82nm	WAY POINT 321.6° 18.23nm	} NAV Data
COURSE 216.1°	34°39.46N	TTG 35:42	
DATE APR. 08 20:31 99:99 (GPS)	135°23.08E TTG 12:35	DEPTH 265.2m	
		TEMP 23.5°C	
<input type="radio"/> TRUE VECTOR	BRG 332.7°T	COURSE 198.5°T	} PLOT Data
30MIN	RNG 12.5nm	SPEED 92.8kt	
TIME 01:28	CPA 8.89nm	TCPA 05:11	

**NORMAL + NAV + PLOT**  
Select ALL on DISP  
DATA menu.

Figure 1-3 Display indications (lower part)

## 1.1 Turning the Radar On/Off



### Turning on the radar

Press the POWER key. The control panel lights and a timer displays the time remaining for warm up of the magnetron, counting down from 3:00 to 0:00.

### Turning off the radar

Press POWER and ST BY/TX keys together.

## 1.2 Transmitting, Stand-by

### Transmitting

After the power is turned on and the magnetron has warmed up, ST-BY (Stand-By) appears at the screen center, indicating the radar is ready to transmit radar pulses. In stand-by the radar is available for use at any time.

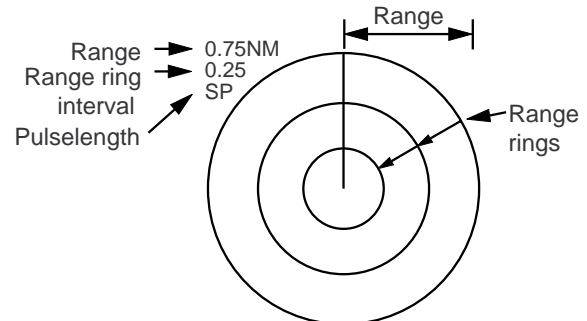
Press the ST BY/TX key to transmit. The radar displays echoes in eight intensities according to echo strength.

### Stand-by

When you won't be using the radar for an extended period, but you want to keep it in a state of readiness, place it in stand-by by pressing the ST BY/TX key. The display shows ST-BY.

## 1.3 Selecting Range

The range selected automatically determines the range ring interval, the number of range rings and pulse repetition rate, for optimal detection capability in short to long ranges.



*Figure 1-4 Location of range, range ring interval and pulselength indications*

### Procedure

Press the RANGE key at + or -. The range, range ring interval and pulselength appear at the top left corner of the display.

# 1.4 Presentation Mode

This radar has the following presentation modes:

## Relative Motion (RM)

- Head-up: Unstabilized
- Course-up: Compass-stabilized relative to ship's intended course
- North-up: Compass-stabilized with reference to north

## True Motion (TM)

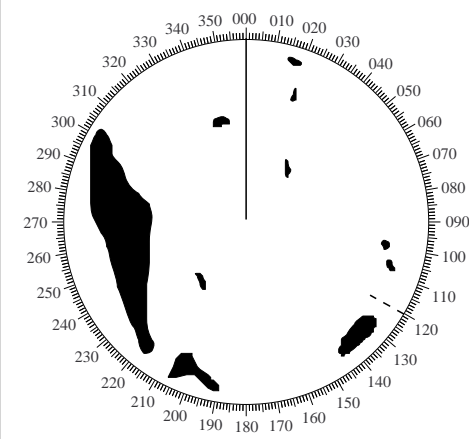
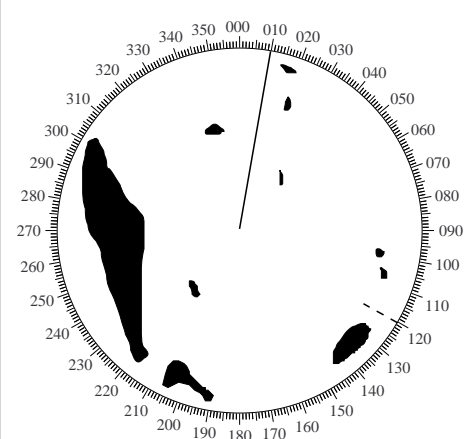
- North-up: Ground or sea stabilized with compass and speed inputs

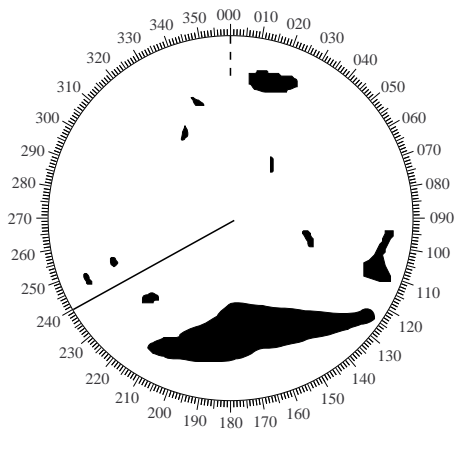
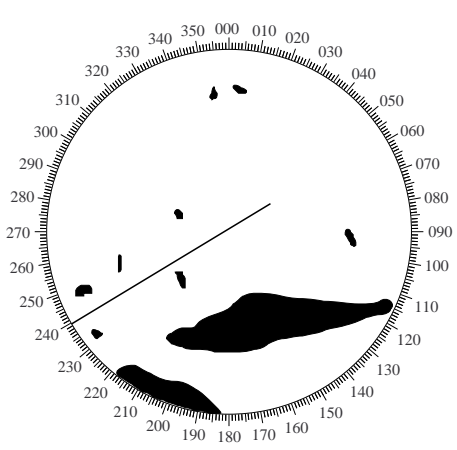
# Selecting presentation mode

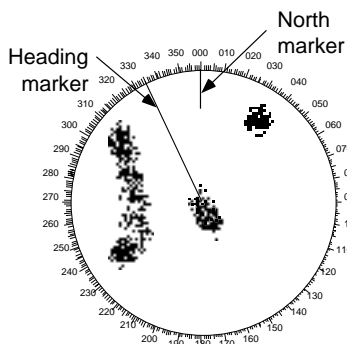
Each time the MODE key is pressed, the presentation mode and mode indication at the upper-left corner of the screen change cyclically.

## **! Loss of gyro signal**

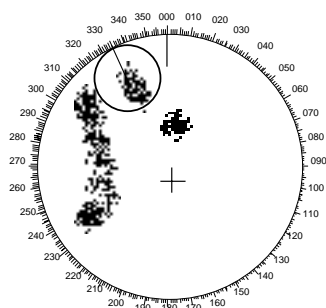
When the gyro signal is lost, the presentation mode automatically becomes Head-up and the HDG readout at the screen top shows xxx.x. The x's do not disappear even when the gyro signal is restored, to warn the operator that the readout may be unreliable. Match the gyro readout with the gyrocompass reading. Press the MODE key.

Presentation mode, representative display	Description
<div style="display: flex; align-items: center;"> <div style="writing-mode: vertical-rl; transform: rotate(180deg); font-weight: bold; margin-right: 10px;">HEAD UP</div>  </div>	<p>A display without azimuth stabilization in which the line connecting the center with the top of the display indicates own ship's heading.</p> <p>The target pips are painted at their measured distances and in their directions relative to own ship's heading.</p> <p>The short dashed line on the bearing scale is the north mark and it indicates compass north.</p> <p>Failure of the gyro will remove the north marker and the HDG indication shows "xxx.x".</p>
<div style="display: flex; align-items: center;"> <div style="writing-mode: vertical-rl; transform: rotate(180deg); font-weight: bold; margin-right: 10px;">COURSE UP</div>  </div>	<p>An azimuth stabilized display in which a line connecting the center with the top of the display indicates own ship's intended course (namely, own ship's previous heading just before this mode has been selected).</p> <p>Target pips are painted at their measured distances and in their directions relative to the intended course which is maintained at the 0-degree position while the heading marker moves in accordance with the ship's yawing and course changes. This mode is useful to avoid smearing of picture during course changes. After a course change, press the SHIFT ZOOM key to reset the picture orientation if you wish to continue using the Course-up mode.</p> <p>If the gyrocompass fails, the presentation mode changes to the Head-up mode and the north marker disappears. Also, the HDG readout at the screen top shows xxx.x.</p>

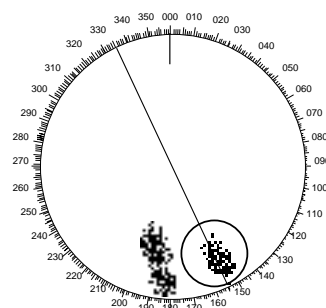
Presentation mode, representative display	Description
<p style="writing-mode: vertical-rl; transform: rotate(180deg);">NORTH UP</p> 	<p>Target pips are painted at their measured distances and in their true (compass) directions with reference to own ship, north being maintained at the top of the screen. The heading marker moves according to ship's heading.</p> <p>If the gyro fails, the presentation mode changes to the Head-up mode and the north mark disappears. Also, the HDG readout at the screen top shows xxx.x.</p>
<p style="writing-mode: vertical-rl; transform: rotate(180deg);">TRUE MOTION</p> 	<p>Own ship and other moving objects move in accordance with their true courses and speeds. All fixed targets, such as landmasses, appear as stationary echoes.</p> <p>When own ship reaches a point corresponding to 75% of the radius of the radar display, the sweep origin is automatically flipped (reset) to 50% radius opposite to the extension of the heading marker passing through the display center.</p> <p>Sweep origin may also be reset automatically, in which case the sweep origin is automatically reset to 50% radius opposite on the extension of the heading marker passing through the display center.</p> <p>If the gyrocompass fails, the presentation mode is changed to the Head-up mode and the north marker disappears. Also, the HDG readout at the screen top shows xxx.x.</p>



(a) True motion is selected



(b) Own ship has reached a point 75% of display radius



(c) Own ship is automatically reset to 50% of radius

Automatic resetting of sweep center in true motion mode

## 1.5 Menu Overview

The MAIN menu, composed of nine menus, contains functions which normally do not require frequent adjustment in everyday operation.

### Basic menu operation

- 1) Press the MENU key to display the MAIN menu.

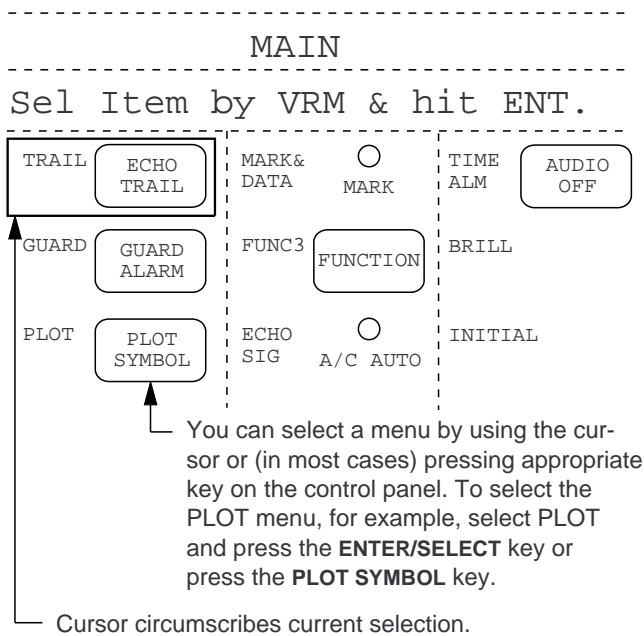


Figure 1-5 MAIN menu

- 2) Operate the VRM or EBL control to select a menu with the cursor and press the ENTER/SELECT key. (You can also select menus by pressing key or control shown on the MAIN menu. In this case you need not press the ENTER/SELECT key.)

For example, select the TRAIL menu.

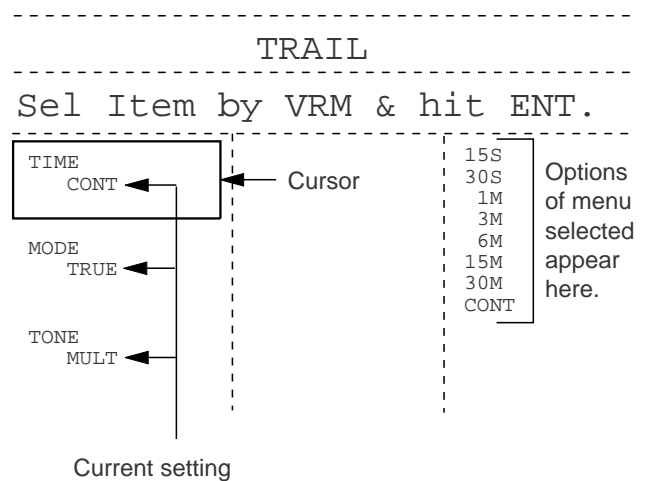


Figure 1-6 TRAIL menu

- 3) Select option (in far right-hand column) by operating the VRM or EBL control.
- 4) Press the ENTER/SELECT key to register selection.
- 5) Press the MENU key to close the menu.

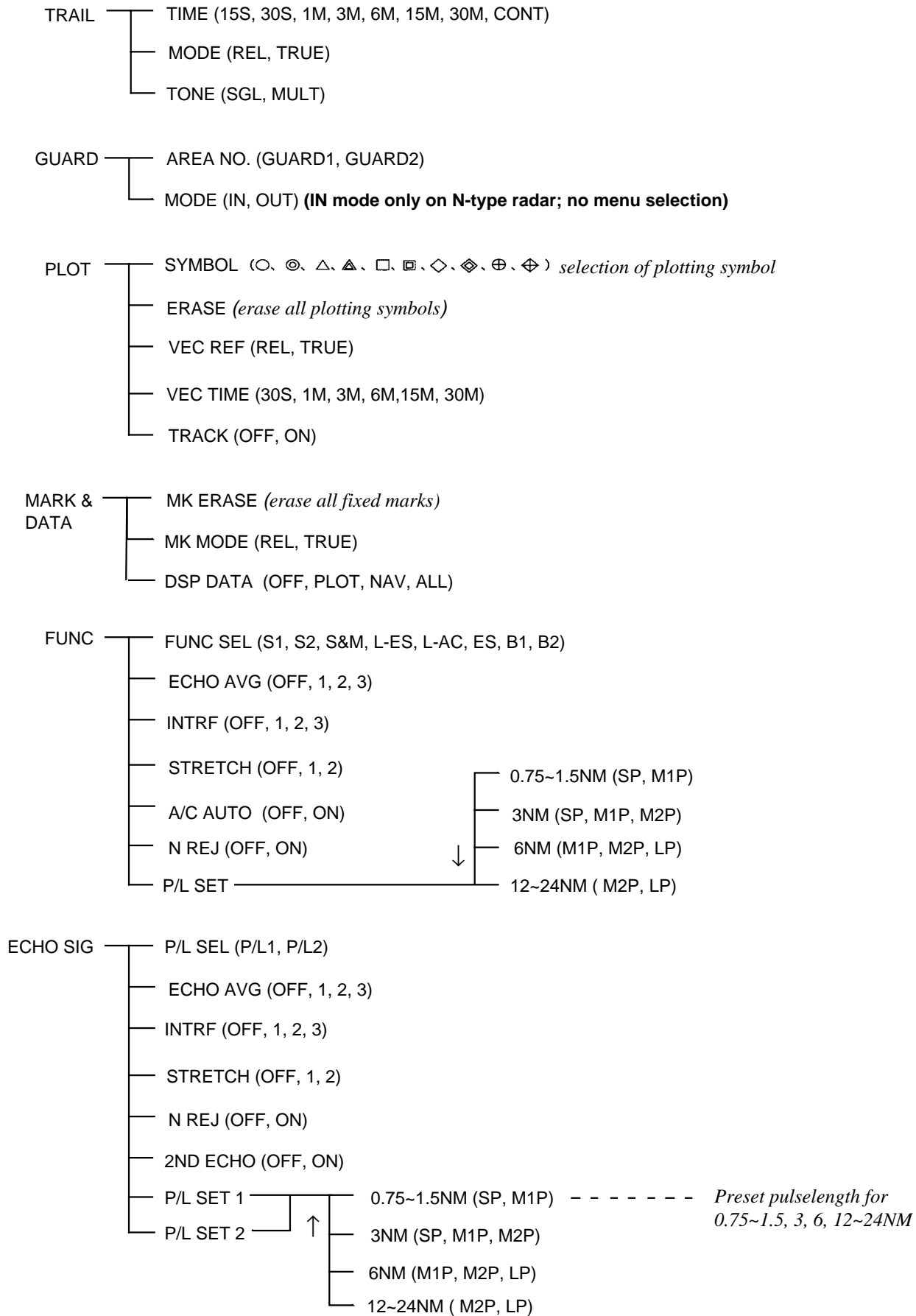
### Changing pages on the INITIAL menu

The initial menu has two pages: INITIAL1 and INITIAL2. You can switch between them as follows:

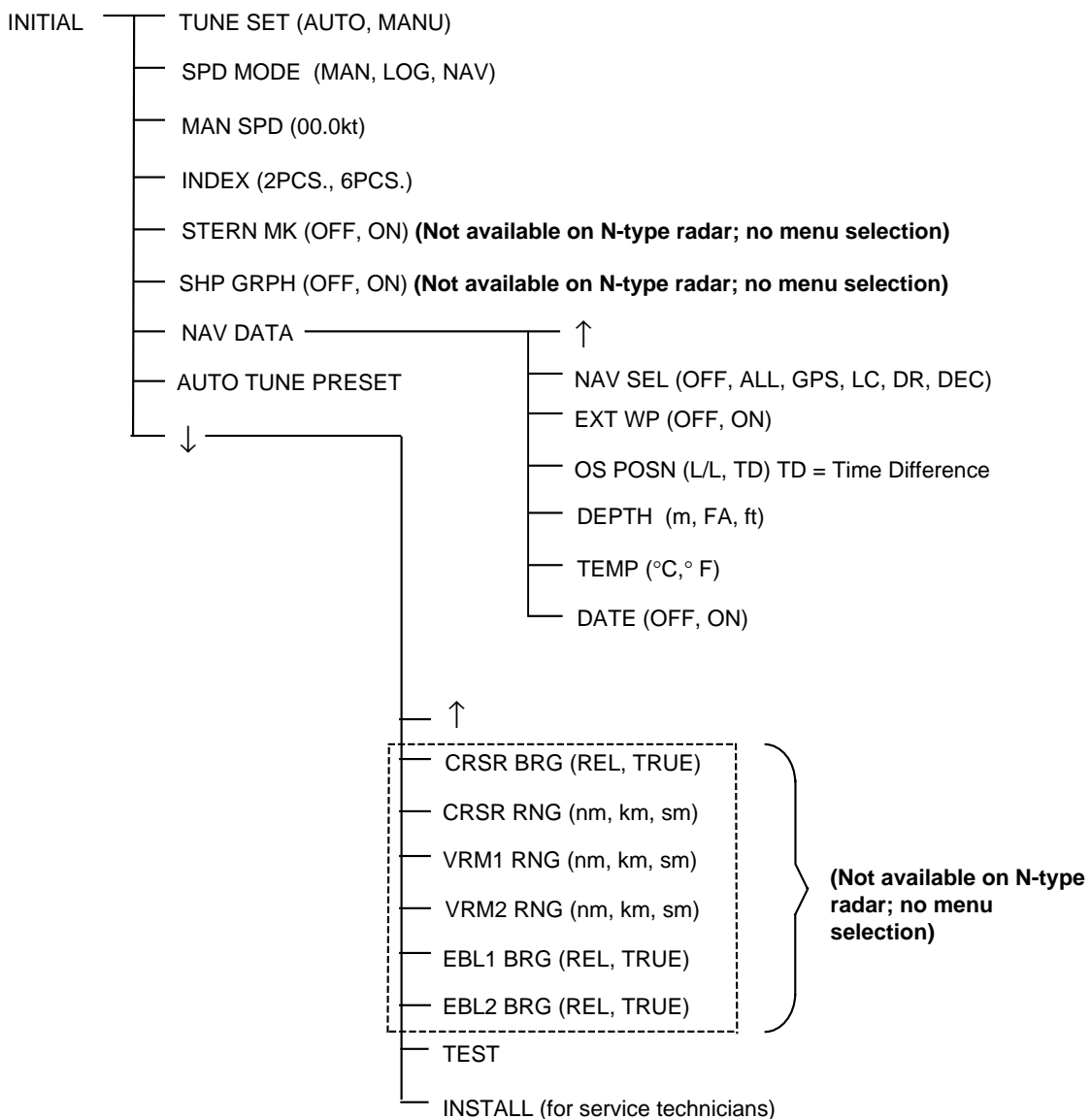
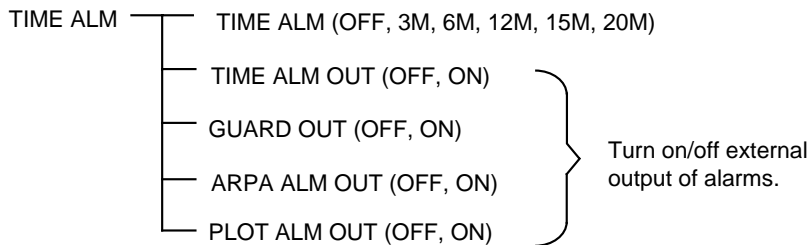
**Previous page:** Place the cursor on [↑] and press the ENTER/SELECT key.

**Next page:** Place the cursor on [↓] and press the ENTER/SELECT key.

## Menu tree







## 1.6 Tuning the Receiver

The receiver can be tuned automatically or manually. The default (factory setting) is automatic tuning.

### Selecting tuning mode

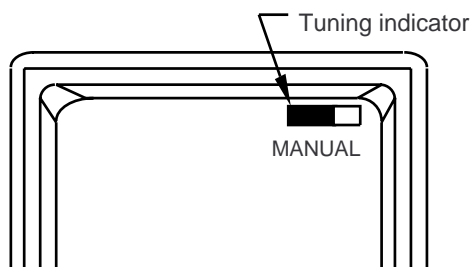
- 1) Press the MENU key.
- 2) Select the INITIAL menu.
- 3) Press the ENTER/SELECT key.

**Note:** The above three steps can also be done by pressing and holding down the MENU key.

- 4) Select TUNE SET and press the ENTER/SELECT key.
- 5) Select AUTO (or MANUAL).
- 6) Press the ENTER/SELECT key.
- 7) Press the MENU key.

### Manual tuning

- 1) Select manual tuning by following "selecting tuning mode."
- 2) While pressing and holding down the HM OFF switch, adjust the trackball to display the longest tuning indicator.



*Figure 1-7 Display appearance when manual tuning is in effect*

**Note:** The receiver may be detuned if your radar is hit by another radar in vicinity. To retune in automatic tuning, press the ST BY/TX key twice.

## ! Video lockup recovery

Video lockup or picture freeze, can occur unexpectedly on digital rasterscan radars. This is mainly caused by heavy spike noise in the power line, and can be noticed by carefully watching the nearly invisible sweep line. If you suspect that the picture is not updated every scan of the antenna or no key entry is accepted notwithstanding the apparently normal picture, turn the power off and on.

## 1.7 Adjusting Sensitivity

The GAIN control adjusts the sensitivity of the receiver and thus the intensity of echoes as they appear on the screen.

The proper setting is such that the background noise is just visible on the screen. If you set up for too little sensitivity, weak echoes may be missed. On the other hand excessive sensitivity yields too much background noise; strong targets may be missed because of the poor contrast between desired echoes and the background noise on the display.

To adjust receiver sensitivity, transmit on long range, and adjust the GAIN control so background noise is just visible on the screen.

## 1.8 Adjusting Picture Brilliance

The BRILL control adjusts the brilliance of the picture.

## 1.9 Adjusting Brilliance of Control Panel and Markers

The brilliance of the control panel and markers can be adjusted on the BRILL menu. The heading marker is visible when set to zero.

- 1) Press the MENU key.
- 2) Select the BRILL menu.
- 3) Press the ENTER/SELECT key.

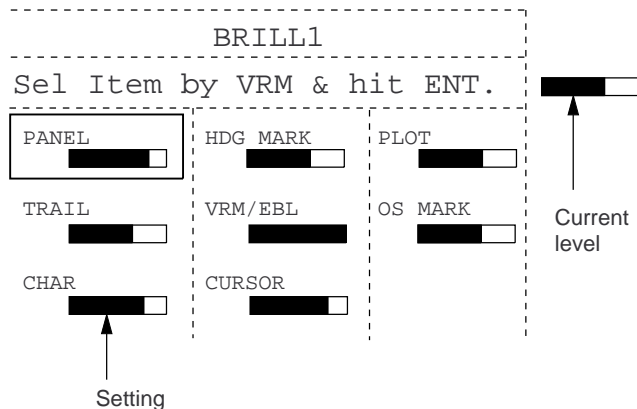


Figure 1-8 BRILL menu

- 4) Select appropriate menu among the following and press the ENTER/SELECT key.

PANEL, TRAIL, CHAR, HDG MARK, VRM/EBL, CURSOR, PLOT, OS MARK

**Note:** The OS MARK (Own Ship Mark) is not available on the N-type radar.

- 5) Operate the VRM or EBL control to set brilliance.
- 6) Press the ENTER/SELECT key.
- 7) Press the MENU key.

**Note:** The OS MARK (Own Ship Mark) is not available on the N-type radar.

## 1.10 Adjusting Range Ring Brilliance

Push in the RINGS (PUSH) control to adjust range ring brilliance/turn the range rings on or off. Each pressing of the key adjusts the brilliance of the rings (in four levels) or turns them off.

## 1.11 Suppressing Sea Clutter

In rough weather conditions returns from the sea surface are received over several miles around own ship and mask nearby targets. This situation can be improved by properly using the automatic anti-clutter function and/or the A/C SEA control.

### Automatic anti-clutter control

The easiest way to suppress the surface clutter is to use the automatic anti-clutter function. Press the A/C AUTO switch.



### Manual anti-clutter control

From the fully counterclockwise position, slowly turn the A/C SEA control clockwise. For optimum target detection, leaves speckles of the surface return slightly visible.

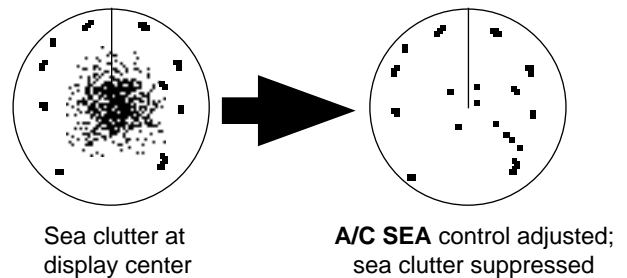


Figure 1-9

The anti-clutter sea facility is often referred to as STC (Sensitivity Time Control) which decreases the sensitivity of the receiver immediately after a radar pulse is transmitted, and progressively increases the sensitivity as the range increases.

If the control is set too low, targets will be hidden in the clutter, while if it is set too high, both sea clutter and targets will disappear from the display. In most cases adjust the control until clutter has disappeared to leeward, but a little is still visible windward.

A common mistake is to over-adjust the A/C SEA control so that the surface clutter is completely removed. By rotating the control fully clockwise, you will see how dangerous this can be; a dark zone will be created near the center of the screen, causing a loss of close-in targets. This dark zone is even more dangerous if the gain has not been properly adjusted. Always leave a little surface clutter visible on the screen. If no clutter is observed (on very calm waters), set the control at the fully counterclockwise position.

## 1.12 Suppressing Rain Clutter

In adverse weather conditions, clouds, rain or snow produce a lot of spray-like spurious echoes and impairs target detection over a long distance. This situation can be improved by using a Function key that is so programmed. If the Function key fails to effectively suppress rain clutter, use the A/C RAIN control.

The A/C RAIN control adjusts the receiver sensitivity as the A/C SEA control does but rather in a longer time period (longer range). Clockwise rotation of this control increases the anti-clutter effect.

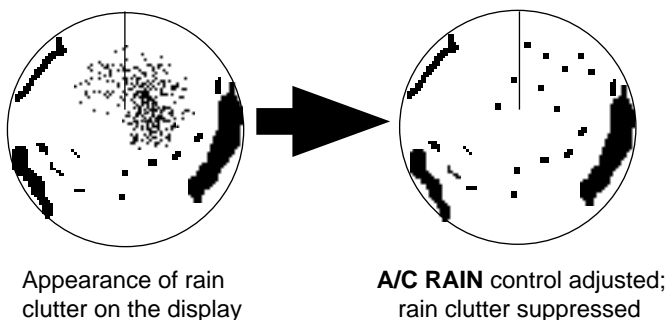


Figure 1-10 Effect of A/C RAIN control

## 1.13 The Heading and North Markers

The heading marker indicates the ship's heading in all presentation modes. It appears at zero degrees on the bearing scale in the Head-up mode, in any direction depending on the ship orientation in North-up and True Motion modes. The north marker appears as a short dashed line. In the Head-up mode, the north marker moves around the bearing scale in accordance with the compass signal.

To temporarily extinguish the heading marker to look at targets existing dead ahead of own ship, press the HM OFF (PUSH) control. The heading marker reappears when the key is released.

## 1.14 Measuring the Range

There are three ways to measure the range to a target: by the range rings, by the cursor and by the VRM (Variable Range Marker).

### Measuring range by the range rings

Use the range rings to obtain a rough estimate of the range to a target. They are concentric circles around own ship, or the sweep origin. The number of rings is automatically determined by the selected range scale and their interval is displayed at the upper-left position of the screen. Press the RINGS (PUSH) control to show the range rings if they are not displayed. Successive presses of the RINGS (PUSH) control gradually increase the brightness of the rings in four steps and a fifth press erases the rings.

### Measuring range by the cursor

Rotate the trackball to place the cursor on the inside edge of the target. The range to the cursor appears at the bottom of the display.

## Measuring range by VRM

- 1) Press the VRM ON key to enable a VRM. Each pressing of the key enables the No.1 VRM or No.2 VRM alternately. The active marker's readout is circumscribed.

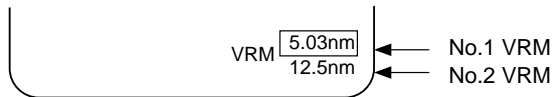


Figure 1-11 Location of VRM readouts

- 2) Operate the VRM control to place the outside edge of the VRM on the inside edge of the target.
- 3) Check the VRM readout at the bottom right corner of the display to find the range to the target.

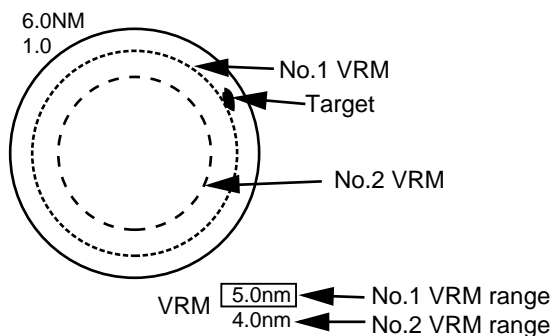


Figure 1-12 How to measure range by VRM

## Erasing VRMs

- 1) If two VRMs are displayed, press the VRM ON key to circumscribe the VRM readout of the VRM you want to keep active.
- 2) Press the VRM OFF key. The VRM readout and its associated VRM are erased.

**Note:** You can select unit of range measurement for the cursor and VRM on the INITIAL menu. For further details see 1.37 Selecting Unit of Range Measurement, Bearing Reference. This function is not available on the N-type radar; unit of range measurement is fixed for nautical miles.

## 1.15 Measuring Bearing

### Measuring bearing by cursor

Rotate the trackball to set the cursor intersection on the center of the target. The bearing to the cursor intersection appears at the bottom of the display.

### Measuring bearing by EBL

- 1) Press the EBL ON key to enable an EBL. Each pressing of the key enables the No.1 EBL or No.2 EBL alternately. The active marker's readout is circumscribed.
- 2) Operate the EBL control to bisect the target with the EBL.
- 3) Check the EBL readout at the bottom left corner of the display.

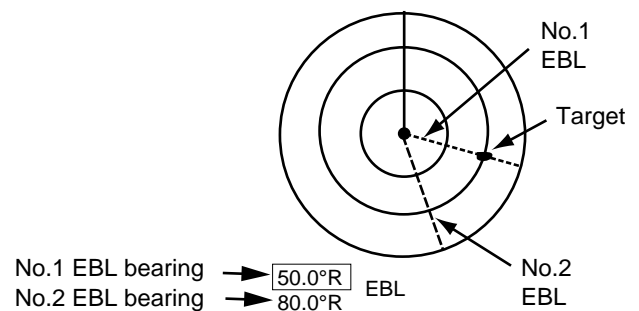


Figure 1-13 How to measure bearing by EBL

**Note 1:** You can display EBL bearing relative to own ship (relative) or with reference to the north (True). For further details see 1.38 Selecting Unit of Range Measurement, Bearing Reference. Bearing reference cannot be selected on the N-type radar; it is fixed to relative bearing in the HU mode, and true bearing in CU, NU and TM modes.

**Note 2:** Suffix "T" denotes true bearing (for gyrocompass input) and suffix "M" denotes magnetic bearing (magnetic compass input).

## Erasing EBLs

- 1) If two EBLs are displayed, press the EBL ON key to circumscribe the VRM readout of the VRM you want to keep active.
- 2) Press the EBL OFF key. The EBL readout and its associated EBL are erased.

## 1.16 Collision Assessment by the Offset EBL

The origin of the No.1 EBL can be placed anywhere with the trackball to assess the risk of collision, as well as to measure the range and bearing between two targets.

- 1) Press the EBL ON key to turn on (or activate) the No.1 EBL.
- 2) Press the CURSOR OFFSET key.
- 3) Operate the trackball to place the No.1 EBL origin on the target.
- 4) Operate the EBL control to pass the No.1 EBL through the screen center.

You can anchor the EBL, to continue monitoring target's track, by pressing the CURSOR OFFSET key again. If the target tracks along the No.1 EBL toward the screen center, the possibility of collision exists.

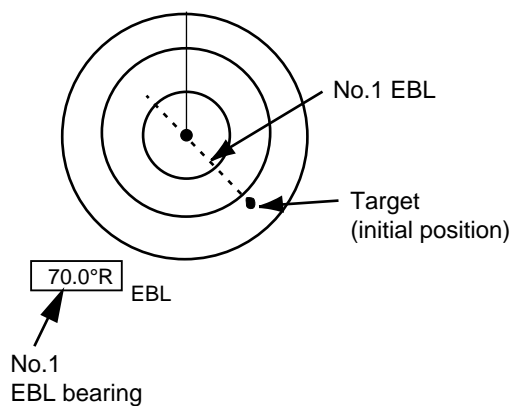


Figure 1-14 How to assess risk of collision

### Canceling the cursor offset

Press the CURSOR OFFSET key to return the No.1 EBL origin to the screen center. (Each pressing of the key links the offset EBL with the cursor, anchors the offset EBL, or returns No.1 EBL origin to the screen center.)

## 1.17 Measuring Range and Bearing Between Two Targets

The range and bearing between two targets, for example, targets A and B in Figure 1-15, can be measured by using the CURSOR OFFSET key.

- 1) Press the EBL ON key to turn on (or activate) the No.1 EBL.
- 2) Press the CURSOR OFFSET key.
- 3) Operate the trackball to place the No.1 EBL origin on target A.
- 4) Operate the EBL control to pass the No.1 EBL through target B.
- 5) Press the VRM ON key to turn on (or activate) the No.1 VRM.
- 6) Operate the VRM control to place the No.1 VRM on the inside edge of target B.

Range and bearing between the two targets appear in the cursor data window at the bottom of the display.

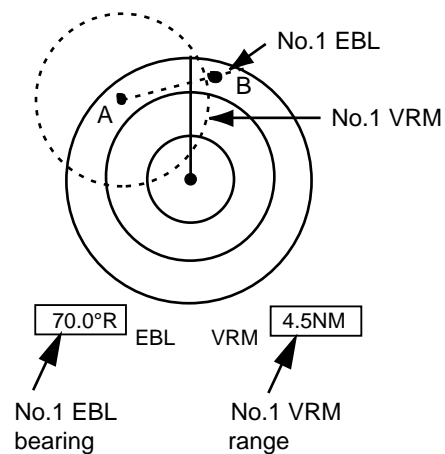


Figure 1-15 Measuring range and bearing between two targets

## 1.18 Index Lines

The index lines are useful for maintaining a constant distance between own ship and a coastline or partner ship. They can be turned on/off by the INDEX LINE key. Each pressing of the key turns on the index lines (linked with No.2 EBL and No.2 VRM), anchors the index lines, or turns off the index lines.

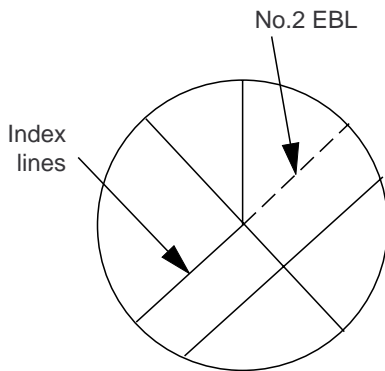


Figure 1-16 Index lines

### Rotating the index lines

Activate the No.2 EBL and operate the EBL control.

### Adjusting index lines intervals

Activate the No.2 VRM and operate the VRM control.

### Selecting number of index lines

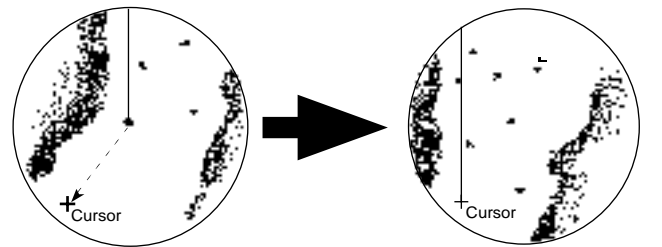
The number of index lines can be selected to two or six on the INITIAL menu.

- 1) Press the MENU key.
- 2) Select the INITIAL menu and press the ENTER/SELECT key.
- 3) Select INDEX and press the ENTER/SELECT key.
- 4) Select 2PCS (or 6PCS).
- 5) Press the ENTER/SELECT key.
- 6) Press the MENU key.

## 1.19 Off-centering the Picture

Your vessel's position can be off-centered up to 75% of the range in use to view the situation around your vessel without changing the range or size of targets.

- 1) Operate the trackball to set cursor where desired.
- 2) Press the SHIFT ZOOM key. SHIFT appears at the top left corner of the display.



① Set cursor where desired.

② Press **SHIFT ZOOM** key to shift display.

Figure 1-17 Off-centering the picture

**Note:** The display cannot be off-centered on the 96 nm range. In True Motion, the SHIFT ZOOM key resets the OS position to a point of 50% radius opposite to the extension of the heading marker passing through the display center.

### Canceling off-centered picture

Press the SHIFT ZOOM key again.

## 1.20 Zoom

The zoom feature allows you to double the size of the area between your vessel and any location within the current range to take a closer look at an area of interest. (Your radar may not have this function.)

- 1) Select location with the cursor.
- 2) Press and hold down the SHIFT ZOOM key about two seconds. ZOOM appears at the top left corner when the zoom function is on.

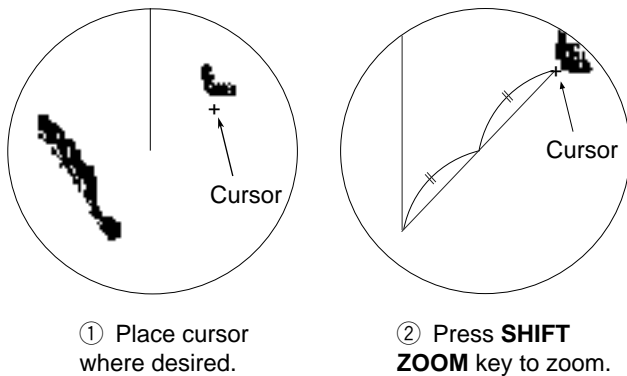


Figure 1-18 Zoom function

**Note:** Zoom is canceled when range or presentation mode is changed.

### Canceling zoom

Press the SHIFT ZOOM key again.

## 1.21 Inscribing Marks on the Display

The MARK (PUSH) control inscribes marks on the display. Each time the MARK (PUSH) control is pressed, an asterisk (\*) appears at the cursor location. You can inscribe 20 marks on the display to denote important locations such as wrecks and fishing grounds, or mark radar targets when changing the range. When the memory for marks becomes full, the eldest mark is erased to make room for the latest.

### Inscribing marks

Place the cursor on the location desired for a mark and press the MARK (PUSH) control.

## Erasing marks

### Erasing individual marks

Place the cursor on the mark to erase and press the CLEAR/DELETE key.

### Erasing all marks

- 1) Press the MENU key.
- 2) Select the MARK & DATA menu and press the ENTER/SELECT key.
- 3) Select MK ERASE.
- 4) Press the ENTER/SELECT key.
- 5) Press the MENU key.

### Mark bearing reference

You can display a mark with a relative bearing to own ship (relative) or with reference to the north (True).

- 1) Press the MENU key.
- 2) Select the MARK & DATA menu and press the ENTER/SELECT key.
- 3) Select MODE and press the ENTER/SELECT key.
- 4) Select REL (or TRUE).
- 5) Press the ENTER/SELECT key.
- 6) Press the MENU key.

## 1.22 The FUNCTION key

The FUNCTION key works similar to the automatic dialing feature on a telephone, playing back controls settings just as they were registered. Instead of manually adjusting controls to set up for navigation in a harbor, for example, you can have the FUNCTION key do it for you.

### Presetting the FUNCTION key

Eight target objectives are available and you can assign three sets on the FUNC menu. The eight objectives available are outlined in the table which follows.



Table 1-1 Eight available target objectives

Objective	Description
S1 (Short range 1)	Short range navigation (within 1.5 nm); for example, in harbor area.
S2 (Short range 2)	Short range navigation within 3 nm, e.g., harbor approach.
S & M (Short and Medium ranges)	Coastal navigation on ranges within 12 nm.
L-ES (Long range-Echo Stretch)	To enhance target on 1.5 to 6 nm range by using Echo Stretch.
L-AC (Long range-anti-clutter)	To suppress sea clutter on 3 nm range and higher ranges.
ES (Echo Stretch)	To magnify target echoes on 1.5 nm range and higher ranges.
B1 (Buoy 1)	To detect small targets (nav buoys, small vessels, floats, etc.) on ranges within 1.5 nm.
B2 (Buoy 2)	To detect small targets on ranges greater than 1.5 nm.

### Procedure

- 1) Press the FUNCTION key to display function number to program (F1, F2, or F3).
- 2) Press the MENU key and select the FUNC menu.
- 3) Press the ENTER/SELECT key.

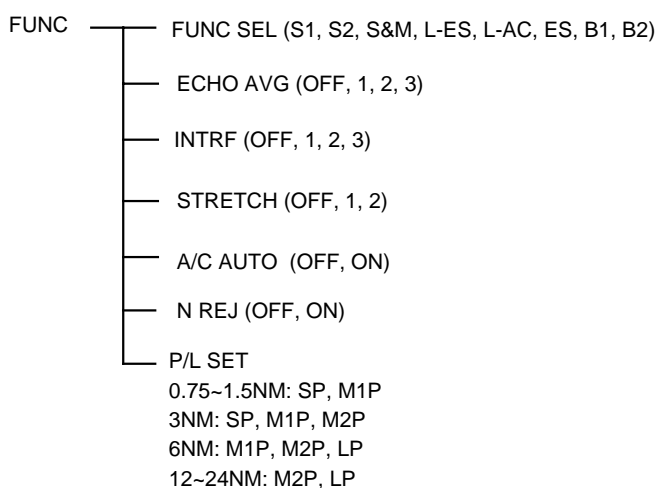


Figure 1-19 FUNC menu

- 5) Select FUNC SEL and press the ENTER/SELECT key.

6) Select target objective desired and press the ENTER/SELECT key.

7) Press the MENU key.

**Note:** Each target objective defines a combination of several radar settings for achieving optimum setup for that particular objective. Therefore, adjustment of radar settings through the FUNC menu is not necessary. If you accidentally change the settings, default settings can be restored by reselecting the target objective.

### Turning on a function

Press the FUNCTION key to display function number desired (at bottom left corner on the display.)

**Note:** When the main menu displays FUNC KEY\*, this means no function is active and the FUNCTION key is inoperative. To select a function, erase the menu and press the FUNCTION key.

## 1.23 Own Ship Speed

Ship's speed can be entered manually or automatically (by speed log or radionav equipment). Own ship's speed is required for TM and display of vectors, E-plot, etc. The True Motion display works on a ship speed entered manually or automatically.

### Automatic speed input

- 1) Press the MENU key and select the INITIAL menu.
- 2) Press the ENTER/SELECT key.
- 3) Select SPD MODE and press the ENTER/SELECT key.
- 4) Select LOG or NAV and press the ENTER/SELECT key.
- 6) Press the MENU key.

**Note:** If no speed is input for 3 minutes at below 0.1 knots, the radar regards this a log failure and displays SYSTEM FAIL LOG.

## Manual speed input

- 1) Press the MENU key.
- 2) Select the INITIAL menu and press the ENTER/SELECT key.
- 3) Select SPD MODE and press the ENTER/SELECT key.
- 4) Select MANU.
- 5) Press the ENTER/SELECT key.
- 6) Enter speed and press the ENTER/SELECT key.
- 7) Press the MENU key.

## 1.24 Ship's Graphic

A graphic (⏏) which depicts own ship can be displayed. This function is not available on the N-type radar.

- 1) Press the MENU key.
- 2) Select the INITIAL menu.
- 3) Press the ENTER/SELECT key.
- 4) Select SHP GRPH and press the ENTER/SELECT key.
- 5) Select ON (or OFF).
- 6) Press the ENTER/SELECT key.
- 7) Press the MENU key.

## 1.25 Interference Rejector

Mutual radar interference may occur in the vicinity of another shipborne radar operating in the same frequency band (9 GHz). It is seen on the screen as a number of bright spikes either in irregular patterns or in the form of usually curved spoke-like dotted lines extending from the center to the edge of the picture. This type of interference can be reduced by activating the interference rejector circuit.

The interference rejector circuit is a kind of signal correlation circuit. It compares the received signals over successive transmissions and suppresses randomly occurring signals. There are three levels of interference rejection depending

on the number of transmissions that are correlated. These are indicated by the legends IR1, IR2 and IR3 at the bottom right-hand position of the screen.

To turn on or off the interference rejector circuit;

- 1) Press the MENU key.
- 2) Select ECHO SIG and press the ENTER/SELECT key.
- 3) Select INTRF and press the ENTER/SELECT key.
- 4) Select level of suppression desired (higher the number the greater the suppression) and press the ENTER/SELECT key.
- 5) Press the MENU key.

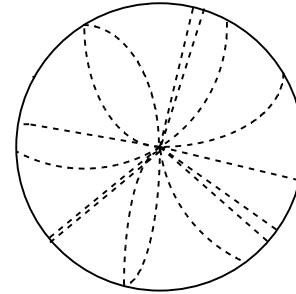


Figure 1-20 Radar interference

## 1.26 Echo Trails

Echo trails are simulated afterglow of target echoes that represent their movements relative to own ship or true movements with respect to land, in a single tone or gradual shading depending on the setting on the TRAIL menu.

### True or relative trails

You may display echo trails in true or relative motion. Relative trails show relative movements between targets and own ship. In the true motion, the moving targets have trails according to their speeds, but stationary targets stay still.

True motion trails require a gyrocompass signal and own ship speed input to cancel out own ship's movement and present true target movements in accordance with their over-the-ground speeds and courses (not heading). Refer to the automatic and manual speed input procedures for entering own ship's speed information.

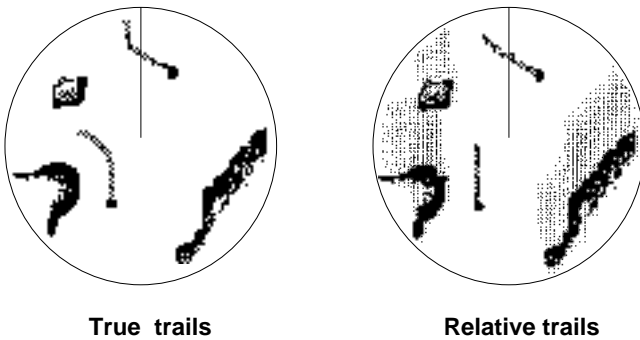


Figure 1-21 True and relative echo trails.

**Note:** If the true trail is selected on the stabilized RM (CU, NU), targets whose extensions hit own ship are not always on a collision course.

### Starting echo trail

Press the ECHO TRAIL key to start the echo trail function. "REL (or TRU) TRAIL", the echo trail time selected (on the TRAIL menu) and elapsed time appear at the top right-hand corner of the display. Then, afterglow starts extending from all targets.

### Canceling echo trail

Press the ECHO TRAIL key to erase echo trails and echo trail indications.

### Trail time

Trail time can be selected on the TRAIL menu.

- 1) Press the MENU key.
- 2) Select the TRAIL menu.
- 3) Press the ENTER/SELECT key.
- 4) Select TIME and press the ENTER/SELECT key.
- 5) Select trail time among 15 seconds, 30 seconds, 1, 3, 6, 15, 30 min, or continuous (99 minutes 59 seconds).
- 6) Press the ENTER/SELECT key.
- 7) Press the MENU key.

### Trail reference

Echo trails can be displayed relative to own ship (relative) or with reference to north (true).

- 1) Press the MENU key.
- 2) Select the TRAIL menu.
- 3) Press the ENTER/SELECT key.
- 4) Select MODE and press the ENTER/SELECT key.
- 5) Select trail reference; true or relative.
- 6) Press the ENTER/SELECT key.
- 7) Press the MENU key.

### Trail gradation

Echo trails may be shown in monotone or gradual shading (multiple). Gradual shading paints the trails getting thinner with time just like the afterglow on an analog PPI radar.



Figure 1-22 Comparison of trail gradation types

- 1) Press the MENU key.
- 2) Select the TRAIL menu.
- 3) Press the ENTER/SELECT key.
- 4) Select TONE and press the ENTER/SELECT key.
- 5) Select SGL or MULT.
- 6) Press the ENTER/SELECT key.
- 7) Press the MENU key.

## Trail brilliance

Trail brilliance may be adjusted on the BRILL menu.

- 1) Press the MENU key.
- 2) Select the BRILL menu.
- 3) Press the ENTER/SELECT key.
- 4) Select TRAIL and press the ENTER/SELECT key.
- 5) Operate the VRM or EBL control to adjust trail brilliance.
- 6) Press the ENTER/SELECT key.
- 7) Press the MENU key.

## 1.27 Electronic Plotting (E-plot)

10 operator-selected targets can be plotted electronically to assess their motion trends. Five past positions are marked for each plotted target.

A vector appears as you enter a second plot for a target and is updated each time a new plot is entered for the target. The vector shows the target motion trend based on its latest two plots.

Alphanumeric readouts for last-plotted or selected target appear at the bottom of the display.

It should be noted that the vector and alphanumeric target data are not updated in real time, but only when you enter a new plot.

E-plot requires ship's speed input (automatic or manual) and a compass signal.

When speed is input by a navigator, own ship moves in accordance with course; not heading.

### Plotting a target

Before plotting a target, select PLOT or ALL on the MARK & DATA DSP menu.

- 1) Place the cursor on the target you want to plot, and press the PLOT SYMBOL key.

- 2) Watching the E-plot timer on the PLOT mode, wait at least 30 seconds. Place the cursor on the plot symbol and press the ENTER/SELECT key. The plot symbol of the target flashes.
- 3) **While the plot symbol of the target is flashing**, place the cursor on the target again and press the PLOT SYMBOL key. The plot symbol shifts to the new target position and the previous position is marked by a small dot.

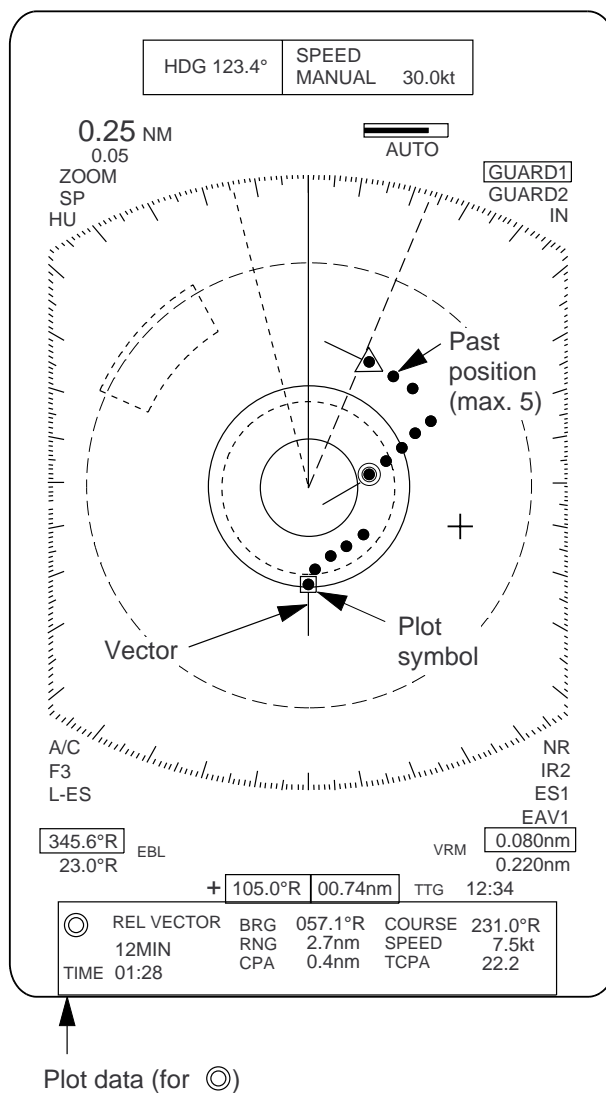


Figure 1-23 Plotting

**Note:** If a certain target once plotted is not plotted again within 12 minutes, the plot symbol of the target flashes. If you want to continue plotting this target, reacquire it within one minute, otherwise, the target will be regarded as a "lost target" and its plot symbol and target data will be erased. The larger the plotting interval, the less accurate the plotted target data. Plotting of each target should normally be made every 3 or 6 minutes as far as possible.

## Target data

Place the cursor on the plotted target and press the ENTER/SELECT key. Vector reference, vector time, vector time elapsed, and selected target's bearing, course, speed, CPA and TCPA appear at bottom of the display.

In the head-up mode target bearing course and speed become true or relative depending on vector reference setting. In north-up, course-up and true motion the target data always shows true bearing, true course and speed over the ground.

## True or relative vector

Target vectors can be displayed relative to own ship (relative) or with reference to the north (True). Current vector reference appears at the bottom of the display when the PLOT mode is active.

- 1) Press the MENU key.
- 2) Select the PLOT menu.
- 3) Press the ENTER/SELECT key.
- 4) Select VEC REF and press the ENTER/SELECT key.
- 5) Select vector reference.
- 6) Press the ENTER/SELECT key.
- 7) Press the MENU key.

## Vector time

A vector extends from plotted targets to show projected position of target at elapse of vector time. The vector is useful for evaluating risk of collision. Current vector time appears at the bottom of the display when the PLOT mode is active.

- 1) Press the MENU key.
- 2) Select the PLOT menu.
- 3) Press the ENTER/SELECT key.
- 4) Select VEC TIME and press the ENTER/SELECT key.
- 5) Select vector time.
- 6) Press the ENTER/SELECT key.
- 7) Press the MENU key.

## Turning past position display on/off

The radar plots the latest five past positions of a plotted target by dots. You can show or hide the dots.

- 1) Press the MENU key.
- 2) Select the PLOT menu.
- 3) Press the ENTER/SELECT key.
- 4) Select TRACK and press the ENTER/SELECT key.
- 5) Select ON (or OFF).
- 6) Press the ENTER/SELECT key.
- 7) Press the MENU key.

## Canceling target plotting

### Canceling individual target plotting

Place the cursor on the plot symbol and press the CLEAR/DELETE key.

### Canceling all target plotting

- 1) Press the MENU key.
- 2) Select the PLOT menu.
- 3) Press the ENTER/SELECT key.
- 4) Select ERASE and press the ENTER/SELECT key.
- 5) Press the MENU key.

## 1.28 Setting a Guard Alarm Zone

The guard allows the operator to set the desired range and bearing for a guard zone. When ships, islands, landmasses, etc. violate the guard zone an aural alarm sounds and the offending target blinks to call the operator's attention. Two areas can be set, zone 1 (short dashed line) and zone 2 (long dashed line), and one may be active.

**! WARNING**

- The alarm should not be relied upon as the sole means for detecting possible collision situations.
- A/C SEA, A/C RAIN and GAIN should be properly adjusted to be sure the alarm system does not overlook target echoes.

### Selecting guard zone type

The guard alarm can be set to sound when a target either enters (or exits) the guard zone. You can select which type of guard alarm you want to use through the GUARD menu. **N-type: IN type alarm only.**

**In alarm:** The alarm sounds on targets entering the guard zone. (IN) appears at the top right-hand corner when the In alarm is selected.

**Out alarm:** The alarm sounds on targets exiting the guard zone. (OUT) appears at the top right-hand corner when the Out alarm is selected.

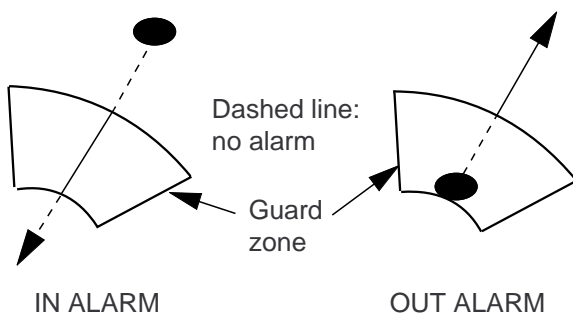


Figure 1-24 In and out alarms

- 1) Press the MENU key.
- 2) Select the GUARD menu.
- 3) Press the ENTER/SELECT key.
- 4) Select MODE and press the ENTER/SELECT key.
- 5) Select IN (or OUT).
- 6) Press the ENTER/SELECT key.
- 7) Press the MENU key.

### Activating the guard zones

Two guard zones may be set and one of them may be active. Select the guard zone to make active on the GUARD menu.

- 1) Press the MENU key.
- 2) Select the GUARD menu.
- 3) Press the ENTER/SELECT key.
- 4) Select AREA NO. and press the ENTER/SELECT key.
- 5) Select guard zone to make active; GUARD1 (or GUARD2).
- 6) Press the ENTER/SELECT key.
- 7) Press the MENU key.

### Setting a guard zone

- 1) Referring to (1) in Figure 1-30, operate the trackball to place the cursor at point A or B.
- 2) Press the GUARD ALARM key. GUARD1 (or GUARD2) SET appears at the top right corner on the display. See Figure 1-30 (2).
- 3) Operate the trackball to place the cursor at point C or D. See Figure 1-30 (3). GUARD1 (or GUARD2) IN (or OUT) appears.
- 4) Press the GUARD ALARM key.

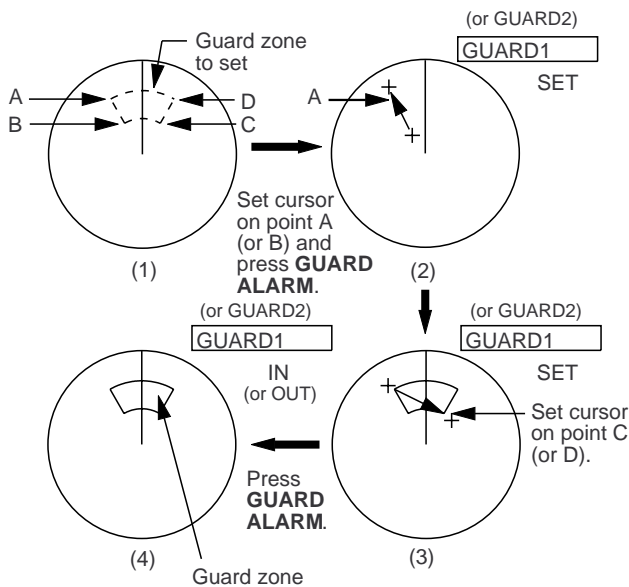


Figure 1-25 How to set the guard alarm

**Note:** When the radar range is less than one half of the guard zone range, the guard zone disappears and the indication of active guard zone (GUARD1 or GUARD2) appears in highlighted video. If this happens, raise the range to re-display the guard zone.

### Silencing the aural alarm

When a target violates the guard zone, the target flashes and the aural alarm sounds. You can silence the aural alarm by pressing the GUARD ALARM key. When this is done, ACK replaces IN (or OUT). This means the aural alarm is temporarily deactivated; but, the target still flashes. Press the key again to reactivate the alarm.

### Canceling the guard zone and guard alarm

Press and hold down the GUARD ALARM key about two seconds until the guard zone disappears.

## 1.29 Watch Alarm

The watch alarm works like an alarm clock, sounding an aural alarm and blinking a visual indication "T ALM" at the predetermined time interval. When the alarm sounds, you can silence it by pressing the AUDIO OFF key.

You can select time interval (3 min, 6 min, 12 min, 15 min, or 20 min) on the TIME ALM menu.

- 1) Press the MENU key.
- 2) Select the TIME ALM menu.
- 3) Press the ENTER/SELECT key.
- 4) Select TIME ALM and press the ENTER/SELECT key.
- 5) Select time interval (or OFF).
- 6) Press the ENTER/SELECT key.
- 7) Press the MENU key.

## 1.30 Echo Average

The echo average feature effectively suppresses sea clutter and other random noise. Echoes received from stable targets such as ships (if not moving at high speeds) appear on the screen at almost the same position every rotation of the antenna. On the other hand, unstable echoes such as sea clutter appear at random positions.

To distinguish real target echoes from sea clutter, this radar performs scan-to-scan correlation. Correlation is made by storing and averaging echo signals over successive picture frames. If an echo is solid and stable, it is shown in its normal intensity. Sea clutter is averaged over successive scans and reduced in brightness. This makes it easier to discriminate real targets from sea clutter.

To properly use the echo average feature, first properly suppress sea clutter with the A/C SEA control and then select echo average function as follows;

### How to turn on echo averaging

- 1) Press the MENU key.
- 2) Select the ECHO SIG menu.

- 3) Press the ENTER/SELECT key.
- 4) Select ECHO AVG and press the ENTER/SELECT key.
- 5) Select 1, 2, or 3.
  - 1: Distinguishes targets from sea clutter and suppresses brilliance of unstable echoes.
  - 2: Distinguishes small stationary targets such as navigation buoys.
  - 3: Displays distant targets as stable echoes.
- 6) Press the ENTER/SELECT key.
- 7) Press the MENU key.

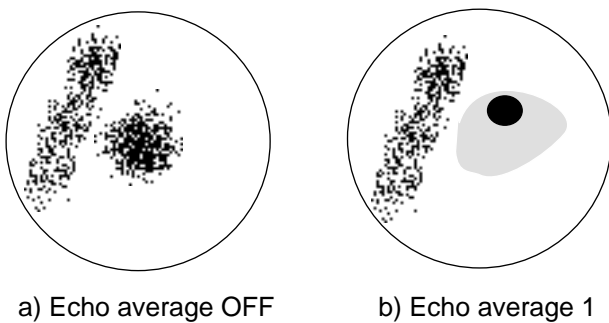


Figure 1-26 Echo average



Echo averaging uses scan-to-scan signal correlation technique based on the true motion over the ground of each target. Thus, small stationary targets such as buoys will be shown while suppressing random echoes such as sea clutter. True echo average is not however effective for picking up small targets running at high speeds over the ground.

The echo average feature is inoperable when a heading signal is not available. If you wish to use this feature without a heading signal, system initialization is required. (Consult a FURUNO representative or dealer.)

**Note:** Echo averaging also requires ship's speed information from a log or manual entry.

## 1.31 Suppressing Second-Trace Echoes

In certain situations, echoes from very distant targets may appear as false echoes (second-track echoes) on the screen. This occurs when the return echo is received one transmission cycle later, namely, after a next radar pulse has been transmitted.

To suppress them, turn on 2ND ECHO on the ECHO SIG menu.

- 1) Press the MENU key.
- 2) Select the ECHO SIG menu.
- 3) Press the ENTER/SELECT key.
- 4) Select 2ND ECHO and press the ENTER/SELECT key.
- 5) Select ON.
- 6) Press the ENTER/SELECT key.
- 7) Press the MENU key.



## 1.32 Echo Stretch

On long ranges target echoes tend to shrink in the bearing direction, making them difficult to see. On short and medium ranges such as 1.5, 3 and 6 nm range scales, the same sized targets get smaller on screen as they approach own ship. These are due to the inherent property of the radiation pattern produced by the antenna. To enhance target video, use the echo stretch feature.

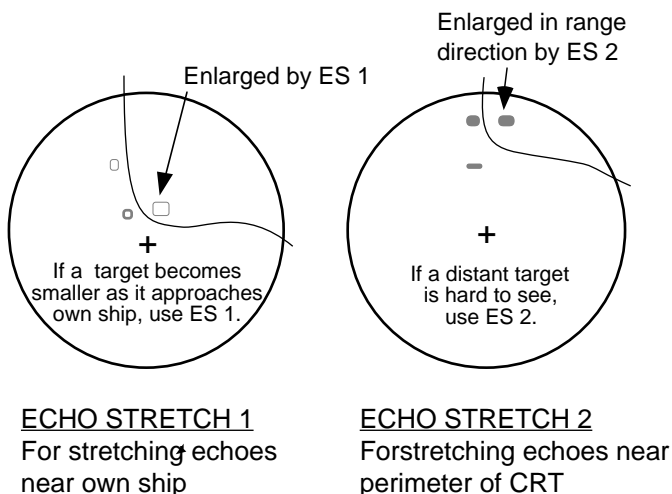


Figure 1-27 Echo stretch

- 1) Press the MENU key.
- 2) Select the ECHO SIG menu and press the ENTER/SELECT key.
- 3) Select STRETCH and press the ENTER/SELECT key.
- 4) Select 1 2, or OFF.
- 5) Press the ENTER/SELECT key followed by the MENU key.

**Note 1:** Echo stretch magnifies not only small target pips but also returns from sea surface, rain and radar interference. For this reason, make sure that these types of interference have been sufficiently suppressed before activating the echo stretch feature.

**Note 2:** If the 1.5 nm range is preset for pulselength SP (0.08  $\mu$ s) or M2 (0.3  $\mu$ s), and the 3 nm scale for M1 (0.3  $\mu$ s), the echo stretch feature is not available on these range scales.

**Note 3:** Suppress sea clutter and noise before activating echo stretch, since the echo stretch circuit stretches not only target echoes but also sea clutter and noise.

**Note 4:** Echo stretch 2 is not available with the short pulse.

## 1.33 Noise Rejection

White noise can be suppressed by turning on N REJ on the ECHO SIG menu.

- 1) Press the MENU key.
- 2) Select the ECHO SIG menu.
- 3) Press the ENTER/SELECT key.
- 4) Select N REJ and press the ENTER/SELECT key.
- 5) Select ON.
- 6) Press the ENTER/SELECT key.
- 7) Press the MENU key.

## 1.34 Selecting Pulselength

Pulselength can be selected on the ranges between 0.75 and 24 nautical miles, on the menu. Pulselengths available are a short pulse, two medium pulses, and a long pulse.

### Presetting pulselength

Two sets of pulselengths can be preset on the ECHO SIG menu: P/L SET 1 and P/L SET 2.

- 1) Press the MENU key.
- 2) Select the ECHO SIG menu.
- 3) Press the ENTER/SELECT key.
- 4) Select P/L SET 1 (or P/L SET 2) and press the ENTER/SELECT key.
- 5) Select pulselength and press the ENTER/SELECT key.
- 6) Select P/L SET 2 (or P/L SET 1) and press the ENTER/SELECT key.

- 7) Select pulselength and press the ENTER/SELECT key.
- 8) Press the ENTER/SELECT key.
- 9) Press the MENU key.

*Table 1-2 Default pulselength settings*

Range	0.75	1.5	3	6	12	24
PL Set No.1	M1P	M1P	M2P	LP	LP	LP
PL Set No.2	SP	SP	M1P	M2P	LP	LP

### Selecting pulselength set to use

Select pulselength set on P/L SEL of the ECHO SIG menu.

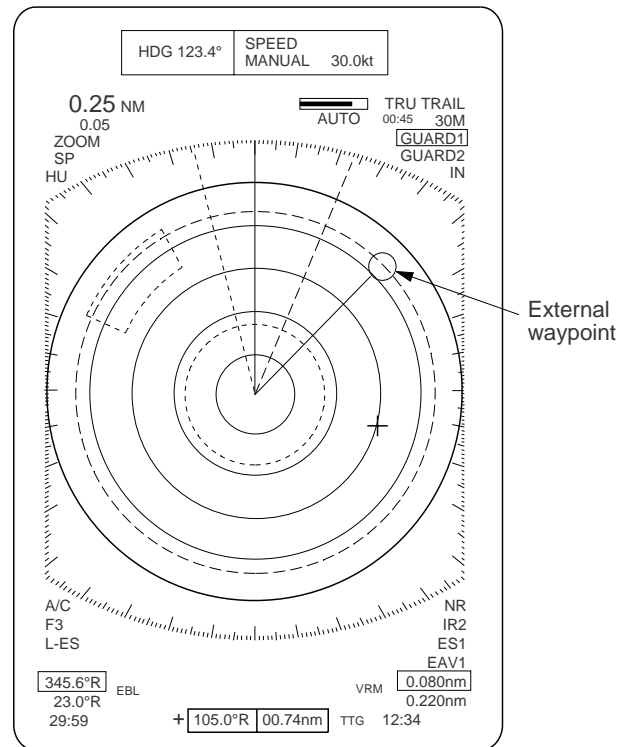
- 1) Press the MENU key.
- 2) Select the ECHO SIG menu.
- 3) Press the ENTER/SELECT key.
- 4) Select P/L SET and press the ENTER/SELECT key.
- 5) Select P/L1 (or P/L2).
- 6) Press the ENTER/SELECT key.
- 7) Press the MENU key.

## 1.35 Waypoint Display

A waypoint selected on a radionav equipment can be displayed on the radar. This function requires a compass signal.

- 1) Press the MENU key.
- 2) Select the INITIAL menu.
- 3) Press the ENTER/SELECT key.
- 4) Select NAV DATA and press the ENTER/SELECT key.
- 5) Select EXT WP and press the ENTER/SELECT key.
- 6) Select ON (or OFF).

- 7) Press the ENTER/SELECT key.
- 8) Press the MENU key.



*Figure 1-28 Displaying an external waypoint*

## 1.36 Outputting Cursor Position (TLL data)

Cursor position can be output to external equipment, in IEC 1162 format, by pressing the VRM (TLL) control. This function requires position data and a compass signal.

## 1.37 Selecting Unit of Range Measurement, Bearing Reference

You can select the unit of range measurement for the VRMs and cursor and bearing reference for the EBLs.

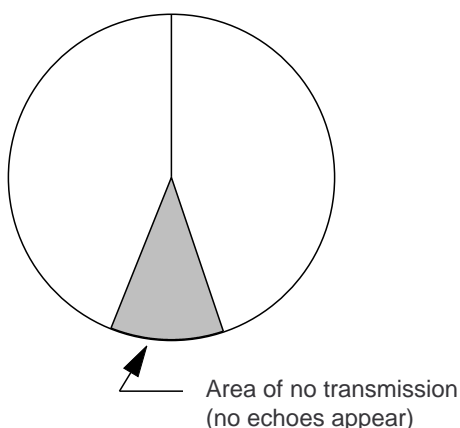
- 1) Press the MENU key.
- 2) Select the INITIAL menu.
- 3) Press the ENTER/SELECT key.
- 4) Select appropriate menu and press the ENTER/SELECT key.

CRSR BRG (REL, TRUE)  
CRSR RNG (nm, km, sm)  
VRM1 RNG (nm, km, sm)  
VRM2 RNG (nm, km, sm)  
EBL1 BRG (REL, TRUE)  
EBL2 BRG (REL, TRUE)

- 5) Select option desired and press the ENTER/SELECT key.
- 6) Press the MENU key.

## 1.38 Sector Blanking

Administrations may require the radar to stop transmitting toward the bridge when it is installed on the foremast. Two blanking areas can be set at installation. No echoes appear in the blanking areas.



*Figure 1-29 Blank areas where transmission is suspended*

## 1.39 Alarm Output Signal On/Off

With connection of an external buzzer (option), aural alarm signal can be output.

- 1) Select the TIME ALM menu.
- 2) Select alarm type and press the ENTER/SELECT key.

TIME ALM OUT: Watch alarm signal  
GUARD OUT: Guard alarm signal  
ARPA ALM OUT: CPA/TCPA alarm on ARP-15  
PLOT ALM OUT: Alarms on RP-15

- 3) Select ON or OFF.
- 4) Press the MENU key.

This page is intentionally left blank.

# Chapter 2

## RADAR OBSERVATION

### 2.1 Radar Picture, Target Properties and Radar Pulse

#### Strength of reflection

The strength of the reflected echo depends not only on the height and size of the target but also its shape, material and the angle at which the radio pulse strikes it.

#### Target size and strength of reflected echo

The size of a target has little to do with the strength of the reflected echo. If the radio pulse strikes the target at a right angle, even a small target will return a strong echo, provided its material is a good radar target.

#### Radar picture and how the pulse strikes a target

A return echo will be weak if the angle at which a radio pulse strikes a target is small. For example, flat surfaces, such as sandy beaches, sandbars and mudbanks have almost no area that can reflect energy back to the radar. Conical surfaces, such as a lighthouse, generate a weak return echo because their shape diffuses most of the radiated energy.

Radar sees only the near side of targets. For example, it cannot show you what is behind a sea wall or an island. The echo of a mountain peak may appear on the radar as a peninsula or small island.

#### Target material and reflected echo

Generally, steel objects return a very strong echo, and reefs and water return a weak echo. The weakest echoes come from wood and fiberglass objects. In summary, non-metallic objects and flat or conical objects are not good radar targets.

### Actual topography and radar picture

The radar cannot display topography in its actual shape.

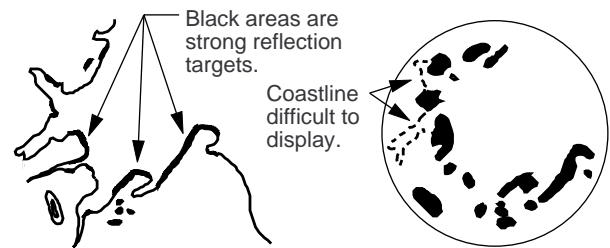


Figure 2-1 Radar picture and actual topography

### 2.2 Range Resolution

Range resolution is a measure of the capability of a radar to display as separate pips the echoes received from two targets which are on the same bearing and are close together.

The main factor which affects range resolution is pulselength. Two targets on the same bearing, close together, cannot be seen as two distinct echoes on the display unless they are separated by a distance greater than one-half the pulselength.

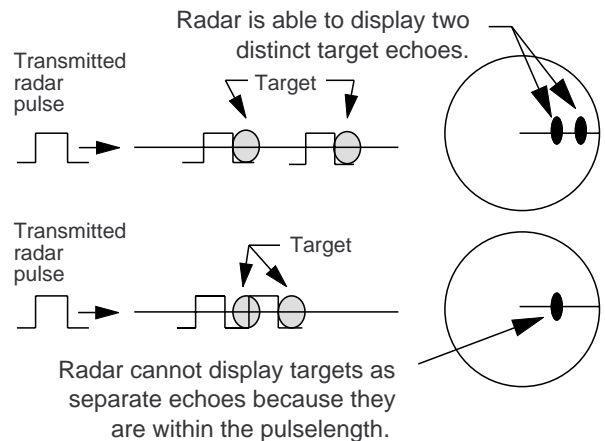


Figure 2-2 Range resolution

## 2.3 Bearing Resolution

Bearing resolution is a measure of the capability of a radar to display as separate targets the echoes received from two targets which are at the same range and are close together.

The principal factor which affects bearing resolution is horizontal beamwidth. Two targets at the same range must be separated by more than one beamwidth to appear as separate pips.

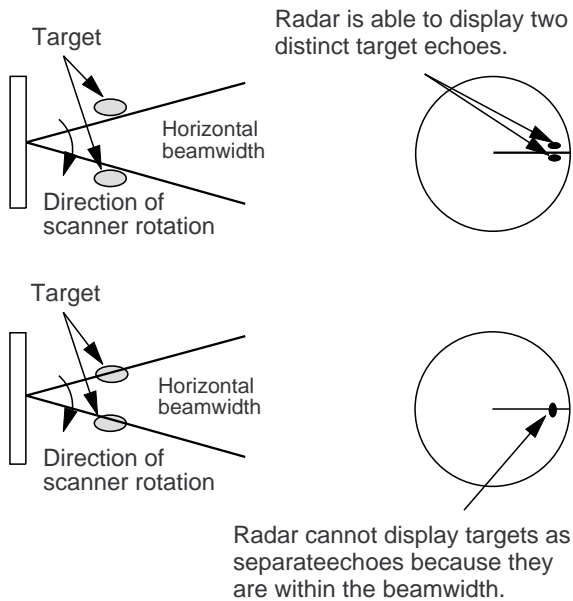


Figure 2-3 Bearing resolution

## 2.4 False Echoes

### Indirect echoes

Indirect echoes may be returned from either a passing ship or returned from a reflecting surface on your own ship, for example, a stack. In both cases, the echo will return from a legitimate contact to the antenna by the same indirect path. The echo will appear on the same bearing of the reflected surface, but at the same range as the direct echo. Figure 2-4 illustrates the effect of an indirect echo. Indirect echoes may be recognized as follows: (1) they usually occur in a shadow sector; (2) they appear on the bearing of the obstruction but at the range of the legitimate contact; (3) when plotted, their movements are usually abnormal, and (4) their shapes may indicate they are not direct echoes.

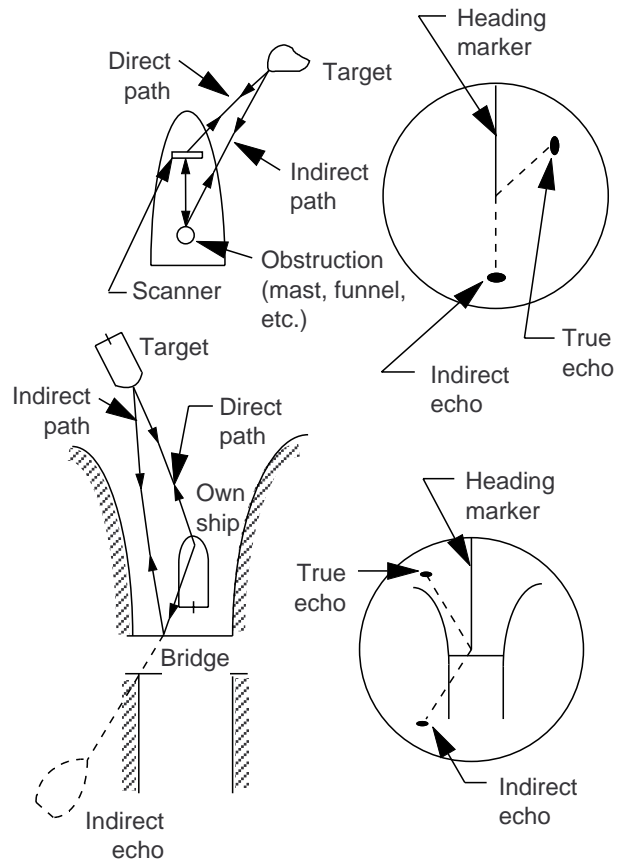


Figure 2-4 Indirect echoes

### Multiple echoes

Multiple echoes occur when a short range, strong echo is received from a ship, bridge, or breakwater. A second, a third or more echoes may be observed on the display at double, triple or other multiples of the actual range of the target as shown in Figure 2-5. Multiple echoes can be reduced and often removed by decreasing the sensitivity or properly adjusting the A/C SEA.

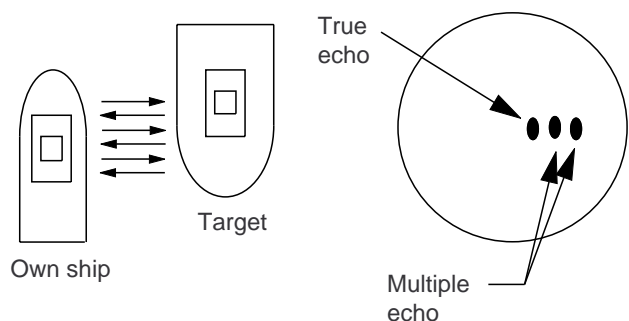


Figure 2-5 Multiple echoes

## Side-lobe echoes

Small amounts of rf radiation on each side of the main beam are called "side-lobes." If a target exists where it can be detected by the side-lobes as well as the main-lobe, the side-lobe echoes may be represented on both sides of the true echo at the same range, as shown in Figure 2-6.

Side-lobes show usually only at short ranges and from strong targets. They can be reduced through careful reduction of the sensitivity or proper adjustment of the A/C SEA.

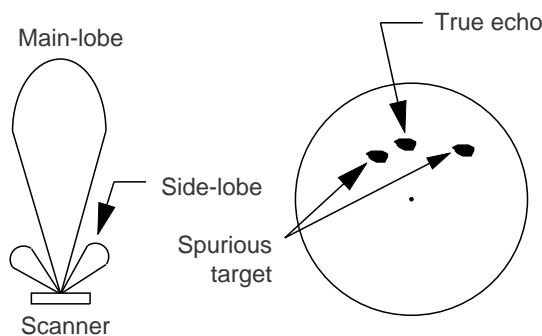


Figure 2-6 Side-lobe echoes

## Blind and shadow sectors

Funnels, stacks, masts, or derricks in the path of antenna may reduce the intensity of the radar beam. Within the blind sector small targets at close range may not be detected while larger targets at much greater ranges may be detected. See Figure 2-7.

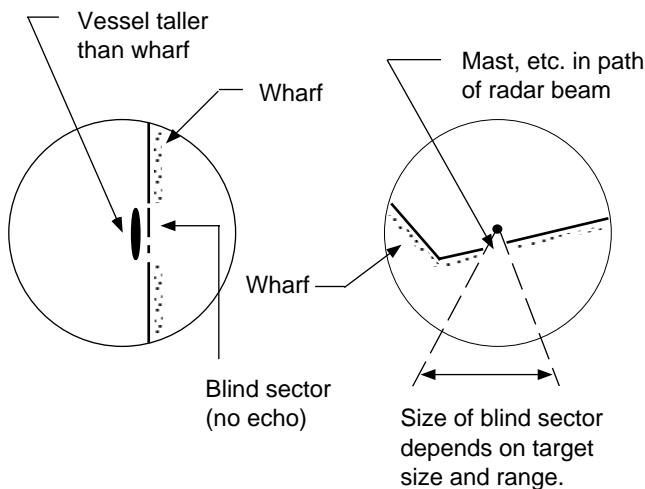


Figure 2-7 Blind and shadow sectors

## 2.5 Minimum and Maximum Ranges

### Minimum range

The minimum range is defined by the shortest distance at which, using a scale of 1.5 or 0.75 nm, a target having an echoing area of 10 m<sup>2</sup> is still shown separate from the point representing the antenna position.

It is mainly dependent on the pulselength, antenna height, and signal processing such as main bang suppression and digital quantization. It is a good practice to use a shorter range scale as far as it gives favorable definition or clarity of picture. The IMO Resolution A. 477 (XII) and IEC 936 require the minimum range to be less than 50 m. All FURUNO radars satisfy this requirement.

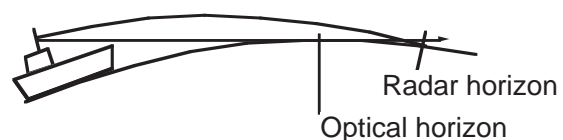
### Maximum range

The maximum detecting range of the radar,  $R_{max}$ , varies considerably depending on several factors such as the height of the antenna above the waterline, the height of the target above the sea, the size, shape and material of the target, and the atmospheric conditions.

Under normal atmospheric conditions, the maximum range is equal to the radar horizon or a little shorter. The radar horizon is longer than the optical one by about 6% because of the diffraction property of the radar signal. The  $R_{max}$  is given in the following equation.

$$R_{max} = 2.2 \times (\sqrt{h_1} + \sqrt{h_2})$$

where  $R_{max}$ : radar horizon (nautical miles)  
 $h_1$ : antenna height (m)  
 $h_2$ : target height (m)



For example, if the height of the antenna above the waterline is 9 meters and the height of the target is 16 meters, the maximum radar range is;

$$R_{max} = 2.2 \times (\sqrt{9} + \sqrt{16}) = 2.2 \times (3 + 4) = 15.4 \text{ nm}$$

## 2.6 Locating a Ship or Survival Craft in Distress by SART

### SART background

The SART is required on vessels of 300 GT and above by the 1974 SOLAS Convention as amended in 1988 (GMDSS). Performance standard is specified in IMO Resolution A.697 (17).

### SART activating conditions

The SART should operate correctly when interrogated at a distance of up to at least five miles by a navigational radar complying with resolutions A.477(XII) and A.422(VII) and IEC 936, with an antenna height of 15 meters. (It should also operate correctly when interrogated at a distance of up to 30 miles by an airborne radar with at least 10 kW peak output power at a height of 3,000 feet.)

### How SART works

Upon receiving a radar signal from a rescue party, the SART automatically transmits a series of twelve frequency sweeps at a frequency between 9200 (+0/-60 MHz) and 9500 MHz (-0/+60 MHz). The radar will represent twelve SART marks during one sweep cycle on the screen. See the Figure 2-8.

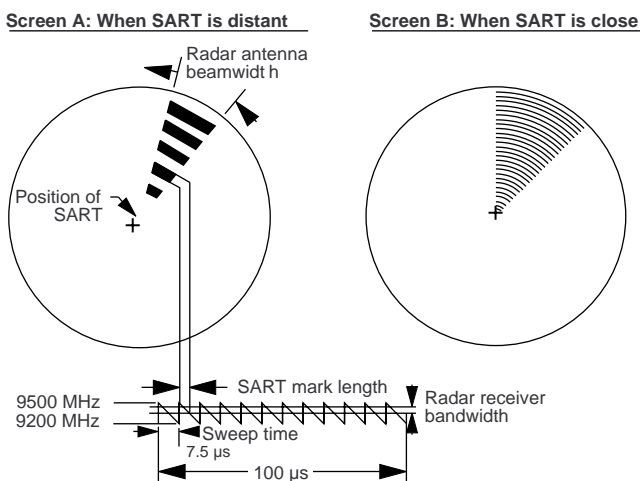


Figure 2-8 Appearance of SART marks on the radar display

The length of a SART mark depends on the radar's receiver bandwidth and sensitivity. For the bandwidth of 12 MHz, the length is 45 meters approximately and for the bandwidth of 3 MHz (usually on the 6 mile range or larger), 12 meters approximately.

### How to show SART marks on the display

Detune the radar receiver manually by turning the TUNE control out of best tuning condition. This erases or weakens all normal radar echoes; but, the SART marks are not erased because the SART response signal scans over all frequencies in the 9 GHz band. When the radar approaches the SART in operation, the SART marks will enlarge to large arcs, blurring a large part of the screen. Reduce the sensitivity and adjust the sea clutter control of the radar.

### Summary to detect SART responses

- 1) Use range scale of 6 or 12 nm as the spacing between the SART responses is about 0.6 nm (1125 m) to distinguish the SART
- 2) Turn off the automatic clutter suppression.
- 3) Turn off the Interference Rejector.
- 4) Turn off the Echo Average.

### General remarks On receiving SART

#### ① Radar range scale

When looking for a SART, it is preferable to use a range scale between **6 and 12 nautical miles**. This is because the spacing between the SART responses is about 0.6 nautical miles (1125 m) and it is necessary to see a number of responses to distinguish the SART from other responses.

#### ② SART range errors

There are inherent delays in the SART responses as the SART has a trigger delay and may also have to sweep through the whole radar band before reaching the frequency of the search radar. At medium ranges of about 6 nautical miles the range delay may be between about 150 meters and 0.6 nautical mile beyond the SART position.



As the SART is approached the radar will normally detect the initial fast sweep of the SART so that the double dots will appear. The range delay of the first dot should be no more than 150 meters beyond the SART position.

### **③ Radar bandwidth**

This is normally matched to the radar pulse length and is usually switched with the range scale and the associated pulse length. Narrow bandwidths of 3-5 MHz are used with long pulses on long range and wide bandwidths of 10-25 MHz with short pulses on short ranges.

Any radar bandwidth of less than 5 MHz will attenuate the SART signal slightly, so it is preferable to use a medium bandwidth to ensure optimum detection of the SART. The Radar Operating Manual should be consulted about the particular radar parameters and bandwidth selection.

### **④ Radar side lobes**

As the SART is approached, side lobes from the radar antenna may show the SART responses as a series of arcs or concentric ring. These can be removed by the use of the anti-clutter sea control although it may be operationally useful to observe the side lobes as these will confirm that the SART is near to the ship.

### **⑤ Detuning the radar**

To increase the visibility of the SART in clutter conditions, the radar may be detuned to reduce the clutter without reducing the SART response. Radar with automatic frequency control may not permit manual detune of the equipment. Care should be taken in operating the radar detuned as other wanted navigational and anti-collision information may be removed. The tuning should be returned to normal operation as soon as possible.

### **⑥ Gain**

For maximum range SART detection the normal maximum gain should be used.

### **⑦ Anti-clutter sea control**

For optimum range SART detection, this control should be set to the minimum. Care should be exercised as target in sea clutter may be obscured.

Some sets have automatic/manual anti-clutter sea control facilities in which cases the operator should switch to manual.

### **⑧ Anti-clutter rain control**

This should not be used when trying to detect SARTs as the SART responses may be removed by this control.

Some sets have automatic/manual anti-clutter rain control facilities in which case the operator should switch to manual.

*\*This information was created by CIRM and reviewed at NAV 39 and circulated as ANNEX 8 NAV 39/WP.2/Add.1.*

This page is intentionally left blank.

# Chapter 3

## MAINTENANCE

---



### Danger!-Electrical Shock Hazard

This equipment contains high voltages which can endanger human life at several internal circuits including a cathode ray tube (CRT) which uses several thousands volts. Any internal adjustment, servicing and repair shall only be performed by qualified service personnel totally familiar with electrical circuits and servicing of the equipment. A residual charge remains in capacitors and other devices several minutes after turning off the power. It is therefore essential to wait at least 3 minutes to allow residual charge to subside before accessing the inside of the equipment. Special care must be taken when approaching the following parts:

- Power supply circuit (Display unit)
- CRT circuit (Display unit)
- Modulator circuit and magnetron (Antenna unit )
- Motor drive circuit (Antenna unit)



### When Working on the Antenna Unit

Wear a safety belt and a hard hat when working on the antenna unit. Always make sure that the radar is **POWERED OFF** and the Antenna Switch in the display unit is **OFF** before working on the antenna unit. Also take all steps to ensure that the radar will not be accidentally operated by someone else, to prevent the potential risk of being struck by the rotating antenna and exposure to RF radiation hazards.

Periodic checks and maintenance are important for proper operation of any electronic systems. This chapter contains maintenance instructions to be followed to obtain optimum performance and the longest possible life of the equipment.

### 3.1 Periodic Maintenance Schedule

Interval	Check point	Check measures	Remarks
Weekly	Display unit	Periodically clean the exterior of display unit using dry soft clean. Use of commercially available CRT cleaner (spray) having antistatic effect is recommended.	CRT screen produces static charge which would attract dust. DO NOT use strong solvent like paint thinner or abrasive cleaners for cleaning. Dust and dirt on CRT creates symptoms similar to poor sensitivity.
3 to 6 months	Exposed nuts and bolts on antenna unit	Check for corroded or loosened nuts and bolts, If necessary, clean and repaint them thickly. Replace them if heavily corroded.	Sealing compound may be used- Instead of paint. Apply a small amount of grease between nuts and bolts for easy removal in future.
	Antenna radiator	Check for dirt and cracks on radiator surface. Thick dirt should be wiped off with soft cloth dampened with fresh water. If a crack is found, apply a slight amount of sealing compound or adhesive as a temporary remedy, then call for repair.	Do not use plastic solvent (acetone) for cleaning. If you need to remove ice from antenna unit, use a wooden hammer or plastic. Crack on the unit may cause water ingress, causing serious damages to internal circuits.
	Terminal strips and plugs in antenna unit	Open antenna cover to check terminal strip and plug connections inside. Also check the rubber gasket of antenna covers for deterioration.	When closing antenna covers in position, be careful not to catch loose wires between covers and unit.
6 months to one year	CRT and surrounding components	High voltage at CRT and surrounding components attract dust in environment which will cause poor insulation. Ask your nearest FURUNO representative or dealer to clean internal high-voltage components.	If CRT anode rubber cap or wire sheath is cracked, ask your dealer to replace it. Wait for at least 3 minutes until high voltage components (CRT and HV capacitors) discharge their residual charges before accessing them.
	Terminal strips, sockets, earth terminal	Check for loose connections. Check contacts and plugs for proper seating, etc.	

### 3.2 Life Expectancy of Major Parts

Parts	Type	Life expectancy	Remarks
Antenna motor	D8G-516 (24 rpm) D8G-570 (36 rpm)	Gear more than 10,000 hours	Wind load 100 knots
Magnetron	MAF1422B (6kW) MAF1425B (10kW) 9M752/M5187F (25kW)	2,000-3,000 hours	

# Chapter 4

## TROUBLESHOOTING



### Danger!-Electrical Shock Hazard

This equipment contains high voltages which can endanger human life at several internal circuits including a cathode ray tube (CRT) which uses several thousands volts. Any internal adjustment, servicing and repair shall only be performed by qualified service personnel totally familiar with electrical circuits and servicing of the equipment. A residual charge remains in capacitors and other devices several minutes after turning off the power. It is therefore essential to wait at least 3 minutes to allow residual charge to subside before accessing the inside of the equipment. Special care must be taken when approaching the following parts:

- Power supply circuit (Display unit and separate power supply units)
- CRT circuit (Display unit)
- Modulator circuit and magnetron (Antenna unit or separate transceiver unit)
- Motor drive circuit (Antenna unit)



### When Working on the Antenna Unit

Wear a safety belt and a hard hat when working on the antenna unit. Always make sure that the radar is POWERED OFF and the Antenna Switch in the display unit is OFF before working on the antenna unit. Also take all steps to ensure that the radar will not be accidentally operated by someone else, to prevent the potential risk of being struck by the rotating antenna and exposure to RF radiation hazards.

## 4.1 Simple Troubleshooting

This paragraph describes how to cure operational problems, by observing the radar picture and using operator controls and touchpad keys without opening the display unit, antenna unit or other equipment units.

The table below shows user-level troubleshooting procedures.

Problem	Remedy
No own ship mark	On the R-type radar, check that SHP GRPH ON is selected at the INITAL menu, referring to paragraph 1.24. The own ship mark is not available on the N-type radar.

## 4.2 Advanced-level Troubleshooting

This paragraph describes how to cure hardware and software troubles which should be carried out by qualified service personnel.

**Note:** This radar equipment contains complex modules in which fault diagnosis and repair down to component level are not practicable by users.

### Serviceman qualification

All adjustments of radio transmitter during or coinciding with the installation, servicing, or maintenance which may affect the proper operation must be performed by or under the immediate supervision and responsibility of a person holding an operator certificate containing a ship radar endorsement.

This is what the U.S. Codes of Federal Regulations part 80.169 implies (not exact extract).

As such, every administration sets forth its own rule; service personnel must be aware of this kind of competency requirements.

Problem	Check point and probable cause	Remedy
Power turned on but radar does not operate at all. Control panel is not illuminated either.	<ol style="list-style-type: none"> <li>1. Blown fuse F1351</li> <li>2. Mains voltage/polarity</li> <li>3. Power Supply Board</li> <li>4. Illumination LEDs</li> </ol>	<ol style="list-style-type: none"> <li>1. Replace blown fuse.</li> <li>2. Correct wirings and input voltage.</li> <li>3. Replace Power Supply Board.</li> <li>4. Replace defective LEDs.</li> </ol>
CRT brilliance adjusted but no picture	<ol style="list-style-type: none"> <li>1. INSTALL 3 menu setting</li> <li>2. CRT voltage</li> <li>3. SPU Board</li> </ol>	<ol style="list-style-type: none"> <li>1. Select "MAIN" for main radar. (For further details consult a FURUNO agent or dealer.)</li> <li>2. Check high voltage supply with utmost care.</li> <li>3. Replace SPU Board.</li> </ol>
Antenna not rotating	<ol style="list-style-type: none"> <li>1. Power supply line of antenna motor</li> </ol>	<ol style="list-style-type: none"> <li>1. Check connection and continuity of signal cable.</li> </ol>
Alphanumeric data and marks are not displayed in Transmit status.	<ol style="list-style-type: none"> <li>1. SPU Board</li> </ol>	<ol style="list-style-type: none"> <li>1. Replace SPU Board.</li> </ol>

<b>Problem</b>	<b>Check point and probable cause</b>	<b>Remedy</b>
Adjust GAIN control with A/C SEA control set at minimum. Marks and legends appear but no noise or echo.	<ol style="list-style-type: none"> <li>1. IF amplifier</li> <li>2. Signal cable between antenna and display</li> <li>3. Video Amplifier Circuit</li> </ol>	<ol style="list-style-type: none"> <li>1. Replace IF amplifier.</li> <li>2. Check continuity and isolation of coaxial cable. (Note: Disconnect the plug and lugs at both ends of coaxial cable before checking it by ohmmeter.)</li> <li>3. Check video coax line for secure connection. If connection is good, replace SPU Board.</li> </ol>
Marks, legends and noise appear but no echo. (Transmission leak, representing own ship position, is absent.)	<ol style="list-style-type: none"> <li>1. Magnetron</li> <li>2. Modulator Board</li> <li>3. Modulator SCR</li> <li>4. SPU Board</li> </ol>	<ol style="list-style-type: none"> <li>1. Check magnetron current. Replace magnetron.</li> <li>2. Replace Modulator Board.</li> <li>3. Replace SCR.</li> </ol> <p><b>DANGER! - High Voltage</b></p> <ol style="list-style-type: none"> <li>4. Replace SPU Board.</li> </ol>
Picture not updated	<ol style="list-style-type: none"> <li>1. Bearing Signal Generator Board (antenna unit)</li> <li>2. SPU Board</li> <li>3. Video lockup</li> </ol>	<ol style="list-style-type: none"> <li>1. Check the connection of signal cable.</li> <li>2. Replace SPU Board.</li> <li>3. Turn off and on radar.</li> </ol>
Incorrect orientation of picture	<ol style="list-style-type: none"> <li>1. SPU Board</li> <li>2. Gyro Interface</li> </ol>	<ol style="list-style-type: none"> <li>1. The HDG readout shows xxx.x when heading signal is not received.</li> <li>2. Replace gyro interface.</li> </ol>
TUNE control adjusted but poor sensitivity	<ol style="list-style-type: none"> <li>1. Deteriorated magnetron</li> <li>2. Detuned MIC</li> <li>3. Dirt on radiator face</li> <li>4. Water ingress to the waveguide or other feeder line.</li> <li>5. Second trace rejection is ON.</li> </ol>	<ol style="list-style-type: none"> <li>1. With radar transmitting on 48 mm range, check magnetron current. If current is below normal value, magnetron may be defective. Replace magnetron.</li> <li>2. Check MIC detecting current. If it is below normal value, MIC may have become detuned. MIC must be tuned.</li> <li>3. Clean radiator surface.</li> <li>4. Remove water from the feeder line.</li> <li>5. Disable the second-trace rejector referring to paragraph 1.31.</li> </ol>
Range changed but no radar picture change	<ol style="list-style-type: none"> <li>1. Defective RANGE key</li> <li>2. SPU Board</li> <li>3. Video lockup</li> </ol>	<ol style="list-style-type: none"> <li>1. Try to hit [+] and [-] RANGE keys several times. If unsuccessful, replacement of keypad may be required.</li> <li>2. Replace SPU Board.</li> <li>3. Turn off and on radar.</li> </ol>

<b>Problem</b>	<b>Check point and probable cause</b>	<b>Remedy</b>
Interference rejector inoperable (interference rejection level not displayed)	1. SPU Board	1. Replace SPU Board.
Echo Stretch ineffective (Neither "ES1" nor "ES2" is displayed.)	1. SPU Board	1. Replace SPU Board.
Only 2 parallel index lines (6 lines wanted)	1. Incorrect setting of index line interval	1. Set index line interval referring to paragraph 1.18.
Range rings are not displayed.	1. Press RINGS (PUSH) control to see if intensity is increased. 2. Bad contact of control 3. SPU Board	1. Replace associated circuit board if unsuccessful. 2. Replace control. 3. Replace SPU Board.
Key beep inaudible	1. SPU Board	1. Replace SPU Board.
Poor discrimination at range	1. Sea clutter control not functioning properly.	1. Improper setting of A/C SEA effect is seen only at very close range. Suspect inaccurate frequency of crystal oscillator.
True Motion presentation not working correctly	1. Poor contact of MODE key. 2. Selection is not accessed. 3. Speed entry is incorrect. 4. TM display inaccurate	1. Try to press MODE key a little harder. 2. Press MODE key until "TM" appears. 3. Enter correct own ship speed referring to paragraph 1.23. 4. Make sure that speed and compass inputs are accurate.
Target not tracked correctly	1. Poor definition of targets in sea clutter	1. Adjust A/C SEA and A/C RAIN controls referring to paragraphs 1.11 and 1.12.



### 4.3 Diagnostic Test

A diagnostic test is provided to enable testing of major circuit boards in the radar display unit.

Proceed as follows to execute the diagnostic test:

- 1) Press the MENU key.
- 2) Select the INITIAL menu and press the ENTER/SELECT key.
- 3) Select TEST and press the ENTER/SELECT key.

```

ROM 1 035909910x OK
ROM 2 035910010x OK
RAM 1      OK
RAM 2      OK
ON TIME    000001.2
TX TIME    000000.3
ANT ROT    20.5RPM
TX TRIGGER 2065Hz
VIDEO LEVEL 3.0V
    
```

x = Version level

ARP-15 data appears  
if ARP-15 is provided.

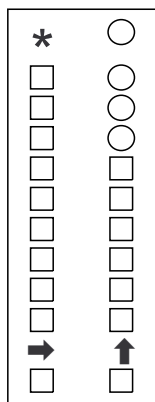


Figure 4-1 Diagnostic test screen

The diagnostic test is executed and the screen shows test results. Sample test results are shown in Figure 4-1.

Small squares displayed to the right of the test results screen are for testing the controls and keys on the control panel. As you operate the controls and keys, corresponding squares are highlighted, indicating your control/key operations are properly recognized.

- 4) To display a test pattern, press the ENTER/SELECT key. You can return to the main diagnostic test screen by pressing the ENTER/SELECT key again.

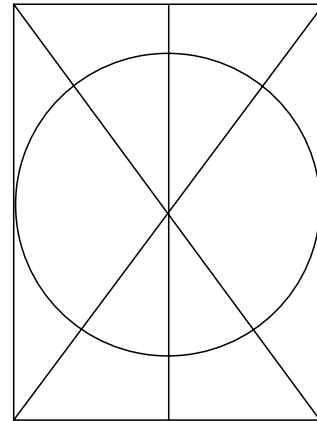


Figure 4-2 Diagnostic test, test pattern

- 5) To return to the normal radar display, press the MENU key.

This page is intentionally left blank.

# Chapter 5

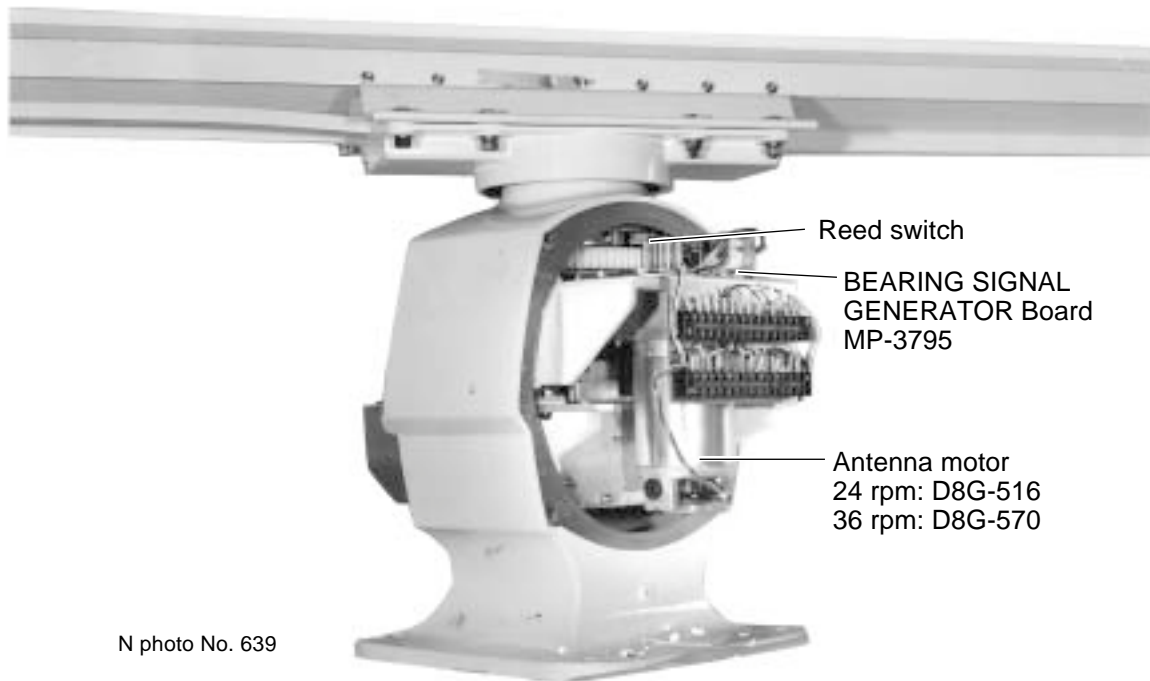
## LOCATION OF PARTS

### 5.1 Antenna Unit

**⚠ DANGER**

**⚡** This equipment uses high voltage electricity which can shock, burn or cause death.

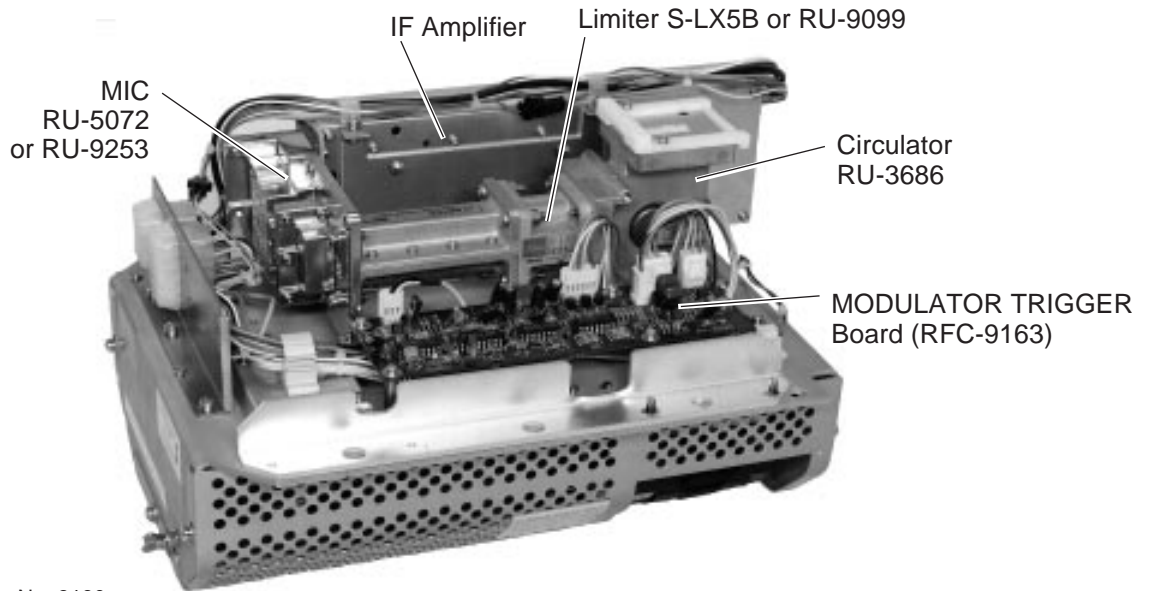
Only qualified personnel should work inside the enclosures.



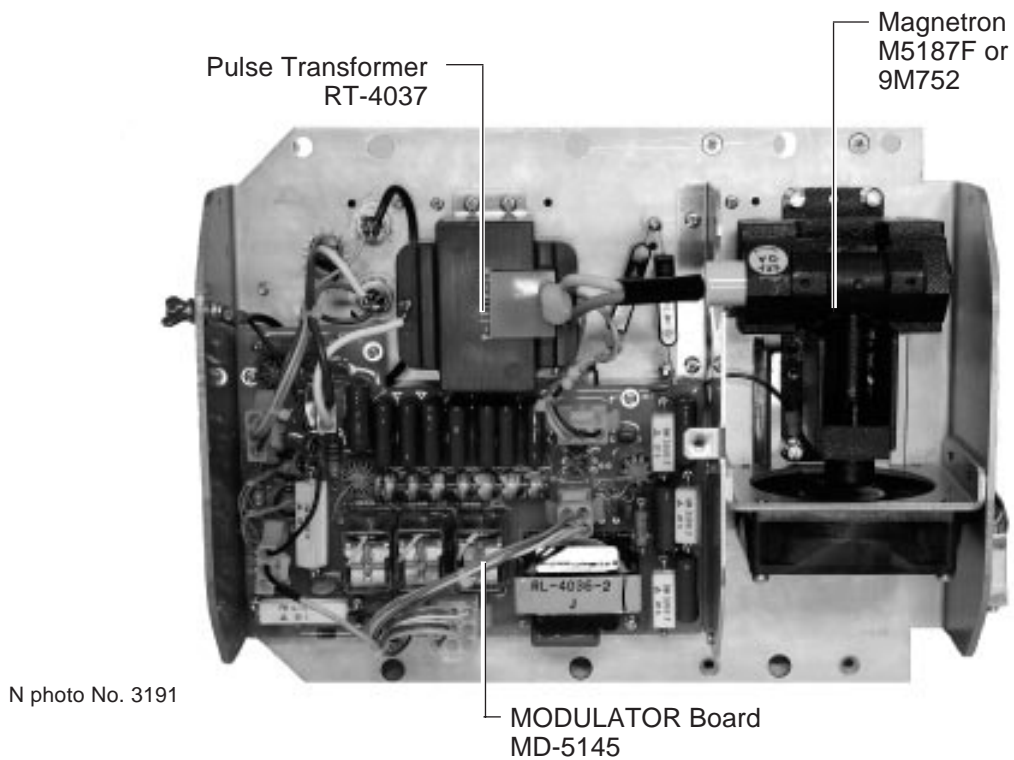
N photo No. 639

*Figure 5-1 Antenna unit (all models), cover opened*

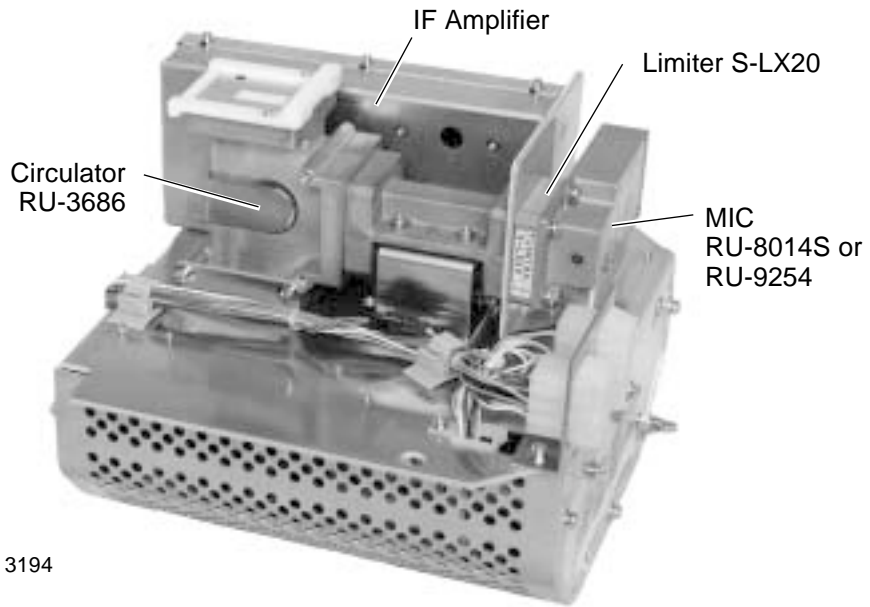
## 5.2 RF Transceiver Unit



*Figure 5-2 RF transceiver unit (FR-8251)*

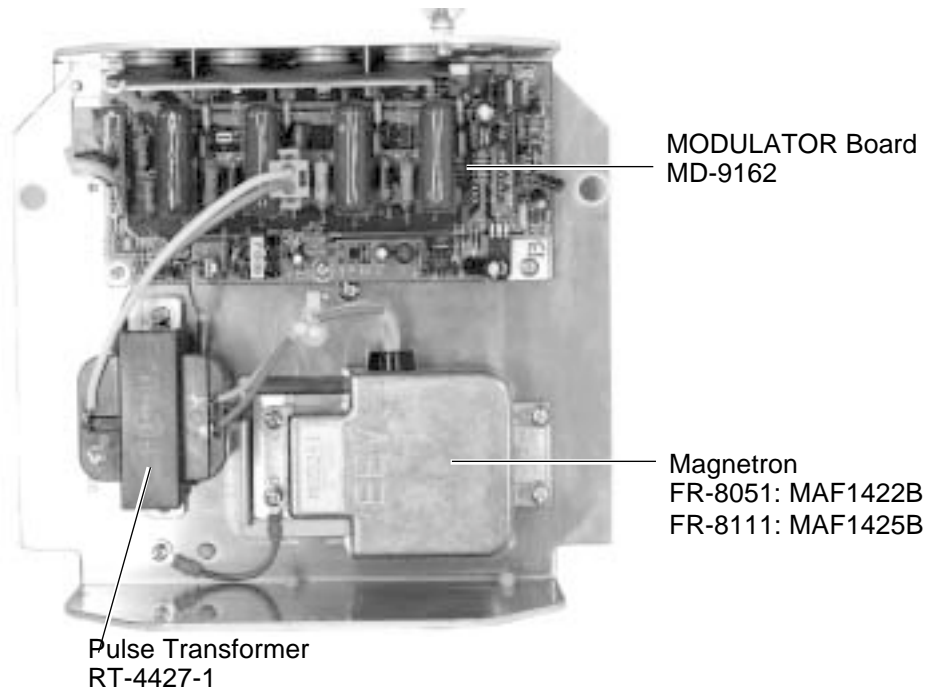


*Figure 5-3 RF transceiver unit (FR-8251), bottom view, cover removed*



N photo No. 3194

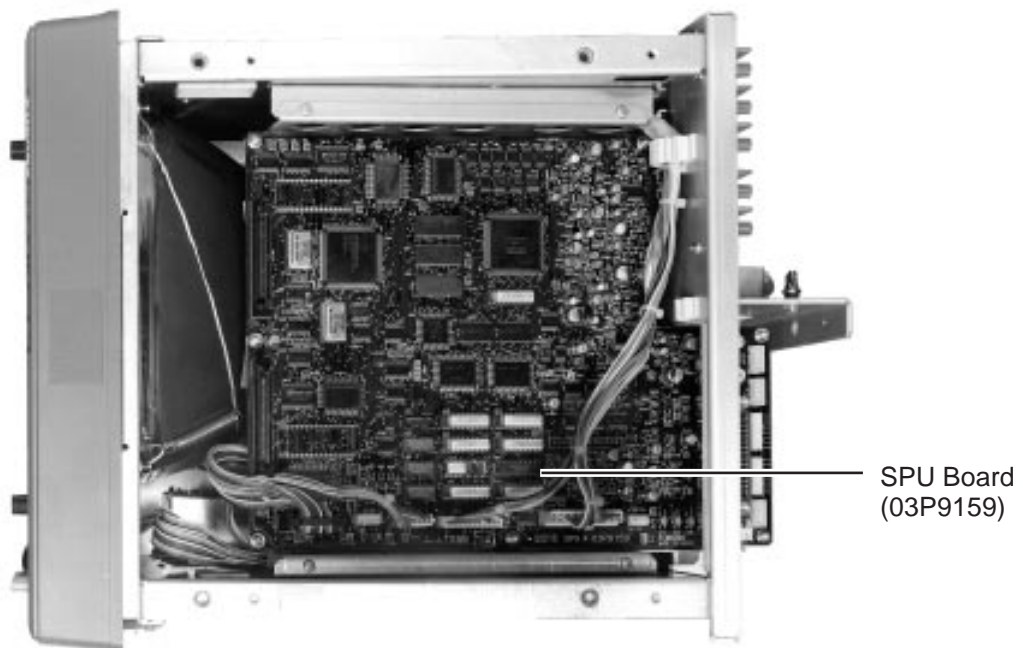
*Figure 5-4 RF transceiver unit (FR-8051/8111)*



N photo No. 3195

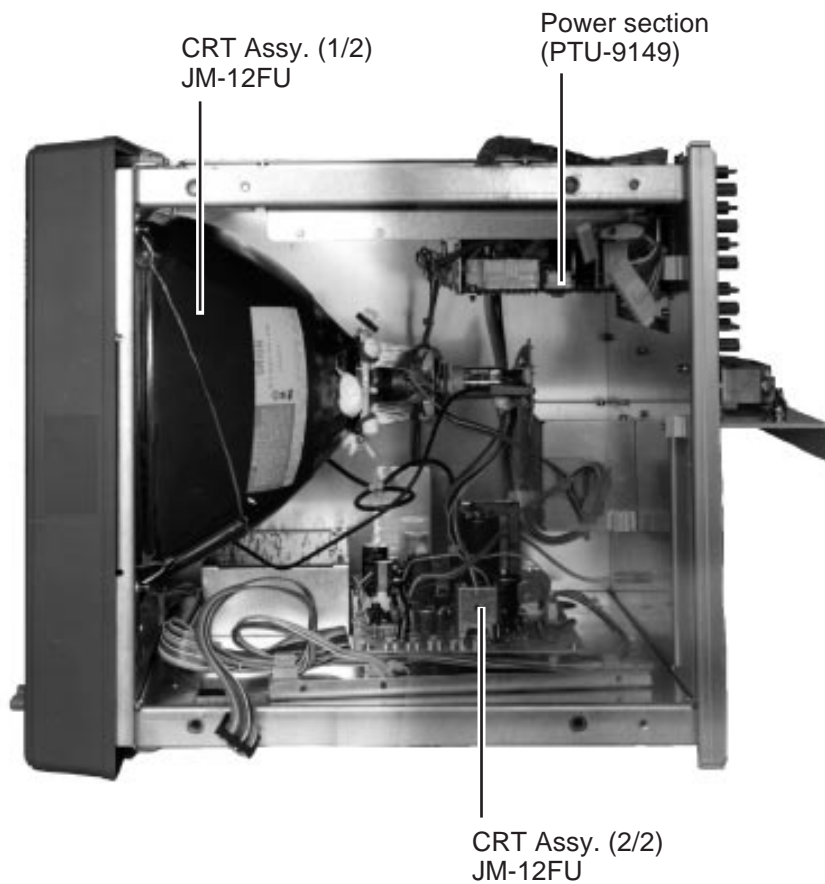
*Figure 5-5 RF transceiver unit (FR-8051/8111), bottom view, cover removed*

## 5.3 Display Unit (common to all models)



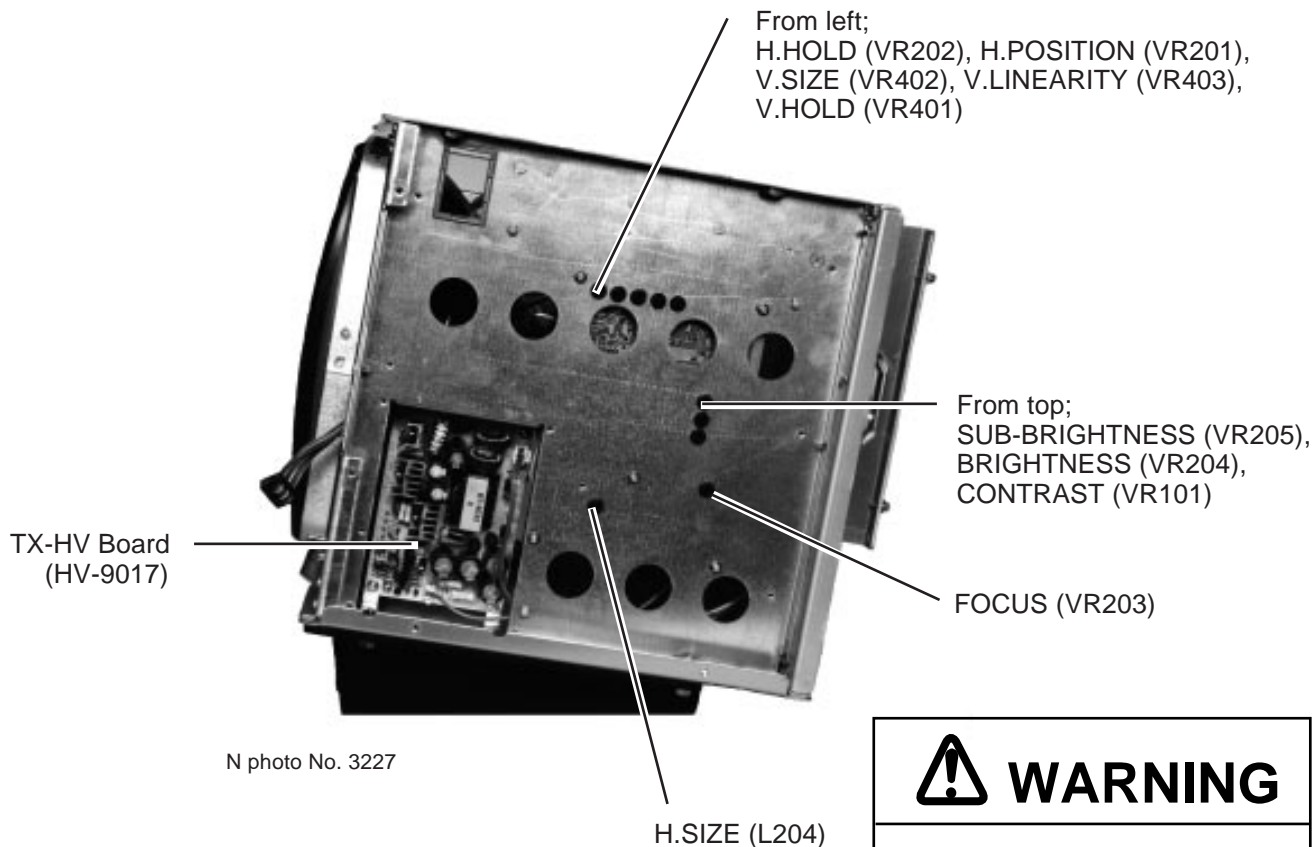
N photo No. 3224

*Figure 5-6 Display unit, top view*




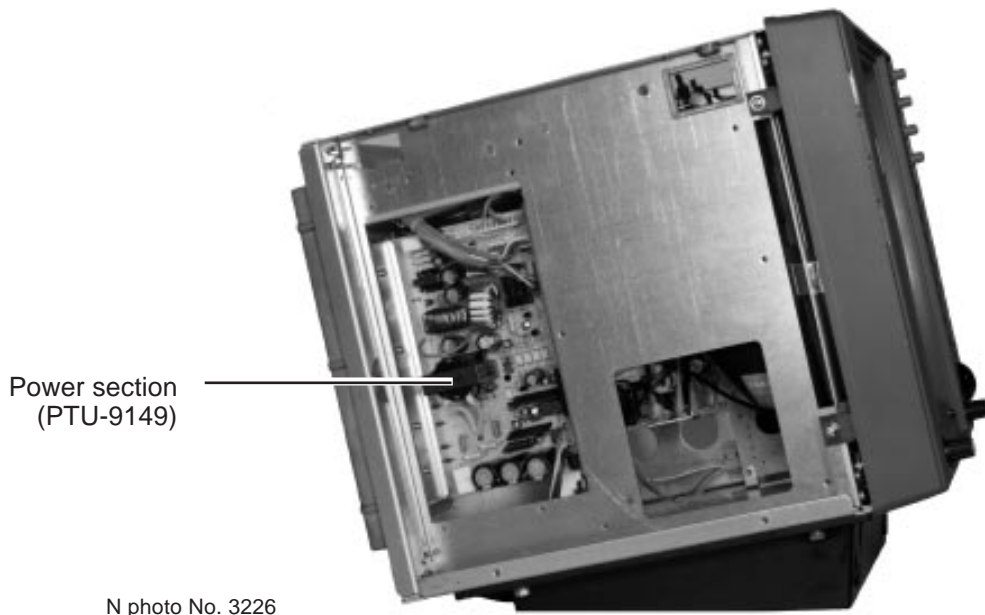
N photo No. 3225

*Figure 5-7 Display unit, top view*



*Figure 5-8 Display unit, right side view*

 <b>WARNING</b>
<p><b>High voltage is present at the potentiometers for adjustment of the picture.</b></p> <p>Use a screwdriver having a non-metallic shank to adjust those potentiometers.</p>



*Figure 5-9 Display unit, left side view*

This page is intentionally left blank.



# Appendix A

## DESCRIPTION OF OPTIONAL EQUIPMENT

This appendix provides a brief description of optional equipment which can be connected to the FR-8051/8111/8251. For more detailed information, see the respective operator's manual.

### A.1 Performance Monitor

A performance monitor is required for a radar installed on vessels of 300 GT and upward engaged in international voyages. For X-band radars, the FURUNO PM-30 satisfies the requirement covering 9410 ±50 MHz.

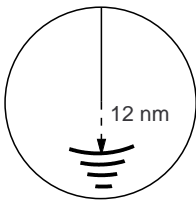
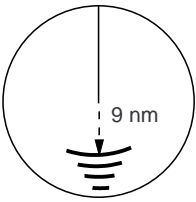
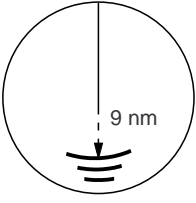
The performance monitor is an independent unit, namely, it is not interconnected with any unit of the radar system except for the 100 VAC power cable. In some radars the power cable is not routed via the power switch or other control of the radar and the monitor is operated as completely a separate device.

#### Operating a performance monitor

Transmit the radar on the 24 nm range scale and select a long pulse. The radar screen will show several arcs, opposite to the heading marker (provided that the performance monitor is installed behind the radar antenna as is normally the case.) If the radar transmitter and receiver are in good working conditions inasmuch as the original state when the monitor was tuned, the innermost arc should appear at 12 nm and there should be a total of 4 arcs.

The range of the innermost arc reduces 3 nm with every 3 dB loss of transmitted power. The receiver sensitivity can be evaluated from the number of visible arcs; one arc is lost every 3 dB deterioration of the sensitivity.

Transmitter performance		Receiver performance	
Range to innermost arc	Loss	No. of arcs	Loss
12 nm	0 dB	4	0 dB
9 nm	3 dB	3	3 dB
6 nm	6 dB	2	6 dB
3 nm or less or none	10 dB	1	9 dB
		0	12 dB

Display	Meaning
	TRANSMITTER: normal RECEIVER: normal
	TRANSMITTER: 3 db loss (Transmitter system has lost half of initial power. Suspect magnetron and feeder system.) RECEIVER: normal
	TRANSMITTER: 3 db loss (Transmitter system has lost half of initial power. Suspect magnetron and feeder system.) RECEIVER: 3 db loss (Receiver has lost half of normal sensitivity. Suspect receiver front end, water leakage in feeder system, etc.)

## **A.2 Auto Plotter ARP-15**

The Auto Plotter ARP-15 is an optional circuit board which is accommodated in the display unit of the radar.

The Auto Plotter can acquire radar targets manually and tracks them. An internal microprocessor calculates target data such as speeds and courses, and this information is displayed in alphanumeric and by vectors.

## **A.3 Video Plotter RP-15**

The Video Plotter RP-15 is optional circuit board which is accommodated in the display unit of the radar.

With the RP-15 you can enter navigation lines or reference lines with as many segments and vertices as required (maximum 25 lines and 30 vertices per line).

An optional memory card enables you to display a digital chart on the radar screen, either along or superimposed on the radar picture.

## **A.4 Fluxgate Heading Sensor C-2000**

The Fluxgate Heading Sensor C-2000 converts magnetic bearing to a bearing signal and outputs it to the radar in AD-100 format.

**FURUNO**

**FURUNO ELECTRIC CO., LTD.**

9-52 Ashihara-Cho, Nishinomiya City, 662-8580, Hyogo, Japan  
Tel: +81 798-65-2111 Fax: +81 798-65-4200

Pub NO. DOC-770

**Declaration of Conformity**



We **FURUNO ELECTRIC CO., LTD.**

(Manufacturer)

9-52 Ashihara-Cho, Nishinomiya City, 662-8580, Hyogo, Japan

(Address)

declare under our sole responsibility that the product

**X-band radar Type: FR-8051**

(Model name, serial number)

is in conformity with the essential requirements as described in the Directive 1999/5/EC of the European Parliament and of the Council of 9 March 1999 on radio equipment and telecommunications terminal equipment (R&TTE Directive) and satisfies all of the following rules, technical standards and recommendations applicable to the product:

EN 60945: 1997-01 (IEC 60945 Third edition: 1996-11)

IEC 60936-1 Amendment 1 Annex D: 2002-06

ITU R.R. Appendix S3 Table 2

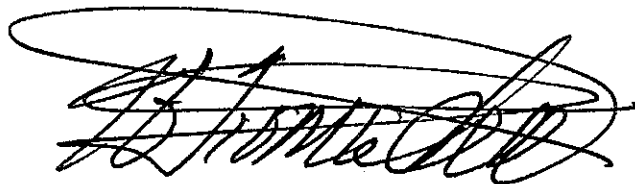
ITU-R M.1177-3: 2003-06, ITU-R SM.1539: 2002-11, ITU-R SM.1541: 2002-11, ITU-R SM.329-9: 2003-02

(title and/or number and date of issue of the standard(s) or other normative document(s))

For assessment, see

- Statement of Opinion N° 00214149/AA/01 of 10 February 2004 issued by Telefication, The Netherlands
- Test report 96308100 of 24 May 1996 prepared by Telefication, The Netherlands
- Test reports TI-1502 of 18 December 1996 and TI-1500 of 27 December 1996 prepared by Furuno Electric Co., Ltd.
- Test report K03-17-196 of 5 January 2004 prepared by Furuno Electric Co., Ltd.

On behalf of Furuno Electric Co., Ltd.



Hiroaki Komatsu  
Manager,  
International Rules and Regulations

Nishinomiya City, Japan  
February 17, 2005

(Place and date of issue)

(name and signature or equivalent marking of authorized person)

**FURUNO®****FURUNO ELECTRIC CO., LTD.**9-52 Ashihara-Cho, Nishinomiya City, 662-8580, Hyogo, Japan  
Tel: +81 798-65-2111 Fax: +81 798-65-4200

Pub NO. DOC-771

**Declaration of Conformity**We **FURUNO ELECTRIC CO., LTD.**

(Manufacturer)

9-52 Ashihara-Cho, Nishinomiya City, 662-8580, Hyogo, Japan

(Address)

declare under our sole responsibility that the product

**X-band radar Type: FR-8111**

(Model name, serial number)

is in conformity with the essential requirements as described in the Directive 1999/5/EC of the European Parliament and of the Council of 9 March 1999 on radio equipment and telecommunications terminal equipment (R&TTE Directive) and satisfies all of the following rules, technical standards and recommendations applicable to the product:

EN 60945: 1997-01 (IEC 60945 Third edition: 1996-11)

IEC 60936-1 Amendment 1 Annex D: 2002-06

ITU R.R. Appendix S3 Table 2

ITU-R M.1177-3: 2003-06, ITU-R SM.1539: 2002-11, ITU-R SM.1541: 2002-11, ITU-R SM.329-9: 2003-02

(title and/or number and date of issue of the standard(s) or other normative document(s))

For assessment, see

- Statement of Opinion N° 00214150/AA/01 of 10 February 2004 issued by Telefication, The Netherlands
- Test report 96308100 of 24 May 1996 prepared by Telefication, The Netherlands
- Test reports TI-1502 of 18 December 1995 and TI-1514 of 27 December 1995 prepared by Furuno Electric Co., Ltd.
- Test report K03-17-195 of 5 January 2004 prepared by Furuno Electric Co., Ltd.

On behalf of Furuno Electric Co., Ltd.

Hiroaki Komatsu  
Manager,  
International Rules and Regulations

Nishinomiya City, Japan  
February 17, 2005

(Place and date of issue)

(name and signature or equivalent marking of authorized person)

**FURUNO®**

**FURUNO ELECTRIC CO., LTD.**

9-52 Ashihara-Cho, Nishinomiya City, 662-8580, Hyogo, Japan  
Tel: +81 798-65-2111 Fax: +81 798-65-4200

Pub NO. DOC-772

**Declaration of Conformity**



We **FURUNO ELECTRIC CO., LTD.**

(Manufacturer)

9-52 Ashihara-Cho, Nishinomiya City, 662-8580, Hyogo, Japan

(Address)

declare under our sole responsibility that the product

X-band radar Type: FR-8251

(Model name, serial number)

is in conformity with the essential requirements as described in the Directive 1999/5/EC of the European Parliament and of the Council of 9 March 1999 on radio equipment and telecommunications terminal equipment (R&TTE Directive) and satisfies all of the following rules, technical standards and recommendations applicable to the product:

EN 60945: 1997-01 (IEC 60945 Third edition: 1996-11)

IEC 60936-1 Amendment 1 Annex D: 2002-06

ITU R.R. Appendix S3 Table 2

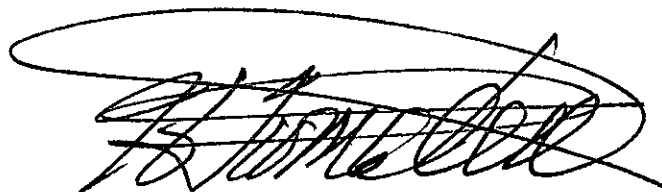
ITU-R M.1177-3: 2003-06, ITU-R SM.1539: 2002-11, ITU-R SM.1541: 2002-11, ITU-R SM.329-9: 2003-02

(title and/or number and date of issue of the standard(s) or other normative document(s))

For assessment, see

- Statement of Opinion N° 00214151/AA/01 of 3 February 2004 issued by Telefication, The Netherlands
- Test report 96326100 of 24 May 1996 prepared by Telefication, The Netherlands
- Test reports TI-1501 of 18 December 1995 and TI-1515 of 27 December 1995 prepared by Furuno Electric Co., Ltd.
- Test report K03-17-192 of 5 January 2004 prepared by Furuno Electric Co., Ltd.

On behalf of Furuno Electric Co., Ltd.



Hiroaki Komatsu  
Manager,  
International Rules and Regulations

Nishinomiya City, Japan  
February 17, 2005

(Place and date of issue)

(name and signature or equivalent marking of authorized person)

## Free Manuals Download Website

<http://myh66.com>

<http://usermanuals.us>

<http://www.somanuals.com>

<http://www.4manuals.cc>

<http://www.manual-lib.com>

<http://www.404manual.com>

<http://www.luxmanual.com>

<http://aubethermostatmanual.com>

Golf course search by state

<http://golfingnear.com>

Email search by domain

<http://emailbydomain.com>

Auto manuals search

<http://auto.somanuals.com>

TV manuals search

<http://tv.somanuals.com>