

FURUNO

INSTALLATION MANUAL

INTERFACE UNIT

MODEL VI-1100A



FURUNO ELECTRIC CO., LTD.
NISHINOMIYA, JAPAN

©FURUNO ELECTRIC CO., LTD.

9-52, Ashihara-cho,
Nishinomiya, Japan 662

Telephone: 0798-65-2111
Telefax: 0798-65-4200

-Your Local Agent/Dealer

All rights reserved. Printed in Japan

FIRST EDITION : SEP 1985
F : JUN. 18, 1998

(TATA)

PUB. No. IME-20180-F
VI-1100A





SAFETY INSTRUCTIONS

"DANGER", "WARNING" and "CAUTION" notices appear throughout this manual. It is the responsibility of the installer of the equipment to read, understand and follow these notices. If you have any questions regarding these safety instructions, please contact a FURUNO agent or dealer.



DANGER

This notice indicates a potentially hazardous situation which, if not avoided, will result in death or serious injury.



WARNING

This notice indicates a potentially hazardous situation which, if not avoided, could result in death or serious injury.



CAUTION

This notice indicates a potentially hazardous situation which, if not avoided, could result in minor or moderate injury, or property damage.

WARNING



**Hazardous voltage.
Can shock, burn or cause
serious injury.**

Do not work inside the equip-
ment unless totally familiar
with electrical circuits.

**Turn off the power at the mains switch-
board before beginning the installation.**

Electrical shock or fire can result if the
power is not turned off.

CAUTION



**Ground the equipment to
prevent electrical shock
and mutual interference.**

**Confirm that the power supply voltage
is compatible with the voltage rating
of the equipment.**

Connection to the wrong power supply
can cause fire or equipment damage. The
voltage rating appears on the label at the
rear of the display unit.

Use the correct fuse.

Use of a wrong fuse can cause fire or
equipment damage.

CONTENTS

* * * * *

	<u>Page</u>
INTRODUCTION	1
Chapter 1. INSTALLATION	1
Chapter 2. ECHO SOUNDER INTERFACING	1 thru 9
2-1. VI-1100A Input Requirements	2
2-2. Adjustment of Interface Unit	5
2-3. Fine Adjustment of Echo Level	8
OUTLINE DRAWING	10
LIST OF INSTALLATION MATERIALS	11
SCHEMATIC DIAGRAM	12
INTERFACING METHOD TO COLOR VIDEO SOUNDER	13
1. FE-808	13

Attaching toroidal Core (To comply with EMC requirement)

Toroidal cores are supplied with the installation materials. Attach them as close as possible to the echosounder end of the interconnection cables as shown below.

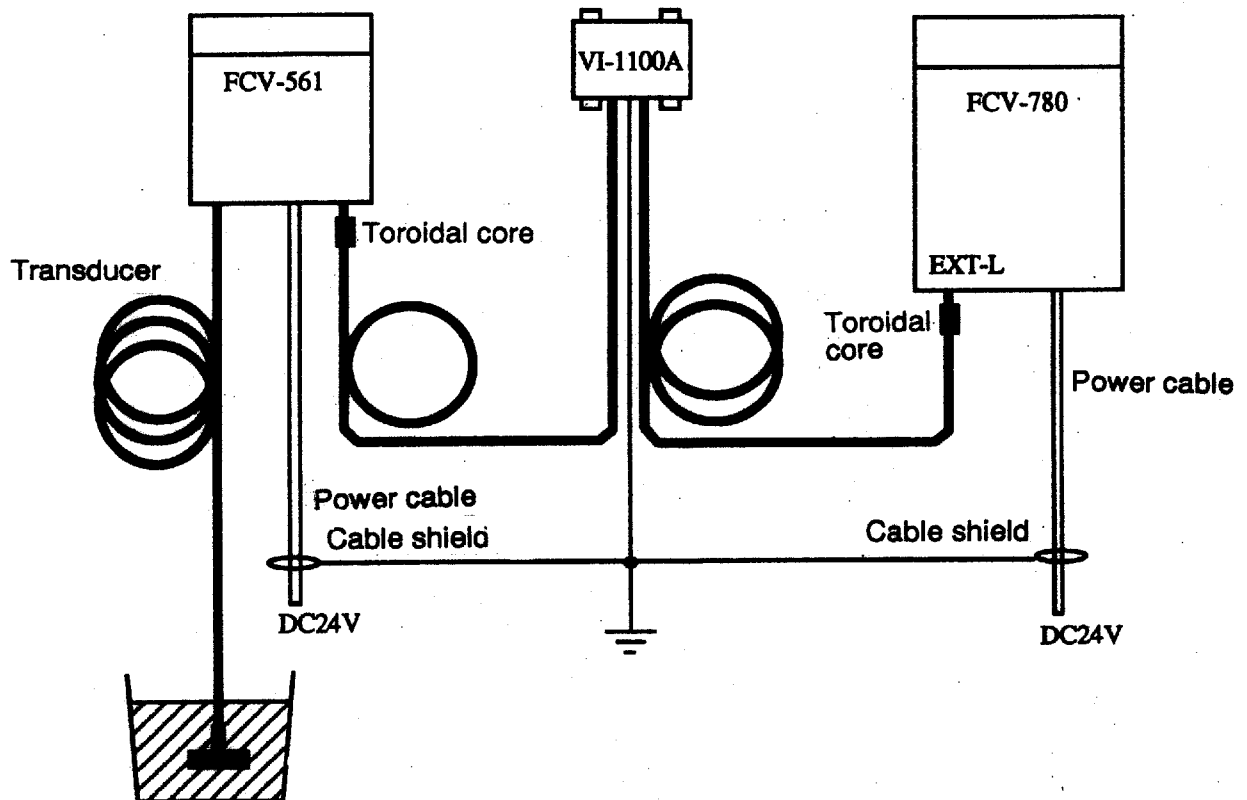

INTRODUCTION

The VI-1100A Interface Unit is basically designed to feed an echo signal from Furuno paper echo sounders to color video sounders for the purpose of monitoring an echo signal in a variety of colors.

Interfacing methods between Furuno's echo sounders (net recorder, sonar), the interface unit and the color video sounders are collected and given on pages 13 thru 36.

One piece of the VI-1100A interface unit is required for each frequency of an echo signal with the following exceptions; For the FE-606, FE-880/880T and FE-881/881II echo sounders, an echo signal can be directly fed to the color video sounder without the use of the interface unit.

An additional switch box EX-7 (or EX-6) may be used between the interface units (transceiver units) and the color video sounder for expansion of the channel number. As to cabling method between them, refer to the installation manual for EX-7 Switch Box. (Publication No. IM-E2010-0A)

Chapter 1. INSTALLATION

The VI-1100A Interface Unit should be sited as nearby the echo sounder, sonar or net-recorder as possible (max. 2m) because a weak signal is handled. If a longer cable is used, color display and echogram are degraded in fidelity. Also, care should be taken not to bundle the interface cables with others handling RF signal, pulses or power.

Chapter 2. ECHO SOUNDER INTERFACING

The following diagrams show the system configurations with or without external echo sounder(s), EX-7 (or EX-6) Switch Box, ETR-2A/B/C/D Transceiver Unit and MT-12 Picture Recorder. Refer to the operator's manuals of the individual color video sounders to show a variety of system configuration.

This chapter describes how to hook up necessary signals in the echo sounder and how to adjust the VI-1100A interface unit because these are fixed irrespective of type of color video sounder.

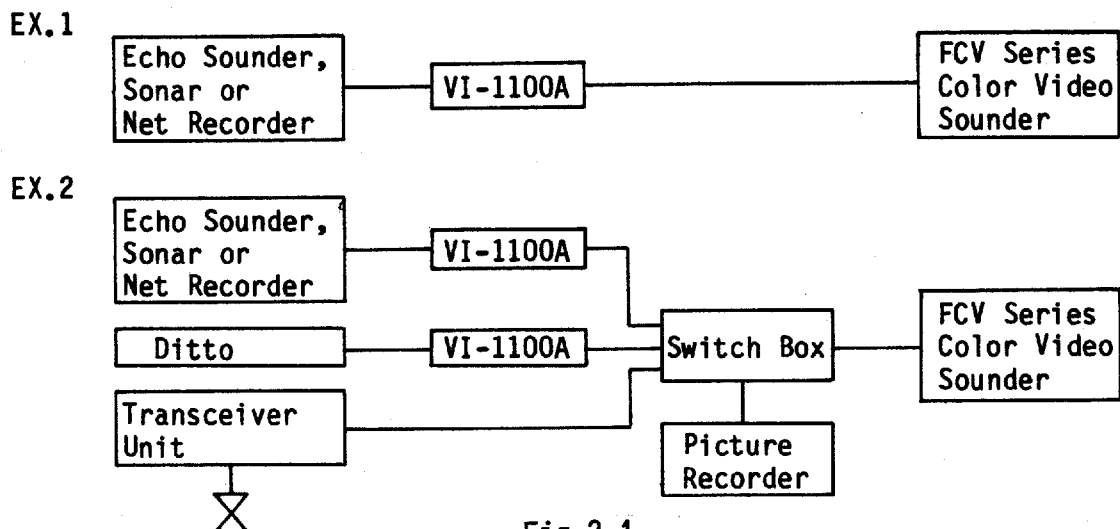

Fig.2-1

2-1. VI-1100A Input Requirements

Fig.2-2 shows what kind of signals should be fed from the echo sounder, and Table 2-1 shows their specifications. The first step of echo sounder interfacing is to find out such signal sources in the echo sounder circuit.

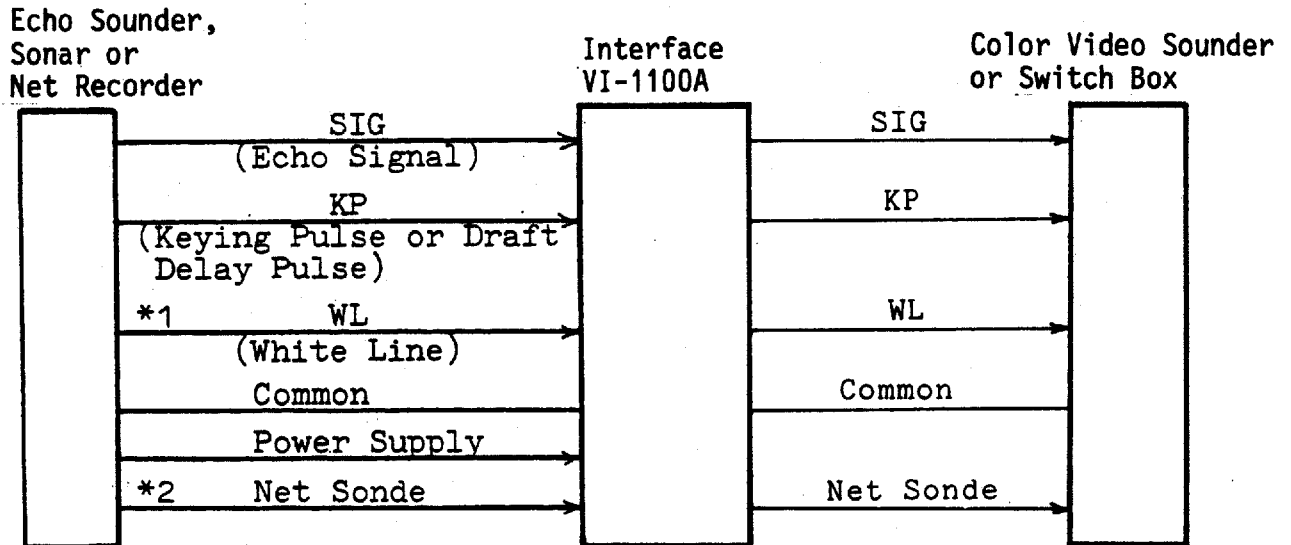

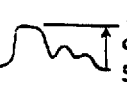
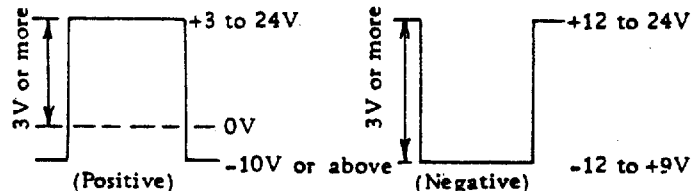

Fig.2-2

Table 2-1

Signal Name	Specifications of Input Signal	
SIG (Echo)	"AC"	IF (10 to 455KHz) Signal or Pen Output Signal of Dry Paper Recorder* ³ .  0.5 to 10Vpp
	"DC"	Pen Output Signal of Wet Paper Recorder* ³ , Scanning Sonar, Net Recorder, Telesounder, etc.  5 to 30Vpeak or 50 to 100Vpeak
KP (Keying Pulse)	Trigger Pulse or Draft Delay Pulse* ⁴ if draft control is provided on the combined echo sounder. 	
WL (White Line)	White Line Pulse. Specifications are same as KP.	
Power Supply	DC Voltage, +12 to +30V. Power drain is 70mA.	

Note *1 No connection if echo signal (SIG) is not effected by the white line control.

*2 No connection if a net sonde is not coupled.

*3 It is recommended to take an echo signal at an IF younger stage of the echo sounder for higher fidelity. Pen output signal can be used with lower fidelity picture as it is somewhat saturated.

When using pen output signal of a dry paper recorder, add a voltage divider for 0.5 to 10Vpp output.

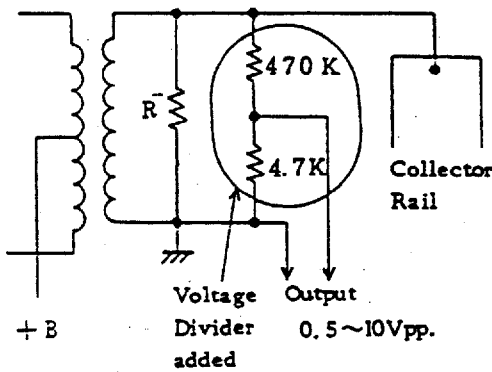

Pen Output Signal of
Dry Paper Recorder
("AC" Mode)

Fig.2-3

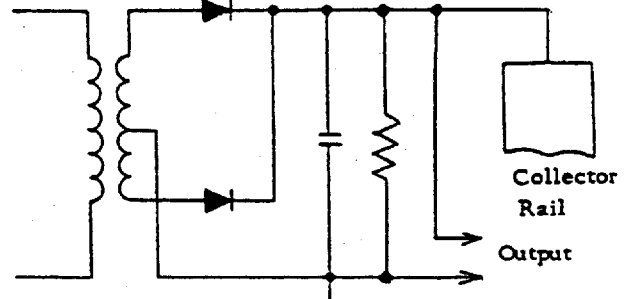

Pen Output Signal of
Wet Paper Recorder
("DC" Mode)

Fig.2-4

*4 In case of **Trigger** or **Draft Delay Pulse**, the draft adjustment at the echo sounder moves up or down the zero line position in the picture.

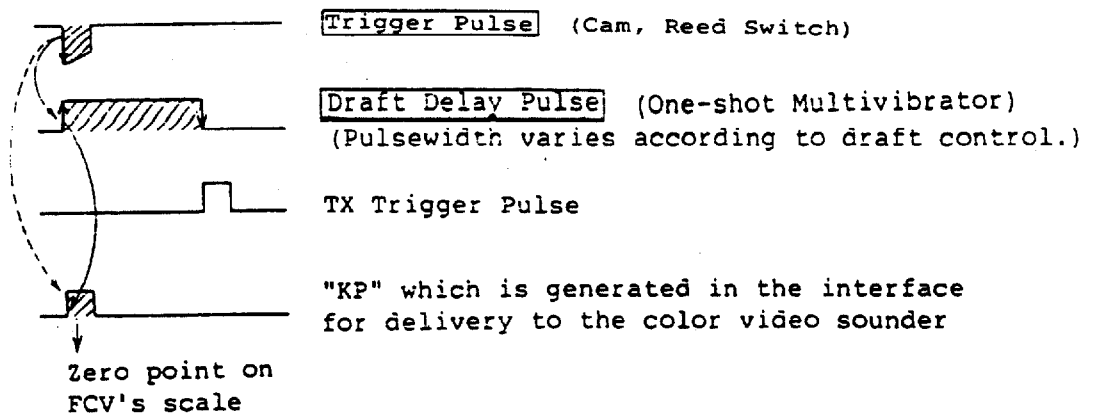

Fig.2-5

In case of **TX Trigger**, the draft adjustment at the echo sounder does not affect the zero line position in the picture.

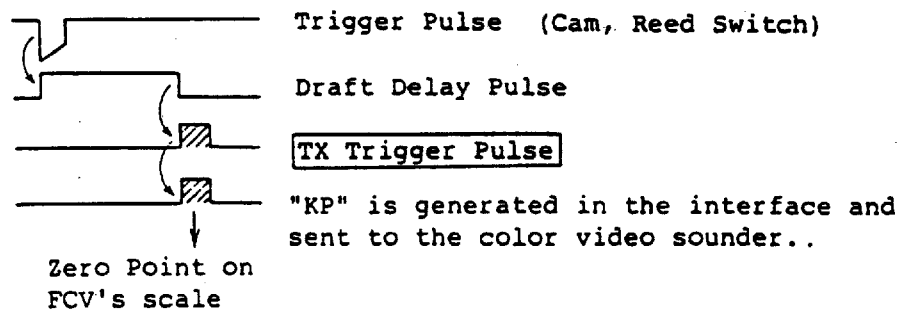

Fig.2-6

How to hook up a net sonde signal

To plot the net depth mark both on the Color Video Sounder and the external echo sounder;

Add a diode (U06C, F114B or equivalent) in the echo sounder and bypass the net depth signal to the Color Video Sounder as shown below.

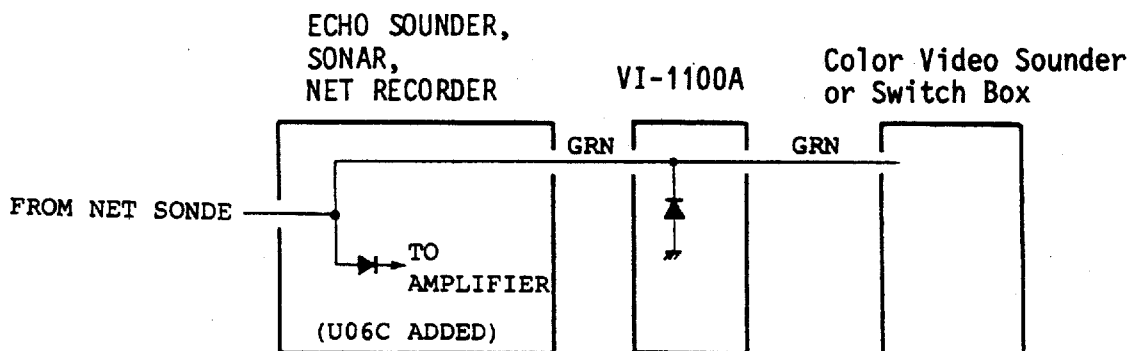

Fig.2-7

Characteristics of U06C and F114B Table 2-2

Type	U06C	F114B
FURUNO Code	000135901	000132716
Application	Rectifier	Rectifier
Construction	Si. D.	Si. D.
Absolute Maximum Ratings (25°C)		
Max. DC Reverse Voltage	200V	200V
Max. Average DC Output Current	2A	800mA
Max. Forward Transit Current	80A	40A

2-2. Adjustment of Interface Unit

Parts to be adjusted on the circuit board are shown below.

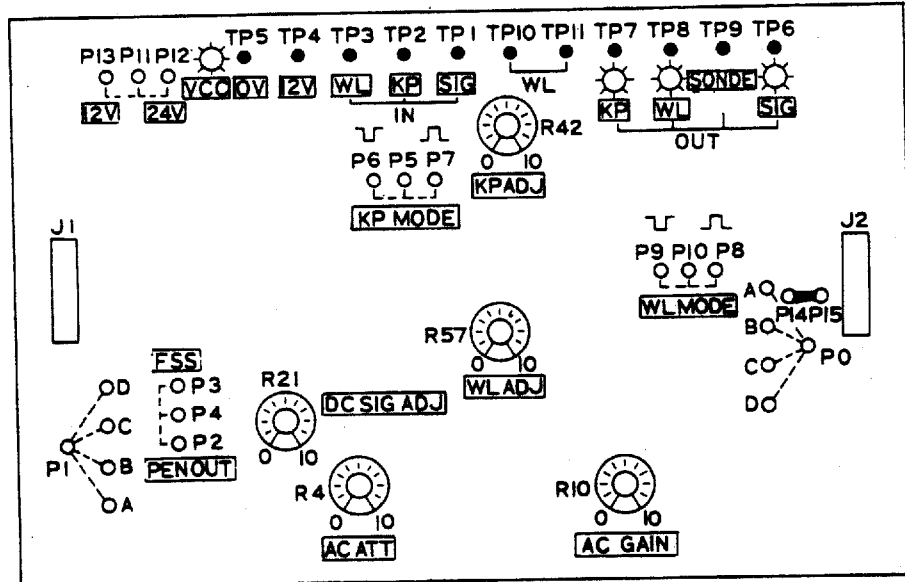

Fig.2-8

- (1) According to the signals selected in the previous paragraph, connect jumper leads as below.

Table 2-3

S I G N A L			Jumper connection		
SIG	AC	10 to 455kHz	P0-A	P1-A	
	DC	50 to 100Vpeak	P0-B	P1-B	P4-P2
		5 to 30Vpeak	P0-B	P1-B	P4-P3
KP	Positive		P5-P7		
	Negative		P5-P6		
WL	Positive		P10-P8		
	Negative		P10-P9		
Power	+15V to +30V		P11-P12		
	+12V to +14V		P11-P13		

} ONLY WHEN "WL" IS FED

NOTE P14-P15: Usually cut off the jumper wire.
(See NOTE 3 on page 8.)

(2) Adjustment

Place the Color Video Sounder and the combined echo sounder under the following condition.

Color Video Sounder

GAIN Control : "5"
THRESHOLD Control: "0"

Combined Echo Sounder

GAIN control : mid-point
RANGE switch : minimum range with which bottom echo tail is appreciable.

Keying Pulse, KP

- ① Turn **KP ADJ** between CW and CCW limits and read the range where **KP OUT** blinks.
- ② Set KP ADJ at the mid point of the range.

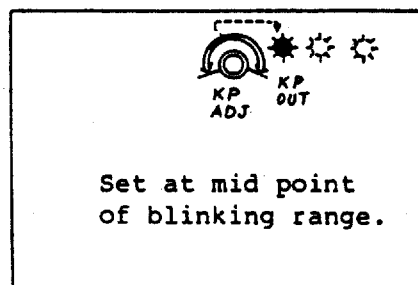

Fig.2-9

White Line, WL (only when WL signal is fed.)

- ① Effect WHITE LINE of the combined echo sounder.
- ② Turn **WL ADJ** between CW and CCW limits and read the range where **WL OUT** blinks.
- ③ Set **WL ADJ** at the mid point of the range.

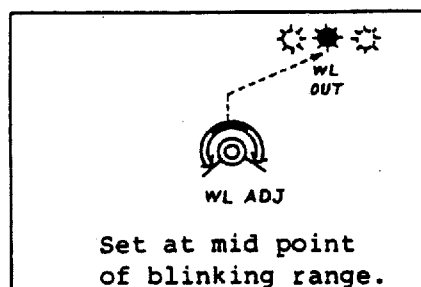

Fig.2-10

Echo Signal, SIG

AC mode signal

- ① Turn off WHITE LINE of the combined echo sounder if provided.
- ② Fix **AC GAIN** at the CCW limit.
- ③ Gradually turn **AC ATT** clockwise until **SIG OUT** begins to blink.

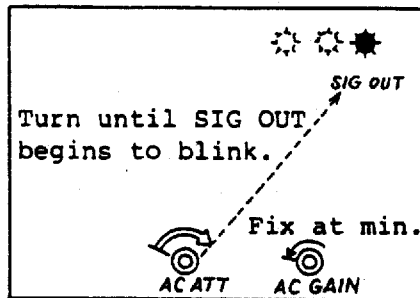
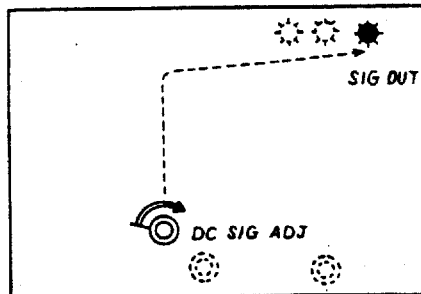

Fig.2-11

Note If **SIG OUT** does not blink with **AC ATT** turned fully CW, slowly turn **AC GAIN** clockwise until **SIG OUT** begins to blink with **AC ATT** fixed at the CW limit.

DC mode signal

- ① Turn off WHITE LINE of the combined echo sounder if provided.
- ② Gradually turn **DC SIG ADJ** clockwise until **SIG OUT** begins to blink.
- ③ Further turn **DC SIG ADJ** clockwise by one graduation of the potentiometer.





Turn until **SIG OUT** begins to blink, and further turn by one graduation only.

Fig.2-12

NOTE 1. The Interface unit is so designed that the following output levels may be obtained when the above-mentioned adjustments are correctly done.

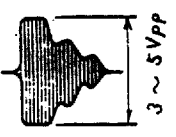
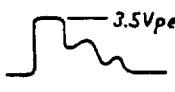
Table 2-4

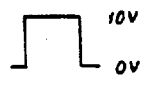
ECHO SIGNAL	S I G	KEYING PULSE	WHITE LINE
' A C '	' D C '	K P	W L
 <p>(TP 6)</p>	 <p>(TP 6)</p>	 <p>(TP 7)</p>	 <p>(TP 8)</p>

- If the picture scrolling is abnormal (entirely no, random, intermittent, etc.), check if fair KP waveform presents on TP7.
- If the screen is fully or partially painted in reddish brown color, check WL waveform on TP8. Note that HIGH level on this pin causes reddish brown color on the screen.

As a rare case, there is such an echo sounder that produces a white line signal not only at the seabed return but also during full period of the draft delay in order to inhibit recording above the zero line. If such a white line signal is fed to the color video sounder, it will completely fill the draft space with reddish brown color. When this case is encountered, gate the white line signal by (1) feeding the negative output of the draft delay one-shot to the interface unit as KP and (2) connecting a jumper wire between P14 and P15.

2-3. Fine Adjustment of Echo Level

The echo level should be finally adjusted so that the sensitivity of the Color Video Sounder may be a little higher than that of the combined echo sounder.

- Place the Color Video Sounder and the combined echo sounder under the following condition.

Color Video Sounder

GAIN control : "5"
THRESHOLD control: "0"

Combined Echo Sounder

GAIN control : mid point
RANGE switch : minimum range with which bottom echo tail is appreciable.

- ② Read out the depth "D" at the end of the bottom echo tail from the range scale of the combined echo sounder.
- ③ Check if:
 - the bottom echo tail by the Color Video Sounder is painted deeper than that by the combined echo sounder.
 - the bottom echo tail is LIGHT BLUE or GREEN at the depth "D".

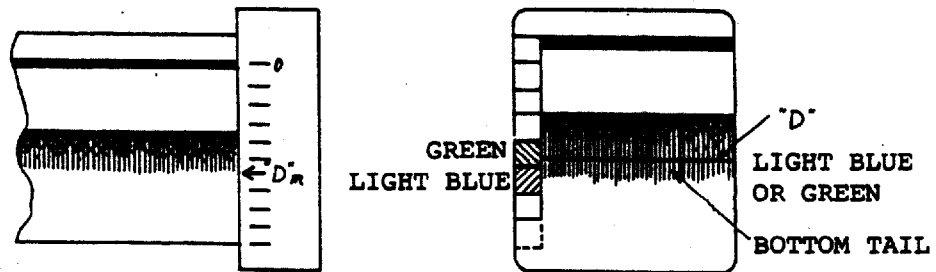

Fig.2-13

- ④ If the above condition is not obtained, adjust the Interface Unit again.

AC Mode Signal

Fine-adjust **AC ATT** so that the bottom tail at the depth "D" may be LIGHT BLUE or GREEN. (If **AC ATT** is already turned fully clockwise, adjust **AC GAIN** instead.)

DC Mode Signal

Fine-adjust **DC SIG ADJ** so that the bottom echo tail at the depth "D" may be LIGHT BLUE or GREEN.

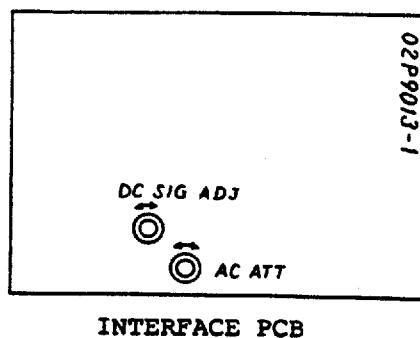

Fig.2-14

A

B

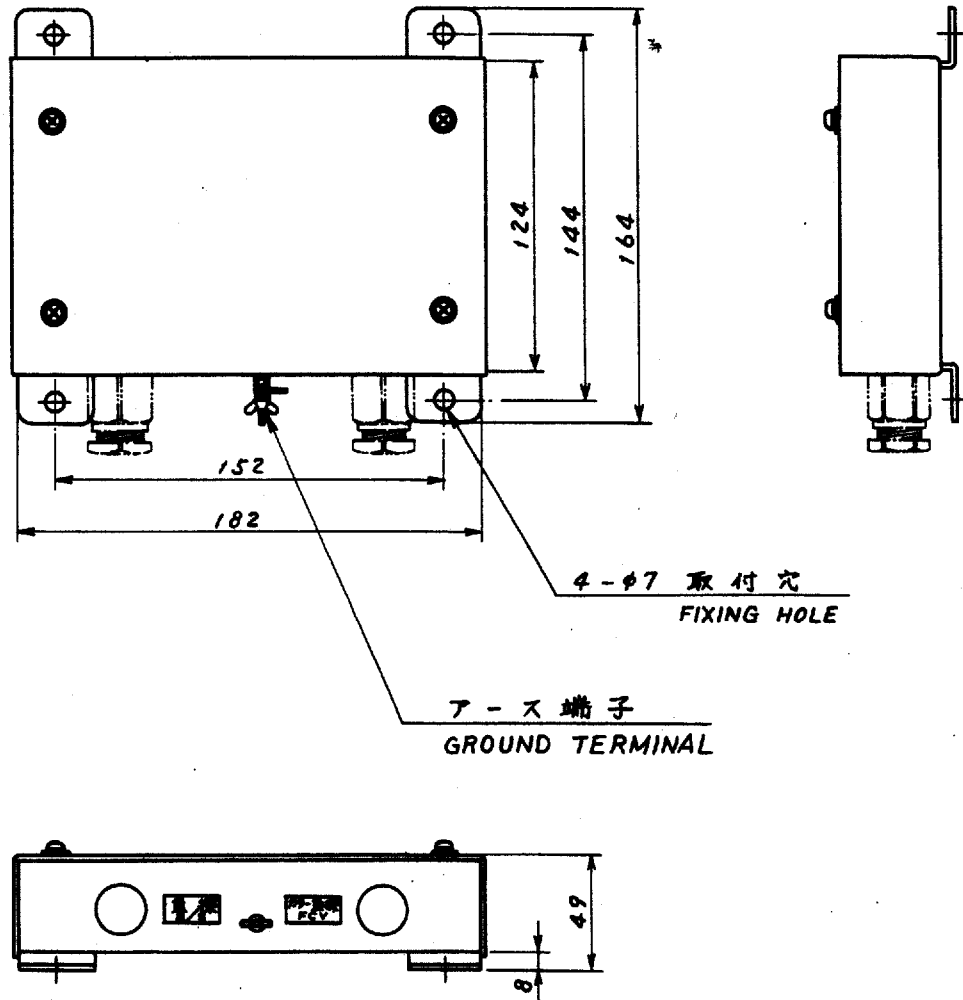

C

D

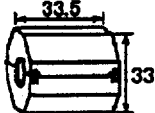
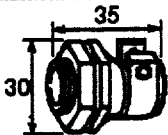
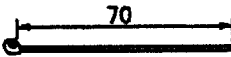

承認 APPROVED	品番 ITEM	品名 NAME	材質 MATERIAL	数量 Q'TY	図番 DWG.NO.	摘要 REMARKS
<i>[Signature]</i>		三角法 THIRD ANGLE PROJECTION				名称 TITLE VI-1100A インターフェース外觀図 INTERFACE UNIT
検図 CHECKED	<i>[Signature]</i>	尺度 SCALE 1/3				
製図 DRAWN		重量 WEIGHT 2 kg			図番 DWG.NO. C2261-026-B	

FURUNO

工事材料表 INSTALLATION MATERIALS		VI-1100A 魚探インターフェース E/S INTERFACE UNIT		CODE NO.	02BL-X-9401 -2
				TYPE	1/1
番号 NO.	名称 NAME	略図 OUTLINE	型名/規格 DESCRIPTIONS	数量 Q'TY	用途/備考 REMARKS
1	コア(EMI) CORE(EMI)		ESD-SR-25	2	
			CODE NO.		
2	コードロック CORD LOCK		NC-1	1	
			CODE NO.		
3	コパックス PLASTIC BAND		CV-70	5	
			CODE NO.		
4	インターフェースケーブル(3)組品 I/F CABLE ASSY. (3)		VI-1100A-C 02S8040 (6M-NH8P)	1	
			CODE NO.		
5	インターフェースケーブル(4)組品 I/F CABLE ASSY. (4)		VI-1100A-C 02S8040 (2M-NH10P)	1	
			CODE NO.		
6	締付ナット NUT		02-009-0801-0	1	
			CODE NO.		
7	ワッシャー WASHER		02-009-0802-0	1	
			CODE NO.		

C2018-M01- B

FURUNO ELECTRIC CO., LTD

(略図の寸法は、参考値です。 DIMENSIONS IN DRAWING FOR REFERENCE ONLY.)

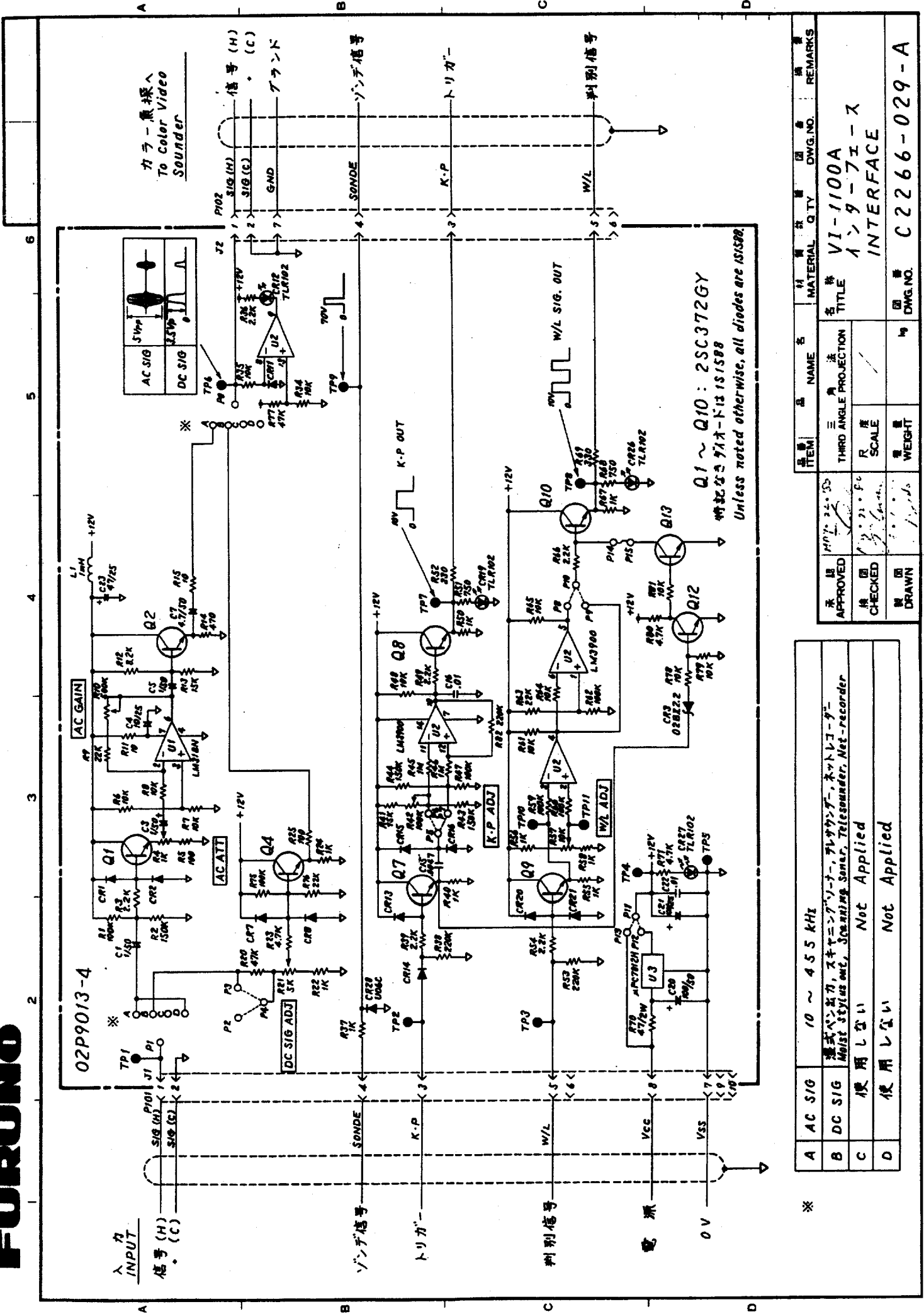

02P9013-4

カラ-魚探へ
To Color Video
SOUNDER

Q1 ~ Q10 : 2SC372GY
特記なきトロードは1S1588
Unless noted otherwise, all diodes are 1S1588.

品名	ITEM	品名	NAME	材	質	材	品	数量	QUALITY	団	番	團	番	備	考
承認	APPROVED	訂正	REVISED	承認	APPROVED	訂正	REVISED	材料	MATERIAL	数量	QTY	図番	DWG. NO.	備考	REMARKS
検査	CHECKED	製	DRAWN	角法		THRD ANGLE PROJECTION		名称		TITLE		VI-1100A		インターフェイス	

A	AC SIG	10 ~ 455 kHz	※
B	DC SIG	摆式ペン出力, スキヤンブローカー, テレサウンダ, ネットレコーダ Moist Stylus out, Scanning Sonar, Telesounder, Net-recorder	
C		使用しない Not Applied	
D		使用しない Not Applied	

1. NECESSARY PARTS

Table 1

Name	Type	Qty	Note
Interface Unit	VI-1100A	1	With 02S8040 cables (2m/6m) (factory-terminated with connectors at inter-face ends.)
Cord Lock	MC-1	1	Supplied as installation materials.
Lead Binder	CV-70	5	Supplied as installation materials.
Grounding Lead	(Black Vinyl) 20cm		(Procure locally.)
Diode	F114B or U06G	1	for Net Sonde (Procure locally.)
Lug Board	2P	1	for Net Sonde (Procure locally.)
Carbon Resistor	100Ω, 1/4W	1	(Procure locally.)

2. CABLING

- Install the interface unit as near by the echo sounder as possible.
- Insert the cord lock into the spare hole on the bottom of the recorder as shown in Fig. 5.
- Pass the 2m cable through the cord lock, and fabricate the cable end as shown right.
- Solder the core leads to signal hook-up points inside the equipment. (Fig. 5)

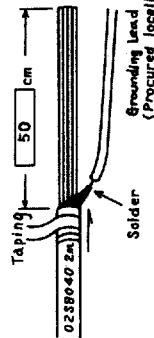

Fig. 1

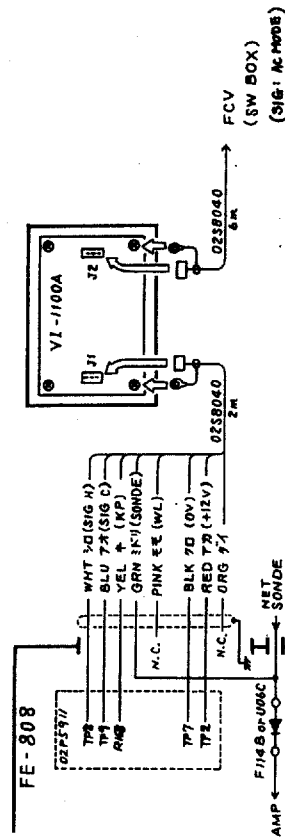
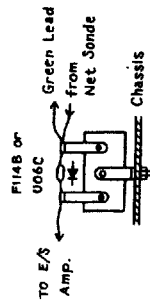

Fig. 2

If a net sonde is combined, mount the 2p lug board at a suitable place in the echo sounder, solder the diode (F114B or U06C) to it and make wiring as shown left.



- Modify the PCB 02P9013 as shown in Fig. 6.

3. JUMPER CONNECTION

Confirm that all jumper leads inside the interface unit are connected in position as shown below. (Pot positions show typical settings.)

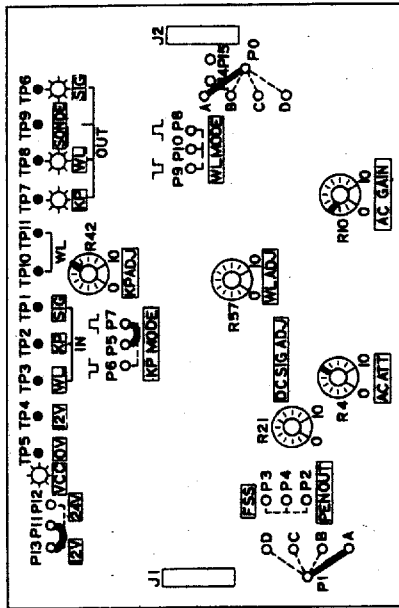

Fig. 3

4. INTERFACE ADJUSTMENT

Conditions FCV----- GAIN "5", CLUTTER "0"
Echo Sounder----- RANGE: Minimum range where bottom echo tail is appreciable.

GAIN : Mid range, TVG: Minimum

- Keying Pulse "KP"

Turn [KP ADJ] (R42) to position "5", and confirm that [KP] (CR19) blinks.

- Echo Signal "SIG" (Turn off SHADOW LINE of the echo sounder for this item.)

With [AC GAIN] (R10) fixed at cw limit, slowly turn [AC ATT] (R4) clockwise until [SIG] (CR12) begins to blink.

(If [SIG] does not blink, slowly turn [AC GAIN] clockwise until it begins to blink while [AC ATT] is fixed at cw limit.)

承認 APPROVED	検査 CHECKED	製図 DRAWN	名称 TITLE
Dec. 13. 84	Dec. 13. 84	Dec. 13. 84	INTERFACING FE-808 TO COLOR VIDEO SOUNDER
			図番 DWG. NO.
			E2018-009-A
			(1/2)

Table 2 Typical Signal Levels

INPUT	SIG		KP
	TP1		TP2
OUTPUT	TP6		TP7

(3) Fine Adjustment of SIG Level

Read the depth "D" at the tip of bottom echo tail on the recording. Fine adjust **AC ATT** so that its depth is painted in LIGHT BLUE or GREEN on the screen. (If **AC ATT** is already turned fully clockwise, adjust **AC GAIN** instead.)

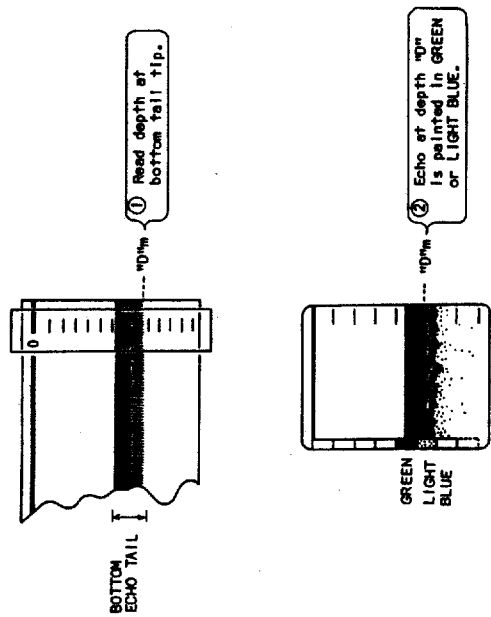

Fig. 4

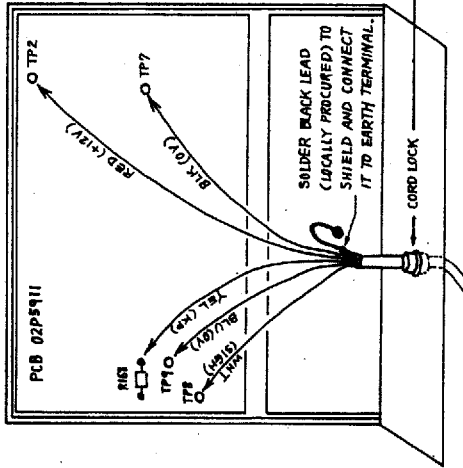

Fig. 5 FE-808 Recorder

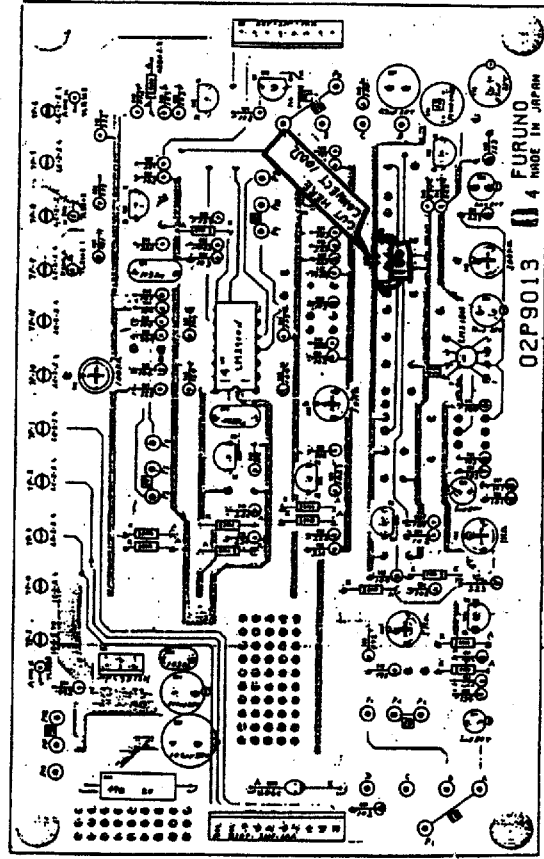

Fig. 6 PCB 02P9013

Free Manuals Download Website

<http://myh66.com>

<http://usermanuals.us>

<http://www.somanuals.com>

<http://www.4manuals.cc>

<http://www.manual-lib.com>

<http://www.404manual.com>

<http://www.luxmanual.com>

<http://aubethermostatmanual.com>

Golf course search by state

<http://golfingnear.com>

Email search by domain

<http://emailbydomain.com>

Auto manuals search

<http://auto.somanuals.com>

TV manuals search

<http://tv.somanuals.com>