

FURUNO

OPERATOR'S MANUAL

COLOR SCANNING SONAR

MODEL CSH-5L/CSH-8L



FURUNO ELECTRIC CO., LTD.
NISHINOMIYA, JAPAN

PRINTED IN JAPAN

© **FURUNO ELECTRIC CO., LTD.**

9-52 Ashihara-cho,
Nishinomiya, Japan

Telephone : 0798-65-2111
fax : 0798-65-4200

Your Local Agent/Dealer

All rights reserved.

Printed in Japan

PUB.No. OME-13190

(YOSH) CSH-5L/8L

FIRST EDITION : DEC . 2002

C : JUL . 06, 2004



* 0 0 0 8 0 9 4 0 4 0 2 *



* O M E 1 3 1 9 0 C 0 0 *



SAFETY INSTRUCTIONS



WARNING



ELECTRICAL SHOCK HAZARD Do not open the equipment.

Only qualified personnel should work inside the equipment.

Immediately turn off the power at the switchboard if water leaks into the equipment or something is dropped in the equipment.

Continued use of the equipment can cause fire or electrical shock. Contact a FURUNO agent for service.

Do not disassemble or modify the equipment.

Fire, electrical shock or serious injury can result.

Do not place liquid-filled containers on the top of the equipment.

Fire or electrical shock can result if a liquid spills into the equipment.

Immediately turn off the power at the switchboard if the equipment is emitting smoke or fire.

Continued use of the equipment can cause fire or electrical shock. Contact a FURUNO agent for service.

Make sure no rain or water splash leaks into the equipment.

Fire or electrical shock can result if water leaks in the equipment.



WARNING

Use the proper fuse.

Fuse rating is shown on the equipment. Use of a wrong fuse can damage the equipment.

Do not operate the equipment with wet hands.

Electrical shock can result.

⚠ CAUTION

Do not exceed 18 knots with the transducer lowered and do not exceed 16 knots when lowering or raising the transducer.

The transducer may become damaged.

Turn off the hull unit before using the hand crank.

Bodily injury may result if the power is not turned off.

The zinc block attached near the transducer must be replaced yearly.

The junction between the transducer and main shaft may corrode, which can result in loss of the transducer or water leakage inside the ship.

WARNING LABEL

A warning label is attached to all units of the system. Do not remove any label. If a label is missing or damaged, contact a FURUNO agent or dealer about replacement.

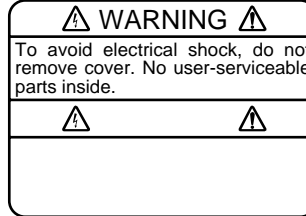

Name: Warning Label (1)
Type: 86-003-1011-1
Code No.: 100-236-231

TABLE OF CONTENTS

FOREWORD	vi
SYSTEM CONFIGURATION	vii
1. OPERATIONAL OVERVIEW	1-1
1.1 Control Unit.....	1-1
1.2 Remote Controller (option).....	1-2
1.3 Basic Operating Procedure	1-3
1.3.1 Turning on the power	1-3
1.3.2 Lowering the transducer.....	1-3
1.3.3 Transmitting	1-4
1.3.4 Adjusting backlighting of control unit	1-5
1.3.5 Choosing a display mode	1-6
1.3.6 Choosing the display range.....	1-8
1.3.7 Adjusting the gain	1-9
1.3.8 Retracting the transducer, turning off the power	1-9
1.4 Setting the Tilt Angle	1-10
1.4.1 Automatic tilt on/off.....	1-10
1.4.2 Bottom and tilt angle	1-12
1.4.3 How to discriminate fish echoes from the bottom	1-12
1.4.4 Points to consider.....	1-13
1.4.5 Tilt angle for surface fish	1-13
1.4.6 Suitable tilt angle.....	1-14
1.5 Finding Range and Bearing to a Target.....	1-14
1.6 Sonar Menu Overview.....	1-15
1.6.1 Operating procedure	1-15
1.6.3 Sonar menu description	1-16
2. FINE TUNING THE SONAR PICTURE	2-1
2.1 Eliminating Unwanted Echoes.....	2-1
2.2 Displaying Surface Fish Clearly	2-2
2.3 Suppressing Bottom Tail	2-2
2.3.1 AGC.....	2-2
2.3.2 Pulse length	2-3
2.3.3 2ND AGC.....	2-3
2.4 Suppressing Bottom and Sea Surface Reflections in Shallow Fishing Grounds	2-4
2.5 Rejecting Sonar Interference and Noise.....	2-5
2.5.1 Identifying noise source	2-5
2.5.2 Rejecting noise with the interference rejector	2-5
2.5.3 Rejecting noise with the noise limiter	2-5
2.5.4 Rejecting interference with TX cycle	2-6
2.6 Choosing Beamwidth	2-7
2.6.1 Horizontal beamwidth.....	2-7
2.6.2 Vertical beamwidth.....	2-7
2.7 Deleting Weak Echoes.....	2-7
2.8 Echo Averaging.....	2-7

3. ADVANCED SONAR OPERATION	3-1
3.1 Tracking a Fish School (target lock).....	3-1
3.2 Detecting Fish Schools Aurally	3-3
3.3 The Fish Alarm	3-4
3.4 Measuring Fish School Speed	3-5
3.4.1 Entering a fish mark.....	3-5
3.4.2 Deleting individual fish marks	3-6
3.5 Relocating Fish School for Easy Observation	3-6
3.6 Event Mark, Own Ship Position Mark.....	3-7
3.6.1 Event mark	3-7
3.6.2 Entering an own ship position mark	3-8
3.6.3 Deleting an event mark.....	3-8
3.7 Collectively Deleting Marks.....	3-9
3.8 Function Keys (F1-F4).....	3-10
3.8.1 Operating the function keys	3-10
3.8.2 Programming for fishing ground or target fish	3-10
3.8.3 Programming specific function	3-11
3.8.4 Confirming function key program	3-12
3.9 Suppressing Effects of Pitching and Rolling (Stabilizer)	3-13
4. ECHOSOUNDER MODE	4-1
4.1 Choosing the Range.....	4-1
4.2 Adjusting the Gain	4-2
4.3 Picture Advance Speed.....	4-3
4.4 Measuring Depth	4-3
4.5 Suppressing Interference.....	4-4
4.6 Suppressing Low Level Noise.....	4-4
4.7 Erasing Weak Echoes	4-5
4.8 Other Items on the Sounder Menu.....	4-6
5. MARKS AND DATA	5-1
5.1 Marks and Data on the Normal Display.....	5-1
5.2 Marks and Data on the Echosounder and Audio Displays.....	5-5
6. INTERPRETING THE DISPLAY	6-1
6.1 Bottom Echo.....	6-1
6.2 Fish School.....	6-2
6.3 Sea Surface Reflections	6-3
6.4 Wake	6-3
6.5 False Echo by Sidelobe	6-4
6.6 Noise and Interference	6-4
7. MARKS AND SYSTEM MENUS	7-1
7.1 MARKS Menu.....	7-1
7.2 SYSTEM Menu.....	7-3

8. MAINTENANCE, TROUBLESHOOTING	8-1
8.1 General Maintenance.....	8-1
8.2 Cleaning the Equipment.....	8-1
8.3 Hull Unit Maintenance	8-2
8.3.1 Lubrication points, zinc plate	8-2
8.3.2 Manually raising the transducer	8-3
8.4 Fuse Replacement.....	8-4
8.5 Fan Replacement.....	8-4
8.6 Troubleshooting	8-5
8.7 Error Messages.....	8-6
8.8 Diagnostic Tests.....	8-7
8.8.1 Choosing a diagnostic test	8-7
8.8.2 Description of diagnostic tests.....	8-8
MENU TREE	AP-1
SPECIFICATIONS.....	SP-1
INDEX	IN-1

FOREWORD

A Word to the Owner of the CSH-5L/CSH-8L

Congratulations on your choice of the FURUNO CSH-5L/CSH-8L Color Scanning Sonar.

For over 50 years FURUNO Electric Company has enjoyed an enviable reputation for innovative and dependable marine electronics equipment. This dedication to excellence is furthered by our extensive global network of agents and dealers.

Your scanning sonar is designed and constructed to meet the rigorous demands of the marine environment. However, no machine can perform its intended function unless installed, operated and maintained properly. Please carefully read and follow the recommended procedures for operation and maintenance.

We would appreciate hearing from you, the end-user, about whether we are achieving our purposes.

Thank you for considering and purchasing FURUNO equipment.

Features

The FURUNO CSH-5L and CSH-8L Color Scanning Sonars are full-circle electronic scanning sonars that detect and instantaneously display fish schools and underwater conditions in 16 colors.

Some of the prominent features of the CSH-5L and CSH-8L are as follows:

- Vivid 16-color display assists in recognition of bottom, and concentration and distribution of fish schools.
- Transducer frequency available in 55 kHz or 68 kHz for the CSH-5L and 85 kHz or 107 kHz for the CSH-8L.
- Various fishing and navigation data (appropriate sensors required) keep operator abreast of fishing and navigation conditions.
- High power MOS FET transmitter ensures reliable operation under any condition.
- Remote controller optionally available.
- Four user-programmable function keys for quick set up of equipment according to fishing conditions or specific function.
- Target lock feature tracks fish school.

SYSTEM CONFIGURATION

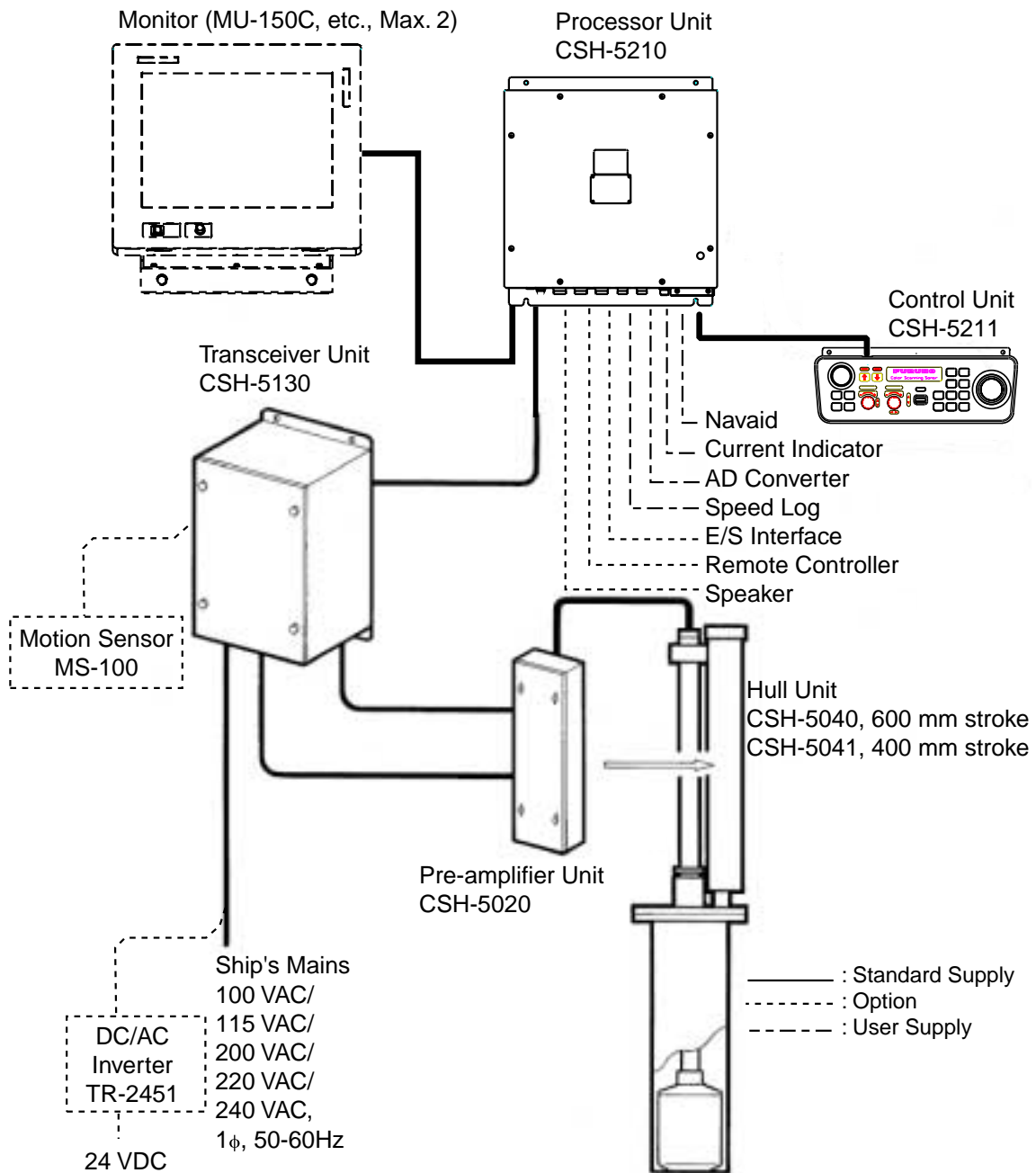

System configuration of CSH-5L

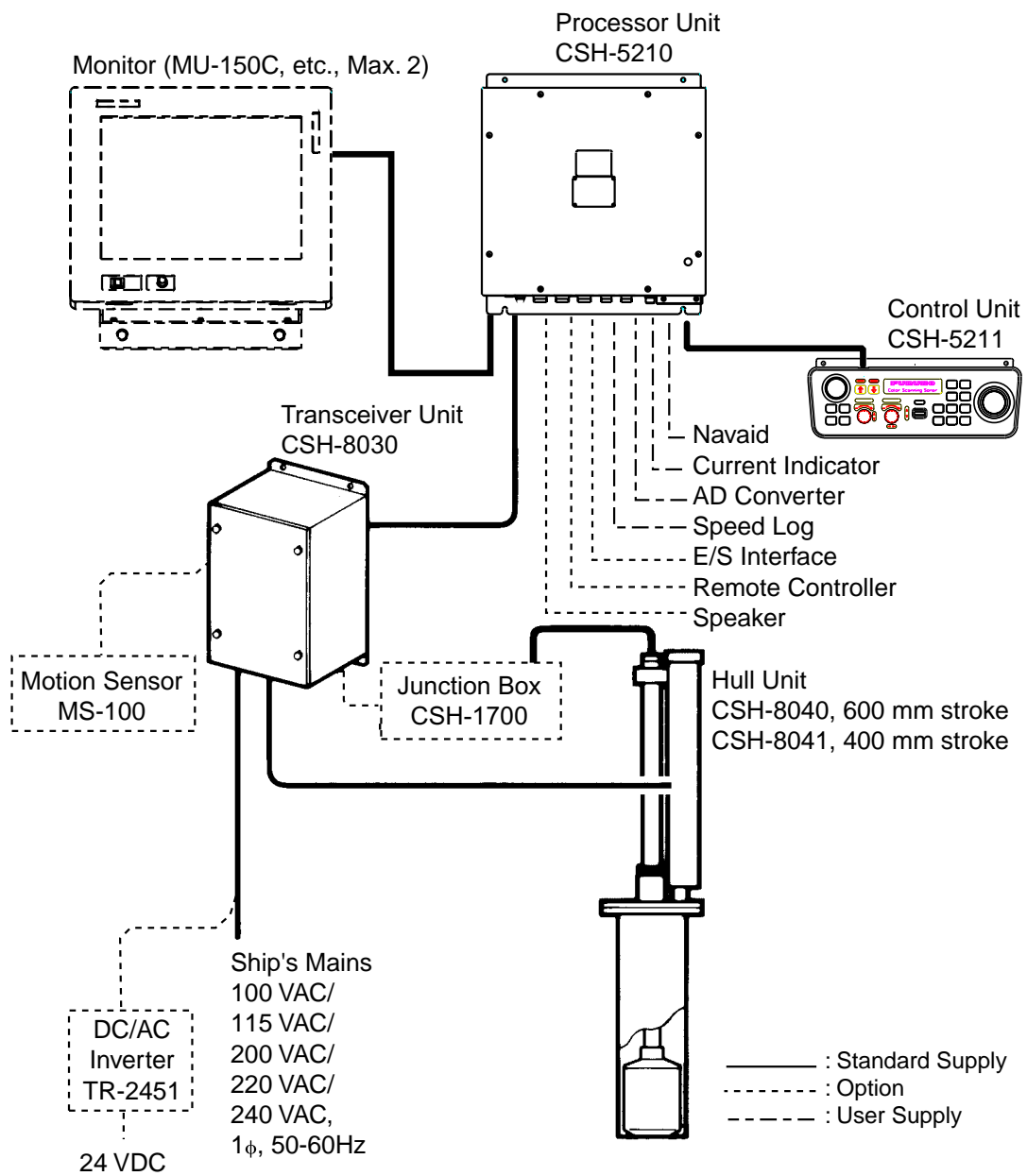

System configuration of CSH-8L

1. OPERATIONAL OVERVIEW

1.1 Control Unit

All operations are carried out from the control unit. All controls quickly respond to the operator's command and the associated reaction can be seen on the screen almost immediately.

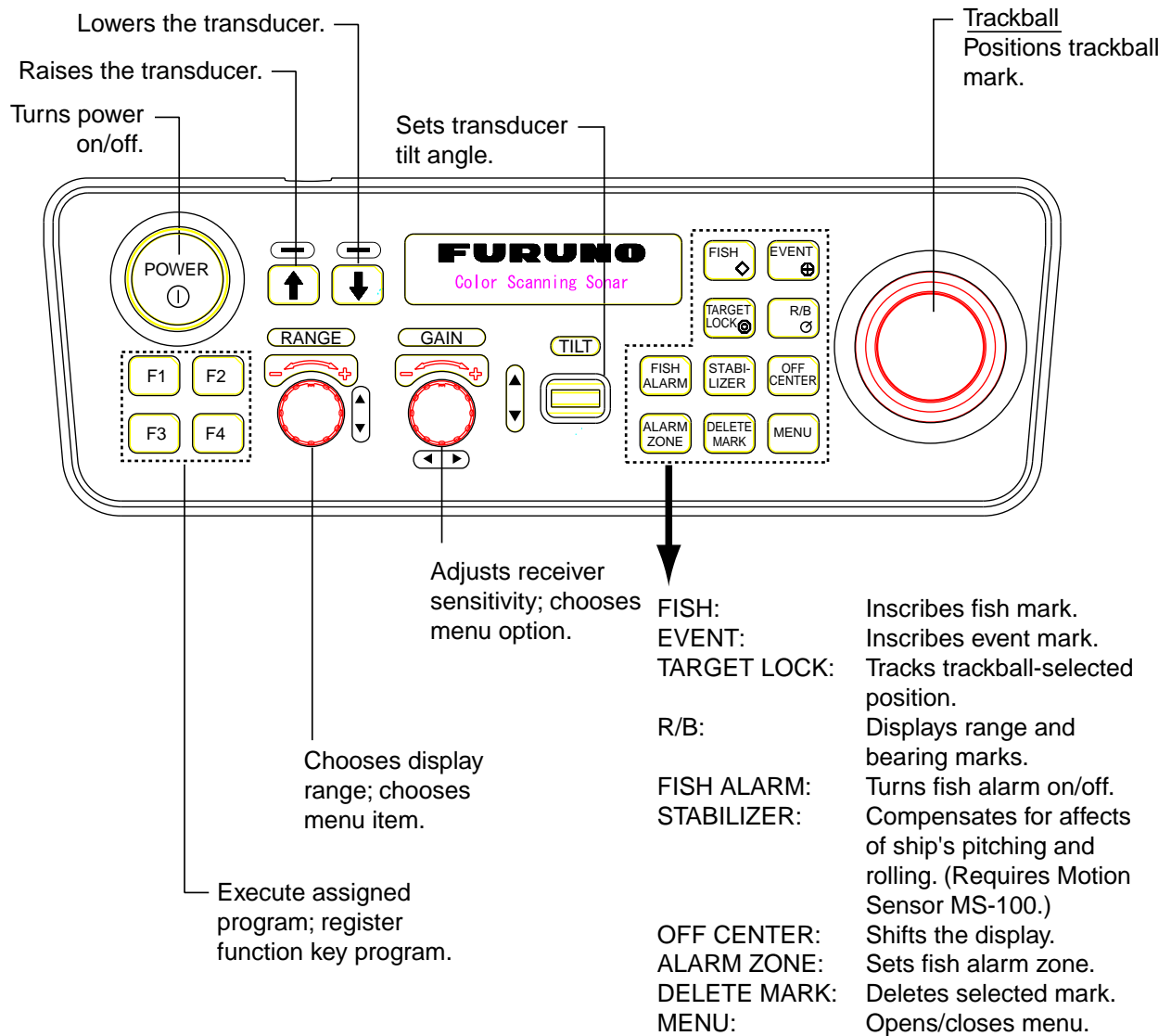

Control unit

1.2 Remote Controller (option)

The remote controller provides armchair control of the tilt, range, gain and menu functions.

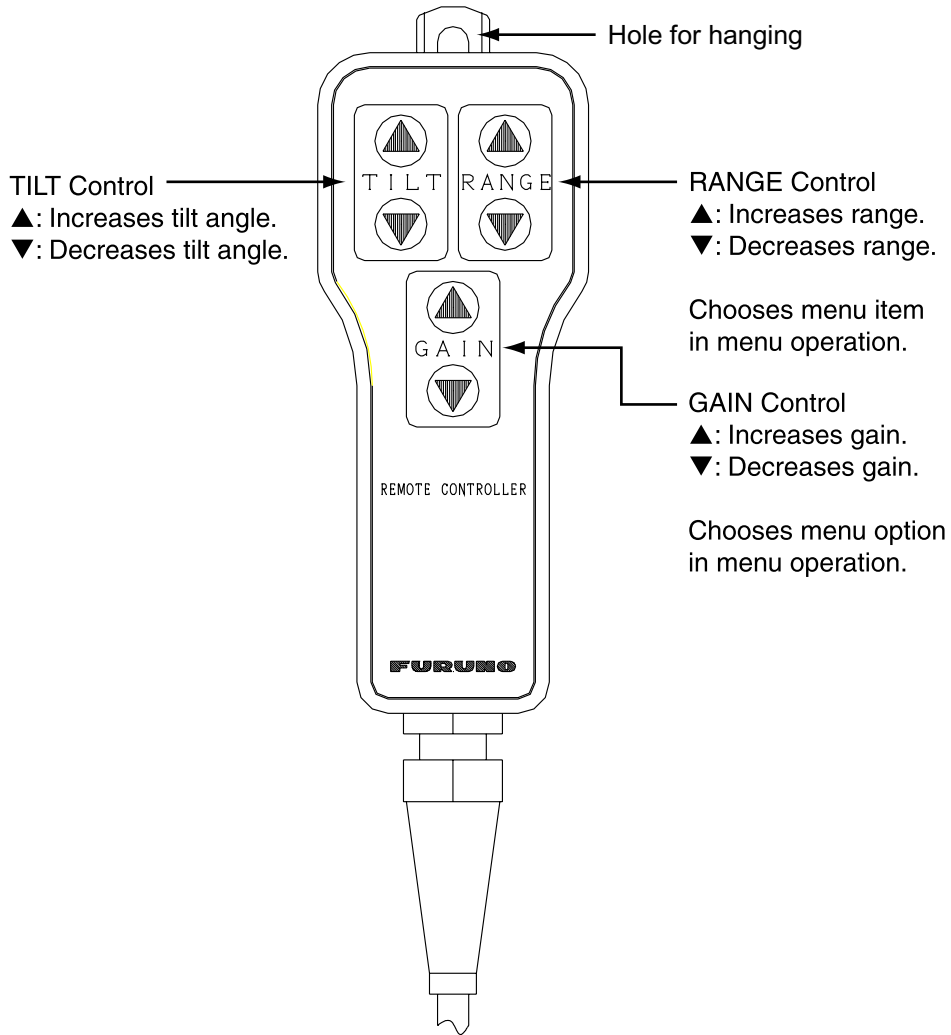

Remote controller

1.3 Basic Operating Procedure

1.3.1 Turning on the power

1. Press the POWER switch on the control unit to turn on the power.
2. Turn on the monitor (user supply).
The system initiates the START UP test to check itself for proper operation. The results are shown as OK or NG (No Good). For any NG, contact your dealer for advice. After the test is completed, the last-used display appears.

START UP TEST		
MAIN-0	1050729-XX.XX	F F
	ROM	= OK
	RAM	= OK
	VRAM	= OK
EEPROM (P.W)		= OK
TRX	1050742-XX.XX	1050733-XX.XX
	ROM	= OK
	RAM	= OK
KEY-0	1050730-XX.XX	F
	ROM	= OK
	RAM	= OK

XX.XX = Program Version No.

Self test screen at start up (example: CSH-5L, 55 kHz transducer)

Note: The example screens shown in this manual may not match the screens you see on your display. The screen you see depends on your system configuration and equipment settings.

1.3.2 Lowering the transducer

Set ship's speed under 16 knots and then press the [↓] switch. The lamp above the switch flashes, and lights when the transducer is fully lowered. If you press the [↓] switch when the speed is over 16 knots and the speed warning is turned on in the SYSTEM menu, the message "Max allowable speed for extended transducer is 16 kt. Max allowable speed during raising lowering transducer is 16 kt." and the audio alarm sounds. Press the [R/B] key to silence the audio alarm.

 CAUTION
<p>Do not exceed 18 knots with the transducer lowered; 16 knots when lowering the transducer.</p> <p>The transducer may become damaged.</p>

Note: The audio alarm may be set to sound and a message displayed when the ship's speed goes higher than maximum allowable speed. For further details, see SPEED MESSAGE on page 7-4.

1.3.3 Transmitting

TRANSMISSION in the SONAR menu is off in the default setting. If it is has been set to ON, the procedure below is not necessary. When the transducer is lowered, transmission starts and when it is raised transmission is stopped.

1. Press the [MENU] key to open the menu.
2. Use the [RANGE] control to choose [MENU MODE] at the top of the screen.
3. Use the [GAIN] control to choose SONAR.

** SONAR MENU **		(RANGE CTRL: U/D, GAIN CTRL: L/R)			
[MENU MODE]	: SONAR	SOUNDER	MARKS	SYSTEM	
DISPLAY MODE	: COMBI-1	NORM	COMBI-2		
TX OUTPUT	: 8				
PULSE LENGTH	: 8				
TX CYCLE	: 10				
TVG NEAR	: 6				
TVG FAR	: 7				
AGC	: 2				
2ND AGC	: 1				
NOISE LIMITER	: 3				
COLOR CURVE	: 1	2	3	4	
COLOR RESPONSE	: 1	2	3	4	
DELETE COLOR	: 0				
ECHO AVERAGE	: 1				
INT REJECT	: 1				
HOR BEAMWIDTH	: WIDE	NARROW			
VER BEAMWIDTH	: WIDE	NARROW			
COLOR	: 1	2	3	4	
ERASE MARKS	: TRACK	SHIP	EVENT	FISH	
ALARM LEVEL	: 9				
AUTO TRAIN	: ON	OFF			
TRAIN SECTOR	: ±10°	±20°	±40°	±60°	
AUTO TILT	: ON	OFF			
TILT ANGLE	: ±2-10°	±4-14°	±6-20°	±10-26°	
TRANSMISSION	: ON	OFF			
AUDIO VOLUME	: 10				
ASSIGN SETTING	: F1 KEY	F2 KEY	F3 KEY	F4 KEY	
ASSIGN MENU	: EXECUTE				
PRESS [MENU] KEY TO EXIT					

SONAR menu

4. Use the [RANGE] control to choose TRANSMISSION.
5. Use the [GAIN] control to choose ON. The sonar starts transmitting and the sonar picture appears.
6. Press the [MENU] key to close the menu.

To turn off transmission, choose OFF at step 5. "TX OFF" appears at the top right corner of the sonar display when the transmitter is turned off.

1.3.4 Adjusting backlighting of control unit

1. Press the [MENU] key to open the menu.
2. Use the [RANGE] control to choose [MENU MODE] at the top of the screen.
3. Use the [GAIN] control to choose SYSTEM.

** SYSTEM MENU **		(RANGE CTRL: U/D, GAIN CTRL: L/R)			
[MENU MODE]	:	SONAR	SOUNDER	MARKS	SYSTEM
DIMMER	:	10			
DISP SELECT	:	TEMP	CURRENT		
HEADING ADJ	:	0°			
AUTO RETRACT	:	OFF	(OFF, 5-16kt)		
SPEED MESSAGE	:	ON	OFF		
EXT KP SYNC	:	OFF	ON		
AUTO TRAIN SPD	:	LOW	HIGH		
AUTO TILT SPD	:	LOW	HIGH		
UNIT	:	METERS	FEET	FATHOMS	PA/BRA
SHIP'S SPD/BR	:	LOG/GYRO	CURRENT	NAV DATA	GYRO+NAV
LOG PULSE	:	200	400		
PORT1 BAUDRATE	:	19200	9600	4800	2400
PORT1 FORMAT	:	NMEA	CIF		
PORT2 BAUDRATE	:	19200	9600	4800	2400
PORT2 FORMAT	:	NMEA	CIF		
NAV DATA	:	GPS	LC	DR	ALL
COMBI SCALE	:	RIGHT	LEFT		
SUB TEXT INDI	:	OFF	ON		
LANGUAGE	:	ENGLISH	(JAPANESE)	ESPAÑOL	DANSK
		NEDERLND	FRANCAIS	ITALIANO	(KOREAN)
		NORSK			
TEST	:	SINGLE	CONTI	PANEL	COLOR
	:	PATTERN	SIO	ECHO-1	ECHO-2
	:	ECHO-3	ECHO-4		
SET TO DEFAULT	:	EXECUTE			
PRESS [MENU] KEY TO EXIT					

System menu

4. Use the [RANGE] control to choose DIMMER.
5. Operate the [GAIN] control adjust the dimmer. The setting range is 0-10. Adjust the control clockwise to increase backlighting; counterclockwise to decrease it.
6. Press the [MENU] key to close the menu.

1.3.5 Choosing a display mode

Three display modes are available: NORMAL, COMBI-1 and COMBI-2. To choose the display mode, do the following:

1. Press the [MENU] key to open the menu. The last-used menu is displayed.
2. Use the [RANGE] control to choose [MENU MODE] at the top of the screen.
3. Use the [GAIN] key to choose SONAR.
4. Use the [RANGE] control to choose DISPLAY MODE.
5. Use the [GAIN] control to choose desired mode among COMBI-1, NORM and COMBI-2.
6. Press the [MENU] key to close the menu.

Mode description

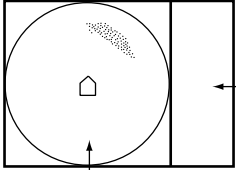
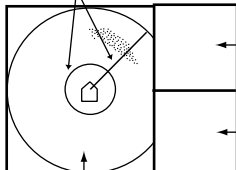
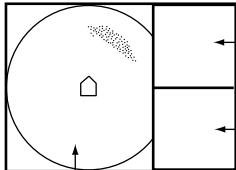
Mode	Description	Display
NORM (Sonar display)	This mode is useful for detecting and tracking fish schools. Navigation data can be displayed in the text window, with connection of appropriate sensors.	 <p style="text-align: center;">Sonar display</p>
COMBI-1 (Sonar + Audio)	<p>Sonar picture appears on the left and the audio display at the lower right side of the screen. This mode is useful analyzing echoes in a desired area.</p> <p>To activate the COMBI-1 mode, do the following:</p> <ol style="list-style-type: none"> 1. Choose the COMBI-1 mode. 2. Use the trackball to place the trackball mark (+) on the bearing desired. 3. Press the [R/B] key. The range and bearing marks are inscribed on the sonar picture, and the signal along the bearing mark appears in the audio display. 	<p style="text-align: center;">Range and bearing marks</p>  <p style="text-align: center;">Sonar display</p>
COMBI-2 (Sonar + echosounder)	The sonar picture appears on the left and the signal fed from the echosounder at the lower right side of the screen. This mode is suitable for judging fish school concentration.	 <p style="text-align: center;">Sonar display</p>

Normal mode display (sonar display)

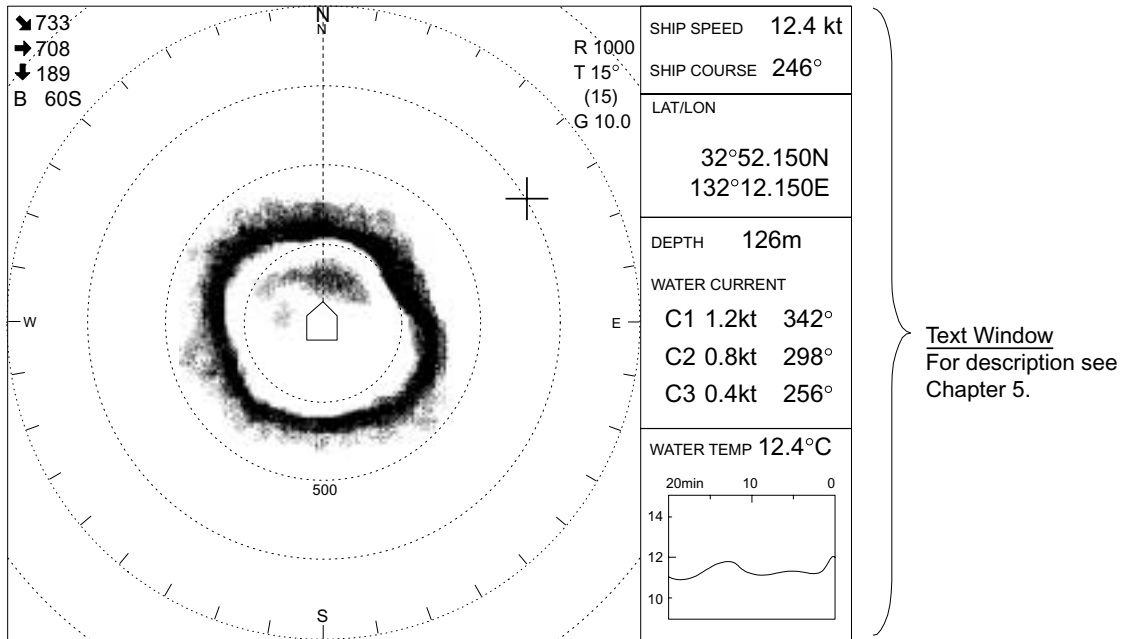

Sonar display

COMBI-1 display (sonar display + audio display)

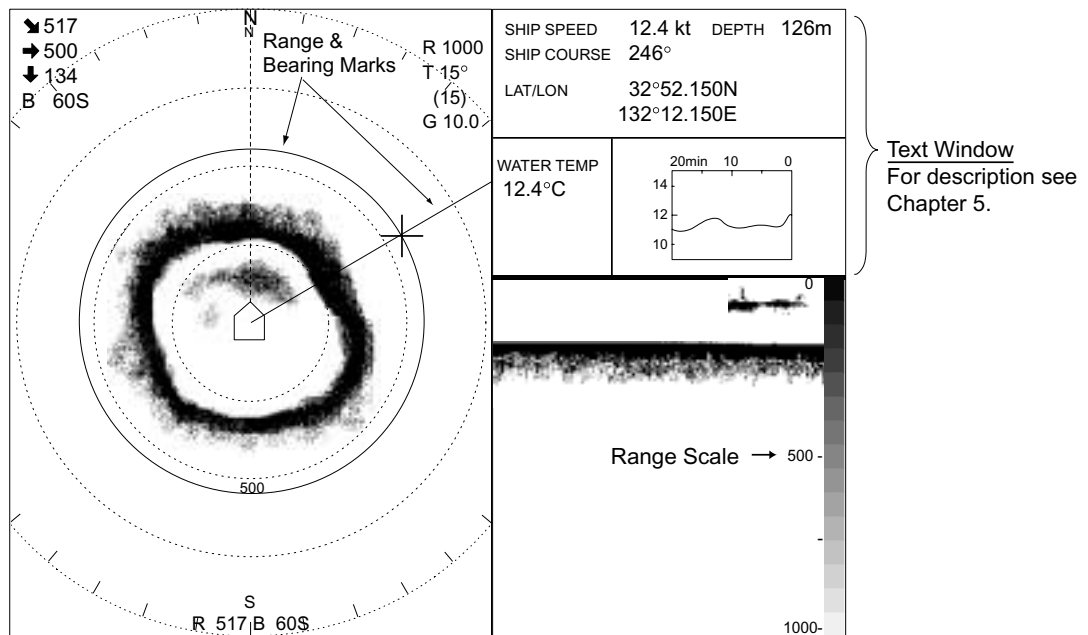

Text Window
For description see Chapter 5.

Range and bearing marks data

COMBI-1 display (sonar display + audio display)

COMBI-2 display (sonar display + echosounder display)

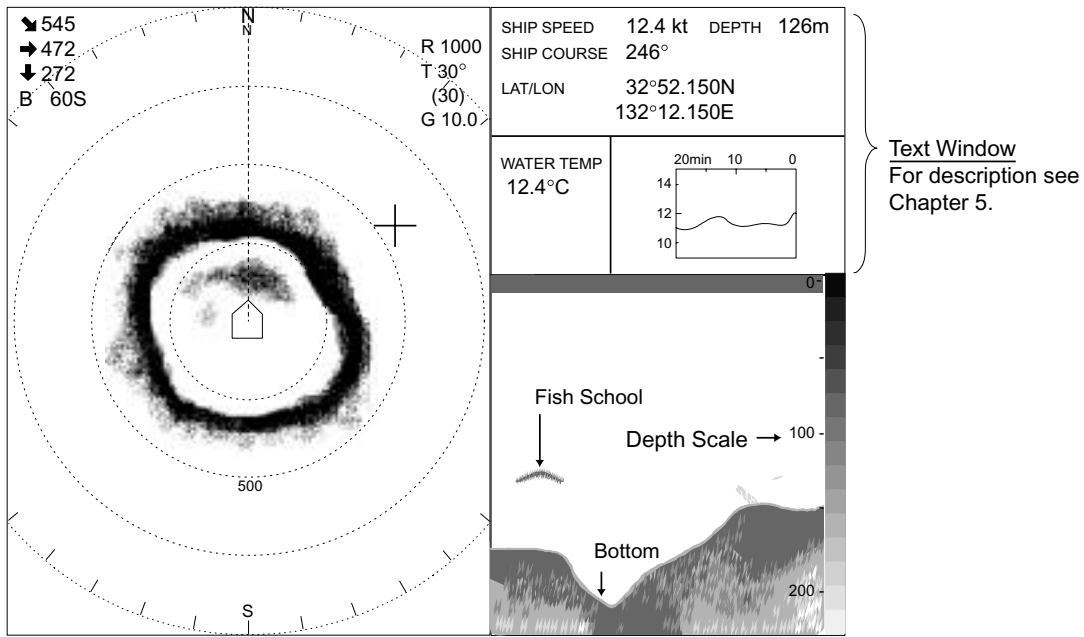

COMBI-2 display (sonar display + echosounder display)

1.3.6 Choosing the display range

The [RANGE] control chooses a display range. Each time the range is changed the newly selected range appears in large characters for five seconds at the top of the sonar display. The current range is always displayed at the top right corner of the sonar display. The ranges (in meters) available are 50, 85, 100, 150, 200, 250, 300, 350, 400, 450, 500, 600, 800, 1000, 1200 and 1600.

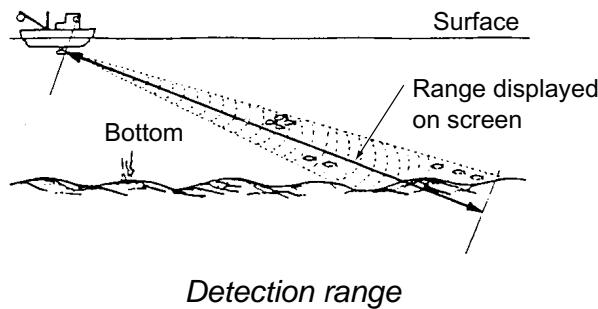

1.3.7 Adjusting the gain

The [GAIN] control adjusts receiver sensitivity. It should be adjusted to see fish echoes clearly with minimal noise on the screen. Too high a setting not only causes excessive noise on the screen and makes it difficult to discriminate wanted fish echoes but also causes bottom echoes to be painted in strong colors, resulting that the echoes from bottom fish are masked by bottom reflections. A setting between 3 and 7 is usually suitable. Each time the control is operated the newly selected range appears in large characters for five seconds at the top of the sonar display. The current range is always displayed at the top right corner of the sonar display.

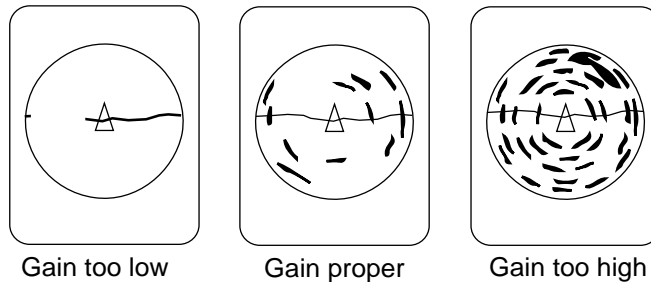

Examples of proper and improper gain

1.3.8 Retracting the transducer, turning off the power

1. Set speed under 16 knots and then press the [↑] switch to retract the transducer. The lamp above the switch blinks while the transducer is being retracted. Transmission is stopped automatically. If you press the [↑] switch when the speed is over 16 knots and the speed warning is turned on in the SYSTEM menu, the message "Max allowable speed for extended transducer is 16 kt. Max allowable speed during raising lowering transducer is 16 kt." and the audio alarm sounds. Press the [R/B] key to silence the audio alarm.
2. When the lamp above the [↑] switch lights, meaning the transducer is completely retracted, press the [POWER] switch on the control unit to turn off the power.
3. Turn off the monitor.

Note 1: The transducer is automatically retracted into the tank whenever the power switch is turned off. However, for safety purposes, make it a habit to retract the transducer before turning off the power.

Note 2: The equipment can be set to automatically retract the transducer when the ship exceeds the operator-set speed. (Speed data required.) The transducer may be retracted at a different speed than set if the speed data is different from actual speed. In all cases, reduce the speed below 16 knots and then retract the transducer.

1.4 Setting the Tilt Angle

The tilt angle shows the direction to which the sound wave is emitted. When the sound wave is emitted horizontally, it is said to be zero (0) degrees and when emitted vertically, 90 degrees.

To set a tilt angle, operate the TILT lever for the desired angle while watching the tilt angle indication at the top right corner of the sonar display. Each time the lever is operated the newly selected tilt angle is displayed in large characters for five seconds at the top of the sonar display. The tilt angle can be set in one-degree steps within the range of 0 to 55 degrees.

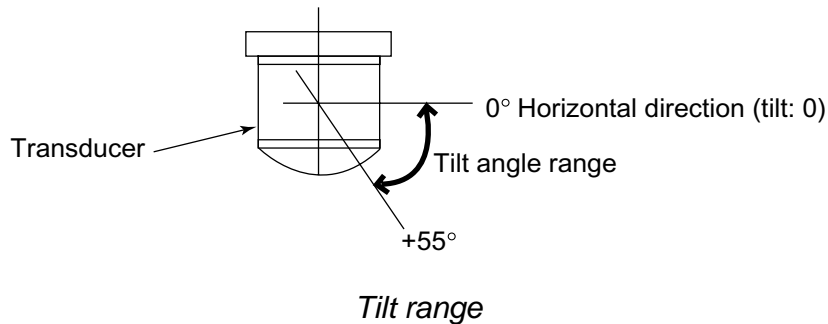

1.4.1 Automatic tilt on/off

The automatic tilt feature automatically tilts the transducer within the tilt range selected on the menu. This feature is useful for finding fish school center.

Automatic tilt becomes inoperative when the target lock feature is made active. Disable the target lock feature to resume automatic tilt.

1. Press the [MENU] key to open the menu.
2. Operate the [RANGE] control to choose [MENU MODE] at the top of the screen.
3. Operate the [GAIN] control to choose SONAR.
4. Operate the [RANGE] control to choose AUTO TILT.
5. Operate the [GAIN] control to choose ON.
6. Operate the [RANGE] control to choose TILT ANGLE.
7. Use the [GAIN] control to choose a tilt range among $\pm 2-10^\circ$, $\pm 4-14^\circ$, $\pm 6-20^\circ$, and $\pm 10-26^\circ$. See the table on the next page for range and tilt angle.
8. Press the [MENU] key to close the menu. When auto tilt is on, auto tilting begins with the range selected (at step 7), centered on the tilt angle set with the TILT lever.

To turn off automatic tilt, choose OFF at step 5. Note that automatic tilt range varies with the range in use.

Range and tilt angle

Range (m)	±2-10°	±4-14°	±6-20°	±10-26°
50, 85, 100, 150, 200, 250, 300, 350	±10°	±14°	±20°	±26°
400, 450, 500	±8°	±12°	±16°	±20°
600, 800	±6°	±10°	±14°	±20°
1000, 1200, 1600	±2°	±4°	±6°	±10°

For example, when the [RANGE] control, [TILT] lever and automatic tilt are set to 1000 m, 8° and ±2-10° respectively, the tilt angle changes at each transmission as follows:

8° → 10° → 8° → 6° → 8° → ...

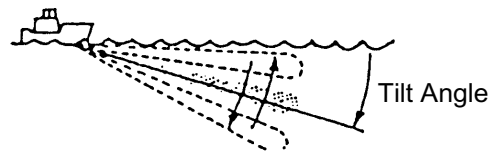

Auto tilt concept

1.4.2 Bottom and tilt angle

Finding the proper tilt angle is of utmost importance when searching for fish, especially in coastal water fishing, where the depth of the fishing ground is from 50-100 m. In this type of fishing ground it is imperative that the bottom echo be always displayed to properly distinguish between fish and the bottom. When selecting a tilt angle, keep the following points in mind.

Case 1: Tilt angle 30 to 40 degrees

This tilt angle uses the full beamwidth to receive echoes, thus the entire bottom echo is displayed. Fish echoes may be hidden in the bottom echo.

Case 2: Tilt angle 10 to 20 degrees

This tilt angle receives bottom echoes within the bottom half of the beam. Fish echoes astern of the bottom echo are displayed.

Case 3: Tilt angle 0 to 5 degrees

This tilt angle may or may not display returning echoes. Fish echoes near the bottom echo are displayed.

1.4.3 How to discriminate fish echoes from the bottom

The following figure illustrates how two fish schools (a) and (b) are displayed on screen using three different tilt angles.

- Case 1: Tilt angle 30 to 40 degrees
Fish school is obscured by the bottom echo.
- Case 2: Tilt angle 10 to 20 degrees
Fish school is located above the bottom echo (midwater).
- Case 3: Tilt angle 0 to 5 degrees
Fish school is located close to the bottom echo.

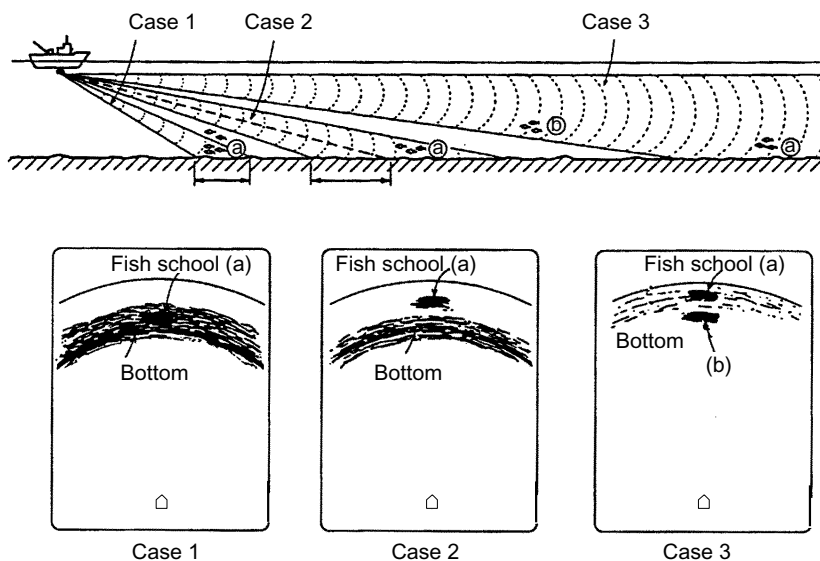

How to discriminate fish echoes from bottom

1.4.4 Points to consider

- As a general rule of thumb, a vertically distributed fish school is a better sonar target than a horizontally one, since it reflects the transmitted pulse back toward to the source.
- In case 3, both fish schools (a) and (b) are presented. Generally speaking, however, midwater fish schools tend to be larger than bottom fish schools and they are often displayed near the bottom on the sonar screen.
- Detection of bottom fish is difficult if they are not distributed vertically.

1.4.5 Tilt angle for surface fish

Sound emitted from the sonar transducer forms a circle-shaped beam with a width of approximately 15° (-6dB in the vertical direction). The tilt angle is indicated by the angle between the center line of the beam and the horizontal plane. Then, if the tilt angle is set to 0 degrees, the center line is parallel with the sea surface and one half of the emitted sound goes upward toward the sea surface.

This causes a half of the emitted sound to be reflected back toward the transducer and displayed on the screen as sea surface reflections. When the sea is calm, since the sound is reflected just like a light hitting a mirror at a narrow incident angle, it propagates away and the sea surface reflections become negligible.

However if the sea is not calm enough, they will become dominant and will interfere with observation of wanted echoes. To minimize these sea surface reflections and to search surface fish schools effectively, the tilt angle is usually set to 5-6 degrees so that the upper portion of the beam becomes almost parallel with the sea surface. When the sea is rough, it is often set to a little larger angle.

* 15° for CSH-5L, 13° for CSH-8L

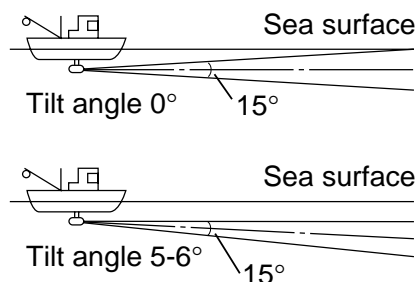

Tilt angle and surface fish (example: CSH-5L)

1.4.6 Suitable tilt angle

The table below shows the estimated detection range for tilt angles of 0, 5, 10 and 15 degrees. Refer to the table to find suitable tilt angle from depth and detection range.

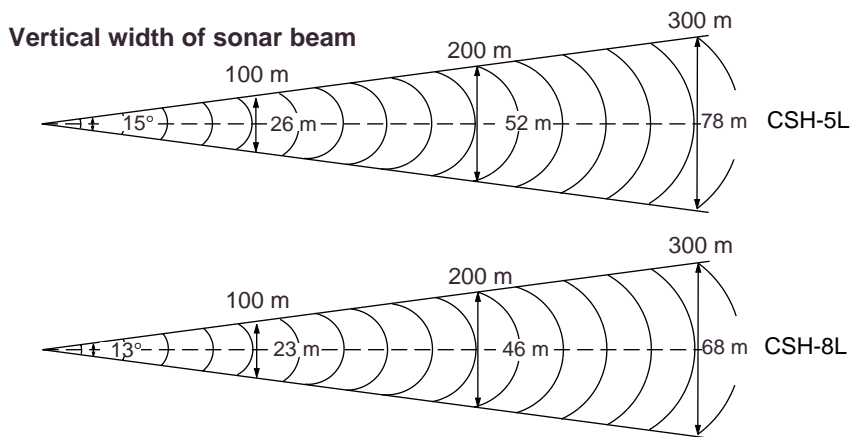
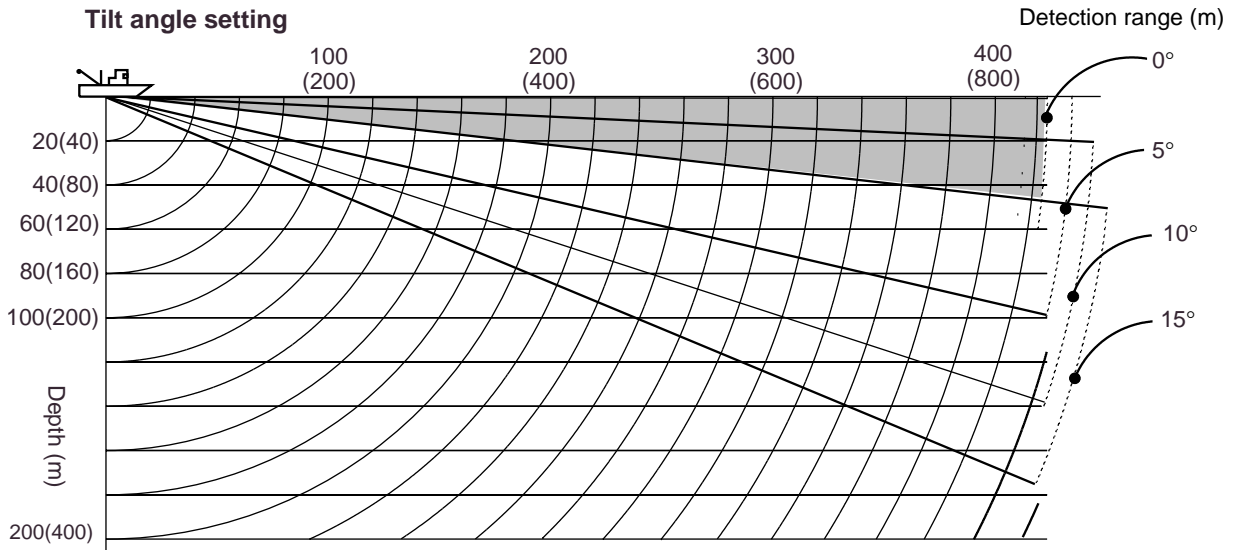

Depth, detection range and tilt angle

1.5 Finding Range and Bearing to a Target

Operate the trackball to place the trackball mark on the target you want to measure the range and bearing. The slant range, horizontal range, bearing and depth to the target appear at the upper left corner of the sonar display.

TRACKBALL DATA

- ↘ Slant range from own ship to trackball mark
- Horizontal range from own ship to trackball mark
- ↓ Depth to trackball mark
- B Relative from own ship to trackball mark*

* = Relative bearing format may be selected with OTHER MARKS on the MARKS menu.

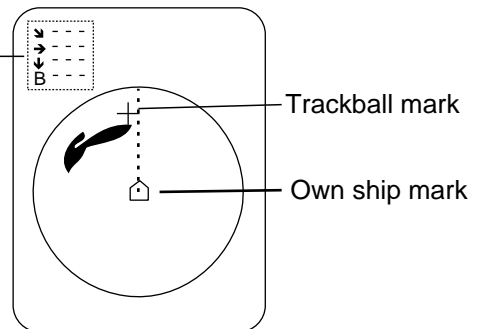

Location of trackball data

1.6 Sonar Menu Overview

This equipment has four menus: sonar menu, sounder menu, marks menu and system menu. Of the four menus, the SONAR menu is the one you will use most often.

Note that the gain and range cannot be adjusted while the menu is displayed.

1.6.1 Operating procedure

1. Press the [MENU] key. The last-used menu appears.
2. Use the [RANGE] control to choose [MENU MODE] at the top of the screen.
3. Use the [GAIN] control to choose SONAR to display the SONAR menu.

** SONAR MENU **		(RANGE CTRL: U/D, GAIN CTRL: L/R)			
[MENU MODE]	: SONAR	SOUNDER	MARKS	SYSTEM	
DISPLAY MODE	: COMBI-1	NORM	COMBI-2		
TX OUTPUT	: 8				
PULSE LENGTH	: 8				
TX CYCLE	: 10				
TVG NEAR	: 6				
TVG FAR	: 7				
AGC	: 2				
2ND AGC	: 1				
NOISE LIMITER	: 3				
COLOR CURVE	: 1	2	3	4	
COLOR RESPONSE	: 1	2	3	4	
DELETE COLOR	: 0				
ECHO AVERAGE	: 1				
INT REJECT	: 1				
HOR BEAMWIDTH	: WIDE	NARROW			
VER BEAMWIDTH	: WIDE	NARROW			
COLOR	: 1	2	3	4	
ERASE MARKS	: TRACK	SHIP	EVENT	FISH	
ALARM LEVEL	: 9				
AUTO TRAIN	: ON	OFF			
TRAIN SECTOR	: ±10°	±20°	±40°	±60°	
AUTO TILT	: ON	OFF			
TILT ANGLE	: ±2-10°	±4-14°	±6-20°	±10-26°	
TRANSMISSION	: ON	OFF			
AUDIO VOLUME	: 10				
ASSIGN SETTING	: F1 KEY	F2 KEY	F3 KEY	F4 KEY	
ASSIGN MENU	: EXECUTE				
PRESS [MENU] KEY TO EXIT					

Sonar menu

1. OPERATIONAL OVERVIEW

4. Use the [RANGE] control to choose a menu item. The selected item is highlighted.

Note: Items displayed in red are locked to prevent accidental change of setting. When any of those items are selected the display shown below appears, to ask you if you are sure to change the setting. To change the setting, use the [GAIN] control to choose YES and then press the [EVENT] key. The items colored in red turn green to show that they are available for adjustment.

SELECTED MENU IS LOCKED
ARE YOU SURE TO CHANGE? NO YES
PRESS [EVENT] KEY TO EXECUTE

5. Use the [GAIN] control to choose the option desired.
6. To close the menu, press the [MENU] key.

1.6.3 Sonar menu description

Description of sonar menu

Item	Description	Ref. page
DISPLAY MODE	Chooses the display mode among, COMBI-1 (NORM + Audio), NORM (Sonar) and COMBI-2 (NORM + Echosounder).	1-6
TX OUTPUT	Adjusts transmitter power.	2-4
PULSE LENGTH	Chooses pulse length.	2-3
TX CYCLE	Removes interference caused by other sonars operating nearby.	2-6
TVG NEAR	Adjusts receiving gain within 300 m.	2-1
TVG FAR	Adjusts receiver gain beyond 300 m.	2-1
AGC	Automatically reduces the receiver gain only against strong echoes such as the bottom or a large fish school, to suppress bottom tail.	2-2
2ND AGC	Suppresses bottom echo.	2-3
NOISE LIMITER	Suppresses unwanted reflections caused by sediments in water, plankton or ship's noise.	2-5
COLOR CURVE	Adjusts echo presentation color curve against strong reflections. In setting "1," for example, weak to strong signals are averaged and displayed to obtain a balanced picture. The larger the setting the better the resolution on weak signals.	—

Description of sonar menu (con't from previous page)

Item	Description	Ref. page
COLOR RESPONSE	Adjusts color level against strong reflections. The higher the setting, the more the red color is displayed and weak level colors are displayed as is, thereby giving the appearance that the gain has been raised.	—
DELETE COLOR	Erases desired echo level from the display.	2-7
ECHO AVERAGE	Specifies how long to leave afterglow on the screen.	2-7
INT REJECT	Rejects random noise and sea surface reflections in rough sea conditions.	2-5
HOR BEAMWIDTH	Sets horizontal beamwidth for wide or narrow.	2-7
VER BEAMWIDTH	Sets vertical beamwidth for wide or narrow.	2-7
COLOR	Chooses display colors for the sonar and audio displays, among four choices. Choose a display color to match your environment or fishing objective.	—
ERASE MARKS	Chooses the mark type to erase collectively, from track, own ship, event and fish. For track, 10% of the oldest track is erased.	3-9
ALARM LEVEL	Sets echo strength level which triggers the fish alarm. The lower the setting the weaker the echo which triggers the alarm.	3-4
AUTO TRAIN	Turns automatic transducer training on or off.	3-3
TRAIN SECTOR	Chooses train sector in automatic training.	3-3
AUTO TILT	Turns automatic tilt on or off.	1-10
TILT ANGLE	Sets automatic tilt range.	1-10
TRANSMISSION	Turns transmission on or off.	1-4
AUDIO VOLUME	Sets audio volume of loudspeaker.	3-3
ASSIGN SETTING	Chooses function key to program.	3-10
ASSIGN MENU	Displays programs assigned to function keys.	3-12

1. OPERATIONAL OVERVIEW

(This page intentionally left blank.)

2. FINE TUNING THE SONAR PICTURE

2.1 Eliminating Unwanted Echoes

Echoes from targets such as bottom and fish return to the transducer in order of distance to them, and when we compare their intensities at the transducer face, those from nearer targets are generally stronger when their reflecting properties are nearly equal. The sonar operator will be quite inconvenienced if these echoes are directly displayed on the screen, since the actual size of the target cannot be judged from the size of echoes displayed on the screen. To overcome this inconvenience, the TVG function is incorporated. It compensates for propagation loss of sound in water; amplification of echoes on short range is suppressed and gradually increased as range increases so that similar targets are displayed in the similar intensities irrespective of the ranges to them.

The CSH-5L/CSH-8L incorporates two TVG functions, NEAR and FAR, and they mainly compensate for propagation loss on short and long ranges respectively, centered at the ranges shown below.

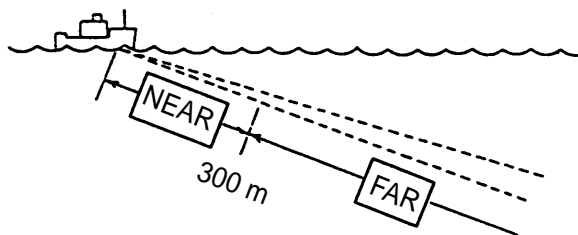

How TVG works

The TVG is also used to suppress unwanted echoes and noise which appear in a certain range area on the screen such as sea surface reflections and cruising noise. To obtain the proper TVG setting, follow the procedure below.

1. Press the MENU key.
2. Use the [RANGE] control to choose [MENU MODE] at the top of the screen.
3. Use the [GAIN] control to choose SONAR to display the SONAR menu.
4. Use the [RANGE] control to choose TVG NEAR.
5. Use the [GAIN] control to adjust gain.
6. Use the [RANGE] control to choose TVG FAR.
7. Use the [GAIN] control to adjust TVG FAR (setting range: 0-10).
8. When sea surface reflections or plankton layers disturb the picture, adjust TVG NEAR to eliminate them. They will be eliminated by decreasing the setting by "1" or "2."

2. FINE TUNING THE SONAR PICTURE

8. On a long range, locate a fish school which is approaching own ship. Note that the tilt should be kept adjusted so that the fish school is always placed in the center of the sonar beam, i.e., so that the fish school is displayed in strongest colors possible. Check that the fish echo is displayed in the same color while it approaches. If the color changes suddenly to weaker colors as the fish echo enters FAR and NEAR areas, the TVG is improperly set. Adjust the TVG to correct it. If this again produces sea surface reflections and noise, try to remove them with the AGC and noise limiter as described later on.
9. Press the [MENU] key to close the menu.

2.2 Displaying Surface Fish Clearly

When you are searching for surface fish with the tilt set to a narrow angle, sea surface reflections may disturb or mask wanted fish echoes. In this case, in addition to the TVG adjustment described earlier, adjust AGC on the SONAR menu. Normally set it between "0" and "3."

2.3 Suppressing Bottom Tail

As noted earlier, fish schools (echoes) located near the bottom are sometimes difficult to detect because you have to discriminate them from the bottom reflections. AGC, PULSE LENGTH and 2ND AGC in the SONAR menu, if used properly, decrease the tail of bottom reflections, making it easier to discriminate bottom fish.

2.3.1 AGC

The AGC functions to automatically reduce the receiver gain only against strong echoes such as the bottom or a large fish school. Since weak echoes remain unaffected, a small fish school becomes easier to detect. Adjust the AGC so it works only on bottom reflections.

1. Press the MENU key.
2. Use the [RANGE] control to choose [MENU MODE] at the top of the screen.
3. Use the [GAIN] control to choose SONAR to display the SONAR menu.
4. Use the [RANGE] control to choose AGC.
5. Use the [GAIN] control to set AGC value. The setting range is 0-10 and the higher the setting the stronger the AGC effect.
6. Press the [MENU] key to close the menu.

2.3.2 Pulse length

The pulse length control determines the length of the transmission pulse emitted into the water. While a longer pulse is advantageous for long-range sounding, it has the disadvantage of being poor in discrimination of targets, i.e., ability to separate several closely located targets. When searching bottom fish, therefore, it is useful to shorten the pulselength in order to separate fish echoes from bottom reflections. For search of surface and midwater fish in which bottom reflections are not so strong, the longest pulse length "10" should be used.

1. Press the MENU key.
2. Use the [RANGE] control to choose [MENU MODE] at the top of the screen.
3. Use the [GAIN] control to choose SONAR to display the SONAR menu.
4. Use the [RANGE] control to choose PULSE LENGTH.
5. Use the [GAIN] control to set pulse length. The setting range is 0-10 and the higher the setting the longer the pulse length.
6. Press the [MENU] key to close the menu.

2.3.3 2ND AGC

While it is ideal to suppress bottom echoes with the AGC alone there are some fishing grounds where this is not possible. (The high power sonar has the advantage of long-range detection but this can also be a disadvantage, since weaker echoes may be hidden in strong, unwanted echoes such as the bottom.) If you cannot suppress bottom echoes or sea surface reflections by the AGC function alone, use the 2ND AGC feature. Normally a setting of 1 or 2 is suitable. For especially strong echoes, use a setting of 3 or 4.

1. Press the MENU key. The last-used menu appears.
2. Use the [RANGE] control to choose [MENU MODE] at the top of the screen.
3. Use the [GAIN] control to choose SONAR to display the SONAR menu.
4. Use the [RANGE] control to choose 2ND AGC.
5. The 2ND AGC setting is locked so use the [GAIN] control to choose YES and then press the [EVENT] key.
6. Use the [GAIN] control to set 2ND AGC. The setting range is 0-10 and the higher the setting the greater the 2ND AGC effect.
7. Press the [MENU] key to close the menu.

2.4 Suppressing Bottom and Sea Surface Reflections in Shallow Fishing Grounds

In shallow fishing grounds with hard or rocky bottom, bottom reflections often interfere with wanted fish echoes and they can not be eliminated sufficiently with the aforementioned TVG and AGC, especially when the tilt angle is large in order to track fish schools approaching within 400 m. In such cases try to reduce the output power without turning down the gain. The picture becomes clearer when the output power is reduced rather than when the gain is decreased as illustrated below.

1. Press the MENU key. The last-used menu appears.
2. Use the [RANGE] control to choose [MENU MODE] at the top of the screen.
3. Use the [GAIN] control to choose SONAR to display the SONAR menu.
4. Use the [RANGE] control to choose TX OUTPUT.
5. Use the [GAIN] control to set TX output. The higher the setting (setting range: 0-10) the greater the TX power.
6. Press the [MENU] key to close the menu.

For long-range detection, set TX OUTPUT to 10.

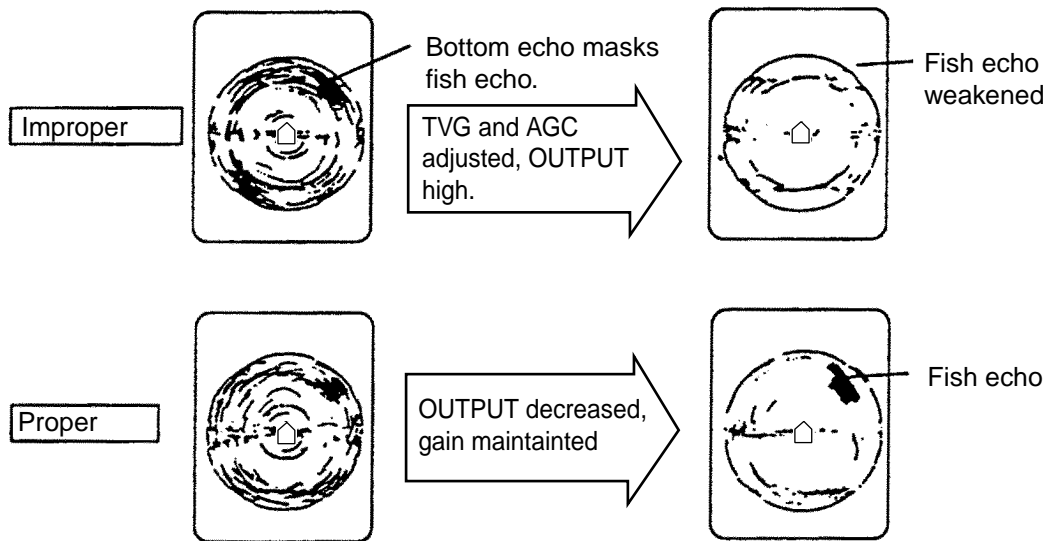

How to adjust TX output

2.5 Rejecting Sonar Interference and Noise

While observing the sonar picture, you may encounter occasional or intermittent noise and interference. These are mostly caused by on-board electronic equipment, engine or propeller noise, or electrical noise from other sonars being operated nearby.

2.5.1 Identifying noise source

To eliminate noise effectively, you should first identify the noise source.

- Turn off “TRANSMISSION” in the SONAR menu to stop transmission and operate all on board equipment one by one while observing the picture.
- Run the boat at various speeds to check if the noise is speed dependent.

If neither of the above two steps affects on the picture, adjust the INT REJECT (Interference Rejector), NOISE LIMITER or TX CYCLE on the SONAR menu as appropriate.

2.5.2 Rejecting noise with the interference rejector

This control is similar to the interference rejector on echo sounders and radars. It is effective for rejecting random noise and sea surface reflections in rough sea conditions. Set the interference rejector so that noise is just eliminated. Do not use an unnecessarily high setting since small wanted echoes may also be rejected.

1. Press the MENU key.
2. Use the [RANGE] control to choose [MENU MODE] at the top of the screen.
3. Use the [GAIN] control to choose SONAR to display the SONAR menu.
4. Use the [RANGE] control to choose INT REJECT.
5. Use the [GAIN] control to set interference rejection level, from 0 (OFF) to 3 (highest degree of suppression).
6. Press the [MENU] key to close the menu.

2.5.3 Rejecting noise with the noise limiter

Weak, unwanted reflections, colored light blue or green, are displayed when water is contaminated or plankton layers exist or due to ship's noise.

1. Press the MENU key. The last-used menu appears.
2. Use the [RANGE] control to choose [MENU MODE] at the top of the screen.
3. Use the [GAIN] control to choose SONAR to display the SONAR menu.
4. Use the [RANGE] control to choose NOISE LIMITER.
5. Use the [GAIN] control to set noise limiter level. The setting range is 0-10 and the higher the figure the greater the degree of suppression.
6. Press the [MENU] key to close the menu.

2.5.4 Rejecting interference with TX cycle

When other sonars of the same TX frequency as own sonar are near, an interference ring caused may be displayed. To erase the interference ring from the screen, reduce the TX CYCLE setting.

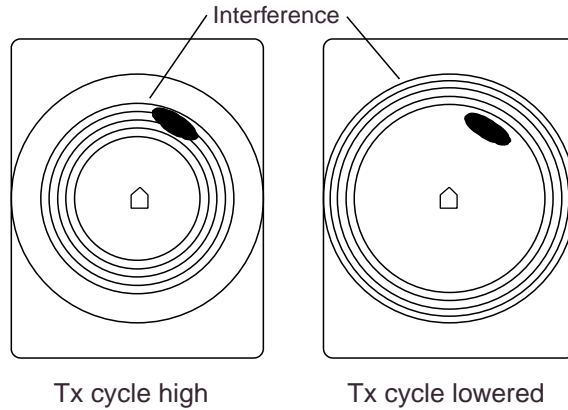

1. Press the MENU key.
2. Use the [RANGE] control to choose [MENU MODE] at the top of the screen.
3. Use the [GAIN] control to choose SONAR to display the SONAR menu.
4. Use the [RANGE] control to choose TX CYCLE.
5. Use the [GAIN] control to set TX cycle. The setting range is 0-10 and the higher the figure the longer the TX cycle.
6. Press the [MENU] key to close the menu.

Note: When the sonar is used in shallow waters with the range set between 100 m and 200 m and the TX cycle at “10”, a previously reflected echo may appear at close range. In this case reduce the TX cycle to “7 or 8” to reject it.

2.6 Choosing Beamwidth

2.6.1 Horizontal beamwidth

If you wish to have better bearing discrimination (ability to distinguish two closely located targets at the same range and different bearings) for fish schools and also wish to examine the contour of bottom, set HOR BEAMWIDTH to NARROW, on the SONAR menu.

2.6.2 Vertical beamwidth

For better bearing discrimination in the vertical direction, set VER BEAMWIDTH to NARROW, on the SONAR menu.

2.7 Deleting Weak Echoes

You can remove weak echoes to clear the picture. Echoes are deleted by strength so this feature is useful for observing only large fish schools or suppressing interference.

1. Press the [MENU] key to open the menu.
2. Use the [RANGE] control to choose [MENU MODE] at the top of the screen.
3. Use the [GAIN] control to choose SONAR.
4. Use the [RANGE] control to choose DELETE COLOR.
5. Use the [GAIN] control to choose setting. The setting range is 0-10 and the higher the number the stronger the echo that will be erased.
6. Press the [MENU] key to close the menu.

2.8 Echo Averaging

You may adjust echo afterglow to follow echo movement. The higher the setting the longer the afterglow remains on the screen.

1. Press the [MENU] key to open the menu.
2. Use the [RANGE] control to choose [MENU MODE] at the top of the screen.
3. Use the [GAIN] control to choose SONAR.
4. Use the [RANGE] control to choose ECHO AVERAGE.
5. Use the [GAIN] control to choose setting. The setting range is 0 (OFF) to 3 and the higher the setting the longer echoes remain on the screen.
6. Press the [MENU] key to close the menu.

2. FINE TUNING THE SONAR PICTURE

(This page intentionally left blank.)

3. ADVANCED SONAR OPERATION

3.1 Tracking a Fish School (target lock)

Target lock, which requires speed and heading inputs, automatically tracks a fixed location (such as a reef) so that you won't lose sight of it on the display screen.

1. On the sonar display, operate the trackball to place the trackball mark on the location you want to track.
2. Press the [TARGET LOCK] key.

The target lock mark appears (⊙) on the echo selected and the bearing mark bisects the echo. Horizontal range, depth and bearing to the target appear at the bottom right hand corner of the sonar display. Note that target lock is automatically cancelled when the echo moves 1.5 times the range in use.

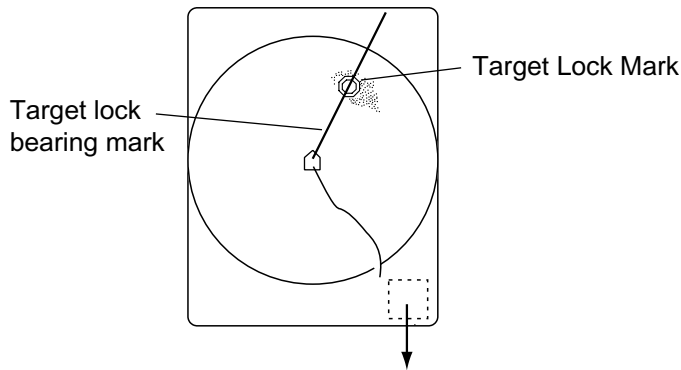

Target Lock Data



- ➔ 650 (Horizontal range from own ship to target)
- ↓ 153 (Depth of target)
- B NNE (Relative bearing to target*)

* Relative bearing format may be selected with OTHER MARKS on the MARKS menu.

** Any value which exceeds 9999 is displayed with four asterisks (****).

Target lock mark and target lock data

3. To cancel target lock and erase the target lock mark and bearing mark, press the [TARGET LOCK] key again.

Note 1: If automatic tilt is active it is automatically cancelled. It is resumed once target lock is disabled.

Note 2: Target lock feature is cancelled when the position selected is more than 1.5 times the range.

3. ADVANCED SONAR OPERATION

Note 3: The target lock feature tracks a target up to 55° tilt angle. For example, if a ship moves from position A to position D, the target lock works between positions A and B. The tilt angle is fixed between positions B and C is 55°, however calculation continues internally. Target lock is restarted after position C.

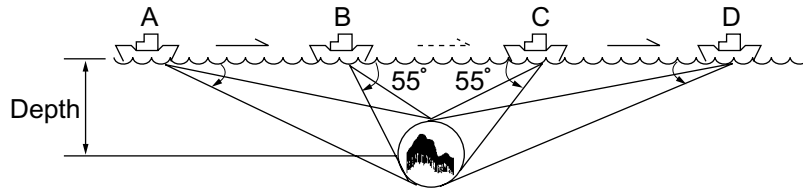

Target lock and tilt angle

3.2 Detecting Fish Schools Aurally

Sometimes you may be preoccupied with other tasks and unable to concentrate on watching the sonar picture. In such cases it would be a good choice to use the audio function. This function enables you to monitor echoes from fish schools and bottom through the built-in speaker.

After you've become accustomed to monitoring fish aurally, you should be able to detect a fish school from a range longer than you can detect it on the screen. In addition you may judge whether the fish school is approaching or going away; the tone becomes higher when the school is approaching and lower when the school is going away.

1. Operate the trackball to place the trackball mark on the direction you want to monitor through the speaker. (If the trackball mark is placed on the own ship mark when the [R/B] key is pressed, the range and bearing marks and range and bearing marks data are erased.)
2. Press the [R/B] key. The bearing mark appears on the bearing selected with the trackball mark. Listen to echoes through the loudspeaker. You may adjust the volume of the loudspeaker with AUDIO VOLUME on the SONAR menu.
3. To change aural coverage area, do the following:
 - a) Press the [MENU] key to open the menu.
 - b) Use the [RANGE] control to choose [MENU MODE] at the top of the screen.
 - c) Use the [GAIN] control to choose SONAR.
 - d) Use the [RANGE] control to choose AUTO TRAIN.
 - e) Use the [GAIN] control to choose ON.
 - f) Use the [RANGE] control to choose TRAIN SECTOR.
 - g) Use the [GAIN] control to choose train sector among $\pm 10^\circ$, $\pm 20^\circ$, $\pm 40^\circ$ and $\pm 60^\circ$.

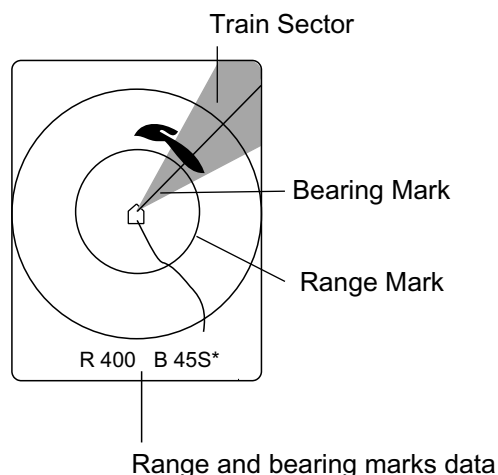

* = Relative bearing format may be chosen with OTHER MARKS in the MARKS menu.

- h) Press the [MENU] key to close the menu. Then, automatic training starts, centered on the bearing mark.

To turn off automatic training, choose OFF at step e).

3.3 The Fish Alarm

The fish alarm generates an audio alarm when a fish echo above a certain strength enters the alarm zone.

1. Operate the trackball to place the trackball mark on the starting point of the alarm zone.
2. Press the [ALARM ZONE] key.
3. Operate the trackball to place the trackball mark on the ending point of the alarm zone.
4. Press the [ALARM ZONE] key.

The display paints a fan-shaped alarm zone. The audio alarm will be released when an echo enters the alarm zone.

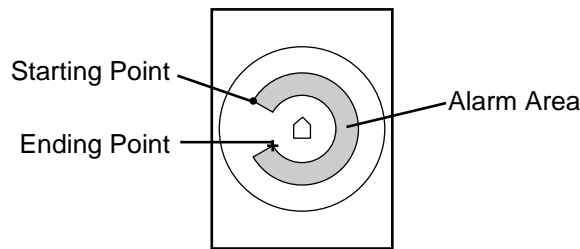

Fish alarm zone

Note 1: There must be at least three degrees difference between the starting and end points to get a fan-shaped alarm zone as shown in (a) and (b) below. Otherwise, a 360° alarm zone is painted as in (c) and (d).

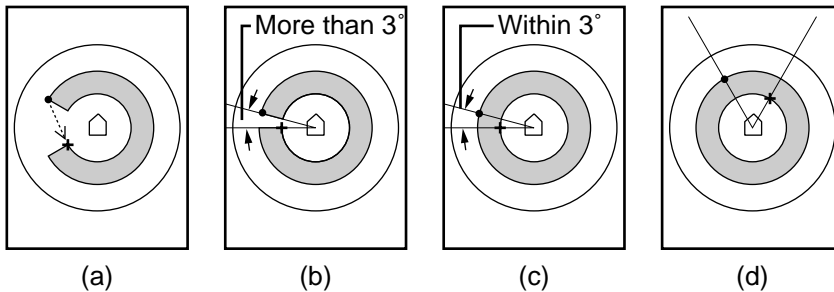

Fish alarm zones

Note 2: You may set the echo strength level which will release the audio alarm with ALARM LEVEL on the SONAR menu. The setting range is 0-14.

Note 3: To show or erase the alarm zone, press the [FISH ALARM] key.

3.4 Measuring Fish School Speed

To ensure a good haul, it is important to estimate the direction and speed of the fish school before shooting the net. You can do this with the [FISH] key. If the tidal current data is used together with fish speed data, you can determine the timing of the net shooting more efficiently. This function requires speed and heading inputs.

3.4.1 Entering a fish mark

1. Place the trackball mark on the center of a fish school, and then press the [FISH] key. The latest fish mark (◇) appears on the fish school.
2. Wait 1 to 2 minutes.
3. Place the trackball mark on the same fish school selected at step 1, and then press the [FISH] key.

The latest fish mark (◇) appears on the target and the 2nd latest fish mark (◇) appears on the location selected at step 1. In addition, the range between the two fish marks, horizontal range from own ship to the latest fish mark and the speed and course of the fish school are shown at the bottom right corner of the sonar display.

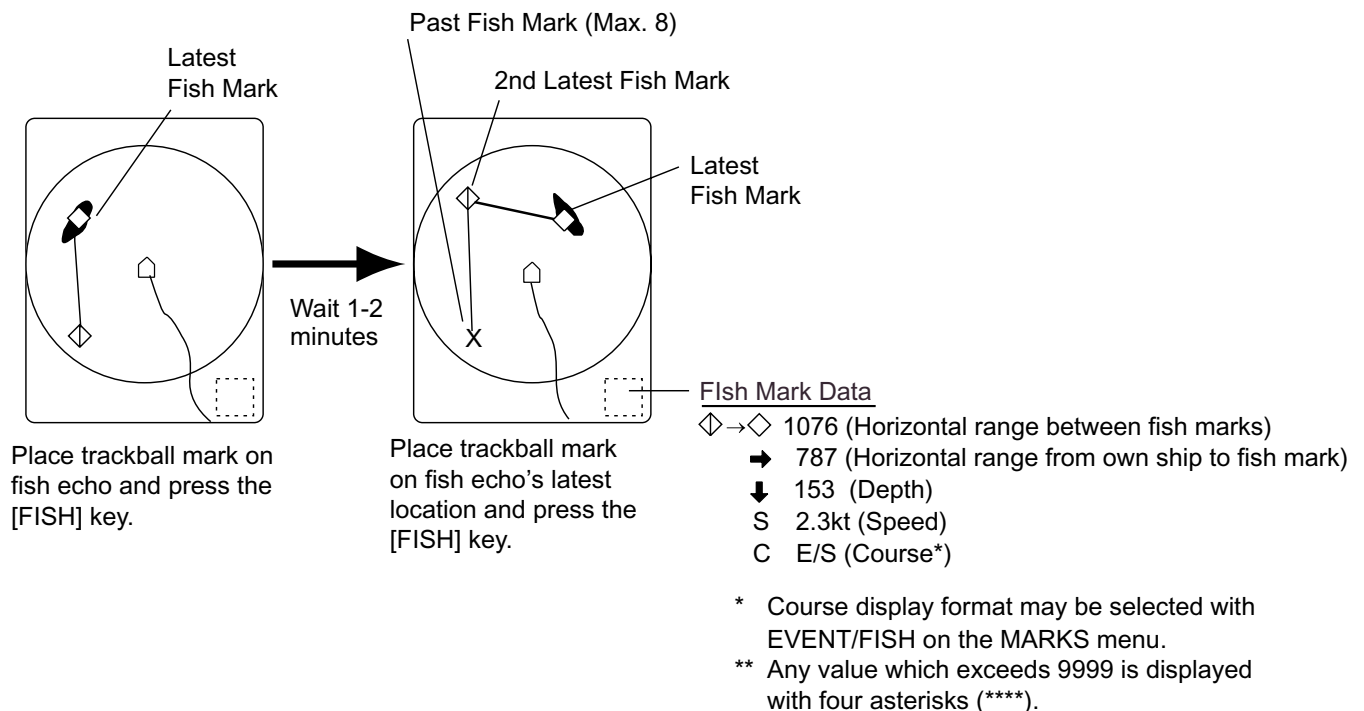

Fish mark and fish mark data

Note 1: Movement is calculated using ship's speed and heading. Accordingly, pitching and rolling may affect the calculation. For more accurate measurement, repeat the procedure two or three times to verify reliability of the data.



Note 2: The time and distance between pressings of the [FISH] key should be as long as possible to increase accuracy of measurement. For more accurate measurement, repeat the procedure two or three times.



3. ADVANCED SONAR OPERATION

Note 3: Each time the [FISH] key is pressed the fish mark changes in the sequence shown below. Maximum 10 fish marks may be inscribed, one latest, one 2nd latest and eight past.

Fish key pressed once: 

Fish key pressed twice:  => 

Fish key pressed three times: X  => 

Fish key pressed four times: X X  => 

3.4.2 Deleting individual fish marks

To delete specific fish marks, use the [DELETE MARK] key as shown below. To delete fish marks collectively, see paragraph 3.7.

1. Operate the trackball to place the trackball mark on the fish mark you want to delete. The color of the fish mark changes from white to red if the trackball mark is correctly placed.
2. Press the [DELETE MARK] key to delete the fish mark.

3.5 Relocating Fish School for Easy Observation

1. Operate the trackball to place the trackball mark on the position where you want to relocate the own ship mark.
2. Press the [OFF CENTER] key.
3. To return the own ship mark back to the screen center, press the [OFF CENTER] key again.

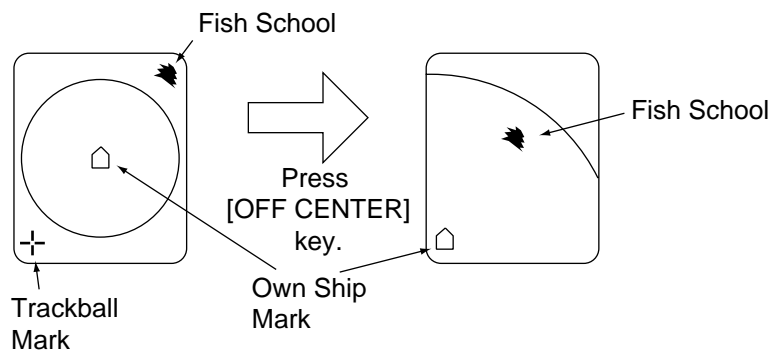

How to use the off-center function

3.6 Event Mark, Own Ship Position Mark

3.6.1 Event mark

The event mark, which requires speed and heading data, is useful for finding the horizontal range, depth and bearing to a location some distance from current position.

Plotting an event mark on the display is equivalent to dropping a buoy with an anchoring chain that extends from surface to bottom. The buoy is fixed at its present geographical location, but the mark on the display moves to a point where present beam plane intersects the anchor chain of the buoy as the ship moves or the tilt angle is changed. This can be said of other marks as well such as fish mark and trackball mark.

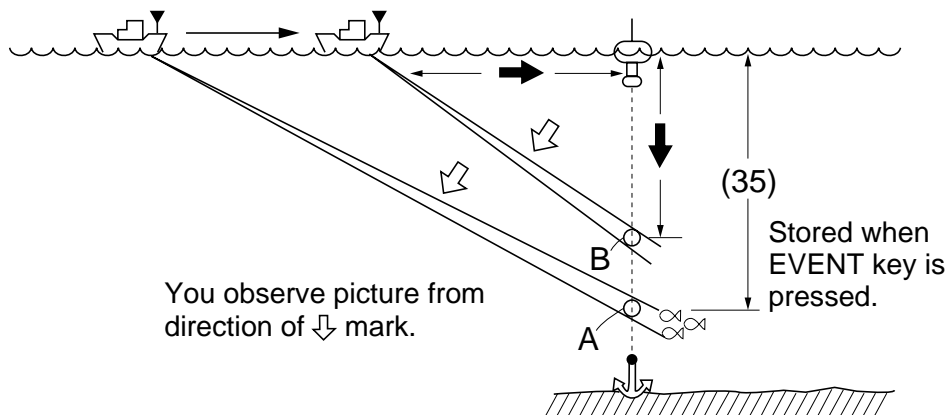

How to use the event mark

Entering an event mark

1. Operate the trackball to place the trackball mark where you want to place an event mark (latest event mark).
2. Press the [EVENT] key. The horizontal range, depth and bearing to the event mark appear at the bottom left corner of the sonar display.

Event mark position is calculated from ship's speed and heading data and it moves on the screen with own ship's movement. With connection of a navigator, the latitude and longitude of the event mark are output to the navigator when an event mark is entered, in NMEA format TLL sentence.



→234 : Horizontal range (m) from own ship mark to mark
 ↓121 : Depth (m) to mark
 (121) : Depth (m) of mark at moment EVENT key is pressed.
 B SW/W : Bearing (degree)*

* Bearing format may be selected with
 EVENT/FISH on the MARKS menu.

** Any value which exceeds 9999 is displayed
 with four asterisks (****).

Event mark data, shown at bottom left corner of the display

3. ADVANCED SONAR OPERATION

Each time the key is pressed the appearance of the event marks changes as below. Ten marks may be entered. When this amount is exceeded the oldest event mark is automatically erased.

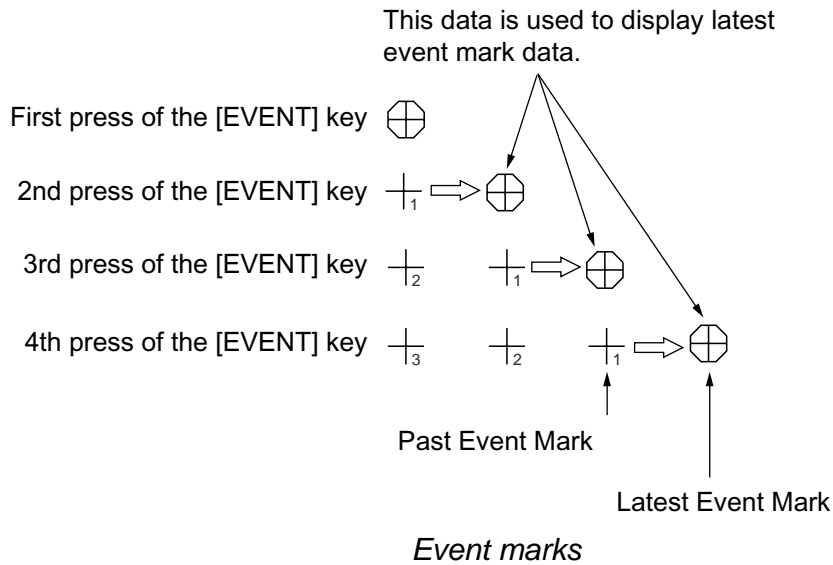

3.6.2 Entering an own ship position mark

Operate the trackball to place the trackball mark on the own ship mark and press the [EVENT] key to inscribe an own ship position mark. 10 own ship position marks (Δ) may be entered. When this amount is exceeded the oldest own ship position mark is automatically erased.

3.6.3 Deleting an event mark

You may delete specific event mark as follows:

1. Operate the trackball to place the trackball mark on the event mark or own ship position mark you want to delete. The color of the mark changes from white to red if the trackball mark is correctly placed.
2. Press the [DELETE MARK] key to delete the mark.

3.7 Collectively Deleting Marks

You may collectively delete track, event marks or fish marks as shown below. Own ship position mark may be also be deleted, one by one.

1. Press the [MENU] key to open the menu.
2. Use the [RANGE] control to choose [MENU MODE] at the top of the screen.
3. Use the [GAIN] control to choose SONAR.
4. Use the [RANGE] control to choose ERASE MARKS.
5. Use the [GAIN] control to choose item to delete: TRACK, SHIP, EVENT or FISH.

TRACK: The oldest 10% of the ship's track is erased with each press of the [EVENT] key.

SHIP: The oldest own ship mark is deleted with each press of the [EVENT] key.

EVENT, FISH: All corresponding marks are erased when the [EVENT] key is pressed.

6. Press the [EVENT] key to delete all of the mark type selected at step 5.
7. Press the [MENU] key to close the menu.

3.8 Function Keys (F1-F4)

A function key may be programmed two ways: set up the equipment according to fishing ground or target fish, or provide a shortcut for a menu item on the SONAR or SOUNDER menu.

Default function key programs (main items only)

Sonar Menu Item	Function Key				<u>Default program</u>
	F1	F2	F3	F4	
TX OUTPUT	8	10	8	10	F1: Short-range detection F2: Long-range detection
PULSE LENGTH	7	10	7	10	F3: Short-range detection F4: Long-range detection
TX CYCLE	10	10	10	10	
TVG NEAR	6	5	6	5	
TVG FAR	6	8	6	8	
HOR BEAMWIDTH	Narrow	Narrow	Narrow	Narrow	
VER BEAMWIDTH	Wide	Narrow	Wide	Narrow	
COLOR CURVE	4	1	4	1	
COLOR RESPONSE	2	4	2	4	

3.8.1 Operating the function keys

1. Press desired function key. The equipment is set according to function key program, or a dialog box appears in case of shortcut operation. For shortcut operation, go to step 2. The illustration below shows the ERASE MARKS dialog box.
2. Press the same function key again within five seconds to set value or choose option. (Be sure to press the function key within five seconds; the dialog box is automatically erased after five seconds.) In case of the SONAR menu item ERASE MARKS use the function key to choose the item to erase and then press the [EVENT] key to erase.

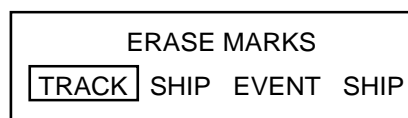

ERASE MARKS dialog box

3.8.2 Programming for fishing ground or target fish

1. Set up controls on the control unit according to fishing ground or target fish.
2. Press the [MENU] key to open the menu.
3. Use the [RANGE] control to choose [MENU MODE].
4. Use the [GAIN] control to choose SONAR.
5. Set all menu items (except TRANSMISSION) as appropriate.
6. Use the [RANGE] control to choose ASSIGN SETTING.

7. Use the [GAIN] control to choose the function key (F1-F4) you want to program.
8. Press the [EVENT] key to program the function key selected at step 7.
9. Press the [MENU] key to close the menu.

Useful programs (main items only)

<u>For detecting surface fish</u>		<u>For detecting bottom fish</u>		<u>For detecting midwater fish</u>	
TX OUTPUT	8	TX OUTPUT	7	TX OUTPUT	8
PULSE LENGTH	7	PULSE LENGTH	5	PULSE LENGTH	8
TX CYCLE	10	TX CYCLE	10	TX CYCLE	10
TVG NEAR	5	TVG NEAR	5	TVG NEAR	6
TVG FAR	5	TVG FAR	6	TVG FAR	7
HOR BEAMWIDTH	Narrow	HOR BEAMWIDTH	Narrow	HOR BEAMWIDTH	Narrow
VER BEAMWIDTH	Narrow	VER BEAMWIDTH	Wide	VER BEAMWIDTH	Wide
COLOR CURVE	1	COLOR CURVE	4	COLOR CURVE	3
COLOR RESPONSE	3	COLOR RESPONSE	1	COLOR RESPONSE	3

3.8.3 Programming specific function

You may program a function key with a menu item from the SONAR or SOUNDER menu to use as shortcut. Most items are available except TRANSMISSION, ASSIGN SETTING and ASSIGN MENU from the SONAR menu and DRAFT from the SOUNDER menu. Locked items (shown in red) are available however the message which asks if you are sure to change a setting is not displayed when the corresponding function key is operated.

1. Press the [MENU] key to open the menu.
2. Use the [RANGE] control to choose [MENU MODE].
3. Use the [GAIN] control to choose SONAR or SOUNDER as appropriate.
4. Use the [RANGE] control to choose item.
5. Press appropriate function key until the message "COMPLETED" appears (more than three seconds).
6. Press the [MENU] key to close the menu.

3.8.4 Confirming function key program

You may confirm function key program as below.

1. Press the [MENU] key to open the menu.
2. Use the [RANGE] control to choose [MENU MODE].
3. Use the [GAIN] control to choose SONAR.
4. Use the [RANGE] control to choose ASSIGN MENU. The current programs are shown at the top of the menu

F1	F1 KEY
F2	F2 KEY
F3	TVG NEAR
F4	TVG FAR

Function key assignment confirmation screen

5. Press the [MENU] key to close the menu.

3.9 Suppressing Effects of Pitching and Rolling (Stabilizer)

The Motion Sensor MS-100 (option) compensates for the affects of pitching and rolling to provide steady, non-fading pictures, along the bearing selected. Follow the procedure below to use the stabilizer feature.

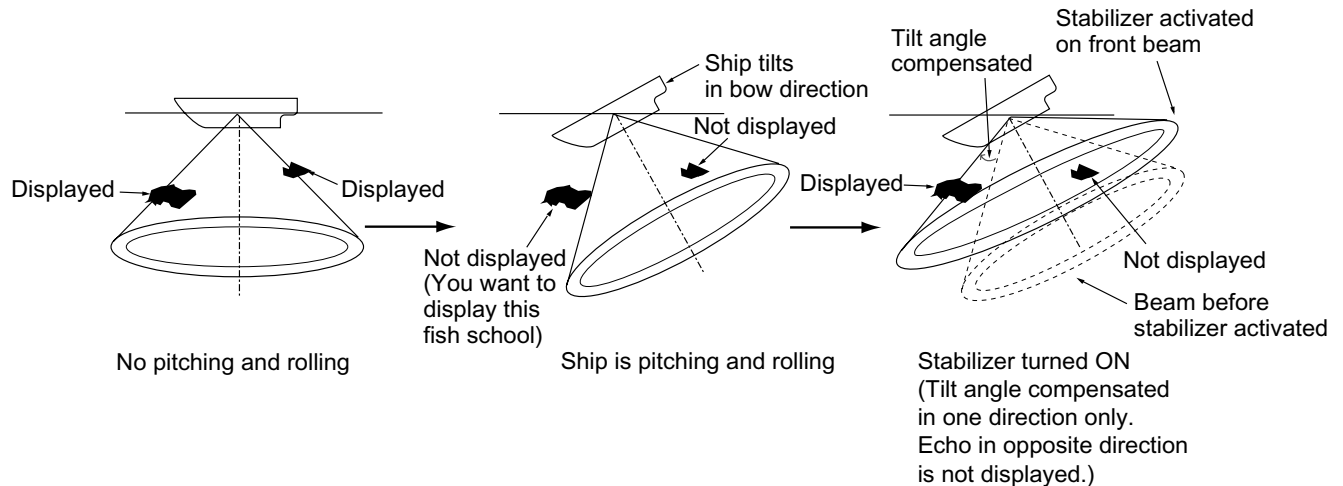

How the stabilizer works

1. Operate the trackball to place the trackball mark on the bearing where you want the stabilizer the picture.
2. Press the [STABILIZER] key. The stabilizer mark, a dashed line extending from the screen center to the edge of the effective diameter of the sonar display, appears on the bearing selected and "STAB" appears at the top right corner of the sonar display.

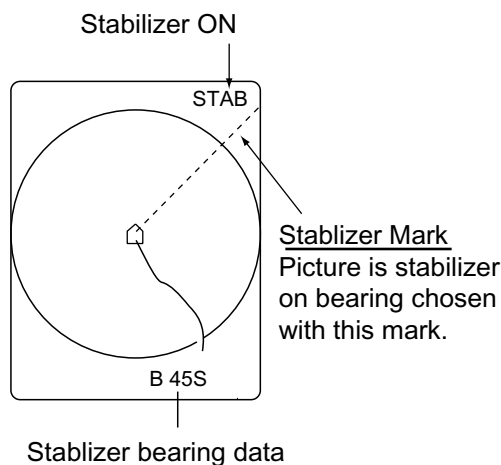

Stabilizer mark

Note: If the target lock function is active when the stabilizer is turned on, the stabilizer works on the bearing selected for the target lock feature (target lock function has higher priority) and the stabilizer mark is not displayed. Even when target lock is deactivated the stabilizer operates on the bearing selected for target lock.

3. ADVANCED SONAR OPERATION

3. To turn off the stabilizer, press the [STABILIZER] key. The stabilizer mark, stabilizer indication and stabilizer bearing data are erased. If range and bearing marks are shown they are displayed along with their data.

Note 1: The tilt angle can be manually set in the range of 0-55°, however pitching and rolling are compensated within the $\pm 20^\circ$ in the tilt angle range of 0 to 55°.

Note 2: If the target lock is activated while the stabilizer is on, the bearing set for target lock will be used with the stabilizer as well and the stabilizer mark is erased. When the target lock is turned off, the bearing set before target lock was turned on is used and the stabilizer mark reappears at the bearing originally selected.

4. ECHOSOUNDER MODE

This chapter covers operation of the echosounder picture, which may be displayed by choosing the COMBI-2 mode.

4.1 Choosing the Range

The basic range and range shifting functions together give you the means to select the depth you can see on the screen. The basic range can be thought of as providing a “window” into the water column and range shifting as moving the “window” to the desired depth.

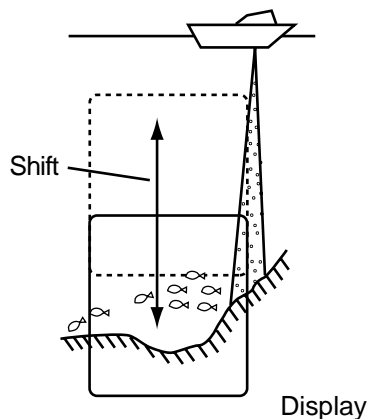

Display range and shift concept

Note: Select the Range and Shift to the same setting as the echo sounder connected. This setting does not affect the original echo sounder setting.

1. Press the [MENU] key to open the menu.
2. Use the [RANGE] control to choose [MENU MODE] at the top of the screen.
3. Use the [GAIN] control to choose SOUNDER.

4. ECHOSOUNDER

** SOUNDER MENU **		(RANGE CTRL: U/D, GAIN CTRL: L/R)		
[MENU MODE]	: SONAR	SOUNDER	MARKS	SYSTEM
COLOR	: 1	2	3	4
RANGE	: 160			
SHIFT	: 0			
E/S INT REJECT	: ON	OFF		
GAIN	: 3.0			
CLUTTER	: 2.0			
ADVANCE	: 2/1 1/8	1/1	1/2	1/4
COLOR CURVE	: LINEAR	1	2	3
DELETE COLOR	: 0			
DRAFT	: 0.0(m)			

PRESS [MENU] KEY TO EXIT

Sounder menu

4. Use the [RANGE] control to choose RANGE.
5. Use the [GAIN] control to choose range desired among 20, 40, 80, 120, 160, 240 and 320 (meters).
6. To shift the display, use the [RANGE] control to choose SHIFT.
7. Use the [GAIN] control to choose amount of shift desired (range 0-1000 (meters)).
8. Press the [MENU] key to close the menu.

4.2 Adjusting the Gain

You may adjust the display level of the echo sounder picture as below; the gain of the echo sounder itself cannot be adjusted from the sonar.

Note: Set the gain to the same setting as the echosounder connected. This setting does not affect the original echosounder setting.

1. Press the [MENU] key to open the menu.
2. Use the [RANGE] control to choose [MENU MODE] at the top of the screen.
3. Use the [GAIN] control to choose SOUNDER.
4. Use the [RANGE] control to choose GAIN.
5. The gain setting is locked so operate the [GAIN] control to choose YES and then press the [EVENT] key.
6. Use the [GAIN] control to adjust gain (setting range: 0.0-10.0).
7. Press the [MENU] key to close the menu.

4.3 Picture Advance Speed

The picture advance speed determines how quickly the vertical scan lines run across the screen. When selecting a picture advance speed, keep in mind that a fast advance speed will expand a fish school horizontally and a slow advance speed will contract it.

Note: Match the picture advance speed to that of the echo sounder. This setting does not affect original echosounder setting.

1. Press the [MENU] key to open the menu.
2. Use the [RANGE] control to choose [MENU MODE] at the top of the screen.
3. Use the [GAIN] control to choose SOUNDER.
4. Use the [RANGE] control to choose ADVANCE.
5. The picture advance speed setting is locked so use the [GAIN] control to choose YES and then press the [EVENT] key.
6. Use the [GAIN] control to adjust advance speed desired. The fractions in the dialog box are one line produced per number of transmissions. For example, "1/2" displays one scan line per two transmissions.
7. Press the [MENU] key to close the menu.

4.4 Measuring Depth

You can measure depth to the cross-hair cursor as follows:

1. Use the trackball to place the trackball mark inside the echosounder display. The trackball mark changes to a cross-hair cursor.
2. Adjust the trackball to place the cross-hair cursor at the location desired.
3. Read the depth to the location at the cross-hair cursor.

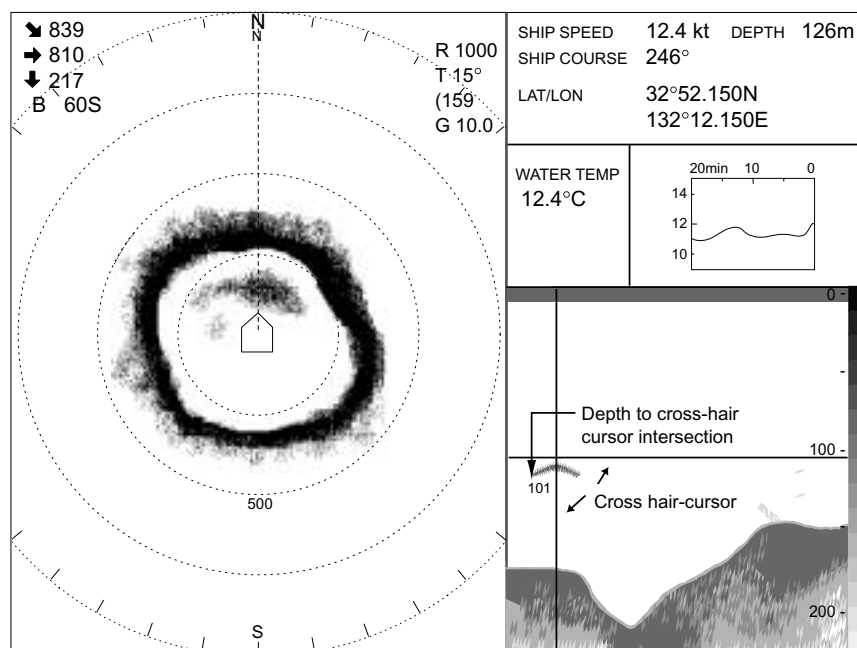

Measuring depth

4.5 Suppressing Interference

Interference from other sounders or electrical interference shows itself on the screen as in the illustration below.



Interference from other sounders

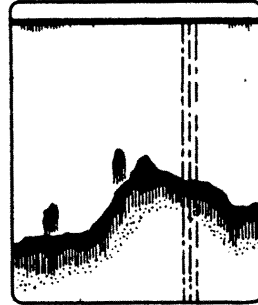

Interference from electrical equipment

Interference

To remove interference, do the following:

1. Press the [MENU] key to open the menu.
2. Use the [RANGE] control to choose [MENU MODE] at the top of the screen.
3. Use the [GAIN] control to choose SOUNDER.
4. Use the [RANGE] control to choose E/S INT REJECT.
5. Use the [GAIN] control to choose ON. (If no interference exists, choose OFF.)
6. Press the [MENU] key to close the menu.

4.6 Suppressing Low Level Noise

Low level noise, often caused by sediments in water, is painted on the screen as a large number of light-blue dots. These echoes may be suppressed as below.

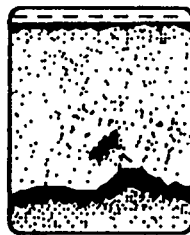

Clutter

1. Press the [MENU] key to open the menu.
2. Use the [RANGE] control to choose [MENU MODE] at the top of the screen.
3. Use the [GAIN] control to choose SOUNDER.
4. Use the [RANGE] control to choose CLUTTER.
5. CLUTTER is locked so use the [GAIN] control to choose YES and then press the [EVENT] key.
6. Use the [GAIN] control to choose setting. (The setting range is 0.0-10.0 and the higher the number the stronger the echo that will be erased.)
7. Press the [MENU] key to close the menu.

4.7 Erasing Weak Echoes

Sediments in the water or reflections from plankton may be painted on the screen in green or light-blue, as shown in the illustration below. These echoes may be erased in order of strength as below.

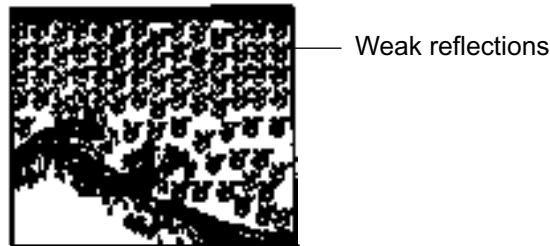

Weak echoes

1. Press the [MENU] key to open the menu.
2. Use the [RANGE] control to choose [MENU MODE] at the top of the screen.
3. Use the [GAIN] control to choose SOUNDER.
4. Use the [RANGE] control to choose DELETE COLOR.
5. Use the [GAIN] control to choose setting desired. The setting range is 0-10, and the higher the setting the stronger the echo that will be erased.
6. Press the [MENU] key to close the menu.

4.8 Other Items on the Sounder Menu

The table below describes the SOUNDER menu items not described in the previous sections of this chapter.

Sounder menu description

Item	Description	Ref. page
COLOR	Choose one of four display color patterns, according to your environment.	—
COLOR CURVE	Adjusts echo presentation color curve against strong reflections. For example, setting “1” averages weak to strong signals to obtain a balanced picture. The larger the setting the better the resolution on weak signals.	—
DRAFT	Set ship’s draft to get depth from the sea surface (rather than from the transducer).	—

5. MARKS AND DATA



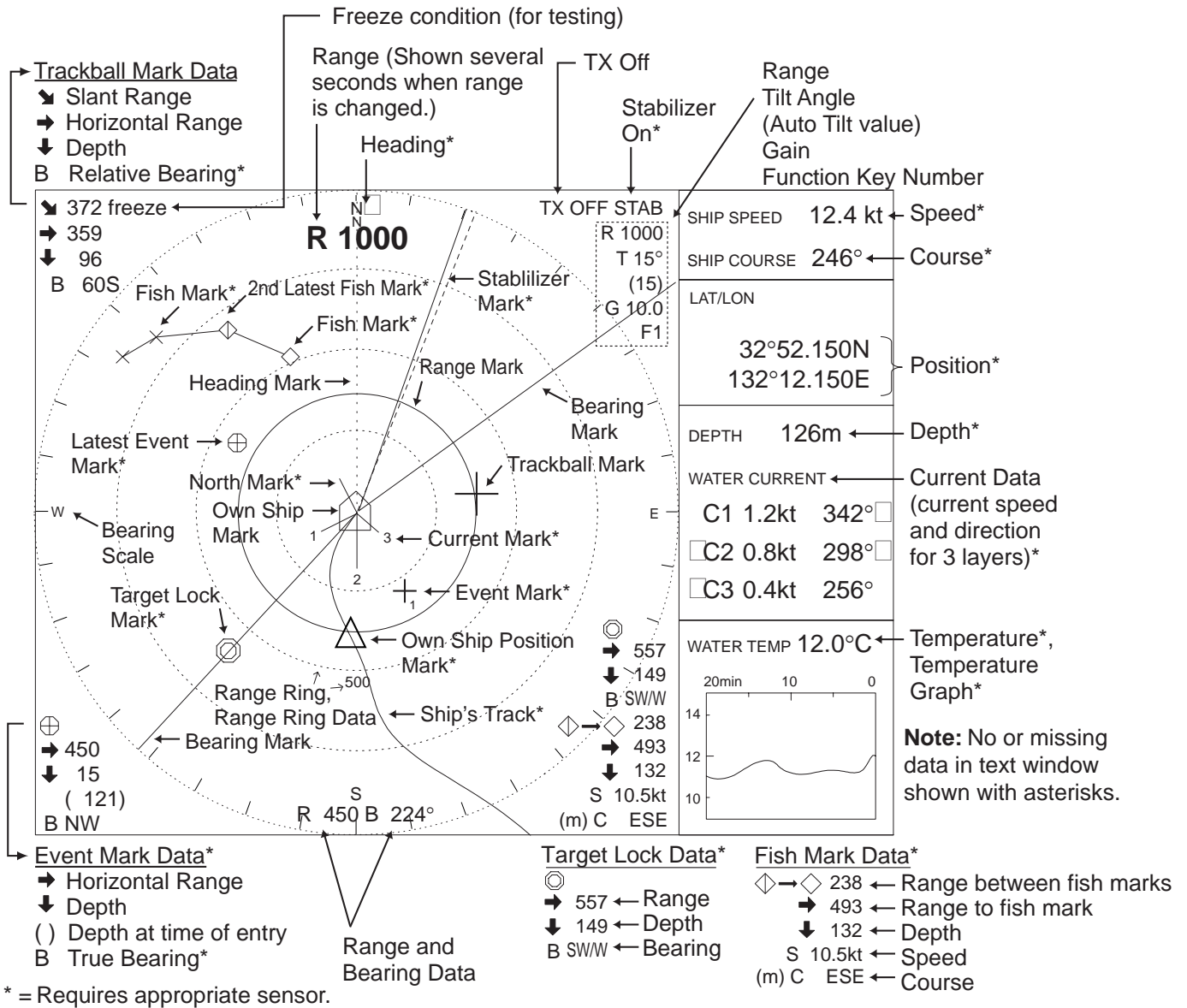

5.1 Marks and Data on the Normal Display



Marks and data on the normal display

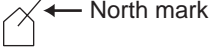

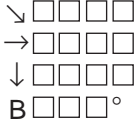

4. ECHOSOUNDER

Description of marks and data on the normal display

Mark/Data	Description
Own Ship Mark 	Shows own ship's present position and points in bow direction.
North Mark* 	When a heading sensor is connected, the North mark is displayed and points to North.
Heading Mark 	The heading mark is a dashed line extending from the screen center to the edge of the outermost range ring and it points in the direction of ship's heading.
Heading	With connection of a heading sensor, heading is shown 32 compass points (N, N/NE, etc.). The heading may also be displayed in true bearing in which case the indication is 360°.
Own Ship Position Mark 	The own ship position mark is entered at own ship's position, with the [EVENT] key. 10 marks may be entered.
Trackball Mark 	Sets own ship's mark location for off-center display; sets location for mark input; measures range and bearing. The trackball controls this mark.
Trackball Mark Data 	Trackball mark data: ↘, slant range; →, Horizontal range; ↓, Depth, B, Bearing. Appears at top left corner of the sonar display. Relative bearing Bearing is shown in 360° or ±180° indication system, relative to ship's heading. In the latter case, " B" is indicated as follows: B□□□P on the port side B□□□S on the starboard side Indication format may be selected with OTHER MARKS on the MARKS menu.
Range Data R□□□□	Range setting, selected with the [RANGE] control, appears at top right corner of the sonar display.
Tilt Angle Data T□□° (□□)	The tilt angle appears below the range indication at the top right corner of the sonar display. The tilt angle can be changed in 1° steps within the range of 0° to 55°. In target lock* and automatic tilt control, the instantaneous tilt angle appears in parentheses. Accordingly, both are equal when target lock is on. In automatic tilt, the upper indication shows the tilt angle set by the TILT lever and the lower indication the instantaneous tilt angle at which the sonar actually works.
Gain G□□.□	The gain chosen with the [GAIN] control appears on the top right corner of the sonar display.
Function Key Number F□	Function key number appears at the top right corner of the sonar display.

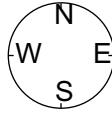



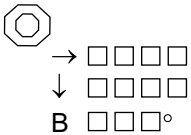

* = Requires appropriate sensor.

Description of marks and data on the normal display (con't from previous page)

Mark/Data	Description
Range Rings 	The range rings are dashed concentric circles inscribed at intervals of 1/4 or 1/2 of the range in use, depending on menu setting. Range ring data is also provided every two range rings.
Electronic Bearing Scale* 	The electronic bearing scale is the outermost ring on the sonar display and is available with heading sensor connection. It rotates with own ship's movement.
Ship's Track Mark* 	With heading and speed data, own ship's track is plotted by a solid line. The track length can be selected among five or ten times the range. When the length exceeds the chosen length, the track is erased so that its length is equal to the chosen length.
Current Mark*  Current Data* C1: □□ kt □□□° C2: □□ kt □□□° C3: □□ kt □□□°	This mark can be displayed with current indicator input. The current marks show tidal current speed and direction in three layers (1-3), selected on the current indicator. The tidal current speed is shown by the length of the line extending from the center of the mark. Current direction can be shown as "to" or "from" with CURRENT DIR on the MARKS menu. Current speed range: 0.0 to 9.9 kt Direction range: ±180° or 0-359°
Own Ship Position Data* □□°□□.□□□ N □□□°□□.□□□ E	With navigation input, position can be displayed in latitude and longitude (or Loran C TDs) in the text window. Latitude range: 90°00.000S to 90°00.000N Longitude range: 179°59.999S to 179°59.999E, 180°00.000
Nav Data* SHIP SPEED: □□. □ kt SHIP COURSE: □□□° DEPTH: □□□□m WATER TEMP: □□. □°	With appropriate sensors, speed, course, water depth and water temperature can be displayed in the text window. Speed range: 0.0-40 kts Course range: 0-359° Depth range: 0-9999 m (same range for any depth unit) Water temperature range: -10.0 to 40.0 °C
Target Lock Mark* 	The target lock mark automatically tracks the fish school selected by the operator. This function requires speed and heading data.
Target Lock Mark Data* 	The slant range (→), depth (↓) and bearing (B) of the fish echo are shown at the bottom left corner on the sonar display.

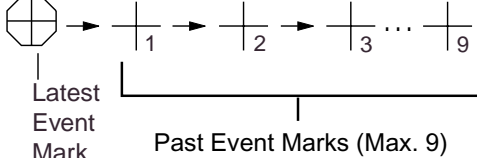
5. MARKS AND DATA

Description of marks and data on the normal display (con't from previous page)

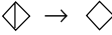
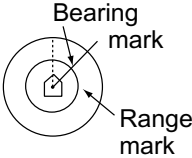
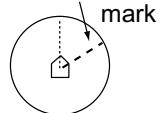
Mark/Data	Description
<p>Latest Event Mark</p>  <p>Event Mark</p> 	<p>This mark depicts important locations. Use the trackball to place the trackball mark where desired and press the [EVENT] key to inscribe an event mark. Requires speed and heading data. Event marks follow own ship's movement. Ten marks may be entered and each press of the [EVENT] key enters an event mark and previously entered marks change as follows.</p> 
<p>Latest Event Mark Data</p>  <p>→ □□□□ ↓ □□□□ (□□□□) B □□□□°</p>	<p>The position data of the latest event mark, that is, horizontal range (→), depth (↓) and bearing. (□□□□) shows the latest event mark's original depth, and remains unchanged regardless of ship's movement or tilt angle. When the event mark is erased the above data disappears from the screen. To erase an event mark, place the trackball mark on it and then press the [DELETE MARK] key.</p>
<p>Latest Fish Mark</p>  <p>2nd Latest Mark</p>  <p>Fish Mark</p> 	<p>These marks are inscribed on the screen by pressing the [FISH] key. Ten fish marks can be displayed. Each time the key is pressed the fish marks change on the screen as follows:</p> <p>1st press of FISH key ◇ 2nd press of FISH key ◇ 3rd press of FISH key × 4th press of FISH key ×</p>
<p>Fish Movement Data</p>  <p>→ □□□□ ↓ □□□□ S □□.□ C □□□</p>	<p>Fish movement from the latest fish mark (◇) to the 2nd latest fish mark (◇) is shown by horizontal range (→), depth (↓), speed (S) and course (C), at the lower right corner of the screen.</p>
<p>Range and Bearing Marks</p> 	<p>The range and bearing marks are used to choose the location to monitor aurally. Place the trackball mark on the location desired and press the [R/B] key. Own ship position and trackball mark are connected with a straight line, the bearing mark. The range mark is drawn with a concentric circle whose center is at own ship position and its radius touching the trackball mark's intersection.</p>
<p>Range and Bearing Marks Data</p> <p>R □□□□ B □□□□°</p>	<p>Range (R) and bearing (B) marks data are shown at the bottom of the display when the range and bearing marks are displayed.</p>
<p>Stabilizer Mark*</p> 	<p>With connection of Motion Sensor MS-100, the picture along the bearing chosen with the stabilizer mark is stabilized against ship's pitching and rolling. Choose the location with the trackball mark and press the [STABILIZER] key to stabilize the picture along the bearing selected.</p>

5.2 Marks and Data on the Echosounder and Audio Displays

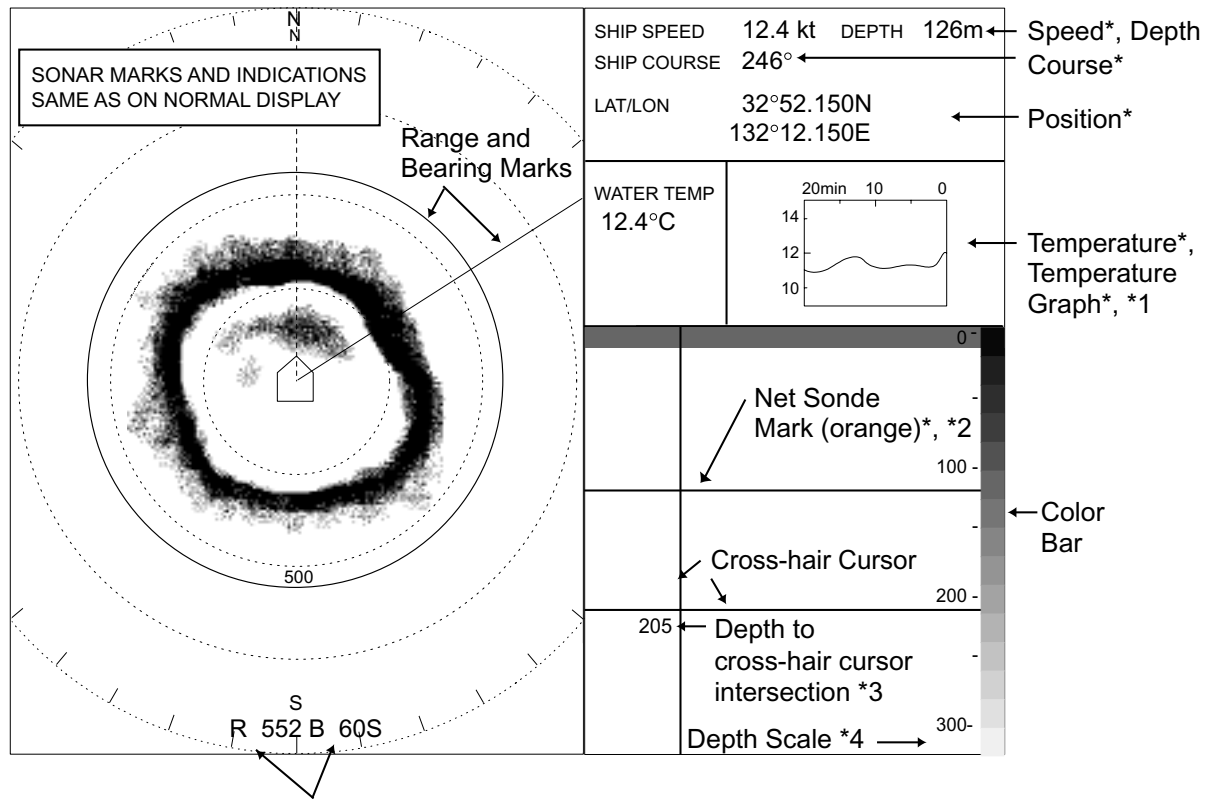

Range and Bearing Data

- * = Requires appropriate sensor.
- *1 = Water current data may be displayed instead of temperature graph. See DISP SELECT on the SYSTEM menu.

	WATER CURRENT	
WATER TEMP 12.4°C	C1	1.2kt 342°
	C2	0.8kt 298°
	C3	0.4kt 256°

- *2 = Echosounder display only
- *3 = Depth on echosounder display; range on audio display.
- *4 = Depth scale on echosounder display; range scale on audio display.

Note: Range and bearing marks are used to choose the location to display in the audio display.

Marks and data on the echosounder and audio displays

5. MARKS AND DATA

Description of marks and data on the echosounder and audio displays

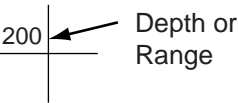
Mark/Data	Description
<p>Color Bar</p> 	<p>The color bar provides an estimate of echo strength in 16 colors. The red color is the strongest echo signal.</p>
<p>Depth Scale, Range Scale</p> <p>0 - - 100 - - 200 - - 300 -</p>	<p>The depth scale and range scale provide an estimate of depth and range in the echosounder and audio displays, respectively. It may be displayed at the right or left side of those displays. See COMBI SCALE on the SYSTEM menu.</p>
<p>Cross-hair Cursor</p> 	<p>The cross-hair cursor measures the depth and range to the user-selected location in the echosounder and audio displays, respectively. Depth or range appears at the cross-hair cursor intersection.</p>
<p>Net Sonde Mark* (Echosounder display only)</p>	<p>The net sonde marks are orange horizontal lines (solid or dashed line) which mark the location of the net sonde fed from the echosounder.</p>

6. INTERPRETING THE DISPLAY

6.1 Bottom Echo

When the tilt angle is changed, the bottom echo will appear on the screen. When the tilt angle is decreased, the bottom trace becomes wider and weaker. By observing the bottom condition on the screen, the skipper can prevent the net from being damaged by a reef or a shipwreck.

(A) Flat bottom

Tilt angle: 10° to 15°

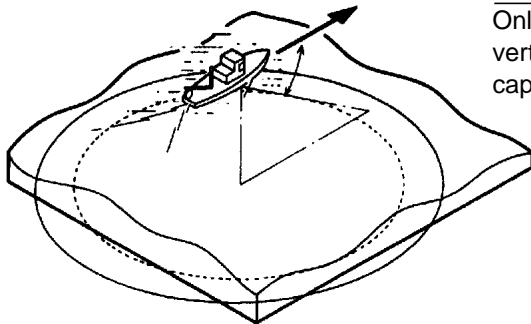

Decreased tilt angle
Only half of
vertical beam width
captures the bottom.

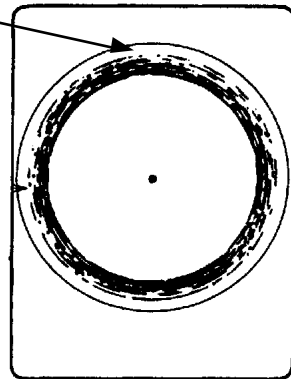

(B) Flat bottom

Tilt angle: 20° or more

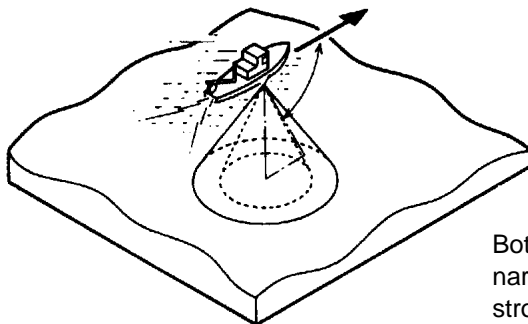

Bottom is displayed
narrower and in
stronger colors when
compared to (A).

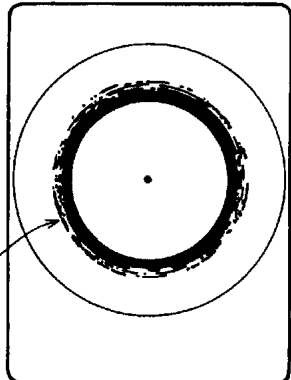

(C) Sloping bottom

Tilt angle: 20° or more

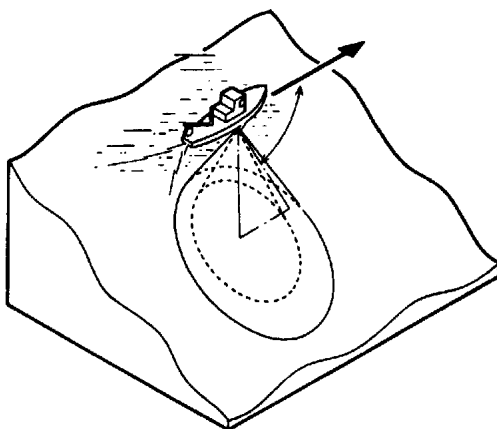

Shallow bottom
is displayed in
a strong color
and with a
short tail.

Bottom

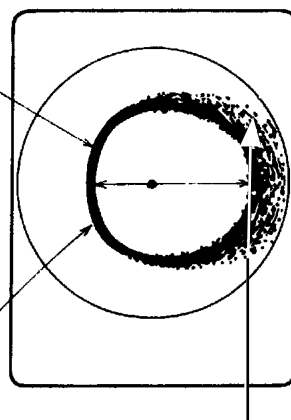

The deeper, sloping
bottom echo is displayed
in a weak color and
with a long tail.

Bottom echoes

6.2 Fish School

A fish school appears as a mass of echoes. The color of the mass shows the density. To know the distribution and center point of a fish school, choose several different tilt angles.

(A) Sea surface fish
Tilt angle: 0° to 10°

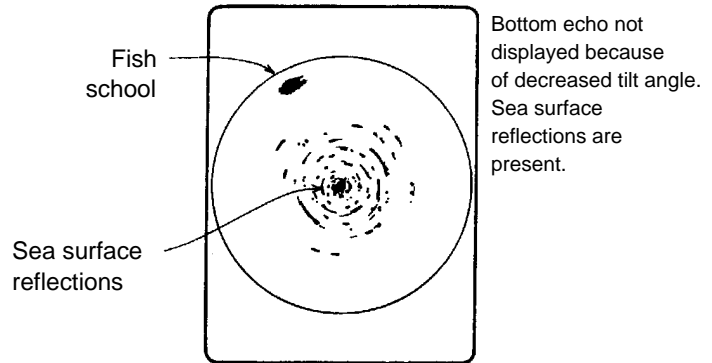
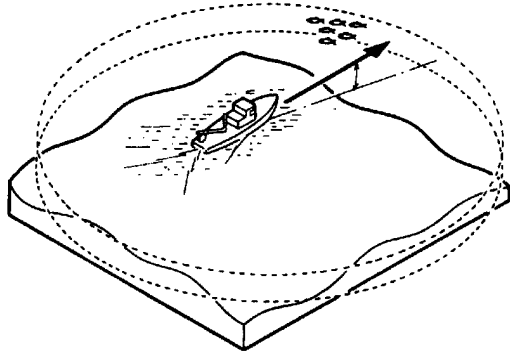

(B) Midwater, bottom fish Tilt angle: 30° or more
Fish echo which appears before bottom can be detected.

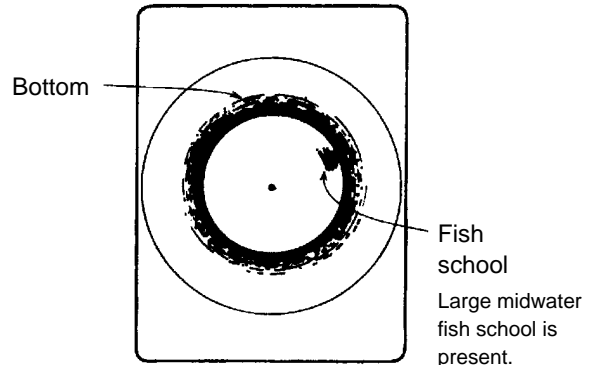
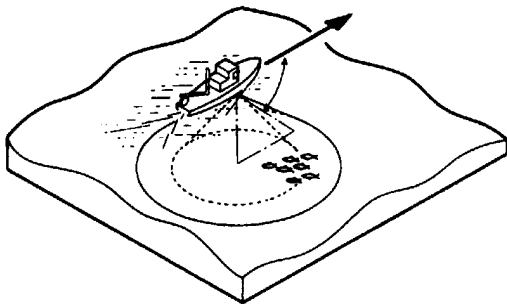

Tilt angle: 0° to 20°
Fish echo which appears together with or after bottom can be detected.

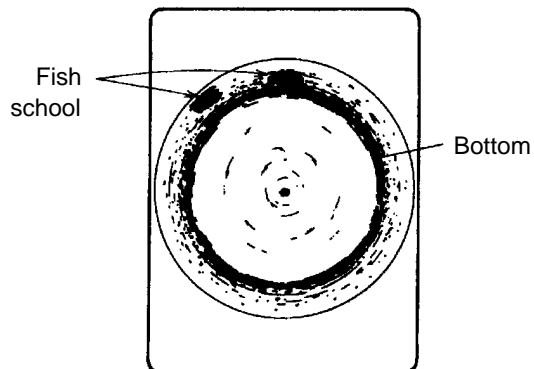
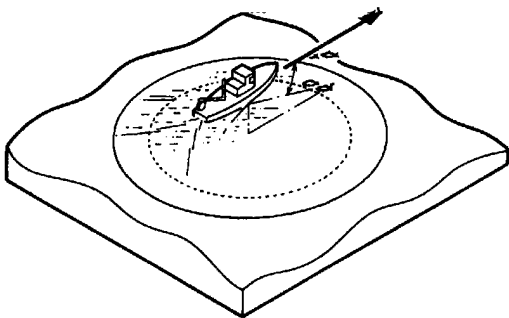

To search bottom fish, use a narrow tilt angle so the bottom echo will be weak, enabling you to see bottom fish echoes.

Fish echoes

6.3 Sea Surface Reflections

To reduce sea surface reflections, set the tilt angle to 5° or more so that the upper edge of the sonar beam does not hit sea surface, or adjust the TVG functions. When the sonar is used with a narrow tilt angle, the sea surface reflections cover a large area (up to 300 m to 400 m) as illustrated below.

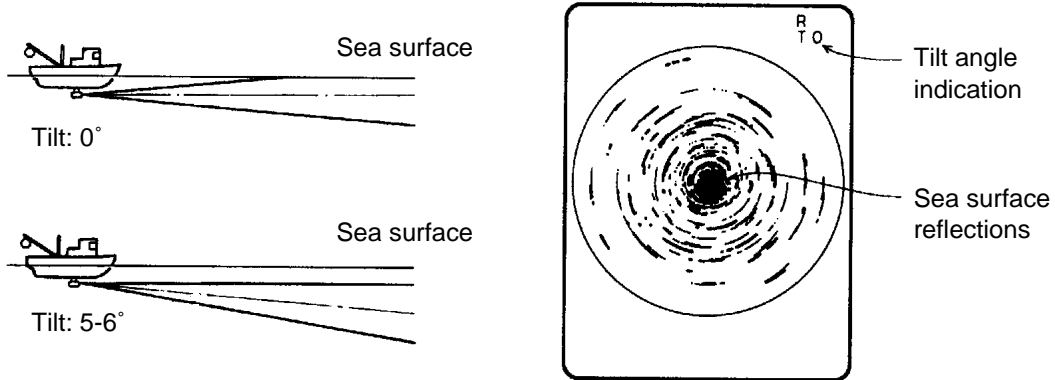

Sea surface reflections

6.4 Wake

A wake produced by own ship or another ship can be a strong reflecting object when the sonar is used with a narrow tilt angle. As the wake appears on the screen as a thick continuous line, it can be easily distinguished from a fish school. On the other hand, the wake contains a lot of air bubbles which attenuate ultrasonic energy, making it often difficult to sound beyond the wake.

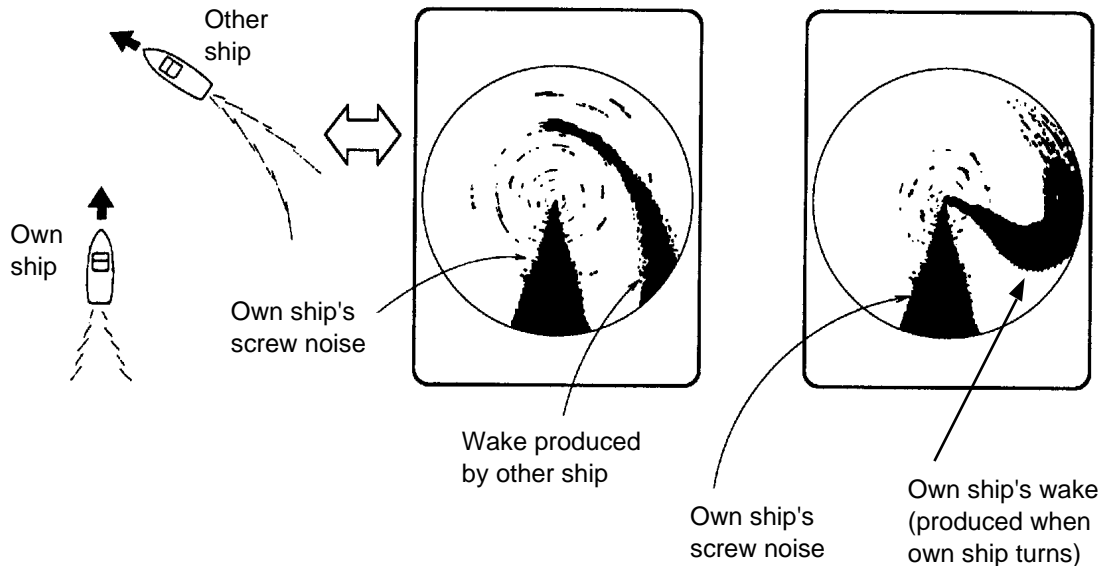

Wake

6.5 False Echo by Sidelobe

An ultrasonic wave is emitted only in the direction set by the [TILT] lever but, in practice, there are some emissions outside the main beam that are called "sidelobes." Energy of the sidelobe is fairly weak but when the sonar is used in comparatively shallow water with a hard and rocky bottom, strong target signals are detected by the sidelobe. These are represented on the screen as a false echo as shown below. To weaken the sidelobe echoes, set VER BEAMWIDTH to WIDE, on the SONAR menu.

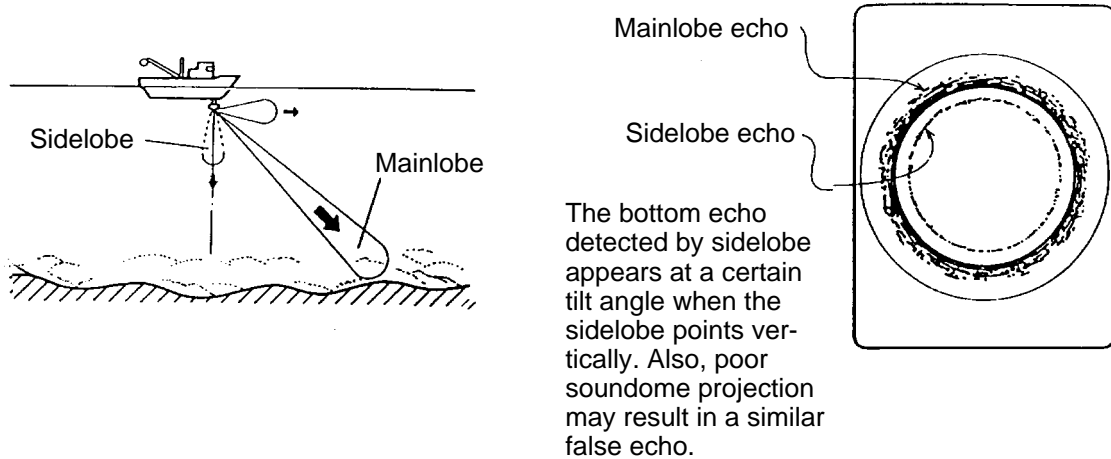

Sidelobe echo

6.6 Noise and Interference

If the fishing ground is crowded with many fishing boats, the sonar is subject to interference from ultrasonic equipment such as an echo sounder, sonar, etc. on board other boats as well as those on board own ship. For instance, interference from the sonar operated on board other boats will appear as a ring as shown in (A). This interference can be suppressed by properly changing the TX cycle. Electrical equipment on own ship can also cause interference to the sonar as shown in (B). The noise from some marine life appears on the screen as in (C). Those types of noise can be suppressed with the interference rejector.

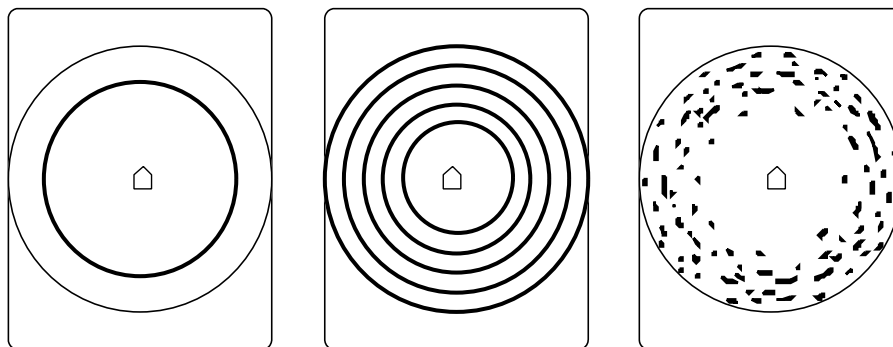

(A) Interference from other sonar

(B) Electrical interference

(C) Marine life noise

Noise and interference

7. MARKS AND SYSTEM MENUS

This chapter describes the MARKS and SYSTEM menus. To display the SYSTEM or MARKS menu, do the following:

1. Press the [MENU] key to open the menu.
2. Use the [RANGE] control to [MENU MODE] at the top of the screen.
3. Use the [GAIN] control to choose SYSTEM or MARKS as appropriate.

7.1 MARKS Menu

** MARKS MENU **		(RANGE CTRL: U/D, GAIN CTRL: L/R)			
[MENU MODE]	:	SONAR	SOUNDER	MARKS	SYSTEM
RANGE RINGS	:	1/4R	1/2R	OFF	
BEARING SCALE	:	ON	OFF		
CURRENT VECTOR	:	ON	OFF		
CURRENT DIR	:	TO	FROM		
SHIP'S TRACK	:	10R	5R	OFF	
COURSE	:	32CMPS	360TRUE		
HEADING	:	32CMPS	360TRUE	OFF	
CURRENT DATA	:	32CMPS	360TRUE	±180°	360°
EVENT/FISH	:	32CMPS	360TRUE	±180°	360°
OTHER MARKS	:	±180°	360°		
POSITION DATA	:	L/L	TD		
PRESS [MENU] KEY TO EXIT					

MARKS menu

7. MARKS AND SYSTEM MENUS

MARKS menu description

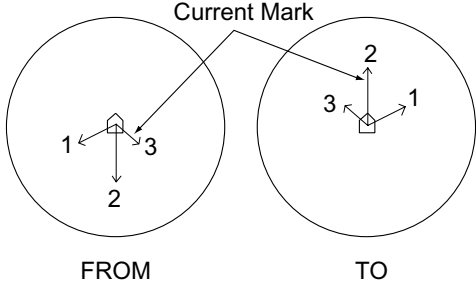
Item	Description	Ref. Page
RANGE RINGS	Turns the range rings on/off and chooses range ring interval, 1/4 or 1/2 the range. When turned off, the north mark and heading mark are also turned off.	5-3
BEARING SCALE	Turns the electronic bearing scale on/off.	5-3
CURRENT VECTOR	Turns the current (tide) mark on/off.	5-3
CURRENT DIR	<p>Turns current (tide) data on or off. "FROM" shows what direction the current is flowing; "TO" shows the direction the current is heading. Requires a current indicator.</p> 	5-3
SHIP'S TRACK	Turns ship's track display on/off. 5R and 10R are the amount of track to display; that is, the length of the track shown on the display is five and ten times the range, respectively.	5-3
COURSE	Chooses how to display course, in 32 compass points or 360° true.	5-3
HEADING	Chooses how to display heading, in 32 compass points or 360° true.	5-2
CURRENT DATA	Choose how to display current (tide) data, 32 compass points, 360° true, ±180° or 360° relative.	5-3
EVENT/FISH	Choose how to display event and fish marks, 32 CMPS, 360° TRUE, ±180° or 360°. For "±180°," starboard direction is shown as "xxxS" and port direction as "xxxP." True requires a heading sensor. 32 CMPS shows direction in compass points such as N, N/E, NNE, NE/N, etc.	Event MK: 5-5 Fish MK: 5-4 Tgt Lock MK: 5-3
OTHER MARKS	Chooses how to display other marks, ±180° or 360°.	R/B MK: 5-4 Trackball MK: 5-2
POSITION DATA	Chooses how to display position, in latitude and longitude or Loran TDs.	5-3

7.2 SYSTEM Menu

** SYSTEM MENU **		(RANGE CTRL: U/D, GAIN CTRL: L/R)			
[MENU MODE]	:	SONAR	SOUNDER	MARKS	SYSTEM
DIMMER	:	10			
DISP SELECT	:	TEMP	CURRENT		
HEADING ADJ	:	0°			
AUTO RETRACT	:	OFF	(OFF, 5-16kt)		
SPEED MESSAGE	:	ON	OFF		
EXT KP SYNC	:	OFF	ON		
AUTO TRAIN SPD	:	LOW	HIGH		
AUTO TILT SPD	:	LOW	HIGH		
UNIT	:	METERS	FEET	FATHOMS	PA/BRA
SHIP'S SPD/BR	:	LOG/GYRO	CURRENT	NAV DATA	GYRO+NAV
LOG PULSE	:	200	400		
PORT1 BAUDRATE	:	19200	9600	4800	2400
PORT1 FORMAT	:	NMEA	CIF		
PORT2 BAUDRATE	:	19200	9600	4800	2400
PORT2 FORMAT	:	NMEA	CIF		
NAV DATA	:	GPS	LC	DR	ALL
COMBI SCALE	:	RIGHT	LEFT		
SUB TEXT INDI	:	OFF	ON		
LANGUAGE	:	ENGLISH	(JAPANESE)	ESPAÑOL	DANSK
		NEDERLND	FRANCAIS	ITALIANO	(KOREAN)
		NORSK			
TEST	:	SINGLE	CONTI	PANEL	COLOR
	:	PATTERN	SIO	ECHO-1	ECHO-2
	:	ECHO-3	ECHO-4		
SET TO DEFAULT	:	EXECUTE			
PRESS [MENU] KEY TO EXIT					

SYSTEM menu

Description of SYSTEM menu

Item	Description	Ref. Page.
DIMMER	Adjust control panel backlighting.	1-5
DISP SELECT	Chooses whether to display current (tide) data or temperature data in the combination displays.	5-5
HEADING ADJ	Compensates for error (compensation range: 0-359°) in heading alignment of hull unit. If you want to turn the displayed echo 30° leftward, for example, enter 30 and to turn it rightward 30° enter 330.	—

7. MENU DESCRIPTION

Description of SYSTEM menu (con't from previous page)

Item	Description	Ref. Page.
AUTO RETRACT	Turns automatic transducer retraction on/off and sets speed (5-16) at which retraction occurs. This function requires speed data. The transducer may be retracted at a speed different from set here if the speed data is wrong. Reduce the ship's speed below 16 knots and then retract the transducer.	—
SPEED MESSAGE	Turns on/off ship's speed warning message.	8-6
EXT KP SYNC	Turn on when using external keying pulse.	—
AUTO TRAIN SPD	Chooses scanning speed of bearing mark; high or low. High speed is useful for general searching and tracking fast moving fish schools.	—
AUTO TILT SPD	Chooses the speed of tilt change in automatic tilting from high or low.	—
UNIT	Chooses unit of depth and distance measurement among meters, feet, fathoms, passi/braza. Note: The unit of measurement is fixed for some menu items (for example, draft). When the unit is changed, echosounder range and shift are reset to 0 (zero).	—
SHIP'S SPD/BR	Chooses source of speed and course data with which to draw ship's track. The choices are log/gyrocompass, current indicator, nav data and gyro+nav data.	—
LOG PULSE	Chooses log pulse/mile specification of speed log; 200 or 400 pulses/mile.	—
PORT1 BAUD RATE	Sets baud rate of equipment connected to port 1, among 2400, 4800, 9600 and 19200 (bps).	—
PORT1 FORMAT	Sets format of equipment connected to port 1; NMEA or CIF (Furuno).	—
PORT2 BAUD RATE	Sets baud rate of equipment connected to port 2, among 2400, 4800, 9600 and 19200 (bps).	—
PORT2 FORMAT	Sets format of equipment connected to port 2; NMEA or CIF (Furuno).	—
NAV DATA	Chooses source of nav data among GPS, LC (Loran C), DR (Dead Reckoning) or ALL. "ALL" automatically chooses source in the order of GPS, Loran C and dead reckoning.	—
COMBI SCALE	Chooses the location of the depth scale and distance scale in the combination displays, right or left side.	5-6
SUB TEXT INDI	For use by service technicians. Normally turn this indication off.	—
LANGUAGE	Choose the language to display among English, Japanese, Korean and several European languages.	—
TEST	Chooses the test to execute.	8-6
SET TO DEFAULT	Restores all default settings, including controls. Choose this item and then press the [EVENT] key to restore all default settings.	—

8. MAINTENANCE, TROUBLESHOOTING

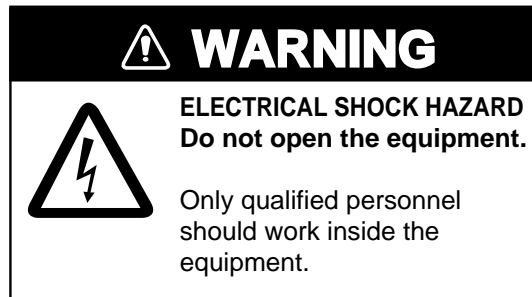

8.1 General Maintenance

This equipment is designed and constructed to provide many years of trouble-free performance when properly maintained. However, no machine can perform to the utmost of its ability without proper maintenance. Check the following points monthly.

- Check all cables. If damaged, replace.
- Check connectors at rear of each unit. Tighten or clean as necessary.
- Check earth of each unit. Tighten or clean as necessary.
- Check voltage of ship's mains to be sure it is within the equipment's power rating.

8.2 Cleaning the Equipment

Dust or dirt can be removed from the equipment with a soft, dry cloth. Do not use chemical cleaners to clean the equipment – they can remove paint and markings or deform the equipment.

8.3 Hull Unit Maintenance

8.3.1 Lubrication points, zinc plate

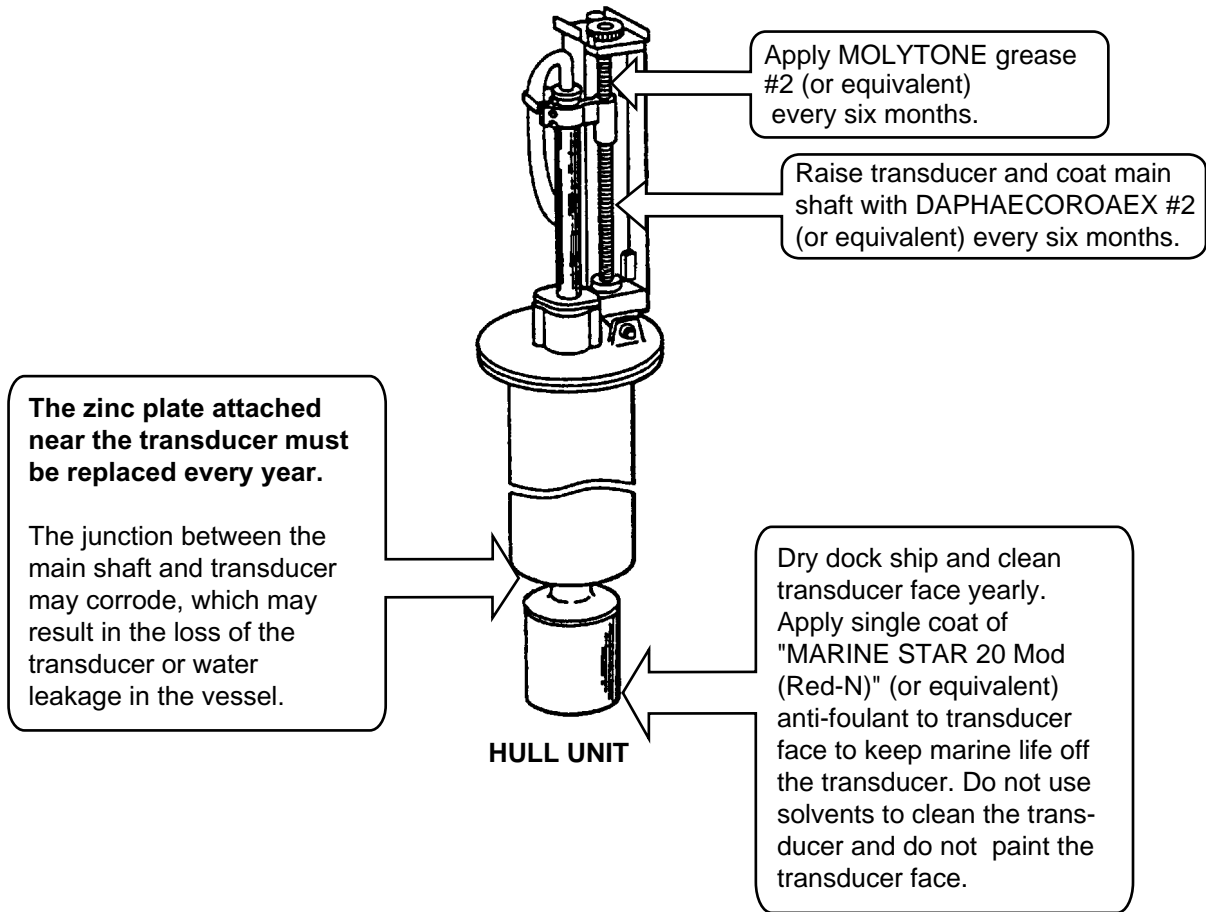

Hull unit maintenance points

8.3.2 Manually raising the transducer

If the transducer cannot be raised automatically, manually raise it as follows:

 CAUTION
<p>Turn off the hull unit before using the hand crank.</p> <p>Bodily injury may result if the power is not turned off.</p>

1. Turn off the hull unit's power switch.
2. Open the gear cover.

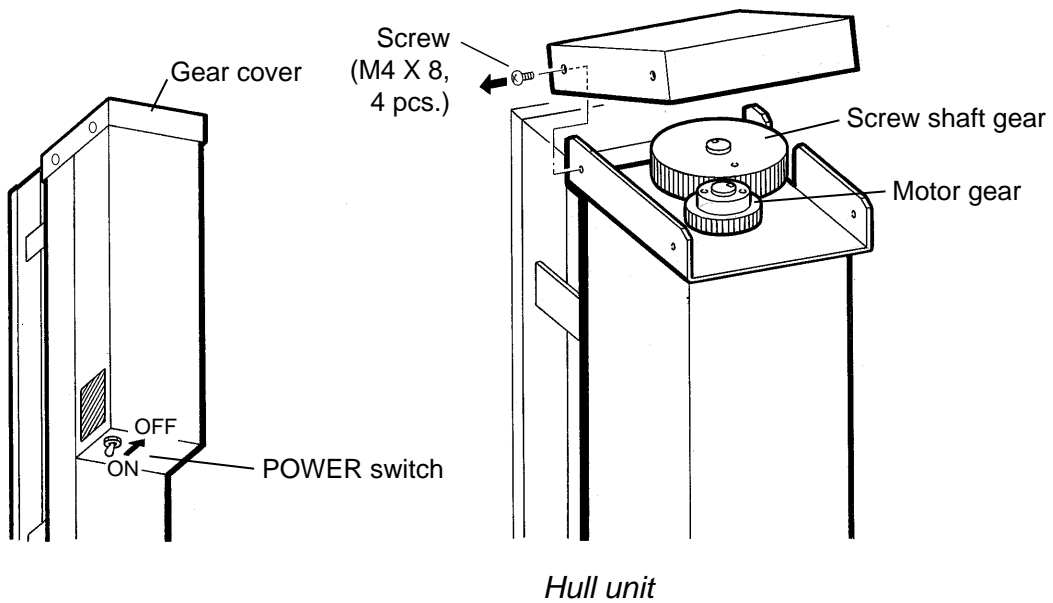

3. Mount the hand crank onto the screw shaft gear or motor gear.

a) Mounting hand crank on screw shaft gear
(Requires greater force but smaller number of turns.)

b) Mounting hand crank on motor gear
(Requires less force but greater number of turns.)

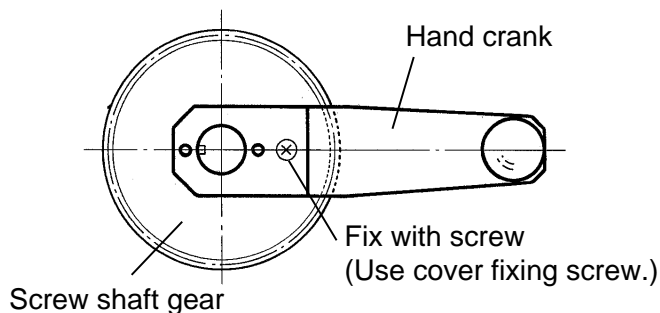

120 turns to move main shaft by 600 mm.

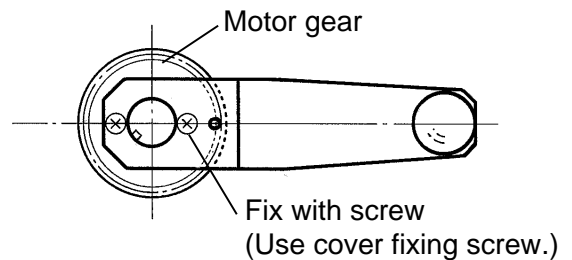

210 turns to move main shaft by 600 mm.

Hand crank

4. Turn the hand crank clockwise to raise the transducer.

8.4 Fuse Replacement

 WARNING
Use the proper fuse.
Use of a wrong fuse can result in damage to the equipment.

The fuses in the processor and transceiver units protect them from overvoltage, equipment fault and reverse polarity of the ship's mains. If the power cannot be applied, first check the fuse for the processor unit. The fuse for the transceiver unit is inside the unit; have a qualified technician check the fuse. If a fuse blows after replacement, or the power cannot be turned in spite of normal fuse, contact your dealer for advice.

Unit	Fuse Type	Code No.
Processor Unit	FGBO-A 2AAC125V	000-549-062
Transceiver Unit (100 VAC spec.)	FGMB 2A 250V	000-122-000
	FGBO 7AAC125V	000-549-013
Transceiver Unit (220 VAC spec.)	FGMB 2A 250V	000-122-000
	FGBO 4AAC250V	000-546-707

8.5 Fan Replacement

The processor unit has a fan, and its life is about 25,000 hours, in ambient temperature of 50°C.

If the fan stops, because the area around the power supply is too hot, the power voltage may fluctuate. Contact a FURUNO agent or dealer to request replacement of the fan.

	Type	Code No
Fan	109-180	000-105-416

8.6 Troubleshooting

The table below provides common symptoms of equipment troubles and the means to rectify them.

Symptom	Check, Remedy
Cannot turn on the power	<ul style="list-style-type: none"> • Check power cable. • Check ship's mains. • First check the fuse in the processor unit. If it is OK, have a qualified technician check the fuse in the transceiver unit.
Bottom echo becomes irregular	<ul style="list-style-type: none"> • Rough seas. Distance to the bottom changes due to rolling and pitching. • Long range selected. Transmission period is longer so ship's pitching and rolling are apt to affect detection of echo.
Weak echo	<ul style="list-style-type: none"> • Output power set to minimum. Set TX OUTPUT (SONAR menu) to maximum. • Excessive TVG. Readjust TVG NEAR and FAR on the SONAR menu.
Somewhat strange color	<ul style="list-style-type: none"> • Brilliance too low. Adjust display brilliance.
Picture contains noise	<ul style="list-style-type: none"> • Equipment not grounded properly. Check equipment ground. • Power cable is too close to the signal cable. Relocate power cable or signal cable. • Debris may be on sea surface. Reject unwanted noise with the interference rejector on the SONAR menu.
Picture does not change when tilt angle is changed	<ul style="list-style-type: none"> • Problem in tilt mechanism or control line. Contact a FURUNO agent or dealer for advice.

8.7 Error Messages

The table below shows the error messages which may appear on the display. All error messages are accompanied by the audio alarm, which you may silence with the [R/B] key.

Error messages

Message	Meaning, Remedy
Overvoltage	
OVERVOLTAGE RETRACT TRANSDUCER AND TURN OFF POWER. PRESS [R/B] KEY TO CLEAR ALARM.	Excessive voltage detected. The message flashes and the audio alarm sounds. Retract the transducer and then turn off the power. Press the [R/B] key to silence the audio alarm. Have a technician check the set.
Transducer not retracted	
TRANSDUCER NOT RETRACTED CUT OFF POWER LINE TO PROCESSOR AND POWER SUPPLY. PRESS [R/B] KEY TO CLEAR ALARM.	If the transducer is not retracted into the tank in approx. 35 seconds after the [↑] key is pressed, the message flashes and the audio alarm sounds. Press the [R/B] key to silence the audio alarm. Raise the transducer manually, following paragraph 8.3.2.
High speed	
WARNING MAX ALLOWABLE SPEED FOR EXTENDED TRANSDUCER IS 16 KT. MAX ALLOWABLE SPEED DURING RAISING/LOWERING TRANSDUCER IS 16 KT. PRESS [R/B] KEY TO CLEAR ALARM.	Ship's speed is higher than 16 knots when you attempted to lower or retract the transducer. The message flashes and the audio alarm sounds. Press the [R/B] key to silence the audio alarm. Reduced speed to less than 16 knots, and the previously used display appears. If you attempt to lower the transducer when the speed is higher than 16 knots the message flashes and the audio alarm sounds. (The transducer is neither raised nor lowered.)
WARNING TRANSDUCER IS KEPT EXTENDED REDUCE SHIP'S SPEED AND PRESS ↑ TO RETRACT TRANSDUCER. ACTIVATING AUTOMATIC RETRACTION. PRESS [R/B] KEY TO CLEAR MESSAGE.	Ship's speed is higher than 18 knots with the transducer extended. The message flashes and the audio alarm sounds. Press the [R/B] key to silence the audio alarm. Lower speed below 18 knots, and the previously used display appears.
Automatic retraction	
ACTIVATING AUTOMATIC RETRACTION PRESS [R/B] KEY TO CLEAR MESSAGE.	Transducer is being retracted because ship speed set for automatic retraction has been reached. (The message appears if AUTO RETRACT in the SYSTEM menu is turned on.) Press the [R/B] key to clear the message.

8.8 Diagnostic Tests

This unit has 10 diagnostic tests (eight with the CSH-8L) which check it for proper performance. Although the tests are designed primarily for use by the service technician, they can also be executed by the user to identify defective components. However, never attempt to check inside the unit; there are no user-serviceable parts inside. Any repair work is best left to a qualified technician.

8.8.1 Choosing a diagnostic test

1. Press the [MENU] key to open the menu.
2. Use the [RANGE] control to choose [MENU MODE].
3. Use the [GAIN] control to choose SYSTEM.

** SYSTEM MENU **		(RANGE CTRL: U/D, GAIN CTRL: L/R)			
[MENU MODE]	:	SONAR	SOUNDER	MARKS	SYSTEM
DIMMER	:	10			
DISP SELECT	:	TEMP	CURRENT		
HEADING ADJ	:	0°			
AUTO RETRACT	:	OFF	(OFF, 5-16kt)		
SPEED MESSAGE	:	ON	OFF		
EXT KP SYNC	:	OFF	ON		
AUTO TRAIN SPD	:	LOW	HIGH		
AUTO TILT SPD	:	LOW	HIGH		
UNIT	:	METERS	FEET	FATHOMS	PA/BRA
SHIP'S SPD/BR	:	LOG/GYRO	CURRENT	NAV DATA	GYRO+NAV
LOG PULSE	:	200	400		
PORT1 BAUDRATE	:	19200	9600	4800	2400
PORT1 FORMAT	:	NMEA	CIF		
PORT2 BAUDRATE	:	19200	9600	4800	2400
PORT2 FORMAT	:	NMEA	CIF		
NAV DATA	:	GPS	LC	DR	ALL
COMBI SCALE	:	RIGHT	LEFT		
SUB TEXT INDI	:	OFF	ON		
LANGUAGE	:	ENGLISH	(JAPANESE)	ESPAÑOL	DANSK
		NEDERLND	FRANCAIS	ITALIANO	(KOREAN)
		NORSK			
TEST	:	SINGLE	CONTI	PANEL	COLOR
	:	PATTERN	SIO	ECHO-1	ECHO-2
	:	ECHO-3	ECHO-4		
SET TO DEFAULT	:	EXECUTE			
PRESS [MENU] KEY TO EXIT					

4. Use the [RANGE] control to choose TEST.
5. Use the [GAIN] control to choose a test.
6. Press the [EVENT] key to execute the test.
7. To quit a test, press the [MENU] key.

8.8.2 Description of diagnostic tests

Single test, Conti(nuous) test

The single and conti(nuous) tests check the ROMs and RAMs for proper operation, one time or continuous, respectively. After the test is completed, the results are indicated as OK (normal operation) or NG (malfunction), to the right of the device checked. For the single test, normal operation is restored after completion of the test. When the [MENU] key is pressed in the continuous test, the equipment goes into start up condition.

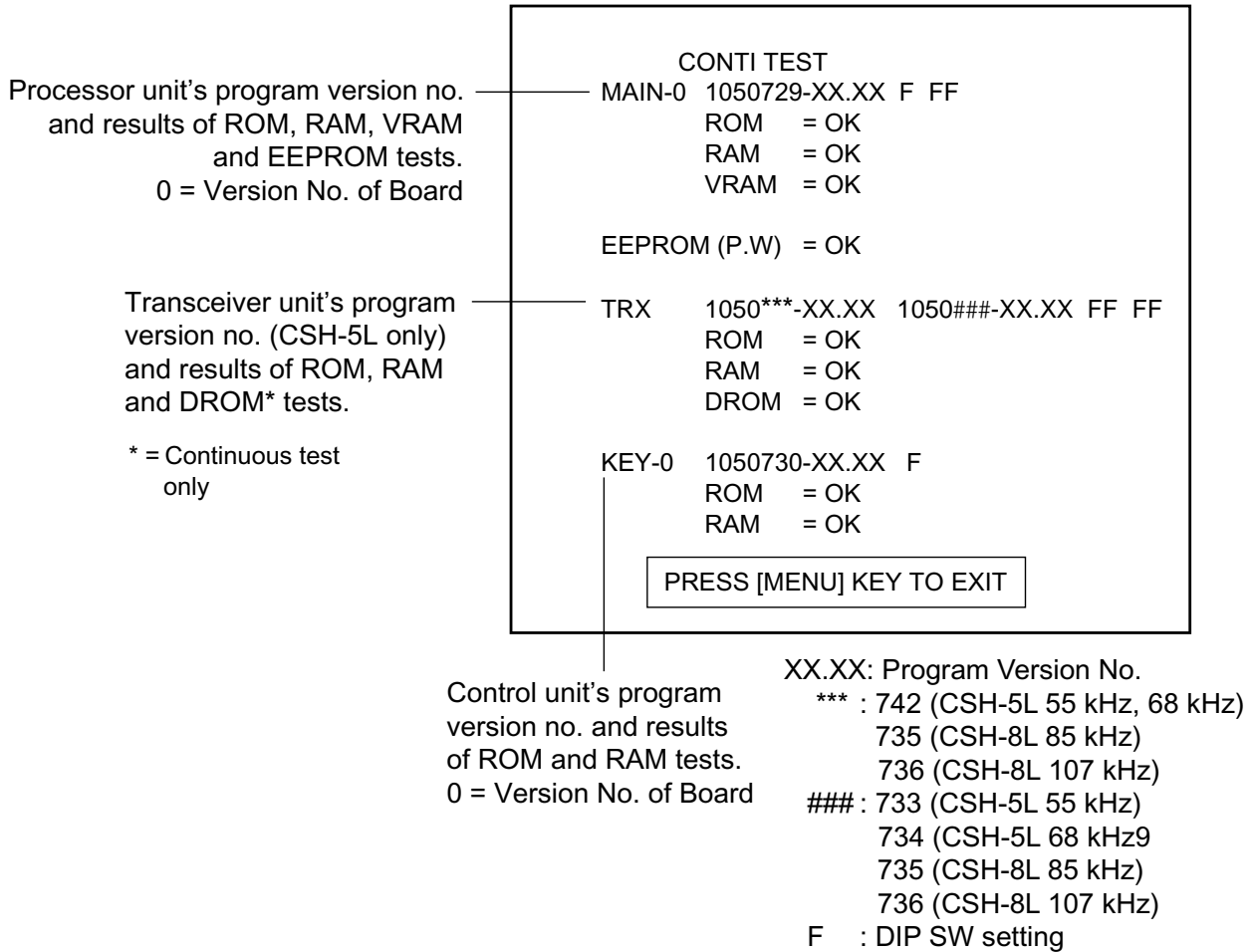

Continuous test (example: CSH-5L, 55 kHz transducer)

Panel test

The panel test checks the controls on the control unit for proper operation.

1. Press a key. If the key is normal, "1" is shown at the key's on-screen location when the key is pressed; "0" when it is released. (The POWER switch cannot be checked.)
2. Operate the TILT lever. If the lever is normal, "1" appears when increasing the tilt angle, "2" when decreasing the tilt angle and "0" when the lever is released.
3. Operate the trackball. Its X-Y coordinate changes with trackball rotation. The coordinates are "0" until the trackball is operated.
4. Operate the [GAIN] and [RANGE] controls. The on-screen indication is "-1" with counterclockwise rotation and "1" with clockwise rotation.

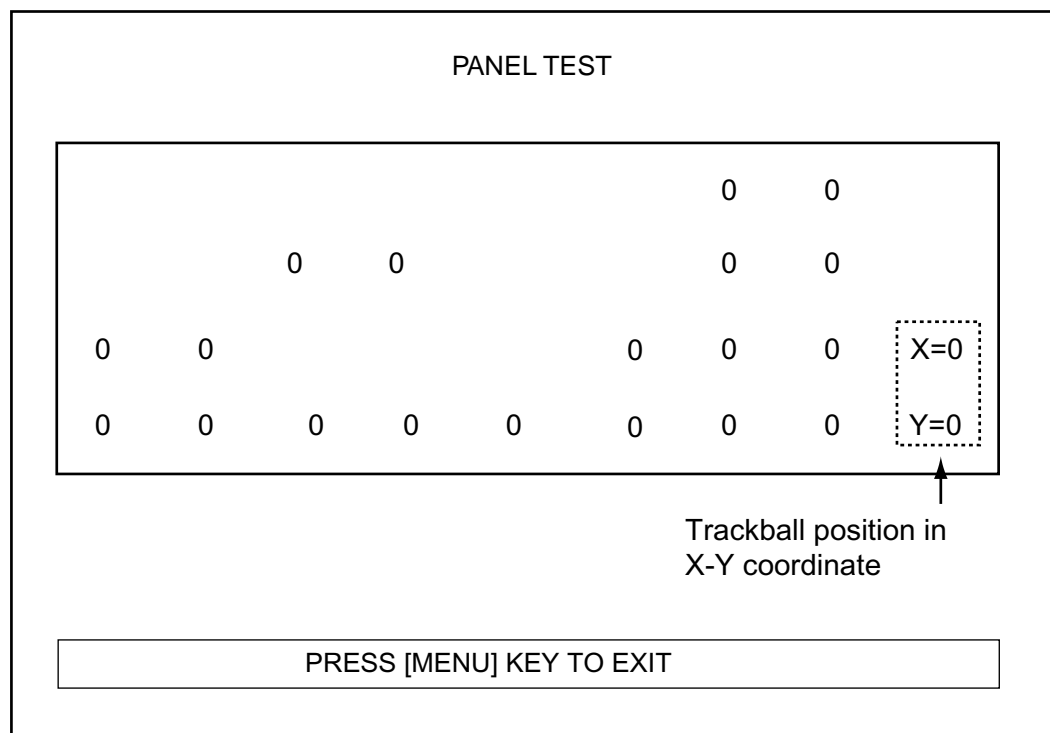

Panel test

Color test

The color test checks for proper display of colors. Press the [EVENT] key to change the screen color, in the order of white, red, green and blue.

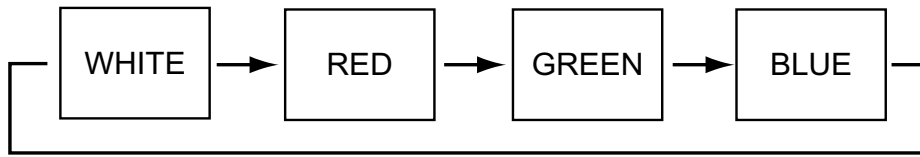

Color test

Pattern test

The pattern test displays concentric rings overlaid on a grid to test for proper display of rings and horizontal and vertical lines.

If the test shows error (for example, no horizontal or vertical lines shown), see the monitor's operator's manual for how to adjust the monitor.

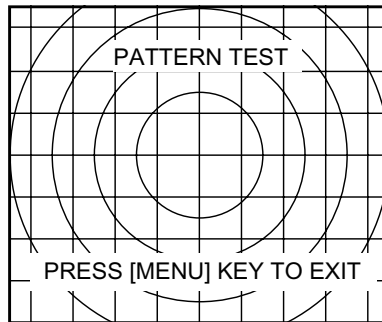

Pattern test

SIO test

This test checks the input/output ports (CN-A1, NMEA1/CIF1, NMEA2/CIF2) of the processor unit. The result for the CN-A1 port is shown as OK or NG (No Good).

The test for the NMEA1/CIF1 and NMEA2/CIF2 ports is for factory use. The result is always NG.

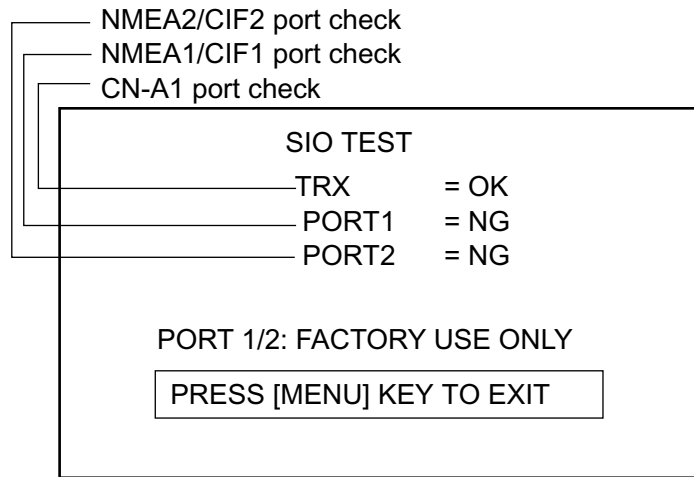

SIO test

Echo tests

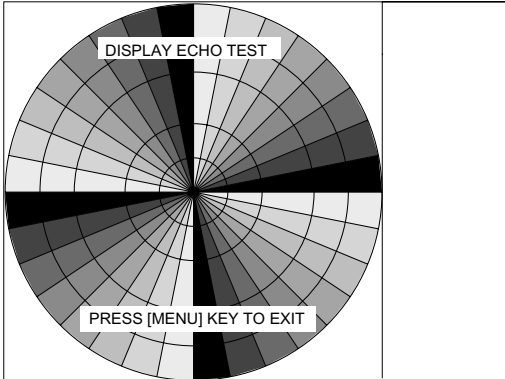
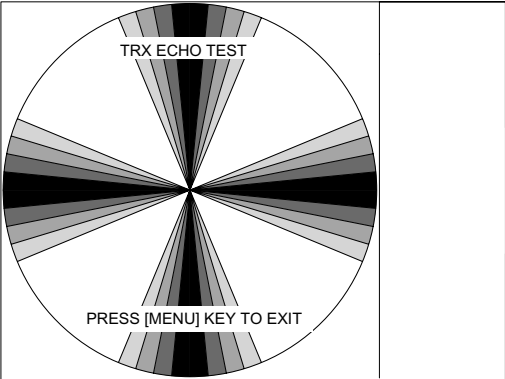
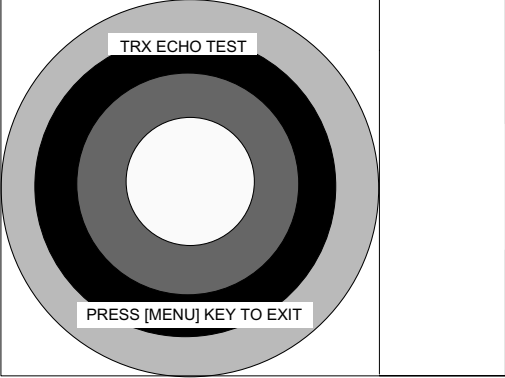
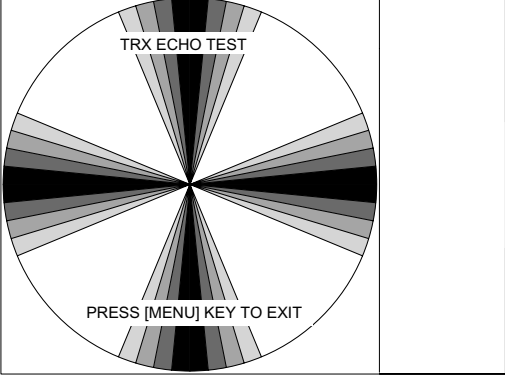
Test	Description	Display
Echo-1	<p>The echo-1 test checks the echo display function of the monitor for proper operation, emitting artificial scan signals in 16 colors. If conducted with the COMBI-2 mode active, artificial echoes are shown in the echosounder display to test the ES interface.</p>	
Echo-2	<p>The echo-2 test checks the TVG function on the PSW Board in the transceiver unit for proper operation. When the [MENU] key is pressed, the equipment goes into start up condition.</p> <p>Note: For the CSH-8L, on the SONAR menu, set NOISE LIMITER to "0" and HOR BEAMWIDTH to "WIDE" before conducting this test.</p>	
Echo-3	<p>The echo-3 test checks the analog multiplexer on the PSW Board in the transceiver unit for proper operation. This test is not available with the CSH-8L. When the [MENU] key is pressed, the equipment goes into start up condition.</p>	
Echo-4	<p>The echo-4 test checks the BMF Board in the transceiver unit for proper operation. This test is not available with the CSH-8L. When the [MENU] key is pressed, the equipment goes into start up condition.</p>	

Echo tests

SPECIFICATIONS OF COLOR SCANNING SONAR CSH-5L/8L

1 PROCESSOR UNIT

- | | | |
|-----|---------------------|---------------------------------------------------------------------------------------------------------------------------------------------------------|
| 1.1 | Display Mode | Single scan
Echo sounder combination (single scan and echo sounder)
Audio combination (single scan and audio pictures) |
| 1.2 | Colors | Scan/echo: 16 colors, mark: 1 color |
| 1.3 | Mark | Own ship's track, Heading line, Direction/distance, Fish school, Event, Target lock |
| 1.4 | Alphanumeric Data | |
| | Sonar Picture | Range, tilt angle, gain |
| | Trackball Mark | Slant range, horizontal range, depth, bearing |
| | Event Mark | Horizontal range, depth, first event marked depth, bearing |
| | Bearing/Range Mark | Bearing, range |
| | Own Ship's Position | Latitude/longitude, LOP |
| | Navigation Data | Ship's speed, bearing, depth, water temperature |
| | Current Data | Current speed and direction |
| 1.5 | Unit | Meter, feet, fathom, P/B |
| 1.6 | Features | Interference rejecter, Afterglow, Noise limiter, Numeric indication
Automatic tilt scanning, Over-voltage Warning,
Unretracted Transducer warning |

2 TRANSCEIVER UNIT

- | | | |
|-----|--------------|------------------------------------------------------------------|
| 2.1 | Transmitter | High power MOS FET amplifier with 11-step power reduction switch |
| 2.2 | Receiver | Low noise superheterodyne, Continuously scanning beam forming |
| 2.3 | Feature | TVG, AGC |
| 2.4 | TX Frequency | |
| | CSH-5L: | 55 kHz or 68 kHz |
| | CSH-8L: | 85 kHz or 107 kHz |

2.5 Range

Basic Range (m)	Range (m)			
	Single		Echo Sounder Combination	
	Offcenter "OFF"	Offcenter "ON"	Offcenter "OFF"	Offcenter "ON"
50	65	80	50	65
85	110	135	85	110
100	130	160	100	130
150	195	240	150	195
200	260	320	200	260
250	325	400	250	325
300	390	480	300	390
350	455	560	350	455
400	520	640	400	520
450	585	720	450	585
500	650	800	500	650
600	780	960	600	780
800	1040	1280	800	1040
1000	1300	1600	1000	1300
1200	1560	1920	1200	1560
1600	2080	2560	1600	2080

Note

- 1) Ranges shown for off-center "on" are maximum value.
- 2) Under certain circumstances, a target (fish school) may not be detected due to its nature or because of sea conditions, even if it is located within the display range.

2.6 Pulse-length 0.5 to 20 ms, interlocked with range (can be changed in 11 steps)

2.7 Pulse Repetition Rate (PRR)

0.25 to 4.4 s, interlocked with range (can be changed in 11 steps)

External synchronized transmission keying

2.8 Audio Search

Method

By built-in loudspeaker

Sector

20°, 40°, 80° and 120° selectable

Output

2 W

Frequency

800 Hz (CSH-5L), 1 kHz (CSH-8L)

3 HULL UNIT

3.1 XDCR travel 600 or 400 mm, selectable

3.2 Raising/lowering Time 400 mm: 14 s, 600 mm: 20 s

3.3 Driving System Remote electric control

3.4 Allowable Ship's Speed 18 knots max. (16 knots during raise/lower operation)

4 INTERFACE

- 4.1 Input Data NMEA 0183 Ver1.5/2.0/2.2
GGA, RMC, GLL, VHW, VTG, HDG, HDM, HDT, DPT, DBT, DBS,
CUR, VDR, GLC, GTD, MTW, RMA
- 4.2 Log, E/S, KP Speed log pulse (contact signal): 200/400 pulse/NM
Sonde, E/S signal: VI-1100A applicable
External KP: Current loop, 0 to 12V
- 4.3 Output Data NMEA 0183 Ver1.5/2.0/2.2
TLL
- 4.4 Video Signal Output
Method RGB analog, separated synchronization, XGA (VESA)
Resolution 1024 x 768, 65.0 MHz clock
Frequency of Vertical/Horizontal 60 Hz/ 48.36 kHz
Connector D-sub15P-female
- 4.5 CIF Data Input Location, Ship's Speed, Bearing, Current data (1 Layer),
Water depth, Water temperature, Multiple layer current data

5 POWER SUPPLY

- 5.1 Processor Unit 100/115/200/220/240 VAC, 1 phase, 50-60 Hz
CSH-5L: 100/115/200 VAC: 4.0A, 200/220/240 VAC: 2.0A
CSH-8L: 100/115/200 VAC: 4.5A, 200/220/240 VAC: 2.2A
- 5.2 Inverter Required for 24 VDC

6 ENVIRONMENTAL CONDITION

- 6.1 Ambient Temperature 0°C to +50°C
- 6.2 Relative Humidity 95% at 40°C
- 6.3 Waterproof
Processor Unit/ Control Unit: IPX2 (w/o connector panel of processor unit)
Others: IPX0
- 6.4 Vibration IEC 60945

7 COATING COLOR

- 7.1 Processor Unit 2.5GY5/1.5
- 7.2 Control Unit N3.0
- 7.3 Transceiver Unit 2.5G7/2
- 7.4 Hull Unit Newton No.4, others

This page is intentionally left blank.

MENU TREE

Default settings shown in bold italics. The menu item “[MENU MODE],” which chooses a menu, is shown at the top of each menu.

Sonar menu

[MENU] key	—	DISPLAY MODE (COMBI-1, <i>NORM</i> , COMBI-2)
(SONAR	—	TX OUTPUT (0-10, <i>8</i>)
selected from	—	PULSE LENGTH (0-10, <i>8</i>)
MENU MODE)	—	TX CYCLE (0-10, <i>10</i>)
	—	TVG NEAR (0-10, <i>6</i>)
	—	TVG FAR (0-10, <i>7</i>)
	—	AGC (0-10, <i>2</i>)
	—	2ND AGC (0-10, <i>1</i>)
	—	NOISE LIMITER (0-10, <i>3</i>)
	—	COLOR CURVE (1, 2, <i>3</i> , 4)
	—	COLOR RESPONSE (1, 2, <i>3</i> , 4)
	—	DELETE COLOR (0-10, <i>0</i>)
	—	ECHO AVERAGE (0-3, <i>1</i>)
	—	INT REJECT (0-3, <i>1</i>)
	—	HOR BEAMWIDTH (WIDE, <i>NARROW</i>)
	—	VER BEAMWIDTH (<i>WIDE</i> , NARROW)
	—	COLOR (<i>1</i> , 2, 3, 4)
	—	ERASE MARKS (TRACK, SHIP, EVENT, FISH)
	—	ALARM LEVEL (0-14, <i>9</i>)
	—	AUTO TRAIN (ON, <i>OFF</i>)
	—	TRAIN SECTOR ($\pm 10^\circ$, <i>$\pm 20^\circ$</i> , $\pm 40^\circ$, $\pm 60^\circ$)
	—	AUTO TILT (ON, <i>OFF</i>)
	—	TILT ANGLE ($\pm 2-10^\circ$, $\pm 4-14^\circ$, <i>$\pm 6-20^\circ$</i> , $\pm 10-26^\circ$)
	—	TRANSMISSION (ON, <i>OFF</i>)
	—	AUDIO VOLUME (0-10, <i>10</i>)
	—	ASSIGN SETTING (F1 KEY, F2 KEY, F3 KEY, F4 KEY)
	—	ASSIGN MENU (EXECUTE)

Sounder menu

[MENU] key	—	COLOR (<i>1</i> , 2, 3, 4)
(SOUNDER	—	RANGE (20-320, <i>160</i> (m))
selected from	—	SHIFT (0-1000, <i>0</i> (m))
MENU MODE)	—	E/S INT REJECT (ON, <i>OFF</i>)
	—	GAIN (0.0-10.0, <i>3.0</i>)
	—	CLUTTER (0.0-10.0, <i>2.0</i>)
	—	ADVANCE (2/1, <i>1/1</i> , 1/2, 1/4, 1/8)
	—	COLOR CURVE (LINEAR, 1, <i>2</i> , 3)
	—	DELETE COLOR (0-19, <i>0</i>)
	—	DRAFT (0.0-10.0, <i>0</i> (m))

MENU TREE

Marks menu

- [MENU] key
(MARKS
selected from
MENU MODE)
- RANGE RINGS (**1/4R**, 1/2R, OFF)
 - BEARING SCALE (**ON**, OFF)
 - CURRENT VECTOR (**ON**, OFF)
 - CURRENT DIR (**TO**, FROM)
 - SHIP'S TRACK (**10R**, 5R, OFF)
 - COURSE (**32CMPS**, 360TRUE)
 - HEADING (**32CMPS**, 360TRUE, OFF)
 - CURRENT DATA (**32CMPS**, 360TRUE, $\pm 180^\circ$, 360°)
 - EVENT/FISH (**32CMPS**, 360TRUE, $\pm 180^\circ$, 360°)
 - OTHER MARKS ($\pm 180^\circ$, 360°)
 - POSITION DATA (**L/L**, TD)

System menu

- [MENU] key
(SYSTEM
selected from
MENU MODE)
- DIMMER (0-10, **10**)
 - DISP SELECT (**TEMP**, CURRENT)
 - HEADING ADJ (0-359°, **0°**)
 - AUTO RETRACT (**OFF**, 5-16 kt)
 - SPEED MESSAGE (**ON**, OFF)
 - EXT KP SYNC (**OFF**, ON)
 - AUTO TRAIN SPD (**LOW**, HIGH)
 - AUTO TILT SPD (**LOW**, HIGH)
 - UNIT (**METERS**, FEET, FATHOMS, PA/BRA)
 - SHIP'S SPD/BR (**LOG/GYRO**, CURRENT, NAV DATA, GYRO+NAV)
 - LOG PULSE (**200**, 400)
 - PORT1 BAUDRATE (19200, 9600, **4800**, 2400)
 - PORT1 FORMAT (**NMEA**, CIF)
 - PORT2 BAUDRATE (19200, 9600, **4800**, 2400)
 - PORT2 FORMAT (**NMEA**, CIF)
 - NAV DATA (**GPS**, LC, DR, ALL)
 - COMBI SCALE (**RIGHT**, LEFT)
 - SUB TEXT INDI (**OFF**, ON)
 - LANGUAGE (**ENGLISH**, Others)
 - TEST (SINGLE, CONTI, PANEL, COLOR, PATTERN, SIO, ECHO-1, ECHO-2, ECHO-3*, ECHO-4*)
 - SET TO DEFAULT :EXECUTE
- * = CSH-5L only

INDEX

2

2ND AGC 2-3

A

AGC 2-2

ALARM ZONE key 3-4

Audio volume 1-17

Auto retraction..... 7-4

Auto tilt..... 1-10

Auto train..... 3-3

B

Beamwidth 2-7

Bearing scale 7-2

C

Clutter 4-4

Color (sonar)..... 1-17

Color curve

 echosounder 4-6

 sonar 1-16

Color response (sonar)..... 1-17

Color test..... 8-10

Continuous test..... 8-8

Control unit..... 1-1

Current vector, direction..... 7-2

D

Default settings 7-4

DELETE MARK key 3-6, 3-8

Deleting marks 3-9

Depth measurement (echosounder mode). 4-3

Diagnostics

 choosing..... 8-7

 color test 8-10

 continuous test..... 8-8

 echo tests..... 8-12

 panel test 8-9

 pattern test..... 8-10

 single test..... 8-8

 SIO test 8-11

DIMMER 1-5

Display mode 1-6

Draft (sonar)..... 4-6

E

Echo average 2-7

Echo tests..... 8-12

Error messages 8-6

EVENT key 3-7

Event marks

 deleting 3-8

 deleting all 3-9

 entering..... 3-7

F

Fan replacement 8-4

Fish alarm..... 3-4

FISH ALARM key 3-4

FISH key..... 3-5

FISH marks

 deleting all 3-9

 deleting individual..... 3-6

 entering..... 3-5

Function keys

 confirming program 3-11

 operating..... 3-10

 programming 3-11

Fuse replacement..... 8-4

G

Gain

 echosounder..... 4-2

 sonar..... 1-9

GAIN control (sonar) 1-9

H

Heading adjustment 7-3

Hull 8-2

I

Interference rejector

 echosounder mode..... 4-4

 sonar..... 2-5

K

Keying pulse 7-4

L

Language..... 7-4

Log pulse 7-4

Free Manuals Download Website

<http://myh66.com>

<http://usermanuals.us>

<http://www.somanuals.com>

<http://www.4manuals.cc>

<http://www.manual-lib.com>

<http://www.404manual.com>

<http://www.luxmanual.com>

<http://aubethermostatmanual.com>

Golf course search by state

<http://golfingnear.com>

Email search by domain

<http://emailbydomain.com>

Auto manuals search

<http://auto.somanuals.com>

TV manuals search

<http://tv.somanuals.com>