

FURUNO

OPERATOR'S MANUAL

COLOR PPI SONAR

MODEL CH-24



FURUNO ELECTRIC CO., LTD.
NISHINOMIYA, JAPAN

©FURUNO ELECTRIC CO., LTD.

9-52, Ashihara-cho,
Nishinomiya, Japan 662

Telephone: 0798-65-2111
Telefax: 0798-65-4200

Your Local Agent/Dealer

All rights reserved. Printed in Japan

FIRST EDITION : JUL 1988
F : AUG. 8, 1997

(TATA)

PUB. No. OME-12690
CH-24





SAFETY INSTRUCTIONS

"DANGER", "WARNING" and "CAUTION" notices appear throughout this manual. It is the responsibility of the operator of the equipment to read, understand and follow these notices. If you have any questions regarding these safety instructions, please contact a FURUNO agent or dealer.



DANGER

This notice indicates a potentially hazardous situation which, if not avoided, will result in death or serious injury.



WARNING

This notice indicates a potentially hazardous situation which, if not avoided, could result in death or serious injury.



CAUTION

This notice indicates a potentially hazardous situation which, if not avoided, could result in minor or moderate injury, or property damage.

WARNING



Do not open the cover of the equipment.

This equipment uses high voltage electricity which can shock, burn, or cause death. Only qualified personnel should work inside the equipment.

Do not disassemble or modify the equipment.

Fire, electrical shock or serious injury can result.

Immediately turn off the power at the ship's mains switchboard if water or foreign object falls into the equipment or the equipment is emitting smoke or fire.

Continued use of the equipment can cause fire, electrical shock or serious injury.

CAUTION

Do not place liquid-filled containers on the top of the equipment.

Fire or electrical shock can result if a liquid spills into the equipment.

Do not place heater near the equipment.

Heat can melt the power cord, which can result in fire or electrical shock.

Do not operate the unit with wet hands.

Electrical shock can result.

Use the correct fuse.

Use of the wrong fuse can cause fire or equipment damage.

Observe maximum allowable ship's speed of 15 knots during operation and 12 knots while raising/lowering transducer.

The zinc block attached to the transducer must be replaced yearly.

The junction between the transducer and main shaft may corrode, which can result in loss of the transducer or water leakage inside the ship.

WARNING Label attached

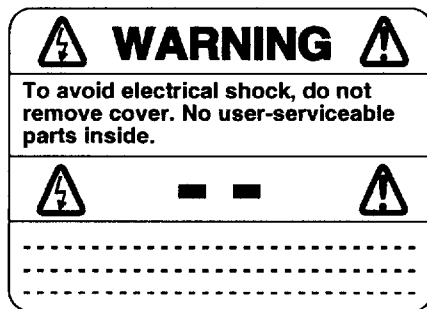

Name : Warning Label (1)
Type : 86-003-1011-0
Code No. : 100-236-230

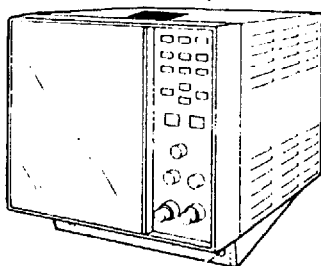

DISPLAY UNIT



TRANSCEIVER UNIT

A WORD TO FURUNO CH-24 OWNERS:

Congratulations on your choice of the FURUNO CH-24 Color PPI Sonar! We are confident that you will enjoy many years of operation with this fine piece of equipment.

For over 30 years Furuno Electric Company has enjoyed an enviable reputation for quality and reliability throughout the world. This dedication to excellence is furthered by our extensive global network of agents and dealers.

The CH-24 Color PPI sonar is developed as the successor of the former monochrome model, FH-106/A. The display of the sonar is presented in eight colors like other Furuno color sounders and sonars. The excellence of its signal processing technique as well as well-suspended sidelobes brings you a clear and high-quality picture on a 10-inch screen. In addition, the historical echo display is always provided in the lower part of the screen. This display may be familiar to the operators used to a graph recording sonar. Bottom fish or reefs, which are normally difficult to discern, may be detected with the use of the historical echo display. Also, the vertical sounding mode is additionally incorporated. The fish school detected on the PPI screen can be identified on this mode when it comes under the boat.

We would appreciate feedback from you, the end-user, about whether we are achieving our purpose.

Thank you for considering and purchasing Furuno equipment.

C O N T E N T S

* * * * *

HANDLING PRECAUTIONS	1
OPERATING CONTROLS	2 to 12
Controls and Functions	2
Indications on the Screen	10
OPERATING PROCEDURE	13
INTERPRETING THE DISPLAY	14 to 21
How the Picture is Composed on the Screen	14
Historical Display Mode	14
Typical Echoes on the Screen	16
EXAMPLE OF ACTUAL PICTURES	22
HOW TO OBTAIN QUALITY PICTURES	23 to 26
HINTS FOR FISHING	27
MAINTENANCE AND GENERAL NOTES	28 to 30
DIAGNOSTIC SELF-CHECK	31 to 32
 =APPENDIX= 	
SPECIFICATIONS	AP-1
CHANGING SPECIFICATIONS	AP-3
CHARACTERISTICS OF THE ULTRASONIC WAVE IN WATER	AP-6

HANDLING PRECAUTIONS

Keep all magnetic materials away.

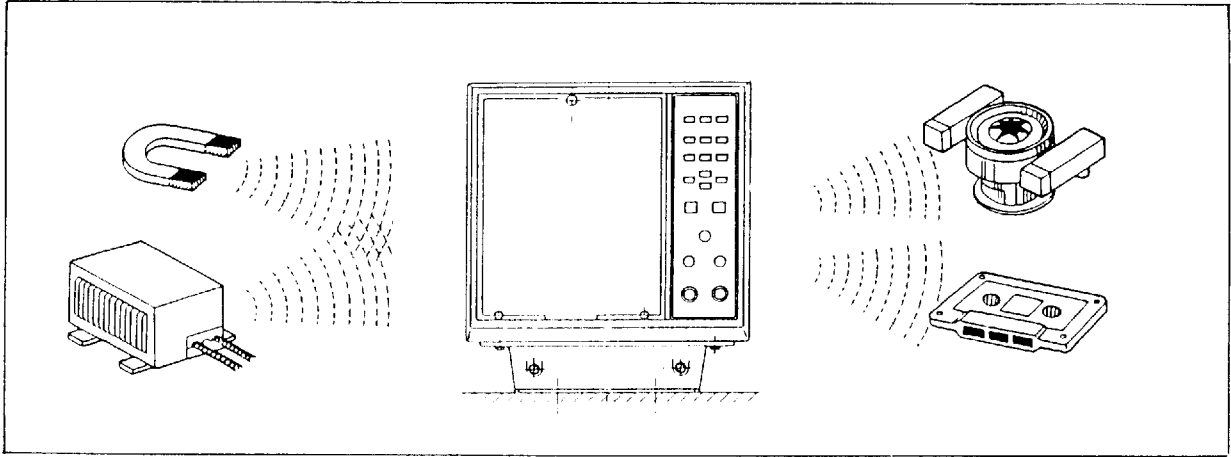

Allow service/ventilation space.

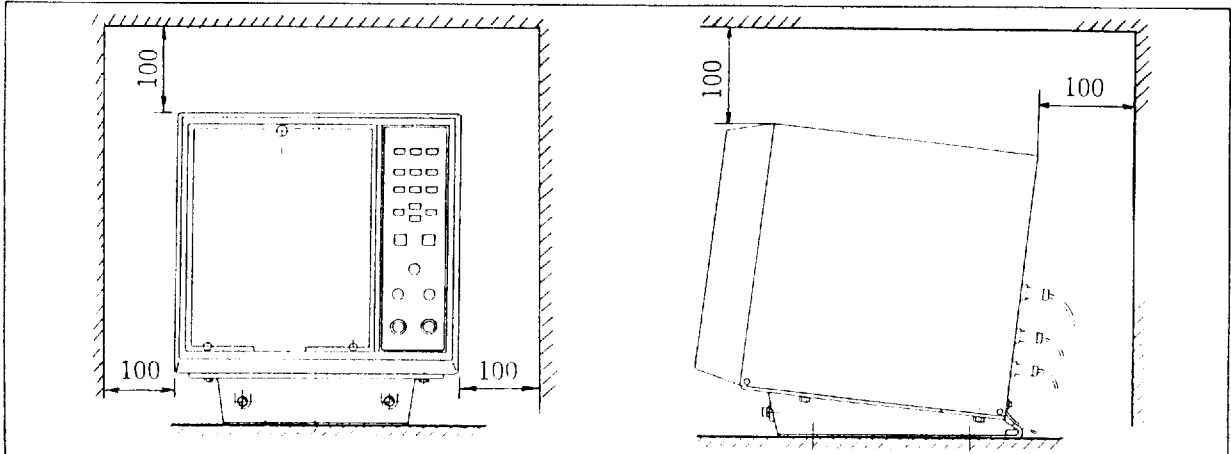

Do not increase brightness too much.

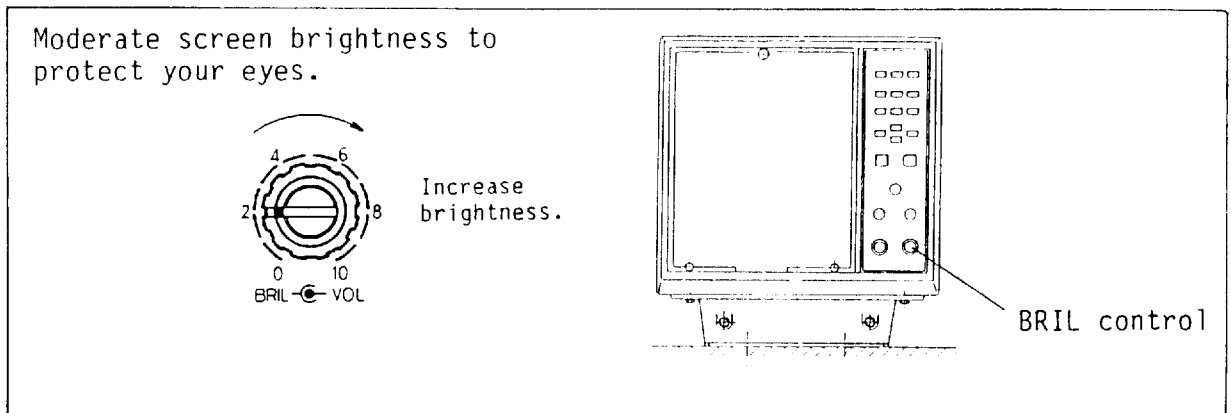

CH-24 stops transmission/training for 1 to 2 seconds every 10 minutes approximately. This is for tilt operation check and not a trouble.

OPERATING CONTROLS

CONTROLS AND FUNCTION

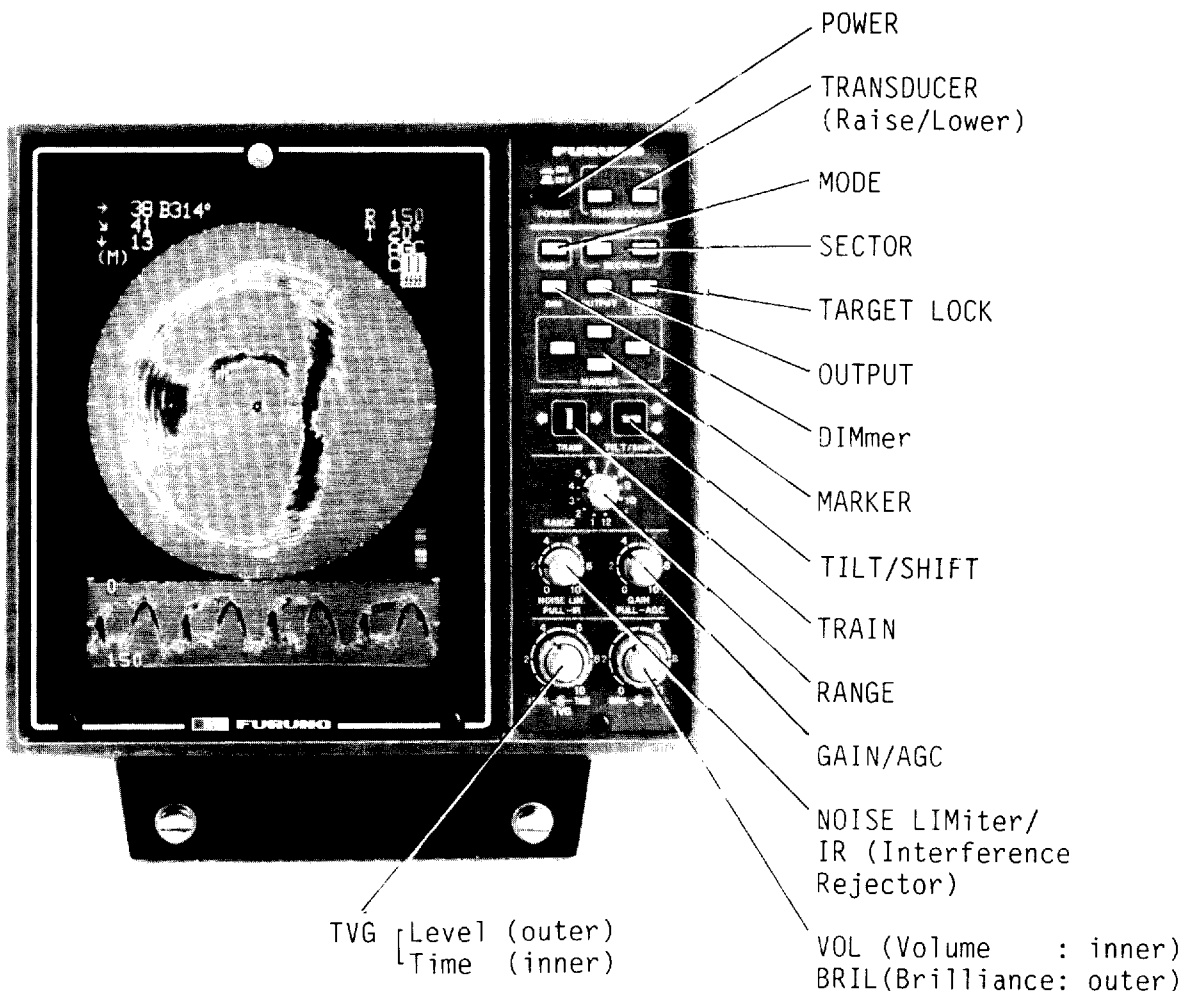

POWER Switch

This switch turns "ON" and "OFF" the power source. Every time power is applied, initial settings will default to the following;

MODE : Mode 1 Scope
 SECTOR : Full circle scope (360°)
 DIM : Bright
 OUTPUT : Max "C"
 TARGET LOCK : "OFF"
 TARGET MARKER: Own ship's position (center)
 TRAIN : Heading (sector center)
 TILT/SHIFT : 0°
 OTHER CONTROLS AND SWITCHES : Same as before power was turned off.

TRANSDUCER switch

These switches are used to raise or lower the soundome. The LED lamps (green for raising, red for lowering) flicker during raising or lowering and light up after completion of operation.

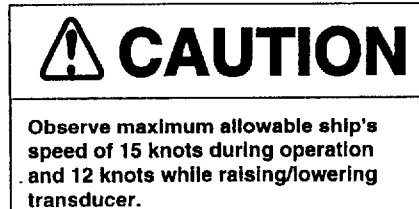

NOTE: Before turning off the POWER switch, do not forget to retract the soundome. The CH-24 is designed so that the soundome is retracted automatically when the power is turned off, even if the soundome is not retracted. Note however that if you turn off the main power switch first, the soundome cannot be retracted.

MODE Switch

Press this switch to select Display Mode 1, 2 or 3.

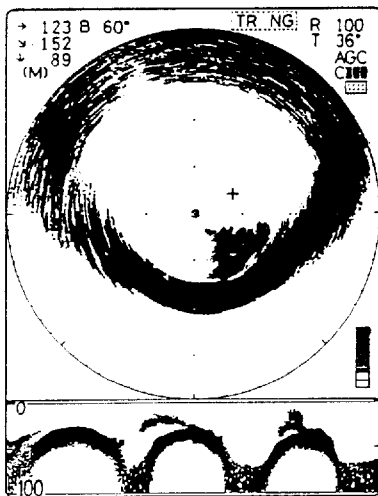

Mode 1 (Initial Setting)

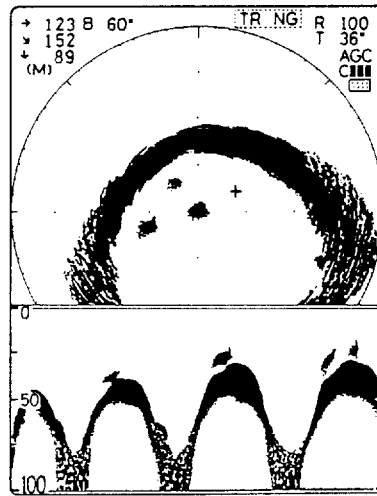

Mode 2

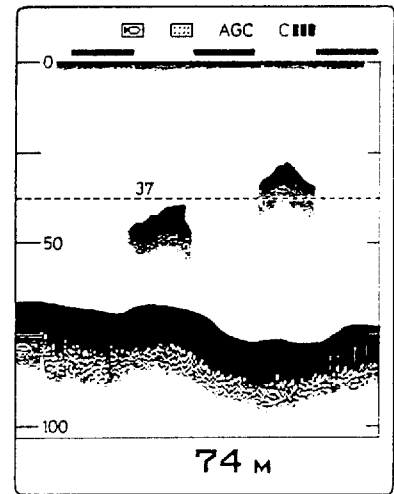

Mode 3

Mode 1: [Full Circle PPI Sonar Display + Historical Display]
Normal full circle picture is displayed at the upper portion of the screen and the historical display picture on the lower portion. To observe the entire area around the ship, select this mode.



Mode 2: [PPI Sonar Display + Expanded Historical Display]
The area of the historical display is expanded twice as large as the one in Mode 1.
This mode is recommended to detect fish mainly in the forward direction.

Mode 3: [Vertical Sounding Display]
When this mode is selected, the transducer is automatically tilted 90 degrees, and the CH-24 works as a vertical sounding echo sounder.

NOTE : The length of the picture displayed in the lower part of the historical display is equal to four full circle pictures approximately. (Information of 240 transmissions is displayed.) This enables you to observe the history of the fish movement, which cannot be readily recognized on the instantaneous PPI display. In other words, you may be able to find fish coming up from the bottom echo with a proper setting of TILT and AGC.

SECTOR Switches



These two switches are used to set the width of the transducer training sector.

	Each press of this switch narrows the training sector by 36°, down to 6° maximum. (360°→324°---→72°→36°→6°)
	Each press of this switch widens the training sector by 36°, up to 360°. (6°→36°→72°---→324°→360°)

The training sector is indicated in degrees for a few seconds at the top of the screen when changing the width. Also the direction of training can be made in both directions except at the 360° setting. For full circle training however the direction is clockwise only.

TRAIN Switch

This switch is used to determine the center direction of the train sector.

	Each press of this switch rotates the center of the train sector clockwise by 6 degrees.
	Each press of this switch rotates the center of the train sector counterclockwise by 6 degrees.

When the switch is pressed and held, the rotating tape is doubled (12 degrees). The bearing angle of the train center is displayed for a few seconds at the top of the screen.

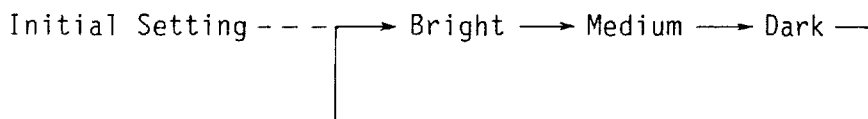

DIMMER switch

This switch adjusts the illumination of the control panel. It is set at the bright position whenever power is turned on. Every time the switch is pressed, the illumination changes in the following sequence.



OUTPUT Switch

The output switch is used to reduce the output power from C to B or A.

C : Maximum power ----- 1.2kW approx. (C ) Display
B : Medium power ----- 120 W approx. (B ) screen
A : Minimum power ----- 12 W approx. (A ) indicator

There are two conditions where a reduction in output power may be beneficial. First, if many ships are operating nearby and operating echo-sounders or sonars at the same frequency as the CH-26, mutual interference may occur. Secondly, when operating in shallow waters a lower output power may help to reduce unwanted echo that a reduction in gain cannot. In either case press the OUTPUT switch to reduce the output power. The output power in use, denoted by a letter and rectangle(s) (see above), is displayed at the upper right side of the screen.

TARGET LOCK Switch

This switch performs different functions depending on display modes.

For Mode 1 and 2 (PPI Sonar + Historical Display)

The target lock function is turned on/off with the switch.

Target Lock Function

The target lock function tracks a fish school appearing in a predetermined target lock zone. Suppose that the hatched area shown at right is the target lock zone and the fish school detected at "A" moves toward "B". In this case, the target lock is activated at "A" and the transducer is trained automatically following the movement of the fish toward "B" so as not to miss it.

Note that the fish school can be tracked only when it moves horizontally. When it moves up and down, it should be tracked by manually changing the tilt. Note also that if the fish school goes out of the zone in the range direction, the tracking is suspended until it or new fish school comes into the zone.

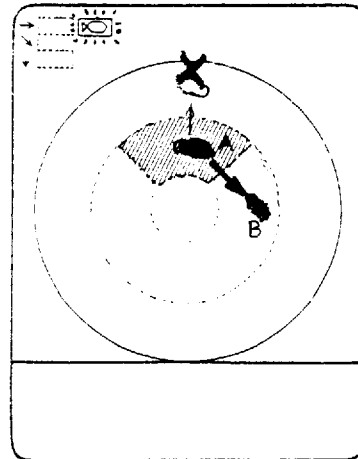

To use the target lock function, take the following steps.

1. Press the TARGET LOCK switch. The target lock indicator () and two zone markers will appear on the screen.

2. Set the target lock zone by moving the zone markers with the MARKER switch. The zone can be set as an area between the two zone markers.
3. The target lock is activated when a fish school displayed in red or red-dish brown is detected in the specified zone, and the red target lock indicator on the screen blinks and the buzzer sounds to call the operator's attention.
4. To turn off the target lock function, press the TARGET LOCK switch again.

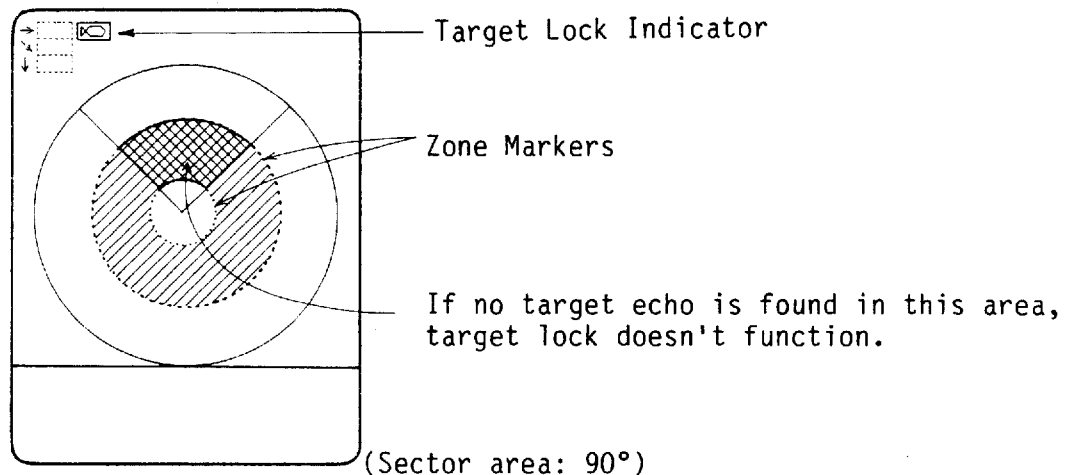

- NOTE: 1. The echo level of the target lock function can be changed to yellow. Refer to page AP-4.
2. The target lock zone should be set so that bottom echoes may not be included in the zone, otherwise the target lock may be activated with bottom echoes.

Target Lock Mode Selection

In the target lock function, two types of tracking modes are available, AREA and EDGE. Select either of them with DIP switch S3 (see page AP-4). The switch is factory-set for the AREA mode.

AREA Mode

The sounding beam is scanned from end to end of the fish school. Namely, the transducer training is reversed at each end of the fish school. The advantage of this mode is that you can observe the size of the fish school continually.

EDGE Mode

The sounding beam tracks either end of the fish school without scanning; the transducer stops training whenever an echo above the red level is detected and trains again when it disappears, resulting that the sounding beam follows the movement of the front or back end of the fish school. Note that the display area is 6° only.

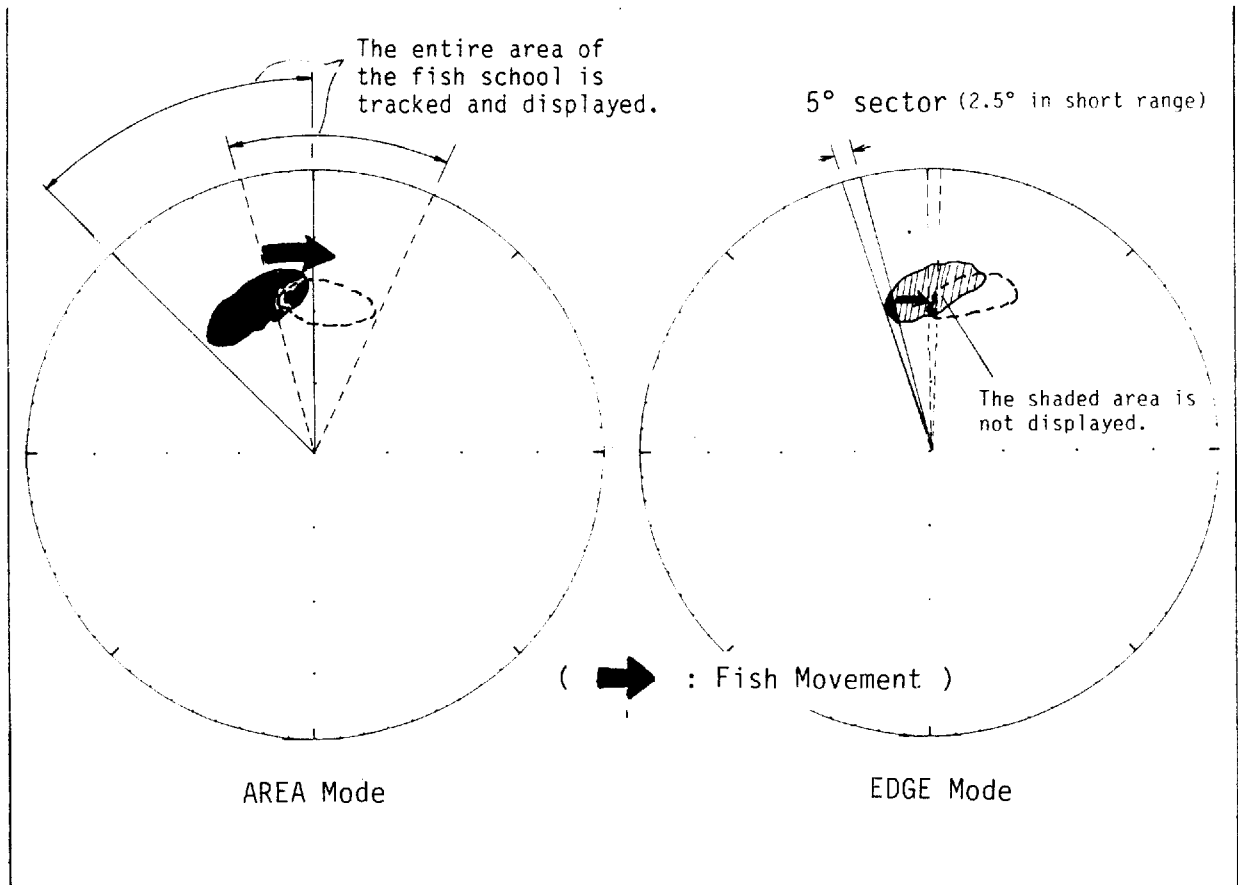

For Mode 3 (Echo Sounder Display)

The alarm function is turned on/off with the TARGET LOCK switch. The alarm function calls operator's attention with audible sound when a fish school is detected.

1. Press the TARGET LOCK switch. The alarm indicator appears at the left top on the screen indicating that the alarm function is activated.
2. Set the alarm zone by moving the VRM marker with the keys of the MARKER switch.
3. The alarm indicator blinks and audible alarm is released when a fish school is detected in red or reddish brown in the alarm zone.

NOTE: The alarm zone should be set so as not to include bottom echoes, which may confusingly activate the alarm function.

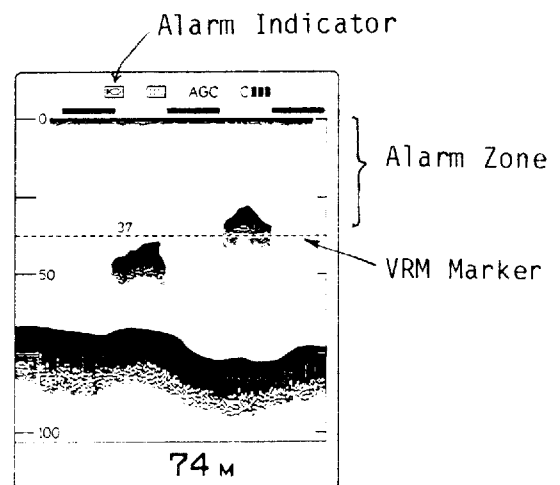

MARKER Switch





For Mode 1 and 2 (PPI Sonar + Historical Display)

These four switches are used to move the "Target Marker" (+) or the two "Zone Markers".

The method to move the marker and the purpose of these switches are;

Target Lock	Marker/ Initial Position	
OFF	Target marker appears at the center of the screen (own ship's position).	<div data-bbox="639 689 898 831" data-label="Diagram"> </div> <p data-bbox="951 689 1374 882">Press any switch to move and put the target marker on the fish echo. The marker moves in the direction indicated by the arrow on the switch.</p> <div data-bbox="635 904 906 1128" data-label="Image"> </div> <p data-bbox="951 913 1374 1106">The horizontal distance, slant distance, depth and bearing relative to ship's heading are displayed at the top left corner of the screen.</p> <p data-bbox="895 1122 1145 1151">"Target Marker" (+)</p>
ON	Zone markers appear at 1/8 and 1/2 of the selected range.	<div data-bbox="619 1178 1299 1357" data-label="Diagram"> </div> <p data-bbox="667 1391 1315 1458">Target lock indicator appears instead of bearing display.</p> <div data-bbox="612 1480 951 1899" data-label="Image"> </div> <p data-bbox="951 1711 1422 1868">Press the key switch to move the two zone markers. This is to select the area (the inner and outer depth) for the target lock function.</p> <p data-bbox="667 1935 1374 2024">For example, using two zone markers, you can exclude the bottom echo for effective fish detection in mid-water.</p>

For Mode 3 (Echo Sounder Display)

  keys are used to move the VRM markers vertically.   keys are not used.

TILT/SHIFT Switch

For Mode 1 and 2 (PPI Sonar + Historical Display)

This switch is used to control the up and down tilt of the transducer.



Pressing upward decreases the tilt angle, up to +5° above horizontal.



Pressing downward increases the tilt angle, down to 90° vertical.

The setting of the tilt angle is made in 1-degree steps and displayed at the upper right corner of the screen.



Tilt Display

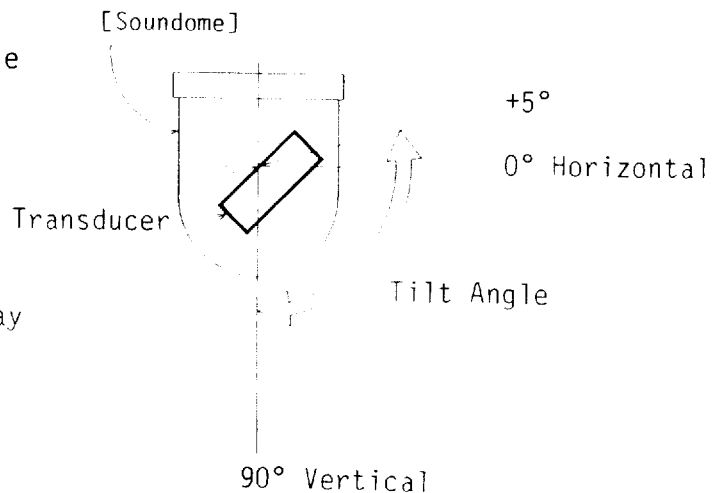

For Mode 3 (Echo Sounder Display)

This switch is used to phase the detection range set with the RANGE switch.



Pressing downward shifts the detection range. Pressing once shifts it by a half of the range scale in use and further pressing shifts it another half.



Upward pressing is used to reset the shifted range setting. Pressing once resets it by a half of the range.

RANGE Switch

This switch is used to select the detection range. Select the range according to either the fish species being searched for or the depth desired. Normally it is set so that the bottom is traced at the lower part of the screen (like an echo sounder). The range selected is shown at the top right-hand side of the screen next to the letter "R". The unit of measurement can be changed by an internal DIP switch. See page AP-3.

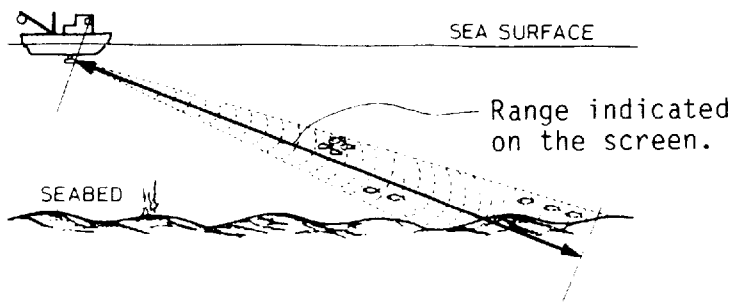

		1	2	3	4	5	6	7	8	9	10	11	12
Range(m)	Standard	30	60	100	150	200	250	300	400	600	800	1200	1600
	Special	50	100	150	200	240	280	320	360	400	450	500	600

"Standard" or "Special" is selected with the internal DIP switch. See page AP-3.

NOISE LIM/IR (Interference Rejector) Control

When low-level noise appears on the screen, turn the NOISE LIM control clockwise to reduce it. With the control in the fully clockwise position noise is eliminated, however weaker echoes (displayed in green, light blue or blue) may go undetected. Therefore, avoid turning the control too far clockwise.

When interference from other echo sounders operating nearby or other electrical noise can be seen on the screen, pull out the IR control to reduce or eliminate the interference. Interference is easily recognizable by its appearance (see right figure). Although the IR is effective in most cases, some forms of interference cannot be reduced or eliminated.

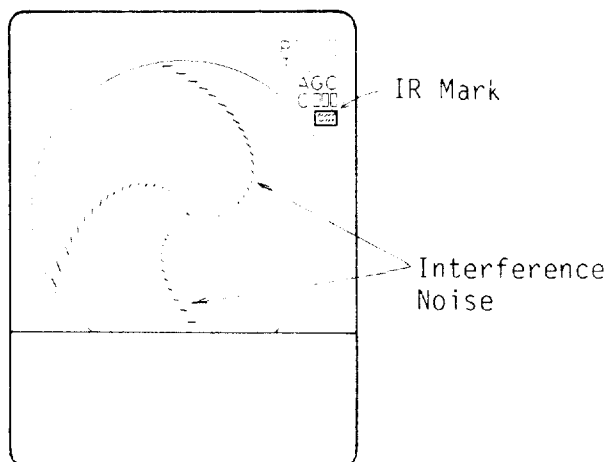

The IR mark is displayed at the right corner of the screen. Switch off the IR when no interference exists.

GAIN/AGC Control

The GAIN control adjusts the sensitivity of the receiver. Turning the control clockwise increases the sensitivity. Normally, the gain is set so that the bottom is displayed in reddish brown mixed with red. When changing the range and tilt settings, readjustment of the gain is required. For normal use, it is recommended to set it around the "5" position.

AGC (Automatic Gain Control) reduces strong seabed returns. This function is helpful to discern fish or wreck (sunken ship) echoes which are normally masked and cannot be identified.

To detect bottom fish, pull out the control. Letters "AGC" appear on the right corner of the screen. For mid-water fish detecting, switch off the control by pushing it in.

TVG controls

TVG compensates for propagation attenuation of ultrasonic waves. This equalizes the echo presentation so that fish schools of the same size appear in the same density in both shallow and deep water. It also helps to eliminate surface noise, which may mask shallow targets.

There are two controls and the function of each is as follows.

TVG level
(outer) Turning this control clockwise reduces (mainly on short ranges) noise caused by strong reflections received off surface turbulence.

TVG time
(inner) The TVG time control is effective up to 1000m. Clockwise rotation extends the effective range. See the figure below.

Notes: 1) For normal use, it is recommended to set the level and time controls as follows.

Level ----- "2" to "5"
Time ----- "5"

2) TVG adjustment is necessary whenever the GAIN is changed.

BRIL/VOL Control

The BRIL control (outer) adjusts the brightness of the CRT picture. To extend the life of the CRT, you are recommended to use a lower setting. The VOL control (inner) adjusts the volume of the external trumpet speaker.

INDICATORS ON THE SCREEN

Mode 1 & 2 (Sonar Mode)

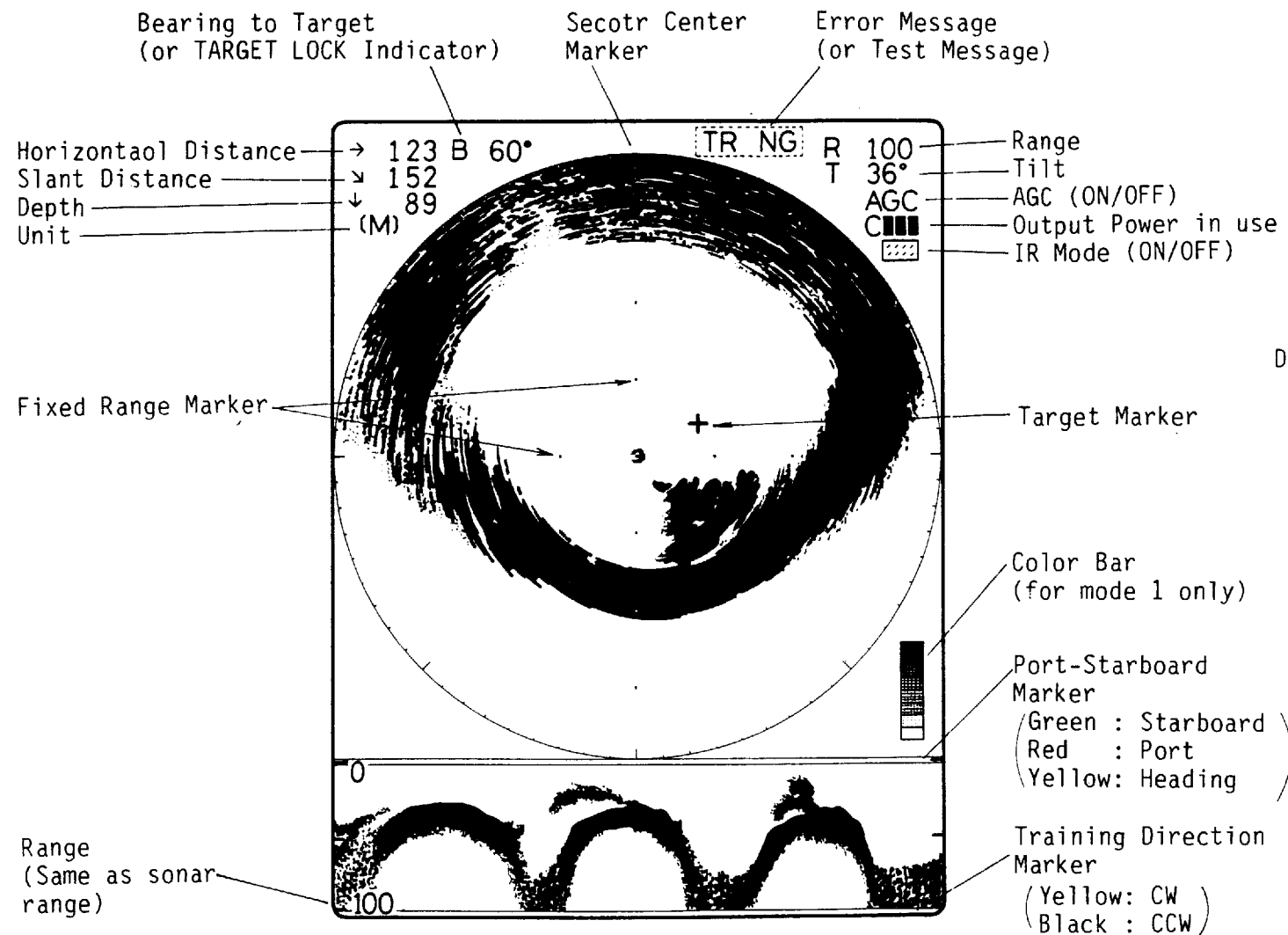

Mode 3 (Vertical Sounding Mode)

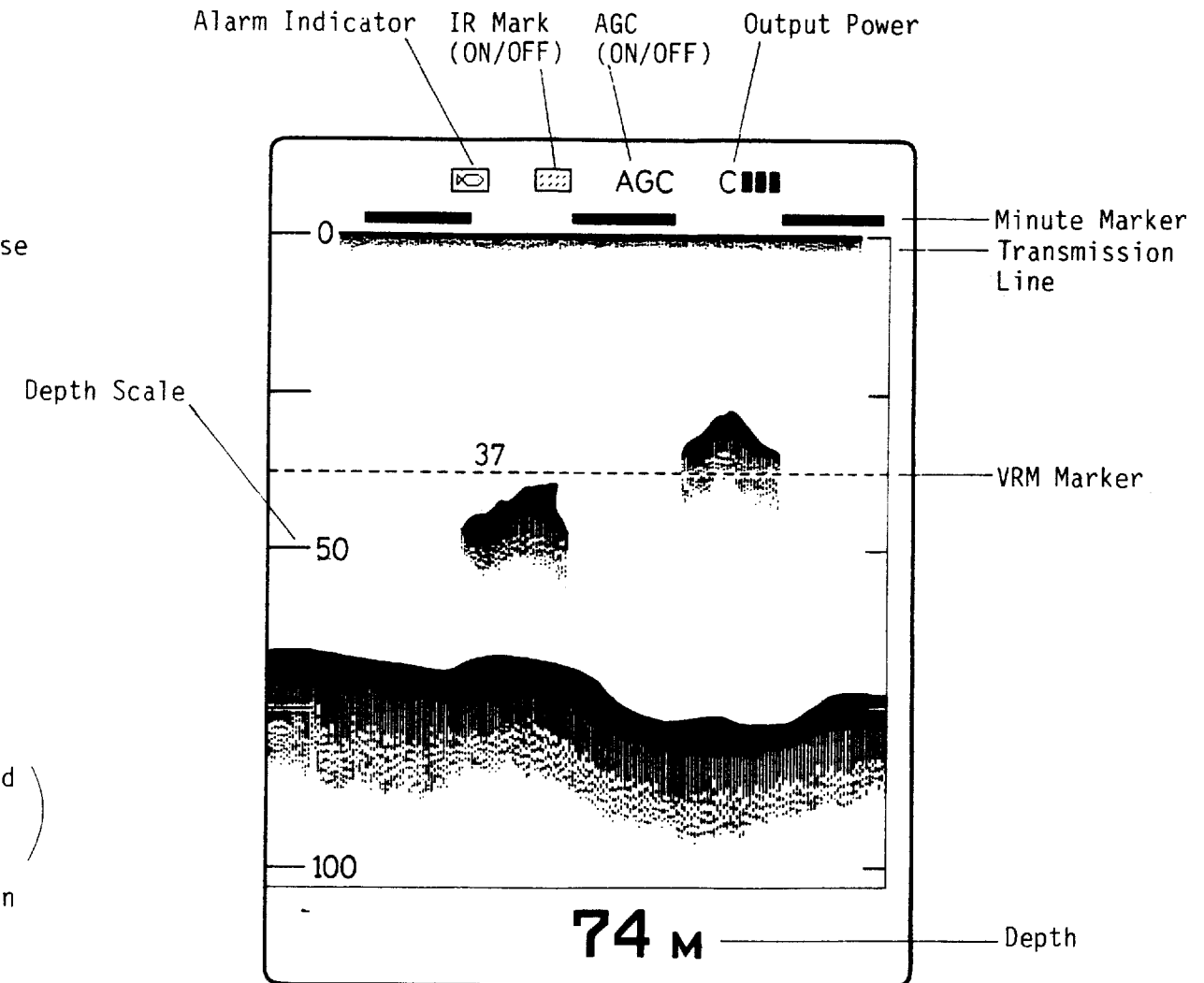

Fish/Bottom Echoes

The color bar at the lower right corner on mode 1 shows the relation between echo intensity and color indication on the screen. The strongest echoes appear in reddish brown or red (upper colors on the bar) and the weakest echoes appear in hues of blue.

Port-Starboard/Training Direction Markers

The port-starboard marker shows the position of the sounding beam in three colors; green for starboard, red for port and yellow for heading. The training direction marker shows the training direction in the sector area, i.e., yellow for clockwise training and black for counterclockwise training.

Target Marker

This white cross marker is used to measure the distance to a target echo with the TARGET LOCK switch being "OFF". When the TARGET LOCK switch is turned on, two Range Ring Markers appear instead of the target marker and the bearing display is also replaced with Target Lock Mark in red or yellow.

Minute Marker

The minute marker is displayed for 30 seconds every minutes.

VRM Marker

This marker is used to accurately measure the depth of fish echoes. When the alarm function is "on", this marker sets the alarm zone; the alarm sounds with fish echoes between the transmission line and the VRM.

OPERATING PROCEDURE

Typical operating procedure of the CH-24 is shown below using the mode 1 and 2 as an example.

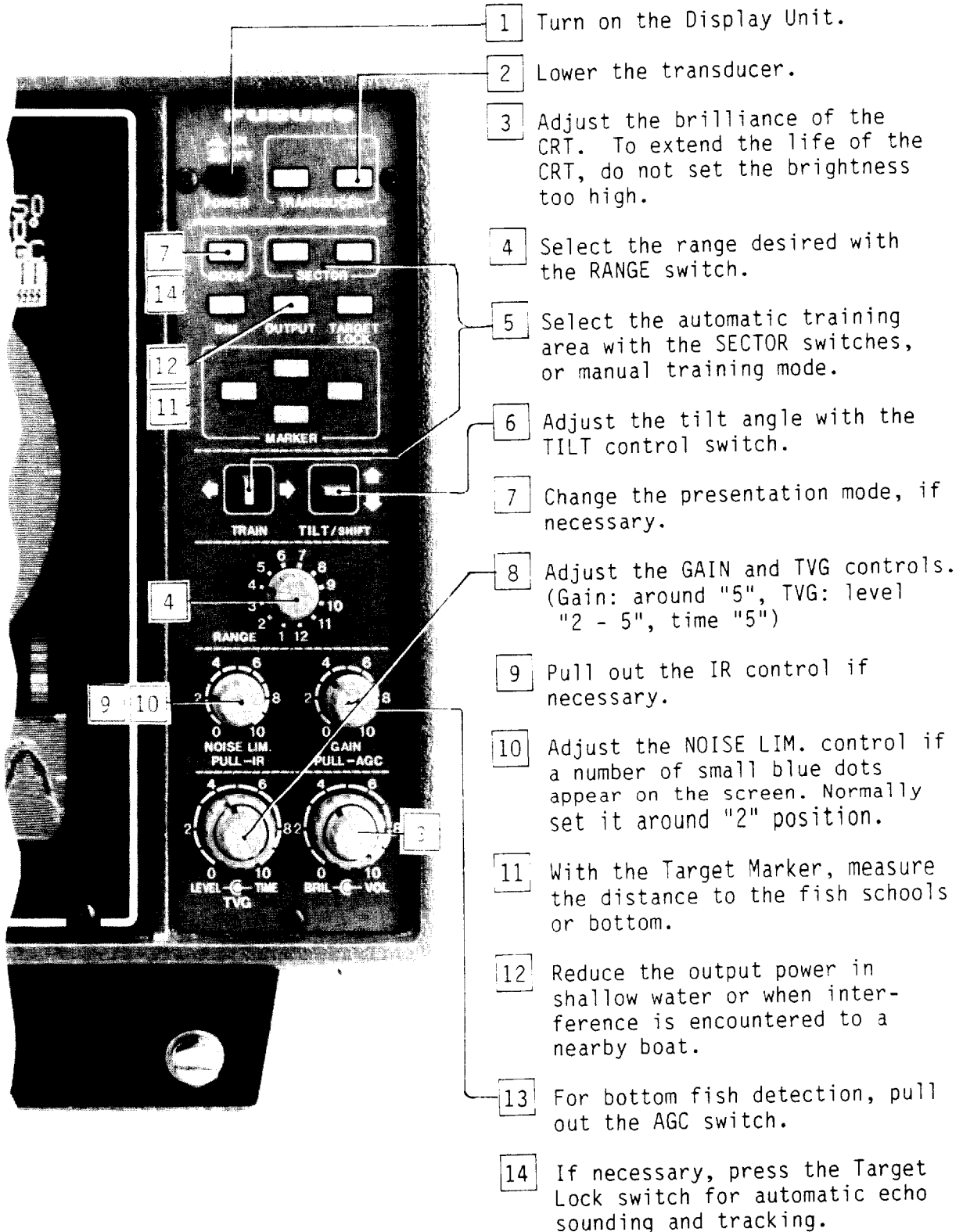

- 1 Turn on the Display Unit.
- 2 Lower the transducer.
- 3 Adjust the brilliance of the CRT. To extend the life of the CRT, do not set the brightness too high.
- 4 Select the range desired with the RANGE switch.
- 5 Select the automatic training area with the SECTOR switches, or manual training mode.
- 6 Adjust the tilt angle with the TILT control switch.
- 7 Change the presentation mode, if necessary.
- 8 Adjust the GAIN and TVG controls. (Gain: around "5", TVG: level "2 - 5", time "5")
- 9 Pull out the IR control if necessary.
- 10 Adjust the NOISE LIM. control if a number of small blue dots appear on the screen. Normally set it around "2" position.
- 11 With the Target Marker, measure the distance to the fish schools or bottom.
- 12 Reduce the output power in shallow water or when interference is encountered to a nearby boat.
- 13 For bottom fish detection, pull out the AGC switch.
- 14 If necessary, press the Target Lock switch for automatic echo sounding and tracking.

INTERPRETING THE DISPLAY

HOW THE PICTURE IS COMPOSED ON THE SCREEN.

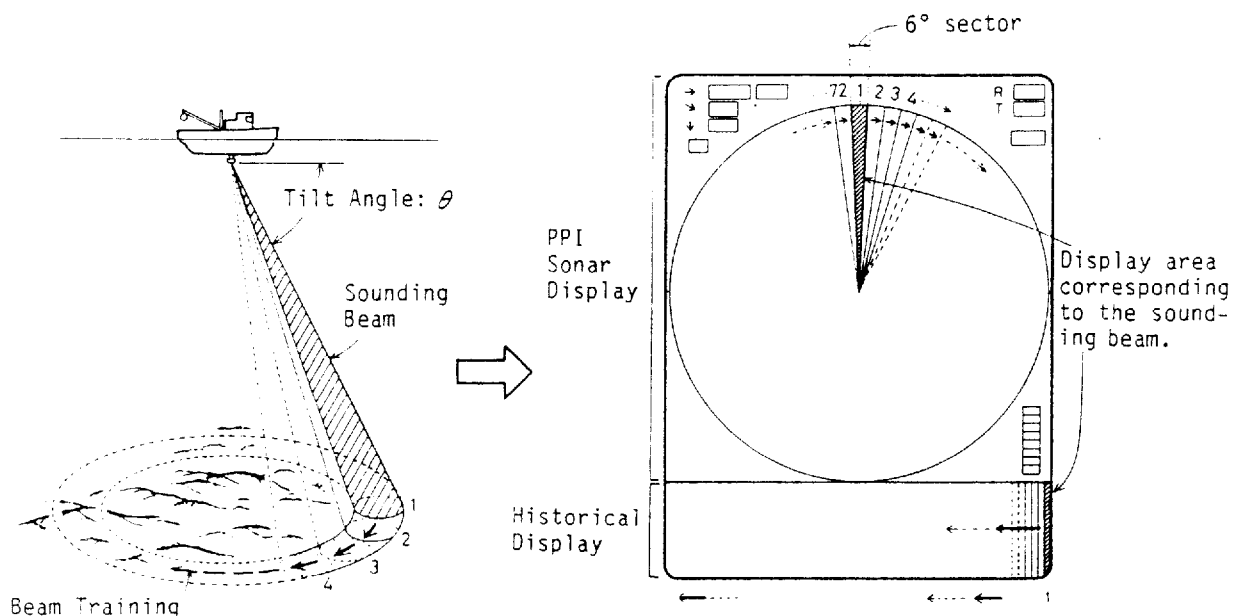

As shown above, the sounding beam is emitted from the soundome at a certain tilt angle. The information (target echoes) obtained by this beam is displayed in 6-degree sectors on the PPI sonar screen and by a series of vertical scan lines like a color sounder in the lower part of the screen. See the hatched areas in the figure. The sonar picture is completed with 60 transmissions ($6^\circ \times 60 = 360^\circ$), and the historical display is completed with 240 transmissions. Provided that the training is performed continuously with tilt, it forms a large sounding area (cone shape), resulting in continuous pictures on both parts of the screen.

HISTORICAL DISPLAY MODE

In the CH-24, the historical display is always provided in the lower part of the screen. (This display is quite similar to the recording of conventional graph recording type sonar.) The features and the expected applications are;

- 1) It can be considered as an echo sounder picture with a tilted transducer.
- 2) It can show as many as the last four complete sonar pictures (360° training of transducer), allowing you to recognize the history of fish school movement/distribution, etc.
- 3) The sounding range is interlocked with the PPI range, but can be doubled in size for closer observation without having to wait for the screen to be updated one ping at a time.
- 4) The identification of weak or intermittent targets, which tend to be ignored on the PPI display, may be possible.

When comparing the historical display with the PPI sonar display, the port-starboard/training direction markers help you to recognize the location of the sounding beam and the corresponding area.

(Refer to page 10 for the port-starboard/training direction makers.)

[Continuous Training Mode; 360°]

The entire PPI screen corresponds to the hatched area in the historical display. This is recognizable from the color indication of the markers.

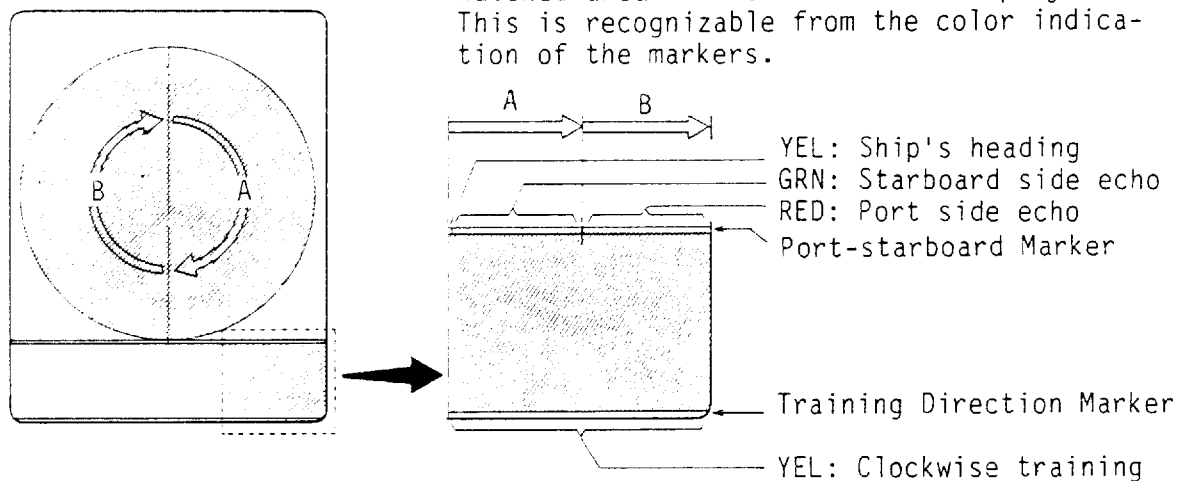

[Training Area; 120°]

120° PPI screen corresponds to the hatched area in the historical display area. This is also recognizable from the color indications.

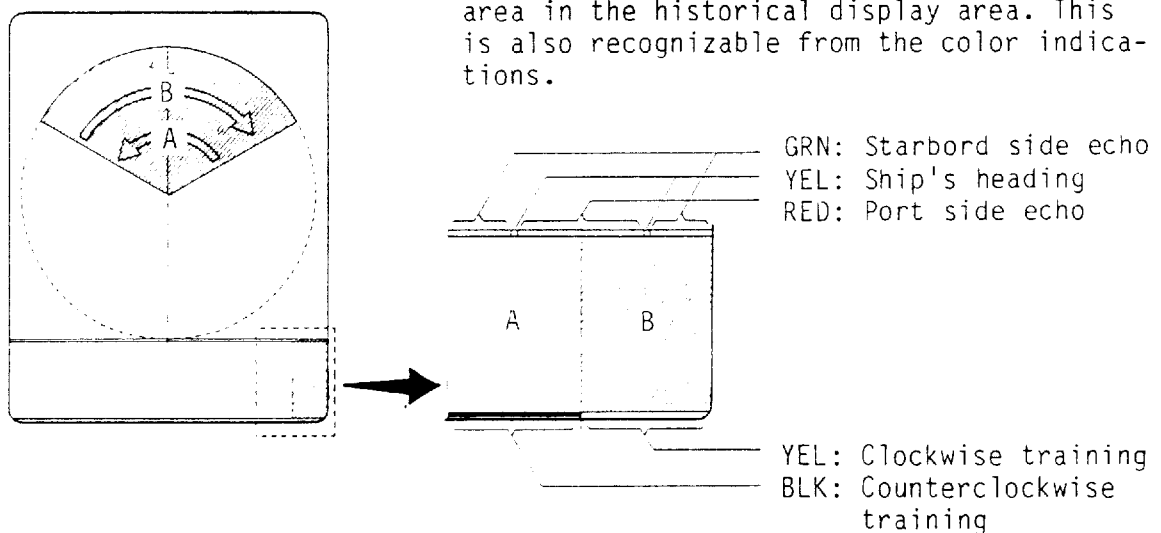

This area is obtained by the former CCW training and cannot be seen on the PPI screen because it has already been renewed.

TYPICAL ECHOES ON THE SCREEN

1. Seabed

When the tilt angle is set at some degrees with a full circle training setting, the picture illustrated below will appear on the screen. The seabed echo is presented on the screen as a thick line which realistically shows the bottom contour. When the tilt angle is decreased, the seabed trace becomes wider and weaker. By observing the seabed condition on the screen, the skipper can prevent the net from being damaged by a reef or a shipwreck.

(a) Flat Bottom

Tilt: 90°
Sector: 360°

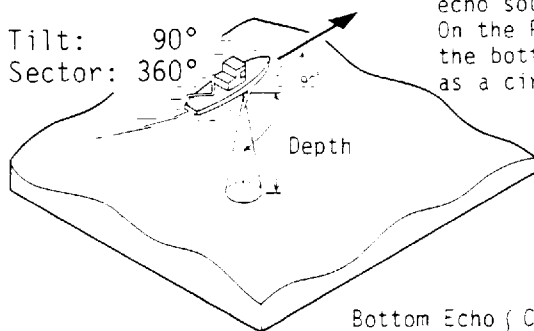

The situation is the same as an echo sounder. On the PPI screen, the bottom is traced as a circle.

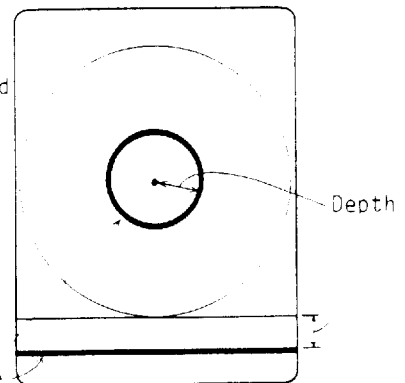

Bottom Echo { Circle
Straight Line

(b) Flat Bottom

Tilt: 60°
Sector: 360°

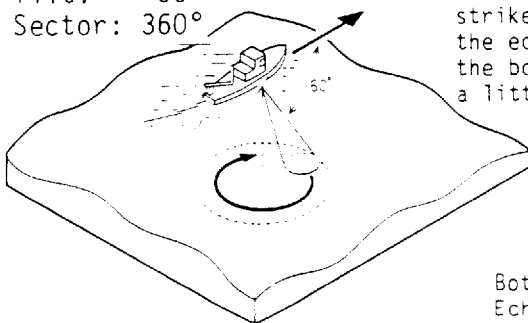

As the slant beam strikes the bottom, the echo trace of the bottom becomes a little wider.

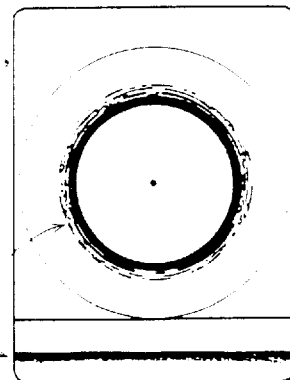

Bottom Echo

(c) Slant Bottom

Tilt: 60°
Sector: 360°

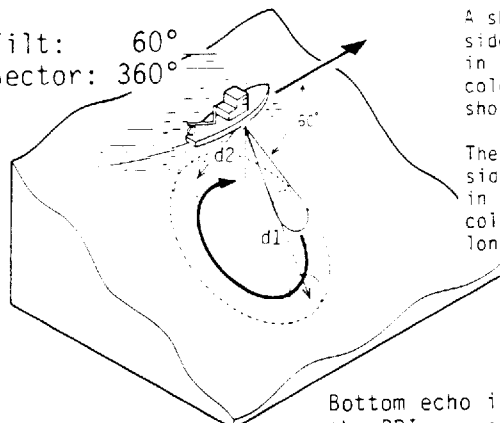

A shallow bottom side is displayed in a strong echo color and with a short tail.

The deeper bottom side is displayed in a weak echo color and with a long tail.

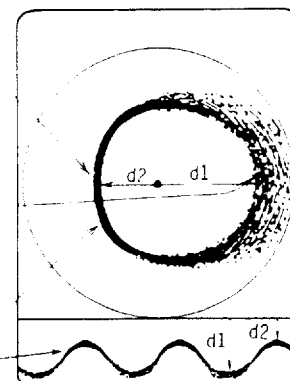

Bottom echo is traced in an oval shape on the PPI screen and wave shaped on the historical display screen.

(d) Reef or Wreck

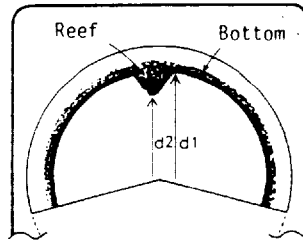
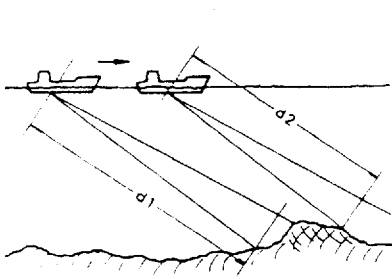

A reef or wreck is traced on the PPI screen as indicated left. (Auto train mode)

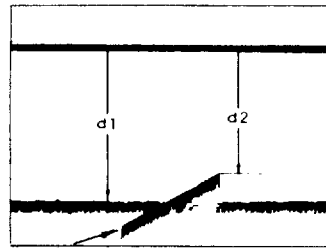

On the historical display screen, it is traced as indicated left. (Train stopped)

Reef (Short & straight echo, it is not traced when exceeding reef height.)

2. Fish School

A fish school appears on the screen as a mass of echoes. The color of the mass shows the density of the schools, and the size of the mass shows how it is distributed. The operator can recognize the horizontal distribution of the fish school from the school's appearance on the screen.

(a) Surface Fish School

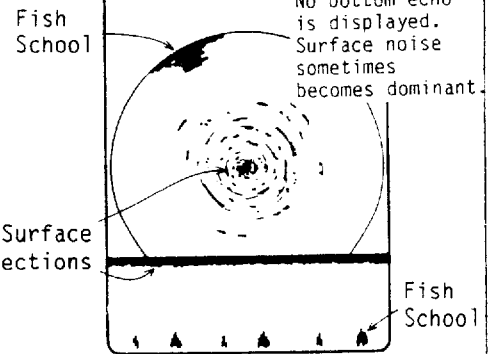
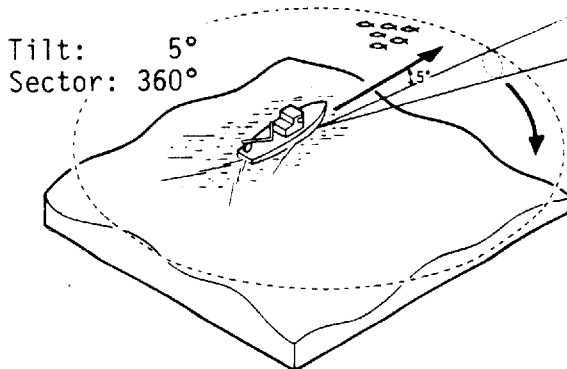

Surface fish school is sounded with a shallow tilt angle setting. In case that the tilt is settled with the training stopped after detecting the fish school and the ship is approaching, the fish school is traced on the historical display area as follows.

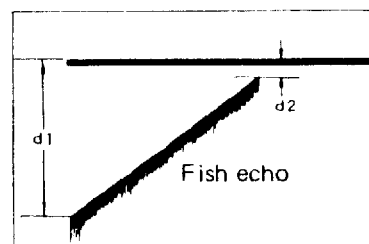
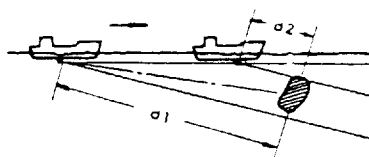

(b) Midwater Fish School

Tilt: 15°
Sector: 360°

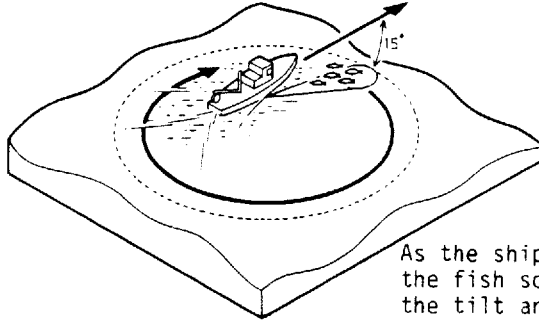

Fish School

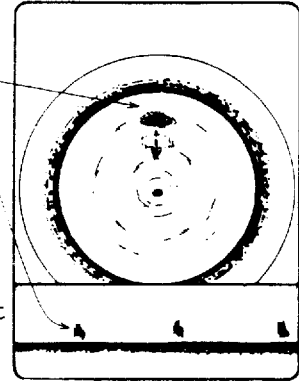

As the ship approaches the fish school, adjust the tilt angle so as not to miss the echo. The echo comes closer.

* Historical display when the ship approaches a fish school,

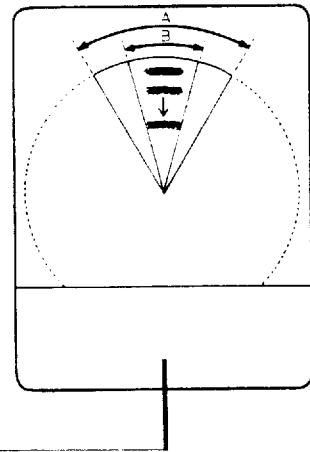
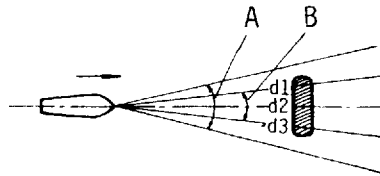

Wide Sector (A)

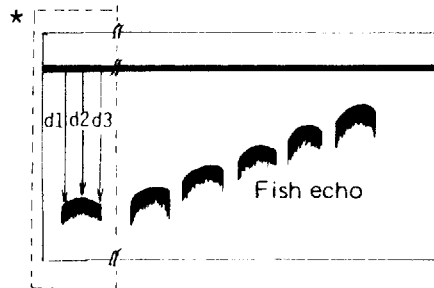

Narrow Sector (B)

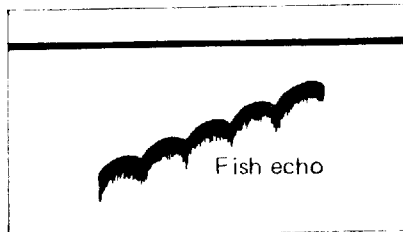

Depending on the training sector, a fish school is traced in a discontinuous or continuous wave shape. It is created by the difference of the depth from the soundome to the center and both edges of the fish school.

* Typical echo trace when ship is stopped.

(c) Bottom Fish School

* When it appears before the bottom echo.

Tilt: 40°
Sector: 360°

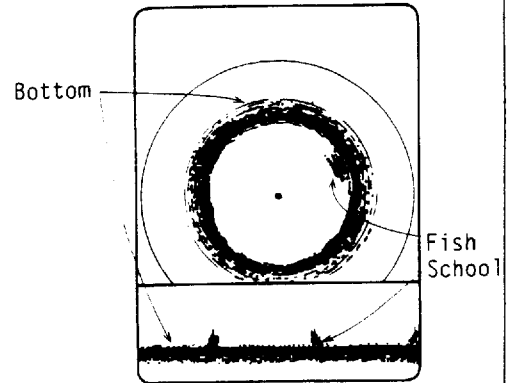
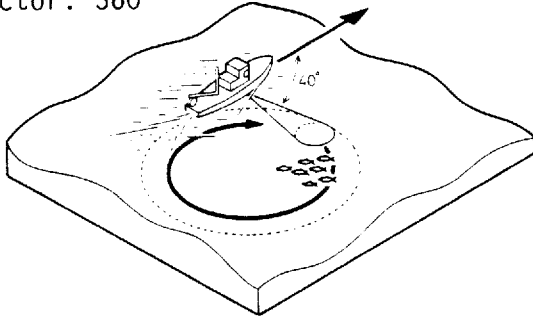

In this case it is sometimes difficult to identify the fish school unless the bottom contour line is recognized clearly (or the operator knows the bottom shape from experience).

* When it appears further than or together with the bottom echo. (Shallow Water Detection)

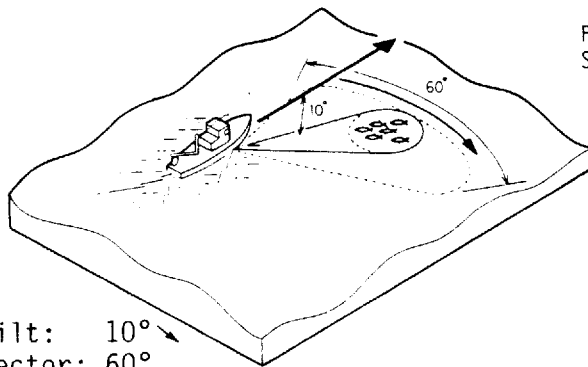

Tilt: 10°
Sector: 60°
AGC: ON

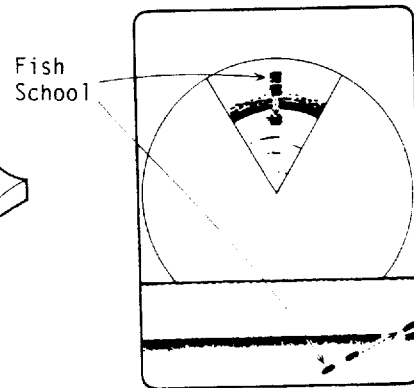

Fish school appearing together with the bottom echo can be recognized if the AGC is turned on.

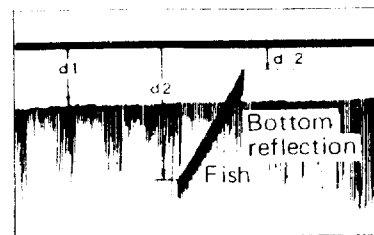
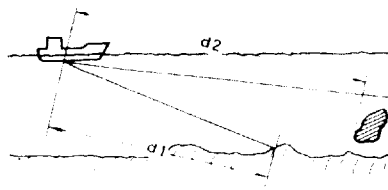

Example of fish echo trace in transducer stopped operation

4. Unwanted Echo/Noise/Interference

Sea Surface Reflections

If the sounding beam is tilted horizontally along the sea surface, surface reflections will become dominant and will interfere with observation of wanted echoes as illustrated below.

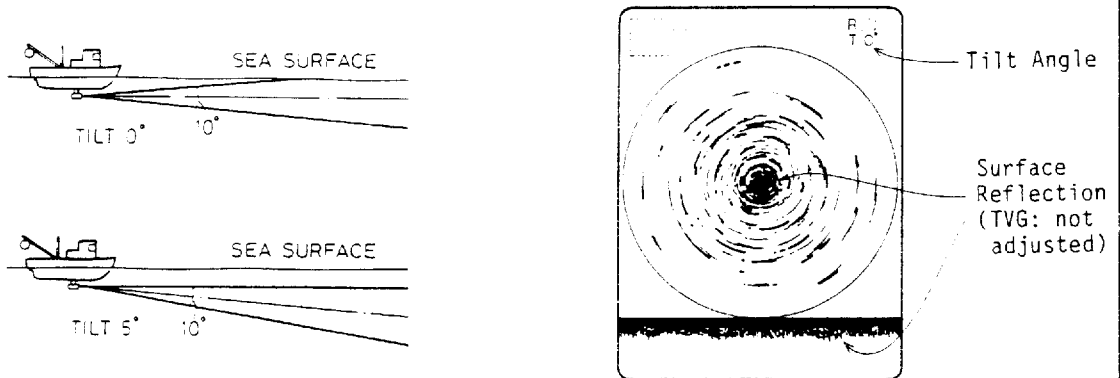

Wake (When setting the TILT to 0 - 10°)

A wake produced by own ship or another ship can be a strong reflecting object. As the wake appears on the screen as a thick continuous line, it can easily be distinguished from a fish school. On the other hand, the wake contains a lot of air bubbles which attenuate ultrasonic energy, making it often difficult to sound beyond the wake.

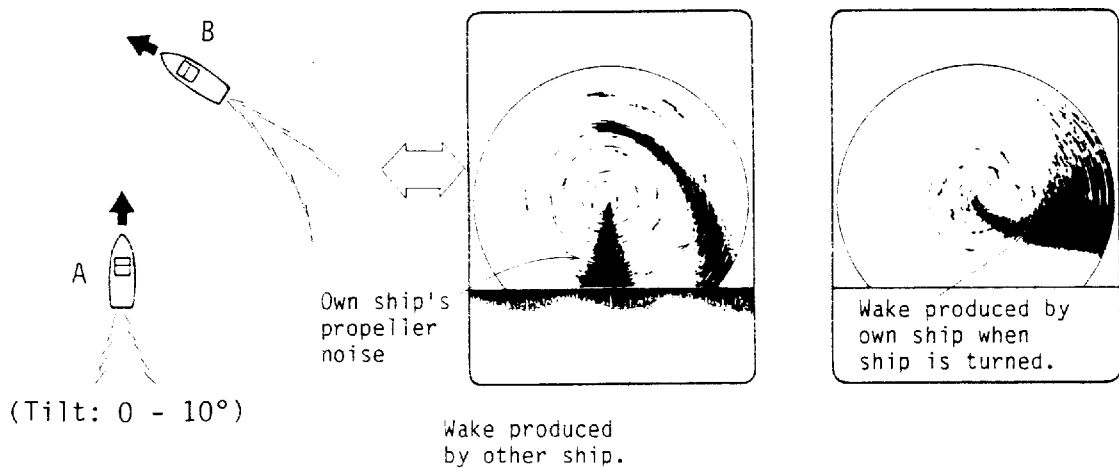

False Echo by Sidelobe

As noted before, an ultrasonic wave is emitted only in the direction set by the TILT switch, but, in practice, there are some emissions outside the main beam that are called "sidelobes". The energy of the sidelobe is fairly weak but when the sonar is used in comparatively shallow water with a high gain setting, strong target echoes are detected by the sidelobe in addition to the detection by the main lobe. These are represented on the screen as a false echo as shown below.

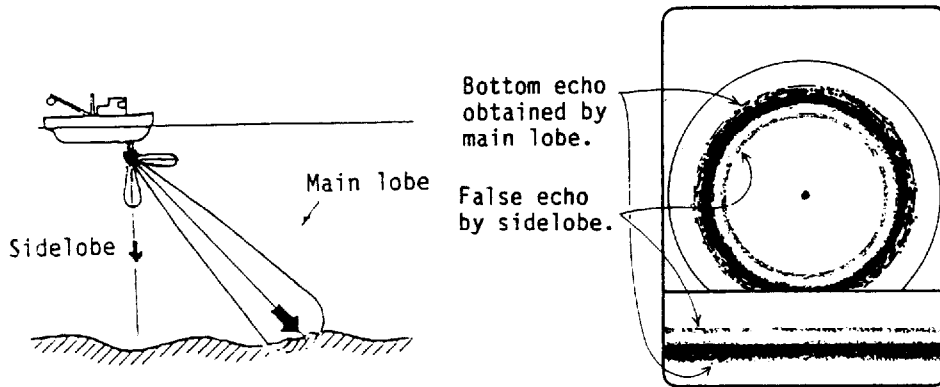

Noise and Interference

When the fishing ground is crowded with many fishing boats, the sonar may pick up interference from ultrasonic equipment such as an echo sounder, sonar, etc. on board other boats as well as those on board own ship.

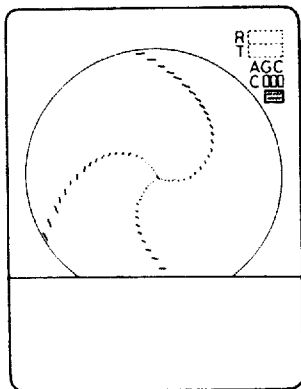

Interference Noise from sonar.

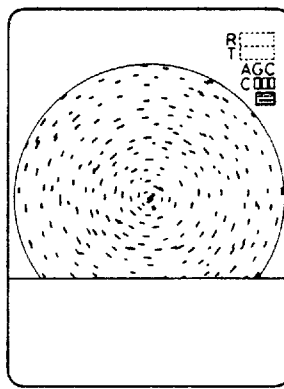

Interference Noise by other electric gears.

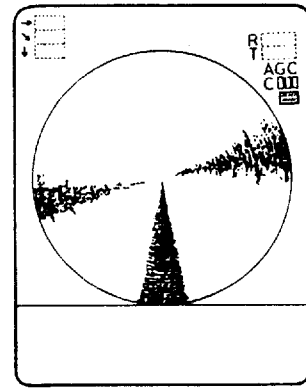

Noise by other boat's propeller.

EXAMPLE OF ACTUAL PICTURES

The following are actual pictures obtained from a fishing ground. Photos 1 thru 3 show the situations below the surface at points A, B and C respectively. Try to obtain as much information as you can from the screens. The basic method of interpreting a sonar picture is explained in the former section.

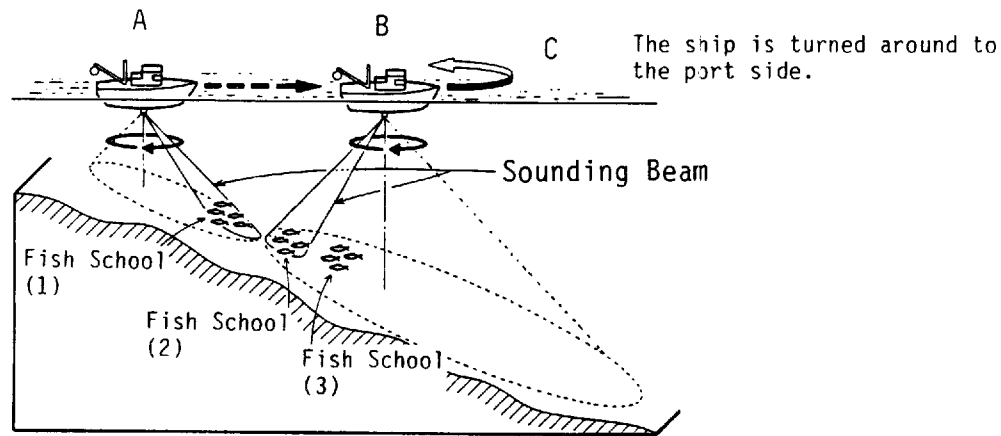

Other Typical Pictures

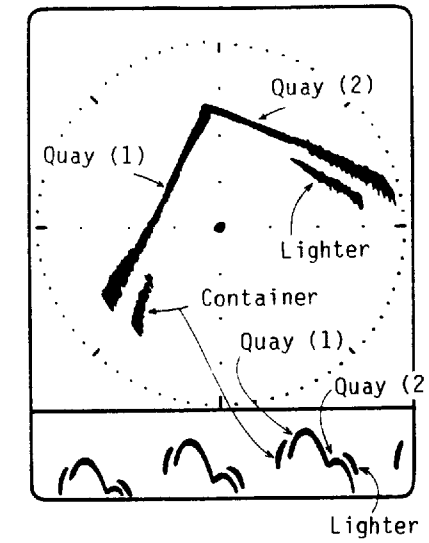
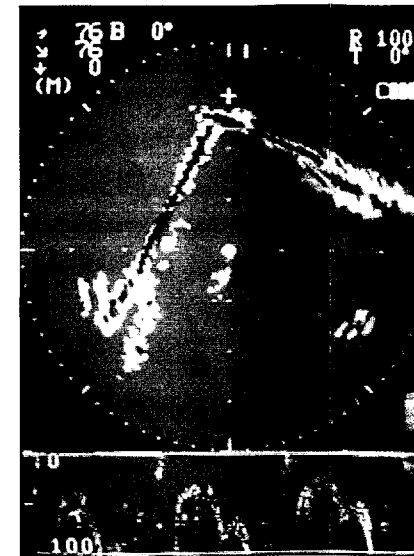

A typical picture of two intersecting quays. (Ship is stopped.)

The corner of the quay and lighter are clearly displayed. Less sidelobes and high-resolution processing give you crisp pictures such as this one. Also study the two different display screens, i.e., the indication of the same quay is quite different.

Point A

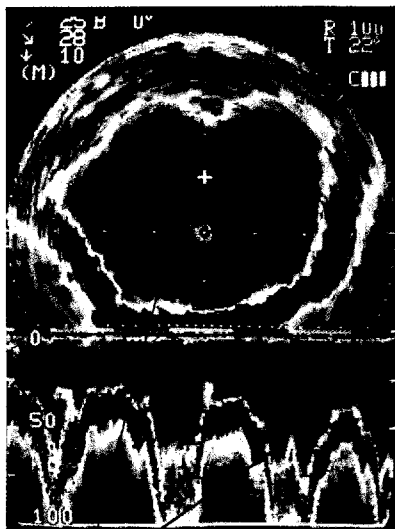

Fish school (1) located on the bottom is detectable in the fore direction of the ship.

From the above picture, the fore direction of the bottom is displayed in a weak echo color and longer tail and the aft direction is in a strong echo color with short echo tail. Also the bottom contour is oval shaped. This kind of display tells you that the bottom is slanting deeper in the fore direction.

Point B

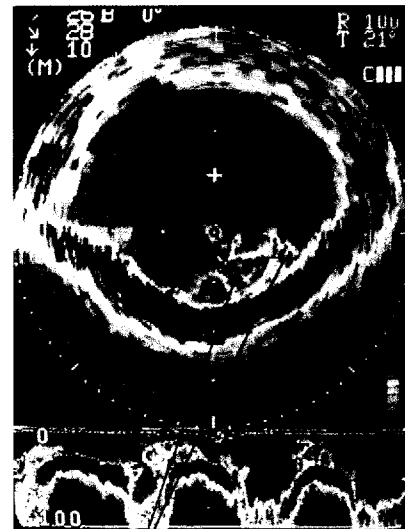

Fish school (2) & (3)

This is the picture when the boat is moving to point B. As before, the forward area is deeper than the aft but the fish school is displayed in the aft at this time.

From the lower picture you can know the fish schools are beginning to gather by observing previous pictures.

Point C

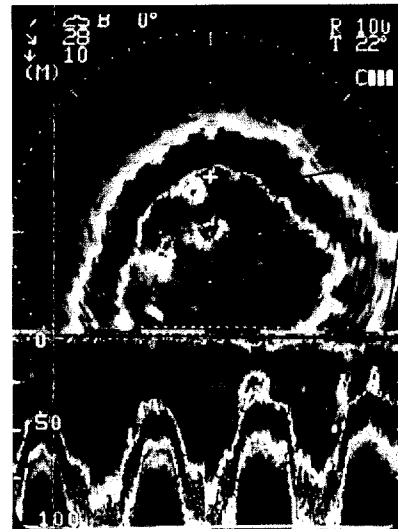

This is the picture when the ship is turned around to the port side. Accordingly the bottom contour shows that it is slanting shallower in the forward direction.

In this stage, the fish schools have separated into two schools.

The separation is clearly observed in the lower picture.

Fish School (3)

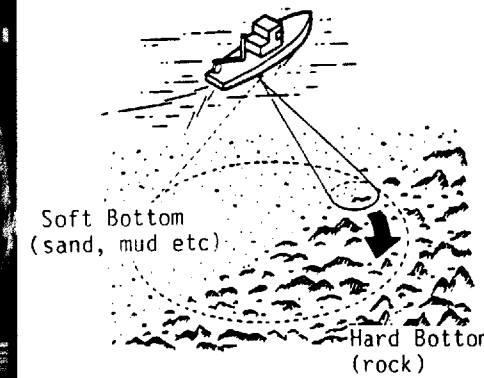
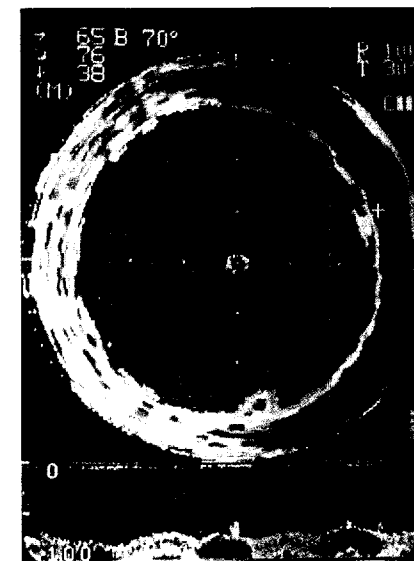

The seabed is even but the material is quite different between the starboard and port sides. This is known from the color display of the bottom (hard bottom; reddish brown & red, soft bottom; yellow & green, etc.)

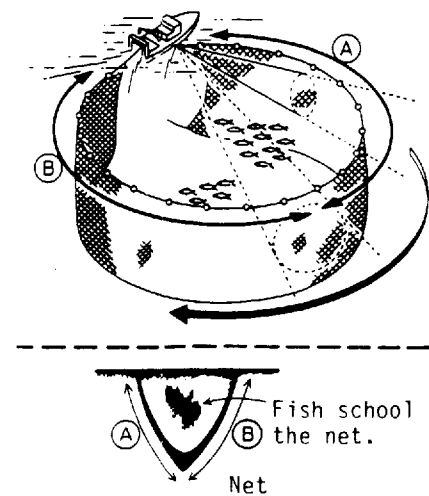
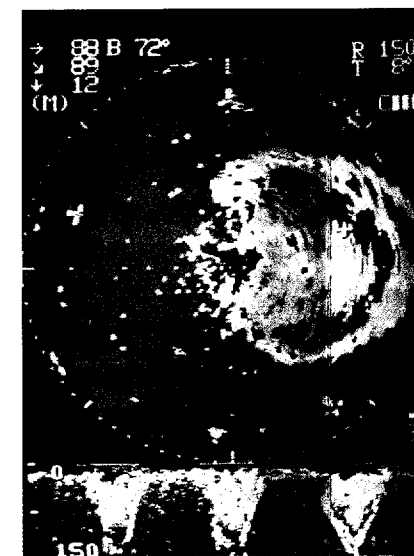

This picture shows the operation of a purse seine at the fishing ground. The net and the fish school in it can be observed. (If you adjust the tilt angle, the situation of the surface, medium and bottom of the net also can be seen.)

HOW TO OBTAIN QUALITY PICTURES

1. Gain Setting

Most of the equipment malfunctioning claims result from improper setting of switches and controls. For example, fish, fish habitat or outcrop can not be readily detected by merely increasing the gain. Initially set the gain around the "5" position. Then make fine tune depending on the condition of the fishing ground, frequency used, etc.

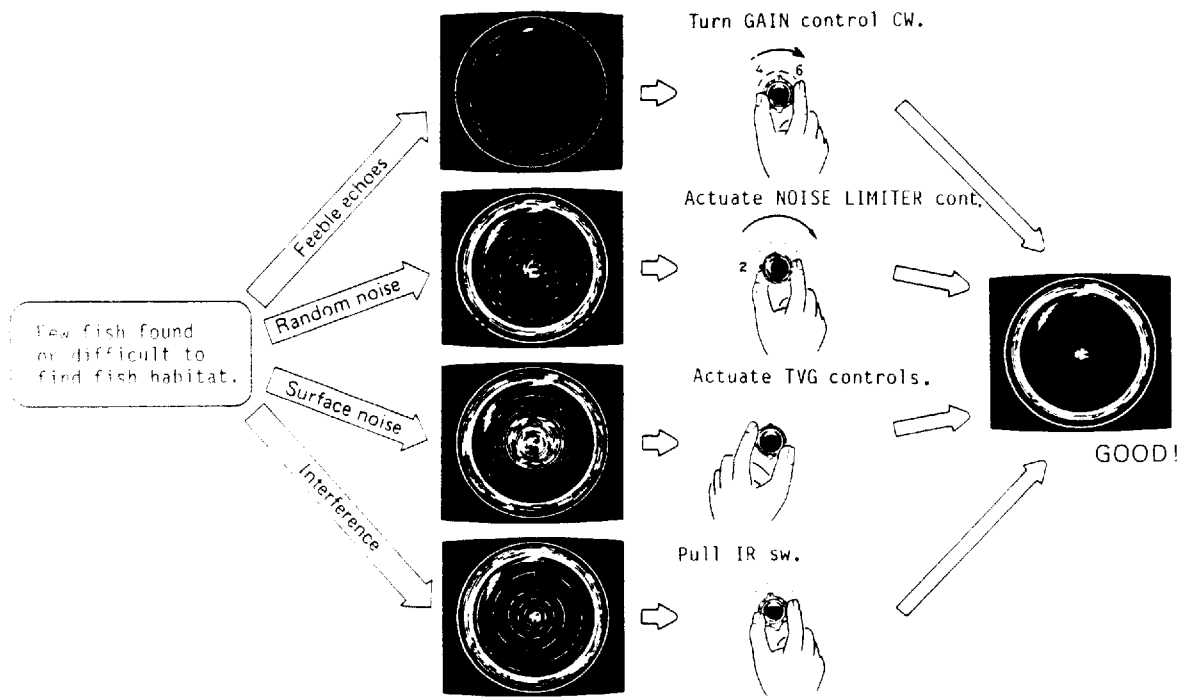

Standard Setting -----

Gain:	"5" ("4" to "6")
Noise Limiter:	"2"
TVG:	Level --- "2" to "5"
	Time --- "5"

2. Eliminating Unwanted Feeble Echoes (Applying Proper TVG)

Echoes from targets (such as a seabed or a fish) return to the transducer in order of the distance to them, and when their intensities are compared at the transducer face, those from nearer targets are generally stronger when their reflecting properties are nearly equal. The sonar operator will be quite inconvenienced if these echoes are directly displayed on the screen. He can not judge the actual size of the target from the size of echoes displayed on the screen. To overcome this inconvenience, a TVG function is incorporated. It compensates for propagation loss of sound in water; amplification of echoes on short range is suppressed and gradually increased as range increases so that similar targets are displayed in similar intensities irrespective of the ranges to them.

In the CH-26, the TVG level and time controls are provided to compensate for propagation loss. The effective distance is up to 1000m approximately.

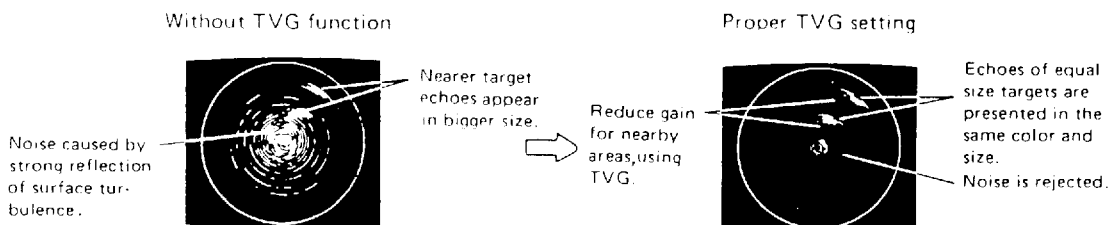

	Position	TVG Range
	0	0
	2	60
	3	130
	5	300
	⋮	⋮
	10	1000m

The TVG is also used to suppress unwanted echoes and noise which appear in a certain range area on the screen as shown in the figure above. To obtain the proper TVG setting, follow the procedure below.

(Procedure)

1. Set TVG time for the "5" position (approx. 300m). This is the standard setting and you can maintain this setting in most cases.
2. When sea surface reflections or plankton layers disturb the picture, set the TVG level knob between "2" and "5" to eliminate them.
3. Locate a fish school on a long range setting and watch it while it approaches. The tilt should be kept adjusted so that the fish school is always placed in the center of the sonar beam. Check that the the fish echo is displayed in the same color while it approaches. If the color changes suddenly to weaker colors as the fish echo nears area, the TVG is improperly set. Adjust the TVG level to correct it. If sea surface reflections and noise remain, try to remove them with the AGC and d NOISE LIM controls as described on pages 24 and 25.

3. Suppressing Seabed Tail (Displaying Bottom Fish Clearly)

As described earlier, fish schools located near the seabed are sometimes difficult to detect because you have to discriminate fish echoes in the seabed reflections. The AGC switch decreases the tail of seabed reflections, making it easier to discriminate bottom fish.

AGC Control

The AGC functions to automatically reduce the receiver gain only against strong echoes such as the seabed or a large school of fish. Since weak echoes remain unaffected, a small school of school becomes easier to detect. Turn it ON.

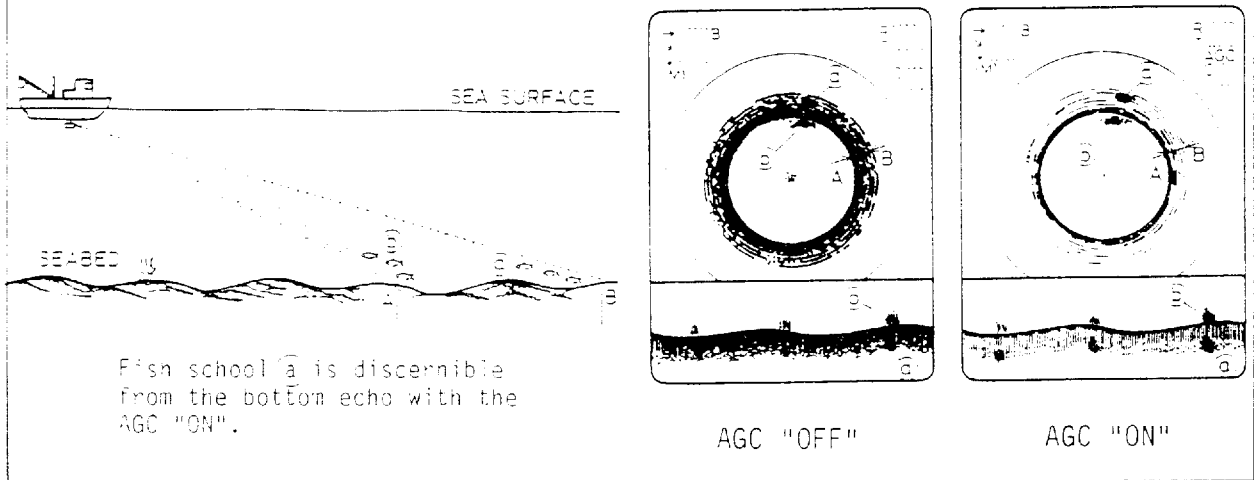

4. Suppressing Seabed and Sea Surface Reflections in Shallow Fishing Grounds (Reducing output power)

In shallow fishing grounds, excessive sea surface and seabed reflections often interfere with wanted fish echoes and they can not be eliminated sufficiently with the afore mentioned TVG and AGC controls. In such cases, try to reduce the output power by pushing the "OUTPUT" switch, without turning down the gain. The picture becomes more clearer when output power is reduced rather than when the gain is decreased as illustrated below.

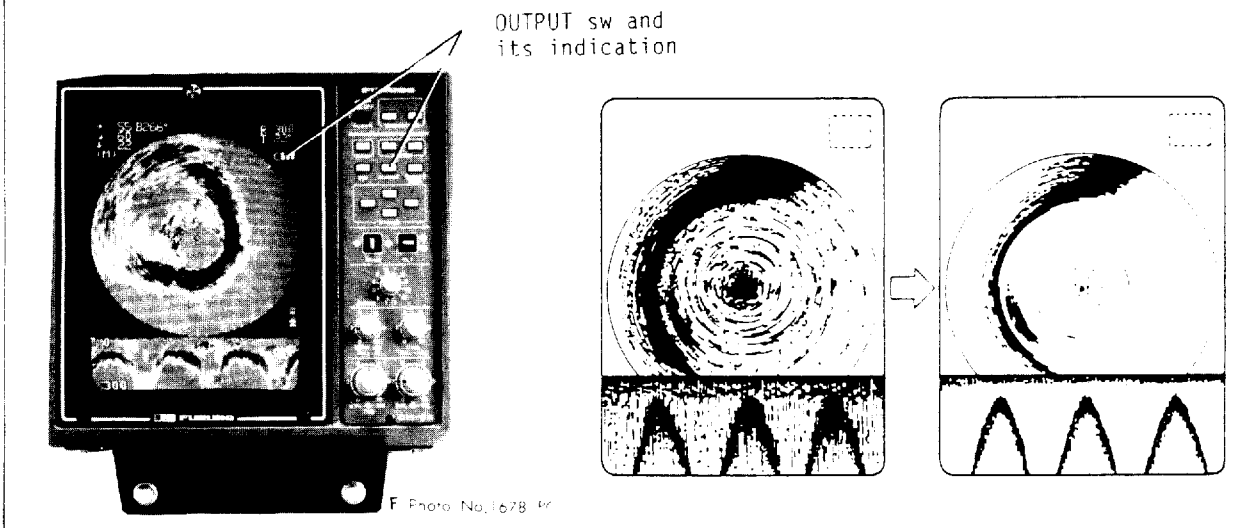

5. Rejecting Sonar Interference and Noise (Turning on the NOISE LIM/IR switches)

You may encounter occasional or intermittent noise and interference as shown below. These are mostly caused by on-board electronic equipment, engine, or propeller noise or electrical noise from other sonars being operated nearby.

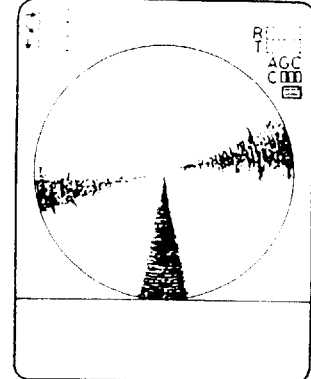
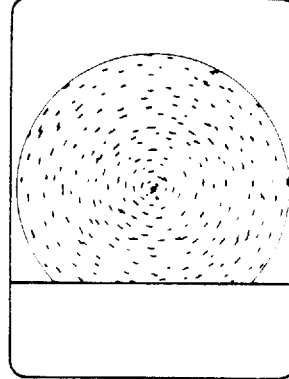
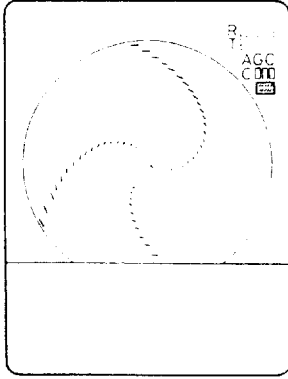

To eliminate noise effectively, you should first identify the noise source.

- * Operate all on-board equipment one by one while watching the picture.
- * Run the boat at various speeds to check if the noise is speed dependent.

If neither of the above two steps has no effect on the picture, adjust the NOISE LIM/IR controls.

HINTS FOR FISHING

PURSE SEINING

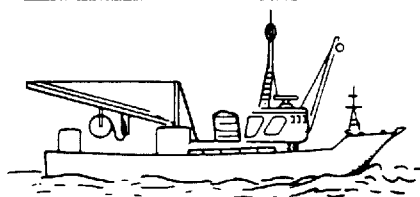

These examples give some helpful hints on how to use your sonar. Don't be afraid to experiment with control settings to optimize your results.

1 Power "ON".

2 Lower soundome.

After blinking, remains lit.

3 Search for fish school by RANGE and TILT sw. using.

4 Narrow the train area, and track fish school.

Here comes fish school!

5 Change tilt angle for strongest fish school echo.

Use expanded historical display.

6 Monitor situation of both fish school and net.

BOTTOM TRAWLING

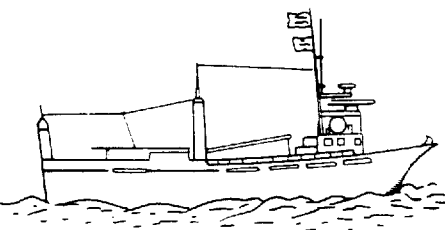

GAIN : 4 - 6
NOISE LIMITER : 2
TVG(level & time): both 5
POWER RED : C

Use these settings initially. "Fine tune" as necessary.

1 Power "ON".

2 Lower soundome.

After blinking, remains lit.

3 Observe seabed on the screen.

Select the proper range and tilt angle.

4 Narrow the train area, and track fish school.

Here comes fish school!

5 Observe movement of fish school and scout-boat.

Adjust tilt angle and observe both screens.

6 Set net around fish school.

Observe the net and the fish school in it.

For bottom trawling, sonar is usually used to detect net "hangs" ahead rather than to detect fish close to the bottom, since seabed returns usually mask the weaker fish targets close to the seabed. If the fish school is dense enough and off the seabed they can be detected by sonar.

5 Expand historical display and observe seabed.

6 Change tilt angle, and tow net.



DO NOT FORGET TO RETRACT THE SOUNDOME BEFORE TURNING OFF THE POWER !!

MAINTENANCE AND GENERAL NOTES

Pay attention to the following items to maintain optimum performance for a reasonably long period.

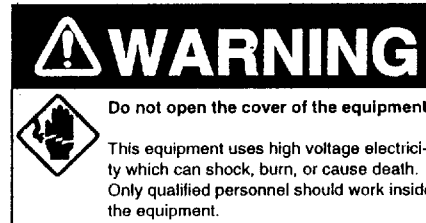

DISPLAY UNIT

1. Handle with care. Corrosion may start even from a scratch.
2. Don't touch the inside of the unit because high tension voltage exists.
3. Allow space around the unit for ventilation.
4. Keep away magnetic equipment such as a speaker, large capacity transformer and also magnetic sensitive unit such as gyrocompass or cassette tape.
5. Clean the filter and screen with wet or dry soft cloth. Don't use thinner or benzine.
6. Put on the cover after operation.

TRANSCEIVER UNIT

Wipe off dust or oil with cloth dampened in a mild detergent. Keep the unit clean, especially the cable entrance.

HULL UNIT

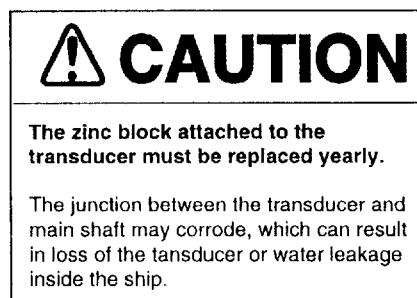

1. Lubrication

Remove the cover for the raise/lower drive assembly by loosening the fixing screws. Then apply grease to the raise/lower screw shaft once a year. Also put grease on the raise/lower main shaft (upper part of the grease cotton retainer) twice a year.

2. Cleaning Retraction Tank (Removal of Marine Growth)

If marine growth (barnacle, oyster, etc.) breeds inside the retraction tank, the raise/lower operation will be obstructed. In the worst case, the raise/lower motor may burn out. Therefore, it is necessary to remove marine growth at least once a year or when the ship is hauled on the slip or in the dry dock.

If the sonar is left inoperative for a considerably long period, scrape off marine growth inside the tank before operation.

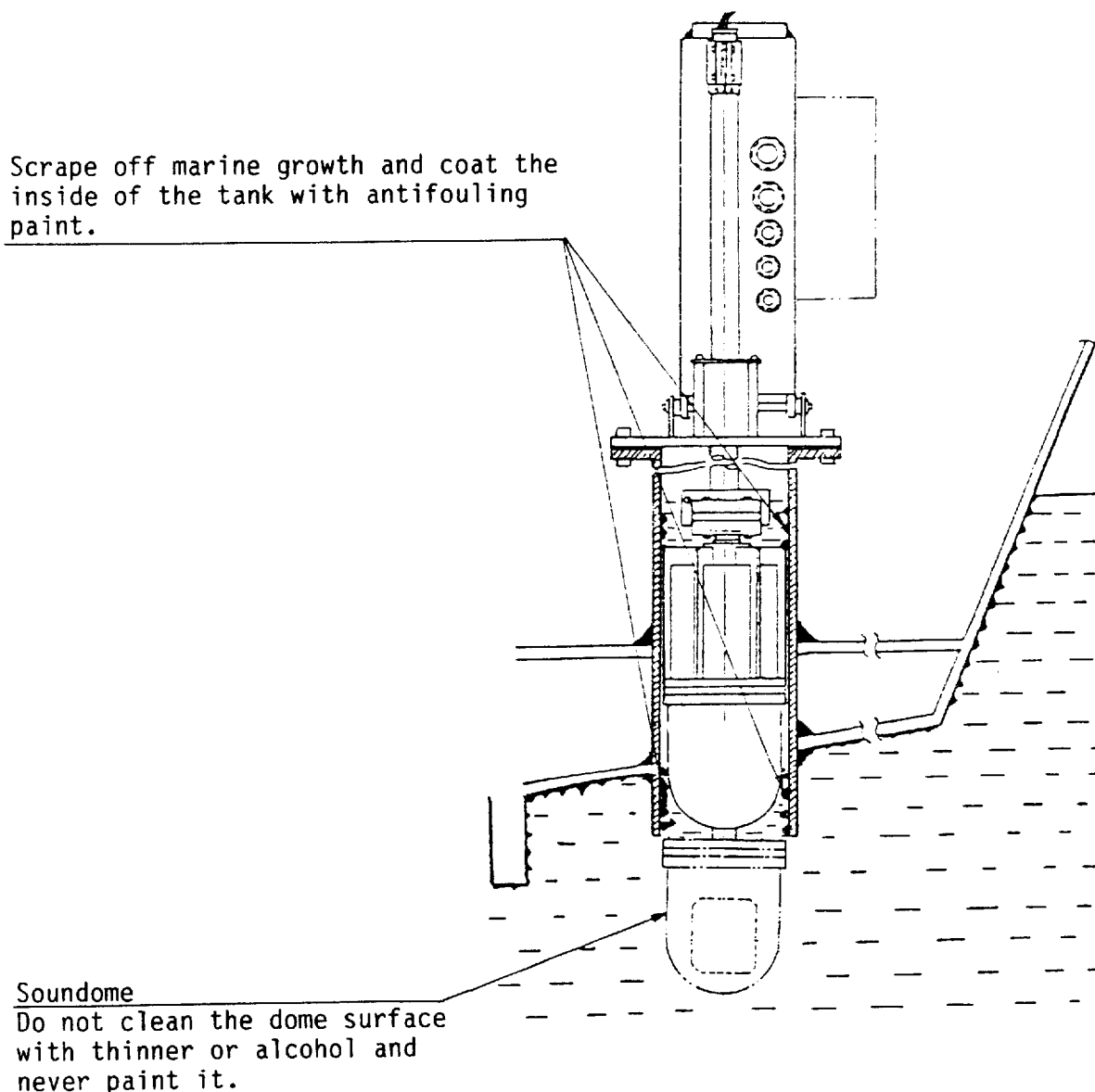

3. Replacement of the Grease Cotton Rings

Replacement of the grease cotton rings is required every two years or when water penetrates along the main shaft. For a ship whose waterline is higher than the flange level, though water penetration into the ship is prevented by the O-ring fitted at the bottom of the main body flange, it is recommended to replace the grease cotton rings with the ship hauled up.

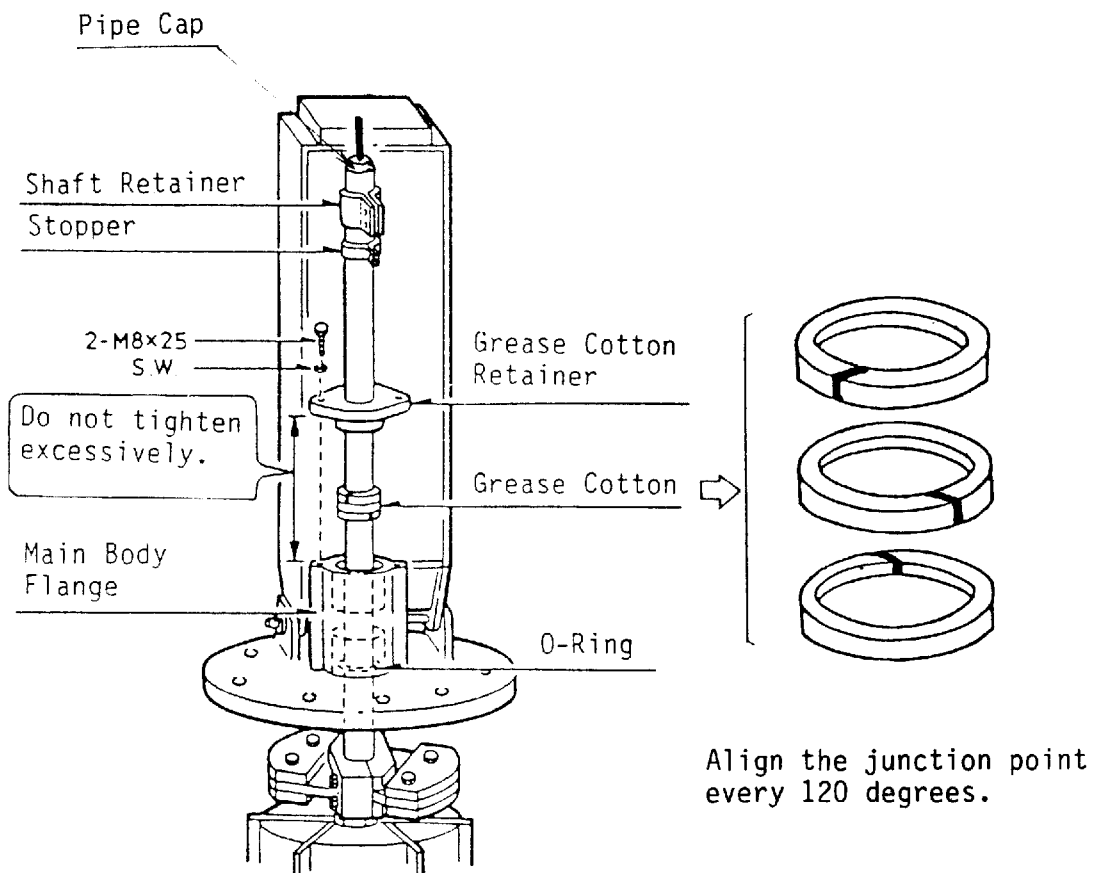

DIAGNOSTIC SELF-CHECK

The unit is equipped with the following self-check functions:

No.	Item	Operation Method
1	Display Unit Check (1)	While pressing the "MODE" switch, turn on power.
2	Hull Unit Check	While pressing the SECTOR "↔" switch, turn on power.
3	Display Unit Check (2)	While pressing the SECTOR "↔" switch, turn on power.

DISPLAY UNIT CHECK (1)

The CPU checks memory ICs, peripheral ICs, operation panel and internal setting switches, and displays the results as follows:

The screenshot shows a diagnostic menu titled "ROM/RAM/PANEL SELF TEST". It is divided into two columns: "MAIN CPU" and "PANEL".

Item	Value	Value	Value
Program version number	06500290XX		
MAIN CPU			
ROM	OK	0	0
RAM	OK	0	0
DSP CPU		0	0
06500300XX			
ROM	OK	0	0
RAM	OK	0	0
VIDEO RAM		0	0
SNR RAM	OK	0	0
ESM RAM	OK		
CHR RAM	OK		2
CLINOMETER		255	
ROLL	0°	(1)	(1)
PITCH	- 2°	255	
REM. CON.		(255)	
DIP SWITCH		0	
S2	00000000		
S3	0000		

Annotations and Explanations:

- * MAIN CPU ROM/RAM check. If a fault is detected, "NG" (no good) will be displayed instead of "OK."
- * Display unit panel switch check. If the value changes when each switch is operated, the switches are normal. As for the **GAIN** and **TVG** controls, the number should be 255 when turned fully clockwise and 0 when turned fully counterclockwise.
- * Remote control box switch check. The switches are normal if the value changes when each touch switch is pressed.
- * Internal preset switch settings. The switches are normal if the value changes when each switch is operated.
- * CLINOMETER check. The clinometer is normal if the value changes following ship's rolling and pitching.
- * VIDEO RAM check. If a fault is detected, "NG" will be displayed instead of "OK".
- * DSP CPU ROM/RAM check. If a fault is detected, "NG" will be displayed instead of "OK."

HULL UNIT CHECK

The hull unit is actually trained and tilted to display the response to the operational command from the display unit in numerical values. The order of checking is as follows: CW training--CCW training--downward tilt--upward tilt--CW training. During checks, a " * " mark will be displayed at the item being checked.

TRAN/TILT SELF TEST					
TRAIN			COUNT		
	NG			NG	
0		0			
1	239	0	1	239	0
2	243	0	2	243	0
3	245	0	3	245	0
4	241	0	4	240	0
5	241	0	5	240	0
6	242	0	6	242	0
7	242	0	7	241	0
8	241	0	8	241	0
9	242	0	9	243	0
10	240	0	10	239	0
11	244	0	11	244	0
12	244	0	12	245	0
TILT					
	NG			NG	
+ 5		+ 5			
-30	337	0	-30	338	0
95	532	0	95	531	0

* Train and tilt check counter. Advances one digit each time one cycle of train and tilt check is made.

* Number of pulses necessary to produce a 30° rotation. Normal if approx. 240.

* Number of pulses necessary to tilt from +5° to -30° and from -30° to -95°. Normal if as shown below.

+5° to -30° ---- Approx. 337
 -30° to -95°---- Approx. 532

DISPLAY UNIT CHECK (2)

This mode is used to check the display unit by using internally generated reference signals. The check can be performed without hull and transceiver units (though it is all right if they are connected) and the check result shows, if normal, the signal processor and coordinator in the display unit are correctly functioning.

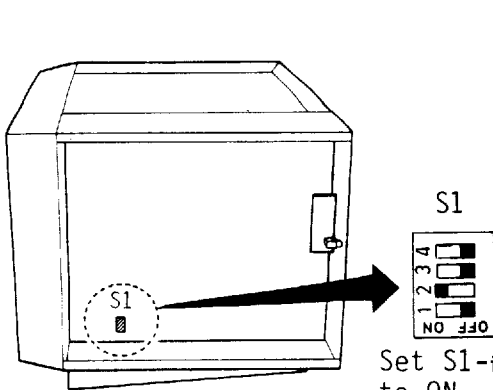

Set S1-#2 to ON.

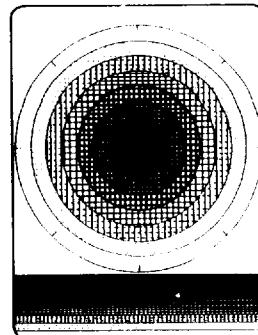

Picture shows concentric circles in which signal strength increases from the center position outwards. The picture will differ depending on the setting of the TVG, GAIN and NOISE LIM. controls.

SPECIFICATIONS

- 1. Display System PPI and historical displays on 10 inch color CRT.
- 2. Picture Color 8 colors depending on signal strength, reddish-brown (strongest echo) red, orange, yellow, green, light blue, blue, and deep blue (background).
- 3. Display Mode
 Mode 1: Full circle PPI + historical display
 Mode 2: PPI + expanded historical display
 Mode 3: Vertical sounding display

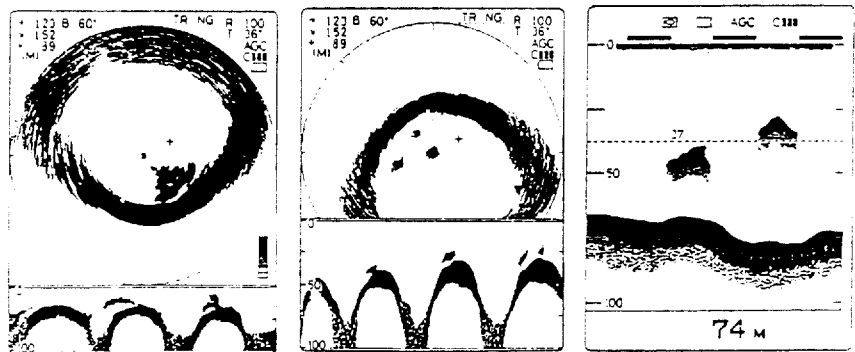

Mode 1

Mode 2

Mode 3

- 4. Display Range, Pulselength and Training Speed (Sonar Mode)

	1	2	3	4	5	6	7	8	9	10	11	12	Unit
1 Range	30	60	100	150	200	250	300	400	600	800	1200	1600	m
1 P/L	0.4	0.8	1.3	2.0	2.6	3.3	3.9	5.2	7.8	10.4	15.6	20.0	ms.
1 Train Spd.	7	7	9	13	17	21	25	33	54	70	102	134	Sec.
2 Range	50	100	150	200	240	280	320	360	400	450	500	600	m
2 P/L	0.7	1.4	2.0	2.7	3.2	3.8	4.3	4.8	5.4	6.0	6.7	8.0	ms.
2 Train Spd.	9	9	13	17	20	23	27	30	33	37	41	49	Sec.

"1" (standard) or "2" (special) is selected with internal DIP switch.

- 5. Display Range, Pulselength and TX Interval (Sonar Mode)

	1	2	3	4	5	6	7	8	9	10	11	12	Unit
1 Range	30	60	100	150	200	250	300	400	600	800	1200	1600	m
1 P/L	0.4	0.4	0.7	1.0	1.3	1.7	2.0	2.7	4.0	5.3	8.0	10.7	ms.
1 TX Intvl	200	300	400	400	500	500	500	550	826	1100	1652	2203	ms.
2 Range	50	100	150	200	240	280	320	360	400	450	500	600	m
2 P/L	0.7	0.7	1.0	1.3	1.6	1.9	2.1	2.4	2.7	3.0	3.3	4.0	ms.
2 TX Intvl	200	400	400	500	500	500	500	500	550	620	689	826	ms.

"1" (standard) or "2" (special) is selected with internal DIP switch.

- 6. Data Display

Range, Tilt Angle, AGC (On/Off), Output Power, Target Lock Mark, Slant and Horizontal Ranges and Depth of Range Marker, Bearing Scale, Range Marker, Automatic Training Center Bearing, Automatic Training Sector, Training Direction Mark, Depth (for V/S mode), Minute Marker (for V/S mode).

- 7. Audible Sound

Output 2W and frequency 1.kHz using external trumpet speaker

8. Transceiver

Frequency: 60, 88, 150 or 180kHz
 Output Power: 1.2 kW

Beamwidth: (-3dB)	Frequency (kHz)	Horizontal	Vertical
	60	15°	12°
	88	11.5°	9.5°
	150	6.5°	6.5°
	180	6.5°	6.5°

9. Training

Manual or automatic training at 6°/step

Auto Train Sector	Selectable in 36° steps from 36° to 360°
Auto Train Center	Can be set in any direction in 6° steps

Target Lock: Locks on and tracks fish targets above a specific level in the automatic training sector.

10. Tilt Scanning

+5° (above horizontal) to -90° (vertical)/10 seconds, 1° / step

11. Transducer Raise/Lower

Transducer travel: 400mm (can be changed to 250mm)

Raise/lower time: (at ship's speed 10 knots)

Ship's Mains	Raise Time	Lower Time
24VDC	36 secs.	30 secs.
32VDC	26 secs.	23 secs.

Note: Transducer operation can be monitored with lamp flickering during raise/lower operation and lighting upon completion.

12. Allowable Ship Speed

15 knots (12 knots during raise/lower operation)

13. Other Functions

Stabilizer (Optional): Stabilizes sounding beam against rolling/pitching of up to ±20° using a clinometer.

Remote Control (Optional)

14. Power Supply and Power Consumption

24/32VDC, approx. 175W (During raising: 275W)
 100/110/115/220VAC, 50-60Hz, 1ø
 (For AC mains, rectifier RU-1746B-2 is required).

CHANGING SPECIFICATIONS

CHANGING OPERATING SPECIFICATIONS

According to user requirements, and in order to render use even easier, the operating specifications can be changed to those shown in the following chart. The switches used to change the specifications are located on the DSP board in display unit. The user should change them to fit his own particular requirements.

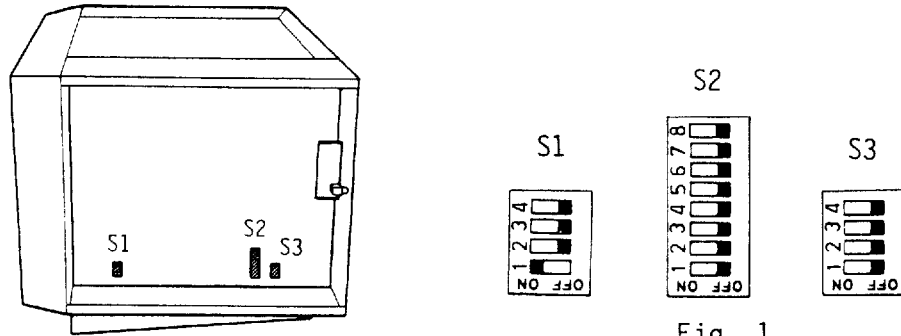

Fig. 1

Note: In the chart below, the values in the thick-lined boxes show standard settings (factory settings).

Internal switch S1

Item	Switch Number	Operational Specifications	
		On Side	Off Side
Received Signal	1	ON	OFF
Test Pattern	2	ON	OFF
External KP	3		
	4	Unused	

Note: To produce the test pattern, set number 1 to OFF and number 2 to ON.

Internal Switch S2

Item	Switch Number	Operational Specifications							
		On Side				Off Side			
Unit	1	OFF	Meter	ON	Feet	OFF	Fathom	ON	Hiro
	2	OFF		OFF		ON		ON	
TVG Compensation	3	OFF	Standard	ON	1	OFF	2	ON	3
	4	OFF		OFF		ON		ON	
AGC Level	5	OFF	Standard	ON	Weak	OFF	Strong	ON	Un-
	6	OFF		OFF		OFF		ON	used
Stabilizer	7	ON				OFF			
		Note: Should be set to ON when the clinometer (optional) is mounted.							
Range	8	Standard				Special			
		Note: See page AP-1 for details.							

Internal Switch S3

Item	Switch Number	Operational Specifications	
		On Side	Off Side
Target Lock Level	1	Yellow	Red
		Note: Set the level of the signal at which target lock is activated. On the OFF side it will be activated for the signals above the red level.	
Target Lock Mode	2	Lock	Sweep
		Note: For details of target lock operation, see the operator's manual.	
Train Speed	3	Low	Standard
		Note: In the "low" mode, the transducer trains 6° after echoes up to the range in use are received; step-by-step training for higher sensitivity. In "standard" mode, continuous training.	
Synchronization	4	ON	OFF
		Note: In the "ON" position, transmission is synchronized with external KP. See page 2-2.	

CHANGING STROKE OF TRANSDUCER TRAVEL

The stroke of transducer travel can be changed from 400mm to 250mm or vice versa by moving the upper limit switch. (The limit switch fixing rail has been tapped at the factory for both positions).

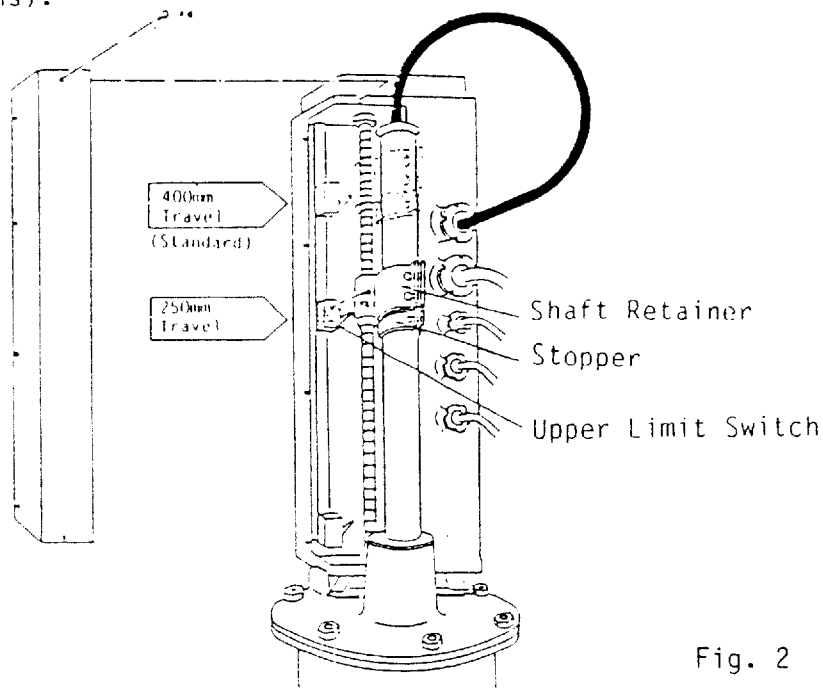
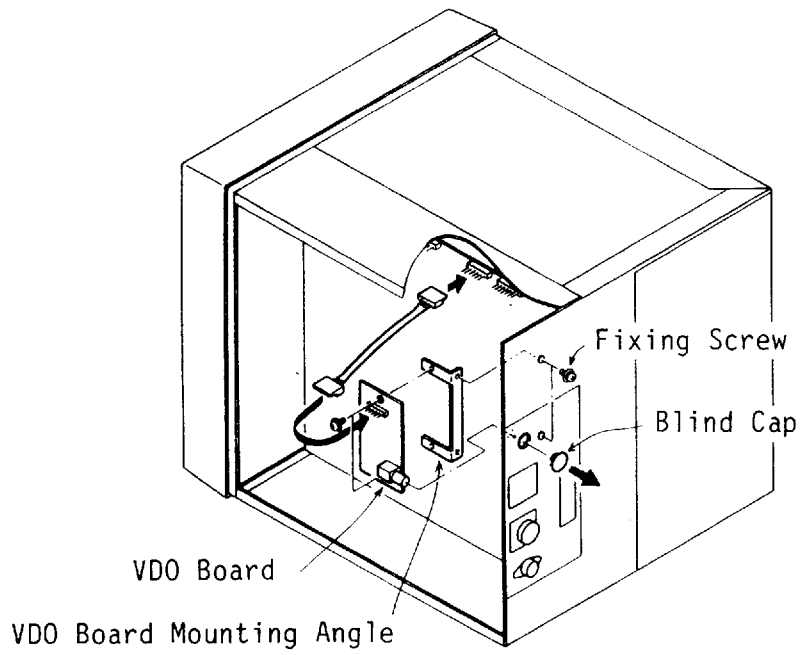

Fig. 2

Note: If the transducer travel is changed from 400mm to 250mm, the transducer may not be retracted into the tank completely; approx. 150mm is left exposed. In this case, lower the position of the shaft retainer by 150mm.

CONNECTING MONITOR TV

To connect the monitor TV, the VDO board (optional) is required. Mount it to the right side of the display unit as shown in the figure below.



CHARACTERISTICS OF THE ULTRASONIC WAVE IN WATER

The experienced fisherman is more than familiar with the characteristics of the ultrasonic wave. This appendix is intended to foster experience with a little theory, hoping the combination of the two may further increase your fishing efficiency.

SOUND VELOCITY

It is generally known that an ultrasonic wave travels 1500 meters per second in sea water, but in practice, some amount of variation arises depending on the season and area from differences in the following three factors:

Water temperature ----- θ [$^{\circ}\text{C}$]
 Salinity density ----- S [%]
 Water pressure (water depth) ----- h [m]

Therefore, for propagation in surface water the velocity changes not only by area but also by the direction of the wave propagation. The equation obtained thru thousands of measurement is;

$$C = 1410 + 4.21\theta - 0.037\theta^2 + 1.145S + 0.0168h \text{ [m/s]}$$

$^{\circ}\text{C}$	Velocity (m/sec)
0	1445.4
1	1450.0
2	1454.4
3	1458.8
4	1463.1
5	1467.2
6	1471.3
7	1475.3
8	1479.2
9	1483.0
10	1486.7
11	1490.3
12	1493.8
13	1497.3
14	1500.6
15	1503.8
16	1507.0
17	1510.0
18	1513.0
19	1515.9
20	1518.7

Correction value with respect to Depth and Temperature (m/sec.)

Depth (m) \ $^{\circ}\text{C}$	100	200	300	400	500	600	700
5	1.8	3.6	5.4	7.3	9.1	10.9	14.5
10	1.8	3.6	5.4	7.2	9.0	10.8	14.5
15	1.8	3.6	5.4	7.2	9.0	10.8	14.4
20	1.8	3.6	5.4	7.2	9.0	10.8	14.4
25	1.8	3.6	5.4	7.3	9.1	10.9	14.5

Fig. 1 Sound Velocity

Research in the waters throughout the world has revealed that there is a difference of approximately 100[m/s] between the areas where the velocity is maximum and minimum.

Generally, the velocity increases as follows, provided that salinity density is constant:

- . 3m/sec for every 1 degree rise of water temperature.
- . 1.7m/sec for every 100m increase of water depth.

ABSORPTION AND ATTENUATION

An ultrasonic wave emitted into water becomes weaker in intensity as it goes away from the emitting source. Principle causes of attenuation are:

1. Acoustic energy of the ultrasonic wave decreases gradually through reflection, refraction and diffusion in water.

- Acoustic energy is absorbed by the viscosity of the medium (water) and converted into other forms of energy.

Fig. 2 shows that the higher the frequency, the greater the absorption and attenuation of the ultrasonic wave. In other words, the absorption coefficient is a function of the frequency. Generally, total energy loss encountered on the way to and from a target is expressed as;

$$TL [dB] = 40 \log R + 2\alpha R$$

where R ----- Range to a target
 α ----- Absorption coefficient

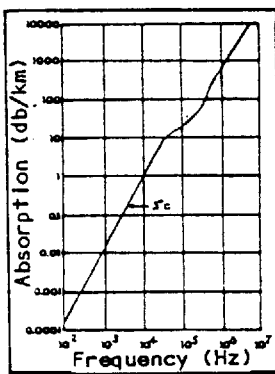

Frequency vs. Absorption

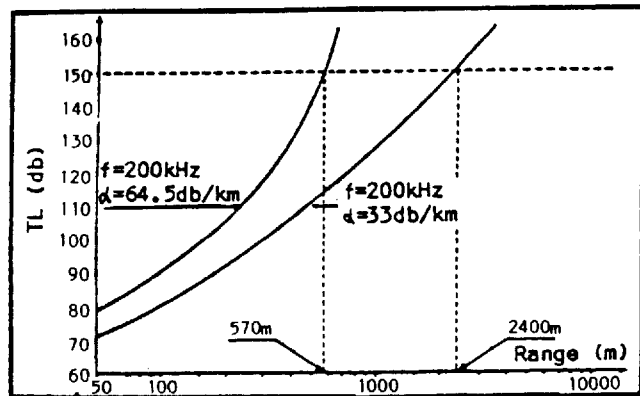

Range vs. Absorption

Fig. 2

REFRACTION

An ultrasonic wave transmitted in water does not travel straight but is more or less refracted. This refraction is caused by the variation of propagation velocity in water. If the velocity decreases (temperature decreases) with depth, the top part of the wave front moves faster than its bottom part, and gradually the front bends downwards. See Fig. 3. In the same way, it bends upwards if the sound velocity increases (temperature rises) with depth. See Fig. 4.

In other words, the ultrasonic wave refracts toward colder water.

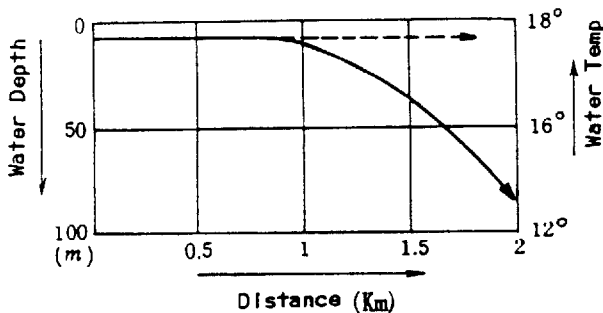

Fig. 3

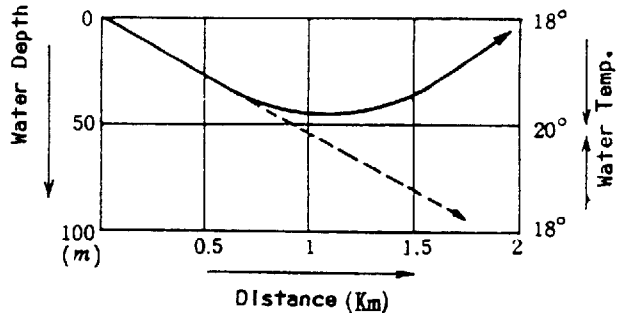

Fig. 4

Here, a fishing ground off Hokkaido Island in Japan is taken as an example.

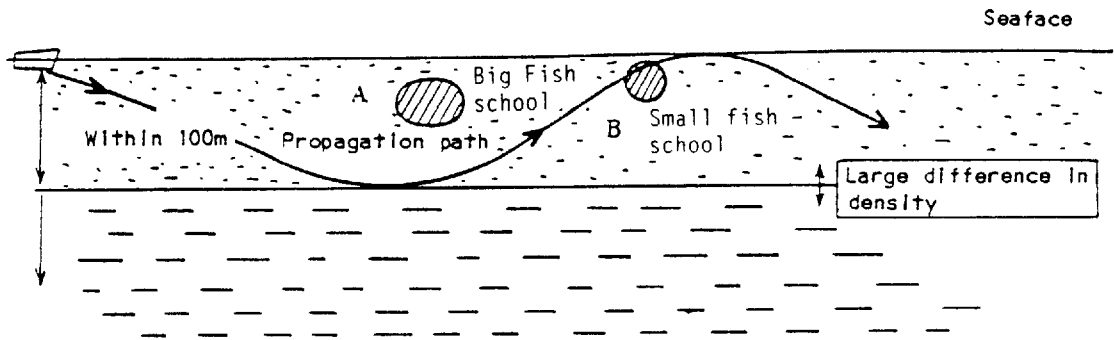

Fig. 5

In summer, there is a large difference in salinity density below and above the 100m deep point. An ultrasonic wave emitted almost in the horizontal direction propagates within the 100m deep water in the same way as a radio wave in waveguide. As a result, even a small fish school is sometimes detected at an unexpected long range or on the contrary, detection of a large fish school does not extend to a relatively long range.

These phenomena are encountered when two fish schools lie in positions "A" and "B" of Fig. 5.

Fig. 6 shows how temperature variation affects sound propagation with respect to different emitting directions (tilt angles). Beams tilted five and ten degrees bend upward at 400m and 600m points respectively. Beams tilted down more than 15 degrees travel in almost straight lines. Between the two beams, a blind zone is created beyond the 600m point. In this zone nothing can be detected. Fig. 6 is only an example calculated by a computer, based on the temperature with depth as shown in the left column of the figure. On actual fishing grounds, the temperature distribution and subsequently the behavior of the sound beam is much more complicated. It is, therefore, for effective use of sonar, necessary to know at least roughly how the temperature is distributed in various waters.

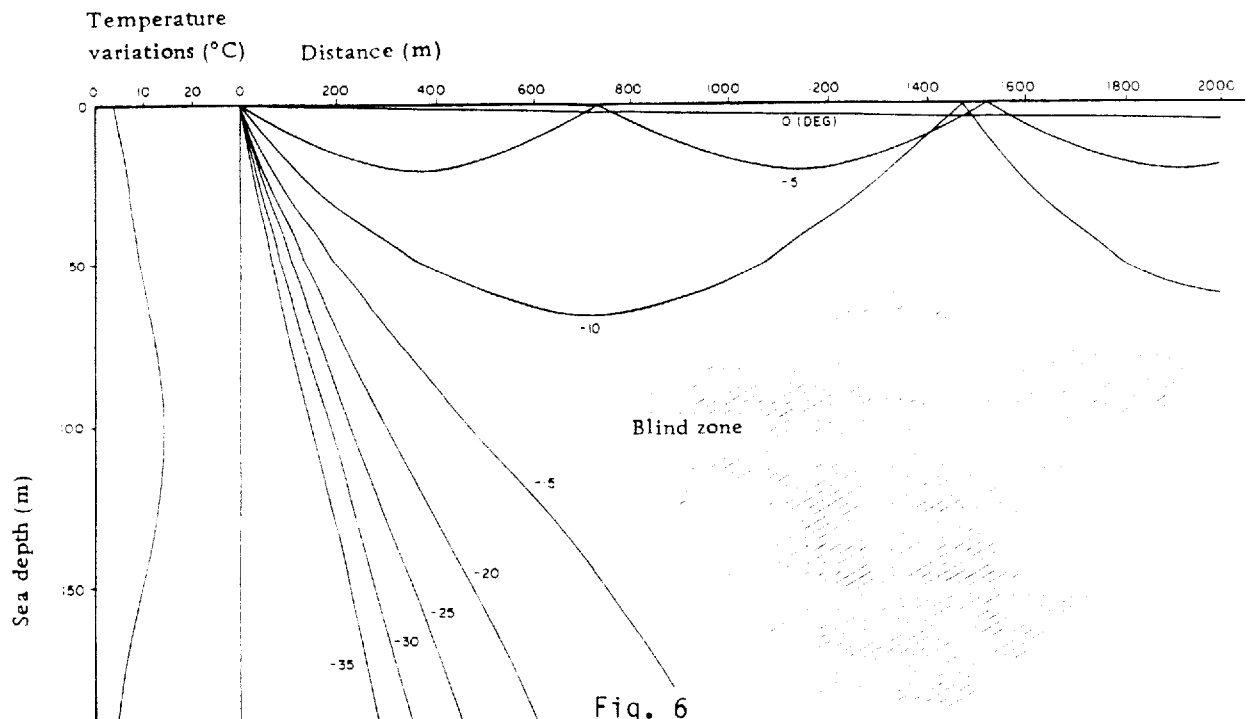

Fig. 6

ADVERSE EFFECT OF AIR BUBBLES

Even infinitesimal air bubbles in sea water (liquid medium) affect propagation of ultrasonic sound. This is because the cubic elasticity of gas is extremely small when compared with that of liquid; the air bubbles violently vibrate (contract and expand) by the action of sound pressure, diffusing the ultrasonic wave and dispersing part of the acoustic energy. In a liquid which contains a large amount of air bubbles, attenuation of an ultrasonic wave increases and the wave is reflected at the boundary of waters which contain and do not contain air bubbles.

From the above it can be said that reflection occurs in the boundary where the density (P) of the material (medium) that is, the velocity of the ultrasonic wave changes. The velocity of an ultrasonic wave with respect to its medium is 200 thru 400m/s in gas, except for hydrogen and helium; 900 thru 2000m/s in liquid (several times higher than in air) and 2000 thru 6400m/s in ordinary metal.

The product of the density (P) and the velocity (C) is called intrinsic acoustic impedance and in the boundary between two media which has extremely different C from each other, most of the acoustic power is reflected and only a small portion penetrates. (In the boundary between water and air, the acoustic energy penetrates with a loss of approximately 30dB, that is approximately 0.1% of the energy penetrates from one medium to the other.)

Reflection from water which contains air bubbles is caused by the fact that the cubic elasticity decreases in aerated water, causing the intrinsic acoustic impedance to change.

In the actual sonar operation, the adverse effect of air bubbles is shown by interrupted display of target echoes which occurs while crossing over the wake of another boat or when the sonar transducer passes above the air bubbles generated by own ship.

Air bubbles in water have a resonant frequency of 15kHz thru 100kHz and hence the ultrasonic wave in this frequency range is most strongly affected.

REFLECTION AT SEABED AND FISH SCHOOL

The nature of the seabed is roughly classified into the following four kinds: crag, sand, mud and seaweeds. In addition, shells and carcass of animals (especially coral) imbedded in the seabed cause reflection loss.

$$\text{Reflection Loss } L_b = 20 \log \left(\frac{\text{Incident sound pressure}}{\text{Reflection sound pressure}} \right) \text{ (db)}$$

Fig. 7 shows the actual reflection loss in the sea. It is shown that the reflection loss remains almost constant up to 50kHz and then gradually increases.

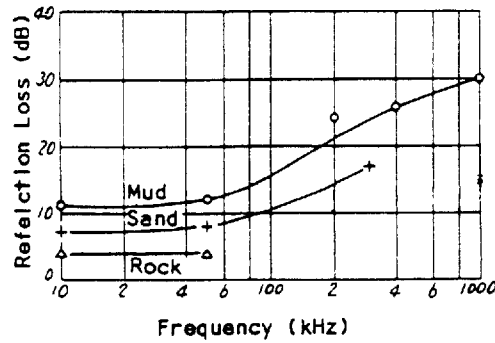
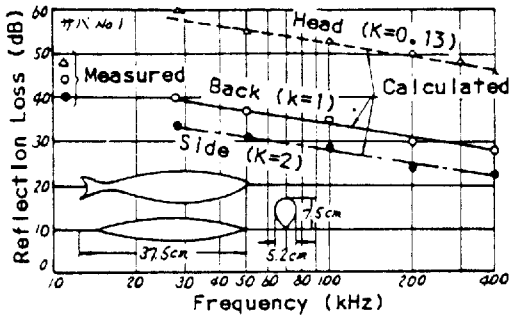
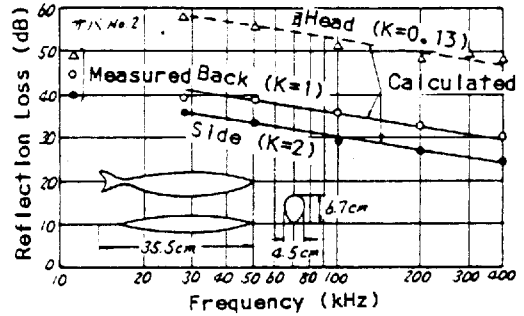

Fig. 7

Fig. 8 is the relation of frequency vs reflection loss for sardine. It shows that the calculated value and actually measured value nearly coincide. And also, on the contrary to the seabed reflection, the reflection loss decreases as the frequency increases. The "K" in the figure is the coefficient of the fish shape for each fish species and listed below, where its larger value introduces smaller reflection loss.



Reflection Loss (Mackerel No.1)



Reflection Loss (Mackerel No.2)

Fig. 8

Species	Incident Direction of Ultrasonic Wave		
	Back	Side	Head
Sardine	1	2	0.13
Bonito	1	2	0.5
Horse Mackerel	0.8-1.2	1.4-2.2	0.4-0.6
Sea Bream	0.9	3	0.45
Turbot		2	
Average	1	2	0.4

Free Manuals Download Website

<http://myh66.com>

<http://usermanuals.us>

<http://www.somanuals.com>

<http://www.4manuals.cc>

<http://www.manual-lib.com>

<http://www.404manual.com>

<http://www.luxmanual.com>

<http://aubethermostatmanual.com>

Golf course search by state

<http://golfingnear.com>

Email search by domain

<http://emailbydomain.com>

Auto manuals search

<http://auto.somanuals.com>

TV manuals search

<http://tv.somanuals.com>