

FURUNO

OPERATOR'S MANUAL

COLOR VIDEO SOUNDER

MODEL FCV-780/782



FURUNO ELECTRIC CO., LTD.
NISHINOMIYA, JAPAN

© **FURUNO ELECTRIC CO., LTD.**

9-52, Ashihara-cho,
Nishinomiya, Japan 662

Telephone: 0798-65-2111
Telefax: 0798-65-4200 (G111)

All rights reserved. Printed in Japan

·Your Local Agent/Dealer

Initial : SEP 1990
M : DEC. 18, 1996

(ETMI)

PUB. No. OME-23290
FCV-780/782





SAFETY INSTRUCTIONS

"**DANGER**", "**WARNING**" and "**CAUTION**" notices appear throughout this manual. It is the responsibility of the operator of the equipment to read, understand and follow these notices. If you have any questions regarding these safety instructions, please contact a FURUNO agent or dealer.



DANGER

This notice indicates a potentially hazardous situation which, if not avoided, will result in death or serious injury.



WARNING

This notice indicates a potentially hazardous situation which, if not avoided, could result in death or serious injury.



CAUTION

This notice indicates a potentially hazardous situation which, if not avoided, could result in minor or moderate injury, or property damage.

WARNING



Do not open the cover of the equipment.

This equipment uses high voltage electricity which can shock, burn, or cause death. Only qualified personnel should work inside the equipment.

Do not disassemble or modify the equipment.

Fire, electrical shock or serious injury can result.

Immediately turn off the power at the ship's mains switchboard if water or foreign object falls into the equipment or the equipment is emitting smoke or fire.

Continued use of the equipment can cause fire, electrical shock or serious injury.

CAUTION

Do not place liquid-filled containers on the top of the equipment.

Fire or electrical shock can result if a liquid spills into the equipment.

Do not place heater near the equipment.

Heat can melt the power cord, which can result in fire or electrical shock.

Do not operate the unit with wet hands.

Electrical shock can result.

Use the correct fuse.

Use of the wrong fuse can cause fire or equipment damage.

(Continued on next page)

NOTICE

Do not use the equipment for other than its intended purpose.

Use of the equipment as a chair or a shelf, for example, can cause equipment damage.

Immediately turn off the power whenever you feel the equipment is abnormal.

Continued use can cause equipment damage.

The useable temperature range is 0°C to 50°C.

Use out of the range can cause equipment damage.

Keep magnets and magnetic fields (speaker, transformer, etc.) away from the equipment.

Magnets and magnetic fields can cause equipment malfunction.

Do not place objects near the equipment.

Objects near the equipment can cause overheating.

Handle the equipment carefully.

Rough handling can cause corrosion.

Do not use chemical cleaners to clean the equipment.

Chemical cleaners can remove paint and markings.

Table of Contents

1. A WORD TO FURUNO FCV-780/782 OWNERS:	1
Features	1
2. HANDLING PRECAUTION	2
3. OPERATIONAL CONTROLS	3
4. PICTURE PAGE	5
Normal Picture	5
Bottom-lock/Bottom Discrimination Picture (BL/BD Key).....	5
A-scope Picture (A-SCOPE Key)	6
5. BASIC OPERATION	7
Power on/off.....	7
Adjusting Brilliance	7
Selecting Basic Range.....	7
Shifting Range.....	7
Selecting Presentation Mode	8
Adjusting Gain	9
Picture Advance Speed Selection	9
Eliminating Surface Noise	9
Eliminating Low Level Noise	9
Eliminating Interference.....	10
Measuring Depth to a Fish School.....	10
Detecting a Fish School or Seabed Aurally.....	10
Detecting Water Temperature Aurally.....	11
Storing/Recalling Picture.....	11
Eliminating Low Intensity Echoes	12
Selecting A-Scope Presentation	12
6. ON-SCREEN INDICATORS	13
7. MENU SCREEN SETTING	15
Operating Procedure.....	15
Description of Menu Item	16
NL (Noise Limiter) Level	16
Background	16
Signal Level (Echo Erase)	16
Hue	16
Color	16
Zoom Range	16
PL(Pulse Length)	16
KPR (Transmission Repetition Rate).....	17
Range	18
8. INTERPRETING THE DISPLAY	19
Color Bar.....	19
Zero Line	19

Seabed	20
Bottom Profile	19
Bottom Nature	20
Fish Schools	21
Fish Quantity	21
Bottom Fish	21
Others	22
Plankton	22
Current Rip	22
Surface Noise	22
Aeration	22
Zig-zag Bottom	23
False Image	23
Interference	23
9. IF SOMETHING SHOULD GO WRONG WITH YOUR UNIT	24
Operation Check	24
System Diagnosis (self-check)	26
10. SYSTEM MENU SETTING	27
Description of System Menu Item	27
11. USER HUE SETTING	32
Color Setting procedure	32
12. INSTALLATION	33
Display Unit	33
Mounting Location	33
Mounting Procedure	33
Transducer	34
Synchronizing Transmission With Other Echo Sounder	40
Connecting With Net Sonde	40
DIP Switch Setting On Main Board	40
Connecting To Other Make Position Fixing Equipment	41
Changing Output Power to 3kW	42
13. SPECIFICATIONS	43
Complete Set	45
Accessories	45
Installation Materials	45
Spare Parts	45
Transducer and Tank (Option)	46
APPENDIX 1. SCREEN DIVISION	AP-1
SCHEMATIC DIAGRAM	S-1

1. A WORD TO FURUNO FCV-780/782 OWNERS:

Congratulation on your choice of the FURUNO FCV-780 series ColorVideo Sounder! For over 40 years Furuno Electric company has enjoyed an enviable reputation for quality and reliability throughout the world. This dedication to excellence is furthered by our extensive global network of agents and dealers.

The FCV-780 series is designed and constructed to give the users many years of trouble-free operation. However to obtain optimum performance from this unit, you should carefully read and follow the recommended procedures for installation, operation and maintenance. No machine can perform to the utmost of its ability unless it is installed and maintained properly. There are two models in this series.

FCV-780: Monitor display for external echo sounder

FCV-782: 2kW or 3kW dual frequency color video sounder

Thank you for considering and purchasing Furuno equipment.

FEATURES

- 1) 8 or 16 color presentation (including background) shows detailed information on fish density and the nature of the bottom, on a medium resolution 14" diagonal CRT. Selectable background color lessens eye-fatigue in both daytime and nighttime operations.
- 2) Six basic ranges are operator-reprogrammable to suit individual fishing grounds and fishing methods.
- 3) Pulse lengths interlocked with end-of-display range in use and transmission repetition rate provide excellent short range and long performance, 0.2 to 5.0ms for ordinary use and 0.4 to 10.0ms for deep water sounding.
- 4) Combination of bottom lock and bottom discrimination display allows detailed observation of bottom fish and nature of the bottom.
- 5) Frequency mixing picture helps discriminate fish species.
- 6) Automatic bottom tracking function permits unattended range phasing operation.
- 7) Three types of alarm are incorporated: fish alarm, bottom alarm and temperature alarm.
- 8) Two types of noise limiter effectively suppresses interference from other sonars and echo sounders.
- 9) Universal 20-40 VDC power supply, drawing less than 150W of power.

2. HANDLING PRECAUTIONS

Keep magnetic materials away!

Keep away both magnetic device (loudspeaker, heavy duty transformer) and magnet sensitive device (magnetic compass, cassette tape).

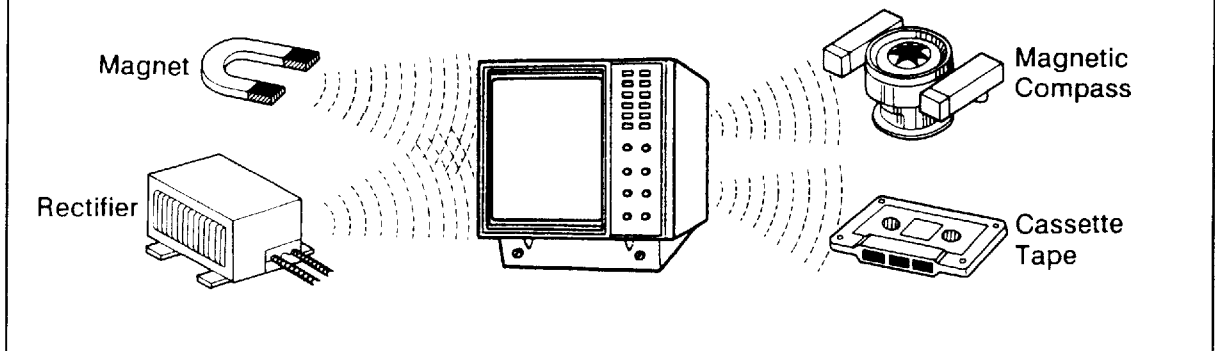

Allow service and ventilation space!

Keep the space shown, for service and ventilation.

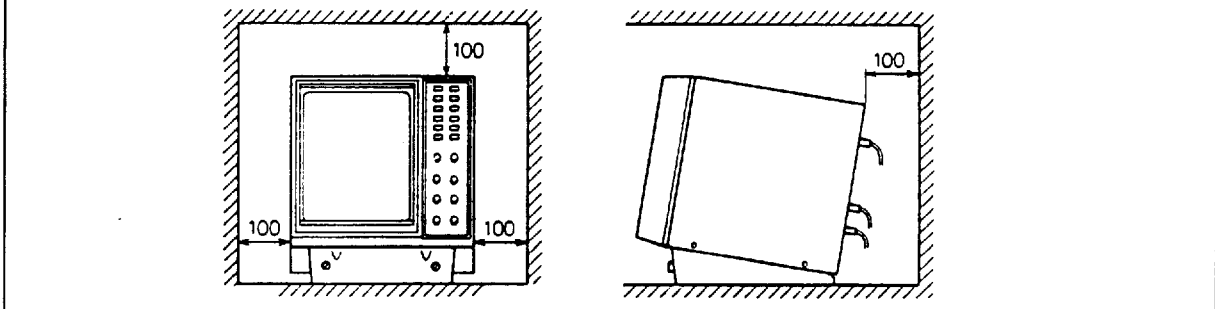

Moderate screen brightness!

Moderate the screen brightness to extend the life of the CRT.

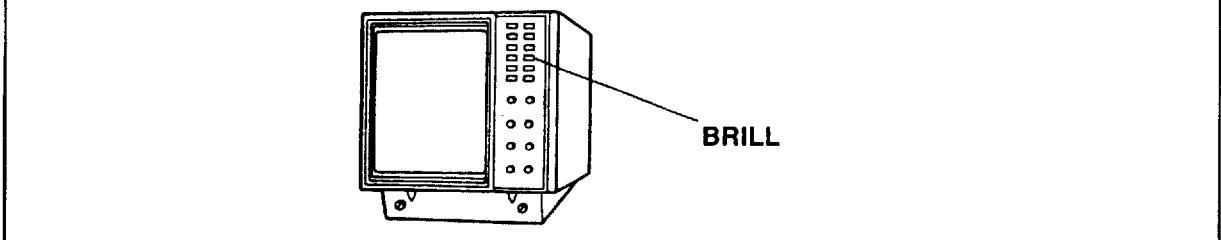

3. OPERATIONAL CONTROLS

The front part of the display unit is separated into two sections: controls on the right-hand side, and the CRT on the left-hand side.

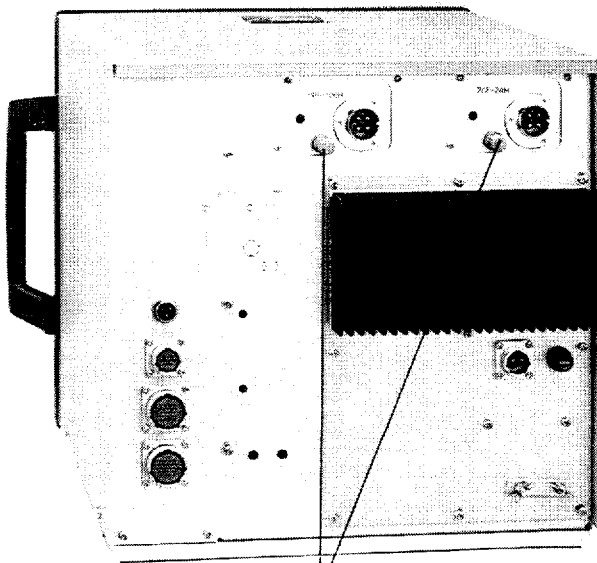

POWER REDUCTION Switch

COLOR VIDEO SOUNDER

PWR

OFF

← -

SHIFT

+ →

↑ ▲

VRM

▼ ↓

ADVNC

BRILL

MENU

SIG LEVEL

ALARM

STORE

A - SCOPE

B/L B/D

RECALL

2 3 4 5 6

RANGE

LF DUAL HF

MODE

LF

GAIN

HF











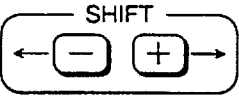

GAIN

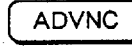
TVG

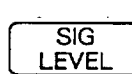
TVG

CLUTTER

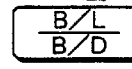
CLUTTER

KEY	FUNCTION
	Turns on the power.
	Turns off the power when pressed simultaneously with the PWR key.
	Changes the start depth of the picture. These are also used to change the menu settings.
	Moves the variable range marker (VRM). These are also used to change the menu settings.
	Selects picture advance speed.
	Adjusts screen brilliance.
	Eliminates low intensity echoes in four steps (for 8 color presentation) or eight steps (for 16 color presentation) up to yellow color echoes.
	Displays menu screen.
	Turns on/off the alarm function.
	Stores picture into the memory. Normal picture is restored automatically when the storage is completed.
	Displays A-scope picture on the right 1/3 of the screen.
	Displays bottom-lock/bottom discrimination picture in the left or lower half of the screen.
	Recalls the stored picture

SWITCH	FUNCTION
RANGE	Sets the basic display range.
MODE	Sets presentation mode.
GAIN	Adjusts picture sensitivity.
TVG	Time varied gain which adjusts picture sensitivity with respect to depth of echoes.
CLUTTER	Rejects noise appearing over the screen due to water contamination, etc.
DEGAUSS	Restores proper color.

4. PICTURE PAGE

The FCV-780/782 produce the following pictures and you may display one of them at any time you wish with the **A-SCOPE** and **BL/BD** keys.

NORMAL PICTURE

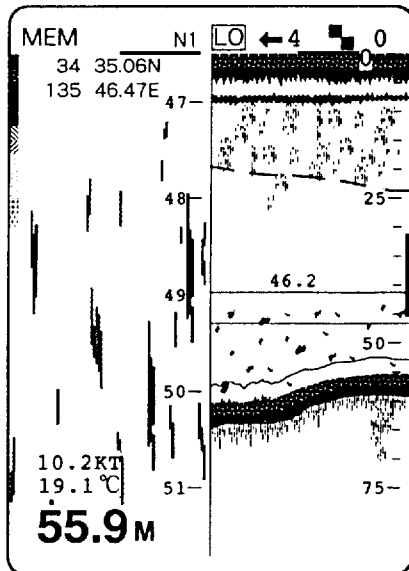

The normal echo sounder picture is displayed as selected with the **MODE** switch.

BOTTOM-LOCK/BOTTOM DISCRIMINATION PICTURE (BL/BD KEY)

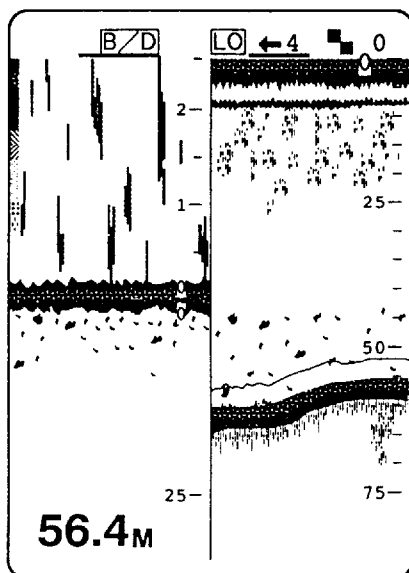

In addition to the normal picture on the right or upper half of the screen, the bottom-lock/bottom-discrimination picture is provided on the remaining half.

The bottom-lock/bottom discrimination picture is a combination display of a bottom-lock expansion picture and a bottom discrimination picture. The bottom contour is shown by a straight line in the middle of the screen and echoes above it is expanded, while the echoes below the bottom contour (bottom discrimination echoes) are displayed with the same scale as the normal picture. This will enable you to quickly discriminate bottom fish and bottom nature on the same screen.

NOTE: For the bottom-discrimination picture of the high frequency sounding, the scale is expanded twice the normal scale.

A-SCOPE PICTURE (A-SCOPE KEY)

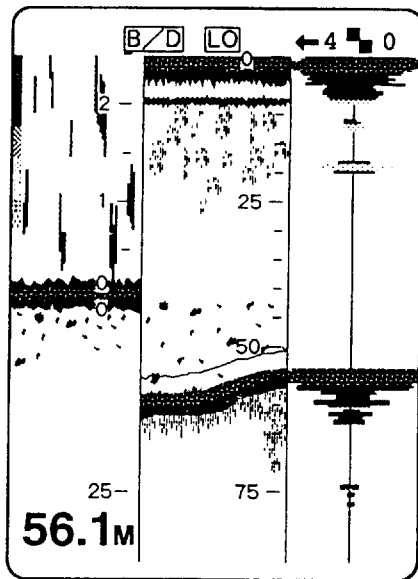

The A-scope picture on the right 1/3 of the screen displays echoes at each transmission with different amplitudes and colors depending on their intensities. It is especially useful for bottom trawler and lobster/crab potter.

5. BASIC OPERATION

The FCV-780/782 is simple to operate. Most of the major functions can be set with single key stroke and each key operation can be confirmed by double size capital letters displayed for five seconds.

Power on/off



"ON" ----- Press the **PWR** key.

"OFF" ----- Press the **PWR** and **OFF** keys simultaneously.

Adjusting Brilliance

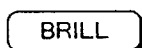

The screen brilliance is adjustable in 4 steps. Keep the moderate brilliance to extend the life of the CRT.

Selecting Basic Range

The basic range may be selected with the **RANGE** switch from six ranges listed below. The six ranges can be operator-reprogrammed as explained on page 18.

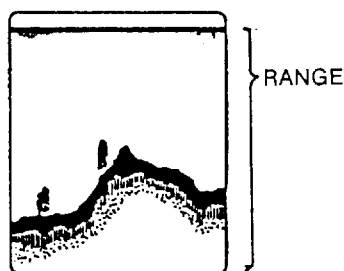

		1	2	3	4	5	6
Basic Range	M	10	20	40	80	150	300
	FT	30	60	120	250	500	1000
	FA	5	10	20	40	80	160
	P/B	6	12	25	50	100	200

Shifting Range

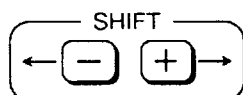

The range shift is to shift the start depth of the picture displayed on the screen with the **SHIFT** \square \square keys. If the key is kept pressed the step of shift accelerates from 1m, 10m, 100m then to 1000m steps.

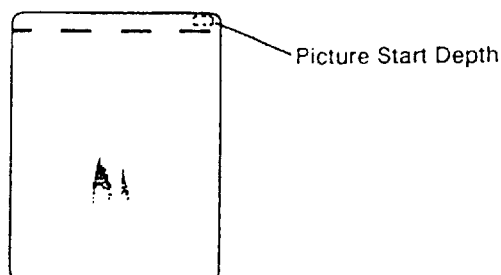
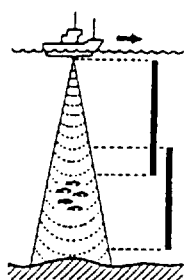

Selecting Presentation Mode

Six presentation modes are available and you may select one of them with the **MODE** switch.

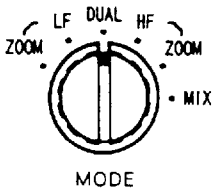

MODE	ZOOM	LF	DUAL
PICTURE	LF ZOOM LF NORMAL	LF NORMAL	LF NORMAL HF NORMAL
MODE	HF	ZOOM	MIX
PICTURE	HF NORMAL	HF ZOOM HF NORMAL	LF (HF) NORMAL MIX

NOTE: While the MIX mode is selected, the BL/BD key is disabled.

(How the MIX mode works.)

The MIX mode compares echo intensity between low and high frequencies, and displays echoes from tiny fish in discriminative colors. This is performed by utilizing widely known characteristics that tiny fish return stronger echo against a high frequency rather than a low frequency. How it actually works is shown below.

- 1) If a high frequency echo is stronger than the corresponding echo on the low frequency, the high frequency echo is displayed.
- 2) If the low frequency echo is stronger than or equal to the high frequency echo, it is less likely to be a tiny fish and therefore is displayed in blue.
- 3) If the echoes on both frequencies have the intensity corresponding to reddish brown or red, they are displayed in reddish brown or red: this is necessary to display the transmission line and seabed in reddish brown or red.

In short, the echoes displayed in orange thru light blue are likely to be tiny fish.

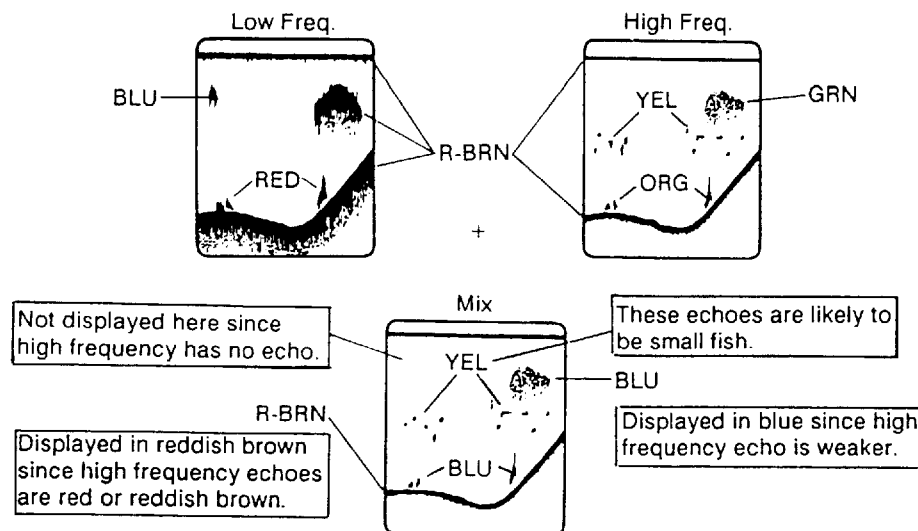

Adjusting Gain

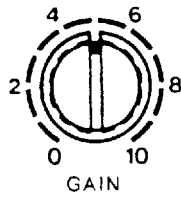

The **GAIN** control adjusts the sensitivity of the receiver. Set it to the point just below where excessive noise appears on the screen. Normally it is set between "3" and "5".

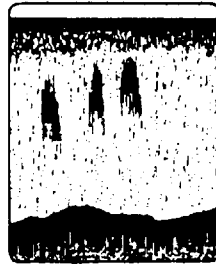

High



Proper



Low

Picture Advance Speed Selection



Press the **ADVNC** key to set the picture advance speed. Every pressing changes the on-screen indications as well as the advance speed.

←	0	1	2	3	4
Speed	Stop	Slow	Medium	Fast	Fastest

When selecting an advance speed, keep in mind that a fast advance speed will expand the size of the fish school horizontally on the screen and a slow advance speed will contract it.

Eliminating Surface Noise

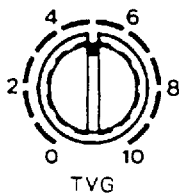

When surface noise masks a shallow target, adjust the **TVG** settings. In addition to suppressing the surface noise, the **TVG** compensates for propagation loss of sound so that the echoes from the same fish schools are displayed in the same color. Set it between "3" and "5" for normal fishing. Too high a setting may eliminate small echoes.

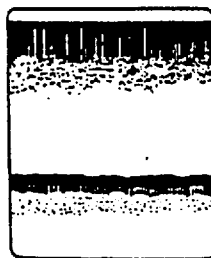

TVG "off"

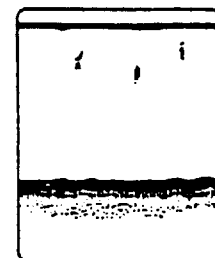

TVG "on"

Eliminating Low Level Noise

When blue dots appear on the whole screen mainly due to contaminated water, use the **CLUTTER** control to eliminate them.

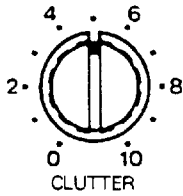

NOTE: Do not turn the CLUTTER control excessively clockwise, otherwise weak echoes may be eliminated. Normally it is recommended to set at "1" to "4" position.

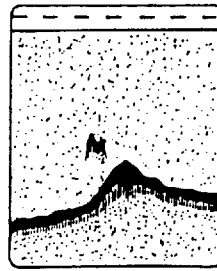

Clutter "off"

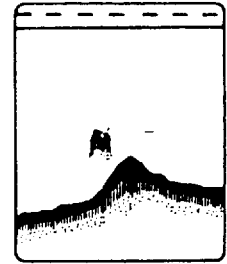

Clutter "on"

Eliminating Interference

When interference from other acoustic equipment operating nearby or other electric equipment can be seen on the screen, use the noise limiter function which can be set on the menu screen. See page 16.

Interference from nearby echo sounder

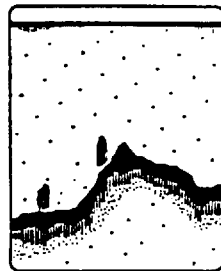



Interference from other electric devices



Measuring Depth to a Fish School



Move the VRM marker onto a fish school with the   keys, and the depth to the fish school is digitally read out at the right-hand side on the marker.

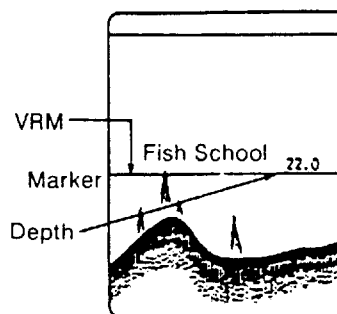

Detecting a Fish School or Seabed Aurally



The alarm function enables you to aurally detect a fish school or seabed appearing in a predetermined zone through the loudspeaker. Two types of alarm are incorporated

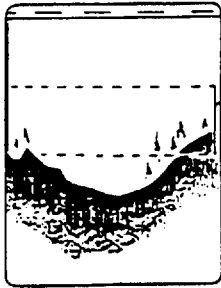
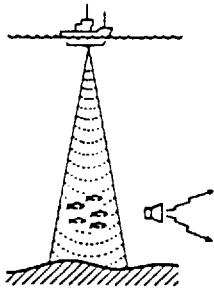

Move with the
▲▼ keys and
change length with
⊖⊕ keys

- 1) Fish Alarm (FA): Only fish echoes can trigger the alarm; the echoes below the seabed contour are ignored.
- 2) Bottom Alarm (BA): Only the seabed contour can trigger the alarm.

(Operating Procedure)

1. Select the fish alarm (FA) or bottom alarm (BA) on the system menu screen. See page 30.
2. Turn off the unit once and turn it on again.
3. Press the **ALARM** key; "ALARM" will be displayed at the top of the screen.
4. Press the **ALARM** key to turn on the alarm function and then move the alarm zone marker to the desired depth by pressing the ▲▼ keys and set the desired length by pressing the ⊖⊕ keys.

NOTE: The alarm zone marker is movable only while the "ALARM" message is displayed to the left of the screen.

5. To turn off the alarm function, press the **ALARM** key.

NOTE: An echo with a weak echo color can not trigger the alarm: the fish must be plotted in yellow or higher gradation colors in the "FA" mode and the seabed in red or reddish brown in the "BA" mode.

Detecting Water Temperature Aurally

All fish species have their respective habitable water temperature ranges. The water temperature alarm function warns you by an audible alarm that you are within or out of the desired temperature ranges.

To activate the water temperature function, press the **ALARM** key after selecting the temperature alarm (TA, BA + TA, FA + TA) and alarm temperature (TEMP LIM, TEMP ALM) on the system menu screen. See page 27 for system menu setting.

Storing/Recalling Picture

The picture displayed on the screen can be stored into the memory and can be recalled at any time.



Storing

Press the **ALARM** and **SIG LEV** keys simultaneously. The picture stops advancing and is stored into the memory. After the picture is stored, the normal picture is restored.



Recalling

Press the **BL/BD** and **A-SCOPE** keys simultaneously. The recalled picture bears MEM indication at its left top. Press the **BL/BD** and **A-SCOPE** keys again to restore the normal picture.

NOTE: Only one picture can be stored; the previous picture is erased when a new picture is stored.

Eliminating Low Intensity Echoes



When you wish to display echoes above certain level, press the **SIG LEV** key. Every pressing eliminates the weakest color echoes on the screen, up to yellow echoes with four (8 color presentation) or nine (16 color presentation) key strokes. The echoes eliminated can be identified with the color bar whose color is eliminated in the same order.

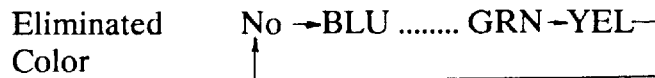

NOTE: It is possible to leave the echoes in gray color on the screen, instead of eliminating them. Refer to the menu setting "SIG LEVEL" on page 16.

Selecting A-Scope Presentation

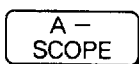

To display the A-SCOPE picture, press the **A-SCOPE** key. Echoes at each transmission are displayed with amplitudes and colors proportional to their intensities on the right 1/3 of the screen. This will enable close observation of small fish and fish near the bottom.

6. ON-SCREEN INDICATORS

The various indicators which appears on the screen are summarized below.

Normal + Zoom

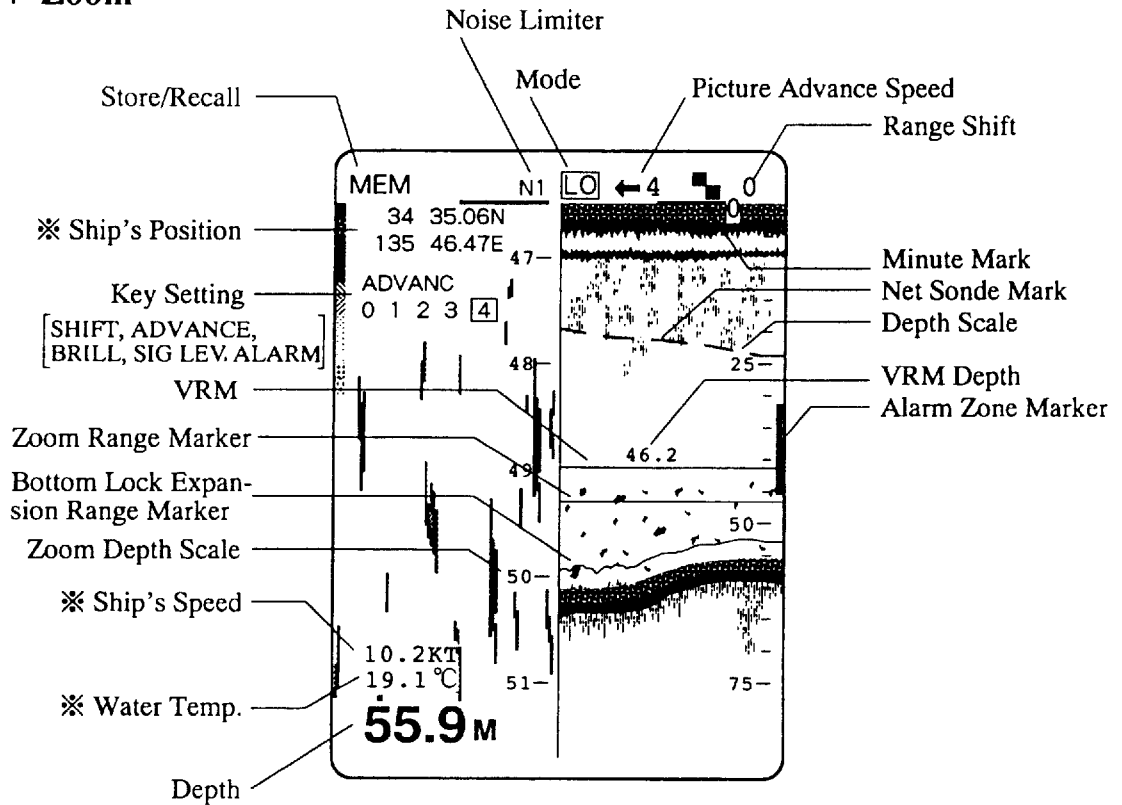

Normal + Bottom Lock/Bottom Discrimination

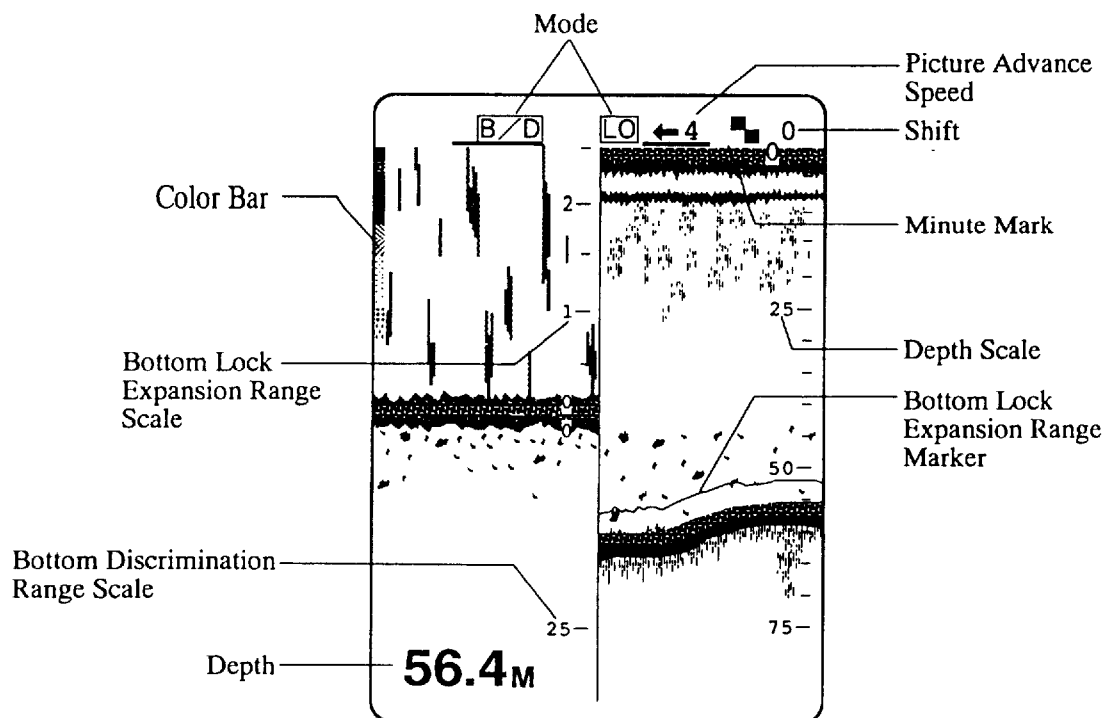

A-Scope + Normal + Bottom Lock/Bottom Discrimination

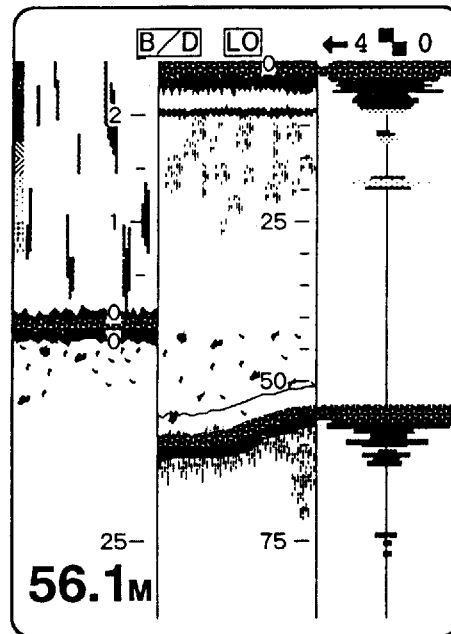

- Color Bar:** Gives reference of color gradation; reddish brown for the strongest echo to blue for the weakest echo return.
- Minute Marker:** One complete minute is shown with a 30 sec. horizontal bar and 30 sec. blank space. By observing the number of minute marks on the screen, you can determine the amount of history being displayed on the screen.
- Water Depth:** This indicator shows the depth from the transducer to the seabed. The unit is capable of reading depths beginning from 1m below the transducer. This minimum depth is necessary to prevent locking onto the surface turbulence rather than the bottom. In order to obtain depth readout, the bottom must be displayed on the screen. Correct depth readout is displayed even when the picture advance rate is set to "0".

7. MENU SCREEN SETTING

The menu screen as shown below is displayed when the **ADVNC** and **BRILL** keys are pressed simultaneously. You may set or select those functions that are not frequently altered in daily use if they have been once preset according to your fishing conditions and preferences

NL LEVEL	: OFF	N1	N2	N3
BACKGROUND	: BLK	D-BLU	BLU	
SIG LEV	: NORM	GRY		
HUE	: STD	DAY	NIGHT	USER
COLOR	: 8COL	16COL		
ZOOM RANGE	: 80	2.5	5	
PL	: SHORT	MID	LONG	
KPR	: 10	(0->10, S)		
RANGE1	: 5	10	20	
RANGE2	: 10	20	30	
RANGE3	: 30	40	50	
RANGE4	: 60	80	100	
RANGE5	: 120	150	200	
RANGE6	: 200	300	400	

▲	▼	KEYS TO SELECT ITEM.
-	+	KEYS TO SELECT PARAMETER.
ADVANC	BRILL	KEYS SIMULTANEOUSLY TO EXIT.

Operating Procedure

1. Press the **ADVNC** and **BRLL** keys simultaneously.
2. Select the desired item with the ▲▼ keys. The selected item is highlighted in green.
3. Select the desired setting with the +− keys. The selected setting is enclosed in a white frame.
4. Repeat steps 2 and 3 to change the settings of other items

5. To turn off the menu screen, press the **ADVNC** and **BRILL** keys simultaneously.

Description of Menu Item

NL (Noise Limiter) Level	<p>When the interference from other echo sounders operating nearby or other types of electrical interference exists, you may use the noise limiter to eliminate or reduce the interference. The "OFF" position turns off the noise limiter function. Position "N3" offers the highest degree of noise rejection. The status of the noise limiter, OFF, N1, N2 or N3 is indicated on the screen.</p> <p><i>NOTE: If the noise limiter is left in N3 when no interference exists, weak echoes may be missed or eliminated.</i></p>
Background	<p>This item determines the background color of the picture; black, deep blue or blue</p>
Signal Level (Echo Erase)	<p>This item selects whether you erase echoes completely or leave them in gray when they are eliminated with the SIG LEV key.</p> <p>NORM: erased completely GRAY: left in gray</p> <p><i>NOTE: The echoes left in gray are displayed with different brilliance gradations depending on their intensity.</i></p>
Hue	<p>In this item, you may select the desired picture colors. Note STD is the standard colors which are employed in most of our video sounders and USER is the user colors which you may program as shown on page 32.</p>
Color	<p>This item sets the number of colors used for presentation; 16 or 8 colors.</p>
Zoom Range	<p>In this item, the display range of the zoom picture can be selected from three ranges: 2.5m, 5m, 10m, 20m, 40m and 80m</p>
PL(Pulse Length)	<p>The transmission pulselength can be changed in three steps in this item. In addition to this setting, the pulselength is interlocked with the display end depth.</p> <p><i>NOTE: The pulselength change in 0.01ms steps for display end depth greater than 10m.</i></p>

Display End Depth	Pulse Length (ms)		
	Short	Mid.	Long
10	0.20	0.20	0.40
20	0.20	0.32	0.64
40	0.26	0.52	1.04
80	0.43	0.85	1.7
100	0.50	1.00	2.0
150	0.57	1.3	2.6
200	0.80	1.6	3.2
250	0.95	1.9	3.8
300	1.1	2.1	4.2
400	1.3	2.6	5.2
500	1.5	3.0	6.0
600	1.7	3.5	7.0
800	2.1	4.2	8.4
1000	2.5	5.0	10.0

KPR (Transmission Repetition Rate)

The transmission repetition rate may be changed in 11 steps (0- 10). Normally the highest rate "10" is used (factory setting). However, when the receiver gain seems to be low, reduce the rate to "0-4"; the transmission pulselength increases, resulting in improvement of receiver sensitivity.

In case the second reflection echoes of seabed of the last transmission appears between the sea surface and the seabed in shallow water, it is also recommended to reduce the rate.

The "S" demotes the ship's speed dependent mode, where the transmission rates changes automatically according to the ship's speed.

(KPR set to "10")

Display End Depth (m)	Transmission Rate (times/minute)				
	PL Short	PL Mid.	PL Long	S *4 (2KTS)	S *4 (20KTS)
0 to 20	600	400	200	40	400
21 to 40	400	250	150	25	200
41 to 80	300	150	90	15	150
81 to 200	200	100	50	10	100
210 to 400	100	60	30	6	60
401 to 640	60	40	20	4	40
641 or greater	*1	*2	*3	*2-10	*2

NOTE: 1. *1 = 45000 - (Display end depth) x 1.2
 *2 = 45000 - {(displat end depth) x 1.2} x 0.7
 *3 = 45000 - {(display end depth) x 1.2} x 0.35
 2. *4: Pulse length at "Mid."

(Advantage of ship's speed dependent mode)

NOTE: For the ship's speed dependent mode, ship's speed information must be fed from the external navigation equipment.

As you may be aware of, a target is plotted wider horizontally when the ship's speed is low and tends to appear narrow when high because the time it takes for the ship to pass over the target differs. Thus you must always bear in mind the ship's speed when judging the size of a target (fish school) on the screen.

The solution for this inconvenience is the "S" (Ship's Speed dependent) mode. Since the transmission rate and as a result the picture advance speed changes inproportion to the ship's speed, the horizontal scale of the picture is not influenced by the change of ship's speed and you can directly compare the sizes of fish schools with the echoes on the screen.

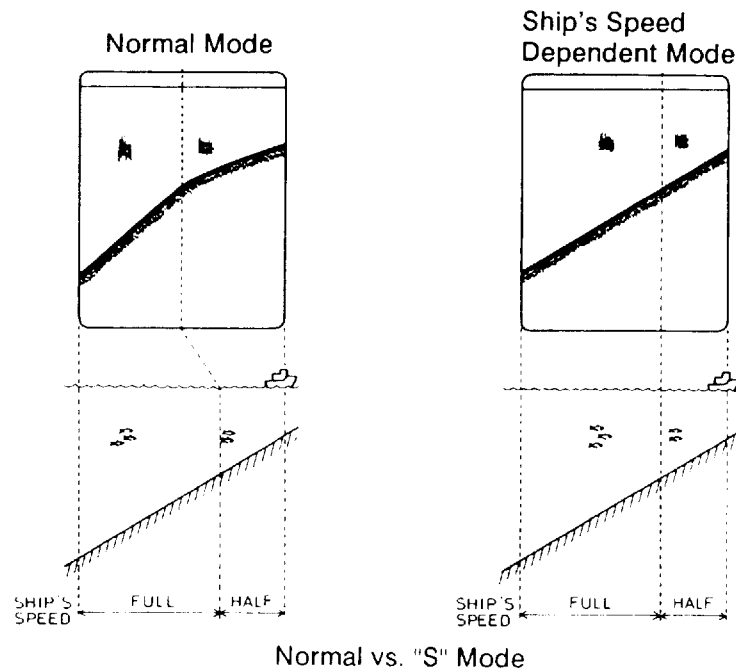

Range

This item permits reprogramming of the factory set ranges. Any range can be replaced with one picked up from the table below.

No.	Meter	Feet	Fathom	P/B	No.	Meter	Feet	Fathom	P/B
1	5	16	2.5	3	12	200	600	100	120
2	10	30	5	6	13	250	800	120	160
3	20	60	10	12	14	300	1000	160	200
4	30	100	16	20	15	400	1200	200	250
5	40	120	20	25	16	500	1600	250	300
6	50	160	25	30	17	600	2000	300	400
7	60	200	30	40	18	800	2500	400	500
8	80	250	40	50	19	1000	3000	500	600
9	100	300	50	60	20	1200	4000	600	800
10	120	400	60	80	21	1500	5000	800	1000
11	150	500	80	100	22	2000	6000	1000	1200

8. INTERPRETING THE DISPLAY

Using some typical examples, this section describes how to interpret the echogram.

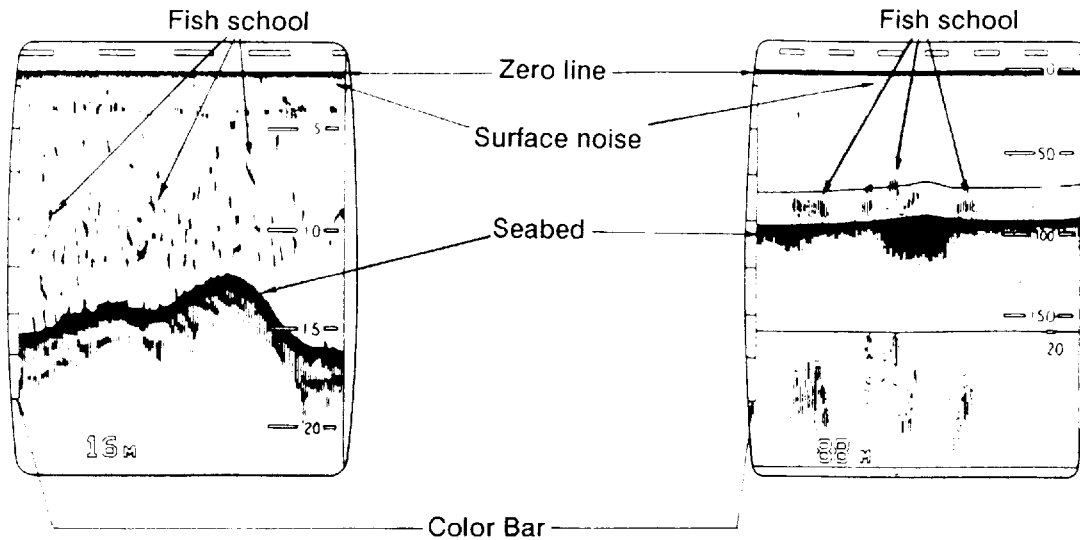

Color Bar

The color bar shows the relation between echo intensity and echo color on the screen. The top color (reddish brown) is used for the strongest and the lower colors for the weaker echoes. It can be used as a reference to estimate density of a fish school, fish species and hardness of seabed from the picture. The background color can be selected on the menu screen, according to environment.

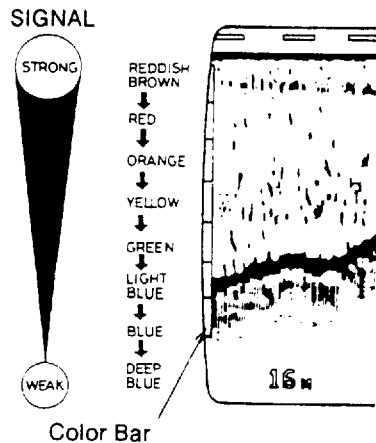

Zero Line

The zero line represents the transducer's position, and moves off the screen when a phased range is used, or it moves up or down on the screen when the DRAFT value is changed.

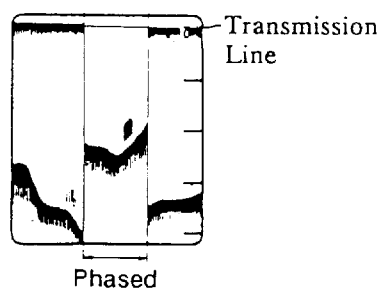

SEABED

Seabed echoes are normally strong and displayed in reddish brown or red, but colors and width will vary with bottom material, water depth, frequency, pulselength and sensitivity.

Bottom Profile

A hard and rough seabed appears with a longer tail because it reflects more of the ultrasonic pulse. Because of their stronger return, shallow seabed echoes appear wider than deep ones even when all bottom conditions are equal. Also, a longer seabed tail appears on slopes because of the difference in traveling time at both edges of the beam angle. In the rugged bottom, echoes are reflected on many different planes, overlapping to present a three dimension effect.

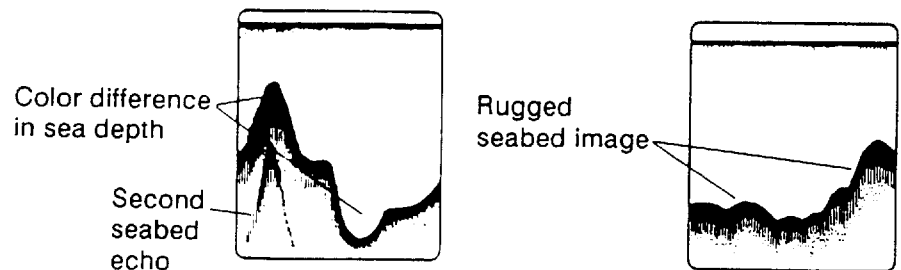

Bottom Nature

The nature of the seabed is known from the intensity and length of the seabed tail. Generally, when observing the seabed nature, lower sounding frequency is used, the pulselength is set to long and the gain setting is kept unchanged. In the hard and craggy bottom, the seabed appears in reddish brown with a long tail. In the muddy or sandy bottom, the echoes appear less reddish and with a short tail. However, the bottom with sediment may give a long tail if a low frequency sounding is used

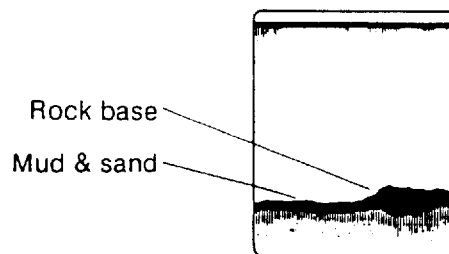

FISH SCHOOLS

Fish Quantity

Fish quantity can be estimated to a certain extent from fish echoes on the screen if the following two basic characteristics are kept in mind.

Size of Fish School

Usually the size of fish echoes on the screen is proportional to the actual size of fish school. However, if two fish echoes appear at different depths with the same size, the fish school at shallower depth is larger because the ultrasonic beam widens as it propagates and fish school in deep water is displayed larger.

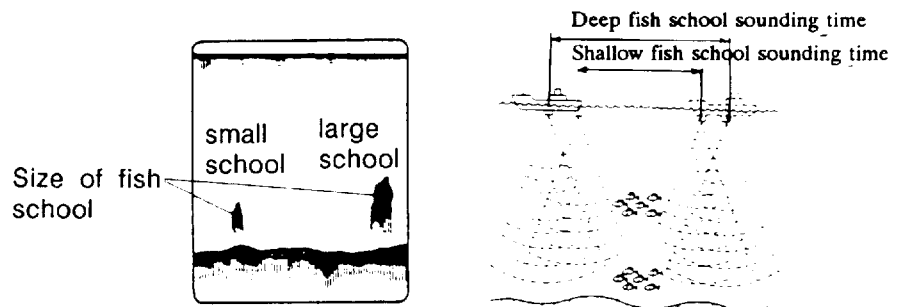

Density of Fish School

If two fish schools appear with the same color at different depths, the one in deeper water is denser because the ultrasonic wave attenuates as it propagates and the fish school in deep water tends to be displayed in a weaker color.

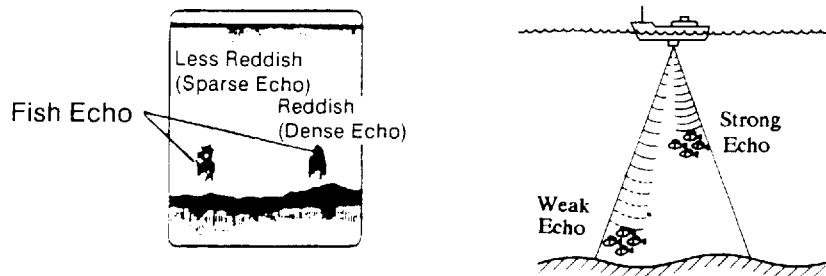

Bottom Fish

Bottom fish can be easily distinguished from the seabed because both are displayed in different colors. Thus, a white line is not required as it is with a recording paper echo sounder.

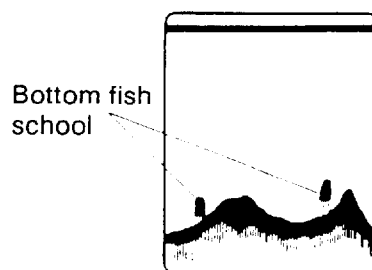

OTHERS

Plankton

A plankton layer, a likely place to find fish, is displayed in green or blue dots. It usually descends in the day and rises at night.

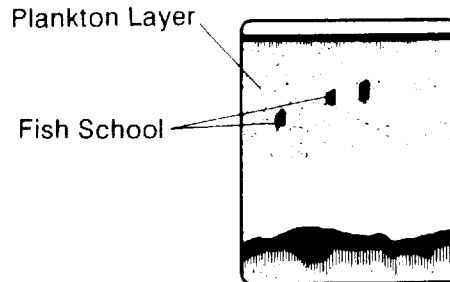

Current Rip

If two ocean currents meet with different speeds, directions and water temperatures, a current rip is developed. Since plankton and air bubbles collect there, a current rip on-screen appearance would be similar to the figure at right.

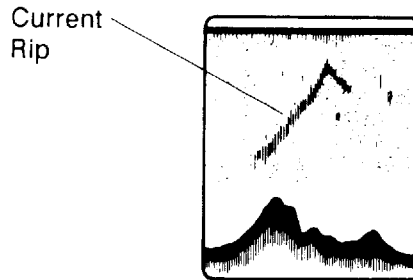

Surface Noise

When the sea is rough or the ship passes over a wake surface noise may appear. Adjust the TVG control or CLUTTER settings to clear surface clutter.

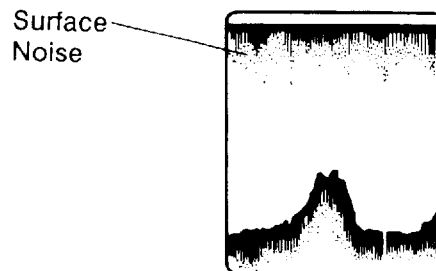

Aeration

When the sea is rough or the ship makes a quick turn, the echogram is occasionally interrupted due to air bubbles blocking propagation of wave. Generally low frequency waves are interrupted more easily than high ones.

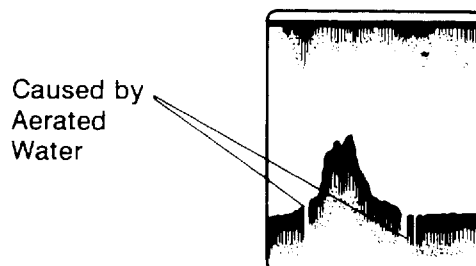

Zig-zag Bottom

The bottom contour zig-zags when the ship rolls and pitches heavily because the sounding direction fluctuates and the distance to the seabed varies.

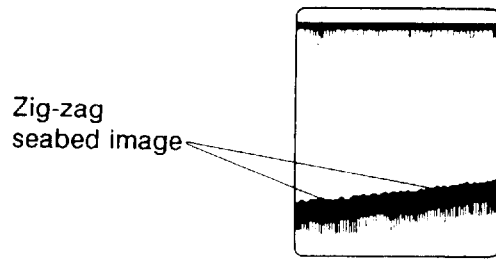

False Image

The following false echoes are detected by the side lobe of the ultrasonic wave.

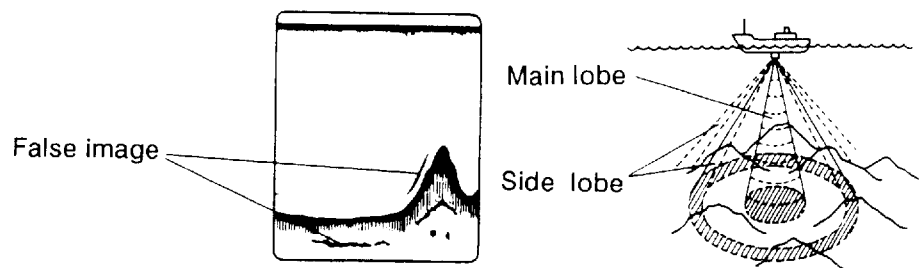

Interference

Interference (from ship vibration, engine noise, electric equipment, other echo sounders, sonar etc.) may sometimes appear on the screen. Most interference can be rejected by the Noise Limiter. See page 16. Interference appearing at the same interval or near the transmission keying rate may not be rejected.

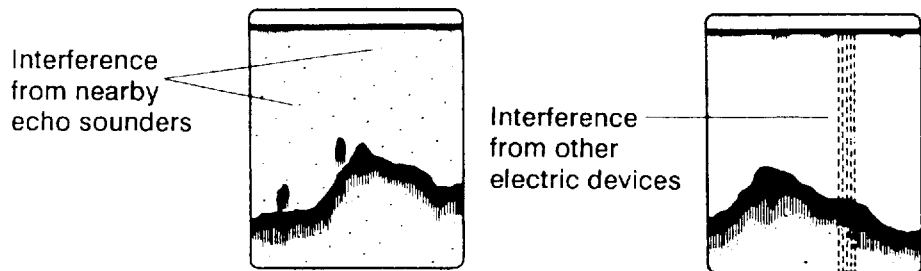

9. IF SOMETHING SHOULD GO WRONG WITH YOUR UNIT

If the unit does not operate properly, perform the following operation check to determine whether your unit is really defective. If there is a problem, proceed to the system diagnosis section (p.26) and report the results at service call.

Operation Check

No Echo Presentation, But Scale Shows

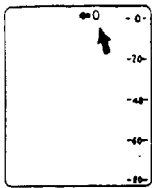

Is the **ADVANC** (picture advance speed) key set to "0" (stop)? Normal setting is "4".

Is the combined echo sounder properly operating (when the FCV is used as a monitor)

No Zero Line/Zero Line not in Position

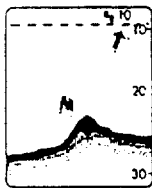

Is the range shift reading "0"? If the range is shifted several meters or more, the zero line is not displayed.

Is the ship's draft set on the system menu screen?

If the ship's draft has been set, the zero line is displayed at the draft depth.

Low Sensitivity

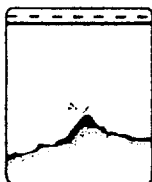

Are the **GAIN/TVG** controls properly set?

Is the **POWER REDUCTION** switch set to "D" position?

Zigzagged Seabed Trace/Occasional Loss of Echo

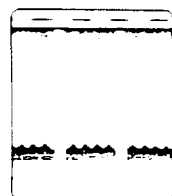

Is the sea rough? Zigzagged seabed trace is plotted when the boat pitches and rolls.

When the boat passes through aerated water, propagation of sound wave is blocked, causing loss of echo plotting. This often occurs when crossing a wake.

No Depth Readout/Bottom-Lock Inoperative

Is the seabed echo present within the normal picture range?

Is the seabed echo strong enough; i.e., red or reddish brown?

Automatic Bottom Tracking Inoperative



Is the seabed return strong enough, reddish brown or red"?

Picture Distorted

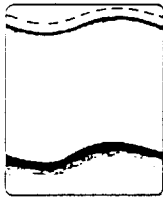

Is the magnetic field generator (heavy duty transformer, rectifier, etc.) nearby?

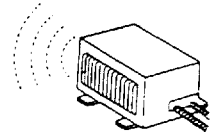

Color Impurity in a Particular Area

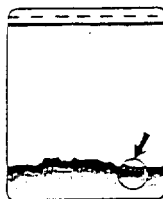

Is the magnetic field generator near the screen?



Occasional Disturbance and Random Noise



Are the connection cables laid near pulse generating equipment or their cables? If so, separate them.

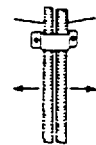

Heavy Noise and Interference



Is the **GAIN** and **CLUTTER** controls set properly?

Is the **NL** (interference rejector) on the menu screen set properly?

Is the equipment properly grounded with a copper strap?

SYSTEM DIAGNOSIS (SELF-CHECK)

Your unit is provided with the self-check facilities which may be initiated by the following operation.

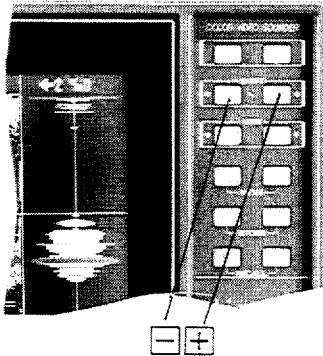

- 1) Turn off the unit.
- 2) Turn on the unit while pressing the \ominus or \oplus key. In a few seconds, the self-check page is displayed on the screen as follows.
- 3) After the keyboard check, press the **BL/BD** key to proceed to the DSP check.

SELF CHECK			
COL PATTERN	DSP CHK	KEY BOARD CHK	
	MAIN CPU	SHIFT	
	0252078 - **	-	+
	ROM OK	0	0
	SRAM OK	▲	▼
	DRAM OK	0	0
	CIF OK	ADVANC	BRILL
		0	0
		SIG LEV	ALARM
		0	0
		A-SCOPE	B/D
		0	0
	SUB CPU		
	0252079 - **		
	ROM OK		
	SRAM OK		
	DRAM OK		
	MAIN ↔ SUB OK	RANGE	MODE
		3	3
	PULSE OK	CLUTTER	
		8	11
	TX-L *** kHz		
	TX-H *** kHz		

Keyboard Check

If the figure changes when each switch or key is operated, the switch/key function is normal.

Press the BL/BD key to proceed to the DSP check.

DSP Check

ROMs, RAMs and communication line between CPUs are checked for normal operation. If the device checked is in good condition, "OK" is displayed.

In the checks of DRAM and SRAM, the screen is repeatedly painted with several colors and "OK" is displayed if they are in good conditions. If they are abnormal, the check result is not displayed.

Pulse Check

The keying pulse (KP) to drive the transmitter circuit is checked for normal operation.

Note: To conduct the CIF check, test cable (factory use only) is required.

- 4) To turn off the system diagnosis, turn off the unit.

10. SYSTEM MENU SETTING

It is necessary to change/confirm the system menu settings according to user's preference, combined navigation equipment, etc.

1. Turn on the unit by pressing the **ADVNC**, **BRILL** and **PWR** keys simultaneously for a few seconds. The system menu will be displayed.
2. Check that settings of all menu items conform to combined navigation equipment and user's preference. If not, change the settings with the \square , \oplus , \blacktriangle and \blacktriangledown keys. Refer to page 15 for key strokes required to change settings.

Description of System Menu Item

* Factory setting

ITEMS	PARAMETER	FUNCTION
LAN- GUAGE	JPN *ENG	Language selection: Japanese or English
UNIT	M FT FA P/B	Unit selection
SCALE	*RIGHT LEFT OFF	Selection of depth scale position on the screen.
SHIFT	*MAN AUTO	Manual or automatic shift selection The automatic shift function automatically locates the seabed trace on the lower half of the screen; the range window jumps up when the seabed trace rises over the center of the screen and jumps down when it reaches the bottom of the screen. <i>NOTE: The shift $\square\oplus$ keys are disabled while the AUTO shift is in operation.</i>

DRAFT	-6.0m to 60m	Ship's draft setting If the ship's draft level is set, the picture starts from the depth of the ship's bottom. It can be set from -6m to 60m in 0.1m steps.
SCREEN DIV	*VERT HOR	Screen division selection for dual picture display VERT: divided into left and right halves HOR: divided into upper and lower halves
MIX MODE	L/M H/M MIX	Selection of MIX mode pictures L/M Low frequency and mix pictures H/M High frequency and mix pictures MIX Mix picture only
FNZ DSP	*H L OFF	Selection of pictures to which the net sonde markers are plotted. L plotted on the low frequency picture LH plotted on both low and high frequency pictures
NAV DATA	*LC LA DECCA GPS GPS DR OTHR	Selection of the navigation equipment from which the ship's position data is entered LA Loran-A navigator LC Loran-C navigator DECCA Decca navigator GPS GPS navigator DR DR navigator (Set-nav connected with gyro and speed log) OTHR ... Omega or other navigation equipment <i>NOTE: For sat-nav combined with Loran-A or C in FURUNO CIF data format, select LA or LC.</i>
NAV FOR-MAT	*CIF NMEA	Selection of input/output data format.
BAUD RATE	600 1200 2400 *4800	Selection of baud rate of the depth data output.
POS DATA	*LL LOP	Selection of ship's position display LL Latitude/longitude LOP ... Line of position of the loran system.
DATA DSP	*ON OFF	On/off of the data display; ship's speed, water temperature and ship's position

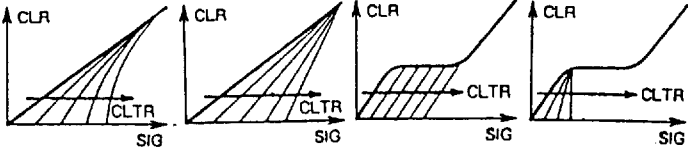
BACK-UP	*ON OFF CHECK	<p>On/off of the memory back-up</p> <p>ON: Control panel keys and menu settings are preserved in the memory and the unit starts with those settings when switched on next time.</p> <p>OFF: The unit starts with the factory settings.</p> <p>CHECK: Check of the back-up memory IC. Restart the unit after selecting this parameter, and the check screen appears; the memory IC is in good condition if the two OKs are displayed.</p>
LOG	*OFF ON	<p>On/off of the ship's speed data from speed log.</p> <p>Set to "ON" to use the speed data from the speed log and "OFF" to use that from the navigation equipment.</p>
TX SYNC	*INT EXT	<p>Synchronizing transmission with other equipment.</p> <p>If two or more echo sounders/sonars are operated simultaneously, mutual interference may result due to synchronous transmission. This menu is used to synchronize transmissions/turn off synchronization. Refer to page 40 for connection to other equipment.</p>
CLUTR CRVE	C1 C2 C3 C4	<p>Clutter curve selection</p> <p>C1: Normal curve: employed in most of Furuno color video sounders.</p> <p>C2: Linear curve</p> <p>C3: Medium level echo color (yellow) emphasis curve 1 Large proportion of an echo is displayed in the medium level color and it changes to lower level colors as the CLUTTER control is turned clockwise, without affecting echoes displayed in strong level colors.</p> <p>C4: Medium level echo color (yellow) emphasis curve 2. It is the same as C3 except that the medium to high level echoes are not affected with the CLUTTER control setting. Only the low level colors as the CLUTTER control is turned clockwise.</p> <div style="text-align: center;">  <p style="display: flex; justify-content: space-around; margin-top: 10px;"> C1 C2 C3 C4 </p> </div>

NL METHOD	*M1 M2	Selection of interference rejection method M1: Echoes in the same position are correlated for a few transmission cycles. This method is employed in most of Furuno color video sounders. M2: In addition to echoes in the same position, echoes in the neighbouring positions are correlated for a few transmission cycles. Compared to "M1", it features that echo outline becomes clear and echo size is not affected by the correlation.
A-SCOPE	*NORM E1 E2	Selection of echo amplitude in A-scope mode. NORM: Linear curve where echo amplitude on the screen is proportional to the echo level. E1: Logarithmic curve where amplitudes of strong echoes are emphasized E2: Logarithmic curve where amplitudes of medium level echoes are emphasized. Yellow color has the largest amplitude and the amplitude goes smaller for both stronger and weaker echo colors.
ADVNC DIR	*LEFT RIGHT	Selection of picture advance direction.
B/L RANGE	*2.5m to 80m	Selection of bottom lock expansion range:2.5, 5, 10, 20, 40, 80 m
ALARM	*BA FA TA BA + TA FA + TA	Selection of alarm function BA: Bottom Alarm FA: Fish Alarm TA: Temperature Alarm
TEMP UNIT	*°C °F	Temperature unit selection
TEMP LIM	-5°C to +35°C	Setting of threshold temperature to trigger the water temperature alarm; can be set in 0.1 degree steps between -5 ° and +35°C (20° and 90°F)
TEMP ALM	*UP DOWN	Selection of the temperature range in which the water temperature alarm is activated UP: Alarm is activated while the water temperature is above the threshold temperature set at the TEMP LIM item. DOWN: Alarm is activated while the water temperature is below the threshold temperature.

TEMP GRPH	*OFF ON	On/off of the temperature graph
--------------	------------	---------------------------------

NOTE: Keep the BACK-UP "ON" always, otherwise the unit operates in Japanese language.

11. USER HUE SETTING

In addition to the factory-programed hue; **STD**, **DAY** and **NIGHT** on the menu. You may program a desired hue and store it as **USER** of the **HUE** item on the menu.

Color Setting procedure

1. Turn power on while pressing the **SIG LEV** key; press and hold **PWR** and **SIG LEV** keys for a few seconds. The picture will be displayed with the hue previously stored (or factory-set) as the **USER** hue.
2. Press the **ADVNC** and **BRILL** keys simultaneously, the hue set menu as shown below is displayed.
3. Set the picture brilliance to "1" with the **BRILL** key.
4. Select the color to be changed with the \square , \oplus , keys; "F" demotes strongest echo color and "0" background color.
5. Observing the color bar or echoes displayed at the upper part on the screen, change the colors with the \blacktriangle , \blacktriangledown , **ALARM** and **SIG LEV** keys.
6. Repeat steps 4 and 5.
7. Select other picture brilliance and repeat steps 4 to 6.
8. To restore normal operation, turn power off and on.

(USER HUE SETTING MENU)

Level	USER			STD		
	R	G	B	R	G	B
F	7	0	0	7	0	0
E*	9	0	0	9	0	0
D	C	0	0	C	0	0
C*	F	0	0	F	0	0
B	F	5	0	F	5	0
A*	F	8	0	F	8	0
9	F	B	0	F	B	0
8*	F	F	0	F	F	0

12. INSTALLATION

DISPLAY UNIT

Mounting Location

Install the display unit at such place,

- * at least one meter away from magnetic field generating device.
- * not exposed to direct sunlight and water splash
- * free from electric noise and interference
- * away from radiotelephone and its feeder cable

Allow service/ventilation space indicated below.

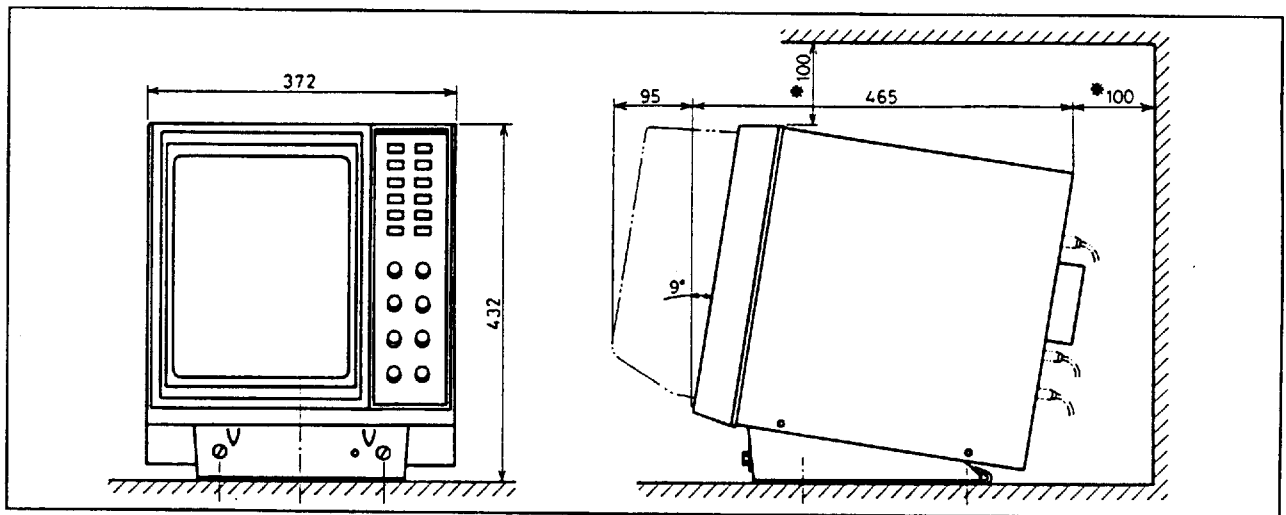

Mounting Procedure

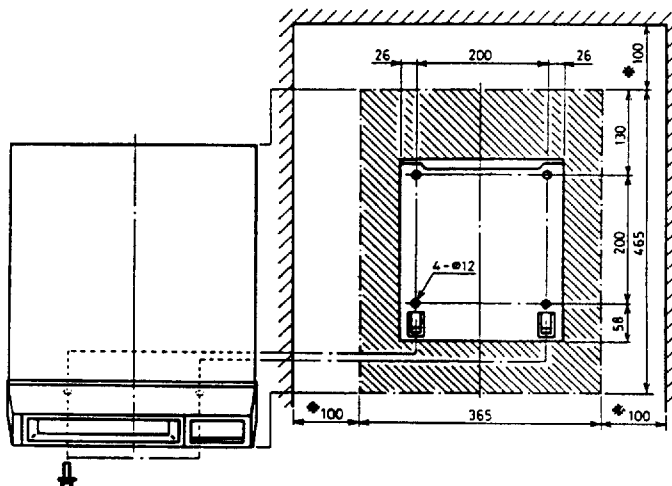

1. Drill four $\phi 12$ mm fixing holes on the planned position, referring to the figure at left.
2. Fix the mounting base by using four fixing screws or bolts and nuts.
3. Set the display unit onto the mounting base.

Cable Fabrication

The cable shield must be grounded thru the connector clamp as below. Applicable connectors are; EXT-H, EXT-L LOG and CIF/NMEA (SRCN and FM type connectors).

1. Solder the cable to the connector pins.

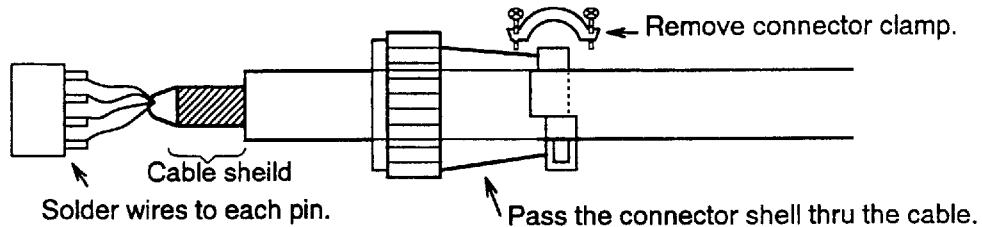

2. Wind shield tape supplied.

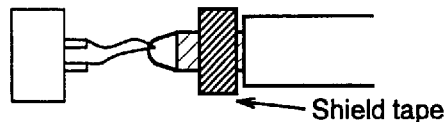

3. Screw the shell on the connector. Fix the connector onto the cable by tightening the clamp.

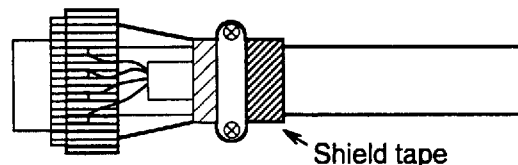

Transducer

The performance of the color video sounder depends greatly upon the transducer position. A place least affected by AIR BUBBLES should be selected since turbulence blocks sounding capability. Also select a place least influenced by ENGINE NOISE. It is known that bubbles are at a minimum at the place where the first bow wave falls and the next wave rises at general cruising speed. In small slowspeed boats, the position between 1/3 and 1/2 of ship's length from the bow is usually a good place.

NOTE: The face of the transducer must be facing the sea bottom in normal cruising trim of the boat.

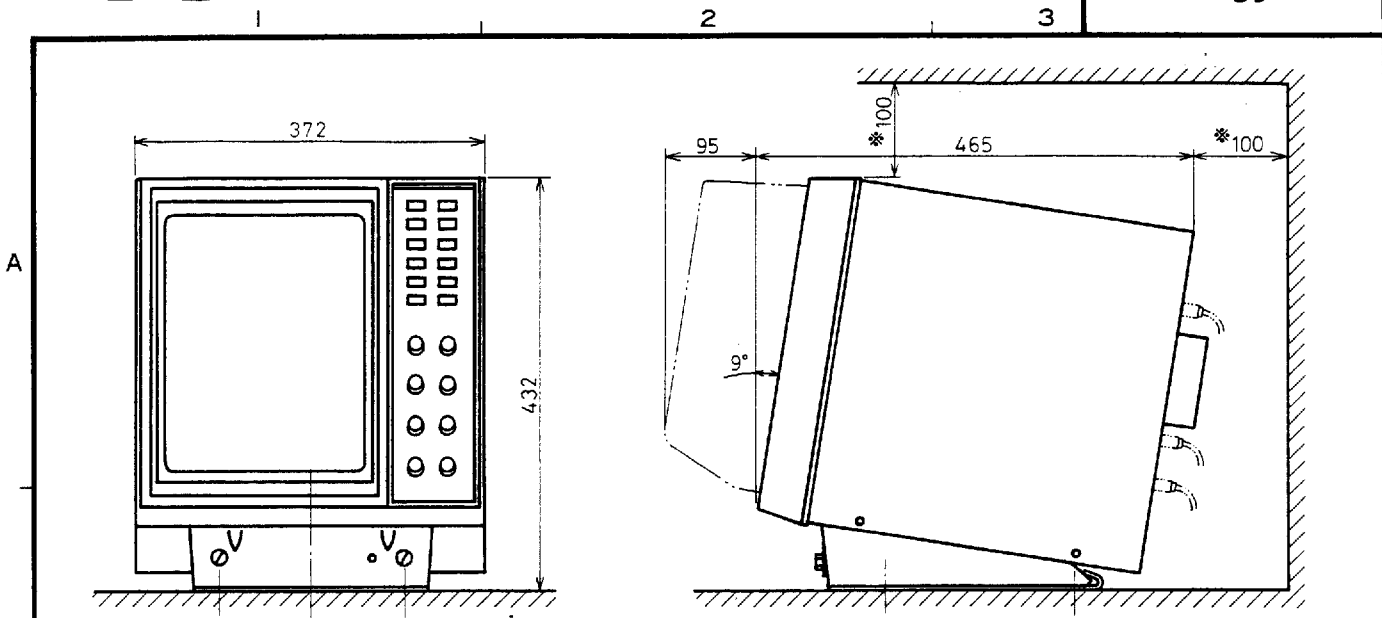

後面図 REAR VIEW

取付寸法 MOUNTING DIMENSION

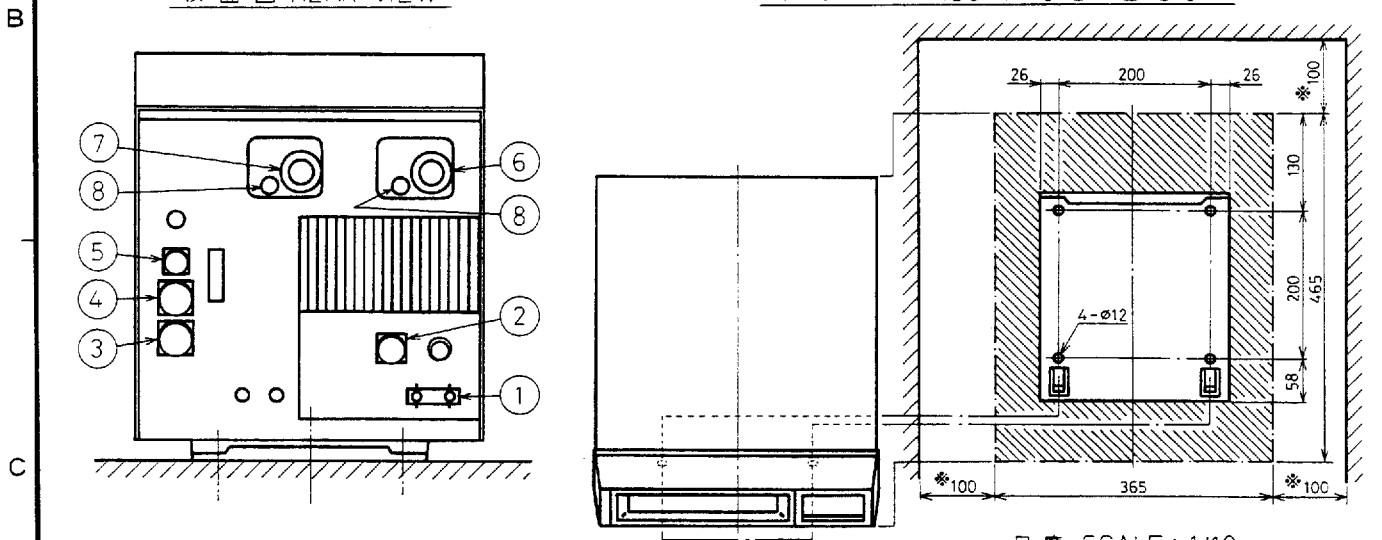

※:推奨サービス空間
RECOMMENDED SERVICE SPACE

尺度 SCALE: 1/10
単位 UNIT: mm

8	出力低減スイッチ POWER REDUCTION SW		2		
7	HF送受波器コネクタ HF TRANSDUCER CONNECTOR		1		
6	LF送受波器コネクタ LF TRANSDUCER CONNECTOR		1		
5	航法装置接続コネクタ NAV EQUIPMENT CONNECTOR		1		
4	LF付加装置用コネクタ LF CONNECTOR FOR OPTION		1		
3	HF付加装置用コネクタ HF CONNECTOR FOR OPTION		1		
2	電源コネクタ POWER CONNECTOR		1		
1	アース GROUND		1		
品番 ITEM	品名 NAME	材質 MATERIAL	数量 Q'TY	図番 DWG. NO.	摘要 REMARKS

承認 APPROVED	JUL.17.'90 T. NAKANO	三角法 THIRD ANGLE PROJECTION		名称 TITLE 指示器 FCV-780/782 DISPLAY UNIT	
検図 CHECKED	JUL.17.'90 M. USUDA	尺度 SCALE	1/8		
製図 DRAWN	JUL.17.'90 TOMITA	重量 WEIGHT	約 24.5kg APPROX. 24.5kg	図番 DWG. NO.	C2329-G01-B

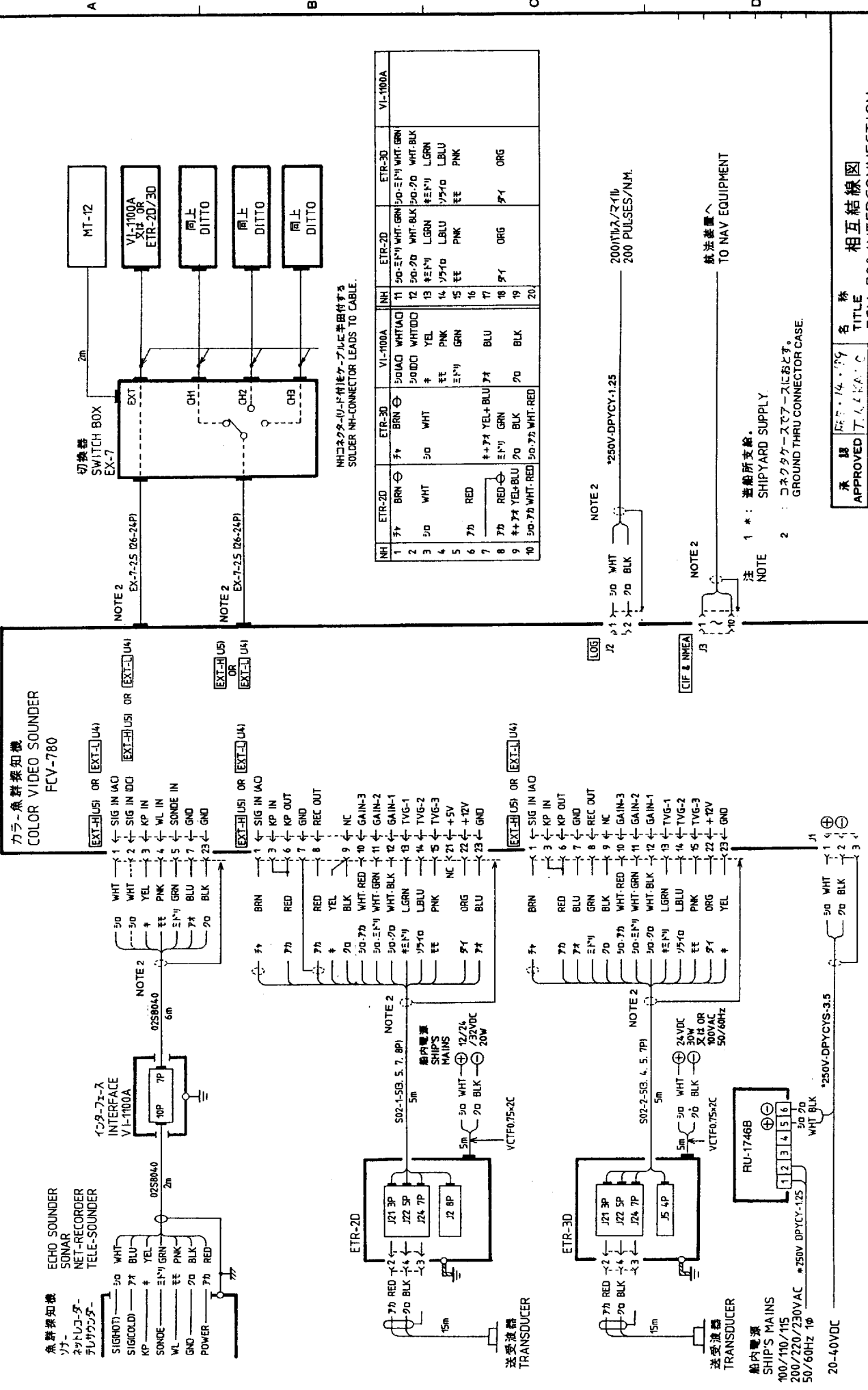

承認 承認者: 1/4/199
APPROVED T. KAKI
検閲 検閲者: F. ...
CHECKED
製図 製図者: F. ...
DRAWN 製図番号: 11. ...

名称 相互結線図
TITLE FCV-780 INTERCONNECTION
DIAGRAM
図番 G2329-C02-D
DWG. NO.

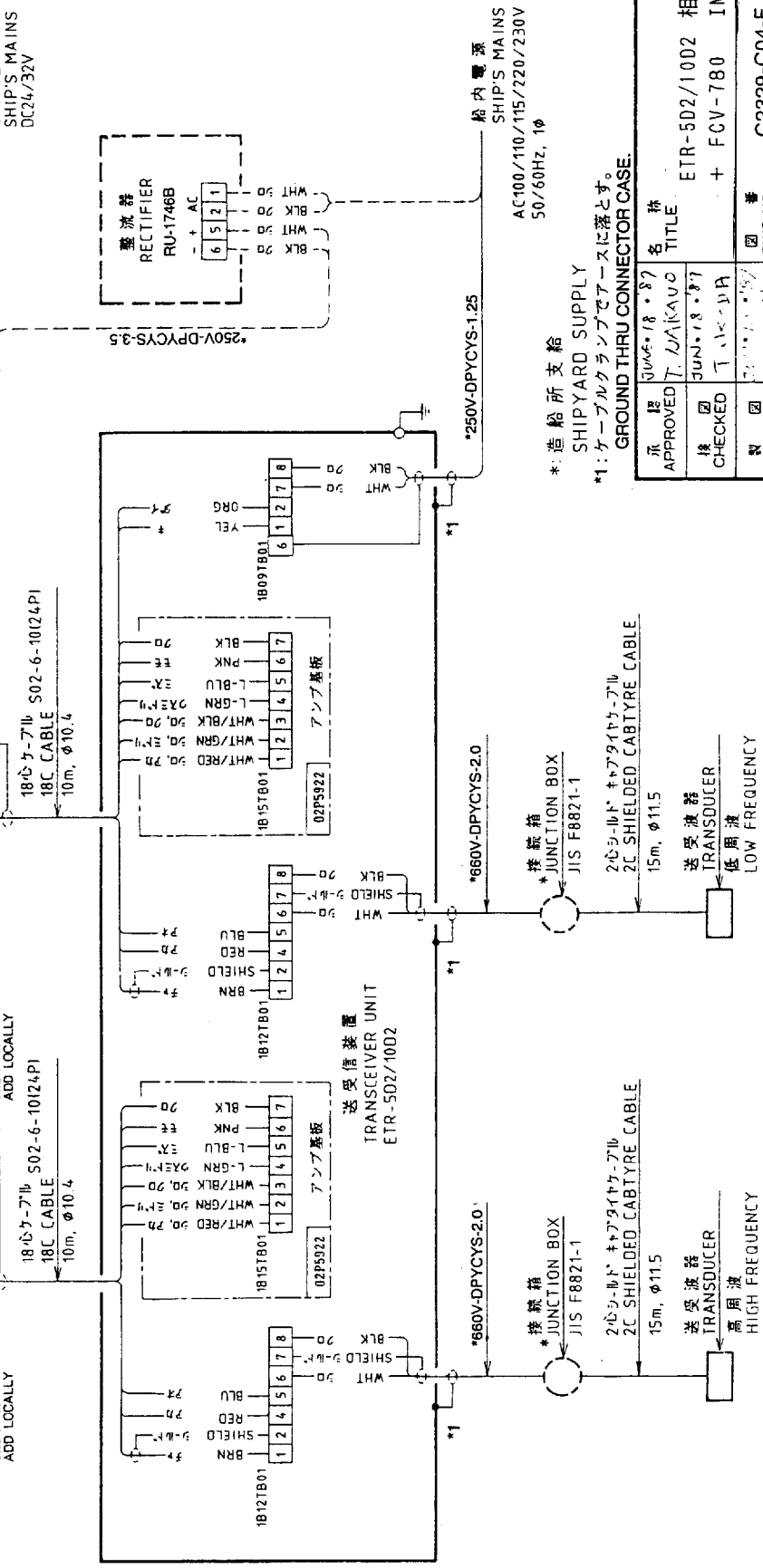
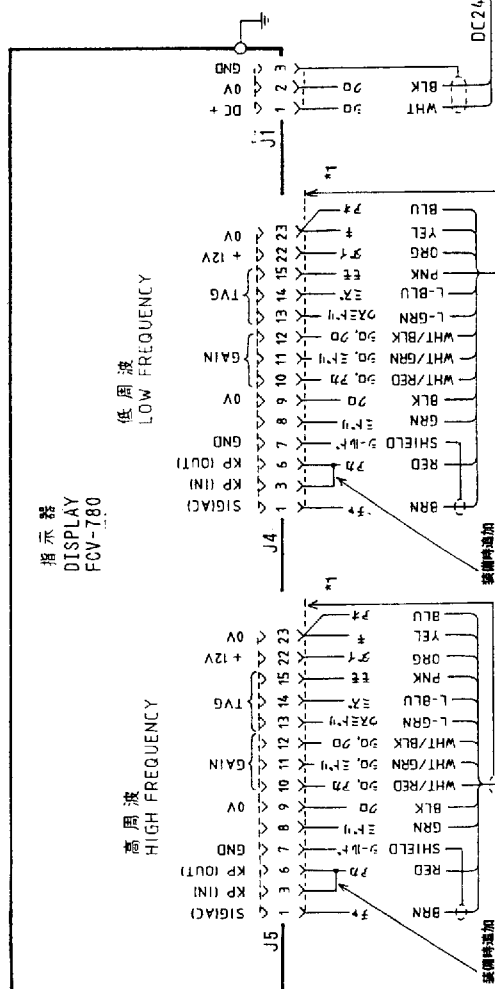
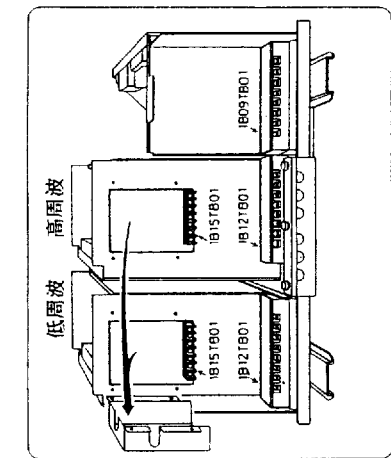

* 造船所支給
SHIPYARD SUPPLY
ケーブルクランプでアースに落とす。
GROUND THRU CONNECTOR CASE.

承認 APPROVED	検査 CHECKED	製図 DRAWN	名 氏 T. AKAUO	名 氏 T. AKASHI	名 氏 T. AKASHI
DATE JUN. 18. 87			DATE JUN. 18. 87		
TITLE ETR-502/1002 相互結線図			TITLE ETR-502/1002 相互結線図		
DWG. NO. C2329-C04-F			DWG. NO. C2329-C04-F		

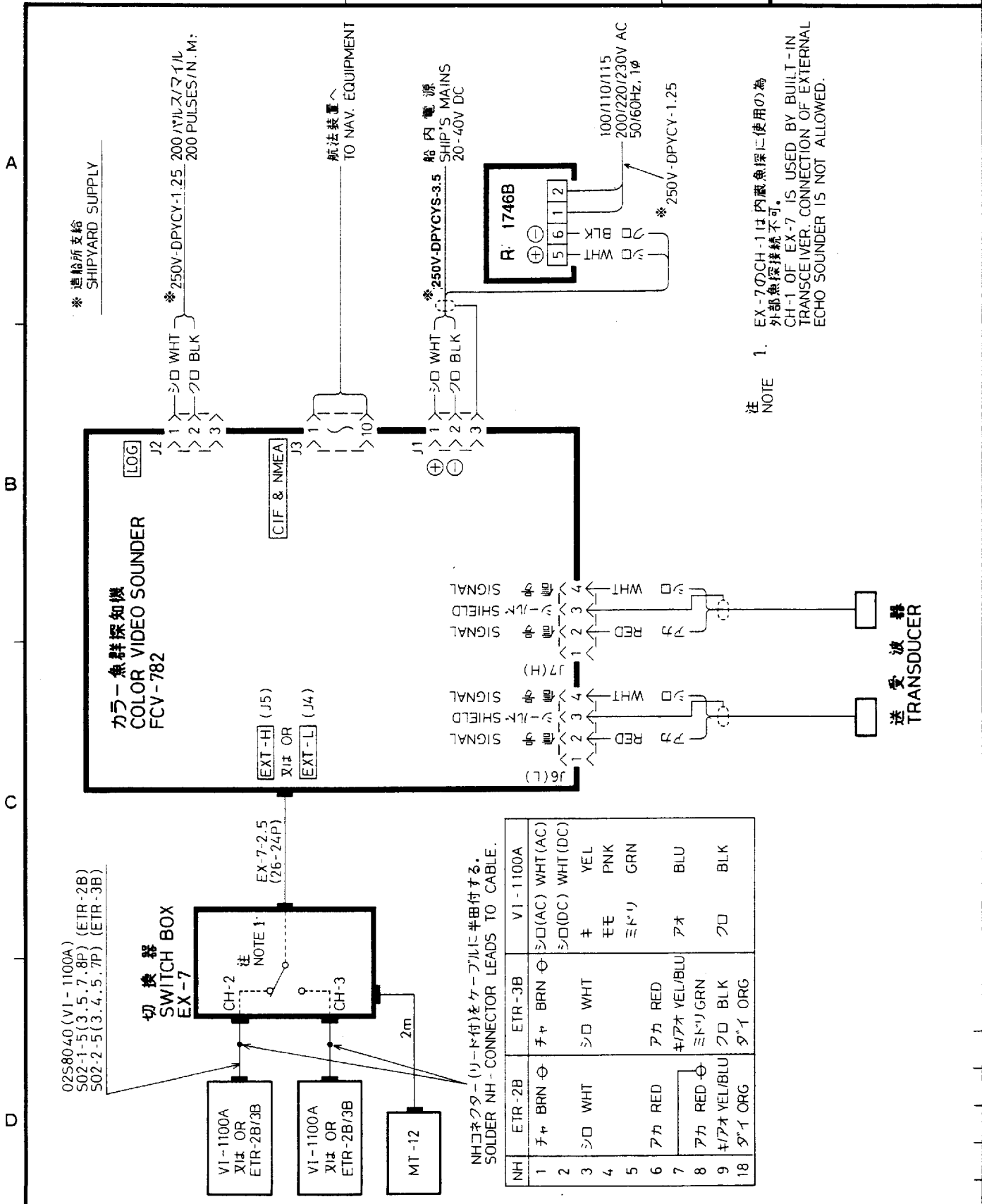

注
NOTE

1. EX-7のCH-1は内蔵魚探に使用の為
外部魚探接続不可。
CH-1 OF EX-7 IS USED BY BUILT-IN
TRANSCIEVER, CONNECTION OF EXTERNAL
ECHO SOUNDER IS NOT ALLOWED.

02S8040 (VI-1100A)
S02-1-5(3.5,7.8P) (ETR-2B)
S02-2-5(3.4,5.7P) (ETR-3B)

切換器
SWITCH BOX
EX-7

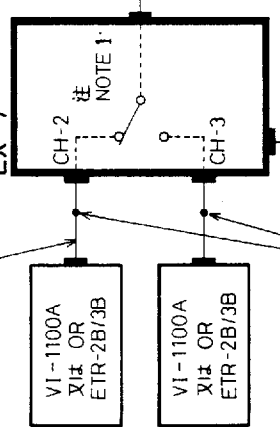

2m

NHコネクタ（リード付）をケーブルに半田付する。
SOLDER NH-CONNECTOR LEADS TO CABLE.

NH	ETR-2B	ETR-3B	VI-1100A
1	赤	赤	シロ(AC) 白(AC)
2	シロ	シロ	シロ(DC) 白(DC)
3	赤	シロ	キ
4	シロ	赤	モ
5	赤	赤	ニ
6	赤	赤	ホ
7	赤	赤	シ
8	赤	赤	シ
9	赤	赤	シ
18	赤	赤	シ

品番 ITEM	品名 NAME	材質 MATERIAL	数量 Q'TY	図番 DWG. NO.	摘要 REMARKS
承認 APPROVED	FEB.14.89 T. NAKANO	三角法 THIRD ANGLE PROJECTION	名称 TITLE	相互結線図 INTERCONNECTION DIAGRAM	
検図 CHECKED	Feb.14.89 T. KODAI	尺度 SCALE	FCV-782	INTERCONNECTION DIAGRAM	
製図 DRAWN	FEB.13.89 H. HAYASHI	重量 WEIGHT	kg	図番 DWG. NO.	C2329-C01-C

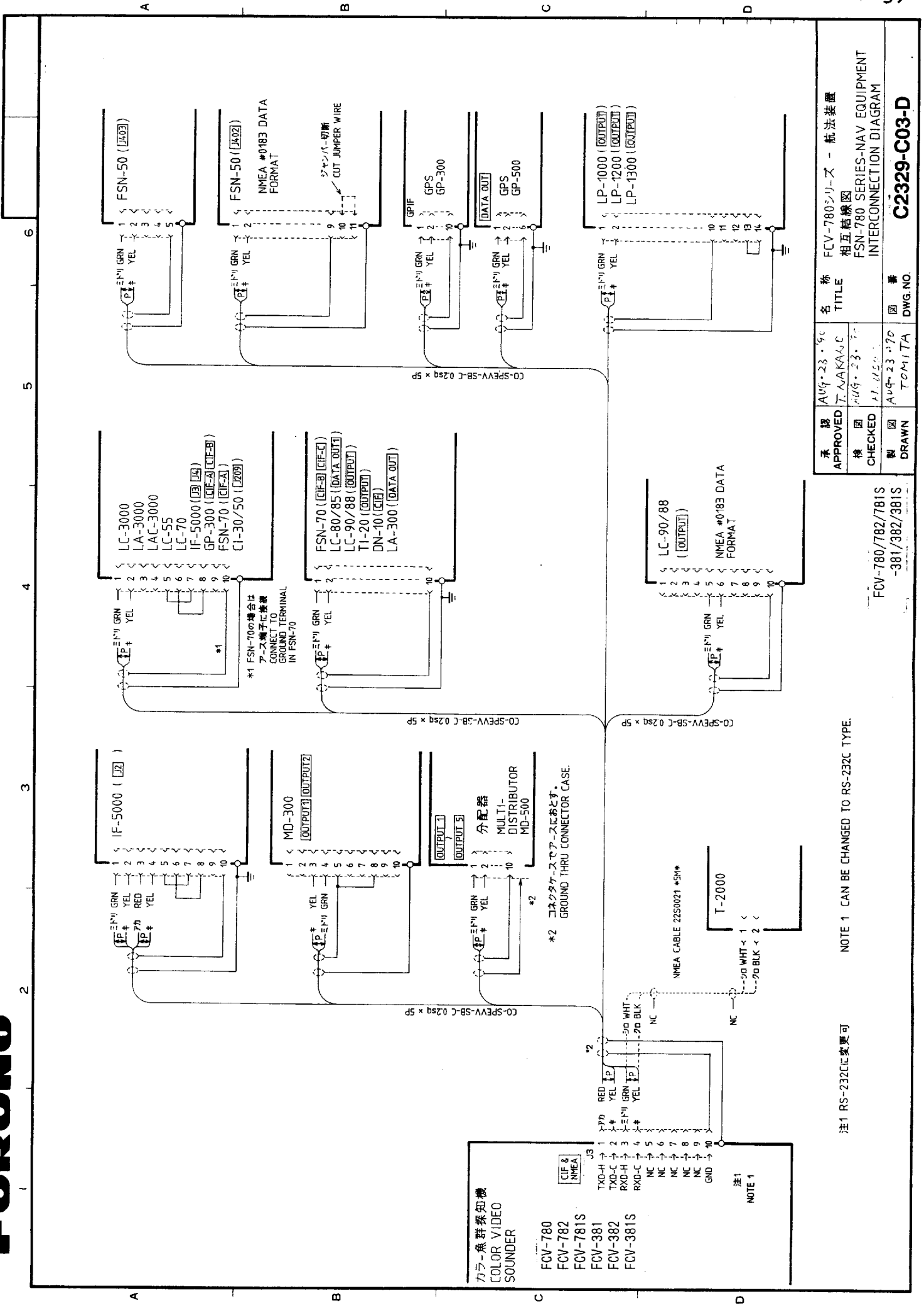

カラ-魚群探知機
COLOR VIDEO
SOUNDER

FCV-780	CIF & NMEA
FCV-782	
FCV-781S	
FCV-382	
FCV-381S	

TXD-H → 1
TXD-C → 2
RXD-H → 3
RXD-C → 4
NC → 5
NC → 6
NC → 7
NC → 8
NC → 9
GND → 10

注1
NOTE 1

承認 APPROVED	Aug. 23. 90 江ノ川 隆夫	名称 TITLE	FCV-780シリーズ - 航海装置 相互接続図 FSN-780 SERIES-NAV EQUIPMENT INTERCONNECTION DIAGRAM
検閲 CHECKED	Aug. 23. 90 TOMITA	図番 DWG. NO.	C2329-C03-D

FCV-780/782/781S
-381/382/381S

NOTE 1 CAN BE CHANGED TO RS-232C TYPE.

注1 RS-232Cに変更可

Synchronizing Transmission With Other Echo Sounder

To synchronize transmission with other echo sounders, make the wiring as follows

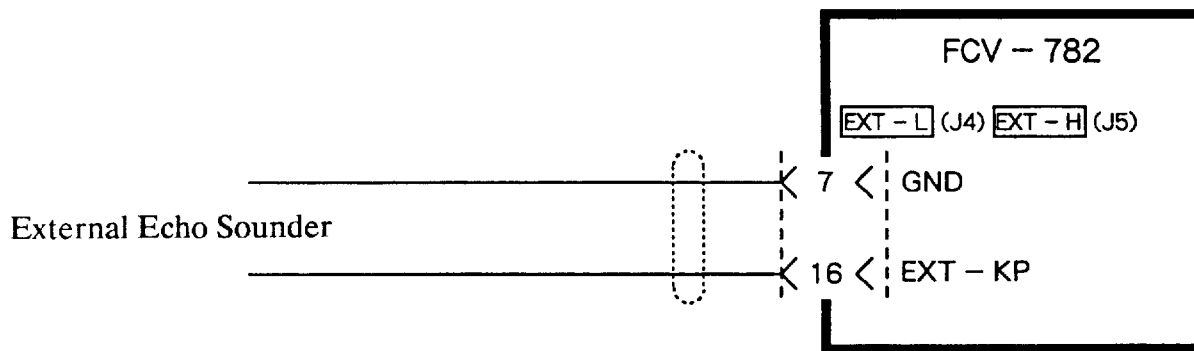

The FCV-780/782 accept a positive KP with an amplitude of 5V thru 15V.

NOTE: Since the FCV-780/782 are driven directly with the external KP, connection to a sonar with a long KP length should be avoided. The KP length should be less than 6ms and a ratio of KP length to repetition rate should be greater than 1/400.

Connecting With Net Sonde

Connection to the net sonde is made as follows

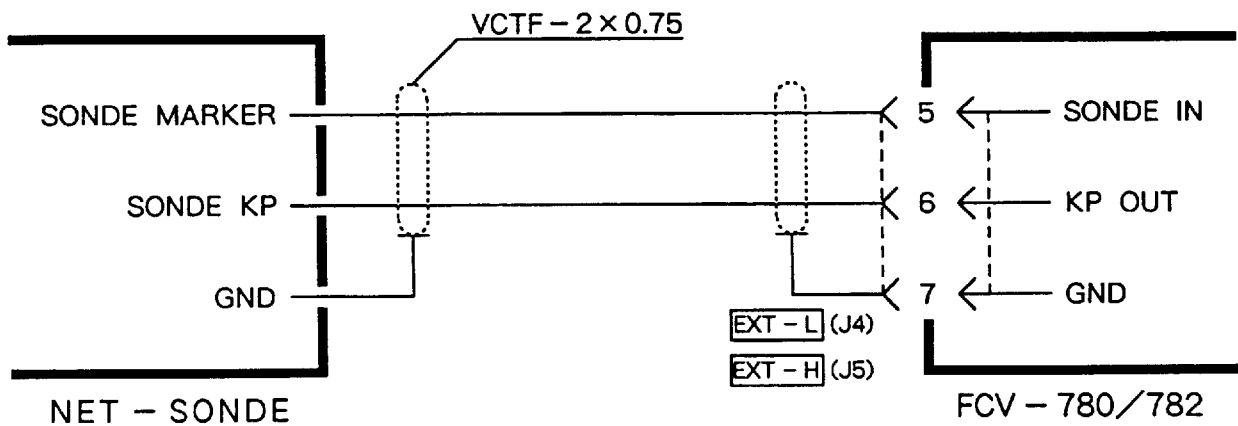

NOTE: If connected to either EXT-L or EXT-H, the net sonde signal is displayed on both high and low frequency pictures. To display only on one of the two pictures, change the system menu setting. Refer to page 28.

DIP Switch Setting On Main Board

When the FCV-782 is interfaced with switch box EX-7, it is necessary to change the settings of the MAIN board.

	High Freq.	Low Freq.	S1				Remarks
			#1	#2	#3	#4	
A	Int. Tx/Rx	Int. Tx/Rx	ON	ON	OFF	OFF	Factory setting
B	Int. Tx/Rx	Ext. ETR	ON	ON	ON	OFF	
C	Ext. ETR	Int. Tx/Rx	OFF	OFF	OFF	OFF	
D	Ext. ETR	Ext. ETR	OFF	OFF	ON	OFF	

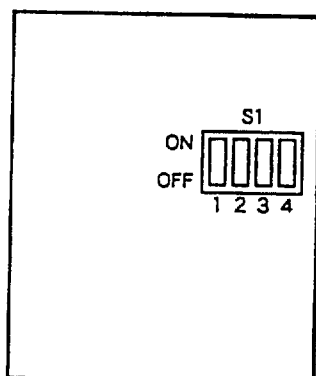

MAIN Board (02P6105)

NOTE: When the FCV-780/782 is connected to the VI-1100A, set DIP switch S5-#1 (LF) and S5-#2 (HF) to OFF on PVR board 02P6114 at the back of the main panel. For built-in transceivers and ETR transceiver unit, set them to ON.

Connecting To Other Make Position Fixing Equipment

The FCV-780/782 can be connected to other make position fixing equipment with NMEA #183 data format. Sentences which can be input/output are as follows.

Input (Data accepted by FCV-780/782)	Output (Data output to interfaced unit)
\$***GLL (Lat./long.) \$***VTG (Ship's ground speed) \$***MTW (Water temperature) \$***GTD (LOP)	\$***SDDBT (Depth)

The wiring is similar to Furuno make navigation equipment. Pins #3 and #4 of J3 are connected to TXD (H) and TXD (C) lines of other make position fixing equipment.

NOTE: To receive NMEA #183 format data, the system menu setting should be changed. See page 28.

Changing Output Power

The output power of the FCV-782 can be changed from 2kW to 3kW or vice versa if the jumper connections on the ES board (02P6073) are changed.

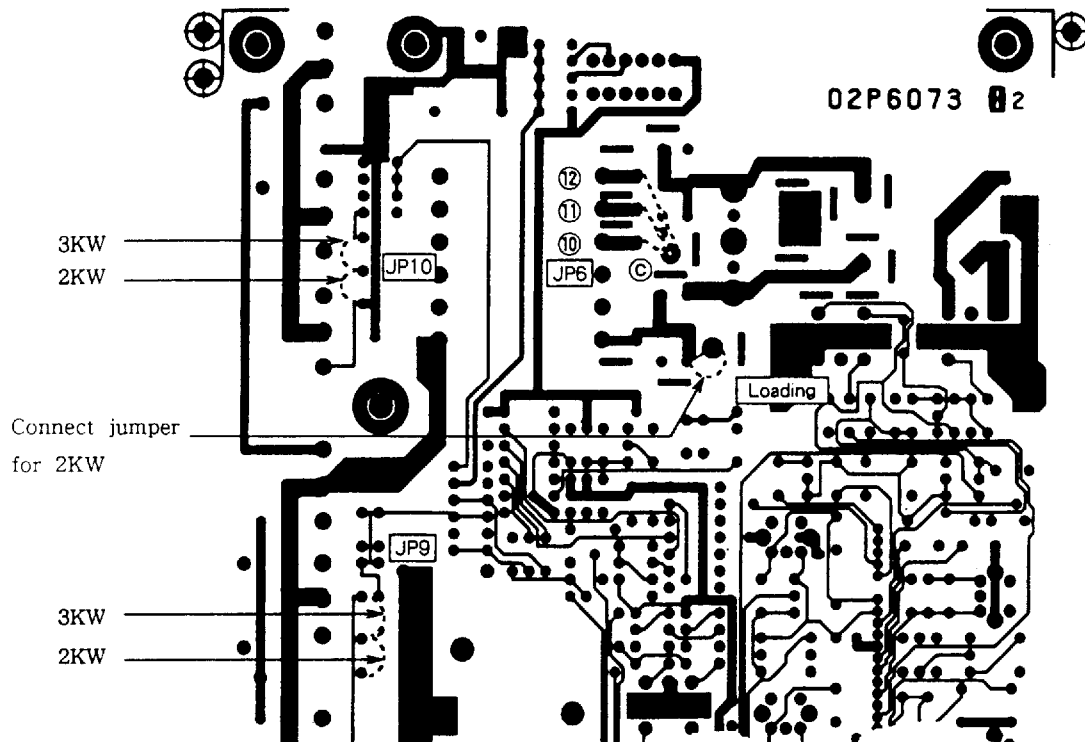

Note 1. Use gilded wires for jumper connection. The maximum height of the jumper wire should be less than 3mm from the board surface.

2. Jumper position of JP6 should be as follows with respect to transducer type.

3kW XDR	28F-24H	50B-24H	68F-30H	88B-126H	200B-12H	
JP6	11	10	11	10	11	
2kW XDR	28F-18	50B-12	68F-30H	88B-10	200B-8/8B	200B-8N
JP6	11	11	10	11	12	10

3. Change the transducer type sticker provided on top of the transducer jack on the rear panel of the display unit. Cut out the correct type from the following transducer lists and affix it by using film sheet supplied as installation material.

28F-18 28F-24H 50B-12 50B-24H 68F-30H 88B-10 88B-126H
200B-8/8B 200B-8N 200B-12H

4. The output power is set to 2kW at the factory until December 1990 production and to 3kW from January 1991 production.

13. SPECIFICATIONS

1. Display 14" diagonal medium resolution CRT
2. Echo Color 16 colors depending on echo intensity. 8 color presentation is also available. The background color is selectable from blue, dark blue and black.
3. Presentation Mode "NORM": Normal (Single or dual frequency)
Normal + Zoom
Normal + Mix
"BL/BD": Normal + BL/BD
BL/BD; Bottom locked and bottom discrimination picture.
4. A-Scope Presentation Provided on the right 1/3 of the screen
5. Basic Display Range

	1	2	3	4	5	6
M	10	20	40	80	150	300
FT	30	60	120	250	500	1000
FA	5	10	20	40	80	160
P/B	6	12	25	50	100	200

- 1) Display start depth can be shifted in 1m (FT, FA, P/B) steps up to 2000m.
- 2) Operator can reprogram the basic range; the shallowest range available is 5m and the deepest one 2000m.

6. Zoom Range/Bottom Lock Expansion Range

	1	2	3	4	5	6
M	2.5	5	10	20	40	80
FT	10	20	40	80	160	300
FA	1.2	2.5	5	10	20	40
P/B	2.5	5	10	20	40	80

7. Automatic Bottom Tracking

Display start depth is automatically shifted to display the bottom on the lower half of the screen.

8. Picture Advance Speed

	0	1	2	3	4
Lines/TX	Freeze	1/8	1/4	1/2	1/1

Ship's speed dependent advance is available.

9. Picture Recording

One page of picture can be stored and recalled at any time.

10. Noise Limiter

Rejects unwanted signals by comparing last and present echoes in strength.

11. Alarm

Bottom or fish alarm. In addition, water temperature alarm is available when temperature data is fed in CIF or NMEA #183 data format.

12. Pulselength/Repetition Rate

Pulselength: Automatically changes from 0.2 to 8.0ms according to display end depth and pulse repetition rate. Manual change is also possible in 3 steps.

Repetition Rate: Automatically changed according to display-end depth. Manual change is also possible in 11 steps.

13. Built-in Transceiver (for FCV-782)

Frequency: Two frequencies from 28, 50, 68, 88 and 200kHz
Output Power: 2kWrms or 3kWrms

14. Input Output Data (CIF or NMEA Format)

Input: Ship's position (L/L or LOP), ship's speed, water temperature
Output: Depth

15. Environmental Condition

Temperature: 0°C to +50°C
Humidity: 95% or less

16. Power Supply

20 to 40VDC, 150W. For AC ship's mains, optional rectifier RU-3423 is required.

COMPLETE SET

No.	Name	Type	Qty	Code No.	Remarks
1	Recorder Unit	CV-782	1		For FCV-782
		CV-780			For FCV-780
2	Accessories	FP02-02600	1 set	000-014-562	
3	Installation Materials	CP-02-04700	1 set	000-014-704	For FCV-780
		CP02-04800		000-014-720	For FCV-782
4	Spare Parts	SP02-02800	1 set	000-024-735	

ACCESSORIES

No.	Name	Type	Qty	Code No.
1	Filter Assembly	FP02-02620	1	002-007-290
2	Hood	10-044-0032-1	1	100-109-251
3	Vinyl Cover	10-044-0031-1	1	000-801-859

INSTALLATION MATERIALS

No.	Name	Type	Qty	Code No.	Remarks
1	Connector	NCS-254P	2	000-506-505	For FCV-782
2	Connector	NJC-203-PF	1	000-506-703	
3	Connector	SRCN6A16-10P	1	000-508-663	
4	Connector	SRCN6A25-24P	2	000-508-676	
5	Copper Strap	WEA-1004-0	1	500-310-040	
6	Connector	FM-143P	1	000-511-405	

SPARE PARTS

No.	Name	Type	Qty	Code No.
1	Fuse	FGB 7A AC125V	3	000-549-013

2kW TRANSDUCER AND TANK (OPTION)

Frequency (kHz)	Transducer (Code No.)	Hull Bottom Installation		
		Ship's Hull	Tank (Code No.)	Thru-hull Pipe (Code No.)
28/50	28F-18 (000-015-004) 50B-12 (000-015-053)	Steel	T-634 (000-015-810)	TFB-7000(2) (000-015-209)
		FRP	T-634-F (000-015-811)	TRB-1100(2) (000-015-218)
28/88	28F-18 (000-015-004) 88B-10 (000-015-025)	Steel	T-636 (000-015-813)	TFB-7000(2) (000-015-209)
		FRP	T-636-F (000-015-814)	TRB-1100(2) (000-015-218)
28/200	28F-18 (000-015-004) 200B-8B (000-015-032)	Steel	T-638 (000-015-818)	TFB-7000(2) (000-015-209)
		FRP	T-638-F (000-015-819)	TRB-1100(2) (000-015-218)
50/88	50B-12 (000-015-053) 88B-10 (000-015-025)	Steel	T-643 (000-015-821)	TFB-7000(2) (000-015-209)
		FRP	T-643-F (000-015-822)	TRB-1100(2) (000-015-218)
50/200	68F-30H (000-015-073) 200B-8B (000-015-032)	Steel	T-645 (000-015-826)	TFB-7000(2) (000-015-209)
		FRP	T-645-F (000-015-827)	TRB-1100(2) (000-015-218)
68/200	68F-30H (000-015-073) 200B-8B (000-015-032)	Steel	T-647 (000-015-831)	TFB-7000(2) (000-015-209)
		FRP	T-647-F (000-015-832)	TRB-1100(2) (000-015-218)
88/200	88B-10 (000-015-025) 200B-8B (000-015-032)	Steel	T-649 (000-015-833)	TFB-7000(2) (000-015-209)
		FRP	T-649-F (000-015-834)	TRB-1100(2) (000-015-218)

3kW TRANSDUCER AND TANK (OPTION)

Frequency (kHz)	Transducer (Code No.)	Hull Bottom Installation		
		Ship's Hull	Tank (Code No.)	Thru-hull Pipe
28/50	28F-24H (000-015-075) 50F-24H (000-015-077)	Steel	T-681 (000-015-849)	TFB-7000(2) (000-015-209)
		FRP	T-681-F (000-015-850)	TRB-1100(2) (000-015-218)
28/68	28F-24H (000-015-075) 68F-30H (000-015-073)	Steel	T-616 (000-015-843) T-614 (000-015-839)	TFB-5000 (000-015-701) (2 pcs. neces- sary)
		FRP	T-616-F (000-015-844) T-614-F (000-015-840)	TRB-1000 (000-015-215) (2 pcs. neces- sary)
28/88	28F-24H (000-015-075) 88F-126H (000-015-068)	Steel	T-682 (000-015-851)	TFB-7000(2) (000-015-209)
		FRP	T-682-F (000-015-852)	TRB-1100(2) (000-015-218)
28/200	28F-24H (000-015-075) 200B-12H (000-015-069)	Steel	T-683 (000-015-853)	TFB-7000(2) (000-015-209)
		FRP	T-683-F (000-015-854)	TRB-1100(2) (000-015-218)
50/88	50F-24H (000-015-077) 88F-126H (000-015-073)	Steel	T-682 (000-015-851)	TFB-7000(2) (000-015-209)
		FRP	T-682-F (000-015-852)	TRB-1100(2) (000-015-218)
50/200	50F-24H (000-015-077) 200B-12H (000-012-069)	Steel	T-683 (000-015-853)	TFB-7000(2) (000-015-209)
		FRP	T-683-F (000-015-854)	TRB-1100(2) (000-015-218)
68/200	68F-30H (000-015-073) 200B-12H (000-015-069)	Steel	T-646 (000-015-829)	TFB-7000(2) (000-015-209)
		FRP	T-646-F (000-015-830)	TRB-1100(2) (000-015-218)
88/200	88F-126H (000-015-068) 200B-12H (000-015-069)	Steel	T-685 (000-015-855)	TFB-7000(2) (000-015-209)
		FRP	T-685-F (000-015-856)	TRB-1100(2) (000-015-218)

APPENDIX 1. SCREEN DIVISION

The display screen is divided as follows depending on the settings of the **MODE** switch, **BL/BD** key and the system menu (Hor. or Vert.).

1. Horizontal Division

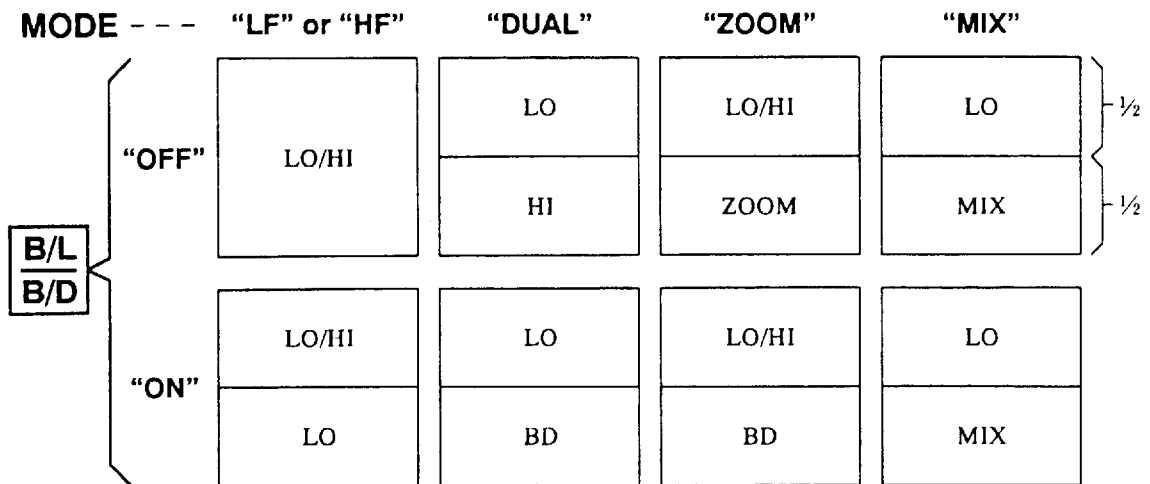

----- When A-scope is "ON" -----

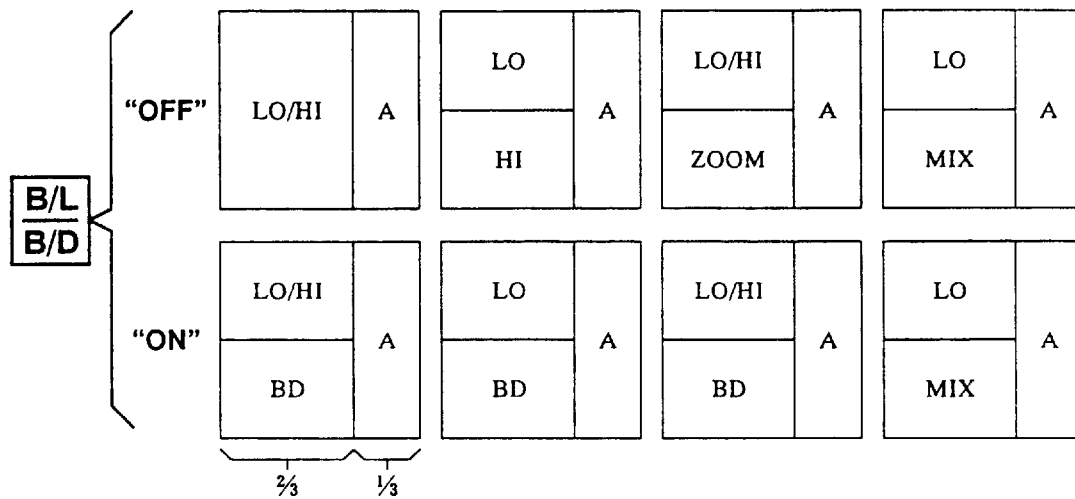

LO: Low Frequency
 HI: High Frequency
 BD: Bottom Lock/
 Bottom Discrimination.

2. Vertical Division

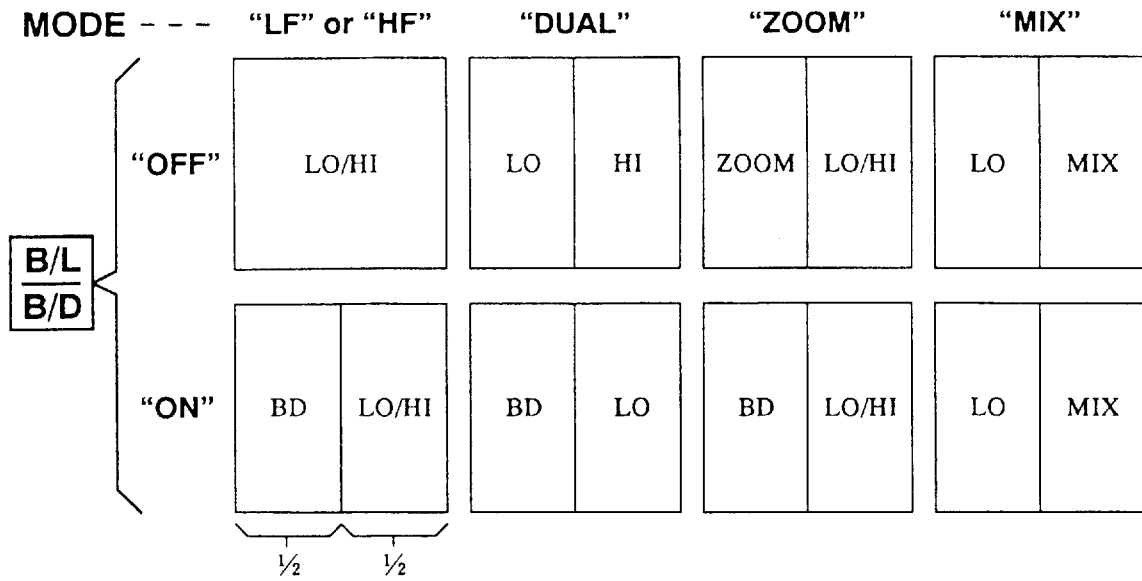

----- When A - scope is “ON” -----

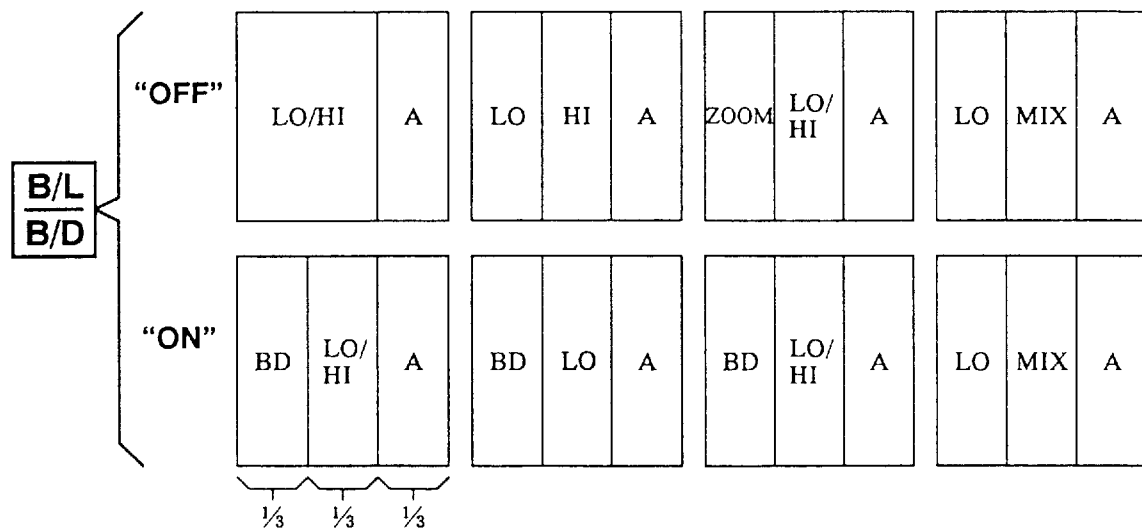

LO: Low Frequency
 HI: High Frequency
 BD: Bottom Lock/
 Bottom Discrimination.

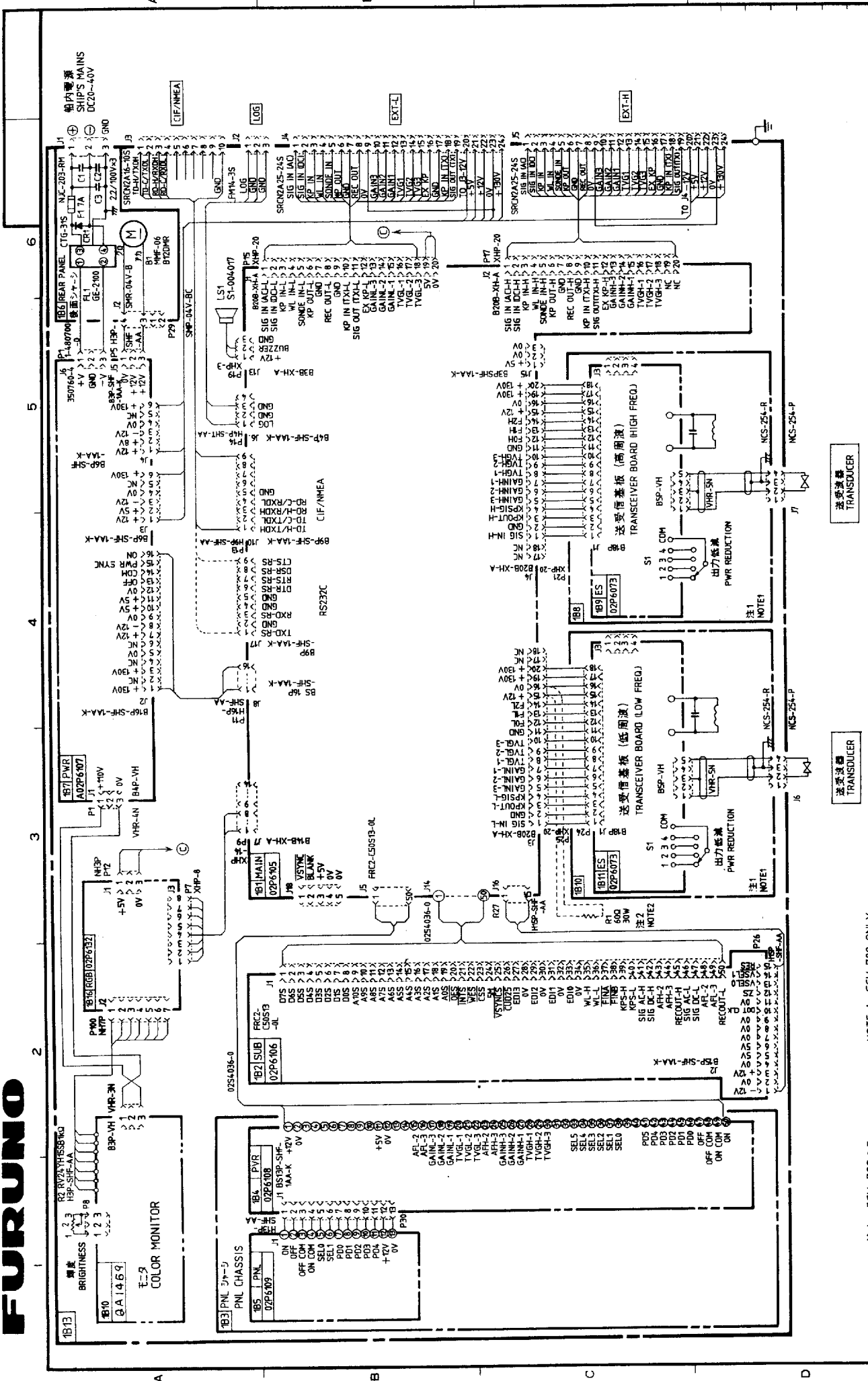

NOTE 1. FCV-782 ONLY
 2. FCV-780 ONLY

注1. FCV-782のみ。
 2. FCV-780のみ。

承認 APPROVED	名 称 TITLE
検 査 CHECKED	指示器 FCV-780/782
製 図 DRAWN	表示器 DISPLAY UNIT
製 図 DRAWN	図 番 DWG. NO.
OCT 5 '72 TAKADA	C2329-K01-D

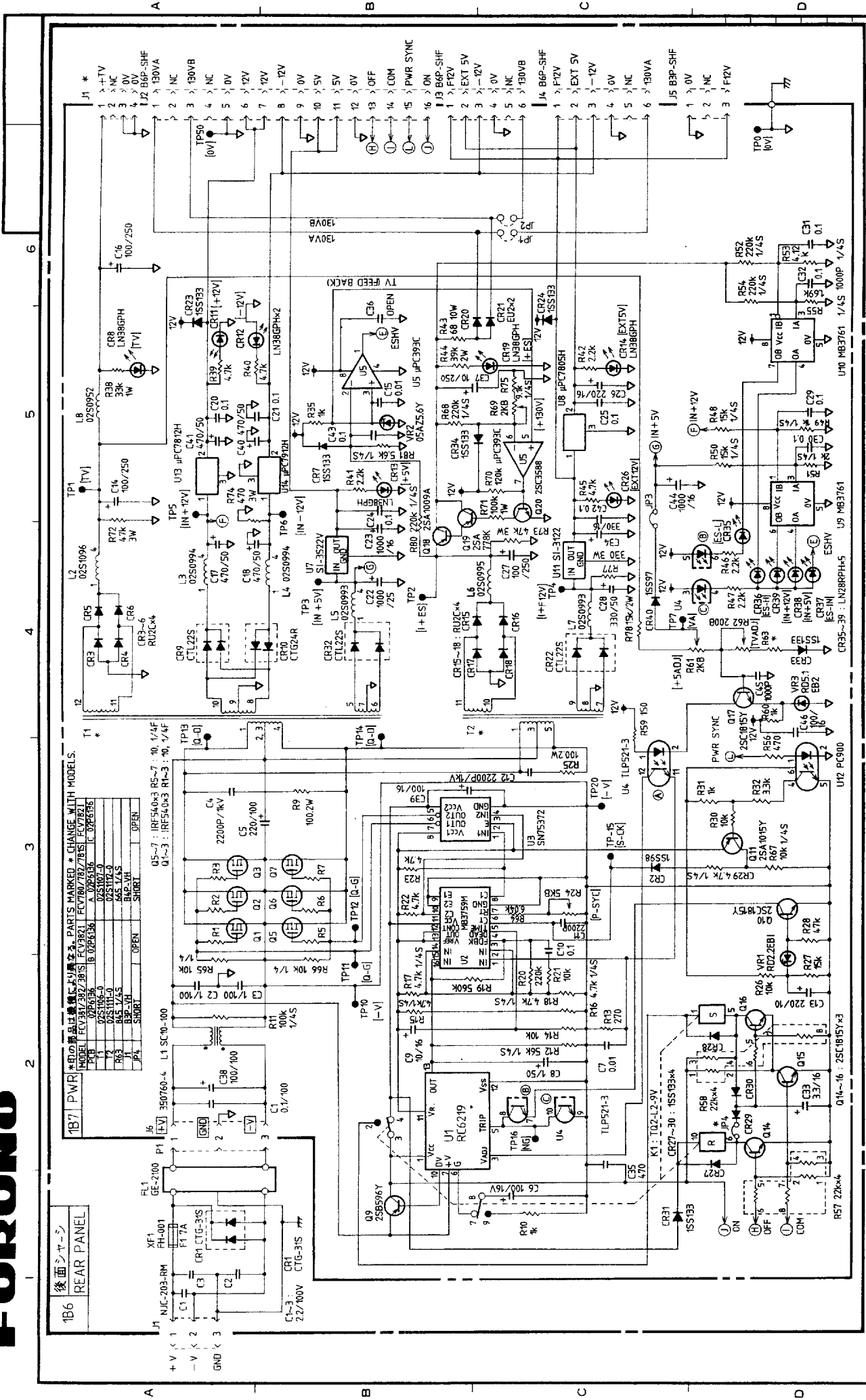

1B6 REAR PANEL

部品名	仕様	数量	備考
1	02S100952	1	
2	02S10094	1	
3	02S10093	1	
4	02S10092	1	
5	02S10091	1	
6	02S10090	1	
7	02S10089	1	
8	02S10088	1	
9	02S10087	1	
10	02S10086	1	
11	02S10085	1	
12	02S10084	1	
13	02S10083	1	
14	02S10082	1	
15	02S10081	1	
16	02S10080	1	
17	02S10079	1	
18	02S10078	1	
19	02S10077	1	
20	02S10076	1	
21	02S10075	1	
22	02S10074	1	
23	02S10073	1	
24	02S10072	1	
25	02S10071	1	
26	02S10070	1	
27	02S10069	1	
28	02S10068	1	
29	02S10067	1	
30	02S10066	1	
31	02S10065	1	
32	02S10064	1	
33	02S10063	1	
34	02S10062	1	
35	02S10061	1	
36	02S10060	1	
37	02S10059	1	
38	02S10058	1	
39	02S10057	1	
40	02S10056	1	
41	02S10055	1	
42	02S10054	1	
43	02S10053	1	
44	02S10052	1	
45	02S10051	1	
46	02S10050	1	
47	02S10049	1	
48	02S10048	1	
49	02S10047	1	
50	02S10046	1	
51	02S10045	1	
52	02S10044	1	
53	02S10043	1	
54	02S10042	1	
55	02S10041	1	
56	02S10040	1	
57	02S10039	1	
58	02S10038	1	
59	02S10037	1	
60	02S10036	1	
61	02S10035	1	
62	02S10034	1	
63	02S10033	1	
64	02S10032	1	
65	02S10031	1	
66	02S10030	1	
67	02S10029	1	
68	02S10028	1	
69	02S10027	1	
70	02S10026	1	
71	02S10025	1	
72	02S10024	1	
73	02S10023	1	
74	02S10022	1	
75	02S10021	1	
76	02S10020	1	
77	02S10019	1	
78	02S10018	1	
79	02S10017	1	
80	02S10016	1	
81	02S10015	1	
82	02S10014	1	
83	02S10013	1	
84	02S10012	1	
85	02S10011	1	
86	02S10010	1	
87	02S10009	1	
88	02S10008	1	
89	02S10007	1	
90	02S10006	1	
91	02S10005	1	
92	02S10004	1	
93	02S10003	1	
94	02S10002	1	
95	02S10001	1	

注 1. 指示なき抵抗は1/6Wタイプ
 2. 放熱板付部品 : Q1~3, 5~7, 18, CR22, 32, U7, 8, 11, 13

NOTE 1. ALL RESISTORS ARE 1/6W TYPE UNLESS OTHERWISE NOTED.
 2. PARTS WITH HEAT SINKS : Q1~3, 5~7, 18, CR22, 32, U7, 8, 11, 13

承認	APR. 17. 91	名称	02P6136
検図 <td>Y. K. A. A. C.</td> <td>TITLE <td>A 02P6136 電源部回路図</td> </td>	Y. K. A. A. C.	TITLE <td>A 02P6136 電源部回路図</td>	A 02P6136 電源部回路図
チェック <td>Y. K. A. A. C.</td> <td> <td>B 02P6136 POWER SUPPLY CIRCUIT</td> </td>	Y. K. A. A. C.	<td>B 02P6136 POWER SUPPLY CIRCUIT</td>	B 02P6136 POWER SUPPLY CIRCUIT
製図 <td>APR. 17. 91</td> <td> <td>C 02P6136</td> </td>	APR. 17. 91	<td>C 02P6136</td>	C 02P6136
DRAWN	Tomita	図番	C2330-K05-D
		DWG. NO.	

Free Manuals Download Website

<http://myh66.com>

<http://usermanuals.us>

<http://www.somanuals.com>

<http://www.4manuals.cc>

<http://www.manual-lib.com>

<http://www.404manual.com>

<http://www.luxmanual.com>

<http://aubethermostatmanual.com>

Golf course search by state

<http://golfingnear.com>

Email search by domain

<http://emailbydomain.com>

Auto manuals search

<http://auto.somanuals.com>

TV manuals search

<http://tv.somanuals.com>