

FURUNO

OPERATOR'S MANUAL

VHF DSC Terminal

MODEL DSC-8V/8VP

This manual contains only operating information.
For other information, please refer to the following
manuals:

- Installation Installation Manual
- Servicing Service Manual (extra cost)



FURUNO ELECTRIC CO., LTD.
NISHINOMIYA, JAPAN

8. All Ships Call

8.1 Transmitting "All Ships Call"

General

When an urgent but not life endangering situation arises on your vessel, for example, engine trouble occurs, transmit an all ships call to request assistance.

After transmitting message, you can communicate by voice over the FM-8000.

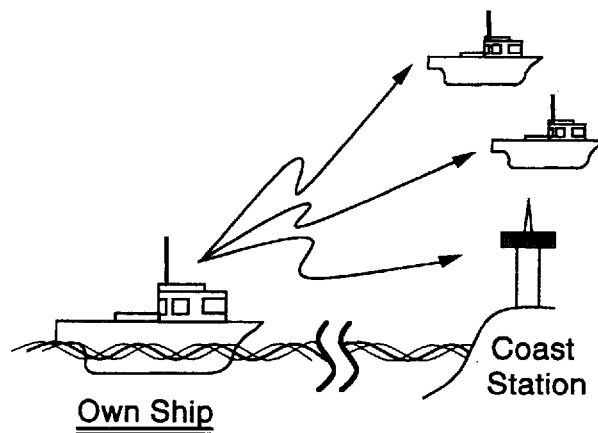

Procedure

Basic procedure

1. Selection of Format specifier (Calling type)
2. Selection of Category (Communication priority)
3. Selection of Telecommand 1 (Communication mode)
4. Entry of Working channel (Communication channel)
5. Press of **CALL** key

For detailed transmission procedure, see the next page.

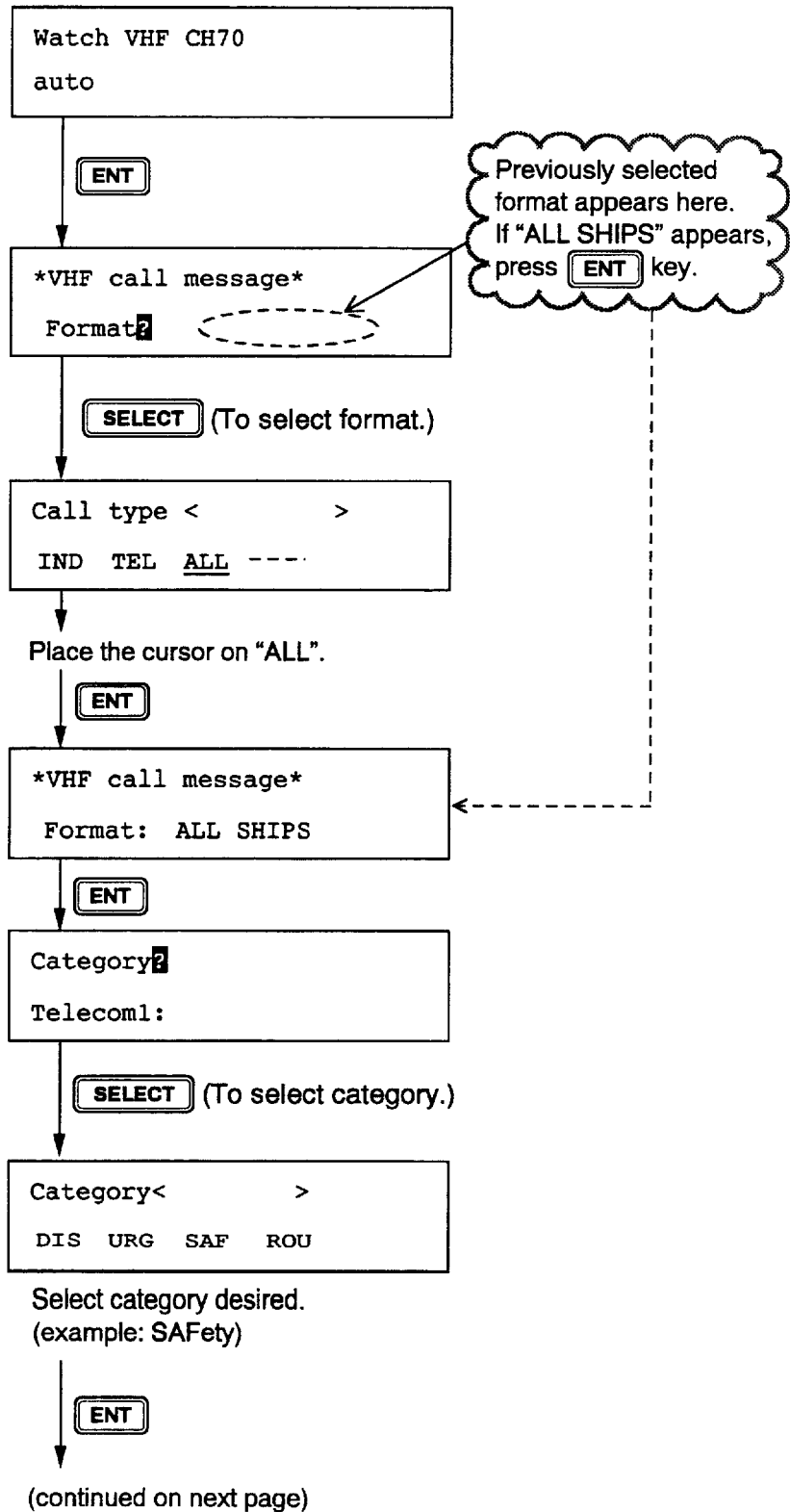
Detailed procedure

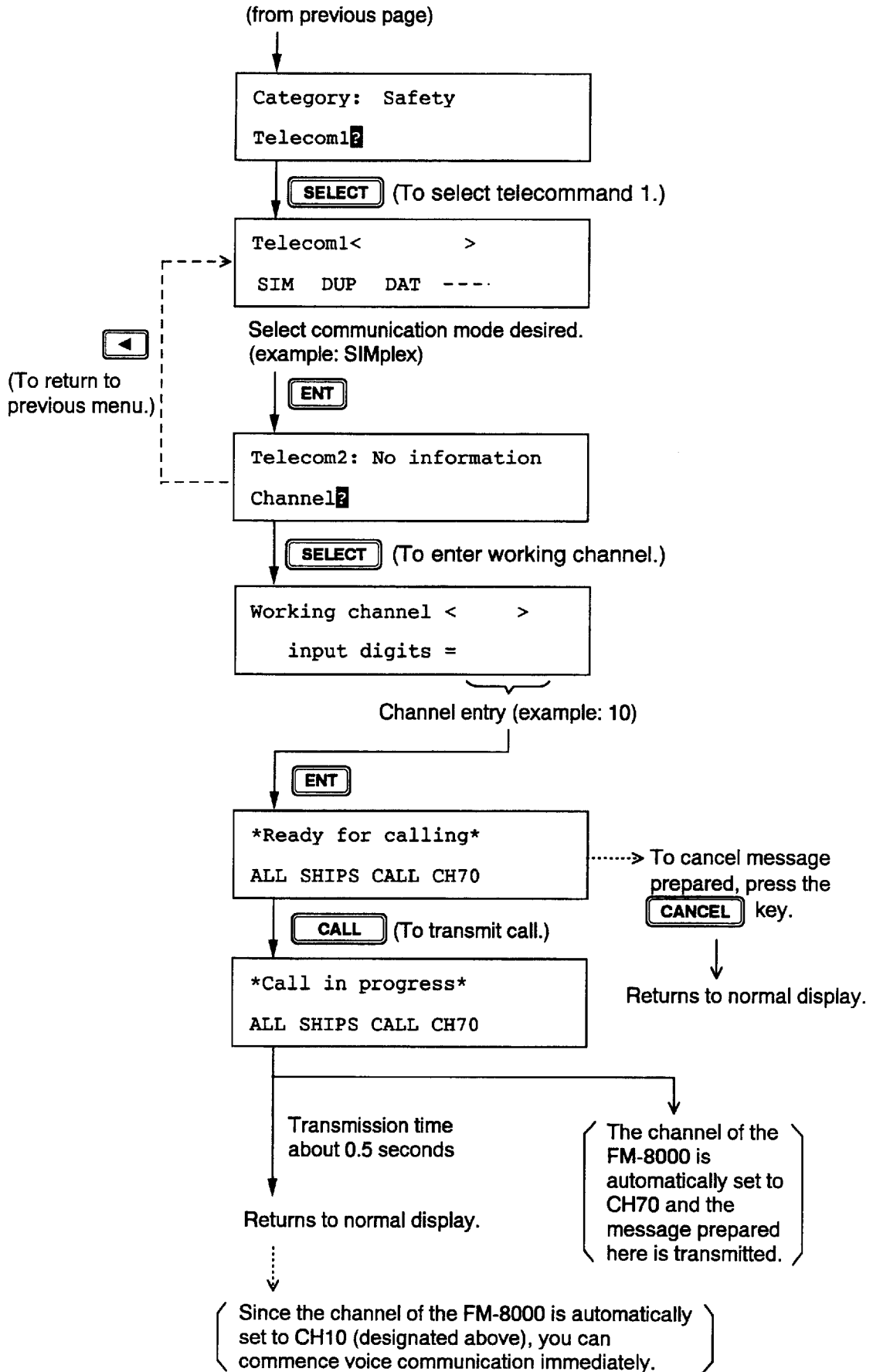

8.2 Receiving "All Ships Call"

General

Remote function of the DSC-8V is normally set to either "auto" or "limit" by pressing the **[2]** key, depending on situation. (See page 4.) When receiving an all ships call, therefore, the channel of the FM-8000 is automatically set to the channel designated by a transmitting station, enabling you to watch initial voice from the transmitting station at once.

Procedure

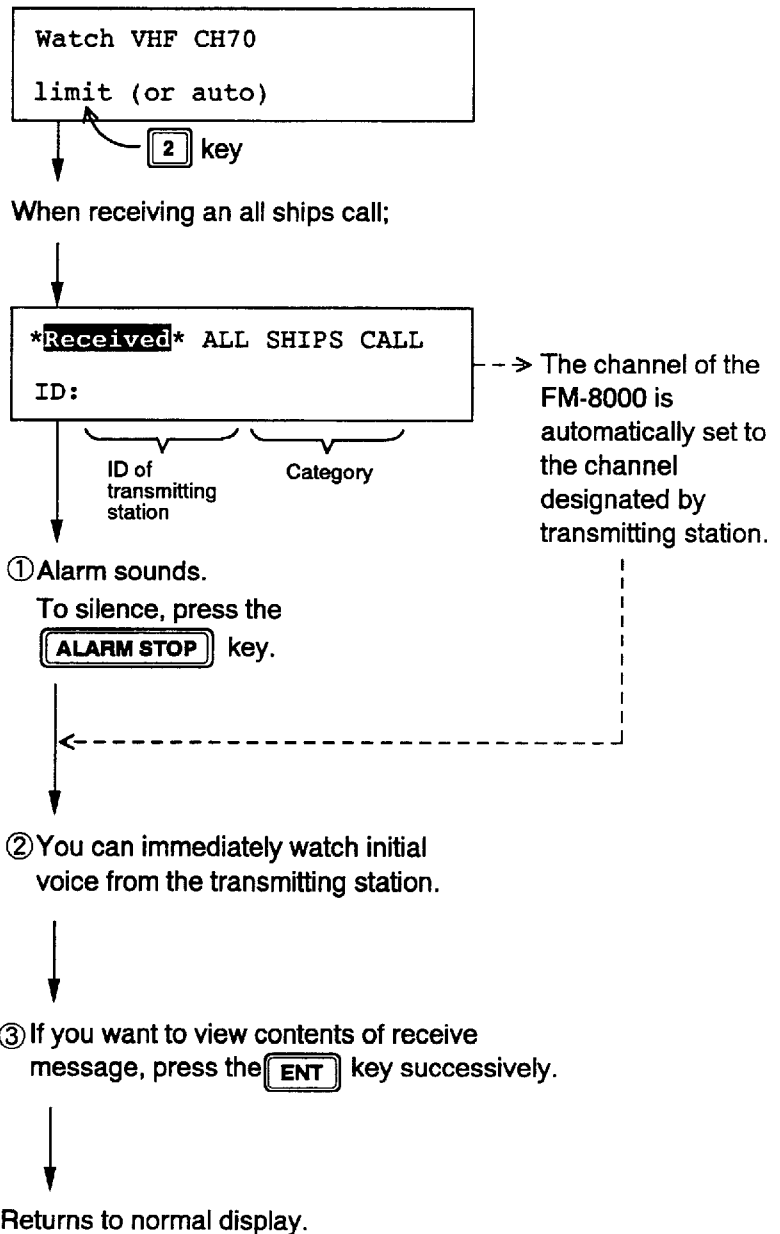

9. Individual Call

9.1 Transmitting "Individual Call" (ACK RQ)

General

The individual call is for sending message to a specific station. After transmitting message (called ACK RQ transmission), wait to receive the acknowledge back (ACK BQ) signal from receiving station. You should receive it within five minutes.

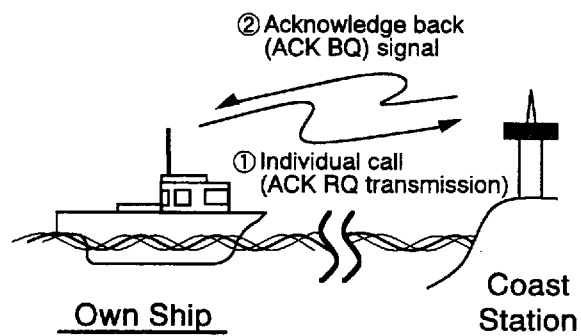

Procedure

Basic procedure

1. Selection of Format specifier (Calling type)
2. Entry of Other ship's ID number
3. Selection of Category (Communication priority)
4. Selection of Telecommand (Communication mode)
5. Entry of Working channel
6. Press of **CALL** key

Detailed procedure

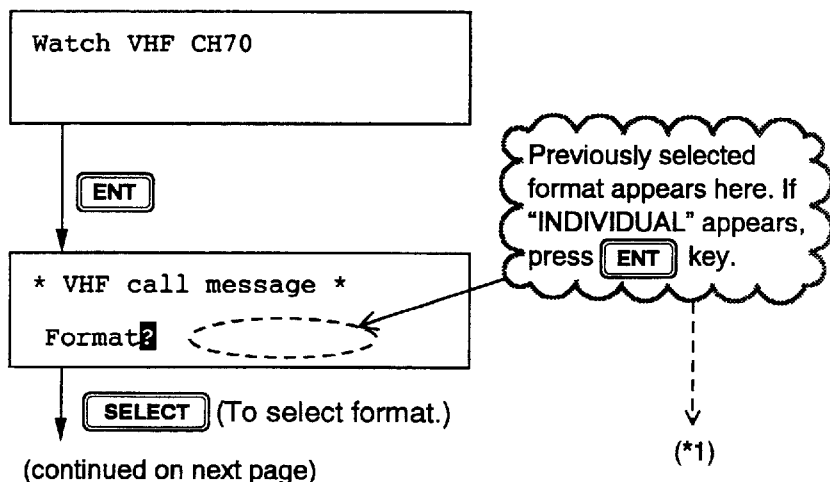

(from previous page)

Call type < >
IND TEL ALL ---

Place the cursor on "IND".

ENT

* VHF call message *
 Format: INDIVIDUAL

(*1)

ENT

Address?
 Category:

SELECT (To enter other station ID.)

Address < >
 input 9 digits =

Entry of other station ID
 (Ship station: 9 digits
 Coast station: 00 + 7 digits)

 (To return to previous menu.)

ENT

Address :
 Category?

SELECT (To select category.)

Category < >
 DIS URG SAF ROU

← "ROU" (Routine) is normally selected.

Select "ROU".

Telecom1?
 Telecom2:

SELECT (To select telecommand 1.)

(continued on next page)

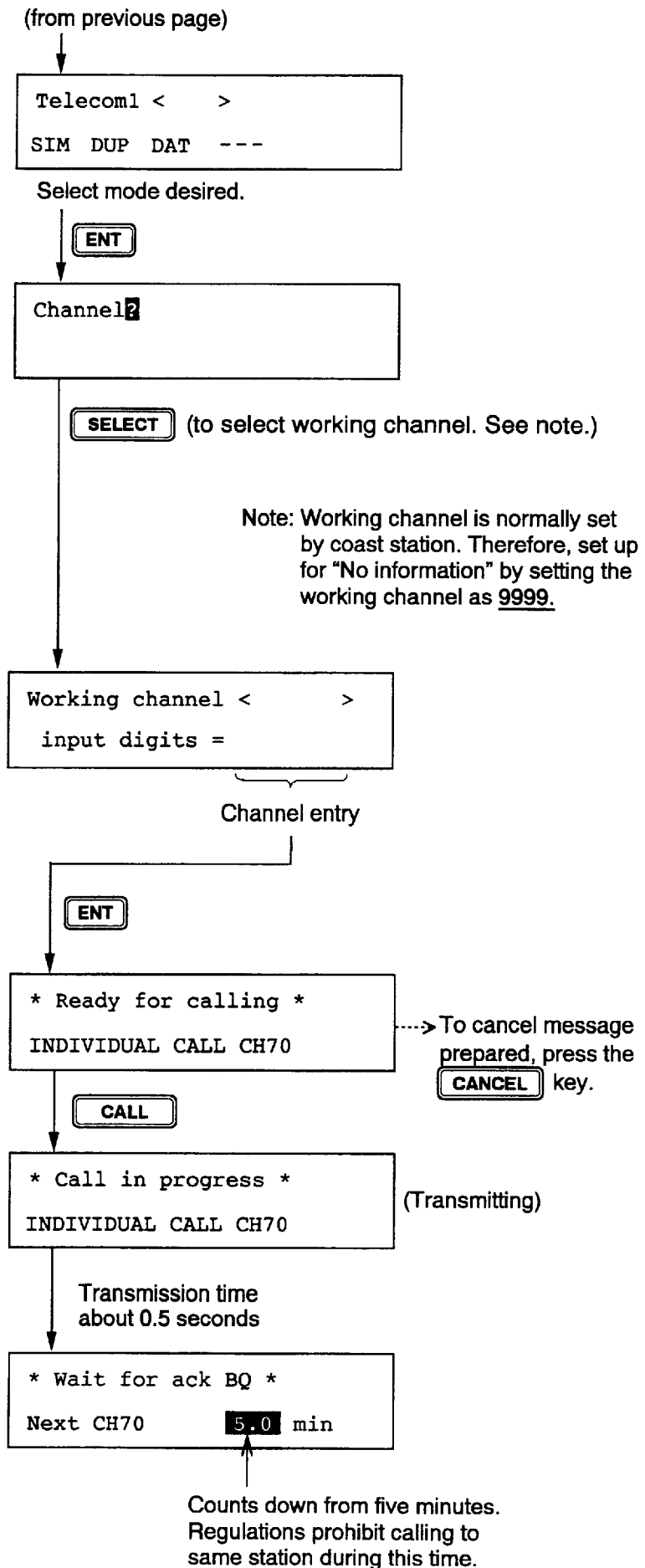

9.2 Receiving Acknowledge Back (ACK BQ) Signal

General

After transmitting an individual call, receive the ACK BQ signal from the receiving station.

Procedure

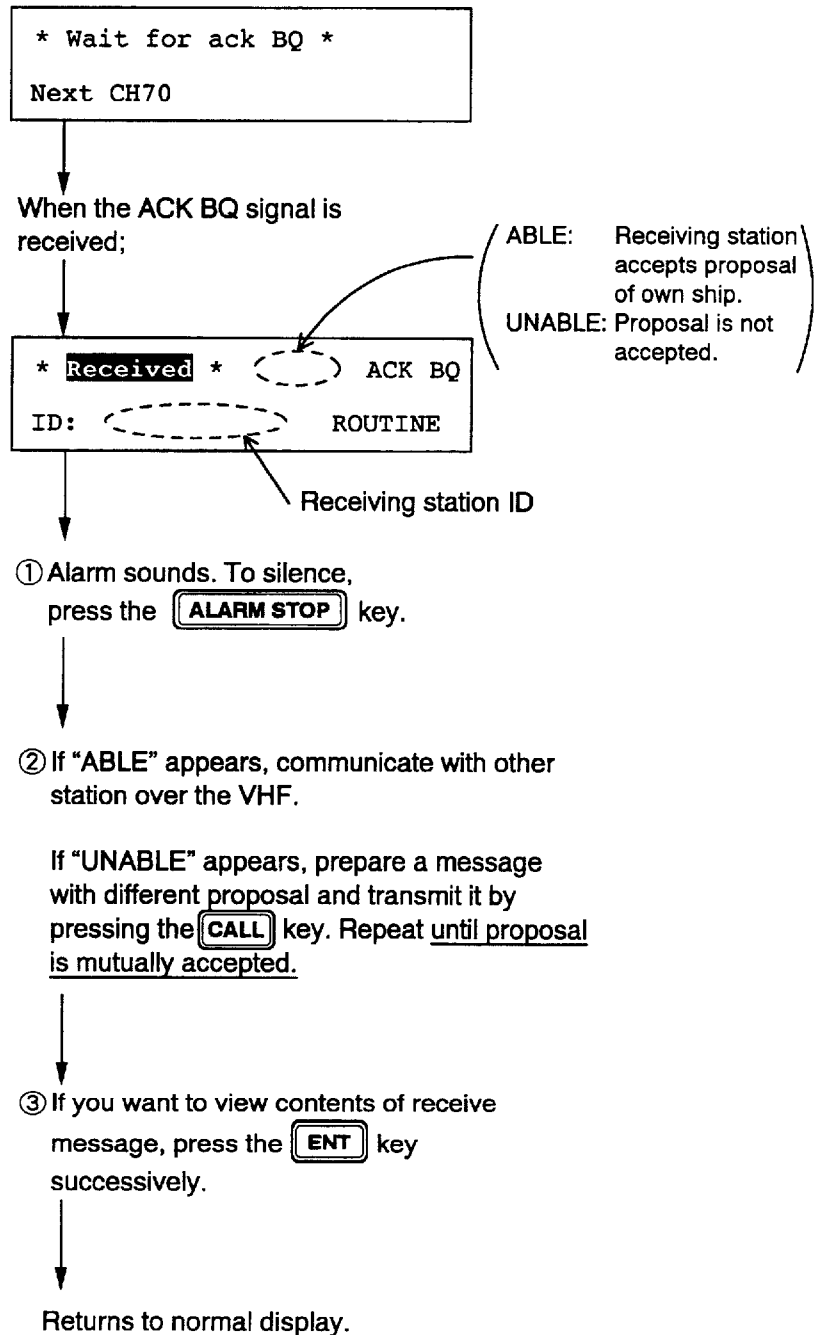

9.3 Receiving "Individual Call" (ACK RQ)

General

When an individual call is received, the DSC-8V responds to the call depending on the setting of automatic acknowledge (AUTO ACK) function:

- **AUTO ACK: ON** ("auto" appears.)
The DSC transmits the acknowledge back (ACK BQ) signal automatically.
- **AUTO ACK: OFF** ("limit" or "manual" appears.)
Verify contents of receive message by pressing the **ENT** key successively, then manually transmit the ACK BQ signal by pressing the **CALL** key.

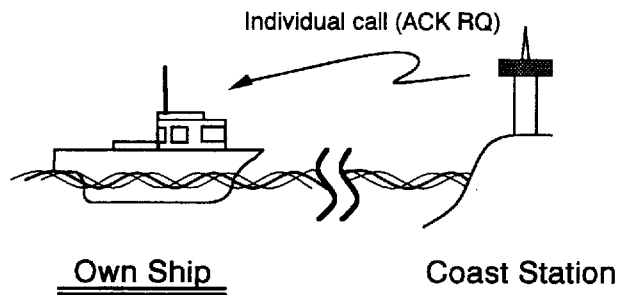

Setting of "ABLE" or "UNABLE"

When AUTO ACK function is ON, you can select either "able" or "unable" (to comply) for proposal from other station. See the next page.

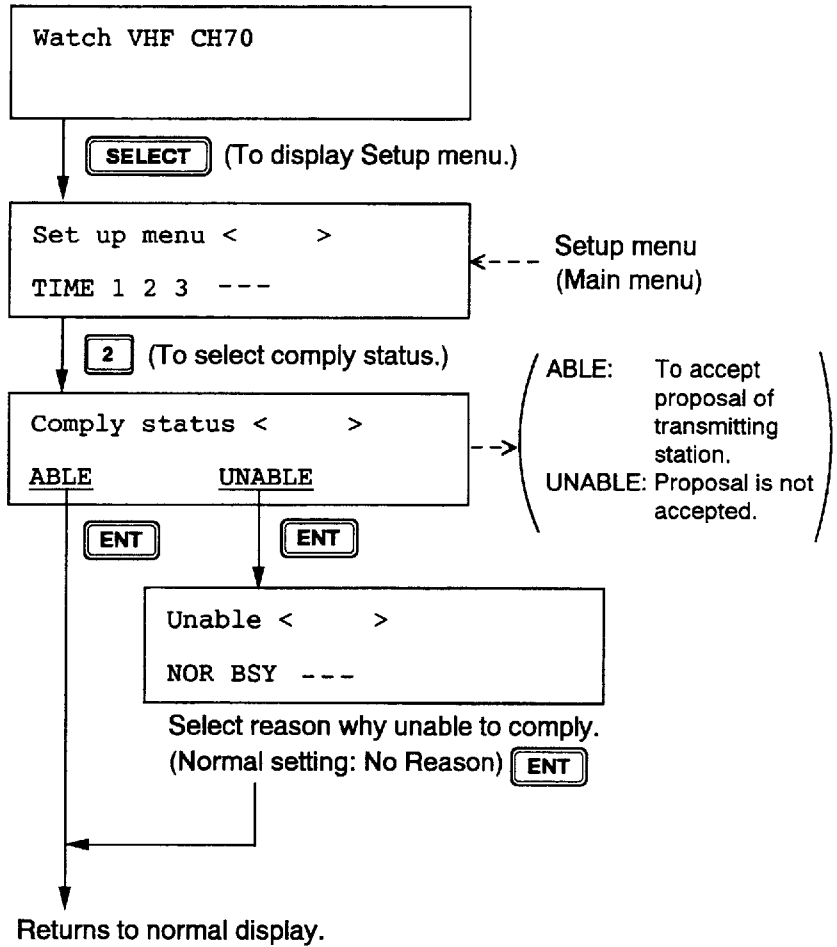

Receiving a message (ACK RQ) with AUTO ACK On

The DSC-8V sends the ACK BQ signal automatically.

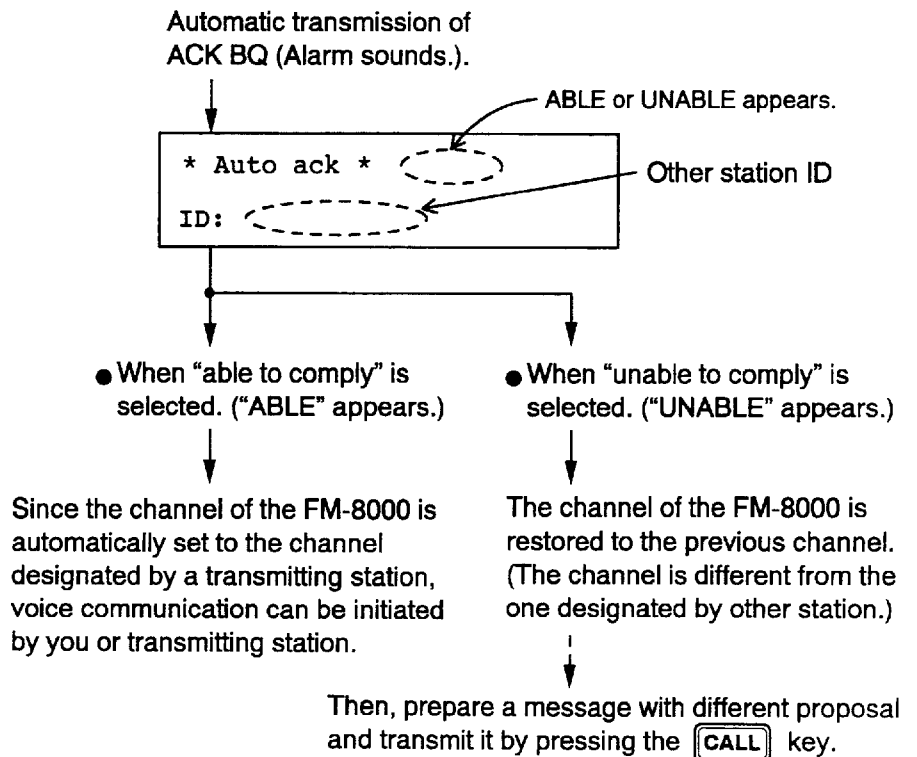

**Receiving
ACK RQ with
AUTO ACK Off**

After verifying contents of receive message, manually transmit the ACK BQ signal by pressing the **CALL** key within five minutes. If the signal is transmitted more than five minutes after reception of ACK RQ signal, it is treated as an ACK RQ signal rather than ACK BQ.

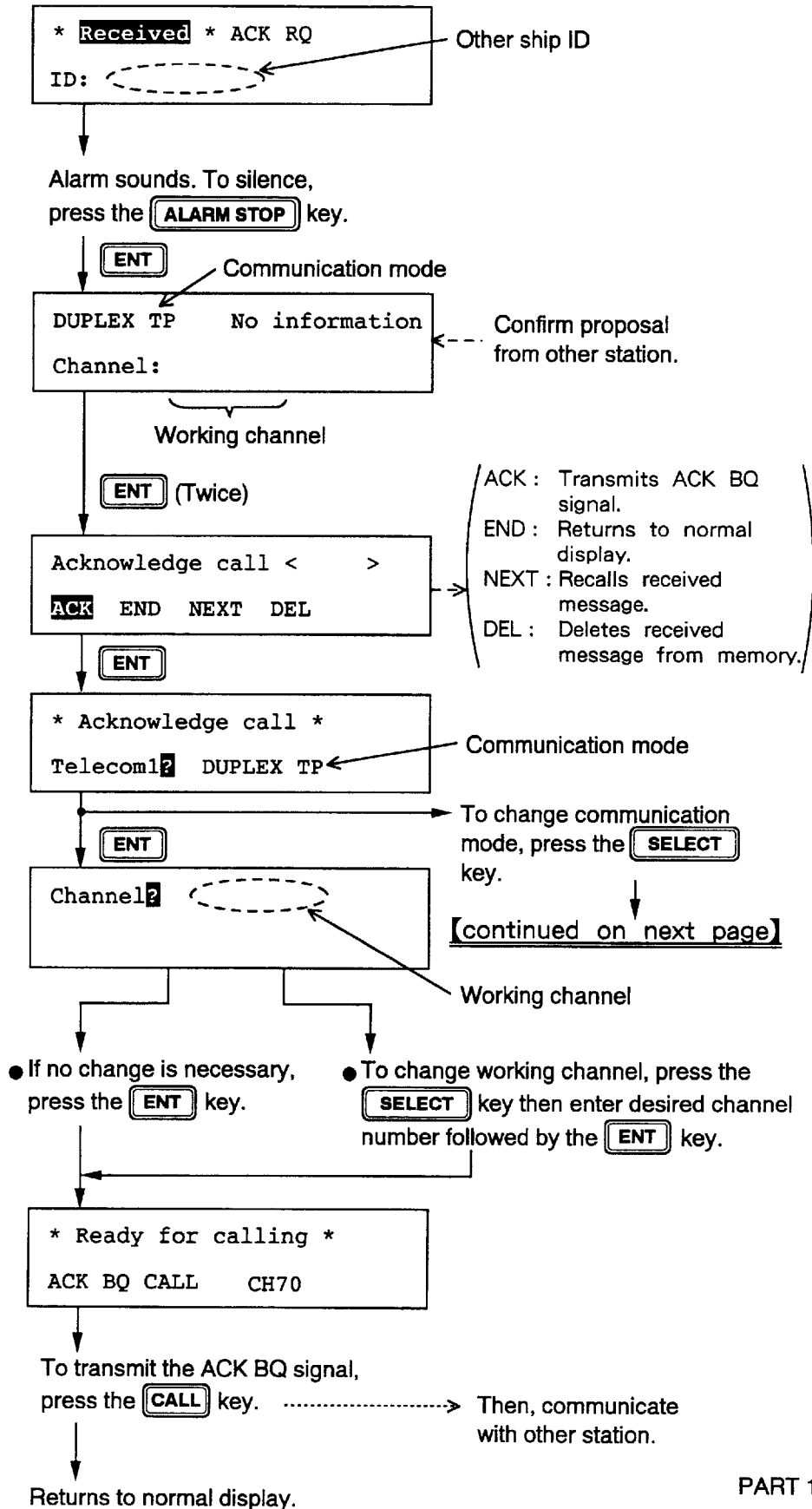

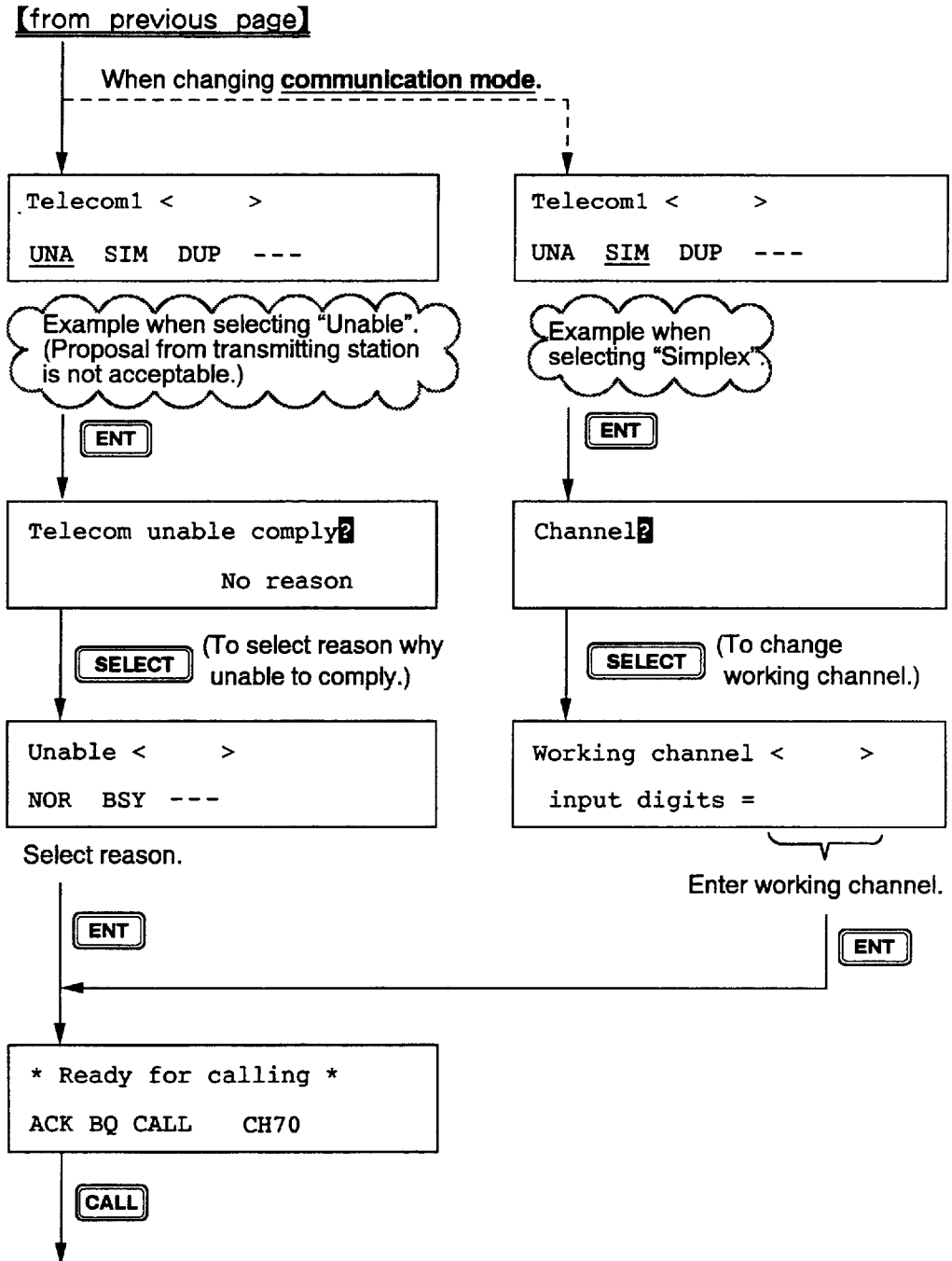

If a different communication mode is selected as shown above, "ACK BQ" call is first transmitted and "ACK RQ" call automatically continues. This means the message proposed here is transmitted as ACK RQ signal (not ACK BQ). Finally the "Wait for ACK BQ" screen appears.

10. Preparing and Saving Transmit Messages

10.1 Preparing and Saving Transmit Messages

General

There are two ways to prepare and transmit a message:

1. Prepare a message for immediate transmission. (Refer to pages 8-1 and 9-1.)
2. Prepare a message and store it for later transmission.

You can save up to 99 transmit messages (excluding distress messages) to the memory. These are numbered 01 to 99.

Procedure

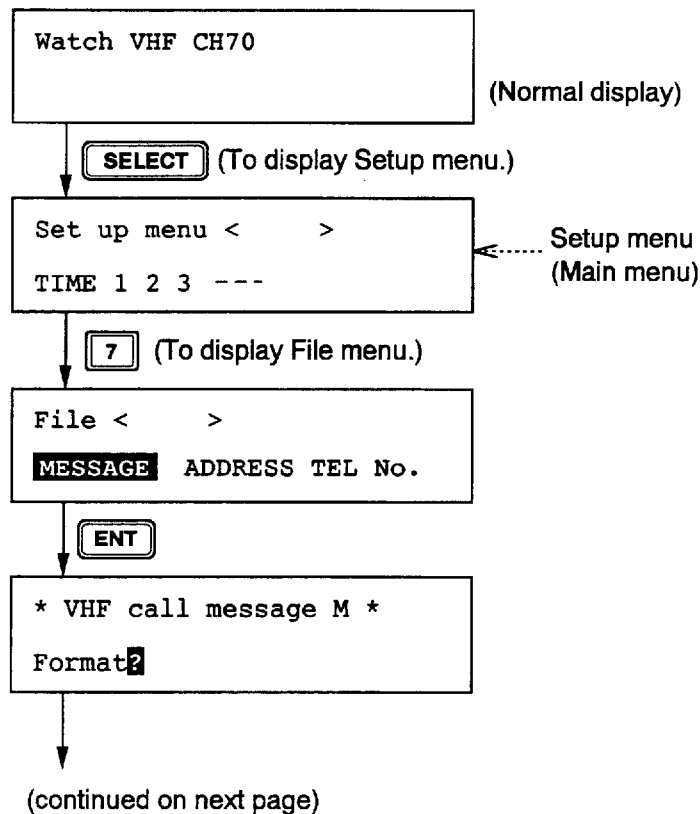

(from previous page)

Prepare a message by referring to page 8-1 (All Ships) and page 9-1 (Individual).

* Ready for filing *

ENT (To select file number under which to save message.)

Call message < >
01/99:

To select a different file number, use the arrow keys.
(**▶** : Up, **◀** : Down)

File No. (blinking)

ENT (To assign file name.)

Name < >
END A B C D ----- R →

To scroll screen, press the **▶** key.

Assign a file name (max. 16 characters) by the arrow keys, **ENT** key and ten keys.

Example File Name: A1

1. Place the cursor on "A" with the arrow keys and press the **ENT** key.
(For alphabet always press **ENT** after selection.)
2. Press the **1** key.

To change specific character, press **SELECT** and ...

▶ : Moves upper cursor rightward every pressing.
◀ : Moves upper cursor leftward every pressing.

Name < A1 >
END A B C D ---

To change entire name, press the **CANCEL** key.

Press **◀** to place the lower cursor on "END".

ENT →

Next file memory < >
END NEXT

Using the example above, the unit saves the transmit message to the memory under file number 1, file name "A1".

To prepare another message;

ENT **ENT**

Returns to normal display.

* VHF call message M *
Format?

10.2 Writing Over a File

General

You may write over unnecessary files. Simply prepare a message and store it under file number of unnecessary file.

Procedure

Example: You want to write over file saved under file number 01.

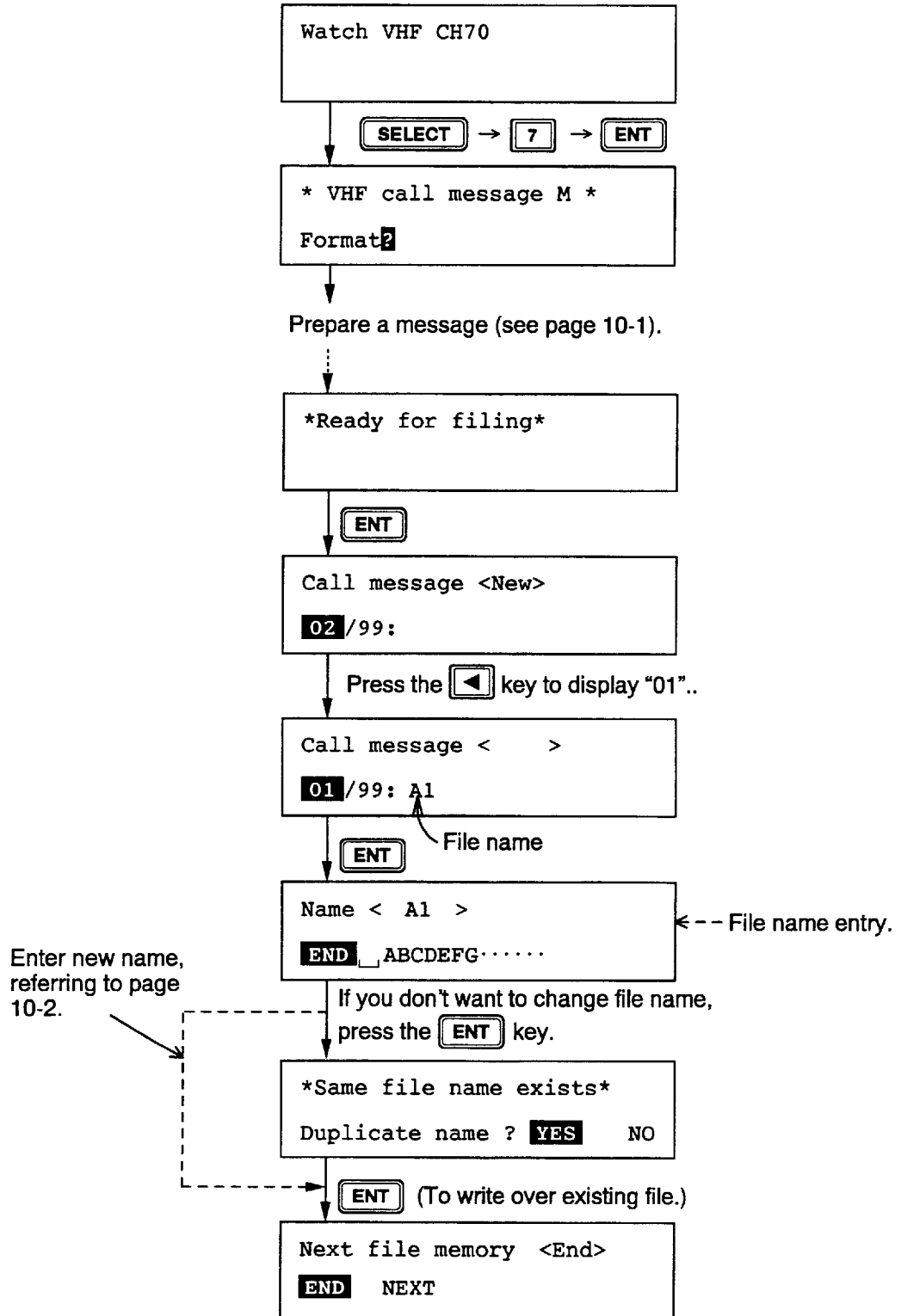

10.3 Retrieving and Transmitting a File

Retrieving a file

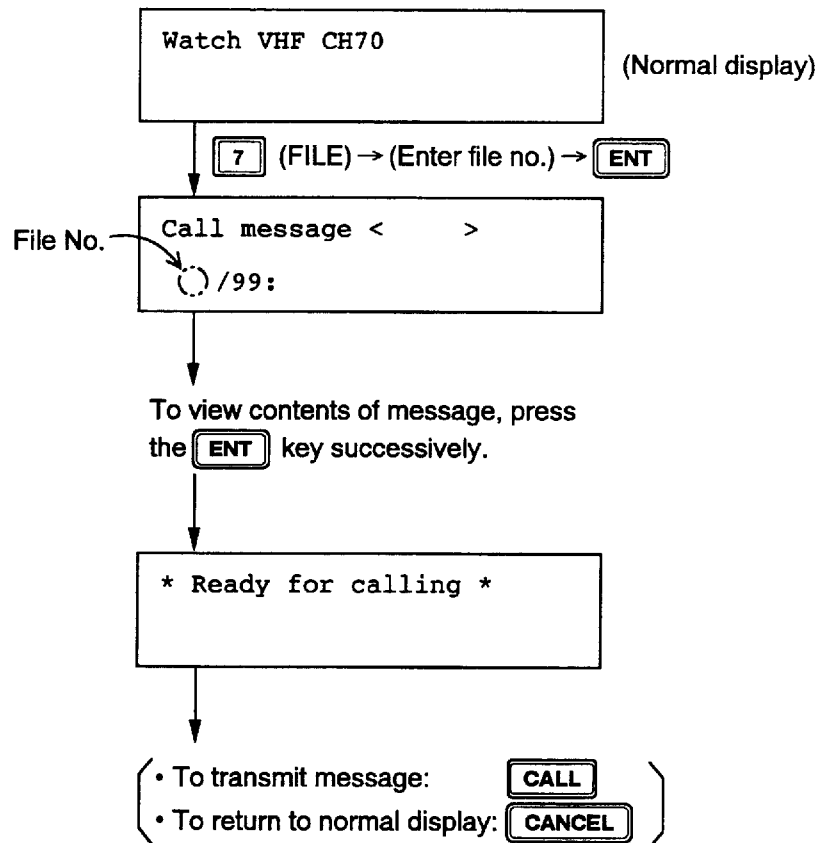

Transmitting a file

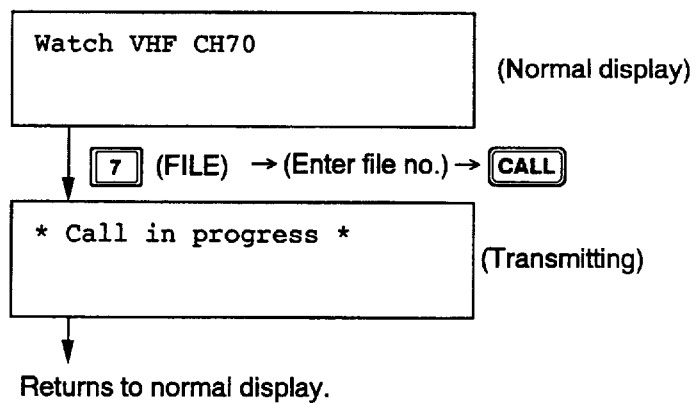

11. Transmit/Receive Message Memory

11.1 Transmit Message Memory

General

The transmit message memory stores **up to 50 transmitted messages** (numbered 1 to 50) on a first-in, first-out basis. This means each time you save a transmitted message it is filed as log no. 1 and the log no. of all previously stored transmit messages changes by one. When the memory is full the oldest file is deleted.

Retrieving a transmit message

Press the **[9]** (XMTD) key at the normal display.

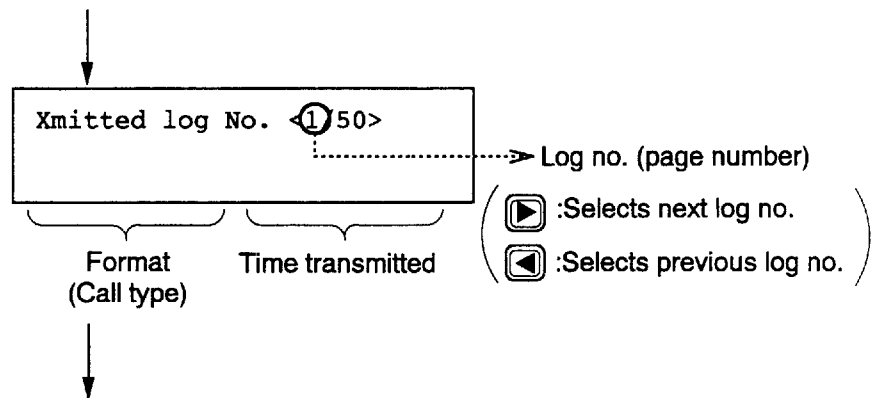

To view contents of message, press the **[ENT]** key successively.

**Transmitting
retrieved
message**

You can transmit a retrieved message as follows.

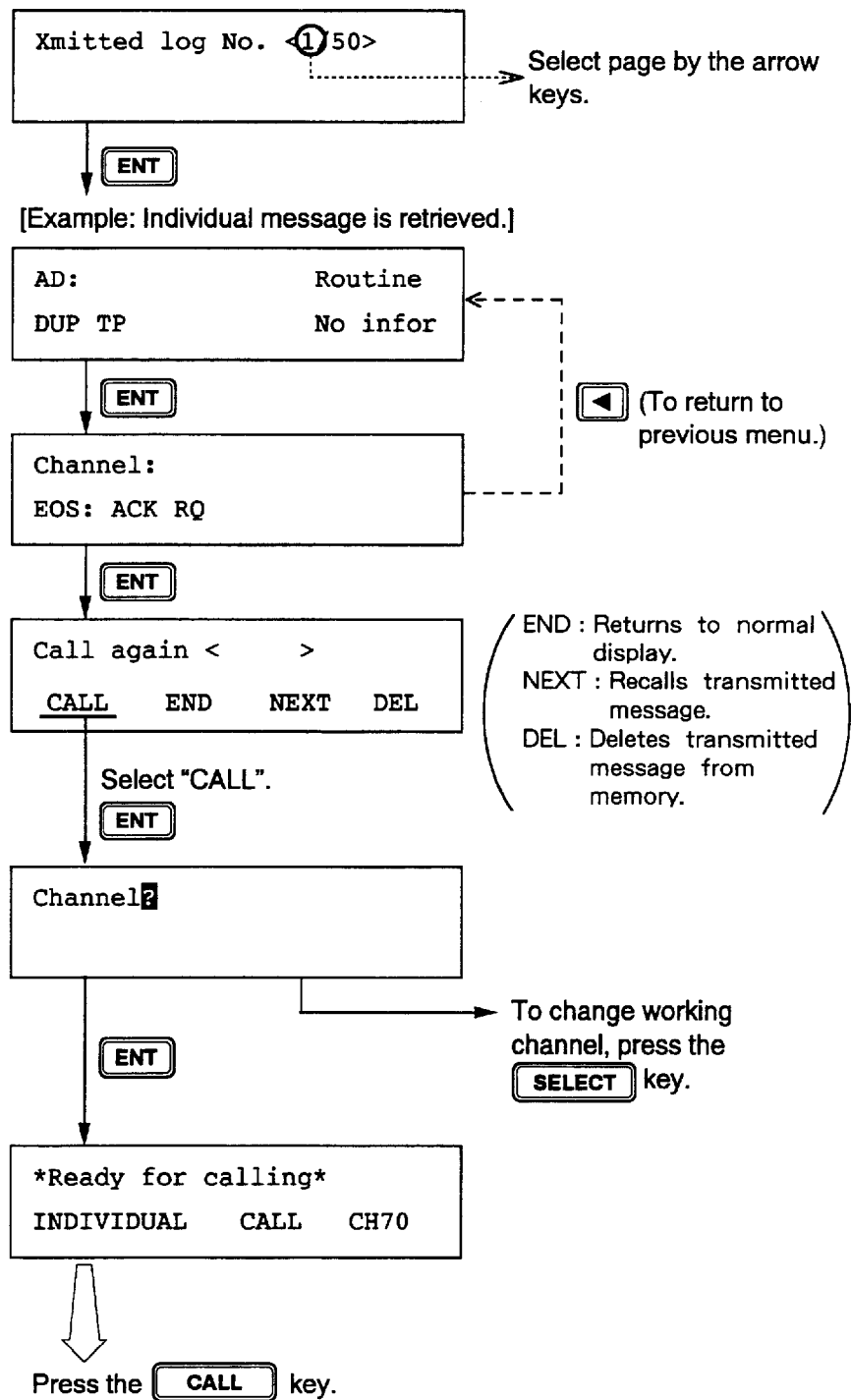

11.2 Receive Message Memory

General

All received messages are automatically saved to the memory and filed according to category, DISTRESS or ORDINARY. The receive message memory can store **up to 50 messages** (numbered 1 to 50) of each category on a first-in, first-out basis. This means each time the unit receives a message it saves it as log no. 1 and changes the log no. of all previously received messages by one. When the memory is full the oldest file is deleted.

Retrieving a receive message

Press the **8** (RCVD) key at normal display.

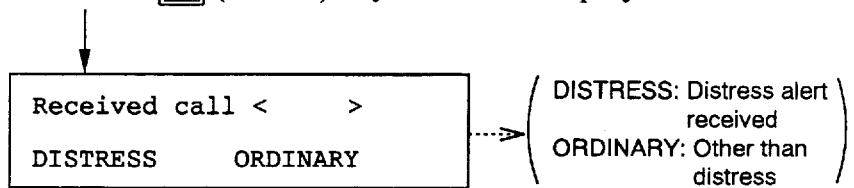

For example, "ORDINARY" log;

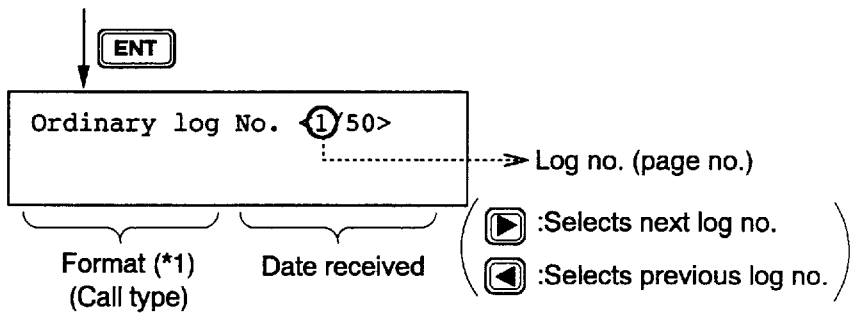

To view contents of message, press the **ENT** key successively.

(*1) : If own ship did not transmit "ACK BQ" (acknowledge back) signal a blinking sharp symbol (#) appears at head of Format.

Transmitting retrieved message

You can send the acknowledged call (DIST ACK or ACK BQ) under certain conditions after retrieving a received message. Refer to page 5-1 for transmitting the DIST ACK signal.

Example: Transmit acknowledge back (ACK BQ) signal in response to an individual call (Refer to page 9-7.)

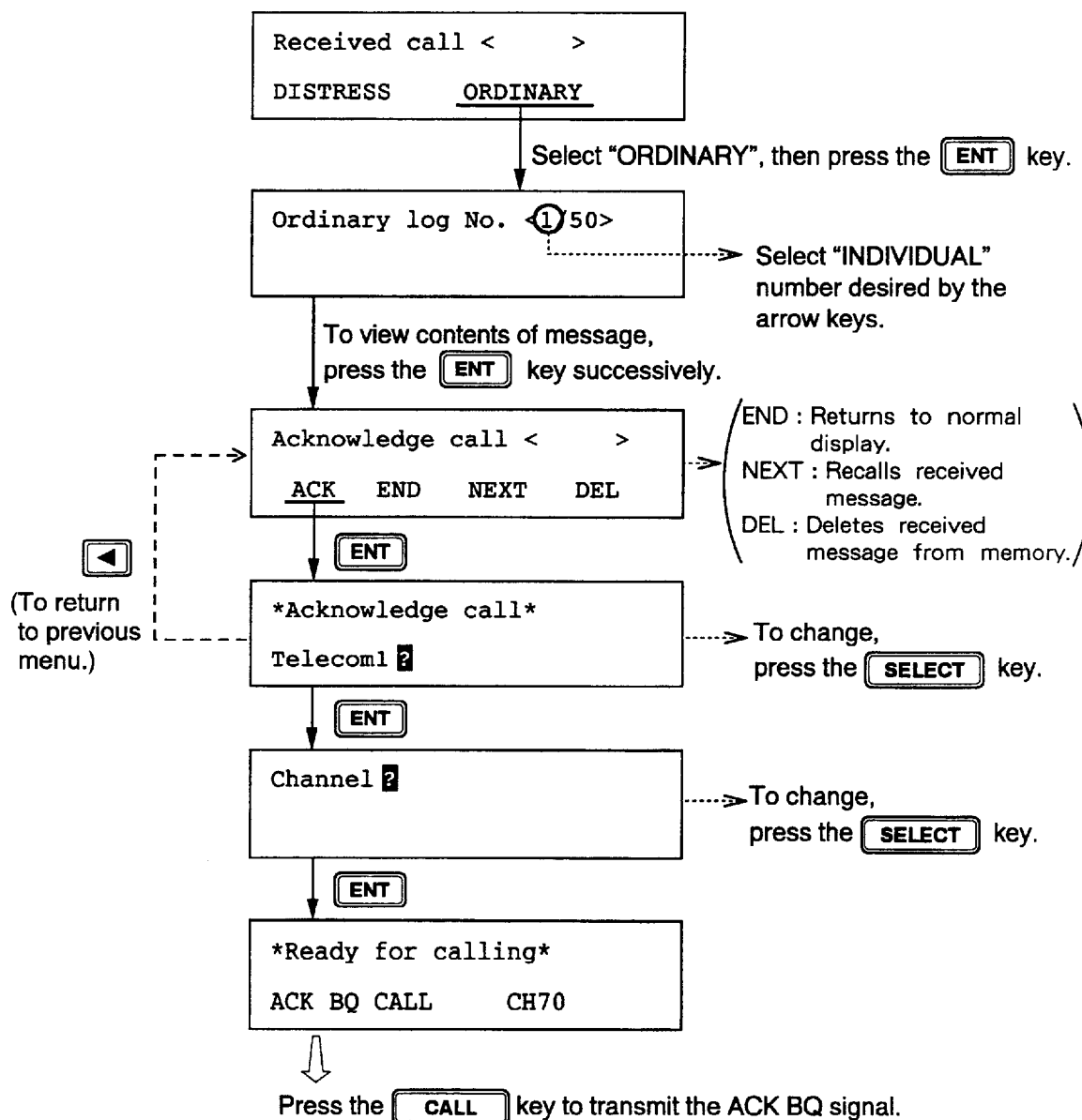

NOTE: If the signal is transmitted more than five minutes after reception of ACK RQ signal, it is treated as an ACK RQ signal rather than ACK BQ. Finally the "Wait for ACK BQ" screen appears.

12. Printer Setup (Auto/Manual)

General

You can select either automatic or manual printing by following the procedure shown below. (Factory setting: Auto)

Procedure

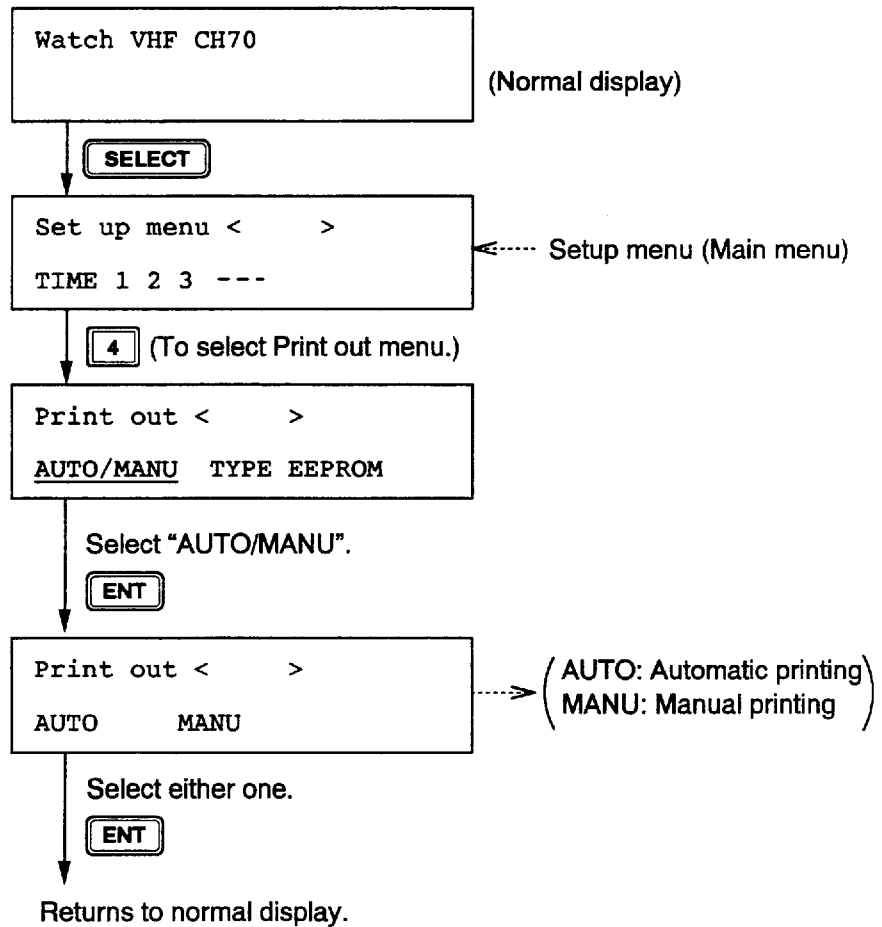

Automatic printing

When "AUTO" is selected, all transmitted and received messages will be automatically printed out when transmitted and received.

Manual printing

When "Manual" is selected, press the **4** (PRINT) key to print out message desired. Note that manual printing is available even when "AUTO" is selected.

The contents to be printed depend on when the **4** key is pressed, as shown in the table below.

No.	Printing	Timing of 4 key pressing	Example Printout
1	Contents of {VHF call message}	During "VHF call message" display to "Ready for calling" display.	(a)
2	Contents of all transmitted logs {Xmitted log No. < >}	Displayed [Xmitted log No. < >] (To stop printing, press CANCEL .)	(b)
3	Contents of specific log no. (for example, log no. 1) {Xmitted log No. <1/50>}	During " [Xmitted...] ⇒ ENT " display to "EOS" display.	(c)
4	Call message (again) Call again CALL END..	Channel? to Ready for calling	(a)
5	Contents of all received logs {Ordinary log No. < >} (Distress)	Displayed [Ordinary log No. < >] (Distress) (To stop printing, press CANCEL key.)	(d)
6	Contents of specific log no. (for example, log no. 1) {Ordinary log No. <1/50>} (Distress)	[Ordinary ...] display ⇒ ENT *Received* to	(e)
7	① Currently received message *Received*	ECC: OK	(f)
	② Acknowledge message Acknowledge call < >	"Ready for calling" is displayed.	(f)
8	Contents of currently prepared {VHF call message M}	During "VHF call message M" display to "Ready for filing" display.	(g)
9	All lists of {saved message} or contents of all {Address or Tel No.} files. • SELECT ⇒ 7 File < > Message Address Tel No.	• For example, to print out all coast addresses in the memory, press 4 at display ① on page 13-9. Press 4 to print out all list of saved messages.	(h)

Example printouts

(a) Format : INDIVIDUAL
Address : 000000000
Category: Routine
Telecom1: DUPLEX TP
Telecom2: RES No.18
Channel : 23
EOS : ACK RQ
ECC :

DSC ch : 70

(c) Xmt message JAN01 00:09
Format : INDIVIDUAL
Address : 004310000
Category: Routine
Telecom1: DUPLEX TP
Telecom2: RES No.18
Channel : 23
EOS : ACK BQ

DSC ch : 70

(e) Rcv message JAN01 00:07
Format : INDIVIDUAL
Address : 431000001
Category: Routine
Telecom1: DUPLEX TP
Telecom2: RES No.18
Channel : 23
EOS : ACK RQ
ECC : OK

DSC ch : 70

(f) Format : INDIVIDUAL
Address : 431000001
Category: Routine
Telecom1: DUPLEX TP
Telecom2: RES No.18
Channel : 23
EOS : ACK BQ

DSC ch : 70

(h) **** Call message file ****
01: FURUNO Individual
02: CAPTAIN All ships

(b) ***** Xmitted log *****
Xmt message JAN01 12:34
Format : INDIVIDUAL
Address : 004310000
Category: Routine
Telecom1: DUPLEX TP
Telecom2: RES No.18
Channel : 23
EOS : ACK BQ

DSC ch : 70

(d) *****Ordinary log*****
Rcv message JAN01 02:04
Format : ALL SHIPS
Category: Safety
Telecom1: SIMPLEX TP
Telecom2: RES No.18
Channel : 16
EOS : EOS
ECC : OK

DSC ch : 70

Rcv message JAN01 02:03
Format : INDIVIDUAL
Address : 004310001
Category: Safety
Telecom1: SIMPLEX TP
Telecom2: RES No.18
Channel : No information
EOS : ACK RQ
ECC : OK

DSC ch : 70

(g) Format : INDIVIDUAL
Address : 000000000
Category: Routine
Telecom1: DUPLEX TP
Telecom2: RES No.18
Channel : 23
EOS : ACK RQ
ECC : OK

DSC ch : 70

13. Other Calling Types and Other Functions

13.1 Other Calling Types

General

The DSC-8V provides 12 calling types. Of these, individual, all ships and distress were discussed in previous chapters. This section describes the other types of calls available. The procedure for preparing and transmitting other calls is the same as that for individual and all ships calls: Select type of call, prepare message and transmit it by pressing the **CALL** key.

Selection of calling type

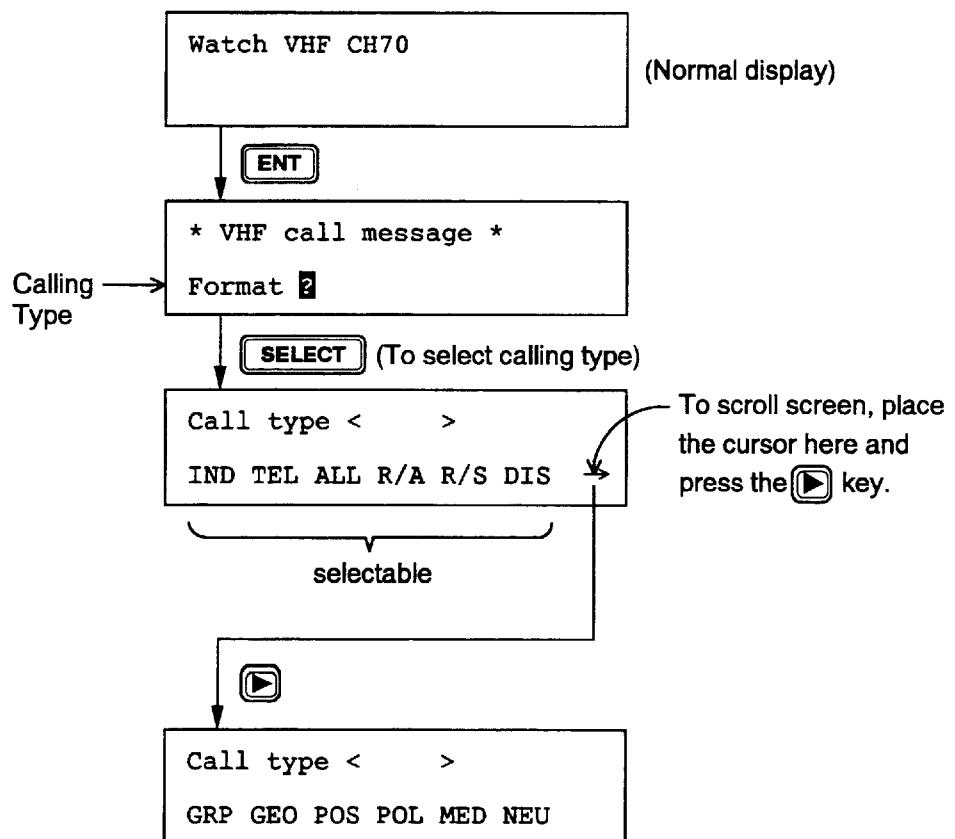

Description of all 12 calling types appears on the next pages.

- **IND** : Individual call (Refer to page 9-1.)
- **TEL** : Telephone call (semi-auto/auto call. Refer to page 13-4.)
 Call a terrestrial network, for example, your office through a coast station.
- **ALL** : All ships call (Refer to page 8-1.)
- **R/A and R/S** : Distress relay for All ships and for Selective (Individual) calls (Refer to page 6-1.)
- **DIS** : Distress call (Refer to page 3-1)
- **GRP** : Group call
 Call a specific group by entering group ID number.
- **GEO** : Geographic area call
 Call for ships within a range set by you in the transmit message (menu). To designate the range, enter reference point and width (range) data of both longitude and latitude.

Example: Ocean AD · · 34N 135E da10 do5

Range data

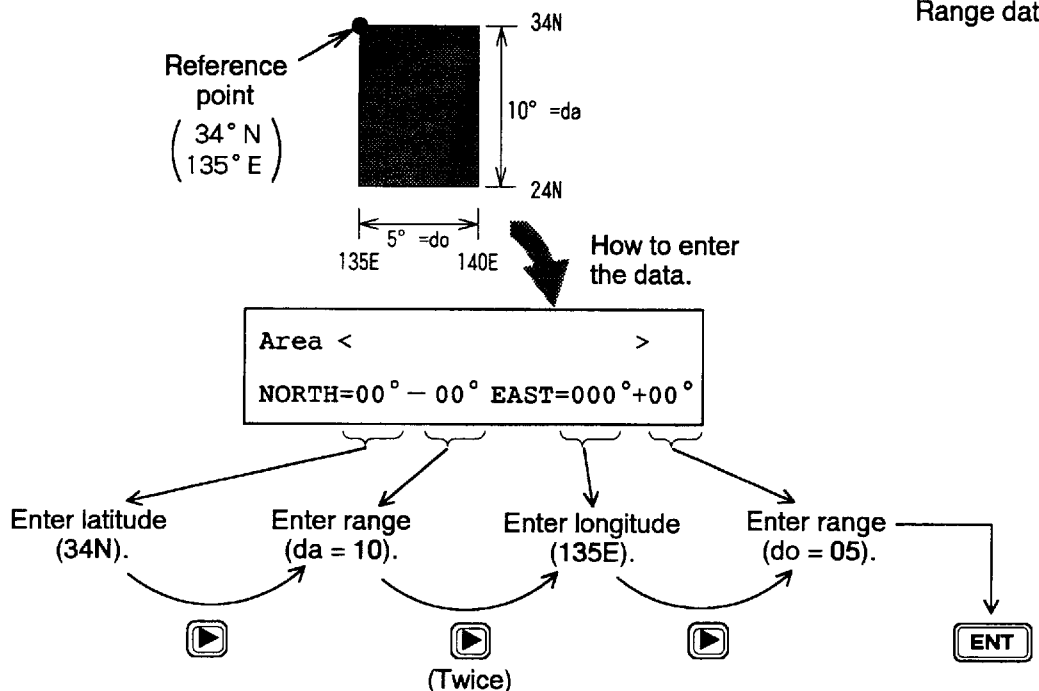

- **POS** : **Position request (Individual call)**
Find position of other ship by entering its ID number.

- **POL** : **Polling call (Individual call)**
Confirm that own ship is within communication range with other ship. This provides only negative response; it does not provide position information.

- **MED** : **Medical transport (All ships call)**
Inform all ships, by using “urgent” category, that own ship carries medical goods.

- **NEU** : **Neutral craft (All ships call)**
Inform all ships that own ship is not a participant in an armed conflict.

13.2 Telephone Call

General

When the coast station serves PSTN telephone service you can make Telephone Call via Coast Station.

Procedure

Basic procedure

1. Selection of Format specifier.
2. Entry of Coast Station ID.
3. Entry of Telephone number.

Detailed procedure

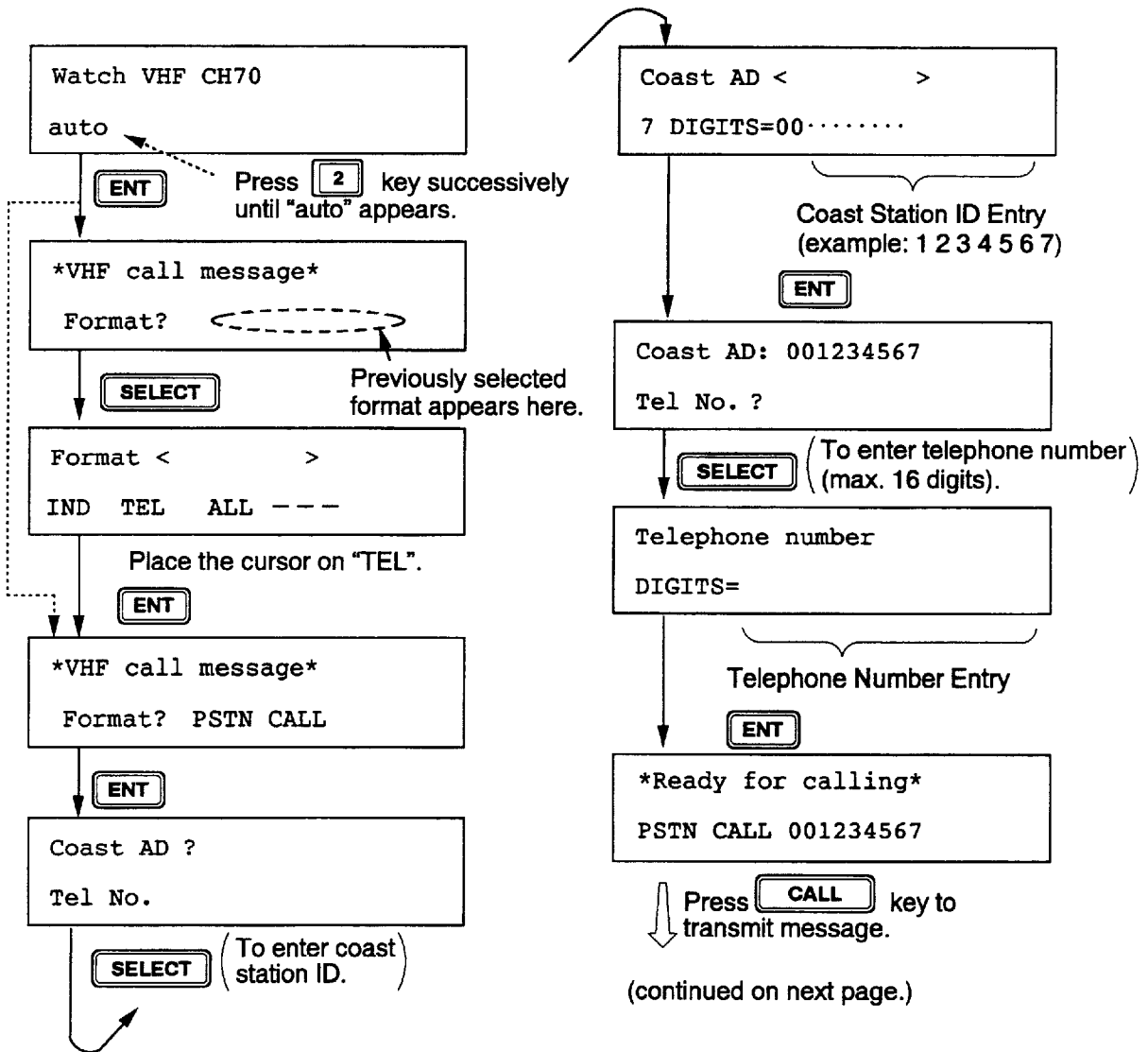

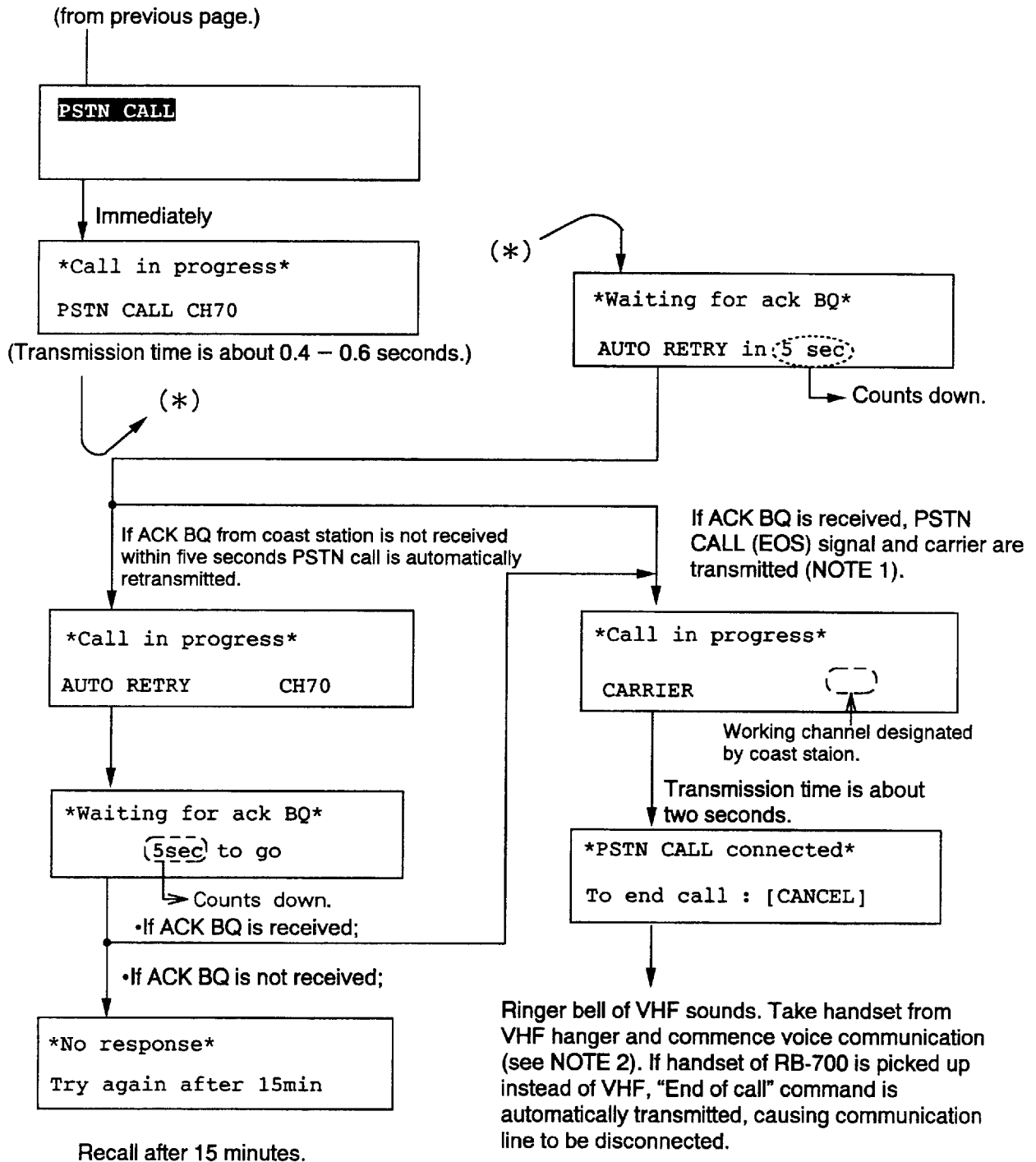

(NOTE 1) When you receive "unable to comply"(BUSY) command instead of "able", the DSC-8V waits for "Ring back call" from coast station for 15.5 minutes. Then, if it is received, carrier is automatically transmitted.

(NOTE 2) If there is no reply (voice response) from subscriber within one minute at "PSTN CALL connected" display, the communication line will be disconnected. The display should look something like the display ② on the page 13-7. If you hang the handset on the hanger, the display ① shown on the next page appears to break the communication line.

Operation after making DSC call

Voice communication is started. (Press and hold the PTT switch only for the FM-7000 during communication to send carrier continuously. If carrier transmission is interrupted for five seconds, the communication line is disconnected and the display ② shown on the page 13-7 appears. If the handset of the RB-700 (only when RB-700 has higher priority than VHF) is picked up while communicating with a subscriber by the VHF, "End of call" command is automatically transmitted.) After completion of communication, the display changes as shown in (1) or (2) below depending on how voice communication is terminated.

(1) When you end voice communication by pressing the **CANCEL** key or hanging the handset on the hanger of the VHF, the display of the DSC-8V changes as follows.

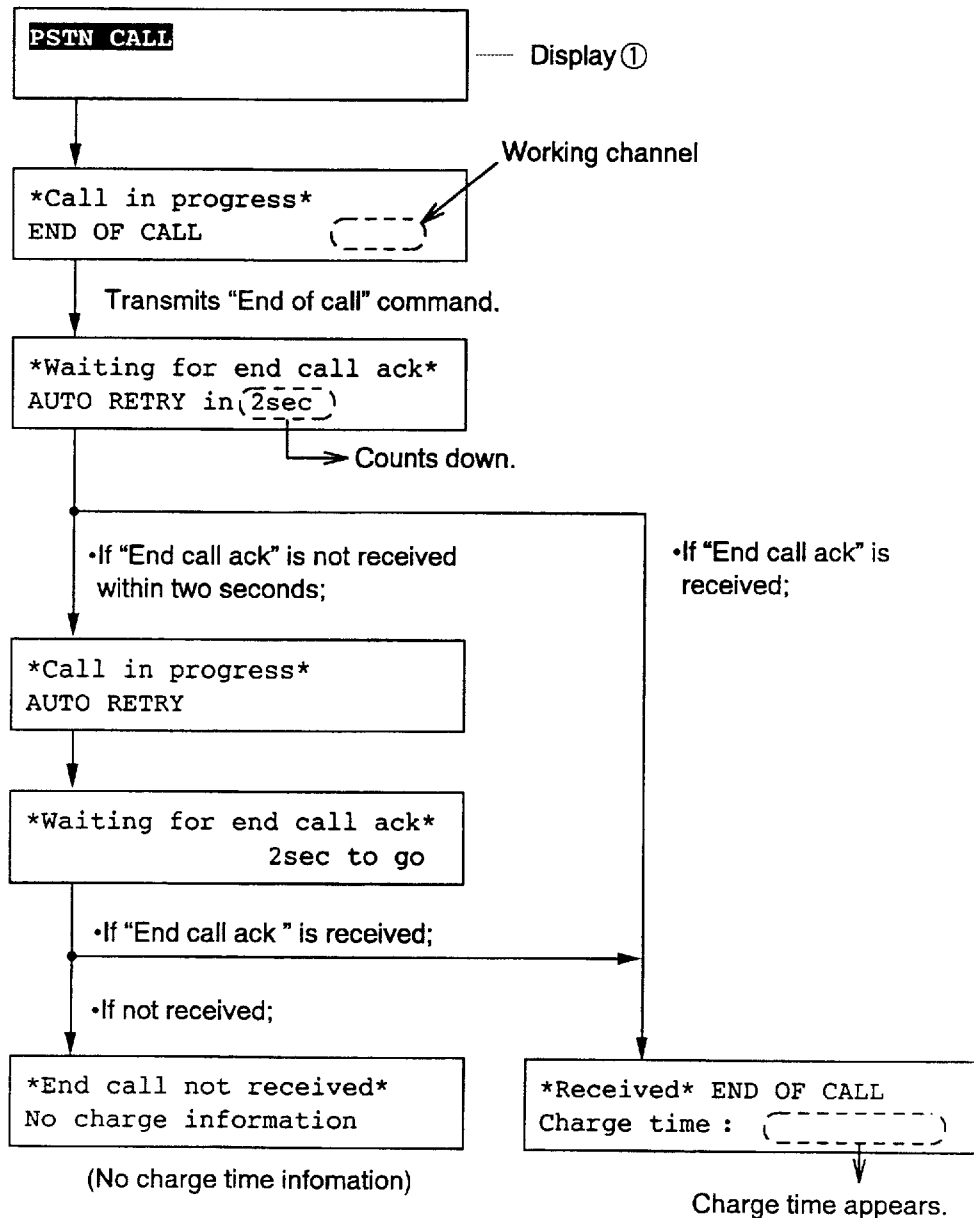

(2) When coast station terminates communication, the display of the DSC-8V is as follows.

When the "End of call" command from coast station is received;

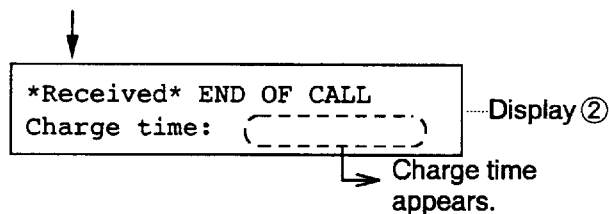

NOTE: If a subscriber hangs the handset on the hanger to terminate voice communication, coast station will transmit the "End of call" command to you to break the communication line.

13.3 Receiving Telephone Call from Coast Station

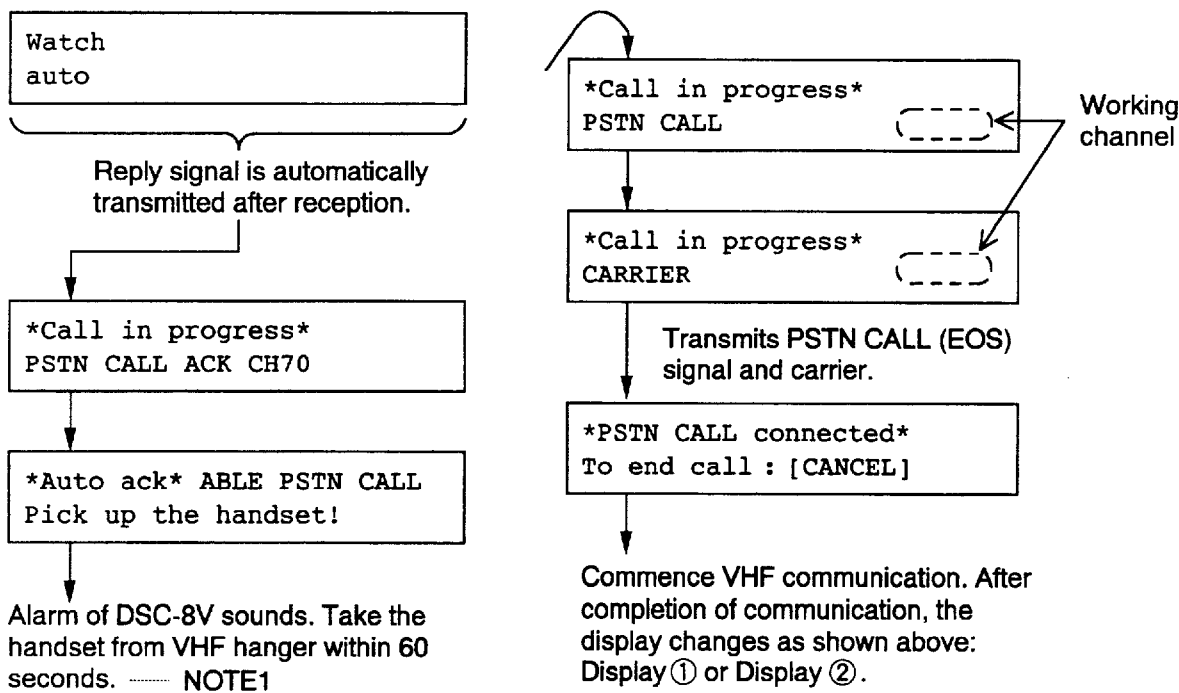

NOTE 1: If more than 60 seconds elapses without taking the handset from the hanger, call is canceled.

13.4 Other Station IDs and Telephone Nos.

Registering

You can program often-used station IDs and telephone numbers under a file name. (Max. 99 files each)

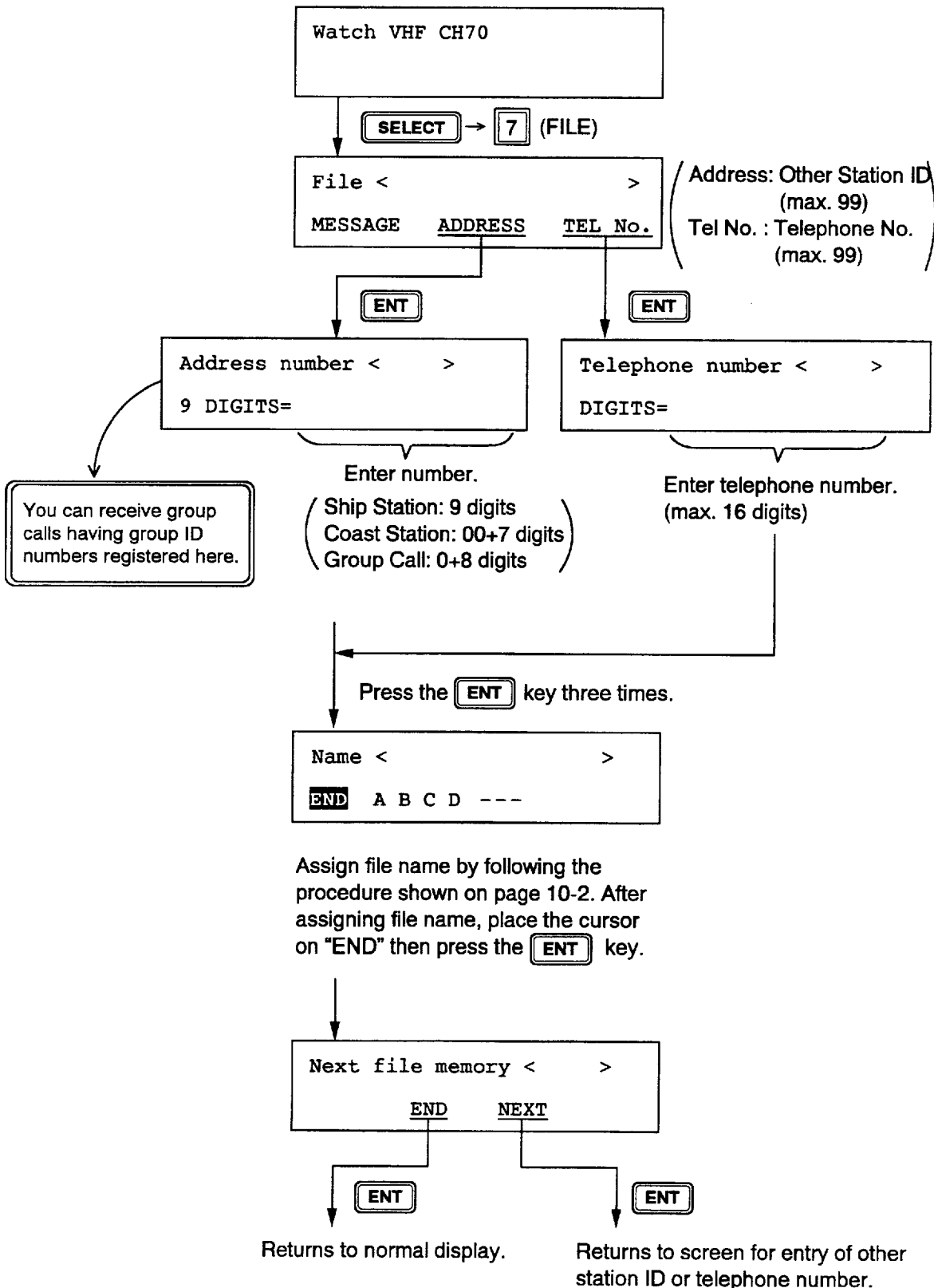

Retrieving

You can retrieve a file registered on previous page, and use it with message which you are currently preparing.

To retrieve a file, **press the 7 (FILE) key on a display where the blinking question mark appears.**

[Example]

1. Retrieving Other Station ID

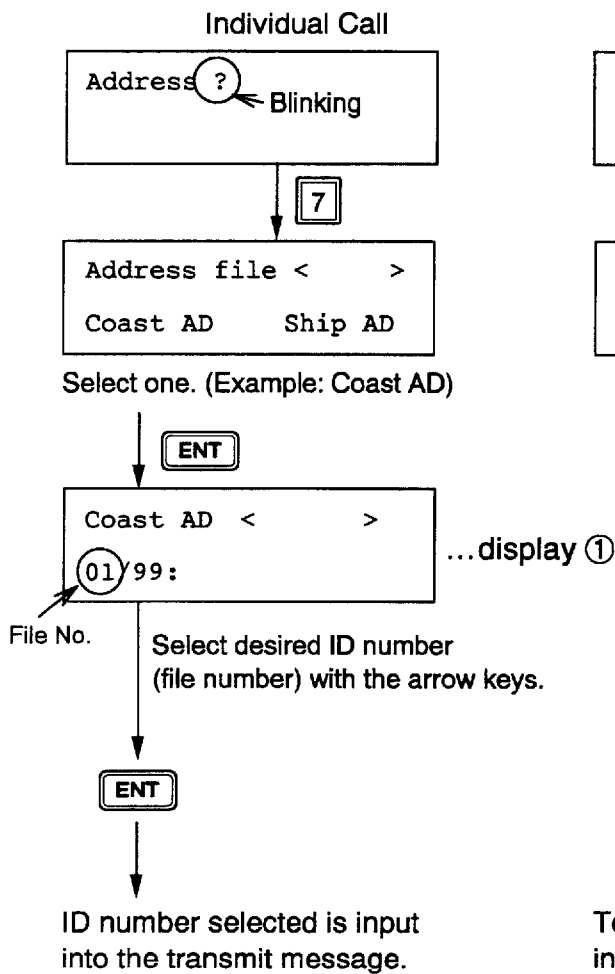

2. Retrieving Telephone Number

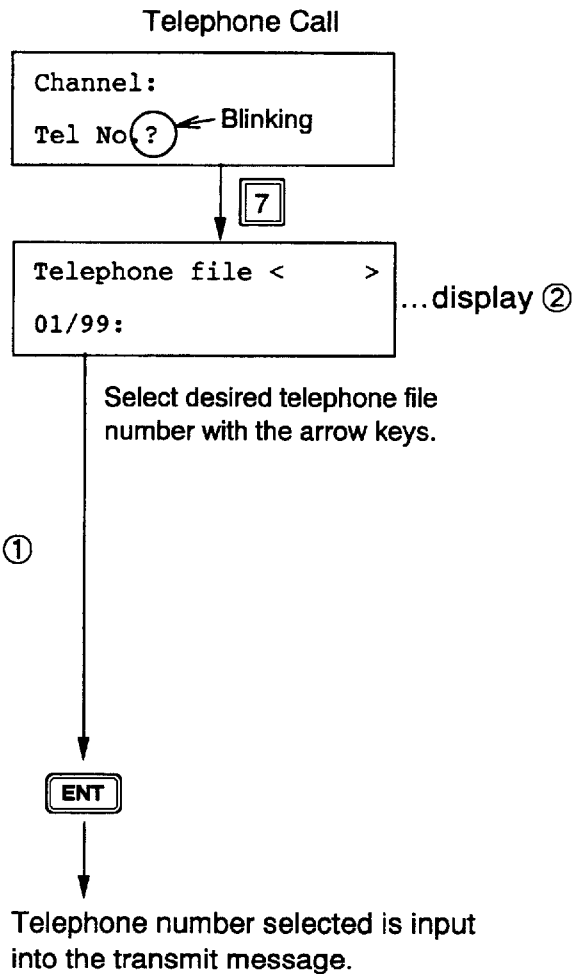

Note: Each press of the SELECT key at display ① or display ② alternates file number and alphabet prefixed file name.

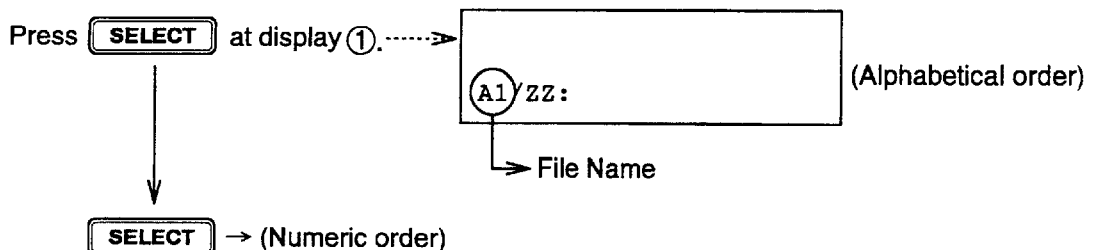

14. Menu List

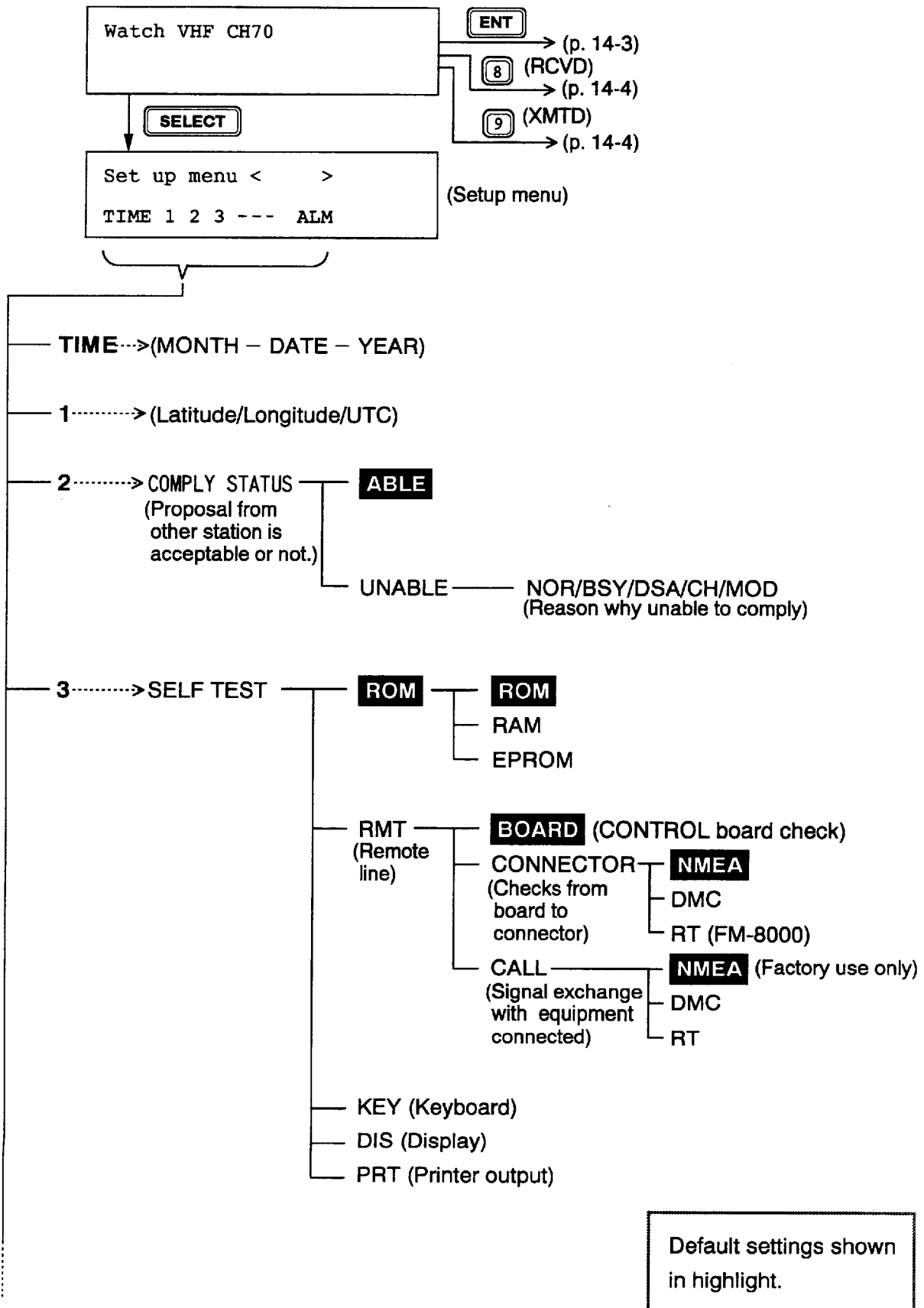

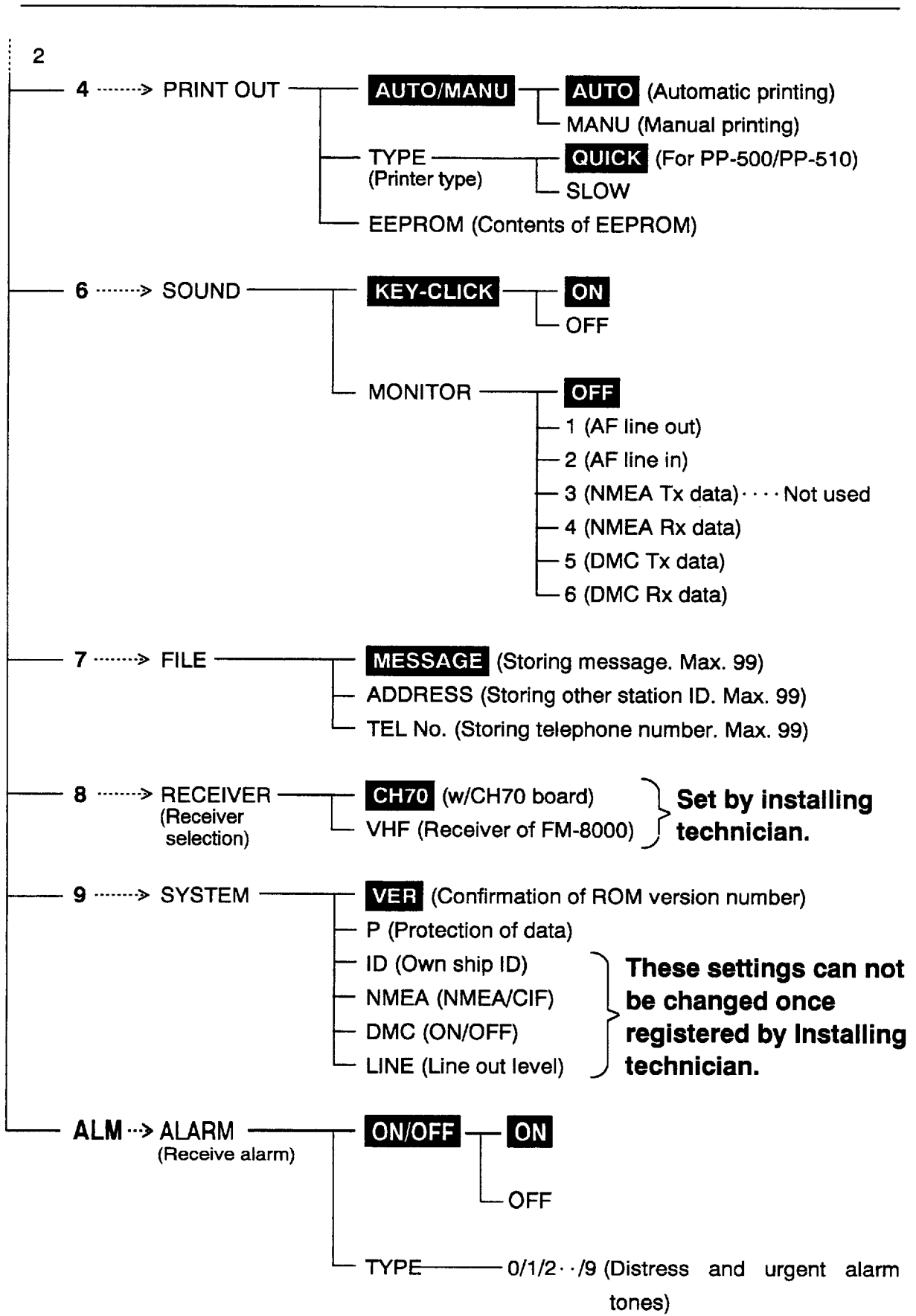

Default settings shown in highlight.

● Normal display

ENT

* VHF call message *

Format ?

(Preparing transmit message)

FORMAT

INDIVIDUAL — ADDRESS — CATEGORY — TELECOM — WORKING CH

TELEPHONE — COAST ADDR — TEL NO.
(DIALPHONE)

ALL SHIPS — CATEGORY — TELECOM — WORKING CH

R/A (DISTRESS RELAY ·· ALL SHIPS) — DIST SHIP ID — N. OF DIST — POS & TIME

R/S (DISTRESS RELAY ·· INDIVIDUAL) — COAST ADDR

DISTRESS — NATURE OF DISTRESS — POSITION & TIME

GROUP — GROUP ADDR — CATEGORY — TELECOM — WORKING CH

GEOGRAPHIC AREA

OCEAN ADDR — CATEGORY — TELECOM — WORKING CH

POSITION REQUEST — ADDR — CATEGORY — TELECOM (POSITION)
(Normally ROUTINE)

POLLING — ADDR — CATEGORY — TELECOM (POLLING)
(Normally ROUTINE)

MEDICAL TRANSPORT — TELECOM — WORKING CH

NEUTRAL CRAFT — CATEGORY — WORKING CH

● Normal display

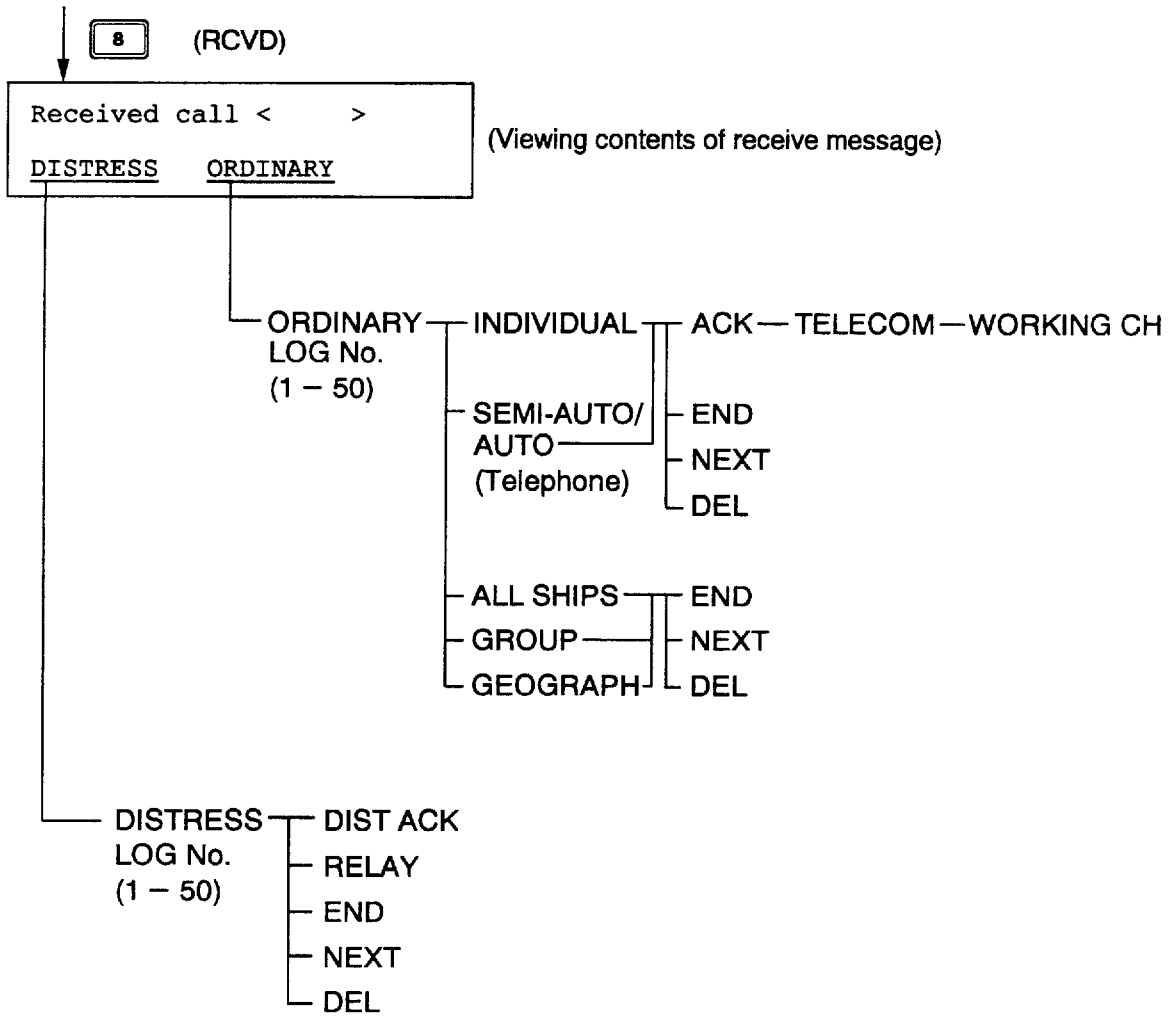

● Normal display

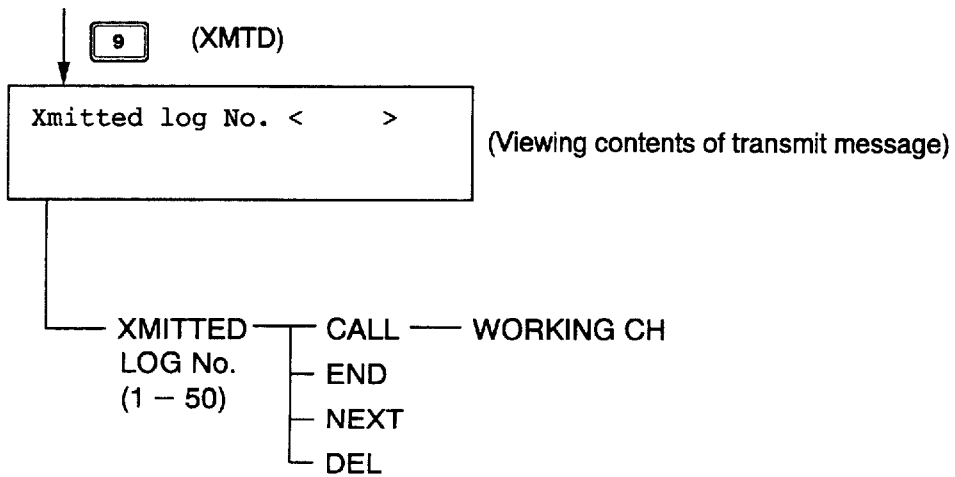

PART 2

Maintenance

PART 2 Table of Contents

(Maintenance)

	<u>Page</u>
1. Daily Operating Test	1-1
2. Visual Check	2-1
3. Self-test for Technician	3-1
4. About Internal Battery	4-1

1. Daily Operating Test

General

This unit is equipped with a self diagnosis test which checks for proper operation. We recommend daily execution of the test to ensure proper transmission in case of distress.

Procedure

Press the **[3]** key at the normal display.

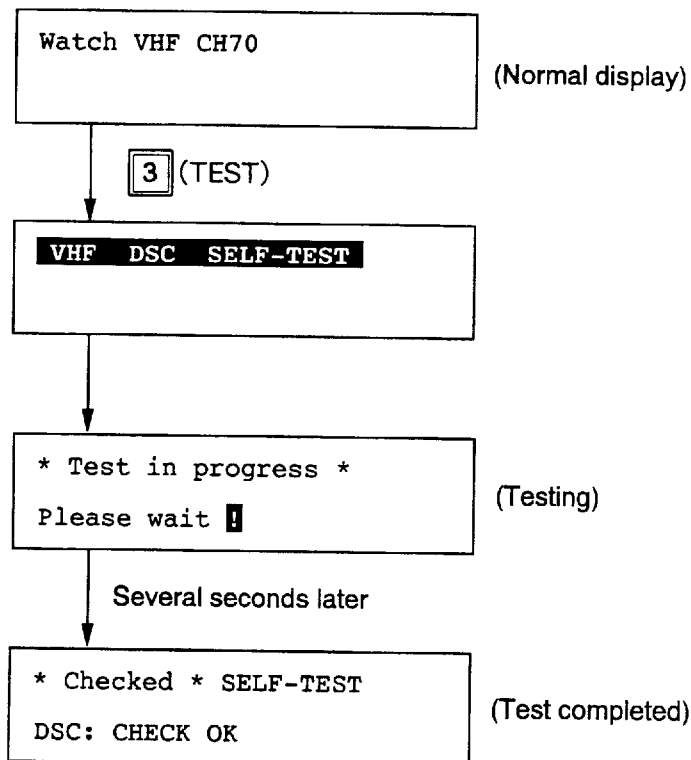

Printing of test result

Printer setting (Refer to page 12-1 of PART 1)	After testing:
"AUTO"	Automatic printing
"MANU"	Press [4] (PRINT) key to print.

(continued on next page)

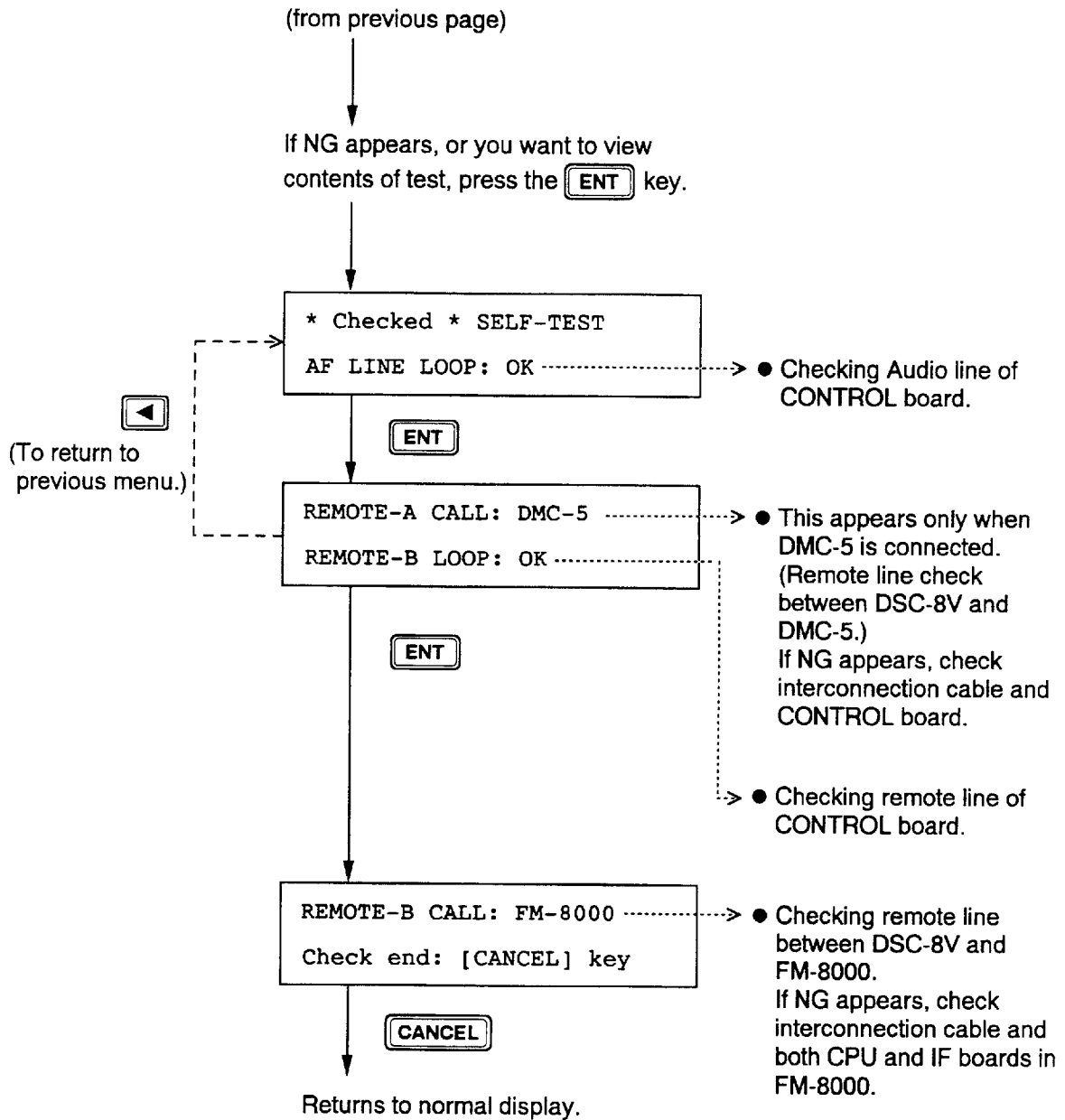

2. Visual Check

General

This unit can perform its intended functions only when properly maintained. Following the procedures shown below will help keep it in top operating condition. **Be sure to turn off the power before performing any maintenance procedures** (except cleaning the display unit).



Cleaning display unit

Accumulated dust can be removed with a soft, dry cloth. Do not use gasoline, thinner, benzine or other solvents to clean the display unit. These may remove paint and markings.

Inspecting connectors and earth terminal

Periodically inspect the connectors and earth terminal on the rear of the unit for tightness.

3. Self-test for Technician

General

This self-test is mainly intended for use by the service technician to identify the cause of operating problems.

Procedure

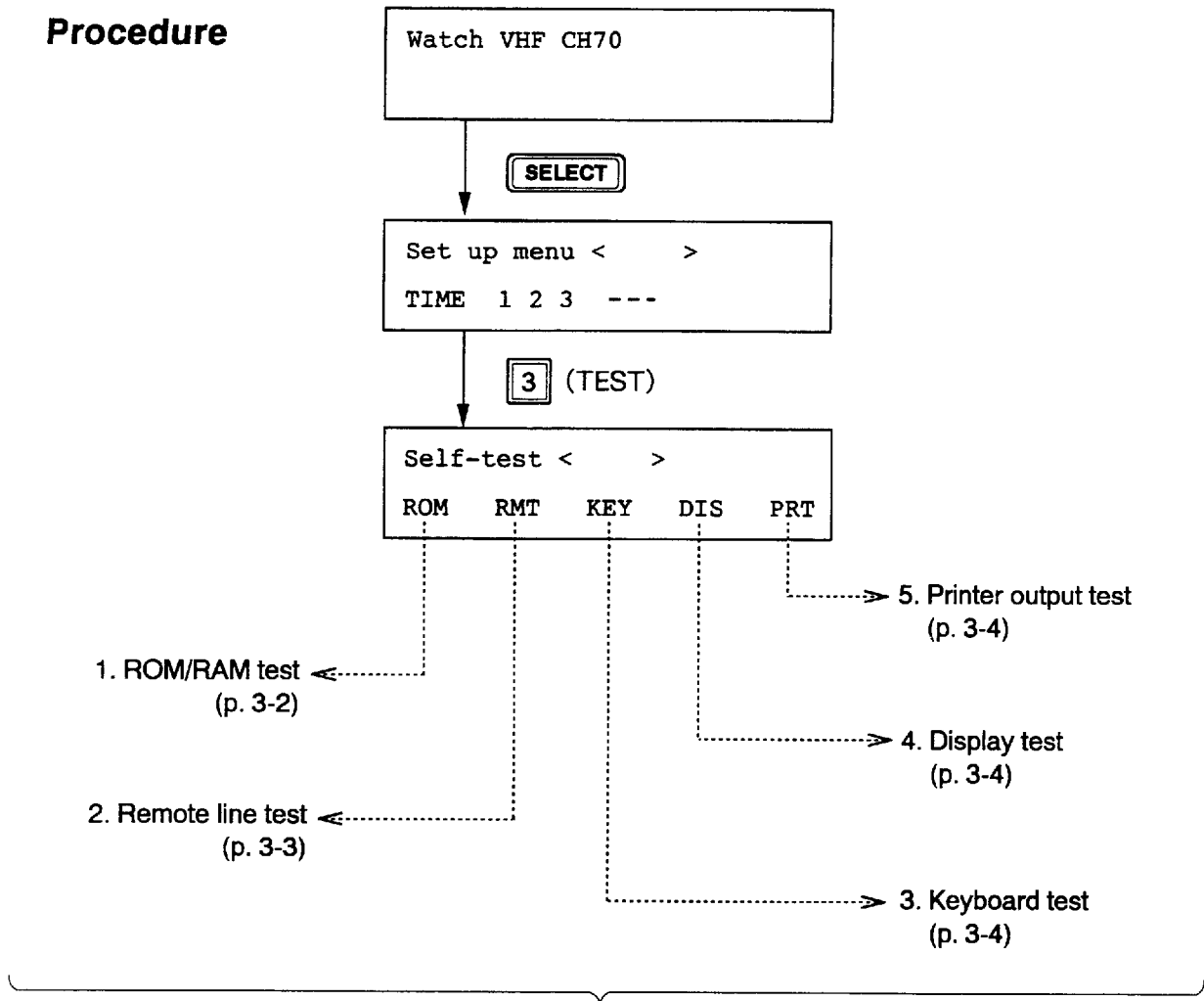

Select test desired, then press the **ENT** key.

ROM/RAM test

This test checks the ROM (U8), RAM (U9 and U10) and EEPROM (U11) on the CONTROL board for proper operation.

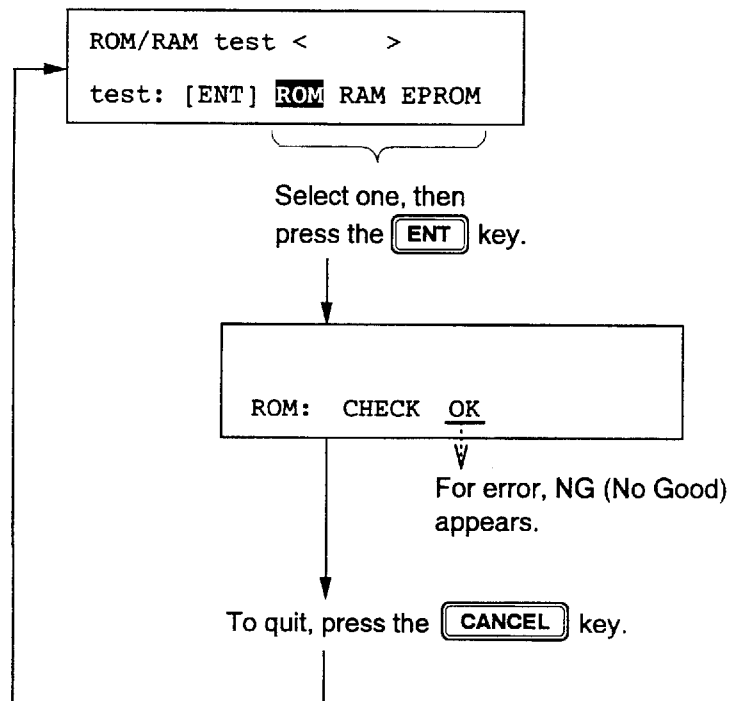

Remote line test

This test checks the remote signal line (MIF data line) for proper operation.

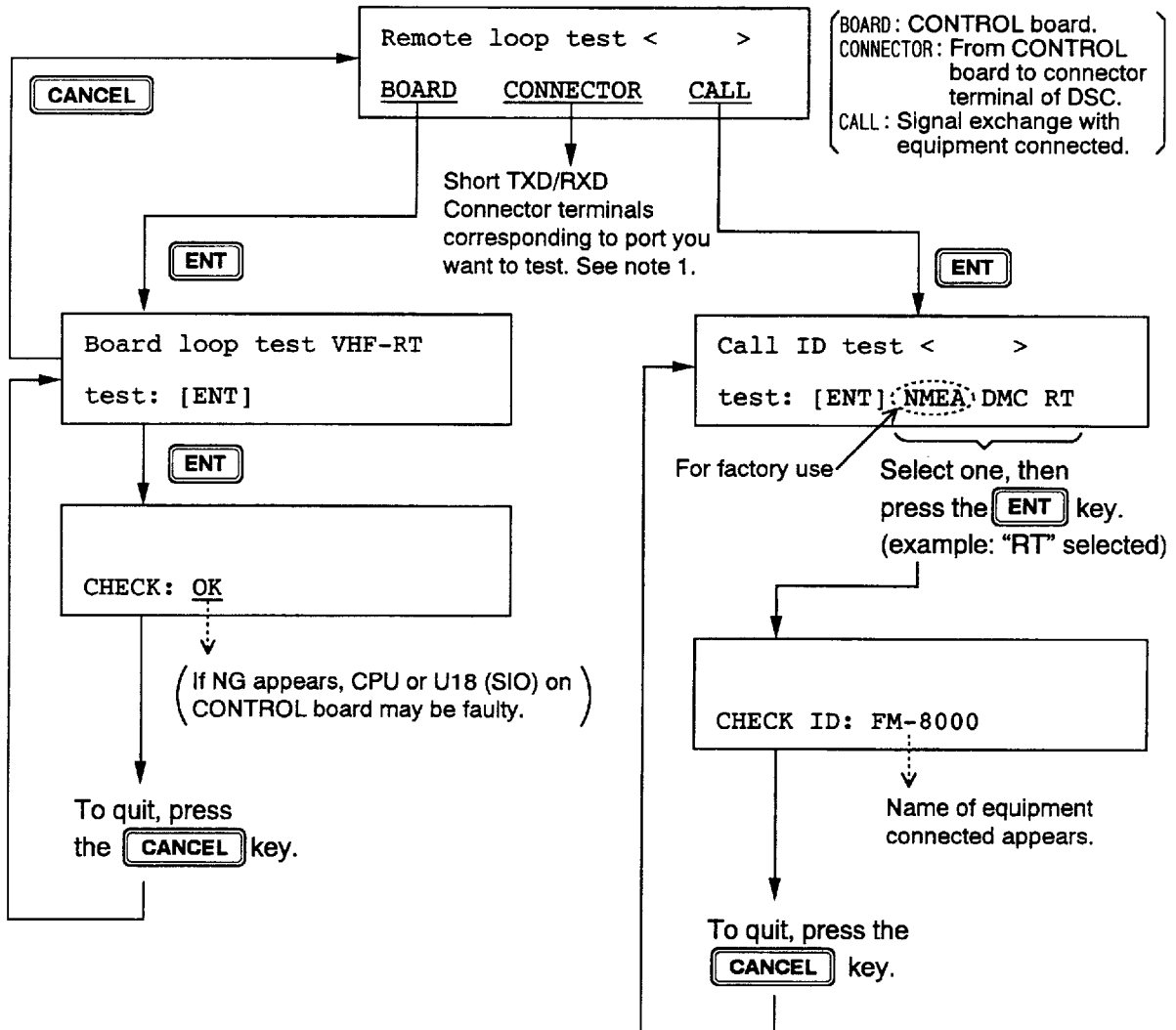

Note 1

Port	Connector terminal (rear panel) to short
NMEA	J1 #1-#3, #2-#4
REMOTE-A	J3 #1-#3, #2-#4
REMOTE-B	J4 #1-#3, #2-#4

Keyboard test

Keyboard test
test: [any key]

Press keys one by one.
The number (or character) corresponding to the key pressed appears if the key is functioning properly.

Display test

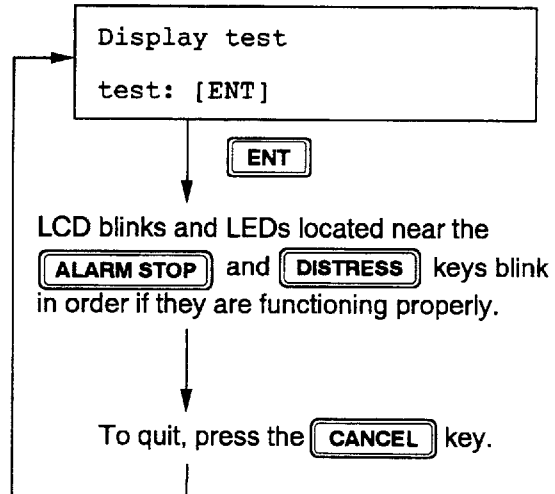

Printer output test

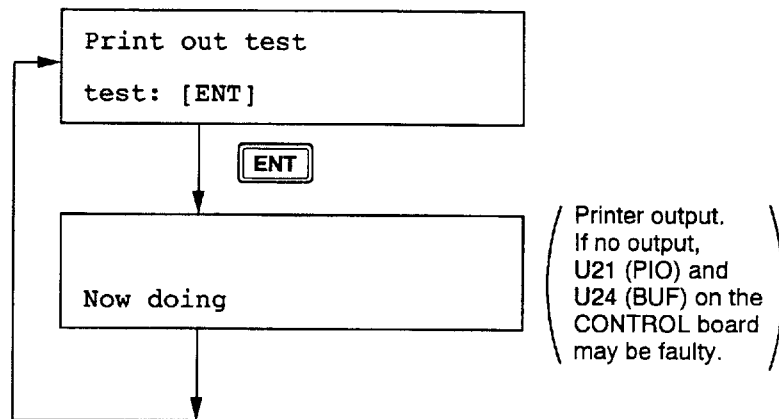

4. About Internal Battery

Items backed up by battery

- ① Prepared transmit messages
[SELECT] → [7] → (Select "MESSAGE".)]
- ② All received message ([8])
- ③ All transmitted messages ([9])
- ④ Internal clock [SELECT] → (Select "TIME".)]

Note

The unit automatically erases all memories shown above if the power is off **for about one month.**

© FURUNO ELECTRIC CO., LTD.

9-52, Ashihara-cho,
Nishinomiya, Japan 662

Telephone: 0798-65-2111
Telefax: 0798-65-4200 (G111)

All rights reserved. Printed in Japan

-Your Local Agent/Dealer

Initial : DEC 1993
F : NOV. 7, 1996

(ETMI)

PUB. No. OME-55850
DSC-8V/8VP



INSTRUCTIONS FOR CANCELLING A FALSE DISTRESS ALERT

VHF DSC

1. Switch off transmitter immediately.
2. Switch equipment on and set to Channel 16.
3. Make broadcast to "All Stations" giving your vessel's name, callsign and DSC number, and cancel the false distress alert.

Example message:

All Stations, All Stations, All Stations
This is NAME, CALLSIGN,
DSC NUMBER, POSITION.

Cancel my distress alert of
DATE, TIME, UTC.
=Master, NAME, CALLSIGN.
DSC NUMBER, DATE, TIME UTC.



SAFETY INSTRUCTIONS

"**DANGER**", "**WARNING**" and "**CAUTION**" notices appear throughout this manual. It is the responsibility of the operator of the equipment to read, understand and follow these notices. If you have any questions regarding these safety instructions, please contact a FURUNO agent or dealer.



DANGER

This notice indicates a potentially hazardous situation which, if not avoided, will result in death or serious injury.



WARNING

This notice indicates a potentially hazardous situation which, if not avoided, could result in death or serious injury.



CAUTION

This notice indicates a potentially hazardous situation which, if not avoided, could result in minor or moderate injury, or property damage.

⚠ WARNING	
	<p>Do not open the cover of the equipment.</p> <p>This equipment uses high voltage electricity which can shock, burn, or cause death. Only qualified personnel should work inside the equipment.</p>
<p>Do not disassemble or modify the equipment.</p> <p>Fire, electrical shock or serious injury can result.</p>	
<p>Immediately turn off the power at the ship's mains switchboard if water or foreign object falls into the equipment or the equipment is emitting smoke or fire.</p> <p>Continued use of the equipment can cause fire, electrical shock or serious injury.</p>	

⚠ CAUTION
<p>Do not place liquid-filled containers on the top of the equipment.</p> <p>Fire or electrical shock can result if a liquid spills into the equipment.</p>
<p>Do not place heater near the equipment.</p> <p>Heat can melt the power cord, which can result in fire or electrical shock.</p>
<p>Do not operate the unit with wet hands.</p> <p>Electrical shock can result.</p>
<p>Use the correct fuse.</p> <p>Use of the wrong fuse can cause fire or equipment damage.</p>

WARNING Label attached

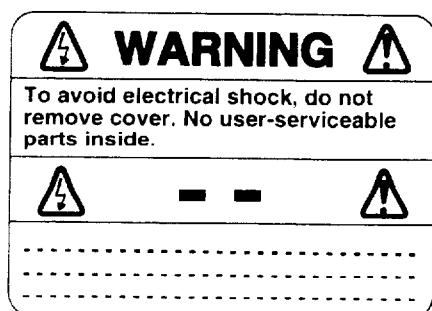

Name : Warning Label (1)
 Type : 86-003-1011-0
 Code No. : 100-236-230

Introduction

About this manual

This manual consists of two parts: PART 1, Operation, and PART 2, Maintenance.

PART 1

PART 1 provides operating information. For sake of easy understanding, instruction is arranged by type of operation.

Once you become acquainted with the basic rules of operation, the function and logical layout of the DSC-8V's man-to-machine dialogue will become more apparent. Therefore, please read "Overview" and "1. Basic Operation" to acquaint yourself with the basics of this unit.

PART 2

This part contains the information necessary for conducting checks of the equipment. If you think something is wrong with the unit, refer to this part.

Reference

The DSC-8VP is developed to operate with the previous VHF radiotelephone model FM-7000. Operation of DSC-8VP is just identical to DSC-8V except procedure of power on/off. Therefore please read the DSC-8V as DSC-8VP and FM-8000 as FM-7000 when operating the DSC-8VP/FM-7000.

Difference between DSC-8V and DSC-8VP

	DSC-8V	DSC-8VP
VHF radio to be connected	FM-8000	FM-7000
Power Supply Circuit	Not provided	Provided
Power required	15VDC from FM-8000	10.8 to 40VDC
POWER Switch	Not provided	Provided
To turn on the power	Turn on FM-8000	Press and hold down the POWER key on the DSC-8VP for about two seconds
To turn off the power	Turn off FM-8000	Press and hold down the POWER key on the DSC-8VP for about two seconds

The DSC-8V System

The DSC-8V is connected to the FM-8000 radiotelephone.

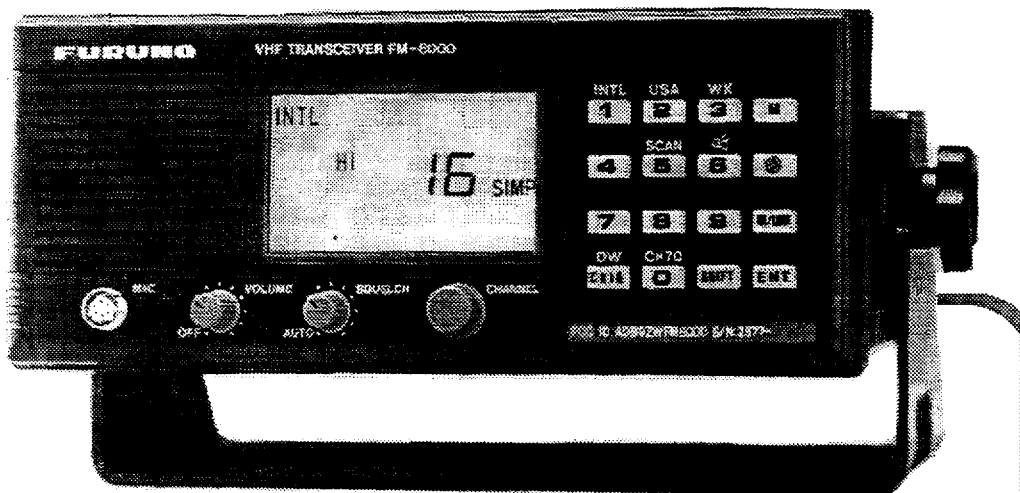

VHF Radiotelephone FM-8000

Interconnection
Cable

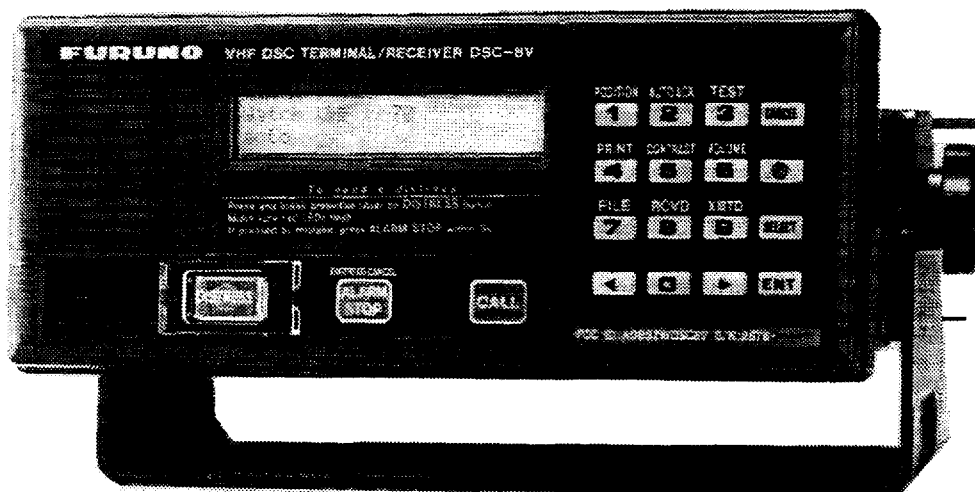

Printer
(option)

PP-500
or
PP-510

(For operation, refer to
the Operator's Manual
of the printer.)

DSC Terminal DSC-8V

PART 1

Operation

PART 1 Table of Contents

(Operation)

	<u>Page</u>
Overview	1
General	1
DSC Message	2
Example of Distress Call	2
Example of Individual Call	3
Remote Function and Automatic Acknowledge	3
Other Calling Categories	5
1. Basic Operation	1-1
1.1 About the Display	1-1
1.2 Preparing and Transmitting Message	1-2
1.3 Status of FM-8000 during DSC Call	1-3
2. Control Description	2-1
2.1 Switches	2-1
2.2 Keys	2-2
3. Distress Alert Transmission	3-1
3.1 Operation Flow from “Distress Transmission” to “Voice Communication”	3-1
3.2 Transmitting Distress Alert	3-1
3.3 Receiving Distress Acknowledge Signal	3-3
3.4 Communicating with Coast Station	3-3
4. Manual Entry of Ship’s Position and Time	4-1
5. Receiving Distress Alert from Other Ship	5-1
6. Distress Relay	6-1
7. Remote and Auto Acknowledge Functions	7-1
7.1 Remote Function	7-1
7.2 Auto Acknowledge (AUTO ACK) Function	7-2

8. All Ships Call	8-1
8.1 Transmitting "All Ships Call"	8-1
8.2 Receiving "All Ships Call"	8-4
9. Individual Call	9-1
9.1 Transmitting "Individual Call" (ACK RQ)	9-1
9.2 Receiving Acknowledge Back (ACK BQ) Signal	9-4
9.3 Receiving "Individual Call" (ACK RQ)	9-5
10. Preparing and Saving Transmit Messages	10-1
10.1 Preparing and Saving Transmit Messages	10-1
10.2 Writing Over a File	10-3
10.3 Retrieving and Transmitting a File	10-4
11. Transmit/Receive Message Memory	11-1
11.1 Transmit Message Memory	11-1
11.2 Receive Message Memory	11-3
12. Printer Setup (Auto/Manual)	12-1
13. Other Calling Types and Other Functions	13-1
13.1 Other Calling Types	13-1
13.2 Telephone Call	13-4
13.3 Receiving Telephone Call from Coast Station	13-7
13.4 Other Station IDs and Telephone Nos.	13-8
14. Menu List	14-1

Overview

General

What is the DSC-8V?

The DSC-8V is a Digital Selective Calling Terminal provides distress/safety, and individual calling for coast station or marine vessels.

The DSC-8V is connected to the FM-8000 Radiotelephone, which supplies powers to the DSC-8V. The DSC-8V can control the channel setting of the FM-8000 by using the "remote control" function. For further details of the remote function, refer to page 3.

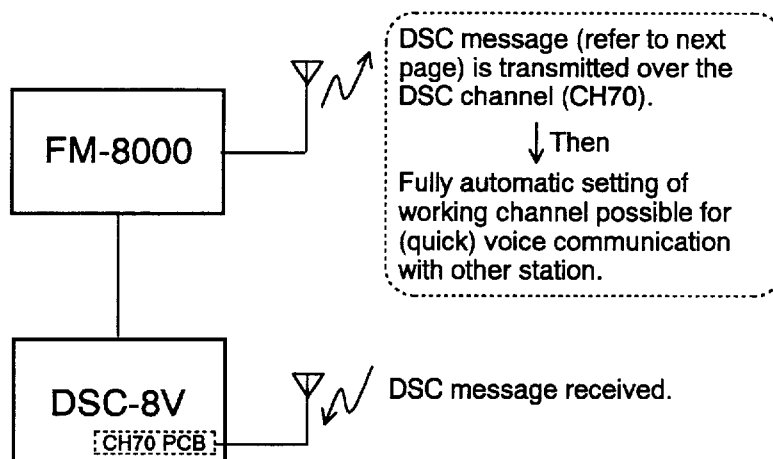

Receiving a message

The DSC-8V incorporates the CH70 Board for continuous watch on CH70. When receiving the distress alert or message addressed to own ship, the aural alarm sounds.

About the aural alarm

When receiving the distress or urgent call, the alarm sounds until the **ALARM STOP** key is pressed. For all other calls, the alarm sounds for five seconds when they are received.

The aural alarm tone depends on message received: The operator can know what type of message is received by listening to the alarm tone. More on this later.

Other functions

Transmitted and received messages can be saved to the memory and printed out (optional printer required) if necessary.

DSC Message

Contents

- ① Format specifier (calling category) such as distress, individual
- ② Address (own ship ID and other ship ID)
- ③ Working channel (channel data for voice communication with other station after transmission of DSC message)
- ④ Ship's co-ordinates

Example of Distress Call (Refer to page 3-1.)

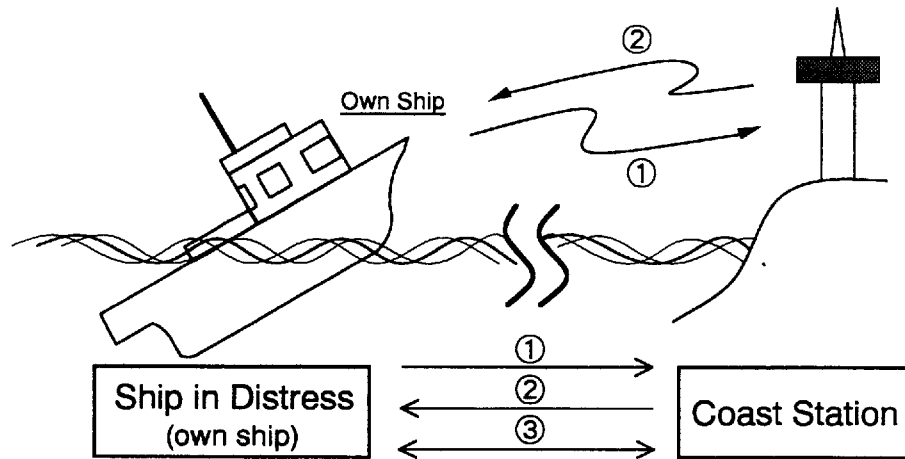

Procedure

- ① Peel off the red seal, and then, press the **DISTRESS** key to transmit the distress alert. (If you are not pressed for time, enter the nature of distress with numeric keys. Refer to table shown below.) After five seconds, the alert is transmitted over CH70.
- ② Wait until the distress acknowledge (DIST ACK) signal from coast station is received. (See NOTE.) The aural alarm sounds when DIST ACK is received. Press the **ALARM STOP** key to silence the alarm.
- ③ After receiving the DIST ACK signal, communicate with coast station over working channel (automatic setting: CH16) designated by own ship.

NOTE: If the distress call is not acknowledged within 3.5 – 4.5 minutes it is automatically retransmitted.

Nature of Distress
[1]: Fire, explosion
[2]: Flooding
[3]: Collision
[4]: Grounding
[5]: Listing, capsizing
[6]: Sinking
[7]: Disabled & adrift
[8]: Abandoning
[0]: Undesignated

Example of Individual Call (Refer to page 9-1.)

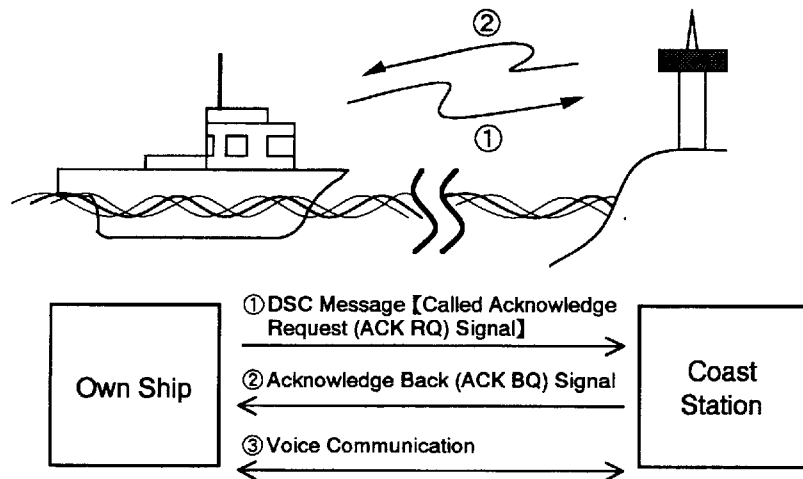

Procedure

- ① Prepare message then transmit it to coast station (or other ship) by pressing the **CALL** key. (The channel of FM-8000 is automatically changed to CH70 and the message is transmitted over CH70.)
- ② Wait until the acknowledge back (ACK BQ) signal from coast station is received within five minutes.
- ③ After receiving the ACK BQ signal, communicate with the coast station over working channel designated by own ship or the coast station.

Remote Function and Automatic Acknowledge (AUTO ACK)

General

The DSC-8V and FURUNO radiotelephone communicate with each other by means of the MIF (FURUNO Radio Interface) data format, which is a unique handshaking type signal exchange system developed by FURUNO.

AUTO ACK

The auto acknowledge feature automatically transmits the acknowledge back (ACK BQ) signal when an individual call is received. With the auto acknowledge feature turned on the remote control function is also turned on.

Remote control function

The remote control function lets the DSC-8V set DSC channel (CH70), working channel and communication mode for the radiotelephone.

Turning remote (& AUTO ACK) on/off

To enable or disable AUTO ACK and remote control, use the key. Each press of the key enables/disables auto acknowledge and remote control function in the sequence shown below.

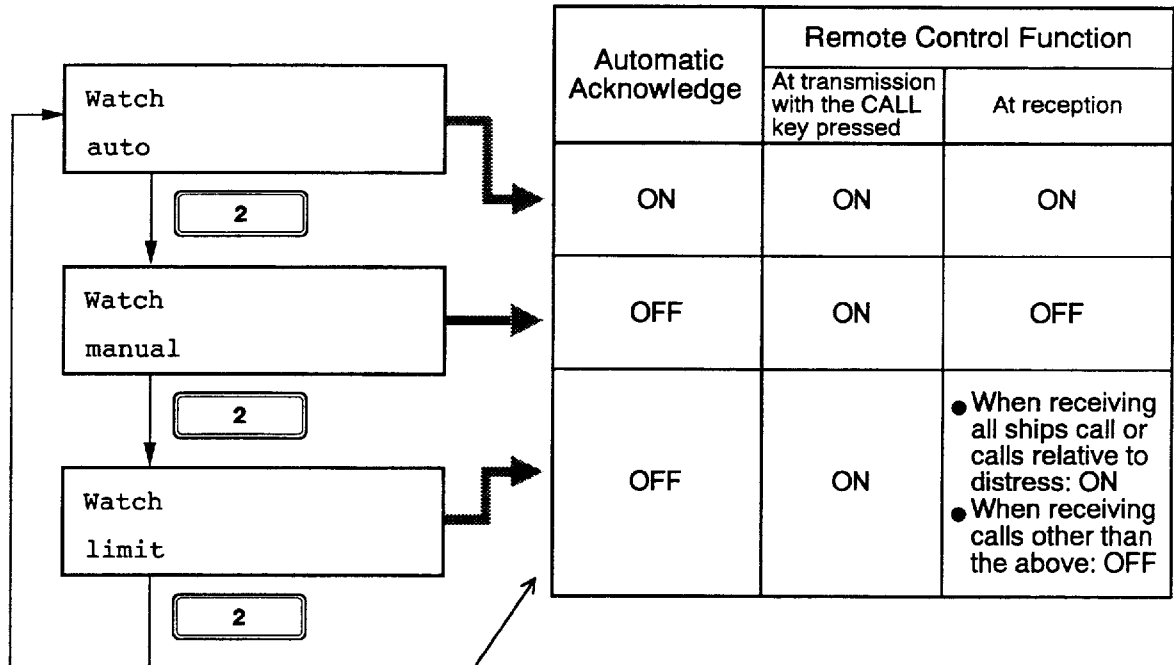

LIMIT FUNCTION

The limit setting provides restricted use of the remote control function. It is useful when the followings are desired.

1. Automatically set working channel when receiving an all ship's call, so as **not to miss initial voice** from the transmitting station.
2. Prevent automatic transmission of the acknowledge back (ACK BQ) signal, in response to an individual call, **when no operator is present**.
3. Prevent automatic transmission of **own ship's position data**, in response to an individual call which requests such data.

Example of AUTO ACK

Individual call transmitted by own ship's DSC-8V ①

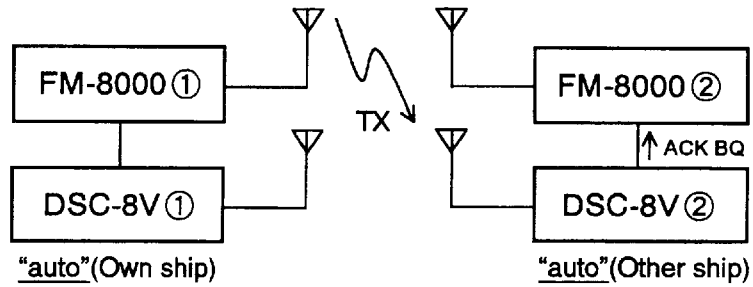

Operation at DSC-8V	Channel of FM-8000 ① (automatic setting)	Channel of FM-8000 ② (automatic setting)
1. Press CALL key of DSC-8V ①.	Changed to CH70. (Message is transmitted.)	
2. DSC-8V ② receives message. (Alarm sounds.)		
3. DSC-8V ② sends ACK BQ automatically.		Changed to CH70. (ACK BQ is transmitted.) After that, channel is set to working channel designated by DSC-8V ①.
4. DSC-8V ① receives ACK BQ. (Alarm sounds.)	Changed to working channel designated by DSC-8V ①.	

Then, voice communication begins between stations over working channel designated by the DSC-8V ①.

Other Calling Categories (Types)

General

The DSC-8V provides the following types of calls, as well as distress and individual calls previously mentioned.

- Distress Relay (Refer to page 6-1.)
- All Ships (Refer to page 8-1.)
- Group (For specific group ships)
- Geographic Area (For ships within specific range)
- Telephone (Refer to page 13-4.)

Further, the "Polling" and "Position Request" functions are also available. Refer to page 13-1.

1. Basic Operation

1.1 About the Display

Normal display

When the FM-8000 is turned on, the following display appears on the DSC-8V. (There is no power switch on the DSC-8V.) This display is known as the “normal display.”

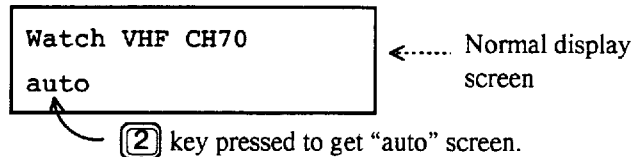

Should you get lost in operation you can return to the normal display by pressing the **CANCEL** key several times.

Selecting and registering items

The arrow keys (**◀** and **▶**) function to select items on the LCD. After selecting item, press the **ENT** key to register it.

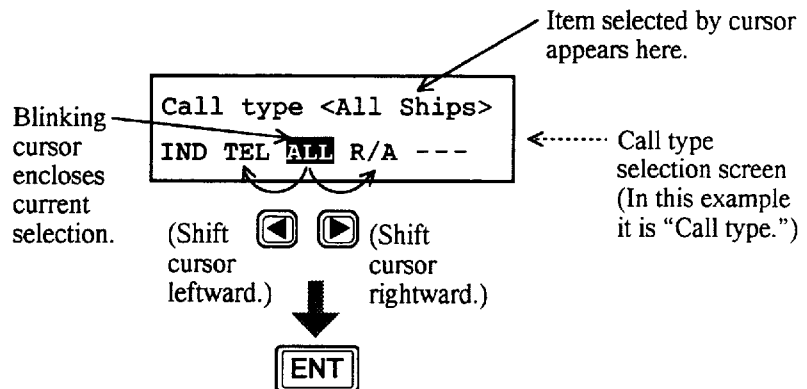

When blinking question mark appears

Press the **ENT** or **SELECT** key depending on your desire.

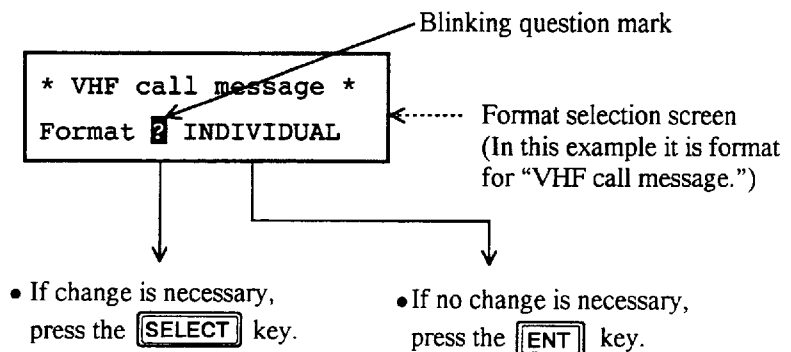

1.2 Preparing and Transmitting Messages

Methods

There are two methods by which you can prepare and transmit messages, and they are shown below.

Preparing message for immediate transmission

Prepare message and then transmit it.

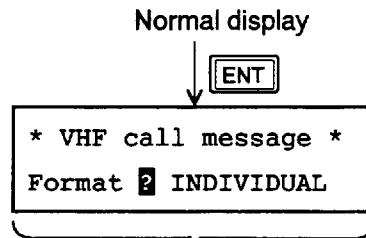

For how to prepare a message, refer to page 9-1.

After preparation, press the **CALL** key to transmit the message.

Preparing and storing message for later transmission

Prepare messages excluding distress message and save them to the memory. (Maximum 99 files) You may retrieve and transmit a memory-stored message as follows.

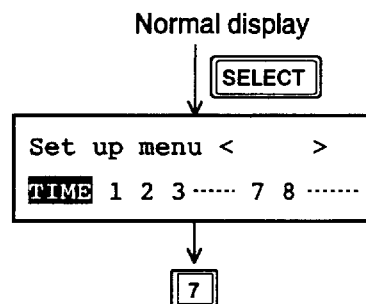

For how to prepare and store a message, refer to page 10-1.

After the normal display appears, press keys in the order shown below to transmit a message.

7 (FILE) → (Enter file number.) → **CALL**

1.3 Status of FM-8000 during DSC Call

Output power of FM-8000 at transmission of distress alert

When the distress alert is transmitted (by pressing the **DISTRESS** key), the output power of the FM-8000 is automatically set to maximum (25W).

Key entry of VHF

The FM-8000's keyboard accepts no key input while DSC message is transmitted. (Distress call: inoperative about 3 seconds, other calls: inoperative about 0.5 seconds.) To unlock it manually, if necessary, press the **CANCEL** key.

2. Control Description

2.1 Switches

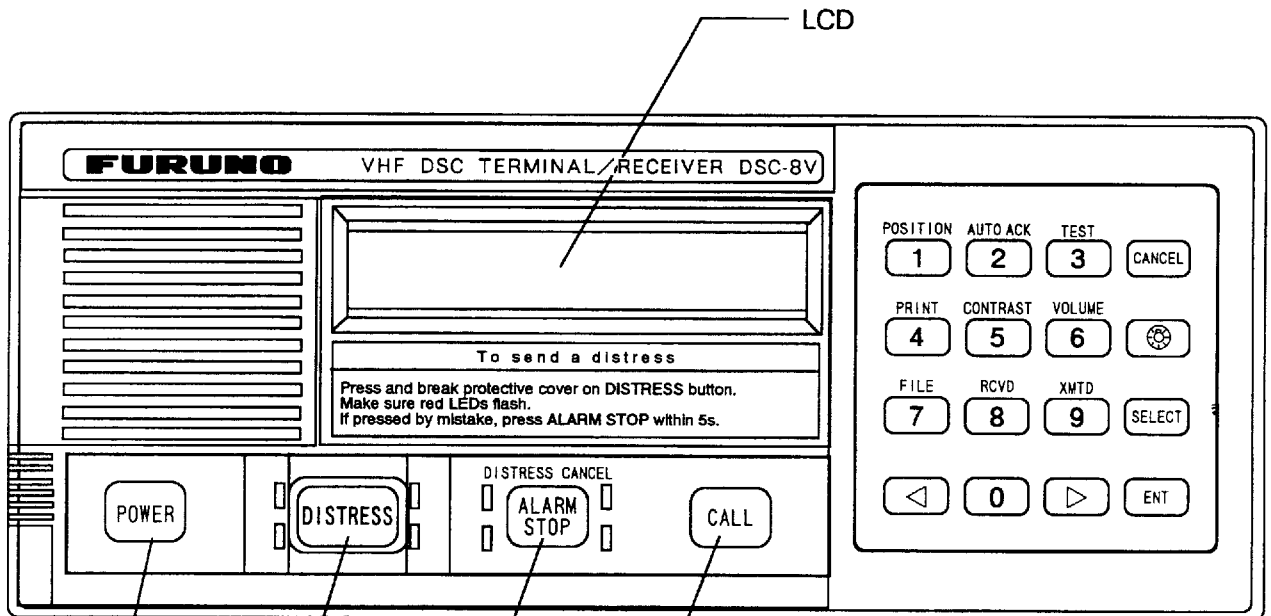

CALL : Transmits messages other than distress.

(DISTRESS CANCEL)

ALARM STOP : Silences the receive alarm.
If the **DISTRESS** key is accidentally pressed, press this key within five seconds to cancel the distress call.

DISTRESS : Transmits the distress alert.
(Press and break the protective cover on this key.)

POWER (DSC-8VP only) : Turns power on and off. To turn the power off, press and hold down the switch at least two seconds. Then, release the key after a loud beep is heard.

About LED



















The four LEDs (Red) blink when the **DISTRESS** key is pressed, and extinguish when the distress alert is completely transmitted.



- Upper two LEDs (Red) blink when distress or urgent message is received.
- Lower two LEDs (Green) blink when messages other than distress/urgent are received.

2.2 Keys

Key	Function/Purpose
 - 	Enter numeric data.
	Cancels wrong data and restores previous menu.
	Adjusts illumination of LCD, switches and keys in four levels.
	1. Displays "Set up menu" (Main menu). 2. Changes settings of items appearing with blinking question mark. (Refer to pages 9-6, 10-1, 12-1 for "Set up menu".)
	Registers key input. (Blinking item is registered when key is pressed.)
	1. Shifts the cursor leftward. 2. Restores previous display when pressed at displays with a blinking question mark.
	Shifts the cursor rightward.
POSITION 	Ship's position and time are shown while pressed and held down.
AUTO ACK 	Turns transceiver remote and automatic transmission of acknowledge call (AUTO ACK) on or off. (Refer to page 3.) Note that distress alert cannot be automatically acknowledge by "auto acknowledge".
TEST 	Conducts self-test. (Refer to PART 2.)
PRINT 	Printing. (This is also available for automatic setting of the printer.)
CONTRAST 	Adjusts contrast of LCD in eight levels.
VOLUME 	Adjusts volume of speaker in eight levels. (Distress and urgency alarms always sound at maximum volume.)
FILE 	Retrieves files.
RCVD 	Displays contents of received messages (Storage capacity: 100 files, 50 each of distress and other). (Refer to page 11-3.)
XMTD 	Displays contents of transmitted messages (Storage capacity: 50 files). (Refer to page 11-1.)

3. Distress Alert Transmission

3.1 Operation Flow from “Distress Transmission” to “Voice Communication”

General

In the GMDSS, the distress alert must be transmitted by the DSC Terminal. Then, distress voice communications with a coast station is started through the radiotelephone.

The figure which follows shows the operation flow from distress transmission to voice communications.

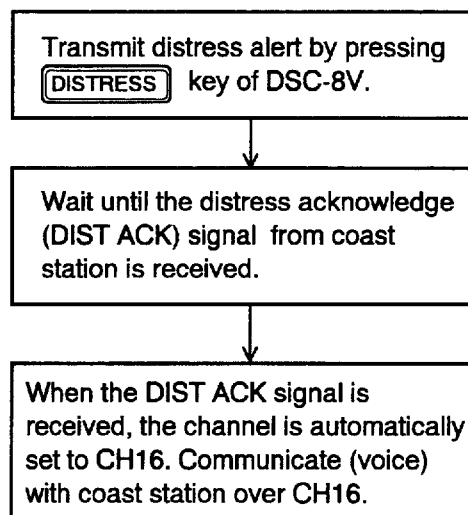

3.2 Transmitting Distress Alert

Procedure

Follow the procedure shown on the next page to transmit the distress alert. When the **DISTRESS** key is pressed, the four LEDs (Red) near this key blink.

If you accidentally press the **DISTRESS** key, press the **ALARM STOP** (DISTRESS CANCEL) key within five seconds to cancel the distress alert.

Transmitting the distress call

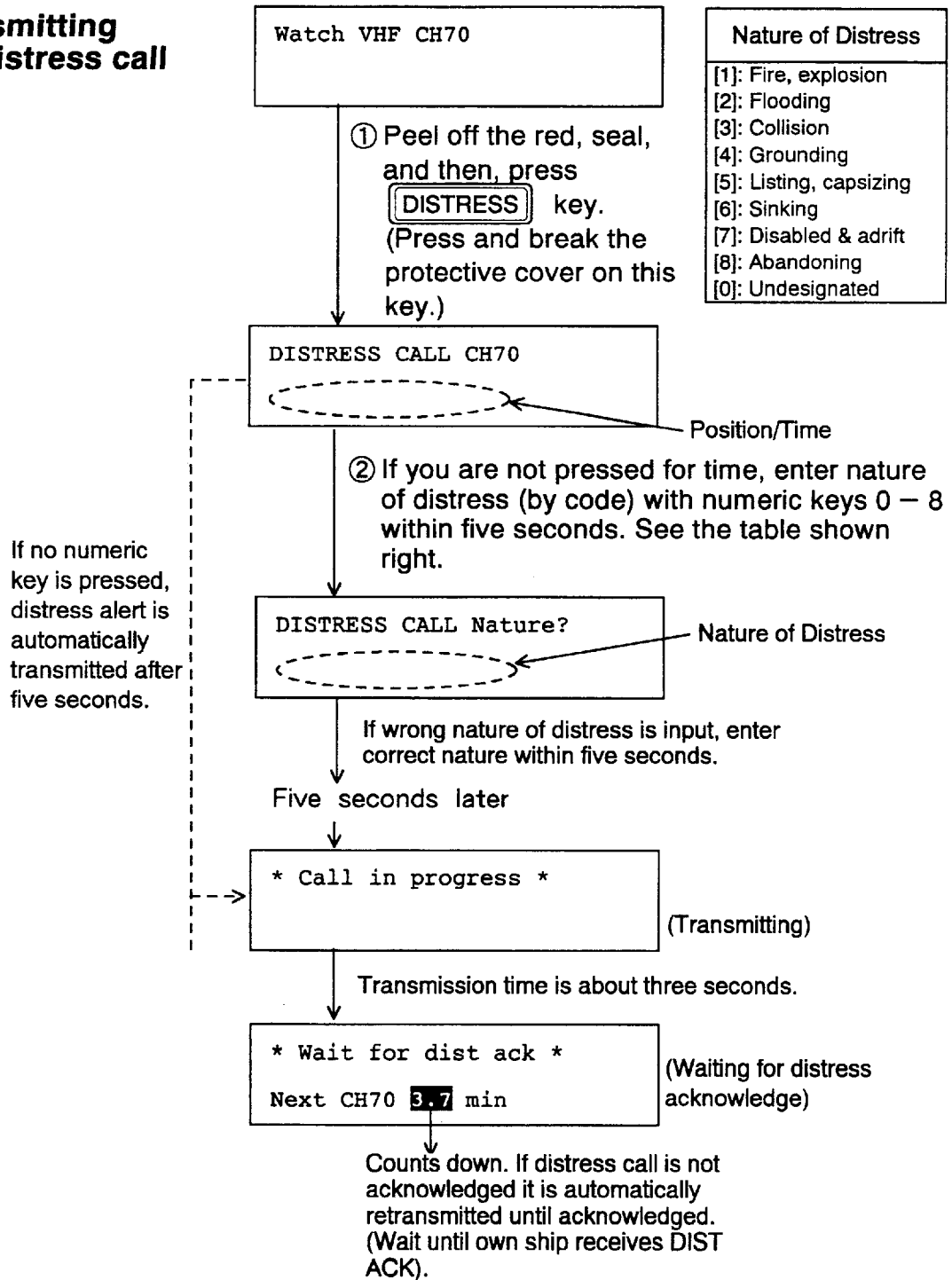

When position data is not automatically input

The ship's position data from a navigational device is usually automatically input to the DSC-8V. When the navigation device fails or automatic input is off, however, enter position manually. The procedure for manual entry of position appears on page 4-1.

When your vessel is in distress and there is no automatic input of position, enter it manually (if you are not pressed for time) then press the **DISTRESS** key.

3.3 Receiving Distress Acknowledge Signal

Procedure

After transmitting the distress alert the “Wait for dist ack” display appears. Then, you should wait to receive the distress acknowledge (hereafter referred to as “DIST ACK”) signal from a coast station. The procedure for receiving DIST ACK is as shown below.

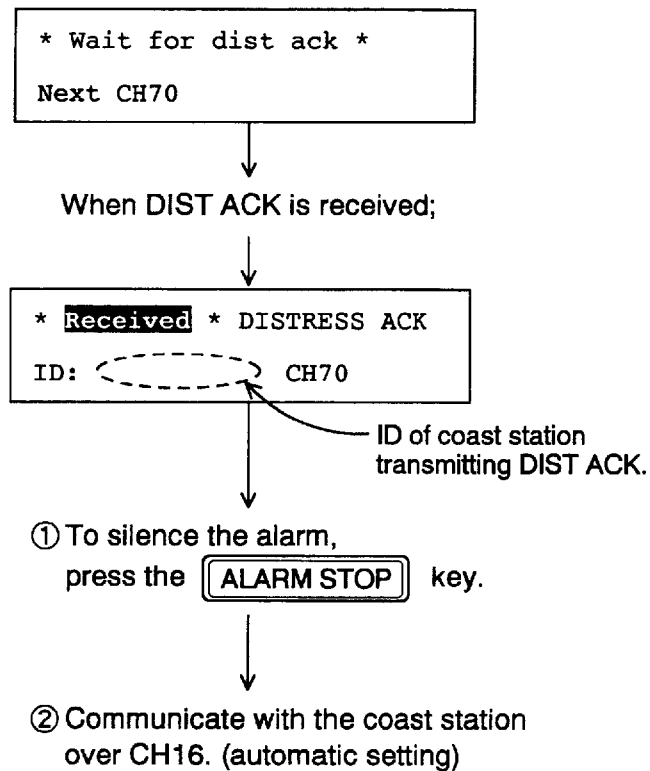

3.4 Communicating with Coast Station

Overview

Since the FM-8000 is automatically set to CH16, you are now ready to begin voice communications with the coast station.

4. Manual Entry of Ship's Position and Time

Entering data manually

If there is no automatic input of position and time data by a navigational device, enter them as follows.

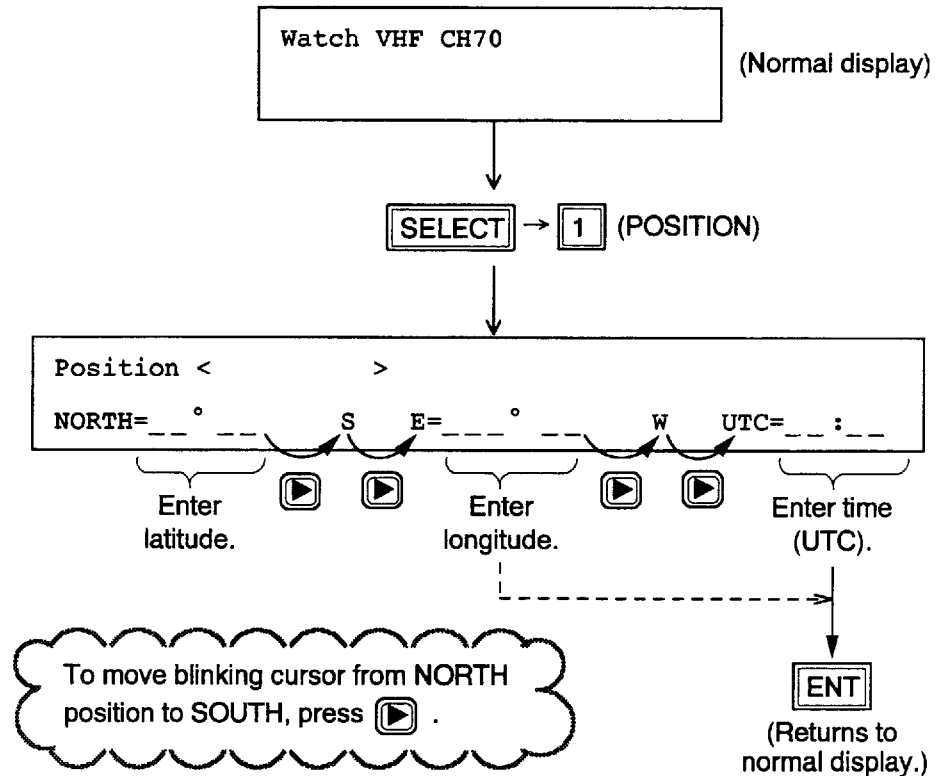

Manually entered data remains for 12 hours

Once the ship's position and time data are entered manually, automatic input of them is not possible for 12 hours after they are manually entered, even if automatic input becomes available. (Note that manually entered data are automatically erased 12 hours after entry.)

Cancelling manually entered data

To cancel the manually entered data, enter 9999 for the time.

UTC = 9999



ENT

5. Receiving Distress Alert from Other Ship

General

When the DSC-8V receives a distress alert from other vessel the two LEDs (Red) near the **ALARM STOP** key blink and the DSC-8V sounds the distress alarm. Silence the alarm by pressing the **ALARM STOP** key. Wait up to three minutes until the DIST ACK signal from a coast station is received. Be prepared to follow the instructions of the coast station. If you do not receive the DIST ACK signal, follow the flow chart shown on the next page.

The DIST ACK signal can be transmitted by you **under certain conditions**. Please carefully read and follow the flow chart to determine whether you should transmit it or not. If you do transmit it, you must **relay the distress alert to a coast station and begin search and rescue operations for the vessel in distress**.

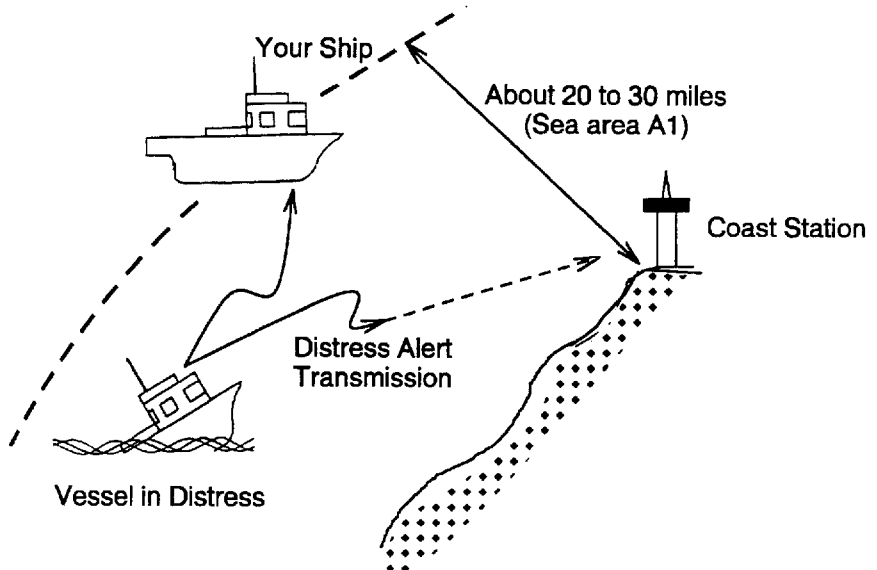

**Flow chart
(Should I transmit
DIST ACK signal
or not?)**

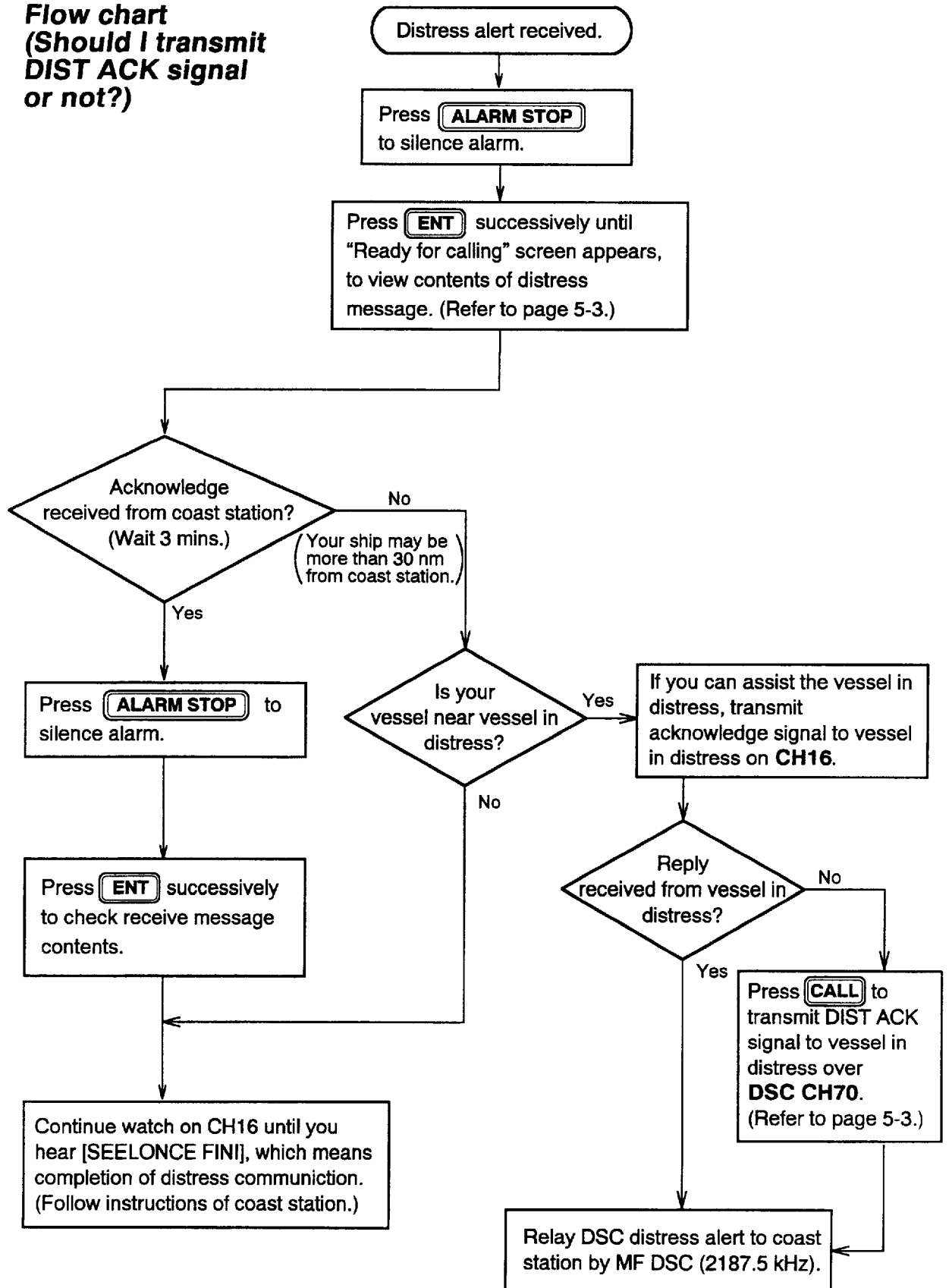

Transmitting DIST ACK

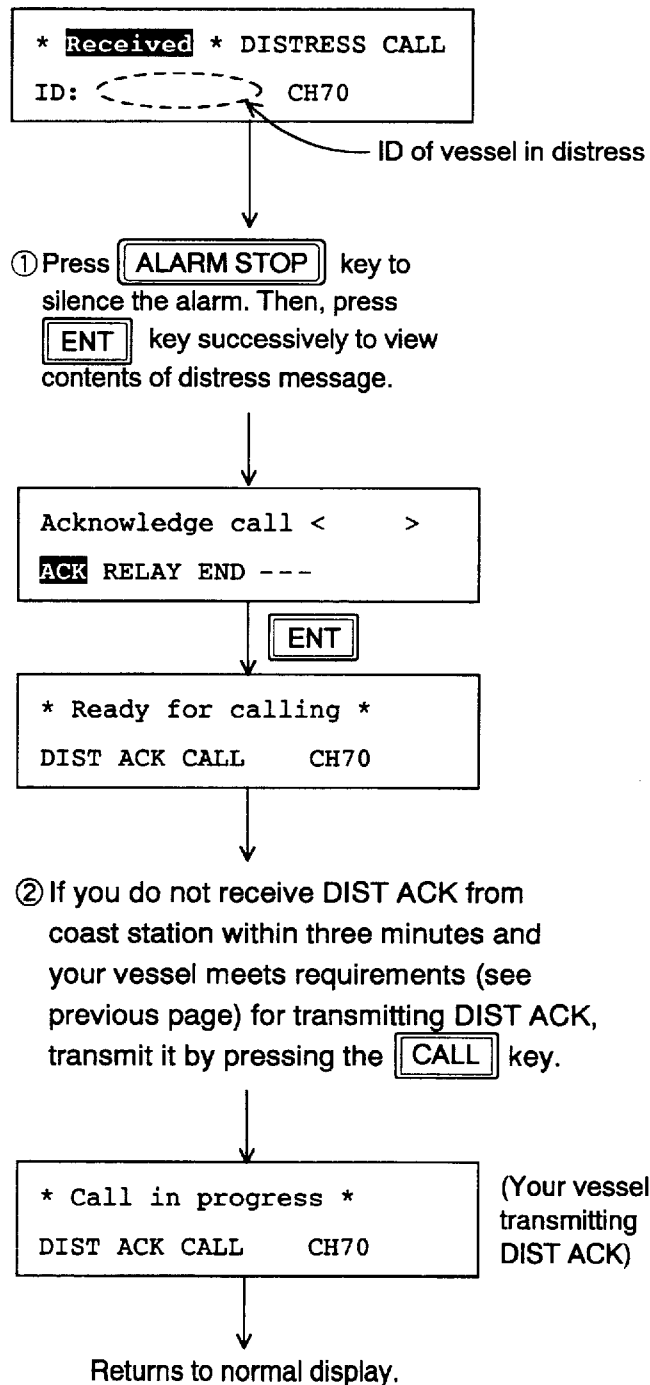

After transmitting DIST ACK

Begin search and rescue operations for the vessel in distress, communicating with the vessel over CH16 (automatically set) on the FM-8000. Relay distress alert to coast station by MF DSC. Finally, follow instructions of the coast station.

6. Distress Relay

General

If a vessel in distress is obviously near own ship and is not able to transmit the distress alert by itself, you can relay (transmit) the alert on behalf of the vessel in distress.

Procedure

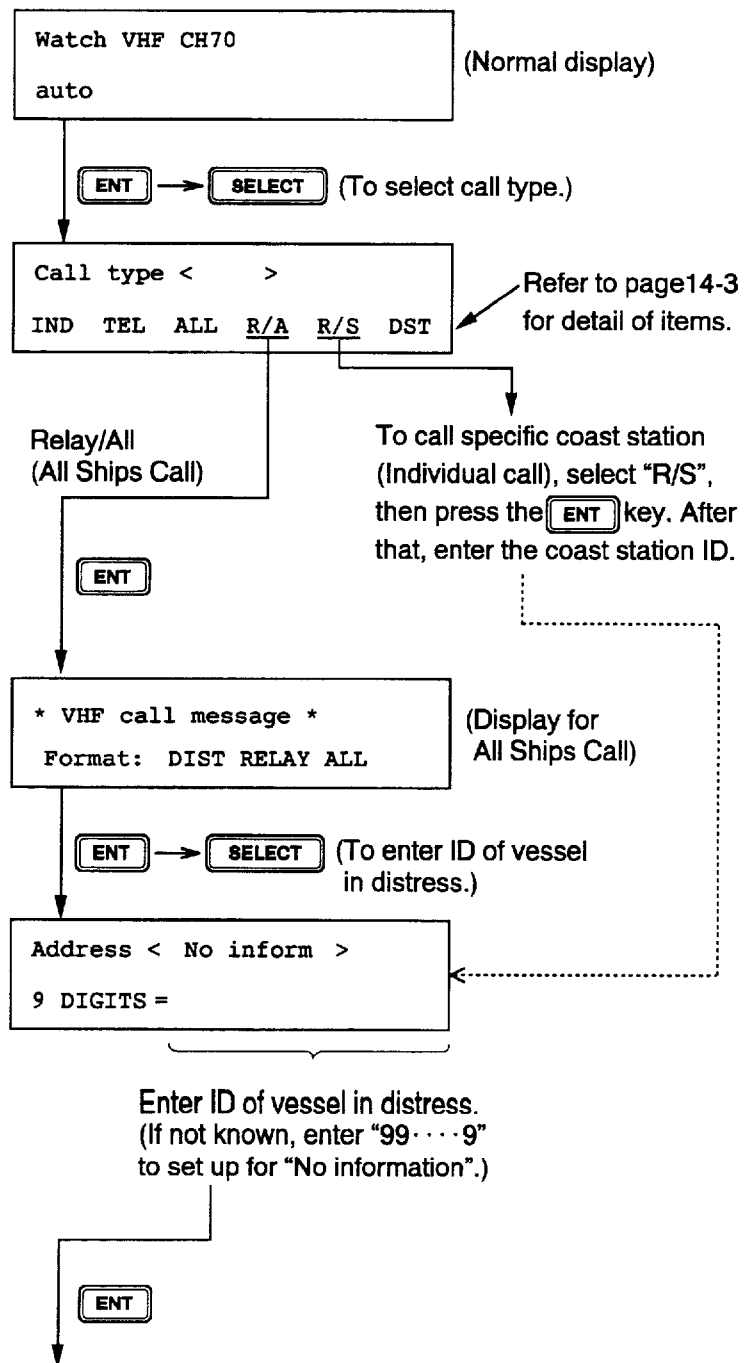

(continued on next page)

(from previous page)

Nature of distress ?
UNDESIGNATED

To designate nature of distress, press **SELECT**.

If unknown

ENT

SELECT

(To enter position of vessel in distress.)

Position < >
NORTH =

Manually enter position of vessel in distress.
(Refer to page 4-1.)

ENT

SELECT

(To enter time.)

Distress UTC :
UTC ?

Manually enter time.
("9999" means no information.)

ENT

(Twice)

Ready for calling
DIST RELAY ALL CH70

CALL

(continued on next page)

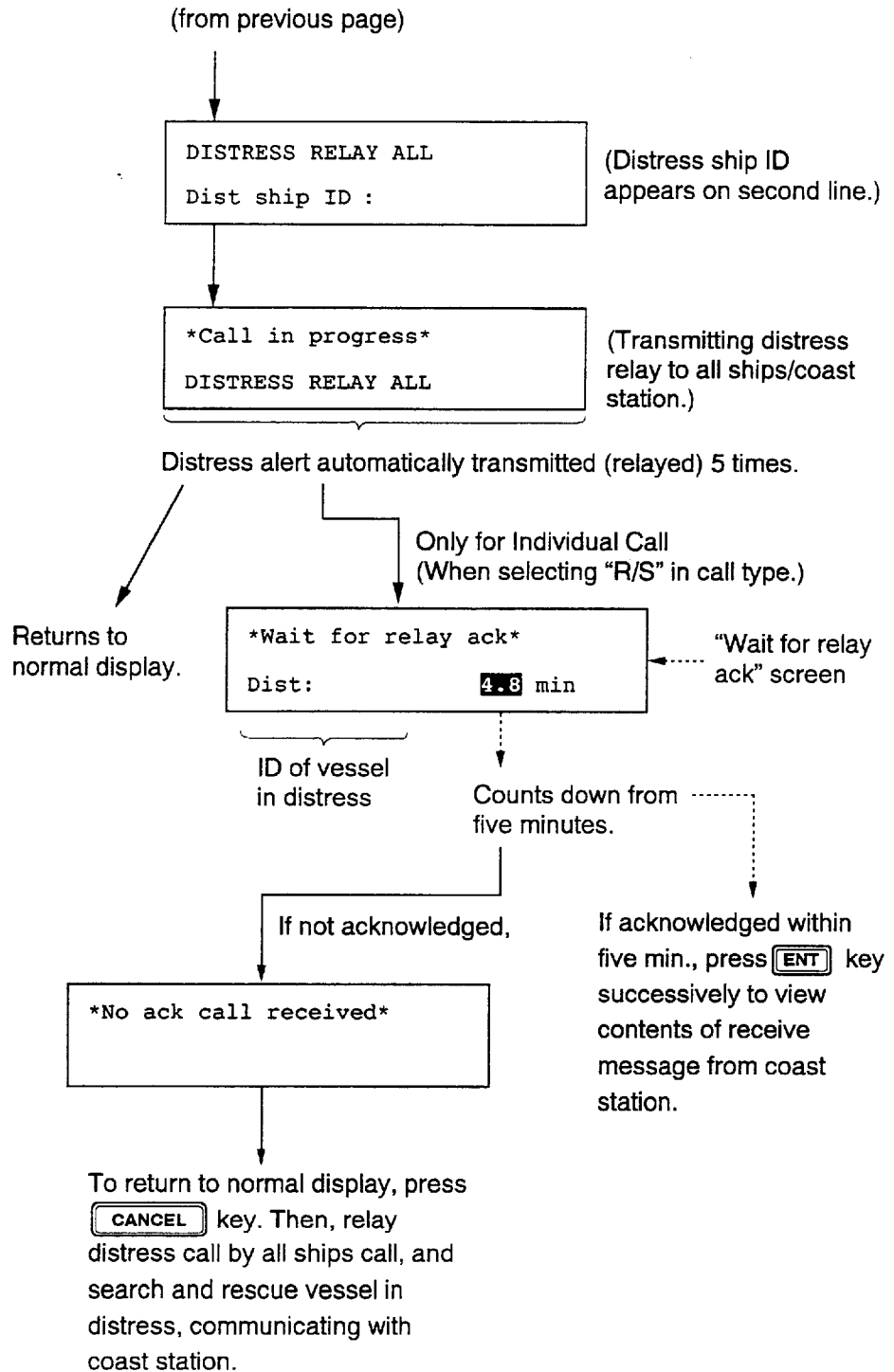

After relaying the alert, you must conduct search and rescue for the vessel in distress, following instructions of a coast station on CH16.

7. Remote and Auto Acknowledge Functions

7.1 Remote Function

What is the remote function?

Remote function means “the DSC controls the VHF”. For instance, the DSC sends channel data such as DSC channel (CH70) and working channel, and communication mode to the VHF, resulting in automatic settings of channels and communication mode of VHF.

Turning the remote function on/off

To turn the remote function on/off, press the **2** (AUTO ACK) key. Each press of the key turns on/off the remote function, as well as the auto acknowledge (AUTO ACK) function (see next page), in the sequence shown below. Note that the remote function is always on at DSC Call irrespective of current setting.

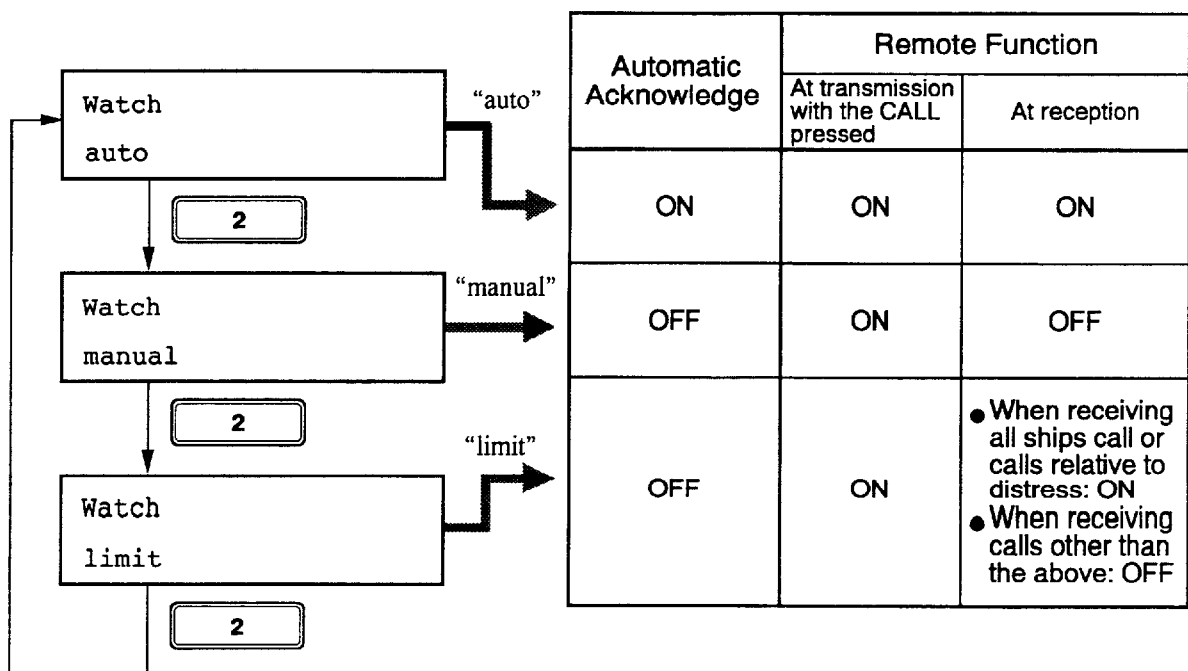

7.2 Auto Acknowledge (AUTO ACK) Function

What is AUTO ACK?

This is used only when receiving an individual call. As shown on the previous page, the AUTO ACK function is on when “auto” appears on the LCD, causing the acknowledge back (ACK BQ) signal to be automatically transmitted to the transmitting station in response to an individual call. (Refer to page 9-5.)

Note: *The AUTO ACK function is not available when receiving or relaying the distress alert, or ECC (ECC: Error Check Character) error is received. (ECC error appears at the end of a receive message when an error is detected.)*

Example of AUTO ACK

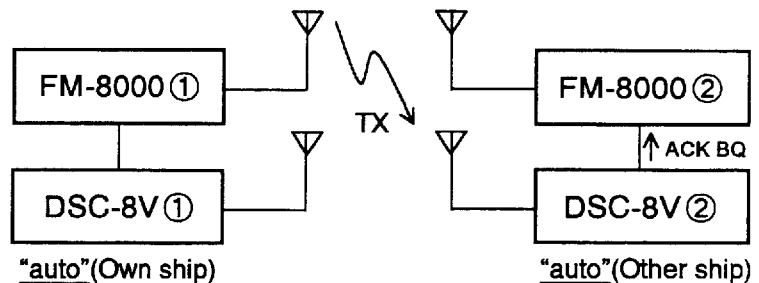

Operation at DSC	Channel of FM-8000 ① (automatic setting)	Channel of FM-8000 ② (automatic setting)
1. Press <input type="button" value="CALL"/> key of DSC-8V ①.	Changed to CH70. (Message is transmitted.)	
2. DSC-8V ② receives message. (Alarm sounds.)		
3. DSC-8V ② sends ACK BQ automatically.		Changed to CH70. (ACK BQ is transmitted.) After that, channel is set to working channel designated by DSC-8V ①.
4. DSC-8V ① receives ACK BQ. (Alarm sounds.)	Changed to working channel designated by DSC-8V ①.	

Then, voice communication begins between stations over working channel designated by the DSC-8V ①.

Free Manuals Download Website

<http://myh66.com>

<http://usermanuals.us>

<http://www.somanuals.com>

<http://www.4manuals.cc>

<http://www.manual-lib.com>

<http://www.404manual.com>

<http://www.luxmanual.com>

<http://aubethermostatmanual.com>

Golf course search by state

<http://golfingnear.com>

Email search by domain

<http://emailbydomain.com>

Auto manuals search

<http://auto.somanuals.com>

TV manuals search

<http://tv.somanuals.com>