

# FURUNO

## OPERATOR'S MANUAL

VHF RADIOTELEPHONE

---

MODEL FM-7000

---



**FURUNO ELECTRIC CO., LTD.**  
NISHINOMIYA, JAPAN

©FURUNO ELECTRIC CO., LTD.

9-52, Ashihara-cho,  
Nishinomiya, Japan 662

Telephone: 0798-65-2111  
Telefax: 0798-65-4200

•Your Local Agent/Dealer

All rights reserved. Printed in Japan

FIRST EDITION : APR 1990  
N : AUG. 25, 1998

(TATA) PUB. No. OME-55170  
FM-7000





# SAFETY INSTRUCTIONS

"DANGER", "WARNING" and "CAUTION" notices appear throughout this manual. It is the responsibility of the operator and installer of the equipment to read, understand and follow these notices. If you have any questions regarding these safety instructions, please contact a FURUNO agent or dealer.



**DANGER**

This notice indicates a potentially hazardous situation which, if not avoided, will result in death or serious injury.



**WARNING**

This notice indicates a potentially hazardous situation which, if not avoided, could result in death or serious injury.



**CAUTION**

This notice indicates a potentially hazardous situation which, if not avoided, could result in minor or moderate injury, or property damage.



# SAFETY INFORMATION FOR THE OPERATOR

## **WARNING**



**Do not open the cover of the equipment.**

This equipment uses high voltage electricity which can shock, burn.  
Only qualified personnel should work inside the equipment.

**Do not disassemble or modify the equipment.**

Fire, electrical shock or serious injury can result.

**Immediately turn off the power at the ship's mains switchboard if water or foreign object falls into the equipment or the equipment is emitting smoke or fire.**

Continued use of the equipment can cause fire, electrical shock or serious injury.

## **CAUTION**

**Do not place liquid-filled containers on the top of the equipment.**

Fire or electrical shock can result if a liquid spills into the equipment.

**Do not place heater near the equipment.**

Heat can melt the power cord, which can result in fire or electrical shock.

**Do not operate the unit with wet hands.**

Electrical shock can result.

**Use the correct fuse.**

Use of the wrong fuse can cause fire or equipment damage.

# SAFETY INFORMATION FOR THE INSTALLER

---

## **WARNING**



Only qualified personnel should work inside the equipment.

This equipment uses high voltage electricity which can shock, burn, or cause death.

**Turn off the power at the ship's mains switchboard before beginning the installation. Post a warning sign near the switchboard to ensure that the power will not be applied while the equipment is being installed.**

Serious injury or death can result if the power is not turned off, or is applied while the equipment is being installed.

## **CAUTION**



**Ground the equipment.**

Ungrounded equipment can give off or receive electromagnetic interference or cause electrical shock.

**Confirm that the power supply voltage is compatible with the voltage rating of the equipment.**

Connection to the wrong power supply can cause fire or equipment damage. The voltage rating appears on the label at the rear of the equipment.

# FM-7000 OPERATOR'S GUIDE

ITEM	KEYSTROKE						
<b>CH16 DISTRESS CALL</b>	<b>ch16</b>						
<b>AUTO REVERT</b> WATCH ON CURRENT CH. WITH THE HANDSET ON THE REST.	Hang the handset in the handset rest. (Ch16 is automatically selected.)  <b>SHIFT</b> <b>INTL</b> <b>1</b> etc.						
<b>CHANNEL SELECTION</b>	(Channel Number) <b>ENT</b> (or rotate channel selector)						
<b>CH MODE (INTL/USA/WX) SELECTION</b>	<b>SHIFT</b> <b>INTL</b> <b>1</b> etc.						
<b>MEMORY OPERATION</b>	<table style="width: 100%; border-collapse: collapse;"> <tr> <td style="padding: 5px;"><b>RECALL</b></td> <td style="padding: 5px;"><b>RCL</b> (Memory Number) <b>ENT</b></td> </tr> <tr> <td style="padding: 5px;"><b>STORE</b></td> <td style="padding: 5px;"><b>SHIFT</b> <b>STO</b> <b>RCL</b> (Memory Number) <b>ENT</b> (Channel Mode: INTL/USA) <b>ENT</b> (Channel Number) <b>ENT</b></td> </tr> <tr> <td style="padding: 5px;"><b>DELETE</b></td> <td style="padding: 5px;"><b>SHIFT</b> <b>STO</b> <b>RCL</b> (Memory Number) <b>ENT</b> <b>0</b> <b>ENT</b></td> </tr> </table>	<b>RECALL</b>	<b>RCL</b> (Memory Number) <b>ENT</b>	<b>STORE</b>	<b>SHIFT</b> <b>STO</b> <b>RCL</b> (Memory Number) <b>ENT</b> (Channel Mode: INTL/USA) <b>ENT</b> (Channel Number) <b>ENT</b>	<b>DELETE</b>	<b>SHIFT</b> <b>STO</b> <b>RCL</b> (Memory Number) <b>ENT</b> <b>0</b> <b>ENT</b>
<b>RECALL</b>	<b>RCL</b> (Memory Number) <b>ENT</b>						
<b>STORE</b>	<b>SHIFT</b> <b>STO</b> <b>RCL</b> (Memory Number) <b>ENT</b> (Channel Mode: INTL/USA) <b>ENT</b> (Channel Number) <b>ENT</b>						
<b>DELETE</b>	<b>SHIFT</b> <b>STO</b> <b>RCL</b> (Memory Number) <b>ENT</b> <b>0</b> <b>ENT</b>						
<b>DUAL WATCH</b>	<table style="width: 100%; border-collapse: collapse;"> <tr> <td style="padding: 5px;">desired CH and CH16</td> <td style="padding: 5px;">(Desired Channel Number) <b>ENT</b> <b>SHIFT</b> <b>DW</b> <b>CH16</b></td> </tr> <tr> <td style="padding: 5px;">desired CH and guard CH (In U.S. waters)</td> <td style="padding: 5px;"><b>SHIFT</b> + <b>DW</b> <b>CH16</b> .... (U.S. coast guard channel should be stored in MEMO 0)</td> </tr> </table>	desired CH and CH16	(Desired Channel Number) <b>ENT</b> <b>SHIFT</b> <b>DW</b> <b>CH16</b>	desired CH and guard CH (In U.S. waters)	<b>SHIFT</b> + <b>DW</b> <b>CH16</b> .... (U.S. coast guard channel should be stored in MEMO 0)		
desired CH and CH16	(Desired Channel Number) <b>ENT</b> <b>SHIFT</b> <b>DW</b> <b>CH16</b>						
desired CH and guard CH (In U.S. waters)	<b>SHIFT</b> + <b>DW</b> <b>CH16</b> .... (U.S. coast guard channel should be stored in MEMO 0)						
<b>SCANNING (Multiple Watch)</b>	<table style="width: 100%; border-collapse: collapse;"> <tr> <td style="padding: 5px;"><b>START</b></td> <td style="padding: 5px;"><b>SHIFT</b> <b>SCAN</b> <b>5</b></td> </tr> <tr> <td style="padding: 5px;"><b>STOP</b></td> <td style="padding: 5px;">Press the PTT switch or any key.</td> </tr> <tr> <td style="padding: 5px;"><b>SETTING SCAN PARAMETERS</b></td> <td style="padding: 5px;"> <p><b>SHIFT</b> + <b>SCAN</b> <b>5</b> → <b>HI/LOW</b> → (1~9) <b>ENT</b></p> <p style="text-align: center;"> <span style="margin-right: 100px;">↑</span> <span>↑</span>                      Select Dual watch quantity                      HOLD or LOCK mode                 </p> </td> </tr> </table>	<b>START</b>	<b>SHIFT</b> <b>SCAN</b> <b>5</b>	<b>STOP</b>	Press the PTT switch or any key.	<b>SETTING SCAN PARAMETERS</b>	<p><b>SHIFT</b> + <b>SCAN</b> <b>5</b> → <b>HI/LOW</b> → (1~9) <b>ENT</b></p> <p style="text-align: center;"> <span style="margin-right: 100px;">↑</span> <span>↑</span>                      Select Dual watch quantity                      HOLD or LOCK mode                 </p>
<b>START</b>	<b>SHIFT</b> <b>SCAN</b> <b>5</b>						
<b>STOP</b>	Press the PTT switch or any key.						
<b>SETTING SCAN PARAMETERS</b>	<p><b>SHIFT</b> + <b>SCAN</b> <b>5</b> → <b>HI/LOW</b> → (1~9) <b>ENT</b></p> <p style="text-align: center;"> <span style="margin-right: 100px;">↑</span> <span>↑</span>                      Select Dual watch quantity                      HOLD or LOCK mode                 </p>						

## OPTIONAL FUNCTIONS

These functions require optional devices. Check here if the function is available

<b>HAILER</b>	<b>SHIFT</b> <b>HAILER</b> <b>8</b>	
<b>DSC(class-C) INDIVIDUAL CALL</b>	<b>SHIFT</b> <b>ID</b> <b>HI/LOW</b> (Receiving station's ID) <b>ENT</b> <b>SHIFT</b> <b>CALL</b> <b>9</b>	
<b>INTERCOM</b>	<b>SHIFT</b> <b>INTCOM</b> <b>7</b> (2~5) <b>ENT</b>	
<b>BEEP</b>	Continuous beep 2-tone alarm for 5 sec 5 long beeps	When DSC distress call is received. While sending a DSC distress call. (Beep sounds from handset speaker.) When individual call is received.

V

# TABLE OF CONTENTS

<b>SAFETY INSTRUCTIONS</b> .....	i
<b>CHANNEL 16 DISTRESS CALL</b> .....	1
<b>DSC CLASS A DISTRESS CALL</b> .....	2
<b>INTRODUCTION</b> .....	3
<b>SPECIFICATIONS</b> .....	4

## **1** OPERATION

---

<b>1. BASIC RULES</b> .....	1-2
Status at Start Up .....	1-2
Key Operation Rules .....	1-2
Automatic Selection of CH16 .....	1-2
Audible Alarm/Key Operation .....	1-3
<b>2. CONTROLS AND INDICATIONS</b> .....	1-4
Keyboard .....	1-4
Functions of each Key .....	1-5
Display Indications .....	1-6
<b>3. BASIC OPERATION</b> .....	1-7
Turning the Power ON and OFF/Adjusting Volume ..	1-7
Adjusting Squelch .....	1-7
Transmitting and Selecting RF Output Power .....	1-7
Turning the Speaker ON and OFF .....	1-7
Adjusting Dimmer .....	1-7
<b>4. SELECTING CHANNEL MODE</b> .....	1-8
<b>5. SELECTING CHANNEL</b> .....	1-9
<b>6. RECALLING MEMORY CHANNELS</b> .....	1-10
<b>7. STORING CHANNELS</b> .....	1-11
<b>8. DELETING MEMORY CHANNELS</b> .....	1-12
<b>9. DUAL WATCH – CH16/Another Channel</b> .....	1-13
<b>10. DUAL WATCH</b>	
– Guard Channel/Another Channel .....	1-14
<b>11. SCANNING</b> .....	1-15
Scan Stop Mode .....	1-16

## **2 DSC OPERATION**

---

- 1. GENERAL ..... 2-2
- 2. DSC ROUTINE CALL ..... 2-3
- 3. RECEIVING A DSC CALL ..... 2-5

## **3 OPERATION OF OPTIONAL EQUIPMENT**

---

- 1. INTERCOM ..... 3-2
- 2. LOUDHAILER ..... 3-3
- 3. RECEIVING 5-TONE SELCALL ..... 3-4
- 4. REJECTING THE CONTROL  
BY THE REMOTE STATION ..... 3-5

## **4 MAINTENANCE**

---

- 1. REGULAR CHECK ..... 4-2
- 2. FUSE REPLACEMENT ..... 4-3
- 3. TROUBLESHOOTING ..... 4-4
- 4. ERROR MESSAGES ..... 4-5
- 5. SELF-TEST ..... 4-6
- 6. EXPLODED VIEW ..... 4-7



## **5** **INSTALLATION**

---

<b>1. TRANSCEIVER UNIT</b> .....	5-2
Mounting Location .....	5-2
Compass Safe Distance .....	5-3
Bulkhead/Ceiling/Tabletop Mounting .....	5-3
Flush Mounting .....	5-4
<b>2. ANTENNA</b> .....	5-5
<b>3. HANDSET HANGER</b> .....	5-5
<b>4. EXTERNAL POWER SUPPLY</b> .....	5-5
<b>5. CONNECTIONS</b> .....	5-6
<b>6. OPTIONAL BOARDS</b> .....	5-8
<b>7. CONNECTION OF EXTERNAL UNITS</b> .....	5-8

## **6** **COMPLETE SET**

---

<b>1. COMPLETE SET</b> .....	6-2
<b>2. INSTALLATION MATERIALS</b> .....	6-4
<b>3. ACCESSORIES</b> .....	6-5
<b>4. SPARE PARTS</b> .....	6-6

## **7** **APPENDIX**

---

<b>SYSTEM DIAGRAM</b> .....	D-1
<b>OUTLINE DRAWINGS</b> .....	D-2
<b>INTERCONNECTION DIAGRAM</b> .....	S-1
<b>SCHEMATIC DIAGRAMS</b> .....	S-2
<b>INTERNATIONAL VHF FREQUENCY LIST</b> .....	A-1
<b>MEMORY CHANNEL LIST</b> .....	A-2

# CHANNEL 16 DISTRESS CALL

Whenever the radio is in operation, keep watch on channel 16 for distress or calling message.

## IF MAYDAY IS HEARD

Distress communications have absolute priority. If you hear MAYDAY, immediately stop any transmission. Note the details of the message in the radio log. Be prepared to offer assistance or relay the distress message.

## TO MAKE A MAYDAY CALL

1. Switch to channel 16.
2. Pick up the handset, press its PTT switch and then send the distress message.

Speak **SLOWLY, CLEARLY** and **CALMLY**.

- ① Say : "MAYDAY\_MAYDAY\_MAYDAY."
- ② Say : "This is \_\_,\_\_,\_\_." (your boat's name)
- ③ TELL WHERE YOU ARE. (What nav. aids or landmarks are near.)
- ④ STATE THE NATURE OF YOUR DISTRESS (fire, collision, etc.).
- ⑤ TELL WHAT ASSISTANCE IS REQUIRED.
- ⑥ BRIEFLY DESCRIBE YOUR BOAT. \_\_(type),\_\_(length),  
\_\_(material), \_\_(color), \_\_(registration no.),  
\_\_\_\_\_(anything else you think will help rescuers to find you.)
- ⑦ Say : "I will be listening on channel 16. \_\_(your boat's name)  
OVER."

3. Release the PTT switch and listen: coast operator should answer.  
Follow his directions afterwards. If some other channel is specified,  
select it with the **CHANNEL** control.  
**IF NO ONE REPLIES, REPEAT THE CALL AGAIN.**

# DSC CLASS A DISTRESS CALLING

DSC terminal connection allows DSC class A distress call.

## DSC TERMINAL WITH FREQUENCY REMOTE CONTROL (ex. FURUNO DSC-5/DSC-5V)

1. Confirm that the FM-7000 and the DSC terminal are on.
2. Press **DISTRESS** switch on the DSC terminal.  
FM-7000 transmits the distress alert on CH 70.  
When the distress acknowledge signal(DIST ACK) is received, the DSC terminal displays DIST ACK.
3. Communicate with a receiving station.

## DSC TERMINAL WITHOUT FREQUENCY REMOTE CONTROL

1. Confirm that the FM-7000 and the DSC terminal are on.
2. On the FM-7000, press **SHIFT** key followed by **CH70** **0** key.
3. Press **DISTRESS** switch on the DSC terminal.  
FM-7000 transmits the distress alert on CH70.  
When the distress acknowledge signal(DIST ACK) is received, the DSC terminal displays DIST ACK and the channel to be used to communicate the distress message.
4. On the FM-7000, select the channel appointed by the receiving station.
5. Communicate with the receiving station.

---

# INTRODUCTION

The FM-7000 is a highly advanced, full duplex, fully synthesized 25W VHF transceiver, designed to satisfy the stringent requirements of marine communications. A built-in duplexer ensures quality two-way communications using a single antenna.

The FM-7000-S incorporates all the features of the FM-7000 less the duplexer, for users who only require semi-duplex communication.

## ■ Features

- ◆ Pre-programmed with all international marine channels. Where permitted, USA channels, weather channels and private channels are also programmed.
  
- ◆ Up to 20 user-programmed channels.
  
- ◆ Single action selection of channel 16.
  
- ◆ Automatic selection of channel 16 when the handset is hung up.
  
- ◆ Economical 12VDC operation. For AC operation, rectifier PR-101 is required. For 24VDC operation, DC-DC converter PC-208 is required.  
AC/DC power supply unit is under development.
  
- ◆ Option;
  - Distress reception and distress calling from DSC terminal
  - 5-tone selective calling reception
  - Remote control by remote station(type: FURUNO RB-700)
  - Intercom between main unit and remote station

# SPECIFICATIONS

## GENERAL

Frequency Range	TX : 155.000 to 161.475MHz RX : 155.000 to 163.275MHz
Channel Program	INTL Channel: 55 USA Channel: 55 WX Channel: 10 PRIV Channel: 20 (authorization required) Full duplex not available on private channels other than international VHF channels 01-28 and 40-88.
Oscillator	PLL synthesizer
Frequency Deviation	$\pm 10 \times 10^{-6}$ max.
Communication System	Full duplex, Semi-duplex(Private channel) & Simplex (Semi-duplex & Simplex:FM-7000-S)
Class of Emission	F3E, F2B, F2C, F2D
Antenna Impedance	50 $\Omega$
Dimensions and Weight	250(W) $\times$ 99(H) $\times$ 248(D)mm 4.0kg
Environment	Temperature: $-20^{\circ}\text{C}$ to $55^{\circ}\text{C}$ Relative Humidity:93% at $+40^{\circ}\text{C}$
Power Supply	12VDC +30% $-$ 10%
Current Drain	Transmit: 6.0A max. Receive: 0.52A max. Stand-by: 0.37A max. 100/110/220VAC, 1 $\phi$ , 50/60Hz (Rectifier PR-101 required.) 24VDC(DC-DC Converter PC-208 required.)
Color	Panel: Munsell N3.0 Chassis: Munsell 2.5GY 5/1.5

**TRANSMITTER**

RF Output Power	25W(HI), 1W(LOW)
Modulation AF Response	Within +1/ - 3 of 6dB/oct de-emphasis characteristics at 300 to 3000Hz
Frequency Deviation	± 5kHz max.
Spurious Emission	Less than 0.25 $\mu$ W
Modulation System	Reactance Type
Hum and Noise	20dB min.

**RECEIVER**

Receiving System	Double Superheterodyne
Intermediate Frequency	First IF: 16.9MHz Second IF: 455kHz
Sensitivity	2 $\mu$ V min. (at 20dB)
Signal Selectivity	12kHz min. (at 6dB) 25kHz max. (at 70dB)
Spurious Response Rejection	80dB max.
Blocking	10mV min.
Squelch Sensitivity	1 $\mu$ V max.
Audio Output	Internal Speaker: 1W min.(8 $\Omega$ ) External Speaker: 4W min.(4 $\Omega$ ) Handset: 1mW (200 $\Omega$ )

**MISCELLANEOUS**

Functions	Dual watch Scan function DSC class C operation(option) Remote control(option) 5-tone selcall(option) Loudhailer(option)
-----------	----------------------------------------------------------------------------------------------------------------------------------------

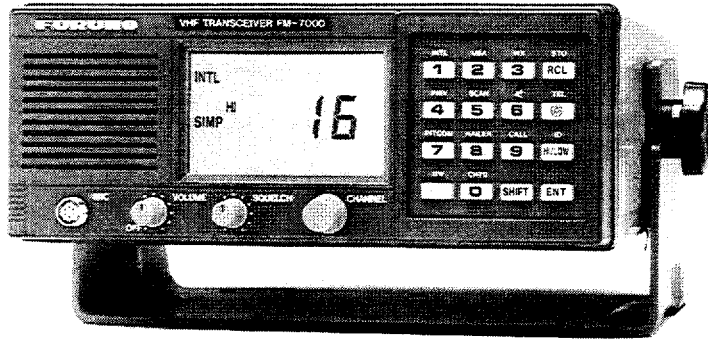

## **OPERATION**

	<u>Page</u>
1. BASIC RULES .....	1-2
Status at Start Up .....	1-2
Key Operation Rules .....	1-2
Automatic Selection of Channel 16 .....	1-2
Audible Alarm/Key Operation .....	1-3
2. CONTROLS AND INDICATIONS .....	1-4
3. BASIC OPERATION .....	1-7
Turning the Power ON and OFF/	
Adjusting Volume .....	1-7
Adjusting Squelch .....	1-7
Transmitting and Selecting RF Output Power .....	1-7
Turning the Speaker ON and OFF .....	1-7
Adjusting Dimmer .....	1-7
4. SELECTING CHANNEL MODE .....	1-8
5. SELECTING CHANNELS .....	1-9
6. RECALLING MEMORY CHANNELS .....	1-10
7. STORING CHANNELS .....	1-11
8. DELETING MEMORY CHANNELS .....	1-12
9. DUAL WATCH	
CH16 and Another channel .....	1-13
10. DUAL WATCH	
Guard channel and Another channel .....	1-14
11. SCANNING .....	1-15
Scan Stop Mode .....	1-16



# 1. BASIC RULES

## Status at Start Up

Each time you turn the FM-7000 on it begins operation with the previous settings (memorized by a super capacitor) of the following controls:

- 1) Channel Mode INTL/USA/WX/PRIV
- 2) Channel Number
- 3) Output Power HI/LOW
- 4) Speaker ON/OFF
- 5) Dimmer

**NOTE:** If the time elapsed between power applications is greater than 24 hours, channel 16 (international distress channel) is automatically selected.

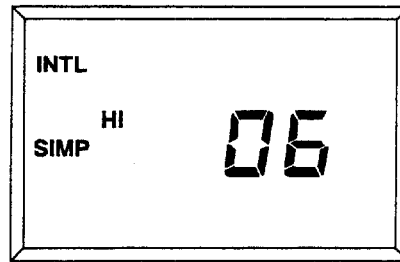

(Operation begins with previous setting.)

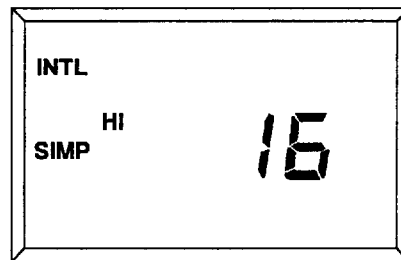

(When 24 hours elapses between power on, INTL CH16 is selected.)

## Key Operation Rules

- When entering a line of data, press each key within five seconds of the previous one. Otherwise, the FM-7000 will return control to the previous display screen.
- The **SHIFT** key alternates selection of primary and secondary functions. When the secondary function mode is in use, a sharp sign (#) appears on the LCD.

## Automatic Selection of Channel 16

Channel 16 is automatically selected when the handset is hung.

## Audible Alarm/ Key Operation

Operation	Convention	
Valid key operation	1 short beep	Pi
Invalid key operation	3 short beeps	PiPiPi
Receiving a distress call	continuous beeps	Pi—
Sending DSC distress call	short beeps in 5-sec. period	Pi-Pi-Pi-...
DSC distress call	audible alarm sounds *1	Pi-Po-Pi-Po-...
Receiving	5 long beeps	Pi-Pi-Pi-Pi-Pi-

\*1: Alarm sounds through the handset speaker. (Internal speaker is off.)



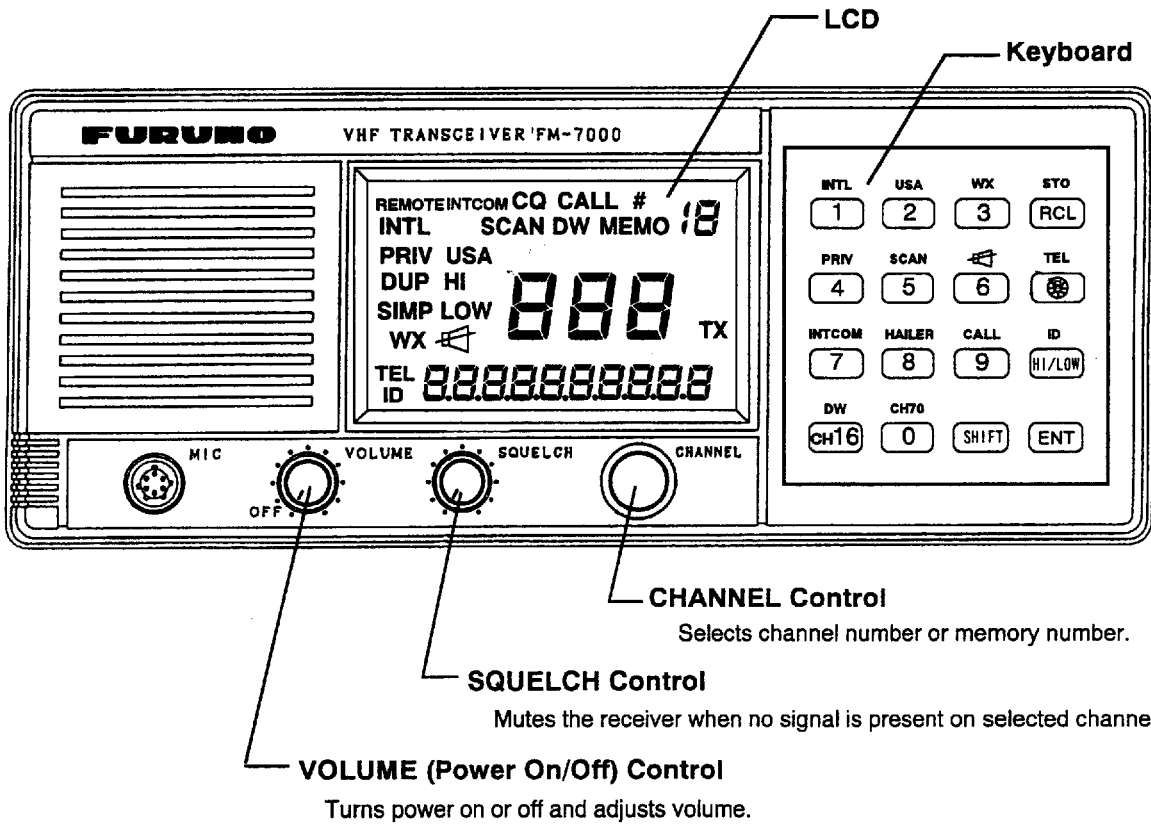













## 2. CONTROLS AND INDICATIONS



### Keyboard

Most operations are carried out through the 16-key keyboard. Most keys have both a primary and a secondary function, the secondary function denoted above a key. (Note that some secondary functions require the connection of optional equipment.)

## Functions of each key

Key	Secondary Function	Optional secondary Func.
	Primary Function	Optional Primary Func.
INTL 	Selects international mode.	—
	Enters 1.	—
USA 	Selects USA mode.	—
	Enters 2.	—
WX 	Selects weather mode.	—
	Enters 3.	—
PRIV 	Selects private mode.	—
	Enters 4.	—
SCAN 	Starts scanning.	—
	Enters 5.	—
 	Turns the speaker on or off.	—
	Enters 6.	—
INTCOM 	—	Activates intercom (interphone).
	Enters 7.	—
HAILER 	—	Activates a loud hailer.
	Enters 8.	—
CALL 	—	Makes DSC routine call.
	Enters 9.	—
CH70 	Selects channel 70.	—
	Enters 0.	—
DW 	Starts dual watching.	—
	Selects channel 16.	—
STO 	Registers memory channel.	—
	Recalls memory channel.	—
TEL 	—	Enters telephone number.
	Adjusts backlighting for LCD and keyboard.	—
ID 	—	Enters ID number.
	Selects output power; HI: 25W, LOW: 1W	—
	Confirms key operation.	—
	Selects sub function mode.	—

## Display Indications

The LCD displays various marks and indications which show operational status. The figure below shows the location and meaning of each mark and indication.

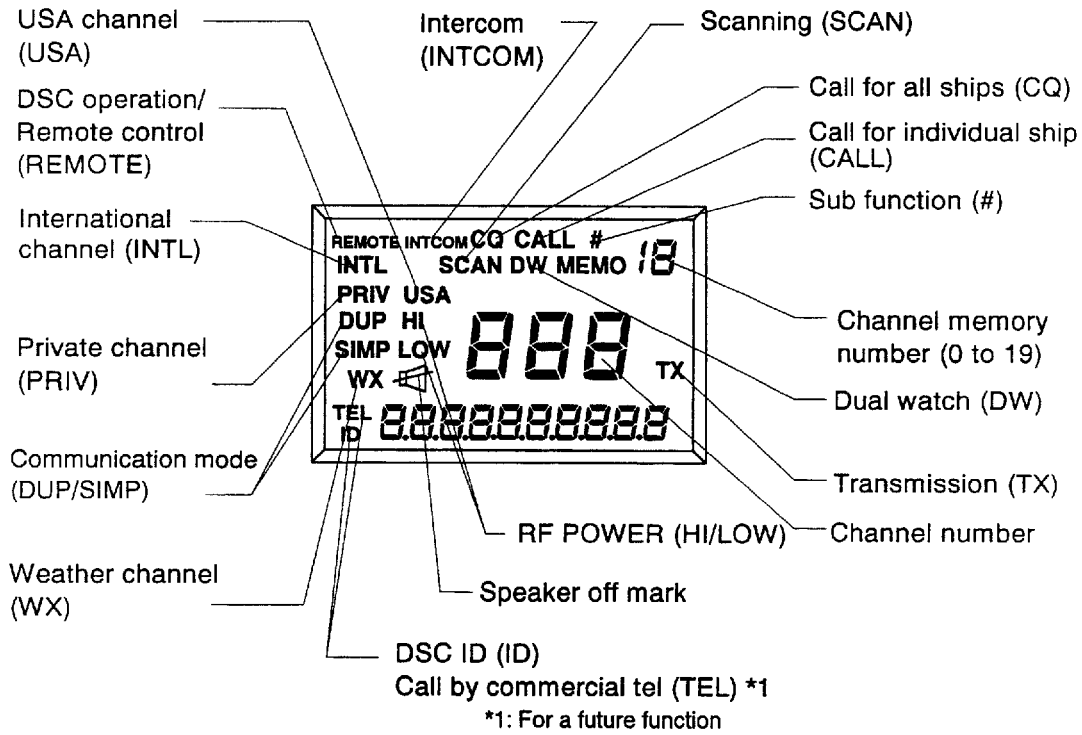

## 3. BASIC OPERATION

### Turning the Power ON and OFF/Adjusting Volume

The **VOLUME** control turns the power on and off and adjusts the volume of the speaker. To turn the power on, turn the control clockwise until you hear a click. Further clockwise rotation adjusts the volume of the speaker. To turn the power off, turn the control fully counterclockwise until you hear the click.

### Adjusting Squelch

The **SQUELCH** control adjusts the squelch threshold level. Adjust it so white noise heard in the loudspeaker just fades out. When there is no signal, turn it fully counterclockwise to silence the receiver.

### Transmitting/Selecting RF Output Power

Press the PTT switch to talk and release it to listen for the response.



Each press of the  key selects HI or LOW output power .

The transmitter power is automatically set for low on the following channels.

**International : CH15/17, USA : CH13/17/67**

To operate US channel 13 or 67 in high power, keep the  key pressed while talking into the handset.

### Turning the Speaker ON and OFF

The  key turns the speaker on and off. To turn the speaker on or off, press the  key followed by the  key. The speaker symbol appears on the LCD when the speaker is off.

### Adjusting Dimmer

The  key adjusts the backlighting for both the LCD and keyboard in four steps: bright, normal, dim and off. Each time you press the key the backlighting changes in the above sequence.

## 4. SELECTING CHANNEL MODE

Channel Mode	Key Operation	Indication
International Channel	<b>SHIFT</b> → <sup>INTL</sup> <b>1</b>	<b>INTL</b>
USA Channel	<b>SHIFT</b> → <sup>USA</sup> <b>2</b>	<b>USA</b>
Weather Channel	<b>SHIFT</b> → <sup>WX</sup> <b>3</b> (Previous weather channel is selected.)	<b>WX</b>
Private Channel	<b>SHIFT</b> → <sup>PRIV</sup> <b>4</b> (Previous private channel is selected.)	<b>PRIV</b>
Memory Channel	<sup>STO</sup> <b>RCL</b> (Previous memory channel is selected.)	<b>MEMO</b>

### Private Channel Operation

Private channels are available only where permitted.

## 5. SELECTING CHANNELS

You may enter channels through the keyboard or by operating the **CHANNEL** control. Entry of an invalid channel causes the FM-7000 to reject the channel and revert to previous channel.

### Procedure

(ex) Select channel 20.

- [1] Press the <sup>USA</sup> **2** key followed by the <sup>CH70</sup> **0** key.  
(Channel number blinks.)

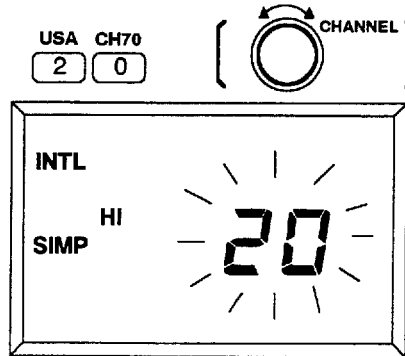

- [2] Press the **ENT** key to select channel 20.

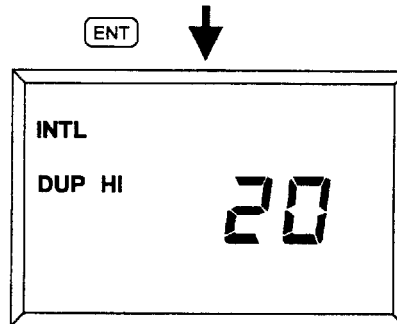

### Tip

- Press the **ENT** **within 5 seconds** after entering channel number.  
Otherwise, the unit restores the previous display.
- To recall L, F or P channels:
  - ◇ Every pressing of the <sup>PRIV</sup> **4** key changes the display in the sequence of L ⇒ F ⇒ P ⇒ L ⇒ ...
  - OR
  - ◇ Press the <sup>PRIV</sup> **4** key and then rotate the **CHANNEL** control.





## 6. RECALLING MEMORY CHANNELS

The FM-7000 provides a memory bank for storing up to 20 channels, including private channels.

### Procedure

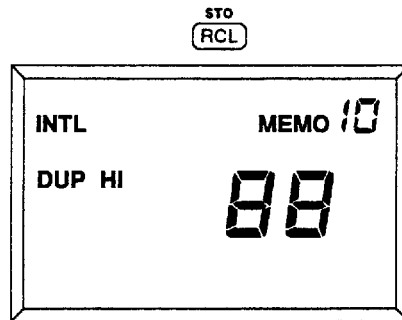
- [1] Press the  key to recall a memory channel.  
The previous memory channel appears.  
Select a memory channel by rotating the **CHANNEL** control or pressing the numeral keys.  
When rotating the control, blank channels are skipped.



- (ex) Select memory channel 12.
- [2] Press the  key followed by the  key.  
(Memory channel blinks.)

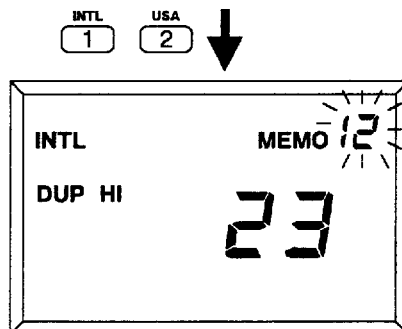

- [3] Press the  key to select memory channel 12.

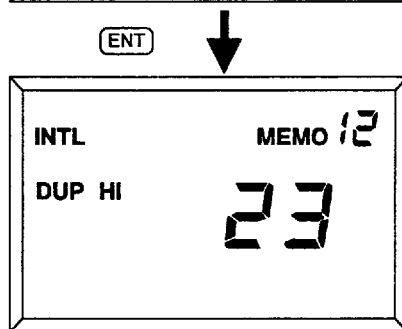

### Tip

- Invalid channels generate three beeps and then the previous channel appears.
- In the case of no memory channels;  
The display shown right appears.  
(Memory channel number "0" blinks.)

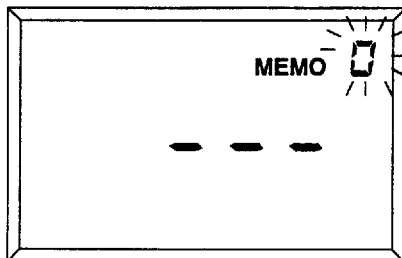

## 7. STORING CHANNELS

### Procedure

- [1] Press the **SHIF** key followed by the **STO RCL** key.

The previous memory channel appears.

When there are no channels stored in the memory, the display shown right appears.

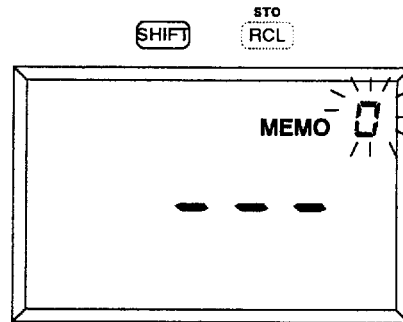

- [2] Enter channel number [0 to 19] by pressing the numeral keys.

(ex) Select memory number 12.

Press the **INTL 1** **USA 2** followed by the **ENT** key.

Channel mode indication **INTL** blinks.

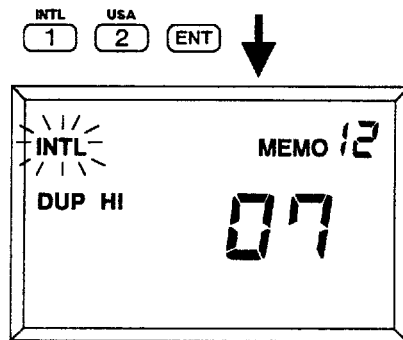

- [3] Press desired channel mode key followed by the **ENT** key.

(ex) Set the channel mode for **INTL**.

Press the **INTL 1** key followed by the **ENT** key.  
Channel number blinks.

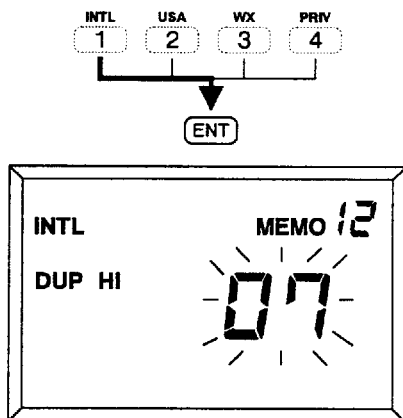

- [4] Enter channel number, then press the **ENT** key.

(ex) Select channel number CH23.

Press the **USA 2** **WX 3** key followed by the **ENT** key.

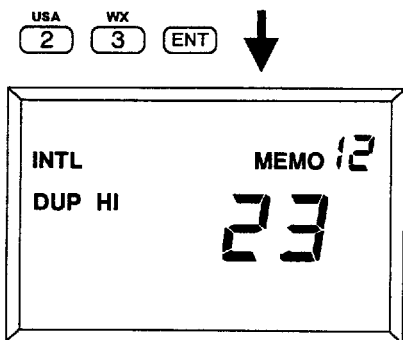

## 8. DELETING MEMORY CHANNELS

### Procedure

- (1) Press the **SHIFT** key followed by the **STO RCL** key.  
The previous memory channel appears.

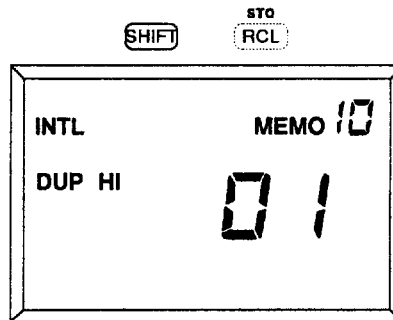

- (2) Enter the memory channel you want to delete, then press the **ENT** key.

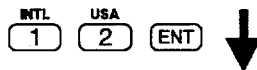

- (ex) Delete memory channel 12.

Press the **INTL 1** **USA 2** key followed by the **ENT** key, or select CH12 by rotating the **CHANNEL** control, then press the **ENT** key.  
The indication **INTL** blinks.

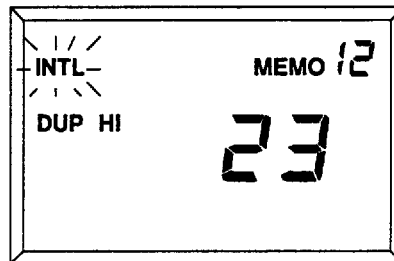

- (3) Press the **CH70 0** key followed by the **ENT** key.  
Channel 12 is deleted;  
" — — — " appears on the display.

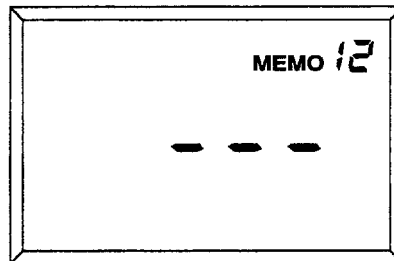

## 9. DUAL WATCH – CH16 and another channel

The dual watch function allows you to keep watch on channel 16 and another channel.

For example, another channel is CH20;

Channel Indication	CH20 → CH16 → CH20 → CH16 → CH20 → ...					
Receiving Time (sec.)	1	0.15	1	0.15	1	.....

### Procedure

[1] Select the channel you want to watch along with CH16 by operating the CHANNEL control.

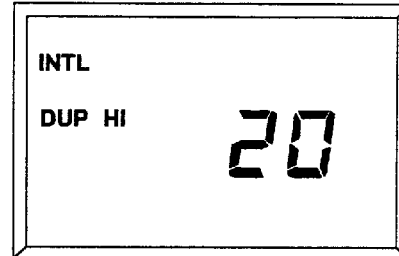

[2] Press the **SHIFT** key followed by the **DW CH16** key. The indication **DW** appears on the display. The distress channel and channel selected are watched at intervals of 0.15 second and 1 second, respectively. Further, the LCD alternately displays CH16 and the channel selected.

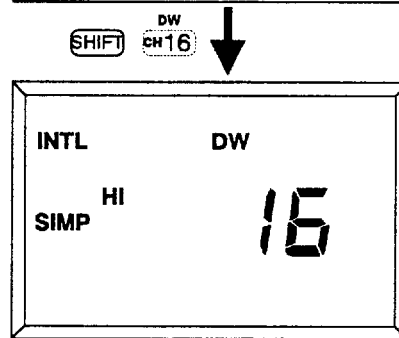

[3] To escape from the dual watch mode, hit any key or press the PTT switch on the handset.

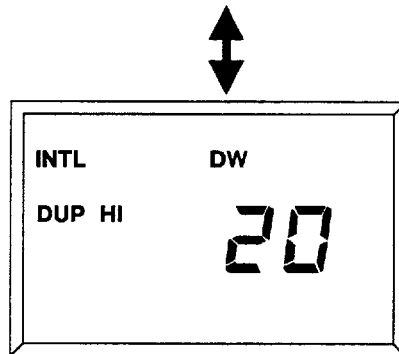

### Tip

- **When a signal is present on CH16;**
  - ① The receiver locks on CH16 and ignores the other channel.
  - ② Five seconds after the signal on CH16 has gone, the receiver reverts to dual watching again.
- **When a signal is present on the channel being watched;**  
Keep dual watching before escaping from this mode.

## 10. DUAL WATCH – guard channel and another channel

The dual watch function allows you to keep watch on coast guard channel stored in the memory and another channel. **You should store a coast guard channel in the memory number “0” for this function.**

For example, coast guard channel is CH13 in the memory and another channel is CH20;

Channel Indication	CH20	→	CH13	→	CH20	→	CH13	→	CH20	→	...
Receiving Time (sec.)	1		0.15		1		0.15		1		.....

### Procedure

[1] Select the channel you want to watch along with coast guard channel stored in the memory.

[2] While pressing and holding down the **SHIFT** key, press the **DW CH16** key. The indication **DW** appears on the display. The coast guard channel in the **MEMO 0** and channel selected are watched at intervals of 0.15 second and 1 second, respectively. Further, the LCD alternately displays CH13(MEMO 0) and the channel selected.

[3] To escape from the dual watch mode, hit any key or press the PTT switch on the handset.

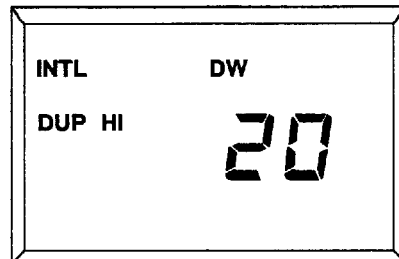
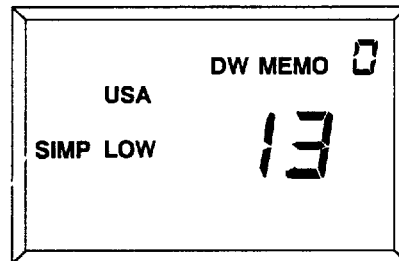
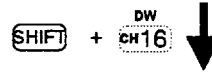
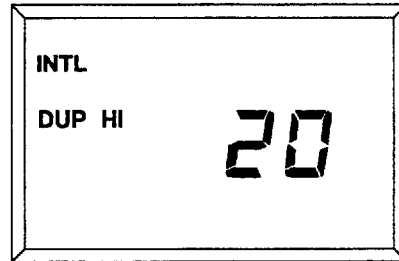

### Tip

- **When a signal is present on coast guard channel in the memory number “0”;**
  - ① The receiver locks on coast guard channel and ignores the other channel.
  - ② Five seconds after the signal on coast guard channel has gone, the receiver reverts to dual watching again.
- **When a signal is present on the channel being watched;**  
Keep dual watching before escaping from this mode.

## 11. SCANNING

The receiver scans a channel mode (USA, WX, etc.) in ascending channel order, stopping when a signal above a certain level is received.

The receiver employs multiple watch; 1-cycle mode and endless mode. One of two modes is available by presetting the jumper wire inside the transceiver.

**Note that the factory setting is endless mode.**

Mode	Function
Multiple Watch [1-cycle mode]	<p>The receiver scans in the selected mode and CH16 is always watched between channels. It terminates scanning when all channels are watched.</p> <p>(ex) Scan starts on CH12 in INTL mode.</p> <p>start <span style="float: right;">end</span></p> <p>12 → 16 → ... → 16 → 88 → 16 → 01 → 16 → ... → 16 → 11</p>
Multiple Watch [Endless mode]	<p>The receiver continuously scans in the selected mode and CH16 is always watched between channels.</p> <p>(ex) Scan starts on CH12 in INTL mode.</p> <p> <span style="font-size: 2em;">}</span> 12 → 16 → 13 → ... → 28 → 16 → 60 → ... → 16 → 88  <span style="font-size: 2em;">}</span> 16 ← 11 ← ..... ← 16 ← 02 ← 16 ←         </p>

### Procedure

- [1] Press the **SHIFT** key followed by the **SCAN 5** key.  
The receiver starts scanning.

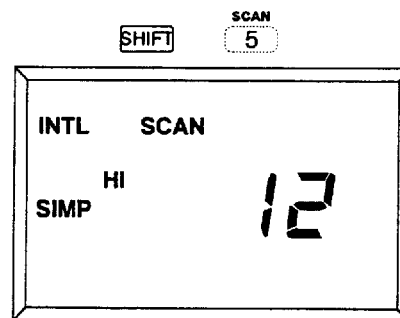

- [2] To escape from the scan mode, hit any key or press the PTT switch on the handset.

## Scan Stop Mode

The receiver offers two modes to stop scanning when it finds a signal, hold or lock.

### ● HOLD Mode

When the receiver finds a signal on a channel other than CH16, it stops scanning and starts dual watching between CH16 and that channel. After dual watching for \* times, it reverts to multiple watch.

(ex) Set the DW quantity for 3 times.

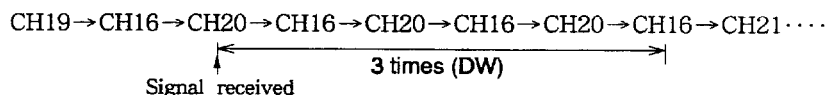

### ● LOCK Mode

When the receiver finds a signal on a channel other than CH16, it stops scanning and starts dual watching. After the signal has gone, the receiver keeps dual watching for \* times.

(ex) Set the DW quantity for 3 times.

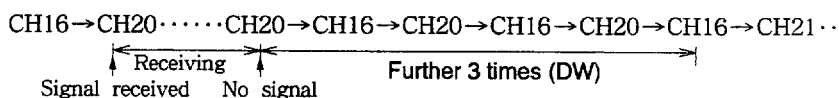

### When a signal is present on CH16;

When the receiver finds a signal on CH16, it receives the signal until it has gone. Further it keeps watching on CH16 for five seconds. After that, the receiver reverts to multiple watch.

Hold or Lock mode can be selected and the scan parameter "\*" can be changed from 1 to 9. The following shows the procedure.

### Procedure

- (1) While pressing and holding down the **SHIFT** key, press the **SCAN 5** key.

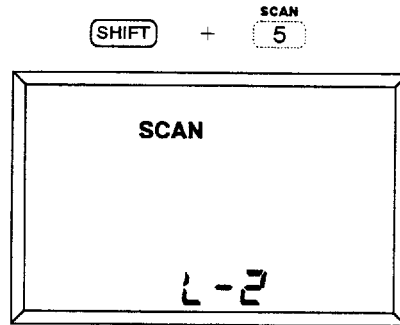

- (2) Each press of the **ID HI/LOW** key alternates display of the HOLD and LOCK mode screens.

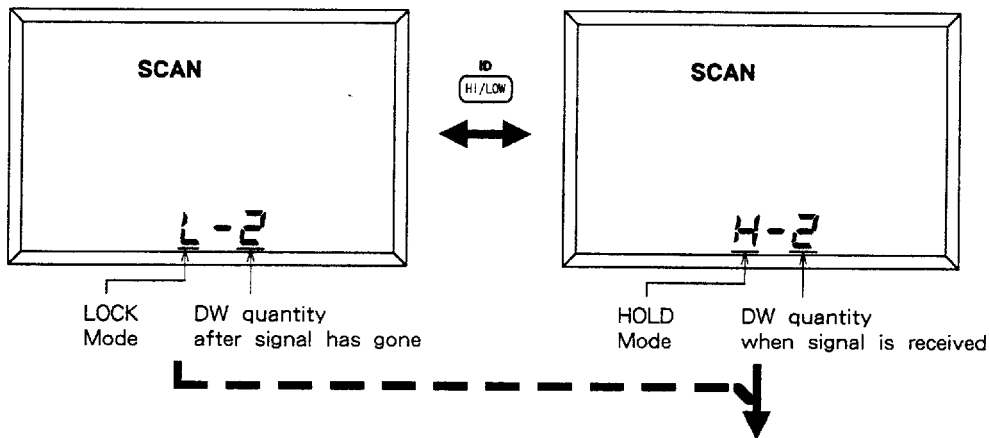

- (3) Enter the DW quantity [1 to 9] followed by pressing the **ENT** key.

(ex) Set the DW quantity for 5 times.

Press the **SCAN 5** key followed by the **ENT** key.

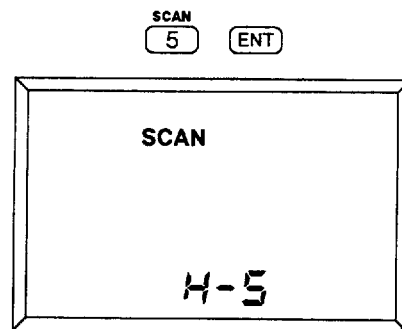



# MEMO

---

## ***DSC OPERATION***

	<u>Page</u>
1. GENERAL .....	2-2
2. DSC ROUTINE CALL .....	2-3
3. RECEIVING A DSC CALL .....	2-5
All Ships Call .....	2-5
Individual Ship Call .....	2-5
Distress Call .....	2-5

## 1. GENERAL

DSC is an acronym meaning Digital Selective Calling. Digital Selective Calling is a digital distress calling system in the MF, HF and VHF frequency bands used by ships for transmitting distress alerts and by coast stations for transmitting the associated acknowledgements.

For distress and safety operation, simplex frequency is used. The VHF DSC frequency is 156.525MHz (channel 70). **Channel 70 is designated exclusively for DSC calling. DSC calling can be done over other channels, however voice communication over channel 70 is prohibited.**

### DSC CALL

DSC calls are divided roughly in two categories: distress and safety, and routine calls (calls to port authorities, etc.).

A DSC call contains the numerical address of the station to which the call is transmitted, the self-identification of the transmitting station and a message which contains several fields of information indicating the purpose of the call.

The receipt of a DSC call by a receiving station is accompanied by a suitable display of the address, the self-identification of the transmitting station and the content of the DSC message, together with audible and visual alarms.

For DSC operation, the optional SUB-CPU board and connector assembly are required.

## 2. DSC ROUTINE CALL

The FM-7000 can transmit DSC routine call.

When the DSC-5 or DSC-5V is connected, however, the DSC operation on the FM-7000 is disabled.

### Procedure

- (1) Select a channel.
- (2) Press the **SHIFT** key followed by the **ID HI/LOW** key. ID appears.
- (3) Enter receiving station's ID followed by the **ENT** key.  
 (ex) Receiving station's ID is 123456789.  
 Press the **INTL** **USA** **WX** **PRV** **SCAN** **←** **1** **2** **3** **4** **5** **6** **7** **8** **9** key followed by the **CH70** **0** **ENT** key.  
**CH70** **0** : Enter "0" after ID to make 10 digits.  
 See next page.
- (4) Press the **SHIFT** key followed by the **CALL 9** key. Digital selective calling signal is transmitted. **TX** appears.

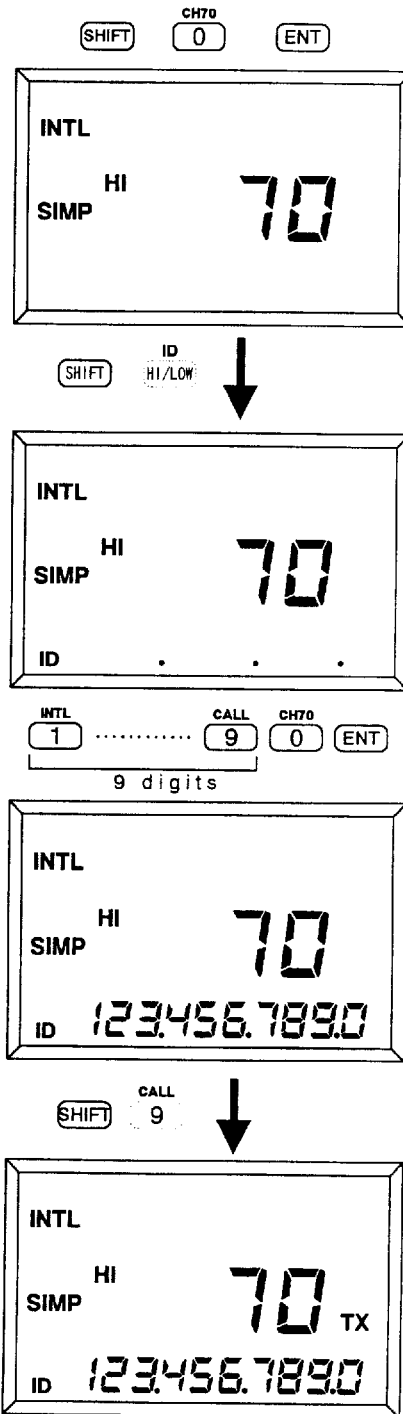

---

**Tip**

- Enter 10 digits when setting an ID number, because the FM-7000 is designed to accept **10 digits**.
  - ◇ Ship's ID is 9 digits, so enter "0" after ID.  
(123.456.789.0)
  - ◇ Group ID is 8 digits, so enter "0" both before and after group ID.  
(012.345.678.0)
  - ◇ Coast ID is 7 digits, so enter two zeroes "00" before ID and one zero "0" after coast ID.  
(001.234.567.0)

### 3. RECEIVING A DSC CALL

The FM-7000 can receive a DSC call by selecting a DSC channel.

#### All Ships Call

When a DSC call is received, five beeps sound and caller's **ID** and **CQ** indication appear.

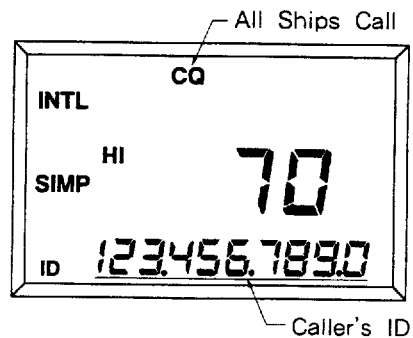

#### Individual Ship Call

When a DSC call is received, five beeps sound and caller's **ID** and **CALL** indication appear.

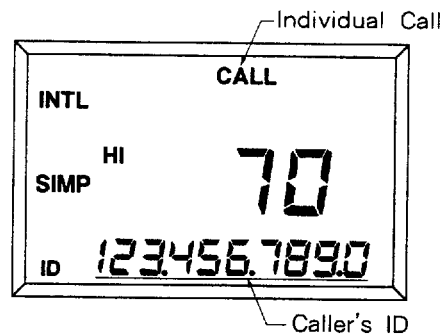

#### Distress Call

When a DSC distress call is received, the unit beeps continuously and caller's **ID** and **CALL** indication appear.

MEMO

---

# MEMO

## Free Manuals Download Website

<http://myh66.com>

<http://usermanuals.us>

<http://www.somanuals.com>

<http://www.4manuals.cc>

<http://www.manual-lib.com>

<http://www.404manual.com>

<http://www.luxmanual.com>

<http://aubethermostatmanual.com>

Golf course search by state

<http://golfingnear.com>

Email search by domain

<http://emailbydomain.com>

Auto manuals search

<http://auto.somanuals.com>

TV manuals search

<http://tv.somanuals.com>