

FURUNO

OPERATOR'S MANUAL

VHF RADIOTELEPHONE

MODEL FM-8800D/8800S



FURUNO ELECTRIC CO., LTD.
NISHINOMIYA, JAPAN



(Elemental Chlorine Free)

The paper used in this manual
is elemental chlorine free.

© **FURUNO ELECTRIC CO., LTD.**

9-52 Ashihara-cho,
Nishinomiya 662-8580, JAPAN

Telephone : 0798-65-2111

Fax : 0798-65-4200

Your Local Agent/Dealer

All rights reserved.

Printed in Japan

Pub. No. OME-56420

(TATA) FM-8800D/S

FIRST EDITION : SEP. 2004

A3 : FEB. 16, 2005



* 0 0 0 1 4 9 9 3 0 0 *



* O M E 5 6 4 2 0 A 3 0 *

CANCELING DISTRESS ALERT

If less than three seconds has elapsed since the [DISTRESS] key was pressed, the distress alert may be canceled by pressing the [CANCEL] key. Otherwise, do the following:

1. Switch off equipment immediately.
2. Switch equipment on and set to Channel 16.
3. Transmit message to "All Stations" giving your vessel's name, callsign and DSC number to cancel the distress alert.

Example message:

All Stations, All Stations, All Stations
This is VESSEL'S NAME, CALLSIGN,
DSC NUMBER, POSITION.

Cancel my distress alert of
DATE, TIME, UTC.
=Master, VESSEL'S NAME, CALLSIGN.
DSC NUMBER, DATE, TIME UTC.



SAFETY INSTRUCTIONS



WARNING

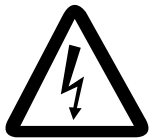

Do not open the equipment.

Hazardous voltage which can cause electrical shock, burn or serious injury exists inside the equipment. Only qualified personnel should work inside the equipment.



Do not approach the antenna closer than 0.9 m (MPE by FCC) when it is transmitting.

The antenna emits radio waves which can be harmful to the human body.

	RF power density on antenna aperture	Distance	Description required by
FM-8800S	100 W/m ²	0.11 m	IEC 60945
	10 W/m ²	0.33 m	IEC 60945
	2 W/m ²	0.9 m	MPE by FCC
FM-8800D	100 W/m ²	0.11 m	IEC 60945
	10 W/m ²	0.33 m	IEC 60945
	2 W/m ²	0.9 m	MPE by FCC

(MPE: Minimum Permissible Exposure)

Do not disassemble or modify the equipment.

Fire, electrical shock or serious injury can result.

Turn off the power immediately if water leaks into the equipment or the equipment is emitting smoke or fire.

Continued use of the equipment can cause fire or electrical shock.

Do not place liquid-filled containers on the top of the equipment.

Fire or electrical shock can result if a liquid spills into the equipment.



WARNING

Do not operate the equipment with wet hands.

Electrical shock can result.

Keep heater away from equipment.

Heat can alter equipment shape and melt the power cord, which can cause fire or electrical shock.

Any repair work must be done by a licensed radio technician.

Improper repair work can cause electrical shock or fire.



CAUTION

Do not touch any part of the antenna when the equipment is transmitting.

Electrical shock can result.

Use the proper fuse.

Use of a wrong fuse can result in fire or cause permanent damage to the equipment.

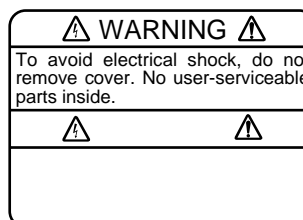

Terminal, Communication Unit

Name: Warning Label (1)

Type: 86-003-1011

Code No.: 100-236-231

Important Notices

- No part of this manual may be copied or reproduced without written permission.
- If this manual is lost or worn, contact your dealer about replacement.
- The contents of this manual and equipment specifications are subject to change without notice.
- The example screens (or illustrations) shown in this manual may not match the screens you see on your display. The screen you see depends on your system configuration and equipment settings.
- This manual is intended for use by native speakers of English.
- FURUNO will assume no responsibility for the damage caused by improper use or modification of the equipment or claims of loss of profit by a third party.

TABLE OF CONTENTS

FOREWORD	vii
-----------------------	------------

SYSTEM CONFIGURATION.....	ix
----------------------------------	-----------

SPECIFICATIONS.....	SP-1
----------------------------	-------------

1. OPERATIONAL OVERVIEW

1.1 Controls Keys and LCD Indication.....	1-1
1.1.1 Front panel.....	1-1
1.1.2 Controls	1-2
1.1.3 Indications on the LCD.....	1-5
1.1.4 Audio alarms.....	1-6
1.2 VHF Basic Operation.....	1-7
1.2.1 Turning the power on and adjusting contrast.....	1-7
1.2.2 Selecting channel modes, channels.....	1-7
1.2.3 Adjusting volume of loudspeaker	1-8
1.2.4 Adjusting squelch.....	1-8
1.2.5 Transmitting	1-8
1.2.6 Selecting output power	1-8
1.2.7 Turning the loudspeaker on/off.....	1-8
1.2.8 Quick selection of CH16	1-9
1.2.9 Dual watch.....	1-9
1.2.10 Scanning.....	1-9
1.2.11 Remarks on voice communications.....	1-9
1.3 DSC Operational Overview	1-10
1.3.1 LED warnings	1-10
1.3.2 DSC operational overview.....	1-10
1.3.3 Automatic acknowledge on/off	1-11
1.4 Priority.....	1-12

2. DSC DISTRESS COMMUNICATION

2.1 Distress Alert Transmission from the DISTRESS Key.....	2-1
2.2 Distress Alert Transmission with Nature of Distress	2-3
2.3 Distress Alert Transmission From CALL Key	2-5
2.4 Canceling a False Distress Alert.....	2-6
2.5 Receiving Distress Alert from Other Vessel, Transmitting DIST ACK Signal	2-7
2.6 Sending Distress Relay on Behalf of a Ship in Distress	2-11
2.6.1 Sending distress relay to coast station	2-11
2.6.2 Sending distress relay to all ships	2-13
2.7 Receiving Distress Relay.....	2-15
2.7.1 Receiving distress relay all call	2-15
2.7.2 Receiving distress relay from coast station	2-16

3. DSC OPERATION FOR NON-DISTRESS CASES

3.1	Coast or Ship Call	3-1
3.1.1	Sending a coast or ship call	3-2
3.1.2	Receiving acknowledgement of coast or ship call	3-4
3.1.3	Receiving a coast or ship call	3-5
3.2	Group Call	3-10
3.2.1	Sending a group call	3-10
3.2.2	Receiving a group call	3-12
3.3	PSTN Call	3-13
3.3.1	Sending a PSTN call	3-13
3.3.2	PSTN call disconnection (ship disconnects line)	3-14
3.3.3	PSTN call disconnection (coast station disconnects line)	3-15
3.3.4	Receiving a PSTN call	3-15
3.4	All Ships Call	3-16
3.4.1	Sending an all ships call	3-16
3.4.2	Receiving an all ships call	3-18
3.5	Geographical Area Call	3-19
3.5.1	Sending a geographical area call	3-19
3.5.2	Receiving a geographical area call	3-21
3.6	Position Call	3-22
3.6.1	Position call: requesting other ship's position	3-22
3.6.2	Position call: other ship requests your position	3-24
3.7	Polling Call	3-25
3.7.1	Sending a polling call	3-25
3.7.2	Receiving a polling call	3-27
3.8	Neutral Craft Call	3-29
3.8.1	Sending a neutral craft call	3-29
3.8.2	Receiving a neutral craft call	3-29
3.9	Medical Transport Call	3-30
3.9.1	Sending a medical transport call	3-30
3.9.2	Receiving a medical transport call	3-31
3.10	Log File	3-32

4. BASIC SETUP

4.1	Alarm Setup	4-1
4.2	Auto ACK Setup	4-3
4.3	Erasing Logs	4-5
4.4	Memory Channel Setup	4-6
4.5	Message File Entry	4-7
4.6	Position Setup	4-11
4.7	Print Out Setup	4-12
4.8	Volume Setup	4-13

TABLE OF CONTENTS

5. SYSTEM SETUP

5.1	Displaying Self ID	5-1
5.2	Displaying Group ID List.....	5-1
5.3	Naming Intercom.....	5-2
5.4	Displaying Program Version	5-3

6. MAINTENANCE & TROUBLESHOOTING

6.1	Maintenance.....	6-1
6.2	Troubleshooting.....	6-1
6.3	Daily Test.....	6-2
6.4	Error Message.....	6-3
6.5	Parts Location	6-3

APPENDIX AP-1

Menu Tree	AP-1
Marine VHF Channel Lists.....	AP-3
Digital Interface (IEC 61162-1 Edition 2).....	AP-14

INDEX..... IN-1

Declaration of conformity

FOREWORD

A Word to FM-8800D/FM-8800S Owners

Congratulations on your choice of the FURUNO FM-8800D/FM-8800S VHF Radiotelephone. We are confident you will see why the FURUNO name has become synonymous with quality and reliability.

For over 50 years FURUNO Electric Company has enjoyed an enviable reputation for quality marine electronics equipment. This dedication to excellence is furthered by our extensive global network of agents and dealers.

This equipment is designed and constructed to meet the rigorous demands of the marine environment. However, no machine can perform its intended function unless operated and maintained properly. Please carefully read and follow the recommended procedures for operation and maintenance.

We would appreciate hearing from you, the end-user, about whether we are achieving our purposes.

Thank you for considering and purchasing FURUNO equipment.

Features

The FURUNO FM-8800D/FM-8800S is a cost-effective all-in-one marine VHF radio system consisting of a 25 W VHF radiotelephone, a DSC modem, and a CH 70 watch receiver. It complies with GMDSS carriage requirements for safety and general communications.

The FM-8800D offers full-duplex voice communications and the FM-8800S offers simplex voice communication on ITU channels in the marine mobile VHF band. The features include Dual Watch which allows a continuous watch on CH16 and another selected frequency.

Full Class-A DSC functions are provided for distress alert transmission and reception, as well as the general call formats (Individual telephone, All Ships, Group and Area Call). Distress alert can be readily transmitted but an arrangement is provided to prevent accidental activation. The FM-8800D/FM-8800S maintains a continuous watch on CH70 even while another VHF channel is in use. Aural and visual alarms are given to incoming DSC messages.

The main features of the FM-8800D/FM-8800S are

- Compact cabinet allows for flexible and space-saving installation on a navigation console or at the conning position
- Conforms to the following standards and regulations:
 - IMO A.385 (X), A.524 (13), A.694 (17), A.803 (19)
 - IMO MSC 68 (68) A1/A2/A3/A4, MSC/Cir.682
 - ITU-R M.489-2, M.493-10, M.541-8, M.689-2
 - IEC60945 (Ed.4), 61162-1 (July 2000)
 - EN300 338 (V1.2.1), 300 828 (V1.1.1), 300 698-1 (V1.3.1)
 - EN301 033 (V1.1.1), 301 925 (V1.1.1)
- Full-duplex communications: FM-8800D
- Precision PLL frequency synthesizer for high frequency stability as required for DSC operation
- Dual Watch and Multiple Watch
- Continuous DSC watch on CH70
- Prevention of accidental distress alert
- File editing for emergency readiness
- Automatic entry of own ship position with manual override

Program number

FM-8800D/FM-8800S: 0550215-02

SYSTEM CONFIGURATION

The FM-8800D/FM-8800S is a highly advanced 25 W VHF transceiver with DSC terminal. It is designed to satisfy the stringent requirements of marine communications, and complies with GMDSS carriage requirements for safety and general communications.

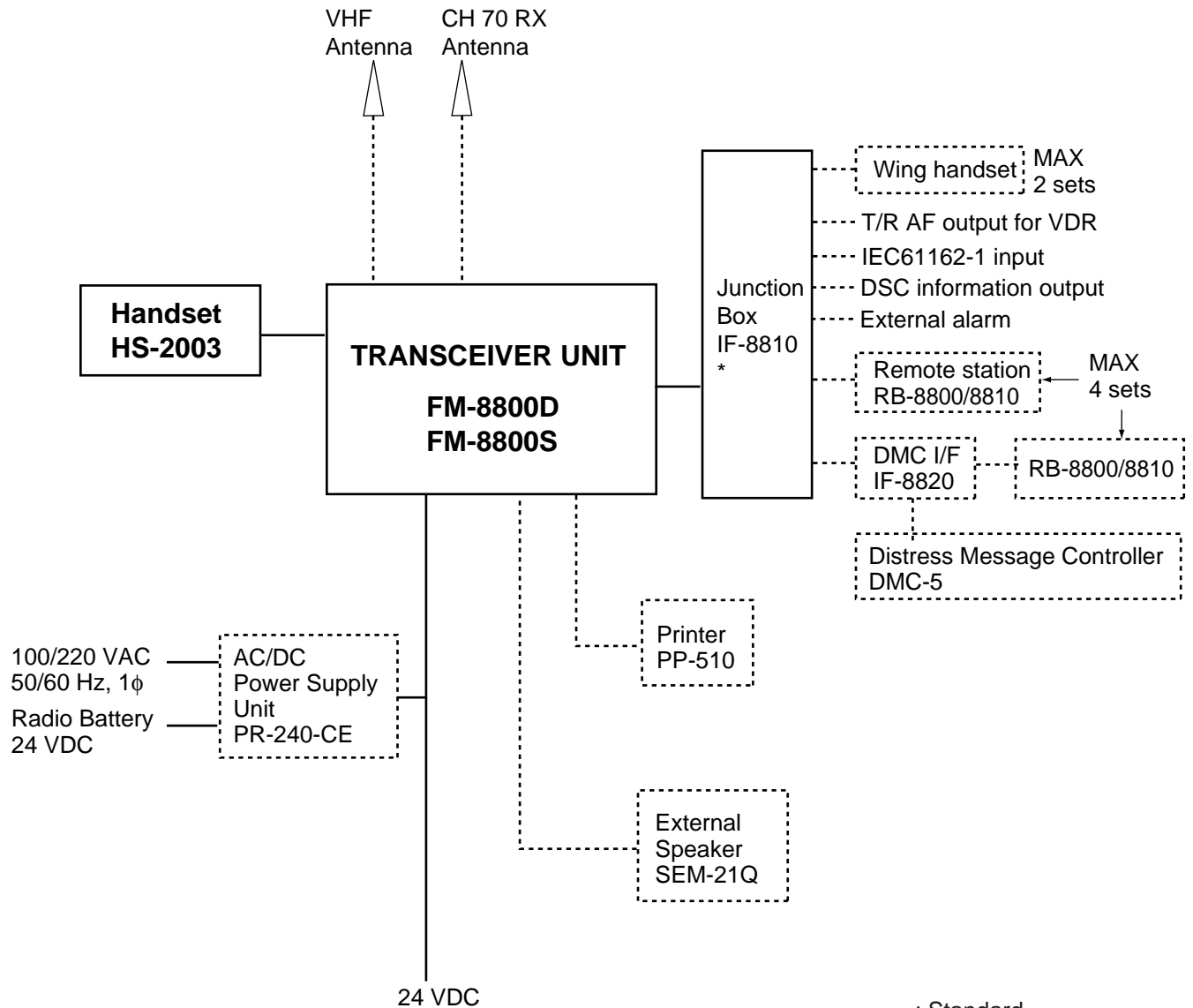

— : Standard
 - - - - : Option

Category of units

Unit	Category
Antenna	Exposed to weather
All other units	Protected from weather

*: Option for FM-8800S/D-N

FM-8800D/FM-8800S system configuration

This page is intentionally left blank.

SPECIFICATIONS OF MARINE VHF RADIOTELEPHONE FM-8800D/FM-8800S

1. GENERAL

- (1) Number of Channels INTL: 57
 USA: 55 (57)*
 Weather: 10
 Canada: 55 (57)*
 INLND-WA: 55 (57)*
 Private: 20 *: CH75&76 can be included
 MEMORY CH: 50 for some countries.
- (2) Frequency Stability Within ± 1.5 kHz
- (3) Communication System FM-8800S: Simplex/Semi-duplex
 FM-8800D: Simplex/Full-duplex
- (4) Class of Emission 16K0G3E (Voice)
 16K0G2B (DSC)
- (5) Antenna Impedance 50 ohms

2. TRANSMITTER

(1) Frequency Range

FM-8800S	Simplex	155.000 to 161.475 MHz
	Semi-duplex	155.000 to 161.475 MHz
FM-8800D	Simplex	155.000 to 158.000 MHz
	Full-duplex	155.000 to 158.000 MHz

- (2) Output Power 25 W max., 1 W at power reduction
- (3) Frequency Deviation ≤ 5 kHz

3. RECEIVER

(1) Frequency Range

FM-8800S	Simplex	155.000 to 159.600 MHz
	Semi-duplex	161.475 to 164.200 MHz
FM-8800D	Simplex	155.000 to 158.000 MHz
	Full-duplex	160.625 to 162.600 MHz

- (2) Receiving System Double Superheterodyne
- (3) Intermediate Frequency 1st: 51.2375 MHz, 2nd: 37.5 kHz
- (4) Sensitivity +6 dB μ V (20 dB SINAD)
- (5) Adjacent Channel Selectivity 70 dB or more
- (6) Spurious Response 70 dB or more
- (7) AF Output Built-in Speaker: 3 W (4 ohms)
 Handset earphone: 2mW (150 ohms)

4. DSC

- (1) Protocol ITU-R Rec. 541-8, 493-10 (class A)
- (2) Baud Rate 1200 baud ± 30 ppm max.
- (3) Modulation AFSK
- (4) Frequency Shift 1700 ± 400 Hz
 Mark: 1300 Hz, Space: 2100 Hz

5. CH70 WATCH RECEIVER

- (1) Receiving Frequency 156.525 MHz
- (2) Sensitivity Symbol error rate: Less than 1% (at 0 dB μ V)
- (3) Conducted Spurious Emission Less than 2 nW

6. POWER REQUIREMENTS

- (1) Power Supply 24 VDC (-10%/+30%)
- (2) Power Consumption

FM-8800S	Waiting	0.5 A
	Receive	1.6 A at 4 W audio output
	Transmit	1.6 A at 1 W output, 4.7 A at 25 W output
FM-8800D	Waiting	0.5 A
	Receive	1.6 A at 4 W audio output
	Transmit	2 A at 1 W output, 6 A at 25 W output
	DUP Transmit	3.6 A at 1 W output, 7.6 A at 25 W output

7. DIGITAL INTERFACE

IEC 61162-1 (NMEA0183 Ver.3)

Sentence IN: ZDA>GGA>RMC>GNS>GLL

OUT: TLL

Talker: GP>LC>DE>II>IN>EC

8. AMBIENT CONDITIONS

- (1) Temperature -15°C to 55°C (IEC60945)
- (2) Relative Humidity 93% (at 40°C)
- (3) Waterproofing (IEC 60529)
 - Transceiver Unit Chassis: IPX0
Panel: IPX4
 - Handset/Hanger HS-2003: IPX-4
 - Remote Box/Handset RB-8800: IPX-0
HS-8800: IPX-2
 - Junction Box IF-8810: IPX-0
 - DMC Interface IF-8820: IPX-0

9. COATING COLOR

- (1) Transceiver Unit Chassis: Munsell 2.5GY5/1.5
Panel: Munsell N3.0

1. OPERATIONAL OVERVIEW

The FM-8800D/FM-8800S system consists of a transceiver block and two antennas. The transceiver block contains a VHF transmitter, receiver, and channel 70 watch receiver module. FM-8800D additionally provides a duplexer block. All operations are controlled on its front panel.

1.1 Controls Keys and LCD Indication

1.1.1 Front panel

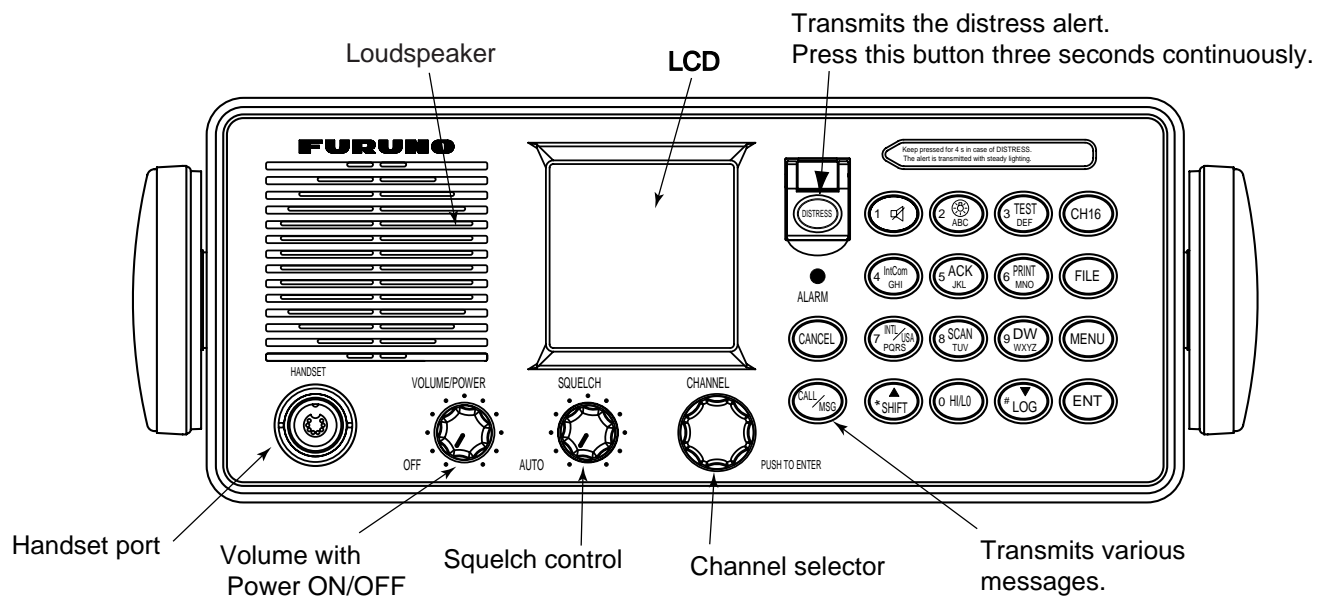

Transceiver unit

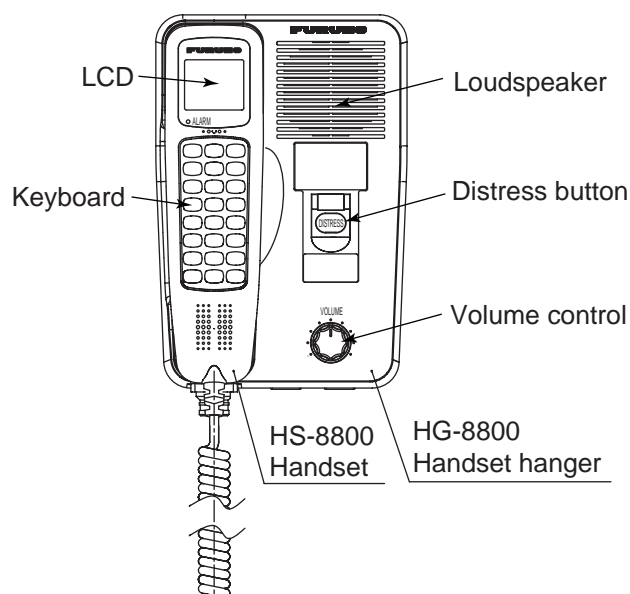



Remote station (option)

1.1.2 Controls

The functions of keys of the transceiver unit and the remote station are almost the same. The table below shows the controls and keys for the transceiver unit.

Control	Function
CHANNEL (PUSH TO ENTER)	<ul style="list-style-type: none"> • Selects a channel. • Moves the cursor in menu opened. • Registers selected item when pressed.
SQUELCH	<ul style="list-style-type: none"> • Mutes the receiver when no signal is present on the channel selected. • AUTO position automatically reduces white noise. • With the SHIFT key is pressed, adjust the contrast of the display.
VOLUME/POWER	<ul style="list-style-type: none"> • Turns the power on/off and adjusts the volume of the loudspeaker.
Key	Function
DISTRESS	<ul style="list-style-type: none"> • Transmits the distress alert after pressing three seconds. <p>When the key is pressed, the LED in the key blinks and the buzzer sounds. Pressing the key three seconds continuously the distress alert is transmitted and the LED lights continuously and buzzer also sounds continuously.</p> <p>These conditions are continued until the distress acknowledge is received or you cancel the distress alert.</p>
ALARM (INDICATOR)	<ul style="list-style-type: none"> • Blinks in red when a distress alert or urgent call is received. Also, the acoustic alarm sounds. To stop the blinking and silence the buzzer, press the CANCEL key. • Blinks in green when a safety call or routine call is received. The acoustic alarm sounds and stops automatically five seconds later.
CANCEL	<ul style="list-style-type: none"> • Stops audible and visual alarms. • Erases an error message. • Cancels numeric entry. • Returns to previous menu. • Cancels transmission or printing.
CALL MSG	<ul style="list-style-type: none"> • Transmits various DSC messages. To transmit a distress message, press this key more than three seconds.

<p>1</p> 	<ul style="list-style-type: none"> • Enters 1, ., ,, ", ;, ;, -, +, *, #, , (,), !, \$, &, / character at entry mode. • Turns the loudspeaker on or off. Pressing the SHIFT and then this key turns loudspeaker on or off. <p>In the off state, the loudspeaker icon appears. However, the key click activates and the alarm sounds when a distress or urgent call is activated.</p>
<p>2</p>  <p>ABC</p>	<ul style="list-style-type: none"> • Enters alphanumeric data (2, A, B, C, a, b, c). • Adjusts panel illumination when preceded by the SHIFT key.
<p>3</p> <p>TEST</p> <p>DEF</p>	<ul style="list-style-type: none"> • Enters alphanumeric data (3, D, E, F, d, e, f). • Performs the daily test when preceded by the SHIFT key.
<p>4</p> <p>IntCom</p> <p>GHI</p>	<ul style="list-style-type: none"> • Enters alphanumeric data (4, G, H, I, g, h, i). • Turns the interphone on or off when preceded by the SHIFT key and followed by ENT key. Available when a remote handset is connected.
<p>5</p> <p>ACK</p> <p>JKL</p>	<ul style="list-style-type: none"> • Enters alphanumeric data (5, J, K, L, j, k, l). • Turns auto acknowledge of routine calls on or off.
<p>6</p> <p>PRINT</p> <p>MNO</p>	<ul style="list-style-type: none"> • Enters alphanumeric data (6, M, N, O, m, n, o). • Prints communication files, current display and daily test result.
<p>7</p> <p>INT/USA</p> <p>PQRS</p>	<ul style="list-style-type: none"> • Enters alphanumeric data (7, P, Q, R, S, p, q, r, s). • Changes the channel mode among INTL, USA**, WX**, CANADA**, INLND-WA** and (MEMO)*. <p>*: If registered.</p> <p>** : Required system setting by qualified serviceman only.</p>
<p>8</p> <p>SCAN</p> <p>TUV</p>	<ul style="list-style-type: none"> • Enters alphanumeric data (8, T, U, V, t, u, v). • Turns the scan function on or off.
<p>9</p> <p>DW</p> <p>WXYZ</p>	<ul style="list-style-type: none"> • Enters alphanumeric data (9, W, X, Y, Z, w, x, y, z). • Turns the dual watch function on or off.

1. OPERATIONAL OVERVIEW

0 HI/LO	<ul style="list-style-type: none"> • Enters "0". • Changes the output power high (25 W) or low (1 W). However, the following channels are always 1 W. INTL mode: CH15, CH17, CH75, CH76 USA mode: CH13, CH17, CH67
▲ * SHIFT	<ul style="list-style-type: none"> • Press to activate secondary function. • Moves the screen to previous item. • Moves cursor backward for editor field.
▼ LOG #	<ul style="list-style-type: none"> • Displays transmitting/receiving messages. • Moves the screen to next item. • Moves cursor forward for editor field.
CH16	<ul style="list-style-type: none"> • Selects CH16 by one-touch action.
FILE	<ul style="list-style-type: none"> • Opens the Message file list.
MENU	<ul style="list-style-type: none"> • Opens the SETUP menu.
ENT	<ul style="list-style-type: none"> • Registers data input. (Same as pressing the CH selector.)

Additional keys of the handset HS-8800

Key	Function
⤴ (up arrow key)	<ul style="list-style-type: none"> • With the SHIFT key pressed, this key increases volumes of internal loudspeaker of remote station. • Increments channel number or setting value.
SQ ⤵	<ul style="list-style-type: none"> • Adjusts squelch level. • With the SHIFT key pressed, turns off the auto squelch.
⤴ (down arrow key)	<ul style="list-style-type: none"> • With the SHIFT key pressed, this key decreases volumes for internal loudspeaker of remote station. • Decrements channel number or setting value.
SQ auto ⤵	<ul style="list-style-type: none"> • Adjusts squelch level. • With the SHIFT key pressed, this key adjusts auto squelch level.

1.1.3 Indications on the LCD

Below are all the indications which appear on the standby display on the transceiver unit.

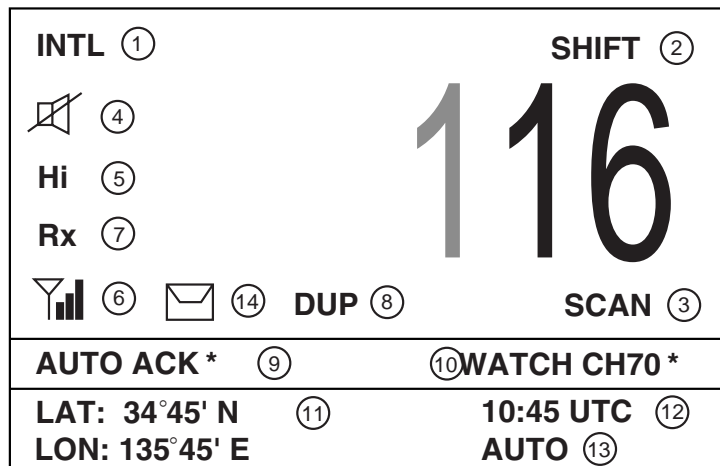

Standby display on the transceiver unit

Reference no.	Meaning
1	Displays the channel mode. (INTL / USA / WX / CANADA / INLND-WA / PRIV / (MEMO))
2	SHIFT is displayed if the shift function is active. Or channel mode (for example CANADA) is displayed at the MEMO mode.
3	Displays the scan mode: SCAN, DUAL or no display. During the scan mode, channel indications are changed alternatively. No display means that the unit receives continuously on the same channel.
4	Lights when the loudspeaker is off. Goes off when the loudspeaker is on.
5	Displays the transmission output. (Hi=25W / Lo=1W)
6	Displays reception signal strength by 4 steps. 1. No signal. Only antenna mark is displayed. 2. Less than 20 dB SINAD : antenna mark and short bar 3. 20 - 40 dB SINAD : antenna mark and two bars 4. 40 dB SINAD and more : antenna mark and three bars
7	RX is displayed during reception and TX is displayed when the RF signal detected at transmission state.
8	Displays the current channel. (PRIV channel: max three digits)
9	Is displayed when the DSC routine call is received. AUTO ACK: Automatic acknowledge MANUAL ACK: Manual acknowledge
10	WATCH CH70 or WATCH VHF is selected at menu. If the CH70 board is defective, WATCH CH70 NG appears. If no MMSI is registered, the message "DSC NOT USABLE" appears.
11	Displays the longitude and latitude of own ship.
12	Displays UTC time.
13	Displays AUTO for automatic data input (L/L, time data) from a navigation device or MANUAL for manual data input.
14	Displays when un-read message(s) exist.

*: "DISTRESS MODE" is displayed at distress calling.

1. OPERATIONAL OVERVIEW

Below are the indications which appear on the standby display on the remote handset.

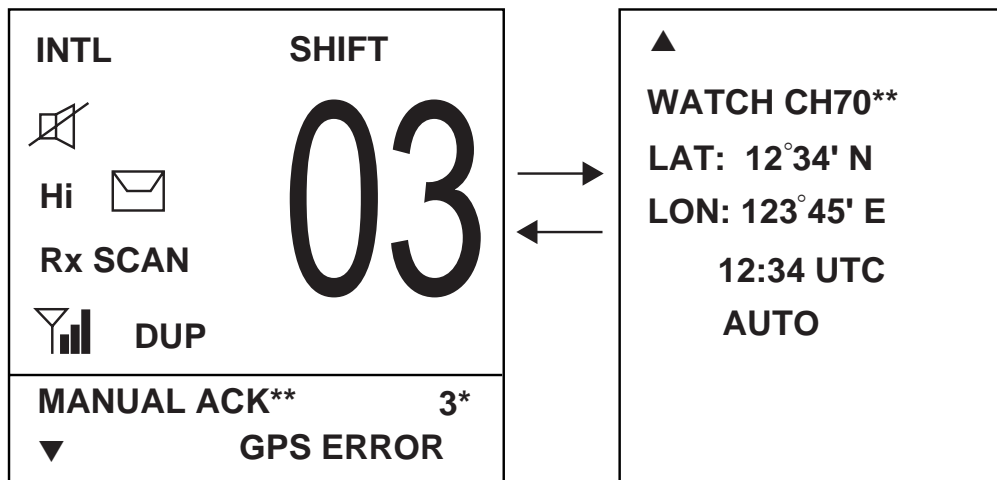

If you press  at the left-hand screen, right-hand screen appears.

If you press  at the right-hand screen, the left-hand screen appears immediately.

The indications are the same as those on of the transceiver unit.

The *- marked number is the terminal number of the remote station.

** : If no MMSI is registered, the message "DSC UNAVAIL" appears instead of MANUAL ACK and WATCH CH70. "DISTRESS MODE" is displayed at distress calling.

Note: The screen of the remote handset is smaller than the one of the transceiver unit. In this manual, display examples are from the transceiver unit. In the remote handset, scrolling with up or down arrow key displays same information as the screen of the transceiver unit.

1.1.4 Audio alarms

When you receive a distress alert or other DSC call, the audible and visual alarms are released. For the distress or urgency call, the audio alarm sounds until the **CANCEL** key is pressed. For all other calls, the audible alarm sounds for two minutes and the automatically goes off. The tone of the alarm changes with the call received. By becoming accustomed to the tone, you can know which type of call you have received.

Alarm	Frequency (interval)
Safety call received	1300 Hz and 0 Hz (250 ms)
Routine, Ship's Business call received	880 Hz and 440 Hz (500 ms)
While DISTRESS key is pressed for three seconds	2200 Hz and 0 Hz (125 ms)
Distress alert sent	2200 Hz, continuous
Own ship position not updated	2200 Hz (50 ms), three beeps every two seconds
Distress alert, urgency message received	1300 Hz and 2200 Hz (250 ms)
Message received from terrestrial telephone line	750 Hz and 650 Hz (50 ms) 10 times Repeat OFF one second

1.2 VHF Basic Operation

1.2.1 Turning the power on and adjusting contrast

To turn the power on, turn the VOLUME control clockwise until you hear a click. To adjust the contrast of the display, press the **SHIFT** key, and then rotate the **CHANNEL** knob or press the ▼ or ▲ key. To turn the power off, turn the control fully counterclockwise until you hear the click.

1.2.2 Selecting channel modes, channels

Selecting channel modes

To change the channel mode, press the **SHIFT** key immediately followed by the **7 INT/USA** key several times until desired mode is displayed. The following modes are available.

INTL : International mode
 USA : USA mode
 WX : Weather channel mode
 CANADA : CANADA mode
 INLND-WA : Rhine river mode (USED ON INLAND Waterways)
 PRIV : Private channel
 MEMO : Memory channel mode if registered

Note: Private channels are available only where permitted by the authorities. The USA/WX, CANADA, INLND-WA, PRIV can also be set by a qualified serviceman.

Selecting channels

Rotate the CH selector clockwise (counterclockwise) to display desired channel.

1.2.3 Adjusting volume of loudspeaker

The VOLUME control adjusts the volume of the loudspeaker.

1.2.4 Adjusting squelch

The **SQUELCH** control adjusts the squelch threshold level. Adjust it so that white noise heard in the loudspeaker just fades out. Perform this operation when no traffic is being received. AUTO squelch automatically reduces white noise. Usually select the AUTO position. Avoid turning the squelch too far clockwise — you may miss a long distance communication.

Note: To obtain correct scan watch/dual watch response, adjust the **SQUELCH** control precisely.

1.2.5 Transmitting

Press the PTT (Push-to-talk) switch on the handset or microphone to talk, and release it to listen for the response. The VHF section keyboard accepts no key input when the PTT switch is operated.

Remarks on transmitting

- Before transmitting, think about the subjects which have to be communicated and, if necessary, prepare written notes to avoid unnecessary interruptions and ensure that no valuable time is wasted on a busy channel.
- Listen before commencing to transmit to make certain that the channel is not already in use.

1.2.6 Selecting output power

After pressing the **SHIFT** key, each press of the **0 HI/LO** key selects high or low output power. Also Hi or Lo appears on the screen depending on your selection.

The transmitter power is automatically set for low on the following channels:

International: CH15, CH17, CH75, CH76

USA: CH13, CH17, CH67, CH77; to operate USA channel 13 or 67 in high power, keep **HI/LOW** key pressed while talking into the handset.

1.2.7 Turning the loudspeaker on/off

To turn the loudspeaker on/off, press the **SHIFT** key, then the **1** key. The loudspeaker off mark appears when the speaker is off. The loudspeaker is automatically turned off when the handset is used.

1.2.8 Quick selection of CH16

Press the **CH16** key to select CH16, the International Calling and Safety Channel. The use is limited to distress, safety and calling. The transmission on CH16 (156.800 MHz) should be limited to within 1 minute except for distress calling.

Avoid calling on CH16 for purposes other than distress, urgency and very brief safety communications when another calling channel is available.

1.2.9 Dual watch

The dual watch function permits watch on CH16 and another selected channel. CH16 and another channel are watched at intervals of 0.15 seconds and one second, respectively.

To start dual watch, first select the other frequency to watch and then press the **SHIFT** key and **9 DW** key in that order. When the receiver finds a signal on CH16, it locks on it and restarts dual watching after the signal on CH16 has gone. If another channel has traffic, it still continues dual watch. The speech is heard intermittently. If you are annoyed with the intermittence, turn off the dual watch by pressing the PTT switch on the handset or pressing the **SHIFT** and **9 DW** key again.

1.2.10 Scanning

The receiver scans all channels at intervals of 0.15 seconds in the selected channel mode in ascending channel order, watching CH16 between channels as below:

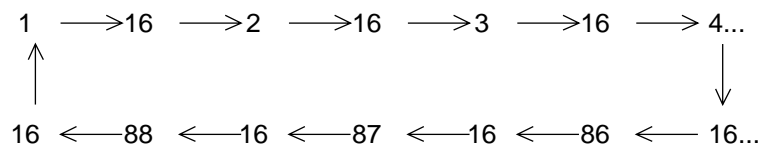

To start scanning, press the **SHIFT** and **8 SCAN** in that order. When the receiver finds a signal, scanning is stopped on that channel and starts dual watch on it and CH16.

To turn off the scanning, press the PTT switch or press the **SHIFT** and **8 SCAN** key.

1.2.11 Remarks on voice communications

Automatic acknowledge (DSC operation) is automatically changed to manual acknowledge when voice communications begin. (The “auto” indication, however, remains on the screen.) This is done to prevent a break in communications. Automatic acknowledge is automatically restored once voice communications are terminated.

1.3 DSC Operational Overview

Digital Selective Calling (DSC) is the global calling system adopted by the ITU-R and IMO for selective calling of coast station and ship radio stations. The DSC system is used for both safety and routine calling. The GMDSS requires the use of DSC for distress alerting and safety calls.

1.3.1 LED warnings

The LED below the **DISTRESS** key lights continuously when the distress signal is transmitted.



The ALARM LED blinks in red (and alarm sounds) when a distress or urgent message is received. The LED can be extinguished and alarm silenced by pressing the **CANCEL** key.

The ALARM LED blinks in green (and alarm sounds) when a message other than distress or urgent is received. Alarm is automatically silenced two minutes after message is received.



1.3.2 DSC operational overview

Standby display

When the FM-8800D/S is turned on, the following display appears. This display is known as the “standby display.” This is where you will begin most operations.

INTL SCAN	SHIFT	
		116
Hi		
RX		
 		SCAN
AUTO ACK	WATCH CH70	
LAT: 34° 45' N	10:17 UTC	
LON: 135° 45' E	AUTO	

Standby display (Transceiver unit)

INTL	SHIFT	
		116
Hi 		
RX SCAN		
		
MANUAL ACK	1	
▼ VOL 5 SQ	2	

Standby display (Remote handset)

(Press the down arrow key of the remote handset to view rest of screen.)

If you get lost in operation you can return to the standby display by pressing the **CANCEL** key several times.

Note: In this manual, screen examples show the transceiver’s screens. To get the same information on the handset screen, press down or up arrow key.

Preparing and transmitting DSC messages

There are two methods by which you can prepare and transmit DSC messages, and they are shown below.

- Preparing message for immediate transmission

1. Press the **CALL** key at the standby display.
2. Select the call type.
3. Select other party (ID) if necessary.
4. Select the communications category.
5. Select the communications channel.
6. Press the **CALL** key more than three seconds.

- Transmitting a message stored in the memory

100 messages can be saved to the memory. You may open a memory-stored message and transmit it.

Distress alert transmission and output power

When the distress alert is transmitted (by pressing the **DISTRESS** key), the output power of the FM-8800D/S is automatically set to maximum (25 W).

When keyboard input is prohibited

DSC-related controls cannot be operated while a DSC message is being transmitted. (These controls are inoperative about 3 seconds during a DSC distress call; 0.5 seconds for other DSC calls.)

1.3.3 Automatic acknowledge on/off

The automatic acknowledge feature of the DSC/watch receiver automatically transmits the acknowledge back (ACK BQ) signal to the sending station when an individual, position or polling call is received. (For position and polling calls, respective item on the AUTO ACK menu must be turned on to enable automatic acknowledge.) Automatic acknowledge can be turned on or off at the standby display by pressing the **SHIFT** and **5** keys in this order.

The message AUTO ACK or MANUAL ACK appears at the bottom of the standby display with each press of the keys.

Note 1: To give priority to own ship's communications while own ship is communicating, show MANUAL ACK by the above procedure.

Note 2: Automatic acknowledge is not possible under the following conditions:

Priority:	Distress, Urgency or Safety
Com Type:	Fax, Data, No Info
Com Freq:	No Info
Off Hook	

1.4 Priority

If one or more remote stations are installed, the transceiver unit (main unit) has the highest priority. You can interrupt remote station operation at any time with the handset of the main unit. When you hook off the handset of the main unit, "OCCUPIED FM8800" (default. This may be change. See section 5.3) is indicated on all remote stations.

Each remote station has its own priority. The remote station ID (1-4) indicates its priority. The priority of the system is as follows.

DSC of main unit > Wing handset > Handset of main unit > 1 > 2 > 3 > 4

If you hook off No.4 remote station, for example, "Occupied Handset.4" is displayed on other remote stations. However, you can hook off and use No.1 handset.

How to set priority of the remote station

1. Disconnect the plug of a remote station to turn off the remote station.
2. While pressing the **MENU** key of a remote station, connect the plug to turn on the power.

Version No. 0550216-01.00 Now ID=01 Input New ID (1-4)=

3. Press **1**, **2**, **3**, or **4** key on the remote handset as appropriate followed by the **ENT** key. Never enter same number among different remote stations.
4. Turn off and on the power of the transceiver unit.

2. DSC DISTRESS COMMUNICATION

2.1 Distress Alert Transmission from the DISTRESS Key

If a distress situation occurs, do as follows:

1. Open the **DISTRESS** key cover and press the **DISTRESS** key more than three seconds. The alarm sounds and the red lamp in the key blinks. The lamp will light steadily three seconds later and at the same time the distress alert is transmitted for three seconds.

The screen changes as follows.

- 1) When the **DISTRESS** key is pressed and held down,

** Compose Message **
CALL TYPE: DISTRESS NATURE: UNDESIGNATED POS : 12° 34'N 123° 45'E AT : 12 : 34
Distress button Pressed!
KEEP PRESSED FOR 3S

- 2) After the timer counts down to zero, "distress call in progress" is announced.

** Compose Message **
CALL TYPE: DISTRESS NATURE: UNDESIGNATED POS : 12° 34'N 123° 45'E AT : 12 : 34
Distress Call in Progress on CH70.

- When the distress is transmitted (called Distress Mode), you can communicate with the handset of the remote station.
- In the distress mode, the CALL, FILE and MENU keys are inoperative.
- To return to normal mode from the distress mode, turn the power off and on again.

2. DSC DISTRESS COMMUNICATION

- 3) The screen changes to “distress acknowledge (DIST ACK) waiting” display. In this condition, distress communication with CH16 may be possible.

** Compose Message **
CALL TYPE: DISTRESS NATURE: UNDESIGNATED POS : 12° 34'N 123° 45'E AT : 12 : 34
Waiting for distress acknowledgement. CH16 Now available.
TIME TO GO : 4M 12S

- 4) When the DIST ACK is received,

Distress acknowledge received.
FROM : 003456789 ID IN DIST : 123456789 TCmd : DISTRESS ACK NATURE : UNDESIGNATED POS : 12° 34'N 123° 45'E AT : 12 : 34 SIMP TP
CANCEL ALARM

Note: If you do not receive the distress alert acknowledge call, during 3.5 to 4.5 minutes the equipment automatically re-transmits the distress alert and then awaits the distress alert acknowledge call. This is repeated until the distress alert is acknowledged.

2. Press the **CANCEL** or **ENT** key. The screen changes as follows.

** Received Message **
APR08/'04 18:30 ECC : OK DISTRESS ACK FROM : 003456789 ID IN DIST : 123456789 TCmd : DISTRESS ACK NATURE : UNDESIGNATED POS : 12° 34'N 123° 45'E AT : 12 : 34 SIMP TP
PRESS ENT

3. Press the **ENT** key. The standby display with CH16 and Hi appears.
4. Provide the following information to the coast station, using a handset on the transceiver unit or remote stations (if connected):

Distress communication

- (1) Press the PTT switch and speak slowly and distinctly, "MAYDAY, MAYDAY, MAYDAY," pronounced as the French expression "m'aider."
- (2) This is; "the name of your vessel and call sign" three times.
- (3) "MAYDAY"
- (4) This is; "the name of your vessel and call sign."
- (5) Position in latitude and longitude;
- (6) The nature of the distress;
- (7) The kind of assistance desired;
- (8) Number of persons on board;
- (9) Any other information which might facilitate rescue, for example, length, color, and type of vessel.
- (10) Indicate the end of message by saying "Over."

Some countries do not have sea area "A1." In this case "ACK" from the coast station does not arrive over DSC. A ship nearby will contact the vessel in distress over CH16. After transmitting the distress alert, conduct voice distress communications as shown above.

2.2 Distress Alert Transmission with Nature of Distress

If you want to transmit the distress alert with nature of distress specified, do as follows:

1. Open the **DISTRESS** key cover and press the **DISTRESS** key momentarily. The alarm sounds and the red lamp in the key blinks and after releasing the key within three seconds the alarm stops and the red lamp goes off. The following screen appears.

** Compose Message **

CALL TYPE : DISTRESS

NATU	UNDESIGNATED
POS	Fire
AT : 1	Flooding
SIMP	Collision
	Grounding
	▼ Listing

2. DSC DISTRESS COMMUNICATION

2. Rotate the channel knob to choose the nature of distress. On the remote handset, press the up or down arrow key.

UNDESIGNATED Fire Flooding Collision Grounding ▼ Listing	▲ Sinking Disabled & Adr Abandoning Piracy Man over board
--	---

3. Press the **ENT** key. The screen changes as follows.

** Compose Message **
CALL TYPE : DISTRESS NATURE : Flooding POS : 34° 41' N 134° 30' E AT : 08 : 00 SIMP TP

The own ship's position and current time in UTC are displayed if your FM-8800D/S is connected to a navigation equipment, for example, GPS.

4. Press the **DISTRESS** key more than three seconds.

** Compose Message **
CALL TYPE: DISTRESS NATURE: Flooding POS : 12° 34'N 123° 45'E AT : 12 : 34 Distress button Pressed!
KEEP PRESSED FOR 3S

The distress alert with nature of distress, ship's position and time are transmitted. The sequence of display and procedures are the same as in paragraph 2.1.

2.3 Distress Alert Transmission from CALL Key

You can transmit the distress alert with nature of distress by using **CALL** key.

1. Press the **CALL** key.

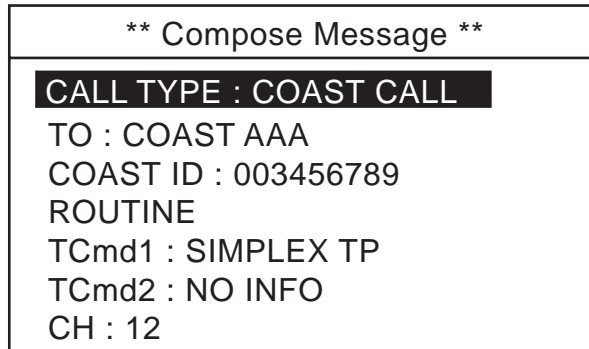

Transceiver unit screen

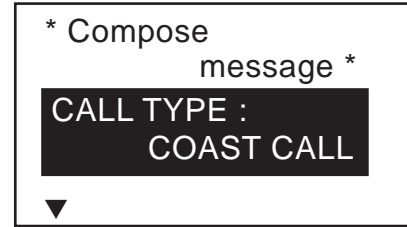

Remote handset screen

2. Press the **ENT** key to show the call type selection window.

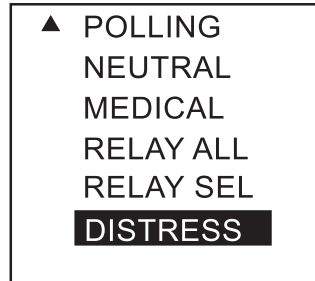
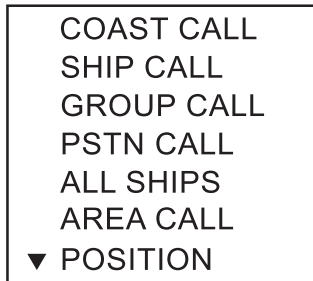

3. Rotate the CH knob (or press up / down arrow key) to choose DISTRESS. Press the **ENT** key.

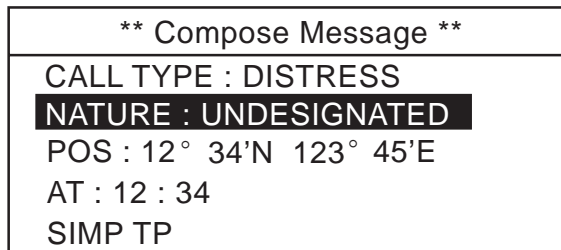

4. Press the **ENT** key to display the distress nature list.

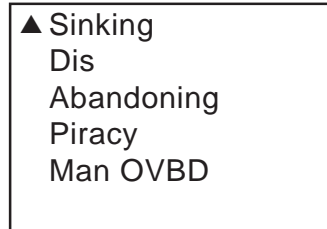
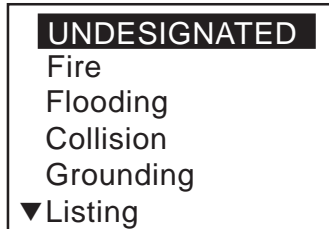

2. DSC DISTRESS COMMUNICATION

5. Rotate the CH knob (or press up / down arrow key) to choose nature of distress and press the **ENT** key.

** Compose Message **
CALL TYPE : DISTRESS NATURE : Abandoning POS : 12° 34'N 123° 45'E AT : 12 : 34 SIMP TP

6. Press the **ENT** key to show the position setup window.

INPUT TYPE : AUTO LAT : 34° 41'N LON : 134° 30'E TIME : 08 : 00
--

If a position fixing device is not connected, press the **ENT** key, choose Manual and enter your position.

AUTO MANUAL* NO INFO

*: MANUAL can not be chosen if position data is input.

7. After confirming the ship's position and time, press the **DISTRESS** key more than three seconds to transmit the distress alert.

2.4 Canceling a False Distress Alert

If you have transmitted a distress alert by mistake, do the following to cancel it .

1. Switch off equipment immediately.
2. Switch equipment on and set to Channel 16.
3. Transmit message to "All Stations" giving your vessel's name, call sign and DSC number.

Example message

All Stations, All Stations, All Stations
This is VESSEL'S NAME, CALLSIGN,
DSC NUMBER, POSITION.

Cancel my distress alert of DATE, TIME, UTC.
=Master, VESSEL'S NAME, CALLSIGN.
DSC NUMBER, DATE, TIME UTC.

2.5 Receiving Distress Alert from Other Vessel, Transmitting DIST ACK Signal

In no case is a ship permitted to transmit a DSC distress relay call upon receipt of a DSC distress alert on VHF channel 70.

Procedure when in area A1

1. When the FM-8800D/8800S receives a distress alert from another vessel, the ALARM LED (red) blinks and the FM-8800D/8800S sounds the distress alarm.
2. Silence the alarm by pressing the **CANCEL** key.
3. Wait up to five minutes until the DIST ACK signal from a coast station is received. Be prepared to follow the instructions of the coast station.
4. If you do not receive the DIST ACK signal, follow the flow chart shown on page 2-8 to determine if your vessel should acknowledge a distress alert.

If further DSC alerts are received from the same source and the ship in distress is beyond doubt in the vicinity, a DSC acknowledgement may, after consultation with an Rescue Co-ordination Center (RCC) or Coast Station, be sent to terminate the distress call.

Note 1: An asterisk (*) in a received distress alert message indicates error or unknown at the location marked with the asterisk.

Note 2: Do not send DIST ACK in response to receipt of distress alert having the nature of distress as "EPIRB emission".

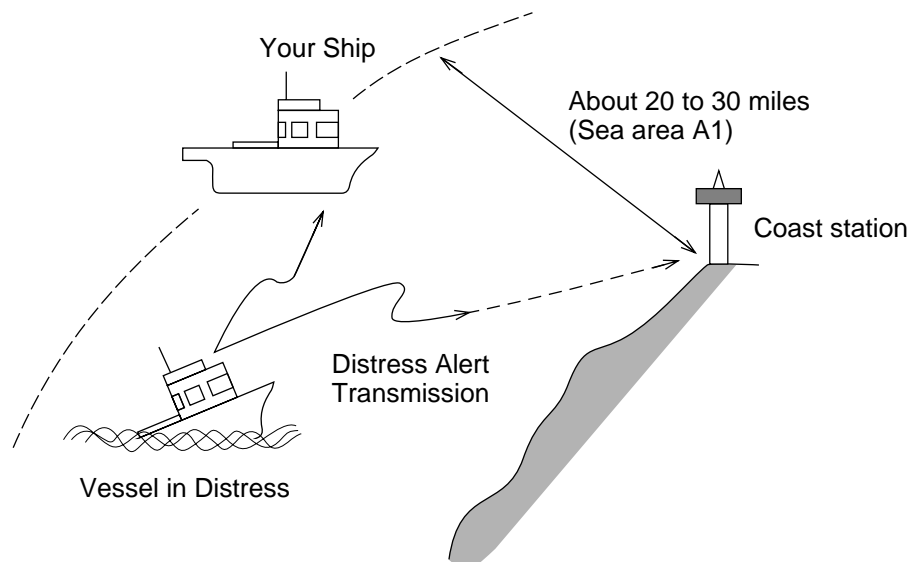

Receiving distress alert from other vessel

2. DSC DISTRESS COMMUNICATION

Flow chart for determining if you should/should not transmit DIST ACK signal

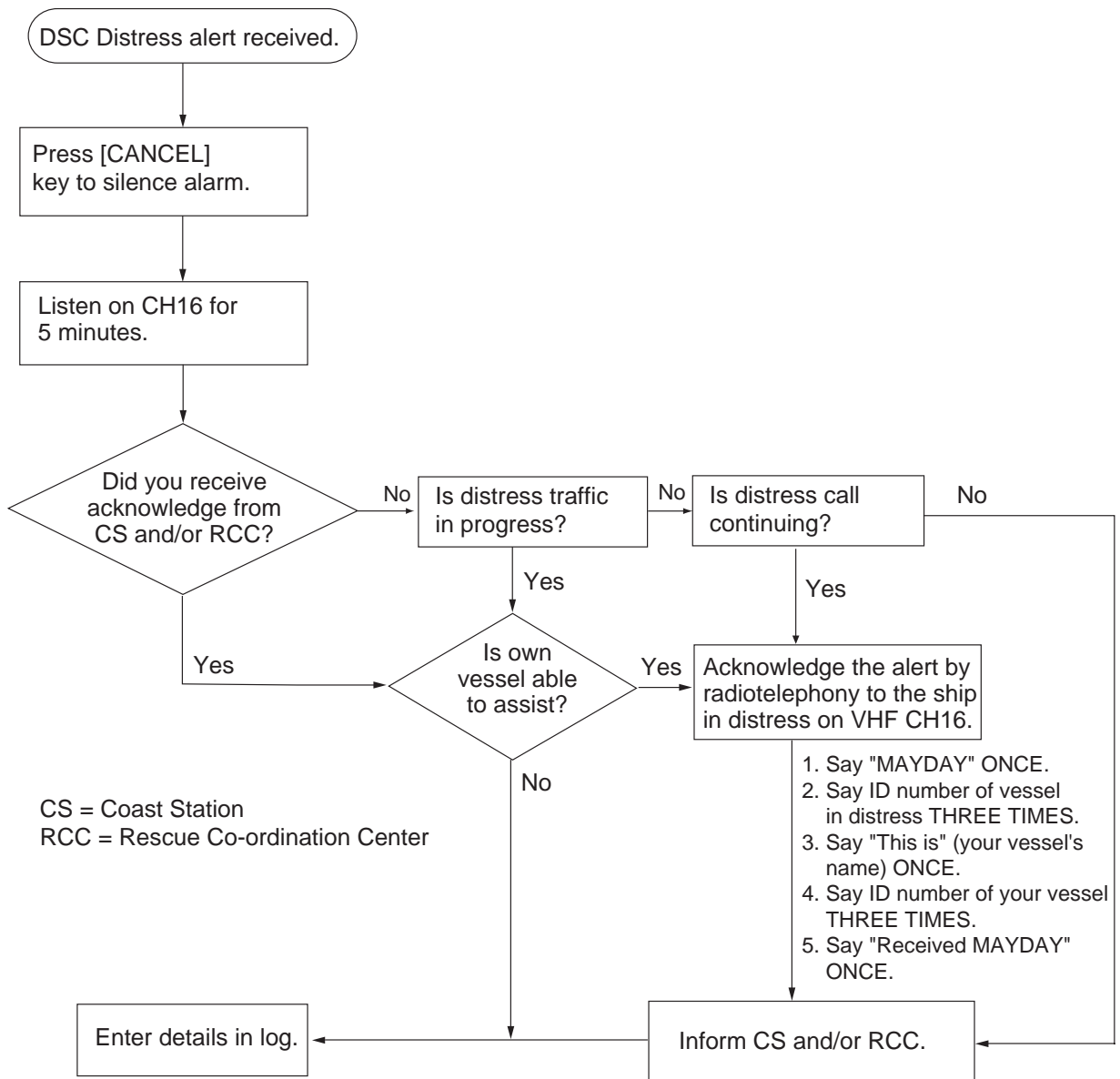

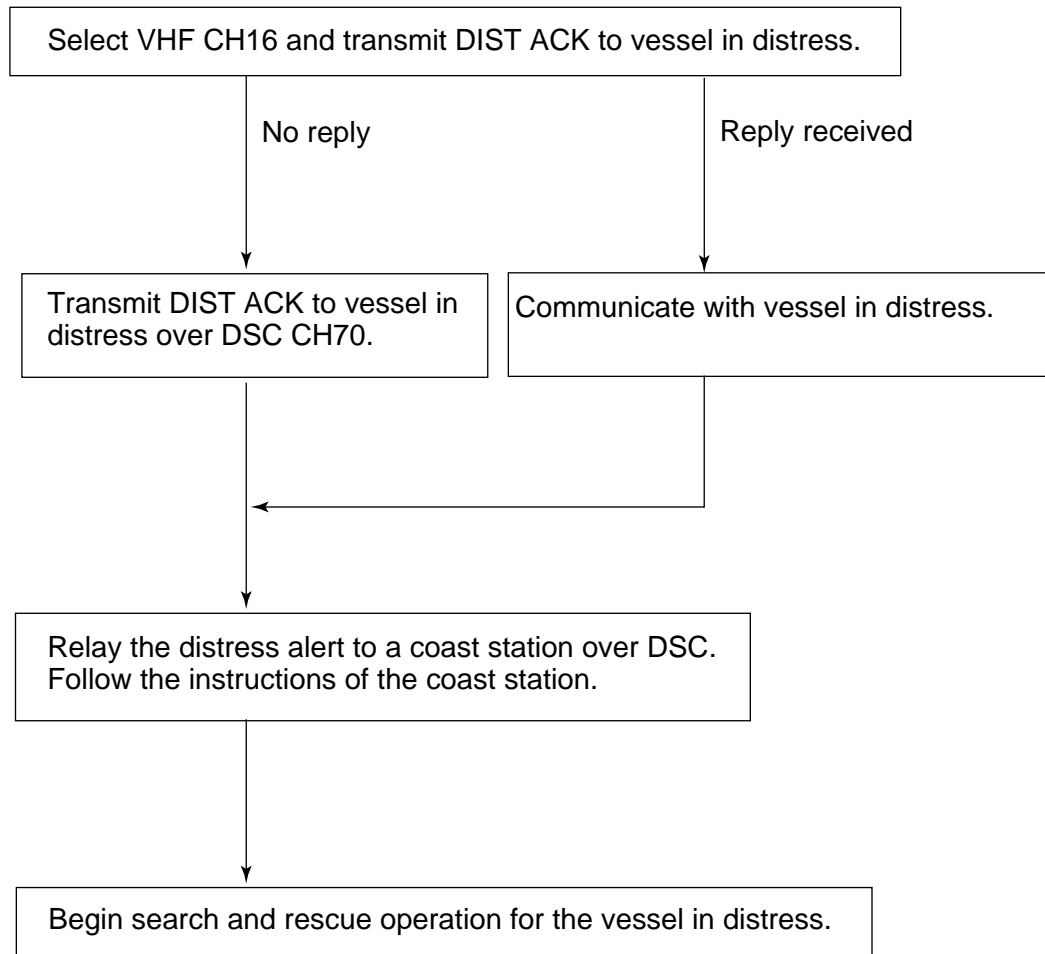
Transmitting DIST ACK over CH16**Transmitting DIST ACK signal**

If your vessel meets the requirements necessary to transmit the DIST ACK signal, do the following:

When a distress alert from other ship is received, the following screen appears. The alarm sounds and the ALARM lamp blinks.

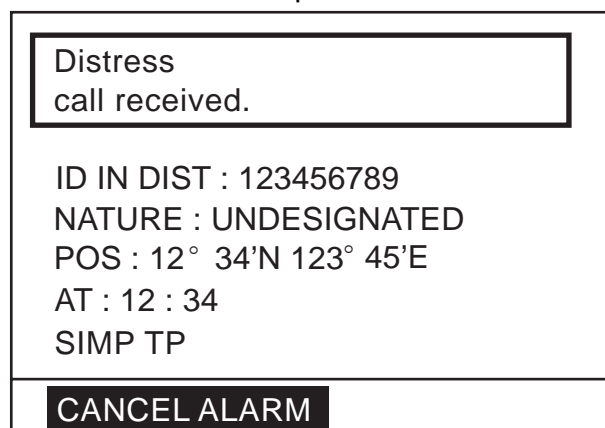

2. DSC DISTRESS COMMUNICATION

1. Press the **CANCEL** or **ENT** key to silence the alarm. The following message appears.

** Received Message **
MAY10'04 08:03 ECC : OK DISTRESS ID IN DIST : 123456789 NATURE : UNDESIGNATED POS : 12° 34'N 123° 45'E AT : 12 : 34 SIMP TP
PRESS ENT TO ACK

2. If you do not receive DIST ACK from coast station within five minutes and your vessel meets requirements (see previous page) for transmitting DIST ACK, press the **ENT** key, and then press the **CALL** key more than three seconds to transmit the DIST ACK.

** Send Message **
DISTRESS ACK TO : 123456789 TCmd : DISTRESS ACK NATURE : UNDESIGNATED POS : 12° 34'N 123° 45'E AT : 12 : 34 SIMP TP
PRESS CALL TO SEND

After transmitting the DIST ACK, the standby display appears.

After transmitting DIST ACK

Begin search and rescue operations for the vessel in distress, communicating with the vessel over CH16 (automatically set). Relay distress alert to coast station by DSC following the instruction in the next paragraph. Finally, follow the instructions of the coast station.

2.6 Sending Distress Relay on Behalf of a Ship in Distress

When you should relay a distress alert

You may relay a distress alert in the following conditions:

- 1) When the station in distress is not itself in a position to transmit the distress message, or
- 2) When the master or person responsible for the vessel not in distress, or the person responsible for the coast station, considers that further help is necessary.

DO NOT press the DISTRESS key to relay a distress alert; it is for use when own vessel is in distress.

2.6.1 Sending distress relay to coast station

1. Press the **CALL** key. The [Compose message] screen appears.

** Compose Message **
CALL TYPE : COAST CALL COAST ID : 00 ROUTINE TCmd1 : SIMPLEX TP TCmd2 : NO INFO CHANNEL : 10

2. Press the **ENT** key. The CALL TYPE selection window appears.
3. Rotate the CH knob (or press up / down arrow key) to choose RELAY SEL.

COAST CALL SHIP CALL GROUP CALL PSTN CALL ALL SHIPS AREA CALL ▼ POSITION	▲ POLLING NEUTRAL MEDICAL RELAY ALL RELAY SEL DISTRESS
--	--

2. DSC DISTRESS COMMUNICATION

4. Press the **ENT** key.

** Compose Message **
CALL TYPE : RELAY SEL COAST ID : 00 ID IN DIST : NO INFO TCmd : DISTRESS RELAY NATURE : UNDESIGNATED POS : 12° 34'N 123° 45'E AT : 12 : 34 SIMP TP

5. Press the **ENT** key again. The COAST ID entry window appears.
6. Key in a coast station ID with numeric keys and press the **ENT** key.
7. Press the **ENT** key again. The ID IN DIST entry window appears.
8. Key in the ID number of ship in distress with numeric keys and press the **ENT** key. If you do not know the ID, simply press the **ENT** key without entering ID; NO INFO is displayed.
9. Press the **ENT** key and the list of distress nature appears.
10. Rotate the CH knob to choose a nature of distress (if known) and press the **ENT** key twice. If you do not know the nature of distress, choose UNDESIGNATED.

INPUT TYPE : AUTO LAT : 34° 41'N LON : 134° 30'E TIME : 08 : 00
--

11. Enter position of the ship in distress, following 1), 2) or 3) below.

AUTO MANUAL NO INFO

- 1) For automatic input, press the **ENT** key twice. Go to step 12.
- 2) For manual input, press the **ENT** key to open the INPUT TYPE menu, rotate the CH knob to choose MANUAL and then push the **ENT** key. Enter latitude and longitude of ship in distress and time as follows:
 - a) Enter latitude and then press the **ENT** key.
 - b) Enter longitude and then press the **ENT** key.
 - c) Enter UTC time and then press the **ENT** key. Go to step 12.
- 3) If you cannot confirm position of ship in distress, press the **ENT** key to open the INPUT TYPE menu, rotate the CH knob to choose NO INFO and then press the **ENT** key. Go to step 12.

12. Press the **CALL** key more than three seconds to transmit the distress relay.

** Compose Message **	
CALL TYPE : RELAY SEL	
COAST ID : 003456789	
ID IN DIST : NO INFO	
TCmd : DISTRESS RELAY	
NATURE : UNDESIGNATED	
POS : 12° 34'N 123° 45'E	
AT : 12 : 34	
SIMP TP	
KEEP PRESSED FOR 3S	←

When CALL key is pressed, this message appears and timer counts down.

The message will be transmitted and "Waiting for acknowledgement" will appear.

2.6.2 Sending distress relay to all ships

1. Press the **CALL** key. The [Compose message] screen appears.

** Compose Message **	
CALL TYPE : COAST CALL	
COAST ID : 003456789	
ROUTINE	
TCmd1 : SIMPLEX TP	
TCmd2 : NO INFO	
CHANNEL : 10	

2. Press the **ENT** key. The CALL TYPE selection window appears.

3. Rotate the CH knob (or press up / down arrow key) to choose RELAY ALL.

COAST CALL SHIP CALL GROUP CALL PSTN CALL ALL SHIPS AREA CALL ▼ POSITION	▲ POLLING NEUTRAL MEDICAL RELAY ALL RELAY SEL DISTRESS
--	--

4. Press the **ENT** key.

** Compose Message **
CALL TYPE : RELAY ALL ID IN DIST : NO INFO TCmd : DISTRESS RELAY NATURE : UNDESIGNATED POS : 12° 34'N 123° 45'E AT : 12 : 34 SIMP TP

5. Press the **ENT** key again. The ID IN DIST entry window appears.
6. Key in the ID number of ship in distress with numeric keys and press the **ENT** key. If you do not know the ID, simply press the **ENT** key without entering ID; NO INFO is displayed.
7. Press the **ENT** key and the list of distress nature appears.
8. Rotate the CH knob (or press up / down arrow key) to choose a nature of distress (if known) and press the **ENT** key twice. If you do not know the nature of distress, choose UNDESIGNATED.

INPUT TYPE : AUTO LAT : 34° 41'N LON : 134° 30'E TIME : 08 : 00

9. Enter position of the ship in distress, following 1), 2) or 3) below.

AUTO MANUAL NO INFO

- 1) **For automatic input**, press the **ENT** key twice. Go to step 10.
- 2) **For manual input**, press the **ENT** key to open the INPUT TYPE menu, rotate the CH knob to choose MANUAL and then push the **ENT** key. Enter latitude and longitude of ship in distress and time as follows:
 - a) Enter latitude and then press the **ENT** key.
 - b) Enter longitude and then press the **ENT** key.
 - c) Enter UTC time and then press the **ENT** key. Go to step 10.
- 3) **If you cannot confirm position of ship in distress**, press the **ENT** key to open the INPUT TYPE menu, rotate the CH knob to choose NO INFO and then press the **ENT** key. Go to step 10.

10. Press the **CALL** key to transmit the call.

** Compose Message **	
CALL TYPE : RELAY ALL	
ID IN DIST : NO INFO	
TCmd : DISTRESS RELAY	
NATURE : UNDESIGNATED	
POS : 12° 34'N 123° 45'E	
AT : 12 : 34	
SIMP TP	
KEEP PRESSED FOR 3S	←

When CALL key is pressed, this message appears and timer counts down.

After the call is transmitted, the standby display appears.

2.7 Receiving Distress Relay

2.7.1 Receiving distress relay all call

If you receive a distress relay for all ships, continue monitoring CH16.

1. When a distress relay all ships call is received, the audio alarm sounds and the display looks like the one below.

Distress relay all call received.
FROM : 123456789
ID IN DIST : 234567890
TCmd : DISTRESS RELAY
NATURE : UNDESIGNATED
POS : 12° 34'N 123° 45'E
AT : 12 : 34 SIMP TP
CANCEL ALARM

2. DSC DISTRESS COMMUNICATION

2. Press the **CANCEL** key or **ENT** key to silence the alarm and the display changes as below.

* Received Message *
APR01/ 04 12 : 34 ECC : OK DISTRESS RELAY ALL FROM : 123456789 ID IN DIST : 234567890 TCmd : DISTRESS RELAY NATURE : UNDESIGNATED POS : 12° 34'N 123° 45'E AT : 12 : 34 SIMP TP
PRESS ENT

3. Press the **ENT** key to return to the standby display with CH16.
4. Watch CH16.

2.7.2 Receiving distress relay from coast station

If you receive a distress relay call from a coast station, continue monitoring CH16.

1. When a distress relay call from a coast station is received, the audio alarm sounds and the display looks like the one below.

Distress relay all call received.
FROM : 003456789 ID IN DIST : 123456789 TCmd : DISTRESS RELAY NATURE : UNDESIGNATED POS : 12° 34'N 123° 45'E AT : 12 : 34 SIMP TP
CANCEL ALARM

2. Press the **CANCEL** key to silence the alarm and the display changes as below.

** Received Message **
APR01/ 04 12 : 34 ECC : OK DISTRESS RELAY ALL FROM : 003456789 ID IN DIST : 123456789 TCmd : DISTRESS RELAY NATURE : UNDESIGNATED POS : 12° 34'N 123° 45'E AT : 12 : 34 SIMP TP
PRESS ENT

3. Press the **ENT** key to return to the standby display with CH16.
4. Watch CH16.

2. DSC DISTRESS COMMUNICATION

This page is intentionally left blank.

3. DSC OPERATION FOR NON-DISTRESS CASES

3.1 Coast or Ship Call

The coast or ship call is for sending message to a specific coast or ship station. After transmitting message (called ACK RQ transmission), wait to receive the acknowledge back (ACK BQ) signal from the receiving station. You should receive it within five minutes.

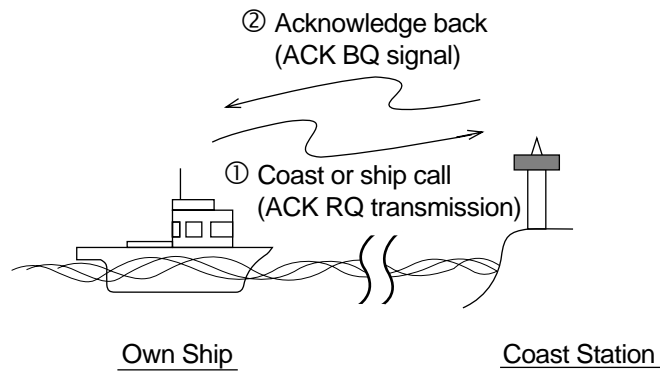

How a coast or ship call is transmitted

General procedure for transmitting a coast or ship call

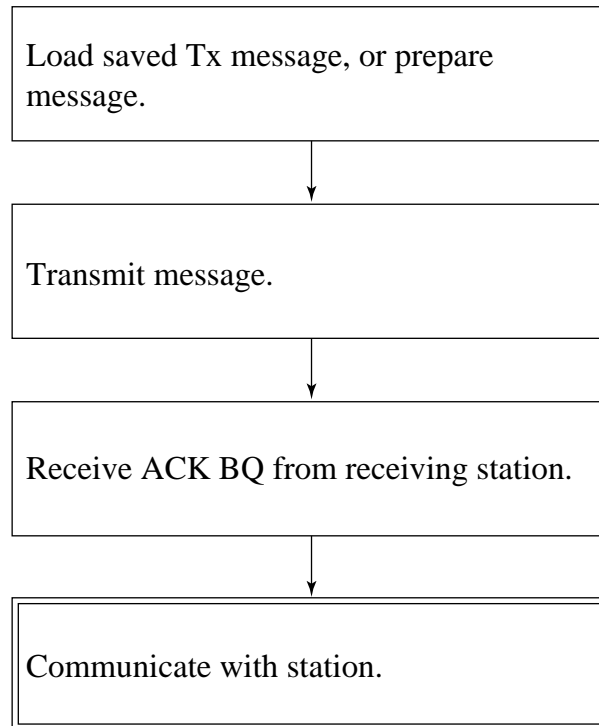

3.1.1 Sending a coast or ship call

1. Press the **CALL** key. The display changes from the standby display to the COMPOSE MESSAGE screen and the CALL TYPE is displayed in reverse video.

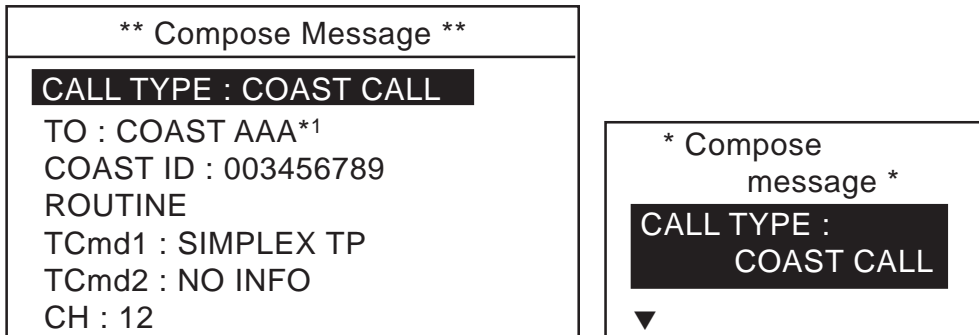

*1: If the coast or ship ID is registered in FILE, the registered name is displayed. If no registered, blank.

2. Press the **ENT** key to open the call type list.

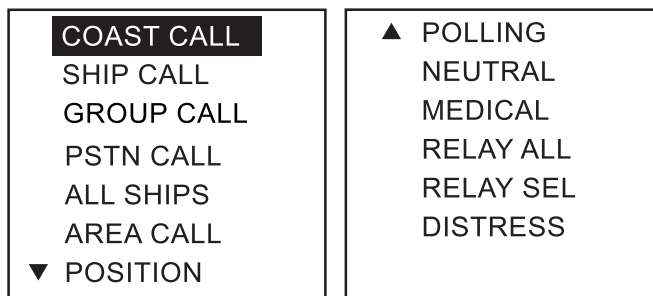

3. Rotate the **CH** knob (or press up / down arrow key) to choose COAST CALL or SHIP CALL and press the **ENT** key.
4. ID is selected; press the **ENT** key.
5. Key in a coast ID or ship ID number as appropriate and press the **ENT** key.
6. ROUTINE is selected; press the **ENT** key.

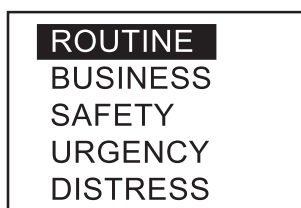

7. Choose ROUTINE, BUSINESS, SAFETY, or URGENCY as appropriate followed by pressing the **ENT** key.
8. TCmd1 is selected; press the **ENT** key.

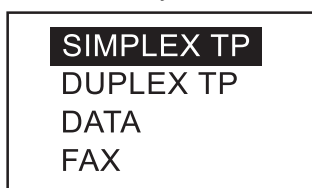

9. Choose SIMPLEX TP, DUPLEX TP, DATA or FAX as appropriate followed by pressing the **ENT** key. If you chose SIMPLEX, DUPLEX or FAX, NO INFO appears in the Tcmd2 field. Go to step 12. If you chose DATA, go to the next step.

10. TCmd2 is selected; press the **ENT** key.

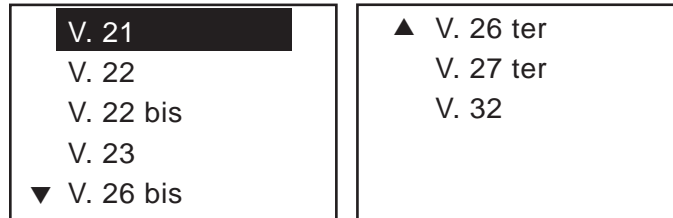

11. Choose the data type and press the **ENT** key.

12. Choose CH and press the **ENT** key. The following window appears.



13. Choose SELECT CH or NO INFO as appropriate followed by pressing the **ENT** key. If you chose SELECT CH, the following channel list appears. (The example shown is the international, duplex channel list.) Rotate the **CH** knob (or press up / down arrow key) to choose a channel you wish to communicate over and then press the **ENT** key.

DUP CHANNEL				
01	20	28	78	86
02	21	60	79	
03	22	61	80	
04	23	62	81	
05	24	63	82	
07	25	64	83	
18	26	65	84	
19	27	66	85	

14. Press the **CALL** key more than three seconds to transmit the message.

3.1.2 Receiving acknowledgement of coast or ship call

1. After a coast or ship call is sent, the equipment waits for acknowledgement of the call, showing the display below.

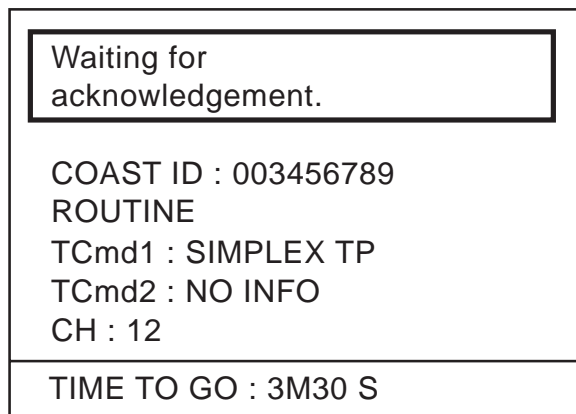

The timer starts counting down the maximum time to wait for acknowledgement, five minutes.

2. One of the following three messages appears. "No response! Try calling again?" appears after the timer counts down to zero. It means the receiving station did not respond.

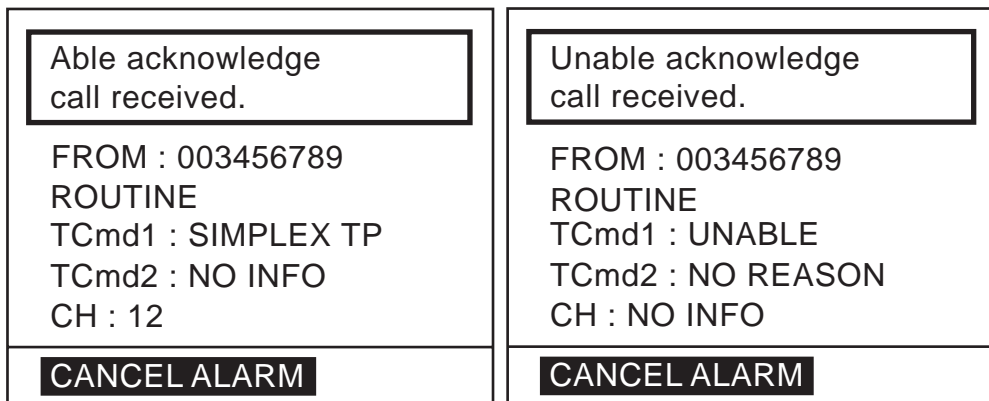

Able acknowledge call received

Unable acknowledge call received

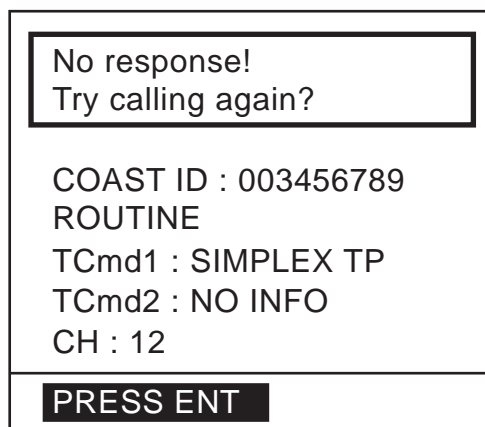

No response from station

A reason of Unable acknowledge is displayed. In case of QUEUE INDICATION, the channel will change to one that the coast station specifies.

3. Do one of the following depending on the message shown above.

Able acknowledge call received

- a) The audio alarm sounds; press the **CANCEL** key to silence it, and the display changes as below.

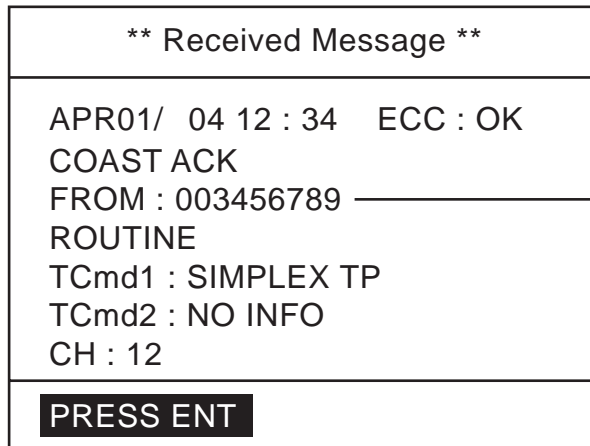

If a file is registered, its registered name is displayed instead of ID.

- b) Press the **ENT** key to go to the standby display. The working channel is automatically set; you may start voice communications.

Unable acknowledge call received

- a) The alarm sounds; press the **CANCEL** key to silence the alarm.
- b) Press the **ENT** key to return to the standby screen.

No response! Try calling again?

Re-send call: Push the **ENT** key followed by pressing the **CALL** key.

Cancel call: Press the **CANCEL** key to go to the standby display.

You can re-send the message from the TRANSMITTED log. See “3.10 Log File.”

3.1.3 Receiving a coast or ship call

When own ship receives a coast or ship call, acknowledgement is automatically or manually sent depending on the comply-type setting (see paragraph 4.2). The relationship between comply status and automatic/manual acknowledge is as shown in the table below.

Comply status Setting of SHIFT → ACK key	ABLE	UNABLE
AUTO ACK	Can send acknowledge automatically.	Can send UNABLE automatically.
MANUAL ACK	Can send acknowledge manually	Can send UNABLE manually.

Note: The handset must be on hook to enable automatic acknowledge.

3. DSC OPERATION FOR NON-DISTRESS CASES

Acknowledging the call automatically or manually by doing one of the following:

- 1) Send automatic acknowledge (ACK BQ) with comply status "ABLE." See the procedure below.
- 2) Sending automatic acknowledge (ACK BQ) with comply status "UNABLE." See the procedure on page 3-7.
- 3) Manually acknowledging individual call with "ABLE." See the procedure on page 3-8.
- 4) Manually acknowledging a coast or ship call with "UNABLE." See the procedure on page 3-9

1) Sending automatic acknowledge (ACK BQ) with comply status "ABLE."

1. When the automatic acknowledge feature is active (AUTO ACK), the comply status is "ABLE" and a coast or ship call is received, the auto acknowledge (ACK BQ) call is sent immediately. The display shown below appears. The alarm sounds and the ALARM LED blinks two minutes.

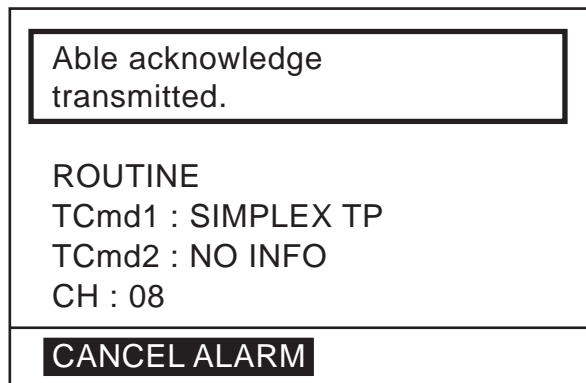

2. Press the **CANCEL** key to silence the alarm. The following display appears.

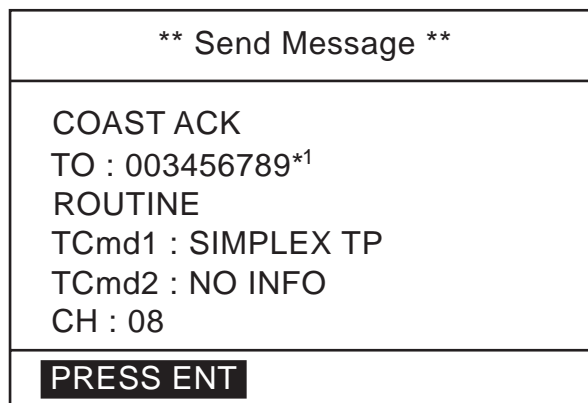

*1: If the coast or ship ID is registered in FILE, the registered name appears.

3. Press the **ENT** key. You can now communicate with the party, over the VHF channel specified.

2) Sending automatic acknowledge (ACK BQ) with comply status "UNABLE."

1. When the automatic acknowledge feature is active (AUTO ACK), the comply status is "UNABLE" and a coast or ship call is received, the display shown below appears, indicating that the auto acknowledge call with UNABLE (ACK BQ) has been sent. The alarm sounds and the ALARM LED blinks two minutes.

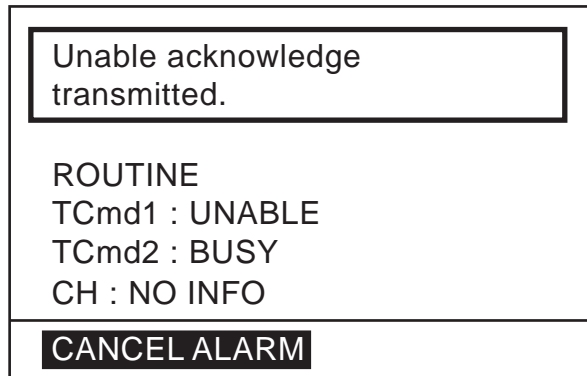

2. Press the **CANCEL** key to silence the alarm. The following display appears.

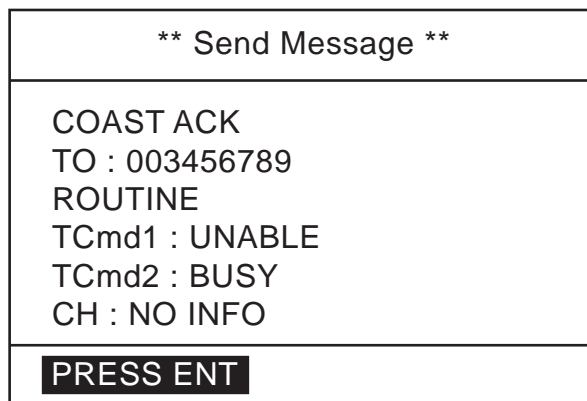

3. Press the **ENT** key.
4. If you want to send a proposal, prepare a message and sent it following the procedures shown on in paragraph 3.1.1.

3) Manually acknowledging individual call with "ABLE."

1. When the equipment is set up with manual acknowledge (MANUAL ACK), the comply status is "ABLE" and a coast or ship call is received, the alarm sounds and the display looks like the one below.

Individual request call received.
FROM : 123456789 ROUTINE TCmd1 : SIMPLEX TP TCmd2 : NO INFO CH : 08
CANCEL ALARM

2. Press the **CANCEL** key to silence the alarm. The following display appears.

** Received Message **
APR01/ 04 12 : 34 ECC : OK SHIP CALL FROM : 123456789 ROUTINE TCmd1 : SIMPLEX TP TCmd2 : NO INFO CH : 08
PRESS ENT TO ACK.

3. To send the ACK BQ manually, press the **ENT** key. The pop-up window shown below is displayed.

ABLE
UNABLE

4. Choose **ABLE** and press the **ENT** key. The display changes as shown below.

** Send Message **
SHIP ACK TO : 123456789 ROUTINE TCmd1 : SIMPLEX TP TCmd2 : NO INFO CH : 08
PRESS CALL TO SEND

5. Press the **CALL** key more than three seconds to transmit the ACK BQ. The display changes to the standby display with a channel specified.

4) Manually acknowledging a coast or ship call with "UNABLE."

1. When the equipment is set up with manual acknowledge and an individual call is received, the alarm sounds and the display shows the message "Individual request call received."

Individual request call received.
FROM : 123456789 ROUTINE TCmd1 : SIMPLEX TP TCmd2 : NO INFO CH : 08
CANCEL ALARM

2. Press the **CANCEL** key to silence the alarm. The following display appears.

** Received Message **
APR01/ 04 12 : 34 ECC : OK SHIP CALL FROM : 123456789 ROUTINE TCmd1 : SIMPLEX TP TCmd2 : NO INFO CH : 08
PRESS ENT TO ACK.

3. DSC OPERATION FOR NON-DISTRESS CASES

3. To send the ACK BQ manually, press the **ENT** key. The pop-up window shown below is displayed.



4. Choose UNABLE and press the **ENT** key. The following pop-up screen appears.

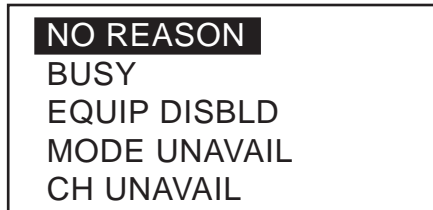

5. Press the **ENT** key.

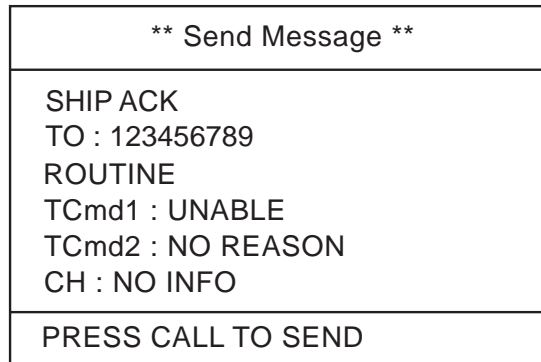

6. Press the **CALL** key more than three seconds to transmit the ACK BQ. The display changes to the standby display.

3.2 Group Call

A group call is for calling a specific group by specifying its group ID. When you set the group call in a message file, its group ID is stored automatically for your ship's group ID (see paragraph 4.5). To confirm group IDs, open the SYSTEM menu.

3.2.1 Sending a group call

1. Press the **CALL** key. The display changes to the COMPOSE MESSAGE screen and the CALL TYPE is displayed in reverse video.

2. Press the **ENT** key to open the call type list.

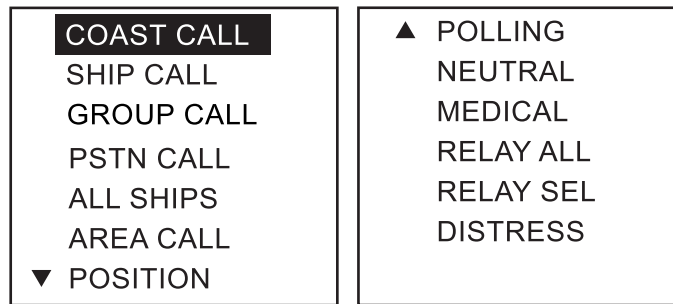

3. Rotate the **CH** knob (or press up / down arrow key) to choose GROUP CALL and press the **ENT** key.

4. GROUP ID is selected; press the **ENT** key.

5. Key in a group ID and press the **ENT** key.

6. ROUTINE is selected; press the **ENT** key.



7. Choose ROUTINE, BUSINESS, SAFETY, or URGENCY as appropriate followed by pressing the **ENT** key.

8. TCmd1 is selected; press the **ENT** key.

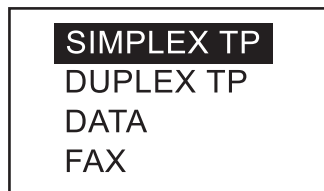

9. Choose SIMPLEX TP, DUPLEX TP, DATA or FAX followed by pressing the **ENT** key. If you chose SIMPLEX, DUPLEX, or FAX, NO INFO appears in the Tcmd2 field. Go to step 12. If you chose DATA, go to the next step.

10. TCmd2 is selected; press the **ENT** key.

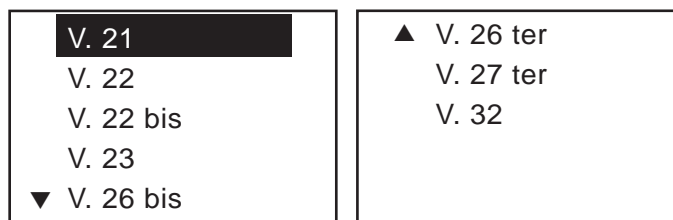

11. Choose the data type and press the **ENT** key.

12. Choose CH and press the **ENT** key. The following window appears.



3. DSC OPERATION FOR NON-DISTRESS CASES

13. Choose **SELECT CH** or **NO INFO** as appropriate followed by pressing the **ENT** key. If you chose **SELECT CH**, the following channel list appears. (The example shown is the international, duplex channel list.) Rotate the **CH** knob (or press up / down arrow key) to choose a channel you wish to communicate and press the **ENT** key.

DUP CHANNEL				
01	20	28	78	86
02	21	60	79	
03	22	61	80	
04	23	62	81	
05	24	63	82	
07	25	64	83	
18	26	65	84	
19	27	66	85	

14. Press the **CALL** key more than three seconds. A message will be transmitted.

3.2.2 Receiving a group call

Group ID must be registered in order to receive a group call. See paragraph 4.5.

1. When a group call is received, the alarm sounds and the **ALARM LED** blinks two minutes.

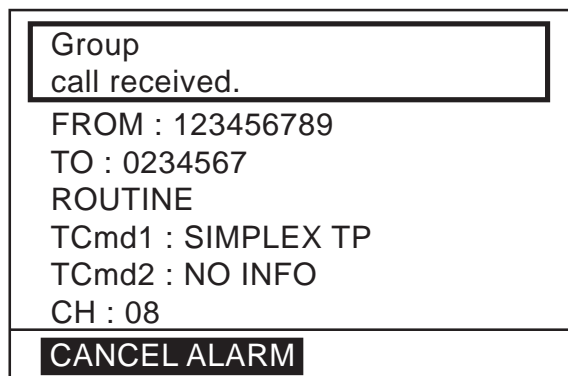

2. Press the **CANCEL** or **ENT** key to silence the alarm. The following display appears.

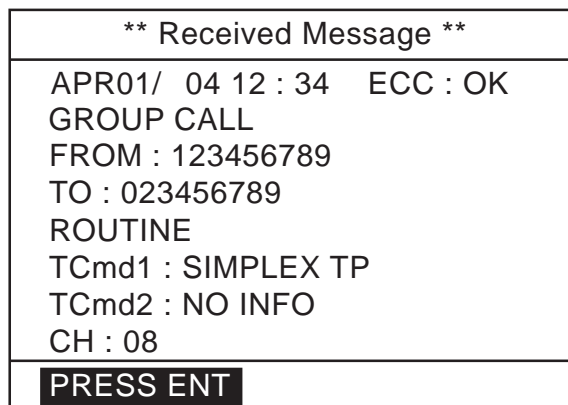

3. Press the **ENT** key. You can now communicate with the party, over the VHF channel specified.

3.3 PSTN Call

The PSTN call allows the making and receiving of telephone calls over public switched telephone networks. To use the PSTN call feature, use a handset which has a HOOK ON/OFF function. The standard supply handset has this feature.

3.3.1 Sending a PSTN call

1. Press the **CALL** key. The display changes from standby display to the COMPOSE MESSAGE screen and the CALL TYPE is displayed in reverse video.
2. Press the **ENT** key to open the call type list.

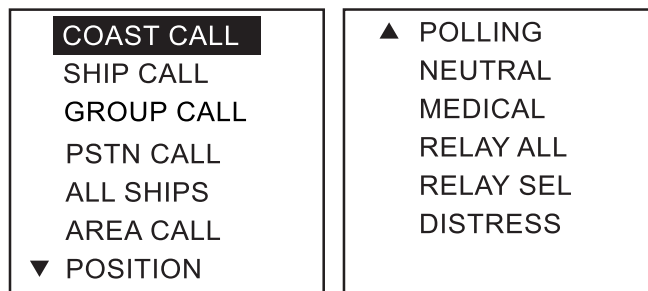

3. Rotate the **CH** knob (or press up / down arrow key) to choose PSTN CALL and press the **ENT** key.

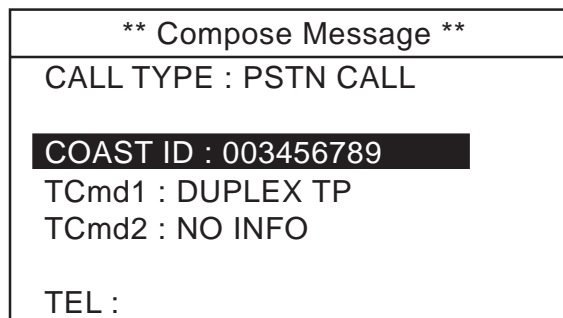

4. COAST ID is selected; press the **ENT** key.
5. Key in a coast ID and press the **ENT** key.
6. TCmd1 is selected; press the **ENT** key.
7. Choose SIMPLEX or DUPLEX as appropriate followed by pressing the **ENT** key.
8. TEL is selected; press the **ENT** key.
9. Key in a subscriber's telephone number (max. 16 digits).
10. Press the **CALL** key more than three seconds.

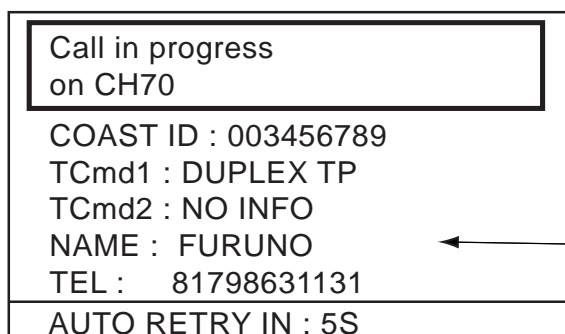

← When TEL no. is registered, the registered name is displayed.

3. DSC OPERATION FOR NON-DISTRESS CASES

If a response from the coast station is received within five seconds, transmit PSTN CALL (EOS) signal and then carrier frequency during two seconds. Then your phone rings. Press the **CANCEL** key to stop the calling sound and change to standby display. Hook off and communicate with other party.

Note: If using a hand-microphone, pressing the **CANCEL** key is equal to off-hook.

3.3.2 PSTN call disconnection (ship disconnects line)

1. After hanging up the handset or pressing the **CANCEL** key to complete your call, the display shows the following message. The end of call signal is transmitted; and the system then waits for a response from the coast station.

Waiting for acknowledgement
FROM : 003456789 TCmd1 : DUPLEX TP TCmd2 : PAY-PHONE TEL : 1234567890123456 CH : 28

2. When the ACK from the coast station is received, the following display appears. The communication time (charge time) is informed.

Able acknowledge call received.
FROM : 003456789 TCmd1 : END CALL TCmd2 : NO INFO TEL : 1234567890123456 CHARGE TIME : 00h05m18s
PRESS ENT

3.3.3 PSTN call disconnection (coast station disconnects line)

1. The PSTN line is disconnected by the coast station when it finds no evidence of communications or the land subscriber hangs up. The coast station then sends charge information as below.

PSTN end of call received.
FROM : 003456789 TCmd1 : END CALL TCmd2 : NO INFO TEL : 1234567890123456 CHARGE TIME : 00h06m18s
PRESS ENT

3.3.4 Receiving a PSTN call

1. When a PSTN call is received, the following display appears. Your phone rings.

Able PSTN call Pick up the handset!
FROM : 003456789 TCmd1 : DUPLEX TP TCmd2 : PAY-PHONE TEL No : 1234567890123456 CH : 28

2. Hook off within 60 seconds. The channel changes automatically and you can communicate with other party.
3. When the communication is completed, hook on the handset or press the **CANCEL** key.

3.4 All Ships Call

When an urgent but not life-endangering situation arises on your ship, for example, engine trouble, send an all ships call to request assistance.

After sending the call, you can communicate by voice over the radiotelephone. Do the following before beginning actual communications:

URGENCY priority: Say PAN three times followed by your call sign.

SAFETY priority: Say SECURITE three times followed by your call sign.

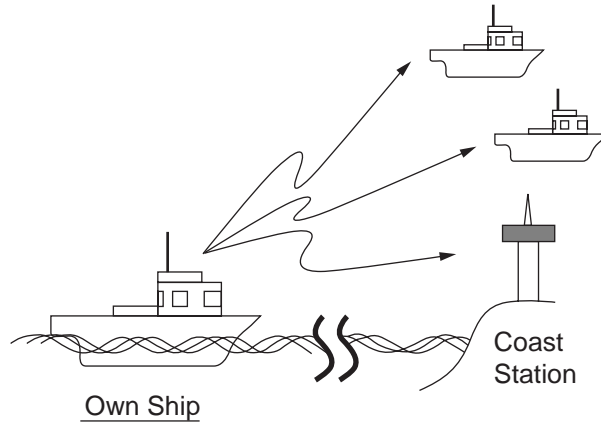

3.4.1 Sending an all ships call

1. Press the **CALL** key. The display changes from standby display to the COMPOSE MESSAGE screen and the CALL TYPE is displayed in reverse video.
2. Press the **ENT** key to open the call type list.

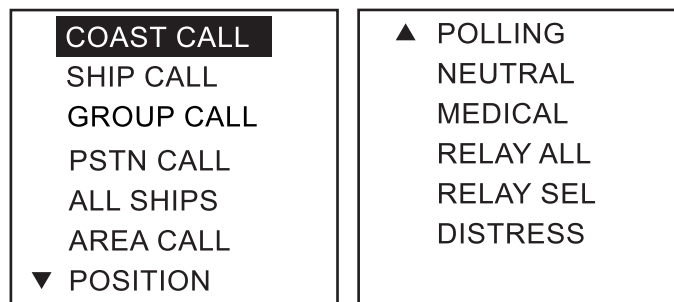

3. Rotate the **CH** knob (or press up / down arrow key) to choose ALL SHIPS and press the **ENT** key.
4. SAFETY is selected; press the **ENT** key.
5. Choose SAFETY, URGENCY, or DISTRESS as appropriate followed by pressing the **ENT** key.
6. TCmd1 is selected; press the **ENT** key.

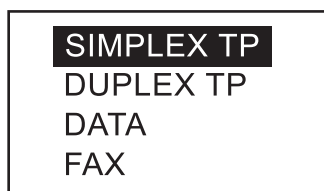

7. Choose SIMPLEX TP, DUPLEX TP, DATA or FAX as appropriate followed by pressing the **ENT** key. If you chose SIMPLEX, DUPLEX, or FAX, the NO INFO appears in the Tcmd2 field. Go to the step 10. If you chose DATA, go to the next step.

8. TCmd2 is selected; press the **ENT** key.

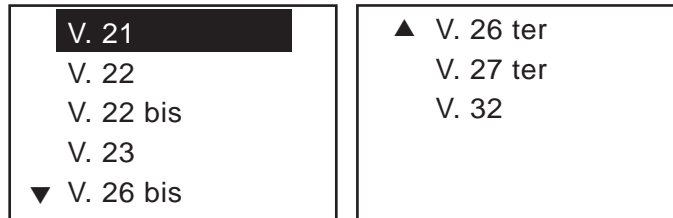

9. Choose the data type and press the **ENT** key.

10. Choose CH and press the **ENT** key. The following window appears.



11. Choose SELECT CH or NO INFO as appropriate followed by pressing the **ENT** key. If you chose SELECT CH, the following channel list appears. (The example is the international, duplex channel list.) Rotate the **CH** knob (or press up / down arrow key) to choose a channel and press the **ENT** key.

DUP CHANNEL				
01	20	28	78	86
02	21	60	79	
03	22	61	80	
04	23	62	81	
05	24	63	82	
07	25	64	83	
18	26	65	84	
19	27	66	85	

12. Press the **CALL** key more than three seconds to transmit the call.

After transmitting the message, the screen changes to standby display.

3.4.2 Receiving an all ships call

In case of ON HOOK

1. When an all ships call is received, the audio alarm sounds and the display looks something like the one shown below.

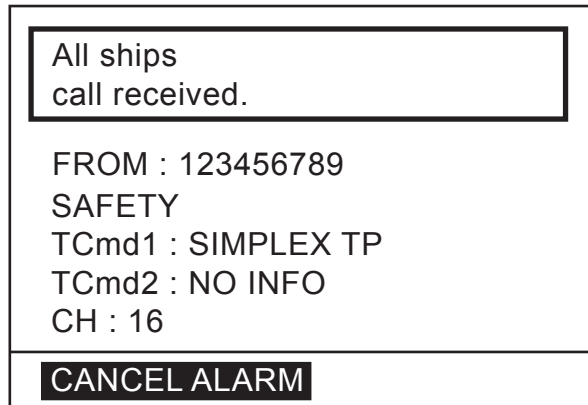

2. Press the **CANCEL** or **ENT** key to silence the alarm. The display changes as follows.

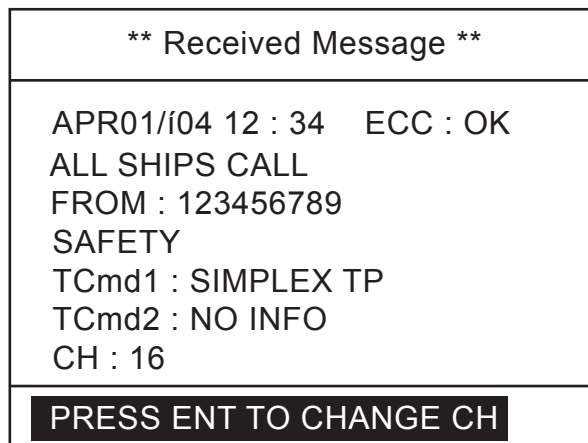

3. Press the **ENT** key. The display changes to the standby display, indicating channel specified, and you can watch the contents of the message.

In case of OFF HOOK

1. When an all ships call is received, the audio alarm sounds and the ALARM LED blinks.
2. Press the **ACK** key. The display changes to the standby display, indicating channel specified.

Note: Before pressing the **ACK** key, if you press the **CANCEL** key, the alarm stops. Press the **CANCEL** key again to cancel the all ship call, or press the **ENT** key to accept the all ship call and the display changes to the standby display, indicating channel specified.

3.5 Geographical Area Call

The geographical area call is for sending a call to all ships within the area you designate in your geographical area call. In the figure below, for example, the call will be sent to all ships within 24-34°N, 135-140°W.

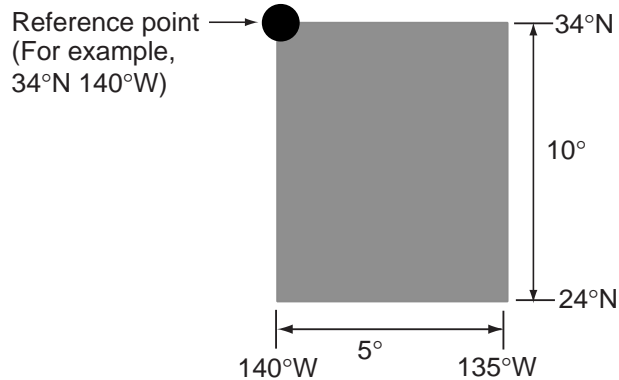

3.5.1 Sending a geographical area call

1. Press the **CALL** key. The display changes from standby display to the COMPOSE MESSAGE screen and the CALL TYPE is displayed in reverse video.
2. Press the **ENT** key to open the call type list.
3. Rotate the **CH** knob (or press up / down arrow key) to choose AREA CALL and press the **ENT** key.

** Compose Message **
CALL TYPE : AREA CALL
AREA : 34° N 123° E ↓10° →5°
ROUTINE
TCmd1 : SIMPLEX TP
TCmd2 : NO INFO
CH : 10

4. AREA is selected; press the **ENT** key.

1 : N / E	2 : S / W
__ ° N	__ ° E ↓ __ ° → __ °

5. Using the numeric keys, enter latitude and longitude of reference point and southerly degrees and easterly degrees of area. To change coordinate, choose it and press the **1** key for North or East; **2** key for South or West. After entering data, push the **ENT** key.
6. ROUTINE is selected; press the **ENT** key.
7. Choose ROUTINE, BUSINESS, SAFETY, URGENCY, or DISTRESS as appropriate followed by pressing the **ENT** key.

3. DSC OPERATION FOR NON-DISTRESS CASES

8. TCmd1 is selected; press the **ENT** key.

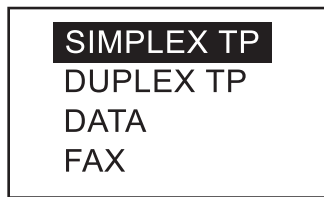

9. Choose SIMPLEX TP, DUPLEX TP, DATA or FAX as appropriate followed by pressing the **ENT** key. If you chose SIMPLEX, DUPLEX, or FAX, NO INFO appears in the Tcmd2 field. Go to step 12. If you chose DATA, go to the next step.

10. TCmd2 is selected; press the **ENT** key.

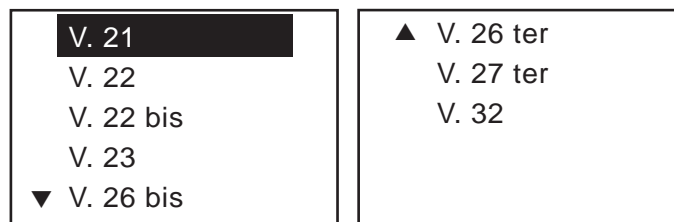

11. Choose the data type and press the **ENT** key.

12. Choose CH and press the **ENT** key. The following window appears.



13. Choose SELECT CH or NO INFO as appropriate followed by pressing the **ENT** key. If you chose SELECT CH, the following channel list appears. (The example is the international, duplex channel list.) Rotate the **CH** knob (or press up / down arrow key) to choose a channel and press the **ENT** key.

DUP CHANNEL				
01	20	28	78	86
02	21	60	79	
03	22	61	80	
04	23	62	81	
05	24	63	82	
07	25	64	83	
18	26	65	84	
19	27	66	85	

14. Press the **CALL** key more than three seconds to transmit the message. After the call is transmitted, the standby display appears with channel specified.

3.5.2 Receiving a geographical area call

1. When a geographical area call is received, the alarm sounds and the ALARM LED blinks two minutes.

Geographical area call received.
FROM : 123456789 AREA : 12° N 123° E ↓01° →01° ROUTINE TCmd1 : SIMPLEX TP TCmd2 : NO INFO CH : 10
CANCEL ALARM

2. Press the **CANCEL** key to silence the alarm. The following display appears.

** Received Message **
APR01/i04 12 : 34 ECC : OK AREA CALL FROM : 123456789 AREA : 12° N 123° E ↓01° →01° ROUTINE TCmd1 : SIMPLEX TP TCmd2 : NO INFO CH : 10
PRESS ENT TO CHANGE CH

3. Press the **ENT** key. You can now watch over the VHF channel specified.

In case of OFF HOOK

1. When a geographical area call is received, the audio alarm sounds and the ALARM LED blinks.
2. Press the **ACK** key. The display changes to the standby display, indicating channel specified.

Note: Before pressing the **ACK** key, if you press the **CANCEL** key, the alarm stops. Press the **CANCEL** key again to cancel the geographical area call, or press the **ENT** key to accept the geographical area call and the display changes to the standby display, indicating channel specified.

3.6 Position Call

There are two types of position calls: other station requires your ship's position and your ship requests position of another ship.

Finding position of other station

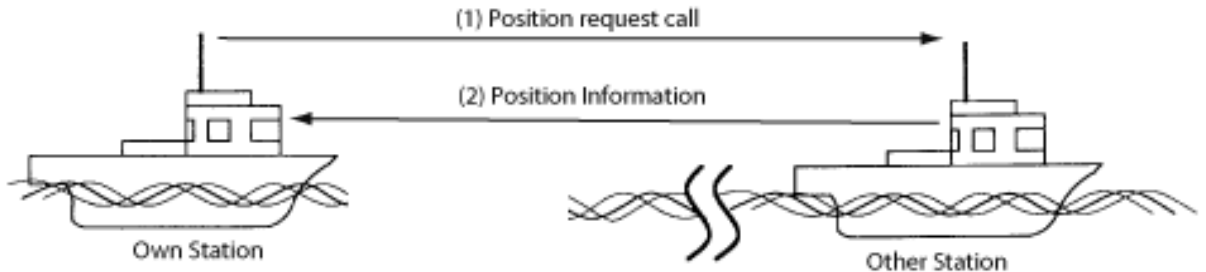

Sending own ship's position to other station

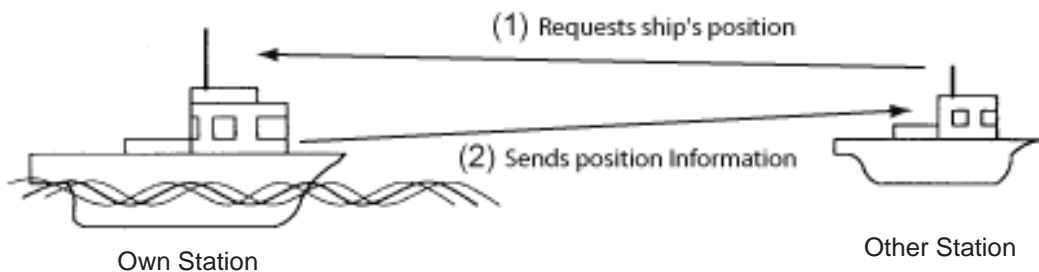

3.6.1 Position call: requesting other ship's position

1. Press the **CALL** key. The display changes from standby display to the COMPOSE MESSAGE screen and the CALL TYPE is displayed in reverse video.
2. Press the **ENT** key to open the call type list.
3. Rotate the **CH** knob (or press up / down arrow key) to choose POSITION and press the **ENT** key.

** Compose Message **	
CALL TYPE : POSITION REQUEST	
TO :	_____
SHIP ID : 123456789	
ROUTINE	
TCmd1 : POSITION REQUEST	
TCmd2 : NO INFO	

If a file is registered, its registration name is displayed. If not, this field is blank.

4. SHIP ID is selected; press the **ENT** key.
5. Key in a ship ID for which you want to know its position.
6. ROUTINE is selected; press the **ENT** key.
7. Choose ROUTINE, BUSINESS, SAFETY, URGENCY, or DISTRESS as appropriate followed by pressing the **ENT** key.

8. Press the **CALL** key more than three seconds to transmit position request. The following display appears. The timer counts down until a response is received.

Waiting for acknowledgement.	If a file is registered, its registration name is displayed. If not, this field is blank.
SHIP ID : 123456789	
ROUTINE	
TCmd1 : POSITION REQUEST TCmd2 : NO INFO	
TIME TO GO : 3M30 S	

9. When an acknowledge call is received, the following display appears and the audio alarm sounds.

Position acknowledge received.
FROM : 123456789
ROUTINE
TCmd1 : POSITION
TCmd2 : NO INFO
POS : 12° 34'N 123° 45'E
AT 12 : 34
CANCEL ALARM

10. Press the **CANCEL** key to silence the alarm. The display looks as below. You can now confirm position of other ship.

** Received Message **
APR01/ 04 12 : 34 ECC : OK
POSITION ACK
FROM : 123456789
ROUTINE
TCmd1 : POSITION
TCmd2 : NO INFO
POS : 12° 34'N 123° 45'E
AT 12 : 34
PRESS ENT

11. When "No response! Try calling again?" is displayed;
 Re-send call: Push the **ENT** key followed by the **CALL** key.
 Cancel call: Press the **CANCEL** key.

3.6.2 Position call: other ship requests your position

You may turn automatic acknowledge of position request on or off with POSITION CALL in the system setup menu. For further details, see page 4-3.

Automatic reply

1. When another ship requests your position, the status of the **5 ACK** key is AUTO ACK and the setting of POSITION CALL on the system setup menu is ON, the FM-8800D/S transmits own position data, showing the display below.

Position auto ack transmitted.
TCmd1 : POSITION TCmd2 : NO INFO POS : 12° 34'N 123° 45'E AT 12 : 34
CANCEL ALARM

2. Press the **CANCEL** key to silence the alarm. The display then looks like the one below, indicating own ship's position.

** Send Message **
POSITION ACK TO : 123456789 TCmd1 : POSITION TCmd2 : NO INFO POS : 12° 34'N 123° 45'E AT 12 : 34
PRESS ENT

Manual reply

1. When a position request call is received and the setting of POSITION CALL on the system setup menu is OFF, the audio alarm sounds and the display changes as below.

Position request call received.
FROM : 123456789 ROUTINE TCmd1 : POSITION TCmd2 : NO INFO
CANCEL ALARM

2. Press the **CANCEL** key to silence the alarm.

** Received Message **
APR01/ 04 12 : 34 ECC : OK POSITION CALL FROM : 123456789 ROUTINE TCmd1 : POSITION TCmd2 : NO INFO
PRESS ENT TO ACK.

3. To send your position manually, press the **ENT** key. The following pop-up menu appears.

ANSWER NO ANSWER

4. Choose **ANSWER** by the **CH** knob and press the **CALL** key to send your position data. Then, the standby display appears.
To send no position data, choose **NO ANSWER** and press the **ENT** key twice to return to the standby display.

3.7 Polling Call

Polling means confirming if own station is within communicating range with other station. This function only provides affirmative or negative response; it does not provide position information. Note that simultaneous polling to more than one station is not possible.

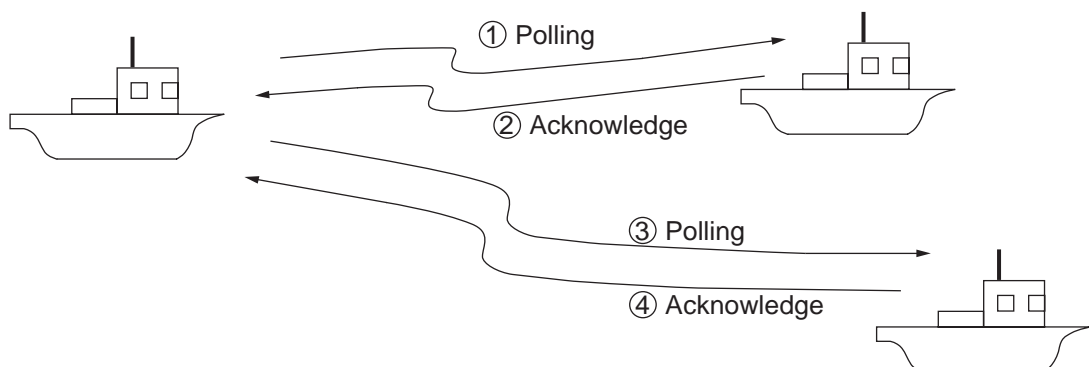

3.7.1 Sending a polling call

1. Press the **CALL** key. The display changes from standby display to the **COMPOSE MESSAGE** screen and the **CALL TYPE** is displayed in reverse video.
2. Press the **ENT** key to open the call type list.

3. DSC OPERATION FOR NON-DISTRESS CASES

3. Rotate the **CH** knob (or press up / down arrow key) to choose POLLING and press the **ENT** key.

** Compose Message **
CALL TYPE : POLLING
SHIP ID :
ROUTINE
TCmd1 : POLLING
TCmd2 : NO INFO

4. SHIP ID is selected; press the **ENT** key.
5. Key in a station ID with the numeric keys and press the **ENT** key.
6. ROUTINE is selected; press the **ENT** key.

ROUTINE
BUSINESS
SAFETY
URGENCY
DISTRESS

7. Rotate the **CH** knob (or press up / down arrow key) to choose the appropriate communications category and press the **ENT** key.
8. Press the **CALL** key more than three seconds to transmit polling call. After the call is transmitted, the following display appears. The timer counts down until a response is received.

Waiting for acknowledgement.
SHIP ID : 123456789
ROUTINE
TCmd1 : POLLING
TCmd2 : NO INFO
TIME TO GO : 3M30 S

- 9-1. When a polling acknowledge call is received, the audio alarm sounds and the display looks something like the one below.

Polling acknowledge received.
FROM : 123456789
ROUTINE
TCmd1 : POLLING
TCmd2 : NO INFO
CANCEL ALARM

— If a file is registered, the registration name is displayed.

Press the **CANCEL** key to silence the alarm. Press the **ENT** key to show the standby display when you can confirm if called party is within communicating range.

9-2. When "No response! Try calling again?" is displayed, do one of the following:

Re-send call: Push the **ENT** key followed by the **CALL** key.

Cancel call: Press the **CANCEL** key to return to the standby display.

3.7.2 Receiving a polling call

Automatic reply

1. When a polling request is received and the equipment is set up for automatic acknowledge POLLING on the AUTO ACK menu is ON and the **ACK** key is set to show AUTO ACK on the display, the display changes as shown in the illustration below and the audio alarm sounds.

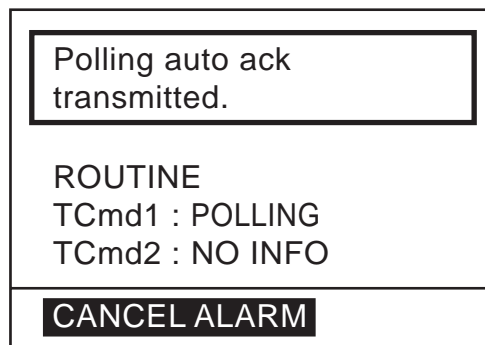

2. Press the **CANCEL** or **ENT** key to silence the alarm. The display changes as below.

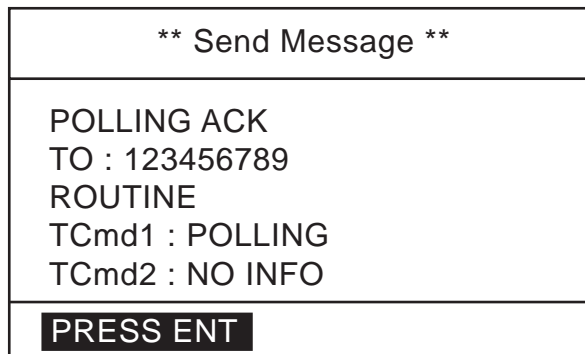

3. DSC OPERATION FOR NON-DISTRESS CASES

Manual reply

1. When a polling request call is received and the setting of POLLING CALL on the system setup menu is OFF, the display changes as shown in the illustration below and the audio alarm sounds.

Position request call received.
FROM : 123456789 ROUTINE TCmd1 : POLLING TCmd2 : NO INFO
CANCEL ALARM

2. Press the **CANCEL** key to silence the alarm. The display changes as below.

** Received Message **
APR01/ 04 12 : 34 ECC : OK POLLING CALL FROM : 123456789 ROUTINE TCmd1 : POLLING TCmd2 : NO INFO
PRESS ENT TO ACK.

3. To respond to the call, press the **ENT** key. The following pop-up window appears.

ANSWER NO ANSWER

4. Choose ANSWER by the **CH** knob and press the **CALL** key to send the polling acknowledge call. Then the standby display appears.
To send no reply, choose NO ANSWER and press the **ENT** key twice to return to the standby display.

3.8 Neutral Craft Call

The neutral craft call, which contains own ship position and ID, informs all ships that your ship is not a participant in armed conflict. Send the call BEFORE entering an area of armed conflict.

3.8.1 Sending a neutral craft call

1. Press the **CALL** key. The display changes from the standby display to the COMPOSE MESSAGE screen and the CALL TYPE is displayed in reverse video.
2. Press the **ENT** key to open the call type list.
3. Rotate the **CH** knob (or press up / down arrow key) to choose NEUTRAL and press the **ENT** key.

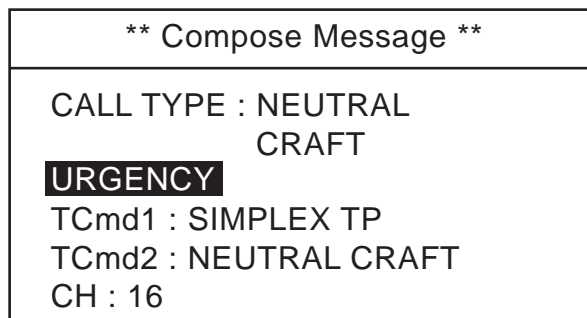

6. URGENCY is selected; press the **ENT** key.
7. Choose SAFETY, or URGENCY as appropriate followed by pressing the **ENT** key.
8. Press the **CALL** key more than three seconds to transmit the call. After the call is transmitted, the standby display appears.

3.8.2 Receiving a neutral craft call

1. When a neutral craft call is received, the alarm sounds and the display changes as below.

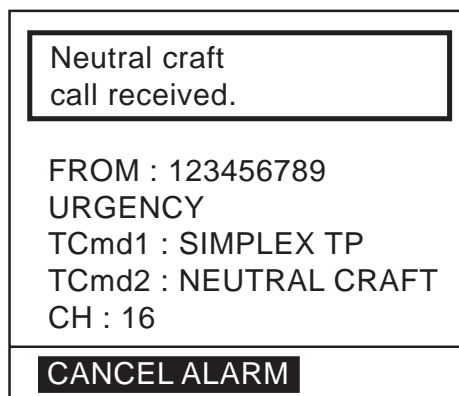

3. DSC OPERATION FOR NON-DISTRESS CASES

2. Press the **CANCEL** or **ENT** key. The audible alarm is silenced and the display changes as below.

** Received Message **
APR01/ 04 12 : 34 ECC : OK NEUTRAL CALL FROM : 123456789 SAFETY TCmd1 : SIMPLEX TP TCmd2 : NEUTRAL CRAFT CH : 16
PRESS ENT TO CHANGE CH

3. Press the **ENT** key. The display changes to the standby display, indicating CH16.

3.9 Medical Transport Call

The medical transport call informs all ships, by urgency priority, that own ship carries medical supplies.

3.9.1 Sending a medical transport call

1. Press the **CALL** key. The display changes from the standby display to the COMPOSE MESSAGE screen and the CALL TYPE is displayed in reverse video.
2. Press the **ENT** key to open the call type list.
3. Rotate the **CH** knob (or press up / down arrow key) to choose the MEDICAL and press the **ENT** key.

** Compose Message **
CALL TYPE : MEDICAL TRANSPORT URGENCY TCmd1 : SIMPLEX TP TCmd2 : MEDICAL TRSPRT CH : 16

4. Press the **CALL** key more than three seconds to transmit the call. After the call is transmitted, the standby display appears, with CH16 selected.

3.9.2 Receiving a medical transport call

1. When a medical call is received, the alarm sounds and the display changes as below.

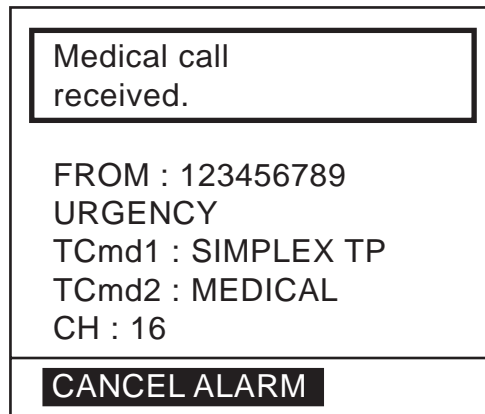

2. Press the **CANCEL** or **ENT** key. The audible alarm stops and the display changes as below.

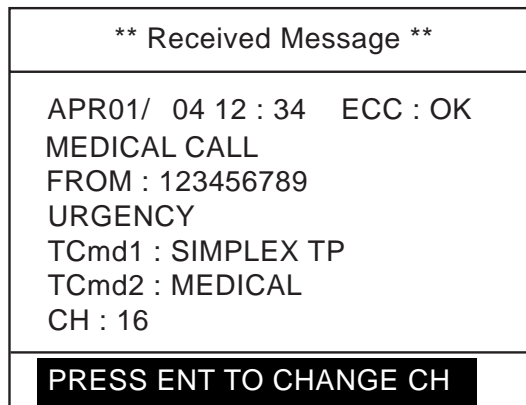

3. Press the **ENT** key. The display changes to the standby display, indicating CH16.

3.10 Log File

Three log files are provided for storage of calls: received ordinary log, received distress log and transmitted log. Each log file stores 50 calls, on a first-in, first-out basis. This means that the latest call is saved as log no.1 and the log no. of all previous calls in that log increments by one. When the storage capacity is exceeded, the oldest call is deleted to make room for the latest. A letter mark shows unread or unacknowledged calls. Received distress calls are automatically deleted 48 hours after being read.

Opening a log file

The procedure for opening a log is common to all logs.

1. Press the **LOG** key to open the SELECT LOG FILE display.

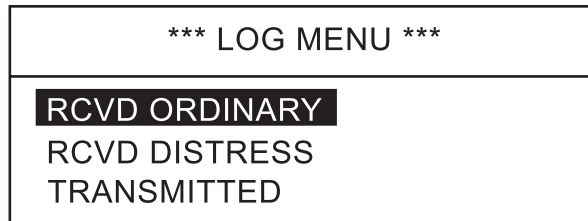

2. Rotate the **CH** knob to choose RCVD ORDINARY, RCVD DISTRESS or TRANSMITTED as appropriate and press the **ENT** key. For example, choose RCVD ORDINARY or TRANSMITTED.

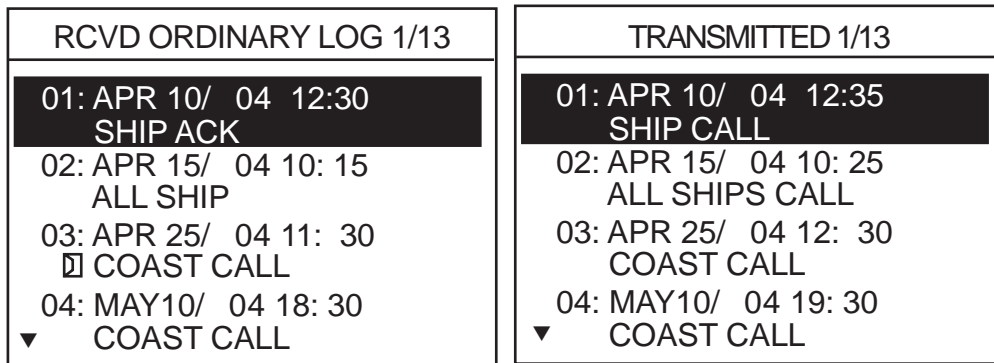

3. Rotate the **CH** knob to choose a file you wish to browse.
The in the RCVD ORDINARY LOG indicates unread or unacknowledged message.

4. Press the **ENT** key to open the message. Below is a sample message.

** Received Message **	
APR 10/04 18:30 ECC : OK SHIP CALL FROM : 123456789 ROUTINE TCmd1 : SIMPLEX TP TCmd2 : NO INFO CH : 16	
DELETE	▲ ▼ ANSWER

For a received message which requires a reply, ANSWER is displayed (for 4.5 minutes) . To reply choose it and press the **ENT** key.

5. Press ▲ or ▼ key to open previous or next page on the log.
6. If you wish to print the file selected, press the **PRINT** key.
7. If you wish to delete the file selected, choose DELETE and press the **ENT** key.
The following confirmation window appears.

DELETE RECEIVED LOG ARE YOU SURE? YES NO

8. Choose YES and press the **ENT** key.

3. DSC OPERATION FOR NON-DISTRESS CASES

This page is intentionally left blank.

4. BASIC SETUP

4.1 Alarm Setup

This section provides the procedures for setting up various alarms. The alarm menu enables/disables internal and external alarms. Note that the Distress/Urgency alarm cannot be disabled.

Old position alarm in manual position entry mode

This alerts the operator when manually entered position data is older by the number of hours or minutes set.

1. Press the **MENU** key.

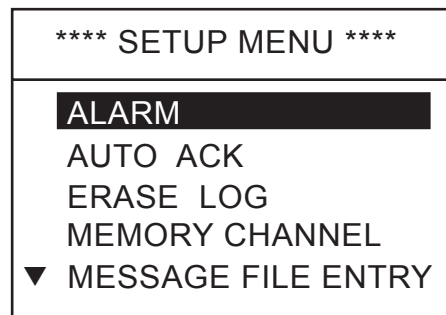

SETUP MENU on transceiver unit



SETUP MENU on remote handset

2. ALARM is selected; press the **ENT** key to display the ALARM menu.



ALARM MENU on transceiver unit

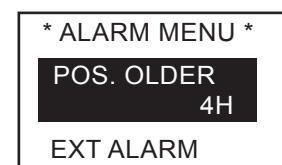

ALARM MENU on remote handset

3. Rotate the **CH** knob (or press up / down arrow key) to choose POSITION OLDER (POS. OLDER for remote handset) from the ALARM MENU and press the **ENT** key. The following setting window appears.

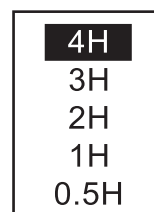

4. Rotate the **CH** knob (or press up / down arrow key) to choose an appropriate value and press the **ENT** key.

Alarm is output when position is older by the number of hours set here.

5. Press the **CANCEL** key twice to return to the standby display.

4. BASIC SETUP

To set type of alarm to output

1. Rotate the **CH** knob (or press up / down arrow key) to choose EXT ALARM from the ALARM MENU and press the **ENT** key. The following setting window appears.

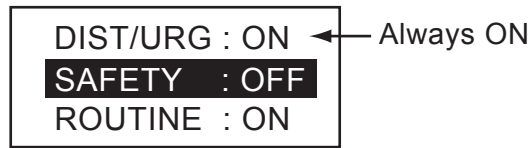

2. Rotate the **CH** knob (or press up / down arrow key) to choose an appropriate option. Alarm is output to external device.
DSTRS/URG: Distress or urgency call output upon receipt.
SAFETY: Safety call output upon receipt.
ROUTINE: Routine call output upon receipt.
3. Press the **ENT** key.
4. Choose ON or OFF as appropriate and press the **ENT** key.
5. Press the **CANCEL** key three times to return to the standby display.
Note that the setting of ROUTINE is turned to ON after turning on the power

4.2 Auto ACK Setup

The Auto Ack Menu enables/disables automatic acknowledgement of ship, coast, position and polling calls.

Comply status Set of [5 ACQ]	ABLE	UNABLE
AUTO ACK	Can send acknowledge automatically.	Can send UNABLE automatically.
MANUAL ACK	Can send acknowledge manually	Can send UNABLE manually.

To set COMPLY TYPE

1. Press the **MENU** key.
2. Rotate the **CH** knob (or press up / down arrow key) to choose AUTO ACK and press the **ENT** key. The following menu appears.

**** AUTO ACK MENU ****
COMPLY STATUS ABLE UNABLE REASON NO REASON POSITION CALL ON POLLING CALL ON

3. **COMPLY STATUS** is selected; press the **ENT** key. The following setting window appears.

ABLE UNABLE

4. Rotate the **CH** knob (or press up / down arrow key) to choose **ABLE** or **UNABLE** as automatic acknowledgement reply to each call.
5. Press the **ENT** key.

Note: Automatic acknowledge is automatically disabled when RX call contains error, as required by law. Further, automatic acknowledge is disabled in case of OFF HOOK.

To set reason for unable

If you have chosen UNABLE as the COMPLY STATUS, set the reason as follows:

1. Rotate the **CH** knob (or press up / down arrow key) to choose UNABLE REASON from the AUTO ACK MENU and press the **ENT** key. The following menu appears.

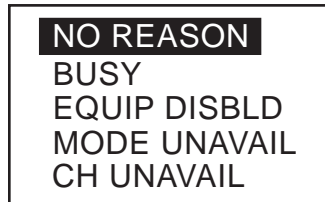

2. Rotate the **CH** knob (or press up / down arrow key) to choose a reason for UNABLE.
3. Press the **ENT** key.

Note: This menu is the same as manual acknowledgement. EQUIPMENT DISABLE is shown in calls when EQUIP DISBLD is selected.

To set position call response

1. Rotate the **CH** knob (or press up / down arrow key) to choose the POSITION CALL from the AUTO ACK MENU and press the **ENT** key.
2. Rotate the **CH** knob (or press up / down arrow key) to choose ON or OFF as appropriate.
OFF: Disables automatic acknowledgement of position request.
ON: Enables automatic acknowledgement of position request.
3. Press the **ENT** key.

To set polling call response

1. Rotate the **CH** knob (or press up / down arrow key) to choose the POLLING CALL from the AUTO ACK MENU and press the **ENT** key.
2. Rotate the **CH** knob (or press up / down arrow key) to choose ON or OFF as appropriate.
OFF: Disables automatic acknowledgement of polling request.
ON: Enables automatic acknowledgement of polling request.
3. Press the **ENT** key.

4.3 Erasing Logs

Erasing received ordinary log

1. Press the **MENU** key.
2. Rotate the **CH** knob (or press up / down arrow key) to choose the ERASE LOG and press the **ENT** key. The following window appears.

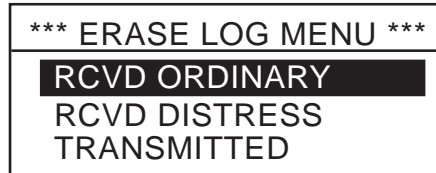

3. RCVD ORDINARY is selected; press the **ENT** key to erase the received ordinary log.
4. Choose YES and press the **ENT** key to erase the received ordinary log.

Erasing received distress log

1. Press the **MENU** key.
2. Rotate the **CH** knob (or press up / down arrow key) to choose ERASE LOG and press the **ENT** key.
3. Rotate the **CH** knob (or press up / down arrow key) to choose RCVD DISTRESS and press the **ENT** key to erase the received distress log.
4. Choose YES and press the **ENT** key to erase the received distress log.

Erasing transmitted log

1. Press the **MENU** key.
2. Rotate the **CH** knob (or press up / down arrow key) to choose ERASE LOG and press the **ENT** key.
3. Rotate the **CH** knob (or press up / down arrow key) to choose TRANSMITTED and press the **ENT** key.

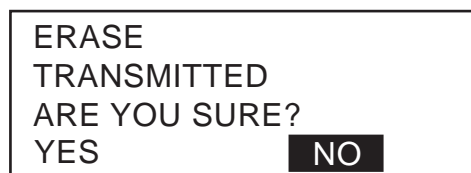

4. Choose YES and press the **ENT** key to erase the transmitted message log.

4.4 Memory Channel Setup

You can save up to 50 channels as follows.

1. Press the **MENU** key.
2. Rotate the **CH** knob (or press up / down arrow key) to choose MEMORY CHANNEL and press the **ENT** key.

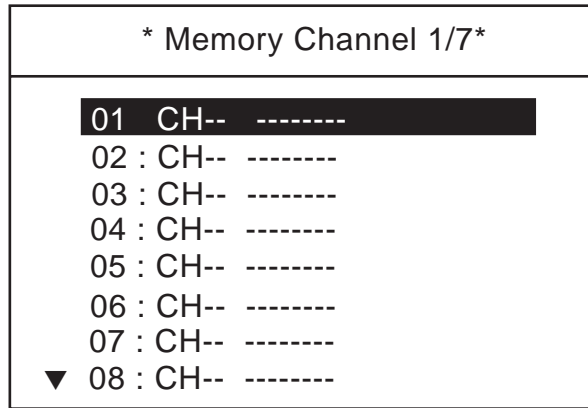

3. Rotate the **CH** knob (or press up / down arrow key) to choose a vacant CH number and press the **ENT** key.



* : Only permitted channel modes are displayed, which are set by the installer of the equipment.

4. Rotate the **CH** knob (or press up / down arrow key) to choose appropriate channel type and press the **ENT** key.
5. Rotate the **CH** knob (or press up / down arrow key) to choose channel number and press the **ENT** key.

4.5 Message File Entry

In this section you will learn how to prepare and store ship, coast, PSTN, group, and area calls for future transmission. 100 calls can be stored.

1. At the standby display, press the **MENU** key to open the SETUP MENU.

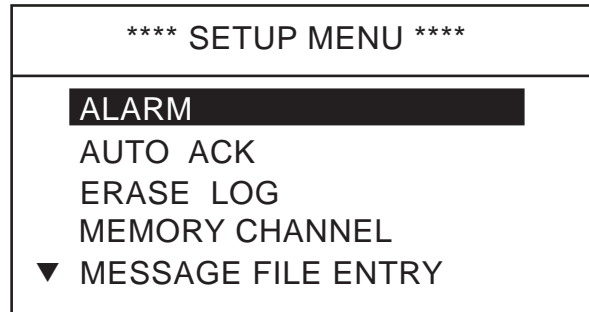

2. Rotate the **CH** knob (or press up / down arrow key) to choose MESSAGE FILE ENTRY and press the **ENT** key.

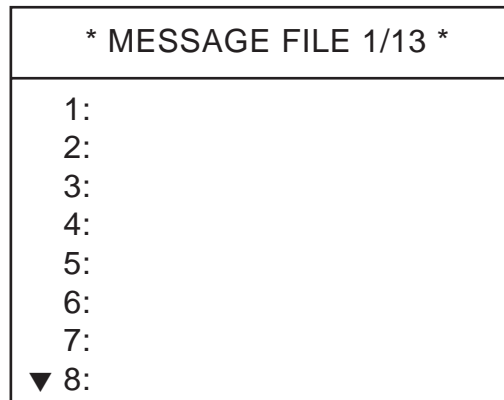

3. Rotate the **CH** knob to choose a vacant number and press the **ENT** key. The following selection window appears.

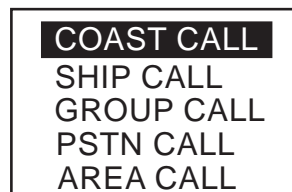

4. BASIC SETUP

4. Rotate the **CH** knob to choose the call type and press the **ENT** key. One of the following display appears depending on the call type selected above.

MESSAGE FILE 1 ENTRY	
CALL TYPE	: COAST CALL
COAST ID	: 00
ROUTINE	
TCmd1	: SIMPLEX TP
TCmd2	: NO INFO
CH	: 16
NAME	:
REGIST ERASE	

In case of Coast call

MESSAGE FILE 1 ENTRY	
CALL TYPE	: SHIP CALL
SHIP ID	:
ROUTINE	
TCmd1	: SIMPLEX TP
TCmd2	: NO INFO
CH	: 16
NAME	:
REGIST ERASE	

In case of Ship call

MESSAGE FILE 1 ENTRY	
CALL TYPE	: GROUP CALL
GROUP ID	: 0
ROUTINE	
TCmd1	: SIMPLEX TP
TCmd2	: NO INFO
CH	: 16
NAME	:
REGIST ERASE	

In case of Group call (Note3)

MESSAGE FILE 1 ENTRY	
CALL TYPE	: PSTN CALL
COAST ID	: 00
TCmd1	: DUPLEX TP
TCmd2	: NO INFO
TEL	:
NAME	:
REGIST ERASE	

In case of PSTN call

MESSAGE FILE 1 ENTRY	
CALL TYPE	: AREA CALL
AREA	: --° ----° ↓ --° → --°
ROUTINE	
TCmd1	: SIMPLEX TP
TCmd2	: NO INFO
CH	: 16
NAME	:
REGIST ERASE	

In case of Area call

Note1: The communication priority is ROUTINE only.

Note2: The group ID will be registered automatically after a group call message file is saved.

Note3: If you register a group call, its group ID becomes your own group ID.

5. Press the **ENT** key and key in each ID or AREA followed by the **ENT** key.
To enter area

1: N/E	2: S/W
--° N	---° E ↓ --° → --°

- Enter latitude (degrees) and 1 for north or 2 for south of reference point.
 - Enter longitude (degrees) and 1 for east or 2 for west.
 - Enter southerly degrees of area.
 - Enter easterly degrees of area.
 - Press the **ENT** key.
6. TCmd1 is selected; press the **ENT** key.

SIMPLEX TP
DUPLEX TP
DATA
FAX

7. Choose SIMPLEX TP, DUPLEX TP, DATA or FAX as appropriate followed by pressing the **ENT** key. If you chose SIMPLEX, DUPLEX, or FAX, NO INFO appears in the Tcmd2 field. Go to step 10. If you chose DATA, go to the next step.
8. Tcmd2 is selected; press the **ENT** key.

V. 21	▲ V. 26 ter
V. 22	V. 27 ter
V. 22 bis	V. 32
V. 23	
▼ V. 26 bis	

9. Choose an appropriate data type and press the **ENT** key.
10. Choose CH and press the **ENT** key. The following window appears.

SELECT CH
NO INFO

11. Choose SELECT CH with the **CH** knob (or up / down arrow key) and press the **ENT** key.

SIMP CHANNEL		
06	15	73
08	16	74
09	17	75
10	67	76
11	68	77
12	69	87
13	71	88
14	72	

In case of NO INFO, there is no channel information.

4. BASIC SETUP

12. Choose a channel with the **CH** knob (or up / down arrow key) and press the **ENT** key.
13. Press the **ENT** key to open the name entry window.
14. Enter a name with the alphanumeric keys. To change a digit, rotate the **CH** knob. Press the **ENT** key.

MESSAGE FILE 1 ENTRY	
CALL TYPE	: COAST CALL
COAST ID	: 0012345678
ROUTINE	
TCmd1	: SIMPLEX TP
TCmd2	: NO INFO
CH	: 12
NAME	: ABCD
REGIST	ERASE

In case of Coast call

15. **REGIST** is selected; press the **ENT** key to register. To erase, rotate the **CH** knob to select **ERASE** and press the **ENT** key.

To send a message file:

Method1

- 1) Press the **CALL** key.
- 2) Choose call type and press the **ENT** key.
- 3) Highlighting xxx ID, press the **FILE** key to display list of message files.
- 4) Choose file to send and press the **ENT** key..
- 5) Set the Routine, TCmd1, TCmd2 and CH.
- 6) Press the **CALL** key more than three seconds.

Method2

- 1) Press the **FILE** key at the standby display.
- 2) Choose a file you want to send and press the **ENT** key.
- 3) Press the **CALL** key more than three seconds.

4.6 Position Setup

This is where you enter your position, automatically or manually.

1. Press the **MENU** key at the standby display.
2. Rotate the **CH** knob (or press up / down arrow key) to choose POSITION from the second page of the main menu.

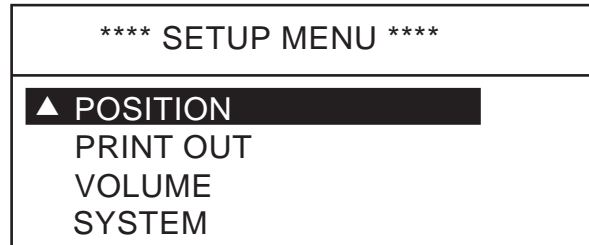

3. Press the **ENT** key. The following menu appears.

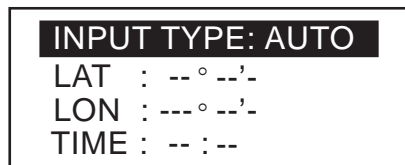

4. INPUT TYPE is selected; press the **ENT** key. The following setting window appears.



Note: If the position data from a positioning sensor is available, MANUAL can not be chosen, i.e. the above window does not open.

5. Rotate the **CH** knob (or press up / down arrow key) to choose AUTO or MANUAL as appropriate and press the **ENT** key.

If you chose AUTO, your ship's position and time appear; press the **CANCEL** to close the menu and return to the standby display. These data are supplied from the navigation equipment connected.

Note: • If correct position data is entered from a position source during the setting of MANUAL, the setting changes automatically to AUTO from MANUAL.

- If the message "GPS ERR" appears after you change INPUT TYPE from MANUAL to AUTO, confirm that the navigation device is functioning.

If you chose MANUAL, enter your position and time as follows.

6. Enter latitude (in four digits) with the numeric keys. If necessary, switch coordinates: **1** key to switch to North; **2** key to switch to South.
7. Press the **ENT** key and enter longitude (in five digits) with the numeric keys. If necessary, switch coordinates: **1** key to switch to East; **2** key to switch to West.
8. Press the **ENT** key and enter UTC time with the numeric keys.
9. Press the **ENT** key and **CANCEL** key to finish.

4.7 Print Out Setup

The PRINT MENU enables/disables automatic printing of all transmitted and received calls and the results of the daily test.

1. Press the **MENU** key at the standby display to open menu.
2. Rotate the **CH** knob (or press up / down arrow key) to choose PRINT OUT from the second page of the main menu and press the **ENT** key.

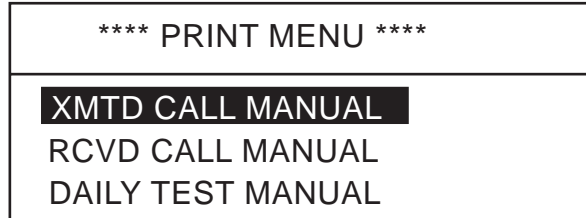

3. Choose appropriate item among XMTD CALL MANUAL, RCVD CALL MANUAL or DAILY TEST MANUAL and press the **ENT** key.



4. Choose AUTO or MANUAL as appropriate and press the **ENT** key.
5. Press the **CANCEL** key twice to return to the standby display.

In the AUTO, when a message is received, its message automatically is printed out. In the MANUAL, open a message you want to print and press the **PRINT** key (see page 3-32).

Note: In the AUTO, you can print a message as same as Manual.

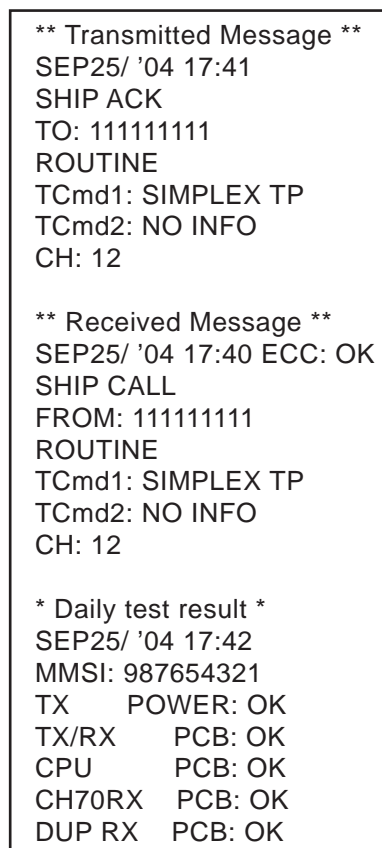

Sample printout

4.8 Volume Setup

The VOLUME menu enables/disables key beep (acknowledges correct key input) and adjusts the volume of the earpiece, intercom and off-hook loudspeaker.

1. Press the **MENU** key at the standby display.
2. Rotate the **CH** knob (or press up / down arrow key) to choose VOLUME and press the **ENT** key.

**** VOLUME MENU ****	
KEY CLICK	8
EARPIECE LEVEL	9
INTERCOM VOLUME	8
OFF HOOK SPKR	ON

Follow the appropriate procedure to adjust volume of desired item.

Key click

1. Choose KEY CLICK, and press the **ENT** key.

KEY CLICK LEVEL SETUP	KEY CLICK LEVEL SETUP
LEVEL (0-16)	LEVEL (0-16)
< ■■■■■ >	< ■■■ > 4
EXT: ENT	EXT: ENT

Note: Do not confuse keyboard beep (single beep) with ACK beep (three beeps).

2. Rotate the **CH** knob (or press up / down arrow key) to set the key click level. The setting range is 0 to 16.
3. Press the **ENT** key. (If you press the **CANCEL** key, the setting is not stored.)

Earpiece volume

1. Choose ERAPIECE LEVEL and press the **ENT** key.

EARPIECE LEVEL SETUP	EARPIECE LEVEL SETUP
LEVEL (8-16)	LEVEL (1-4)
< ■■■■■ >	< ■■ > 2
EXT: ENT	EXT: ENT

Transceiver unit

Remote handset

2. Rotate the **CH** knob (or press up / down arrow key) to set the earpiece volume level. The setting range is 8 to 16 for transceiver handset and 1 to 4 for remote handset.
3. Press the **ENT** key. (If you press the **CANCEL** key, the setting is not stored.)

4. BASIC SETUP

Intercom volume

1. Choose INTERCOM VOLUME and press the **ENT** key.

INTERCOM SETUP	
LEVEL (1-16)	
< ■■■■	> 8
EXT: ENT	

2. Rotate the **CH** knob (or press up / down arrow key) to set the intercom volume level. The setting range is 1 to 16.
3. Press the **ENT** key.

Off-hook loudspeaker

You can set the loudspeaker(s) (internal and external) on or off, according to off-hook condition.

1. Choose OFFHOOK SPKR and press the **ENT** key.
2. Choose ON or OFF and press the **ENT** key.
 - OFFHOOK SPKR ON: Loudspeaker(s) is activated when off-hook.
 - OFFHOOK SPKR OFF: Loudspeaker(s) is deactivated when off-hook.

5. SYSTEM SETUP

5.1 Displaying Self ID

1. Press the **MENU** key.

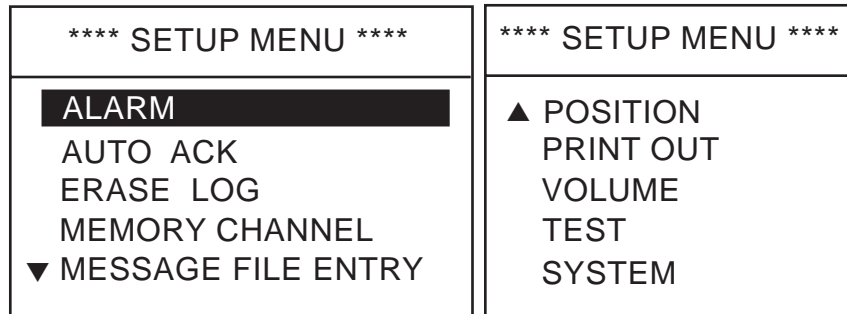

2. Rotate the **CH** knob (or press up / down arrow key) to choose SYSTEM from page 2 of the menu and press the **ENT** key. The following window appears. The self ID is displayed on the first line.

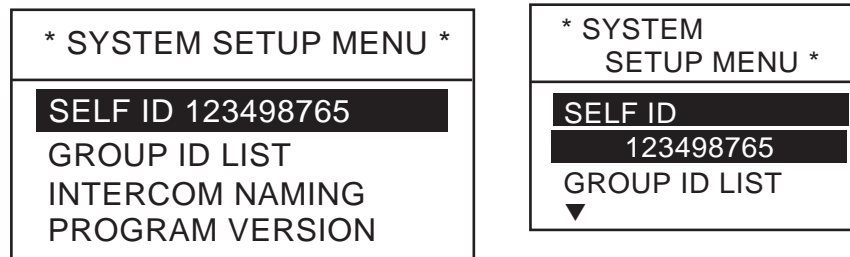

Transceiver unit

Remote handset

5.2 Displaying Group ID List

1. Press the **MENU** key.
2. Rotate the **CH** knob (or press up / down arrow key) to choose SYSTEM from page 2 of the menu and press the **ENT** key.
3. Rotate the **CH** knob (or press up / down arrow key) to choose GROUP ID LIST and press the **ENT** key to show the GROUP ID list. For how to registers group IDs, see paragraph 4.5.

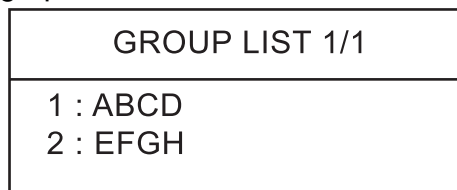

5.3 Naming Intercom

1. Press the **MENU** key.

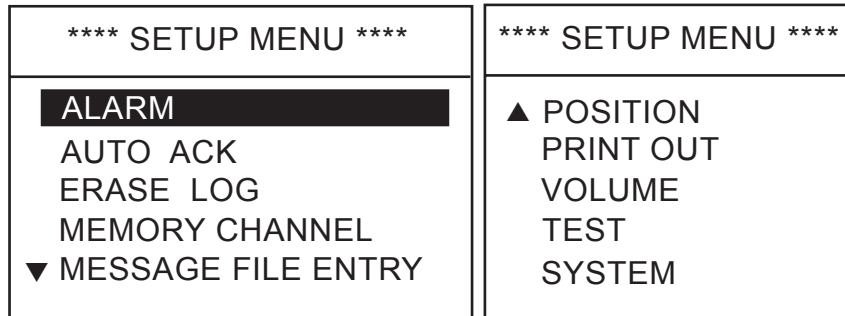

2. Rotate the **CH** knob (or press up / down arrow key) to choose SYSTEM from page 2 of the menu and press the **ENT** key. The following window appears.

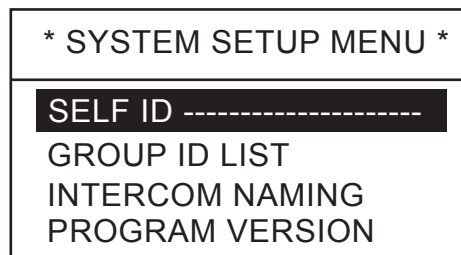

3. Rotate the **CH** knob (or press up / down arrow key) to choose INTERCOM NAMING and press the **ENT** key. The following window appears.

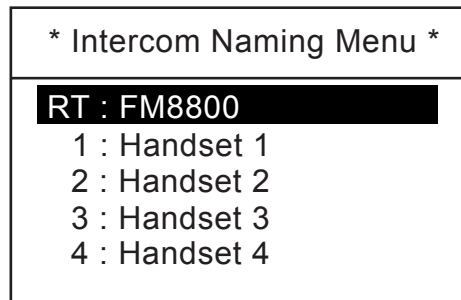

4. Rotate the **CH** knob (or press up / down arrow key) to choose a handset number and press the **ENT** key.
5. Key in remote station name with alphanumeric keys and press the **ENT** key.
6. Repeat steps 4 and 5 to name other handsets.

To change the default name, for example, "1: Handset 1", rotate the CH knob to move the cursor to right of "1".

1: Handset 1__
↑

Move cursor here. And then press the ▼ key to delete the characters.
Enter a new name for the remote station.

5.4 Displaying Program Version

1. Press the **MENU** key.

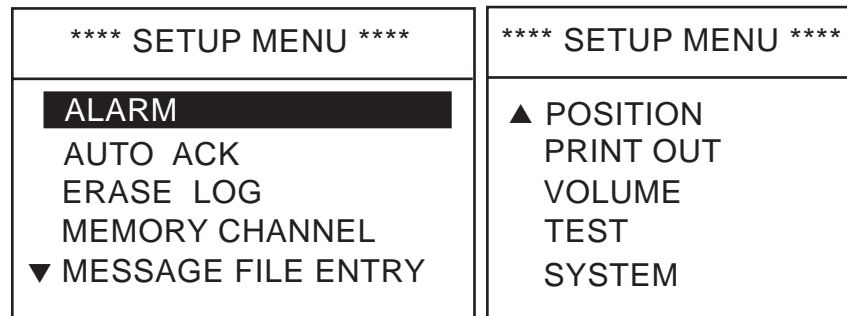

2. Rotate the **CH** knob to choose SYSTEM and press the **ENT** key. The following selection window appears.

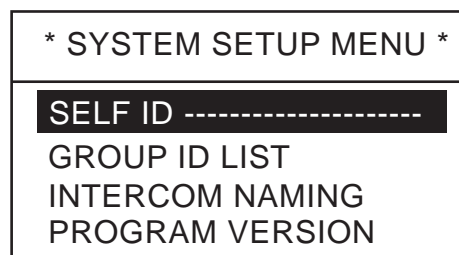

3. Rotate the **CH** knob to choose PROGRAM VERSION and press the **ENT** key to show program version number.

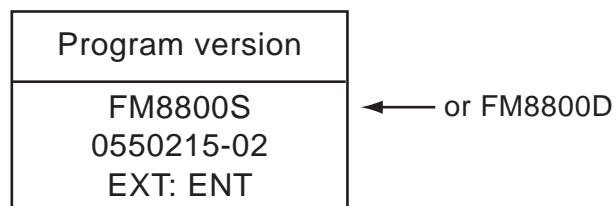

Program version

4. Press the **ENT** key to exit.

5. SYSTEM SETUP

This page is intentionally left blank.

6. MAINTENANCE & TROUBLESHOOTING

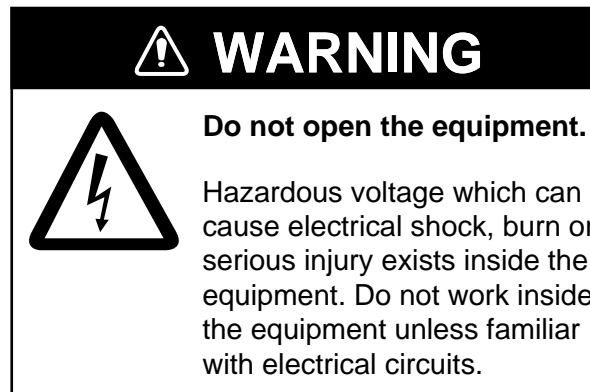

6.1 Maintenance

Periodic checks

- 1) Check that each connector is firmly connected.
- 2) Clean corroded or soiled connectors.
- 3) Check coaxial cable for damage. If damaged, replace.
- 4) Check that bolts fixing the antenna are firmly tightened.

6.2 Troubleshooting

When the power cannot be turned on

- 1) Check if power plug is firmly connected.
- 2) Check fuses in the power cable. If it has tripped, replace it with a new one (15A).
- 3) If power cannot be turned on (after checking 1 and 2), contact a FURUNO agent or representative for advice.

6.3 Daily Test

Authorities require that the DSC be checked daily for proper operation to ensure that it will function properly in the event of distress. Execute the daily test as below.

1. At the standby display, press the **SHIFT** key and **TEST** key in that order. The following display appears for test. And distress alarm (visual and audible) occurs.

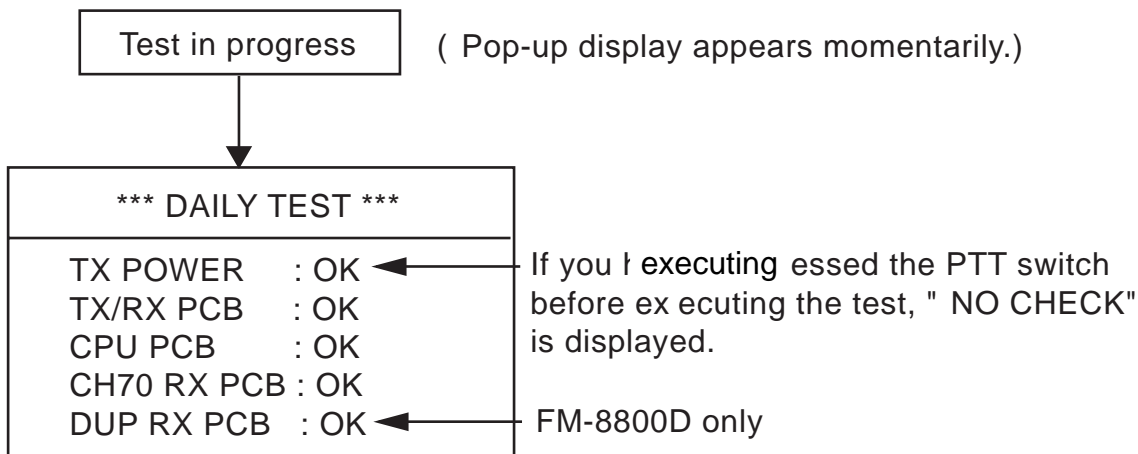

Result of daily test

2. To stop ALARM, press the **CANCEL** key.
3. To stop the daily test, press the **CANCEL** key.

“NG” may be displayed depending on the receiving conditions. In this case, repeat the daily test a couple of times. If NG is displayed always, contact a FURUNO agent or representative for advice.

The table below shows the abnormal indications and causes shown in the daily test.

Indication	Cause
TX POWER: NG	Indicates no transmitting output power. PA module or TX/RX pcb 05P0774 may be damaged.
TX/RX PCB: NG	Indicates abnormal PLL circuit in the TX/RX pcb. TX/RX pcb 05P0774 may be damaged.
CPU PCB: NG	Indicates abnormal loop circuit inside the CPU board. CPU pcb 05P0773 may be damaged.
CH70 RX PCB: NG	Indicates abnormal loop circuit between CPU and CH70 RX pcb. CH70 RX pcb 05P0775 may be damaged.
DUP RX PCB: NG	Indicates abnormal PLL circuit in the DUP RX pcb. DUP RX pcb 05P0777 may be damaged.

If necessary, refer to Parts Location on subsequent pages.

6.4 Error Message

The table below shows all the error messages which may appear.

Error message	Meaning
PLL1 Unlock	PLL circuit on the TX/RX pcb 05P0774 has unlocked.
PLL2 Unlock	PLL circuit on the DUP RX pcb 05P0777 has unlocked (only FM-8800D).
ANT ERROR	The antenna is abnormal. In this condition, if the transmission continues more than five seconds, the output power is reduced to approximately 10W.
GPS ERROR	There is no L/L input from a positioning sensor for more than one minute.
System Error	The DSP (digital signal processor) is abnormally.
Printer PE	Printer is disconnected or paper runs out.

Note: If the CPU is abnormal, the beep sounds continuously until turning off the power.

6.5 Parts Location

Transceiver unit FM-8800D/8800S

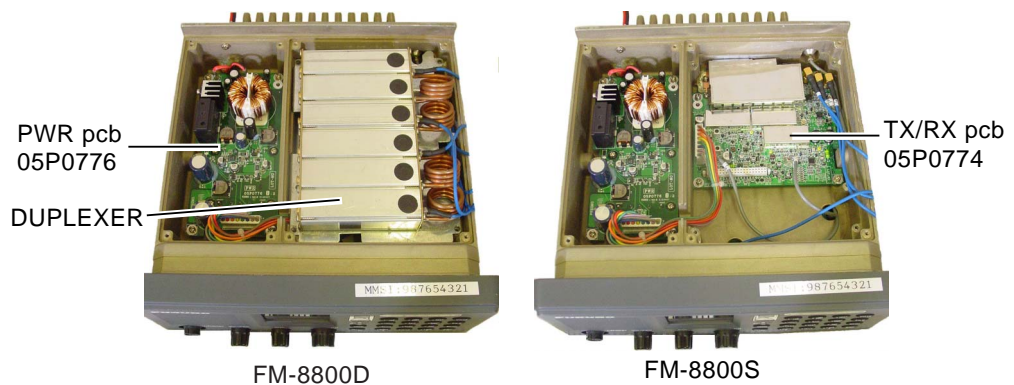

Top cover removed

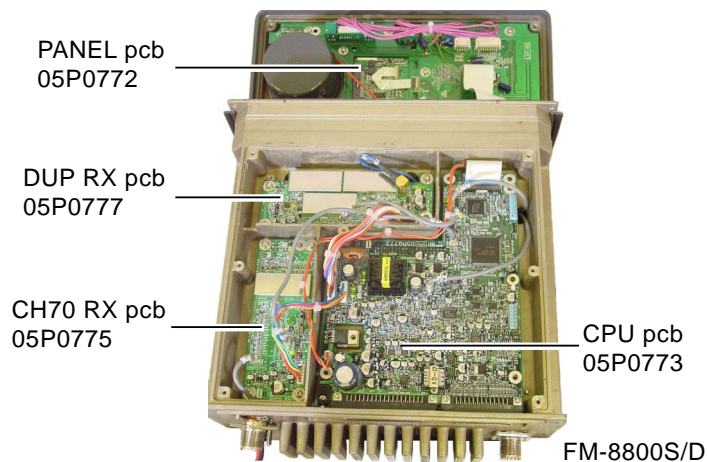

Bottom cover removed

Handset HS-2003

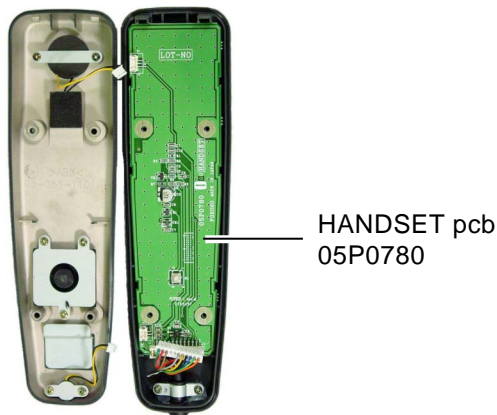

Remote station RB-8800/RB-8810

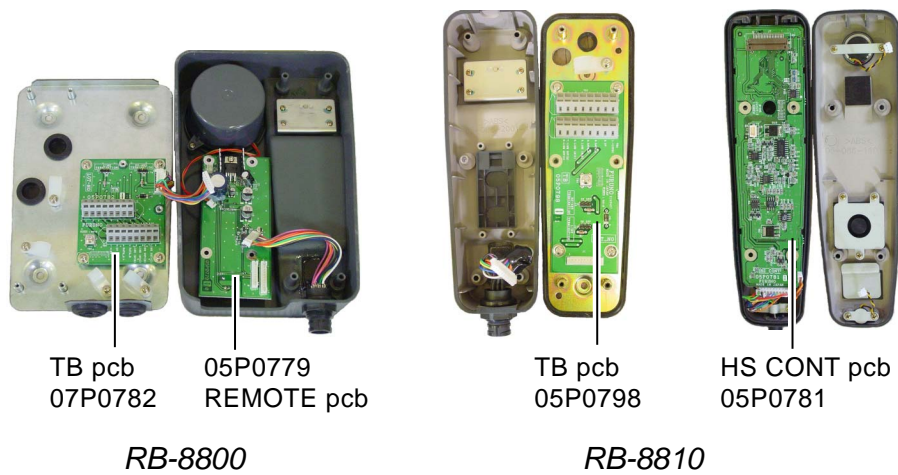

Junction box IF-8810

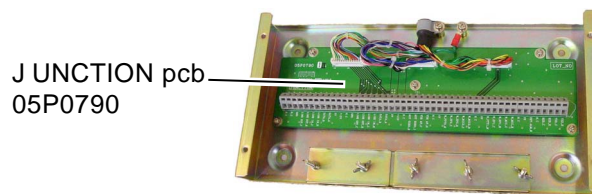

DMC Interface IF-8820

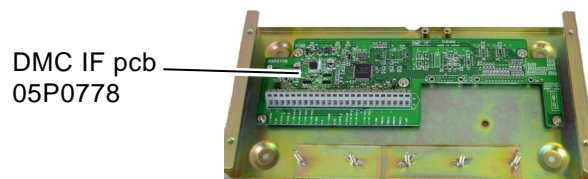

APPENDIX

Menu Tree

Bold: Default

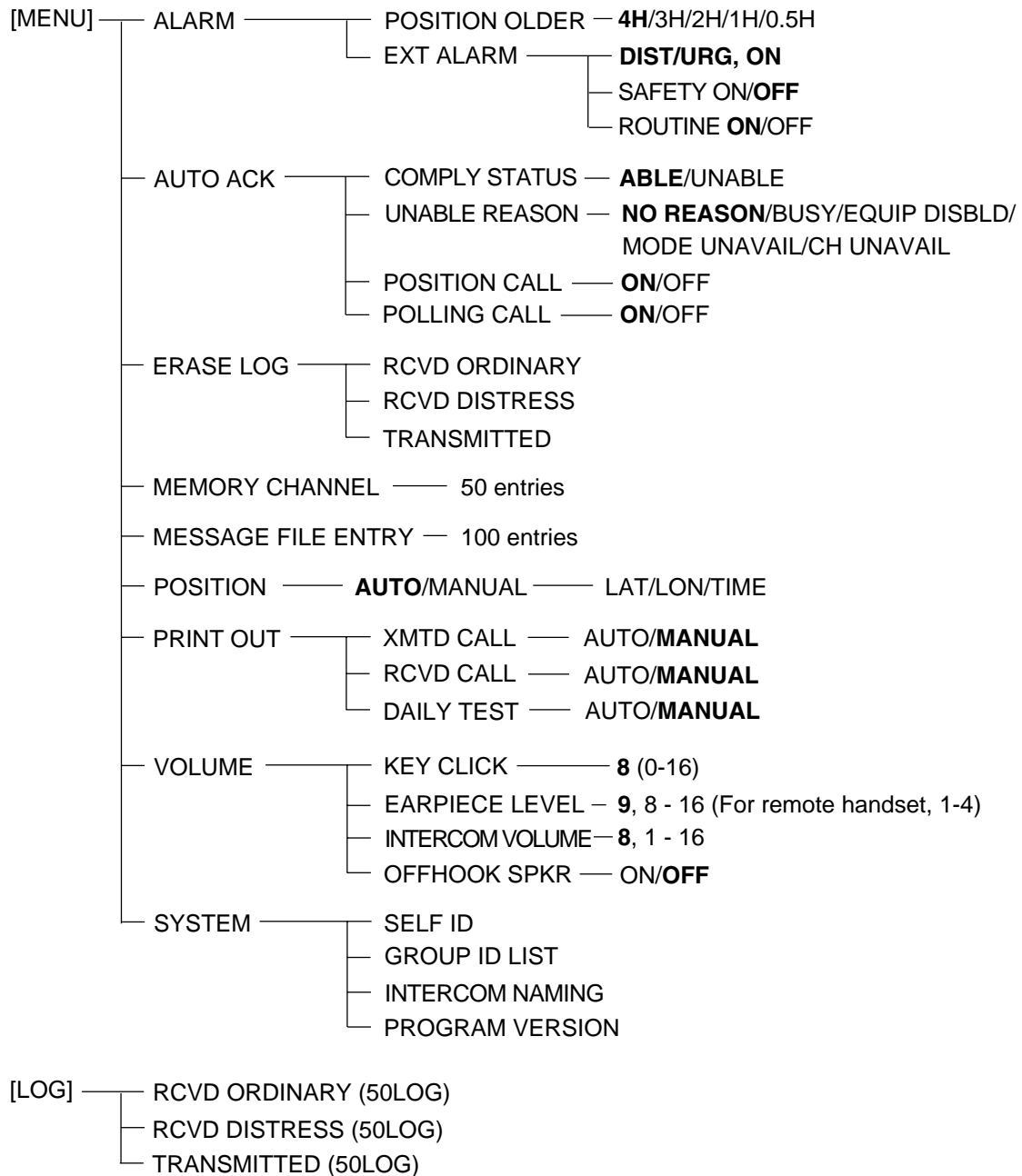

APPENDIX

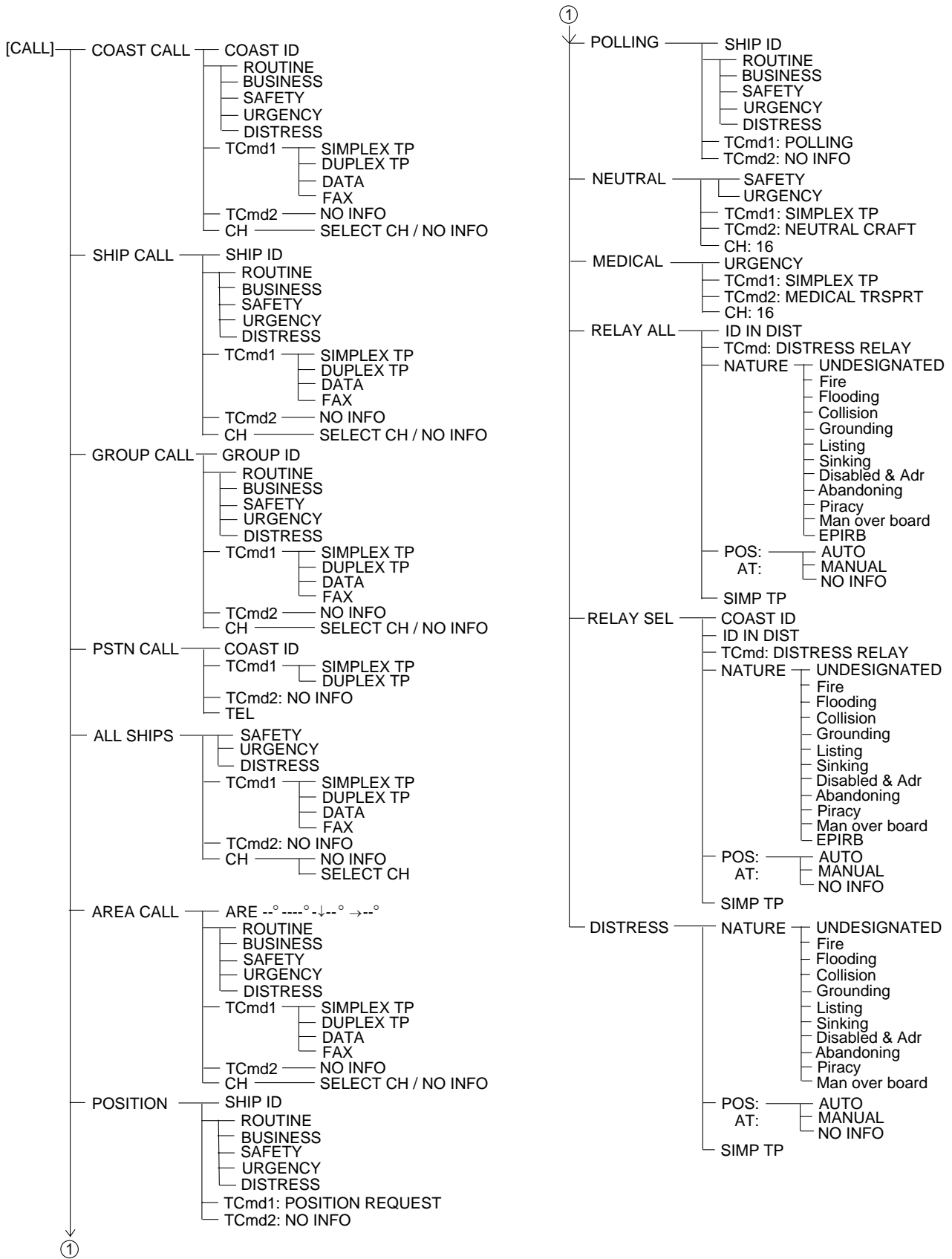

Marine VHF Channel Lists

1) International Channels

CH	TX MHz	RX MHz	Remark	CH	TX MHz	RX MHz	Remark
01	156.050	160.650		60	156.025	160.625	
02	156.100	160.700		61	156.075	160.675	
03	156.150	160.750		62	156.125	160.725	
04	156.200	160.800		63	156.175	160.775	
05	156.250	160.850		64	156.225	160.825	
06	156.300	156.300		65	156.275	160.875	
07	156.350	160.950		66	156.325	160.925	
08	156.400	156.400		67	156.375	156.375	
09	156.450	156.450		68	156.425	156.425	
10	156.500	156.500		69	156.475	156.475	
11	156.550	156.550		70	-	156.525	DSC
12	156.600	156.600		71	156.575	156.575	
13	156.650	156.650		72	156.625	156.625	
14	156.700	156.700		73	156.675	156.675	
15	156.750	156.750	Low PWR	74	156.725	156.725	
16	156.800	156.800		75	156.775	156.775	Low PWR
17	156.850	156.850	Low PWR	76	156.825	156.825	Low PWR
18	156.900	161.500		77	156.875	156.875	
19	156.950	161.550		78	156.925	161.525	
20	157.000	161.600		79	156.975	161.575	
21	157.050	161.650		80	157.025	161.625	
22	157.100	161.700		81	157.075	161.675	
23	157.150	161.750		82	157.125	161.725	
24	157.200	161.800		83	157.175	161.775	
25	157.250	161.850		84	157.225	161.825	
26	157.300	161.900		85	157.275	161.875	
27	157.350	161.950		86	157.325	161.925	
28	157.400	162.000		87	157.375	157.375	
				88	157.425	157.425	

APPENDIX

2) USA Channels

CH	TX MHz	RX MHz	Remark	CH	TX MHz	RX MHz	Remark
01	156.050	156.050		60	-	-	
02	-	-		61	-	-	
03	-	-		62	-	-	
04	-	-		63	156.175	156.175	
05	156.250	156.250		64	-	-	
06	156.300	156.300		65	156.275	156.275	
07	156.350	156.350		66	156.325	156.325	
08	156.400	156.400		67	156.375	156.375	Low PWR
09	156.450	156.450		68	156.425	156.425	
10	156.500	156.500		69	156.475	156.475	
11	156.550	156.550		70	-	156.525	DSC
12	156.600	156.600		71	156.575	156.575	
13	156.650	156.650	Low PWR	72	156.625	156.625	
14	156.700	156.700		73	156.675	156.675	
15	-	156.750		74	156.725	156.725	
16	156.800	156.800		75	-	-	
17	156.850	156.850	Low PWR	76	-	-	
18	156.900	156.900		77	156.875	156.875	Low PWR
19	156.950	156.950		78	156.925	156.925	
20	157.000	157.000		79	156.975	156.975	
21	157.050	157.050		80	157.025	157.025	
22	157.100	157.100		81	157.075	157.075	
23	157.150	157.150		82	157.125	157.125	
24	157.200	161.800		83	157.175	157.175	
25	157.250	161.850		84	157.225	161.825	
26	157.300	161.900		85	157.275	161.875	
27	157.350	161.950		86	157.325	161.925	
28	157.400	162.000		87	157.375	157.375	
				88	157.425	157.425	

US Weather Channels

WX	RX MHz	WX	RX MHz
01	162.550	06	162.500
02	162.400	07	162.525
03	162.475	08	161.650
04	162.425	09	161.775
05	162.450	10	163.275

3) Canadian Channels

CH	TX MHz	RX MHz	Remark	CH	TX MHz	RX MHz	Remark
01	156.050	160.650		60	156.025	160.625	
02	156.100	160.700		61	156.075	156.075	
03	156.150	160.750		62	156.125	156.125	
04	156.200	156.200		63			
05	156.250	156.250		64	156.225	156.225	
06	156.300	156.300		65	156.275	156.275	Low PWR
07	156.350	156.350		66	156.325	156.325	
08	156.400	156.400		67	156.375	156.375	
09	156.450	156.450		68	156.425	156.425	
10	156.500	156.500		69	156.475	156.475	
11	156.550	156.550		70	-	156.525	DSC
12	156.600	156.600		71	156.575	156.575	
13	156.650	156.650		72	156.625	156.625	
14	156.700	156.700		73	156.675	156.675	
15	156.750	156.750	Low PWR	74	156.725	156.725	
16	156.800	156.800		75	-	-	
17	156.850	156.850	Low PWR	76	-	-	
18	156.900	156.900		77	156.875	156.875	Low PWR
19	156.950	156.950		78	156.925	156.925	
20	157.000	161.600	Low PWR	79	156.975	156.975	
21	157.050	157.050		80	157.025	157.025	
22	157.100	157.100		81	157.075	157.075	
23	157.150	161.750		82	157.125	157.125	
24	157.200	161.800		83	157.175	157.175	
25	157.250	161.850		84	157.225	161.825	
26	157.300	161.900		85	157.275	161.875	
27	157.350	161.950		86	157.325	161.925	
28	157.400	162.000		87	157.375	157.375	
				88	157.425	157.425	

APPENDIX

4) Inland waterways (INLND-WA) Channels

CH	TX MHz	RX MHz	Remark	CH	TX MHz	RX MHz	Remark
01	156.050	160.650		60	156.025	160.625	
02	156.100	160.700		61	156.075	160.675	
03	156.150	160.750		62	156.125	160.725	
04	156.200	160.800		63	156.175	160.775	
05	156.250	160.850		64	156.225	160.825	
06	156.300	156.300	Low PWR	65	156.275	160.875	
07	156.350	160.950		66	156.325	160.925	
08	156.400	156.400	Low PWR	67	156.375	156.375	
09	156.450	156.450		68	156.425	156.425	
10	156.500	156.500	Low PWR	69	156.475	156.475	
11	156.550	156.550	Low PWR	70	-	156.525	DSC
12	156.600	156.600	Low PWR	71	156.575	156.575	Low PWR
13	156.650	156.650	Low PWR	72	156.625	156.625	Low PWR
14	156.700	156.700	Low PWR	73	156.675	156.675	
15	156.750	156.750	Low PWR	74	156.725	156.725	Low PWR
16	156.800	156.800		75	-	-	
17	156.850	156.850	Low PWR	76	-	-	
18	156.900	161.500		77	156.875	156.875	Low PWR
19	156.950	161.550		78	156.925	161.525	
20	157.000	161.600		79	156.975	161.575	
21	157.050	161.650		80	157.025	161.625	
22	157.100	161.700		81	157.075	161.675	
23	157.150	161.750		82	157.125	161.725	
24	157.200	161.800		83	157.175	161.775	
25	157.250	161.850		84	157.225	161.825	
26	157.300	161.900		85	157.275	161.875	
27	157.350	161.950		86	157.325	161.925	
28	157.400	162.000		87	157.375	157.375	
				88	157.425	157.425	

5) Private Channels

Note: Bold for FM-8800D duplex TX frequencies

TX		RX				CH NO (current)	Remark
FM-8800S	FM-8800D	FM-8800S		FM-8800D			
Simplex	Sim/Dup	Simplex	Semi-dup	Simplex	Duplex		
155.000		155.000	159.600			180	
155.025		155.025	159.625			181	
155.050		155.050	159.650			182	
155.075		155.075	159.675			183	
155.100		155.100	159.700			184	
155.125		155.125	159.725			185	
155.150		155.150	159.750			186	
155.175		155.175	159.775			187	
155.200		155.200	159.800			188	
155.225		155.225	159.825			189	
155.250		155.250	159.850			190	
155.275		155.275	159.875			191	
155.300		155.300	159.900			192	
155.325		155.325	159.925			193	
155.350		155.350	159.950			194	
155.375		155.375	159.975			195	
155.400	155.400	155.400	160.000	155.400		196	
155.425	155.425	155.425	160.025	155.425		197	
155.450	155.450	155.450	160.050	155.450		198	
155.475	155.475	155.475	160.075	155.475		199	
155.500	155.500	155.500	160.100	155.500		120(L1)	
155.525	155.525	155.525	160.125	155.525		121(L2)	
155.550	155.550	155.550	160.150	155.550		122	
155.575	155.575	155.575	160.175	155.575		123	
155.600	155.600	155.600	160.200	155.600		124	
155.625	155.625	155.625	160.225	155.625		125(F1)(P1)	
155.650	155.650	155.650	160.250	155.650		126(L3)	
155.675	155.675	155.675	160.275	155.675		127	
155.700	155.700	155.700	160.300	155.700		128	
155.725	155.725	155.725	160.325	155.725		129	
155.750	155.750	155.750	160.350	155.750		130	
155.775	155.775	155.775	160.375	155.775		131(F2)(P2)	
155.800	155.800	155.800	160.400	155.800		132	
155.825	155.825	155.825	160.425	155.825		133(F3)(P3)	
155.850	155.850	155.850	160.450	155.850		134	
155.875	155.875	155.875	160.475	155.875		135	
155.900	155.900	155.900	160.500	155.900		136	
155.925	155.925	155.925	160.525	155.925		137	
155.950	155.950	155.950	160.550	155.950		138	

- Continued -

APPENDIX

TX		RX				CH NO (current)	Remark
FM-8800S	FM-8800D	FM-8800S		FM-8800D			
Simplex	Sim/Dup	Simplex	Semi-dup	Simplex	Duplex		
155.975	155.975	155.975	160.575	155.975		139	
156.000	156.000	156.000	160.600	156.000	160.600	00	Min DUPch
156.025	156.025	156.025	160.625	156.025	160.625	60	
156.050	156.050	156.050	160.650	156.050	160.650	01	
156.075	156.075	156.075	160.675	156.075	160.675	61	
156.100	156.100	156.100	160.700	156.100	160.700	02	
156.125	156.125	156.125	160.725	156.125	160.725	62	
156.150	156.150	156.150	160.750	156.150	160.750	03	
156.175	156.175	156.175	160.775	156.175	160.775	63	
156.200	156.200	156.200	160.800	156.200	160.800	04	
156.225	156.225	156.225	160.825	156.225	160.825	64	
156.250	156.250	156.250	160.850	156.250	160.850	05	
156.275	156.275	156.275	160.875	156.275	160.875	65	
156.300	156.300	156.300	160.900	156.300	160.900	06	
156.325	156.325	156.325	160.925	156.325	160.925	66	
156.350	156.350	156.350	160.950	156.350	160.950	07	
156.375	156.375	156.375	160.975	156.375	160.975	67	
156.400	156.400	156.400	161.000	156.400	161.000	08	
156.425	156.425	156.425	161.025	156.425	161.025	68	
156.450	156.450	156.450	161.050	156.450	161.050	09	
156.475	156.475	156.475	161.075	156.475	161.075	69	
156.500	156.500	156.500	161.100	156.500	161.100	10	
156.525	156.525	156.525	161.125	156.525	161.125	70	
156.550	156.550	156.550	161.150	156.550	161.150	11	
156.575	156.575	156.575	161.175	156.575	161.175	71	
156.600	156.600	156.600	161.200	156.600	161.200	12	
156.625	156.625	156.625	161.225	156.625	161.225	72	
156.650	156.650	156.650	161.250	156.650	161.250	13	
156.675	156.675	156.675	161.275	156.675	161.275	73	
156.700	156.700	156.700	161.300	156.700	161.300	14	
156.725	156.725	156.725	161.325	156.725	161.325	74	
156.750	156.750	156.750	161.350	156.750	161.350	15	
156.775	156.775	156.775	161.375	156.775	161.375	75	
156.800	156.800	156.800	161.400	156.800	161.400	16	
156.825	156.825	156.825	161.425	156.825	161.425	76	
156.850	156.850	156.850	161.450	156.850	161.450	17	
156.875	156.875	156.875	161.475	156.875	161.475	77	
156.900	156.900	156.900	161.500	156.900	161.500	18	
156.925	156.925	156.925	161.525	156.925	161.525	78	
156.950	156.950	156.950	161.550	156.950	161.550	19	

- Continued -

TX		RX				CH NO (current)	Remark
FM-8800S	FM-8800D	FM-8800S		FM-8800D			
Simplex	Sim/Dup	Simplex	Semi-dup	Simplex	Duplex		
156.975	156.975	156.975	161.575	156.975	161.575	79	
157.000	157.000	157.000	161.600	157.000	161.600	20	
157.025	157.025	157.025	161.625	157.025	161.625	80	
157.050	157.050	157.050	161.650	157.050	161.650	21	
157.075	157.075	157.075	161.675	157.075	161.675	81	
157.100	157.100	157.100	161.700	157.100	161.700	22	
157.125	157.125	157.125	161.725	157.125	161.725	82	
157.150	157.150	157.150	161.750	157.150	161.750	23	
157.175	157.175	157.175	161.775	157.175	161.775	83	
157.200	157.200	157.200	161.800	157.200	161.800	24	
157.225	157.225	157.225	161.825	157.225	161.825	84	
157.250	157.250	157.250	161.850	157.250	161.850	25	
157.275	157.275	157.275	161.875	157.275	161.875	85	
157.300	157.300	157.300	161.900	157.300	161.900	26	
157.325	157.325	157.325	161.925	157.325	161.925	86	
157.350	157.350	157.350	161.950	157.350	161.950	27	
157.375	157.375	157.375	161.975	157.375	161.975	87	
157.400	157.400	157.400	162.000	157.400	162.000	28	
157.425	157.425	157.425	162.025	157.425	162.025	88	
157.450	157.450	157.450	162.050	157.450	162.050	29	
157.475	157.475	157.475	162.075	157.475	162.075	89	
157.500	157.500	157.500	162.100	157.500	162.100	30	Max DUPch
157.525	157.525	157.525	162.125	157.525		90	
157.550	157.550	157.550	162.150	157.550		31	
157.575	157.575	157.575	162.175	157.575		91	
157.600	157.600	157.600	162.200	157.600		32	
157.625	157.625	157.625	162.225	157.625		92	
157.650	157.650	157.650	162.250	157.650		33	
157.675	157.675	157.675	162.275	157.675		93	
157.700	157.700	157.700	162.300	157.700		34	
157.725	157.725	157.725	162.325	157.725		94	
157.750	157.750	157.750	162.350	157.750		35	
157.775	157.775	157.775	162.375	157.775		95	
157.800	157.800	157.800	162.400	157.800		36	
157.825	157.825	157.825	162.425	157.825		96	
157.850	157.850	157.850	162.450	157.850		37	
157.875	157.875	157.875	162.475	157.875		97	
157.900	157.900	157.900	162.500	157.900		38	
157.925	157.925	157.925	162.525	157.925		98	
157.950	157.950	157.950	162.550	157.950		39	

- Continued -

APPENDIX

TX		RX				CH NO (current)	Remark
FM-8800S	FM-8800D	FM-8800S		FM-8800D			
Simplex	Sim/Dup	Simplex	Semi-dup	Simplex	Duplex		
157.975	157.975	157.975	162.575	157.975		99	
158.000	158.000	158.000	162.600	158.000		40	
158.025		158.025	162.625	158.025		100	
158.050		158.050	162.650	158.050		41	
158.075		158.075	162.675	158.075		101	
158.100		158.100	162.700	158.100		42	
158.125		158.125	162.725	158.125		102	
158.150		158.150	162.750	158.150		43	
158.175		158.175	162.775	158.175		103	
158.200		158.200	162.800	158.200		44	
158.225		158.225	162.825	158.225		104	
158.250		158.250	162.850	158.250		45	
158.275		158.275	162.875	158.275		105	
158.300		158.300	162.900	158.300		46	
158.325		158.325	162.925	158.325		106	
158.350		158.350	162.950	158.350		47	
158.375		158.375	162.975	158.375		107	
158.400		158.400	163.000	158.400		48	
158.425		158.425	163.025	158.425		108	
158.450		158.450	163.050	158.450		49	
158.475		158.475	163.075	158.475		109	
158.500		158.500	163.100	158.500		50	
158.525		158.525	163.125	158.525		110	
158.550		158.550	163.150	158.550		51	
158.575		158.575	163.175	158.575		111	
158.600		158.600	163.200	158.600		52	
158.625		158.625	163.225	158.625		112	
158.650		158.650	163.250	158.650		53	
158.675		158.675	163.275	158.675		113	
158.700		158.700	163.300	158.700		54	
158.725		158.725	163.325	158.725		114	
158.750		158.750	163.350	158.750		55	
158.775		158.775	163.375	158.775		115	
158.800		158.800	163.400	158.800		56	
158.825		158.825	163.425	158.825		116	
158.850		158.850	163.450	158.850		57	
158.875		158.875	163.475	158.875		117	
158.900		158.900	163.500	158.900		58	
158.925		158.925	163.525	158.925		118	
158.950		158.950	163.550	158.950		59	

- Continued -

TX		RX				CH NO (current)	Remark
FM-8800S	FM-8800D	FM-8800S		FM-8800D			
Simplex	Sim/Dup	Simplex	Semi-dup	Simplex	Duplex		
158.975		158.975	163.575	158.975		119	
159.000		159.000	163.600	159.000		200	RX.max.freq
159.025		159.025		159.025		201	
159.050		159.050		159.050		202	
159.075		159.075		159.075		203	
159.100		159.100		159.100		204	
159.125		159.125		159.125		205	
159.150		159.150		159.150		206	
159.175		159.175		159.175		207	
159.200		159.200		159.200		208	
159.225		159.225		159.225		209	
159.250		159.250		159.250		210	
159.275		159.275		159.275		211	
159.300		159.300		159.300		212	
159.325		159.325		159.325		213	
159.350		159.350		159.350		214	
159.375		159.375		159.375		215	
159.400		159.400		159.400		216	
159.425		159.425		159.425		217	
159.450		159.450		159.450		218	
159.475		159.475		159.475		219	
159.500		159.500		159.500		220	
159.525		159.525		159.525		221	
159.550		159.550		159.550		222	
159.575		159.575		159.575		223	
159.600		159.600		159.600		224	
159.625		159.625		159.625		225	
159.650		159.650		159.650		226	
159.675		159.675		159.675		227	
159.700		159.700		159.700		228	
159.725		159.725		159.725		229	
159.750		159.750		159.750		230	
159.775		159.775		159.775		231	
159.800		159.800		159.800		232	
159.825		159.825		159.825		233	
159.850		159.850		159.850		234	
159.875		159.875		159.875		235	
159.900		159.900		159.900		236	
159.925		159.925		159.925		237	
159.950		159.950		159.950		238	

- Continued -

APPENDIX

TX		RX				CH NO (current)	Remark
FM-8800S	FM-8800D	FM-8800S		FM-8800D			
Simplex	Sim/Dup	Simplex	Semi-dup	Simplex	Duplex		
159.975		159.975		159.975		239	
160.000		160.000		160.000		240	
160.025		160.025		160.025		241	
160.050		160.050		160.050		242	
160.075		160.075		160.075		243	
160.100		160.100		160.100		244	
160.125		160.125		160.125		245	
160.150		160.150		160.150		246	
160.175		160.175		160.175		247	
160.200		160.200		160.200		248	
160.225		160.225		160.225		249	
160.250		160.250		160.250		250	
160.275		160.275		160.275		251	
160.300		160.300		160.300		252	
160.325		160.325		160.325		253	
160.350		160.350		160.350		254	
160.375		160.375		160.375		255	
160.400		160.400		160.400		256	Added ch no.
160.425		160.425		160.425		257	Added ch no.
160.450		160.450		160.450		258	Added ch no.
160.475		160.475		160.475		259	Added ch no.
160.500		160.500		160.500		140	
160.525		160.525		160.525		141	
160.550		160.550		160.550		142	
160.575		160.575		160.575		143	
160.600		160.600		160.600		144	
160.625		160.625		160.625		145	
160.650		160.650		160.650		146	
160.675		160.675		160.675		147	
160.700		160.700		160.700		148	
160.725		160.725		160.725		149	
160.750		160.750		160.750		150	
160.775		160.775		160.775		151	
160.800		160.800		160.800		152	
160.825		160.825		160.825		153	
160.850		160.850		160.850		154	
160.875		160.875		160.875		155	
160.900		160.900		160.900		156	
160.925		160.925		160.925		157	
160.950		160.950		160.950		158	

- Continued -

TX		RX				CH NO (current)	Remark
FM-8800S	FM-8800D	FM-8800S		FM-8800D			
Simplex	Sim/Dup	Simplex	Semi-dup	Simplex	Duplex		
160.975		160.975		160.975		159	
161.000		161.000		161.000		160	
161.025		161.025		161.025		161	
161.050		161.050		161.050		162	
161.075		161.075		161.075		163	
161.100		161.100		161.100		164	
161.125		161.125		161.125		165	
161.150		161.150		161.150		166	
161.175		161.175		161.175		167	
161.200		161.200		161.200		168	
161.225		161.225		161.225		169	
161.250		161.250		161.250		170	
161.275		161.275		161.275		171	
161.300		161.300		161.300		172	
161.325		161.325		161.325		173	
161.350		161.350		161.350		174	
161.375		161.375		161.375		175	
161.400		161.400		161.400		176	
161.425		161.425		161.425		177(M2)	
161.450		161.450		161.450		178	
161.475		161.475		161.475		179	

Digital Interface (IEC 61162-1 Edition 2)

Input sentences

GGA, GLL, RMC, ZDA, GNS

Schematic diagram

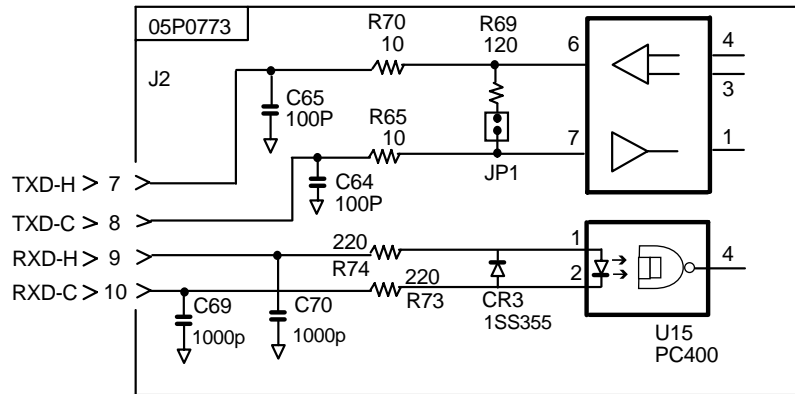

Load requirements as listner

Isolation	Optocoupler
Input impedance	560 ohms
Max. Voltage	±15V
Threshold	4 mA

Output sentence

TLL

GGA - Global positioning system (GPS) fix data

```
$--GGA,hhmmss.ss,lll.lll,a,yyyyy.yyy,a,x,xx,x.x,x.x,M,x.x,M,x.x,xxxx*hh<CR><LF>
```

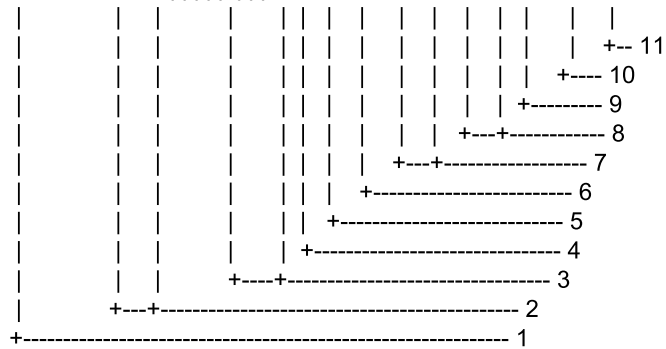

1. UTC of position
2. Latitude, N/S
3. Longitude, E/W
4. GPS quality indicator (see note)
5. Number of satellite in use,00-12, may be different from the number in view
6. Horizontal dilution of precision
7. Antenna altitude above/below mean sealevel, m
8. Geoidal separation, m
9. Age of differential GPS data
10. Differential reference station ID, 0000-1023
11. Checksum

NOTE

- 0 = fix not available or invalid
- 1 = GPS SPS mode, fix valid
- 2 = differential GPS, SPS mode, fix valid
- 3 = GPS PPS mode, fix valid
- 4 = Real Time Kinetic. Satellite system used in RTK mode with fixed integers
- 5 = Float RTK. Satellite system used in RTK mode with floating fingers
- 6 = Estimated (dead reckoning) mode
- 7 = Manual input mode
- 8 = Simulator mode

The GPS quality indicator shall not be a null field.

RMC - Recommended minimum specific GPS/TRANSIT data

```
$--RMC,hhmmss.ss,A,lll.lll,a,yyyy.yy,a,x .x .x .x .x .x .x .x .x ,a*hh<CR><LF>
```

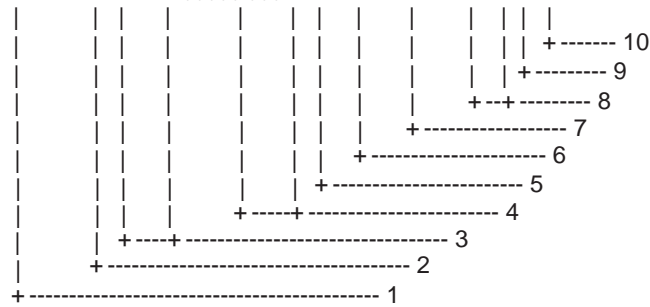

1. UTC of position fix
2. Status: A= data valid, V= navigation receiver warning
3. Latitude, N/S
4. Longitude, E/W
5. Speed over ground, knots
6. Course over ground, degrees true
7. Date: dd/mm/yy
8. Magnetic variation, degree E/W
9. Mode indicator(see note)
10. Checksum

NOTE Positioning system Mode indicator:

- A = Autonomous
- D = Differential
- E = Estimated (dead reckoning)
- M = Manual input
- S = Simulator
- N = Data not valid

The Mode indicator field supplements the Status field. The Status field shall be set to V= invalid for all values of Operating Mode except for A= Autonomous and D=Differential. The positioning system Mode indicator and Status field shall not be null fields.

ZDA - Time and data

```
$--ZDA,hhmmss.ss,xx,xx,xxxx,xx,xx*hh<CR><LF>
```

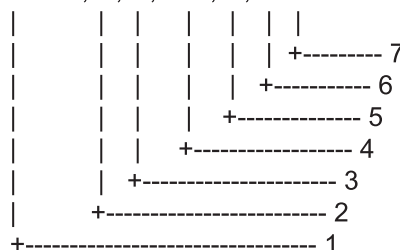

1. UTC
2. Day, 01 to 31(UTC)
3. Month, 01 to 12(UTC)
4. Year(UTC)
5. Local zone hours, 00h to +-13h
6. Local zone minutes, 00 to +59
as local hours
7. Checksum

TLL – Target latitude and longitude

\$--TLL,x x ,lll.lll,a,yyyyy.yyy,a,c--c,hhmmss.ss,a,a*hh<CR><LF>

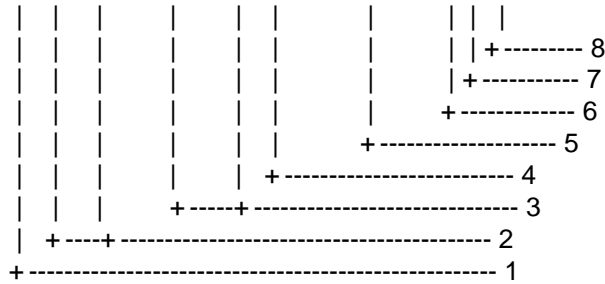

1. Target number 00 - 99
- 2. Latitude, N/S**
- 3. Longitude, E/W**
4. Target name
5. UTC of data
6. Target status(see note)
7. Reference target= R,null otherwise
8. Checksum

NOTE - Target status

- L = lost, tracked target has beenlost
- Q = query, target in the process of acquisition
- T = tracking

INDEX

A

- Able acknowledge call.....3-5
- ACK BQ3-7
- Alarm setup.....4-1
- All ships call.....3-16
- Audio alarms.....1-6
- Auto ACK setup4-3
- Automatic acknowledge 1-11, 3-7

C

- Call key 1-11
- Cancel key1-6
- CH16 key1-9
- Channel modes1-7
- Coast call.....3-2
- Contrast1-2
- Controls1-2

D

- Daily Test6-2
- DIST ACK signal.....2-9
- Distress Alert2-1
- Distress communication2-3
- Distress key 1-10, 2-1
- Distress relay.....2-11
- DSC operational1-10
- Dual watch.....1-9

E

- Earpiece volume.....4-13
- Erasing logs.....4-5
- Error message.....6-3

F

- Front panel.....1-1

G

- Geographical area call3-19
- Group call3-10
- Group ID list.....5-1

I

- Intercom volume4-14

K

- Key click.....4-13

L

- LCD.....1-5
- Log file3-32
- Loudspeaker1-8

M

- Maintenance6-1
- Manually acknowledging3-8
- Medical transport call.....3-30
- Memory channel setup4-6
- Message file entry4-7

N

- Naming intercom5-2
- Nature of distress2-3
- Neutral craft call.....3-29

O

- Off-hook loudspeaker4-14
- Old position alarm.....4-1
- Output power1-8

P

- Polling call.....3-25
- Position call.....3-22
- Position setup4-11
- Print out setup.....4-12
- Priority.....1-12
- Program version5-3
- PSTN call.....3-13

R

- Remote station.....1-1

S

- Scanning1-9
- Self ID5-1
- Shift key1-7
- Ship call3-2
- Squelch1-8
- Standby display.....1-10

T

- Transceiver unit1-1
- Transmitting1-8
- Troubleshooting6-1

INDEX

U

Unable acknowledge call.....3-5

V

Volume..... 1-8

Volume setup.....4-13

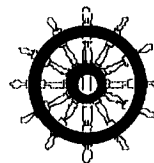
Declaration of conformity**0560**We **FURUNO ELECTRIC CO., LTD.**

(Manufacturer)

9-52 Ashihara-Cho, Nishinomiya City, 662-8580, Hyogo, Japan

(Address)

hereby declare under our sole responsibility that the products

VHF radiotelephone Types FM-8800S (simplex) and FM-8800D (duplex) consisting of Transceiver FM-8800S/FM-8800D, Handset HS-2003, Remote station RB-8810, Remote station with DISTRESS button RB-8800, Junction box IF-8810, DMC interface IF-8820, Handset for remote station HS-8800, AC power supply PR-240/PR-300, Printer PP-510 and Distress message controller DMC-5

(Model names, type numbers)

to which this declaration relates conform to the following standard(s) or normative document(s)

IMO Resolutions A.385(X), A.524(13), A.694(17), MSC.68(68), A.803(19) and IMO MSC Circular MSC/Circ.862

Testing standards EN 301 925: V1.1.1: 2002-09, EN 300 698-1 V1.3.1: 2003-12, EN 300 338 V1.2.1: 1999-04, EN 301 033 V1.1.1: 1998-08, EN 300 828 V1.1.1: 1998-03, EN 60945: 2002 (IEC 60945 4th edition: 2002-08) and EN 61162-1: 2000-07 (IEC 61162-1 2nd edition: 2000-07)

ITU-R Recommendations M.489-2, M.493-10, M.541-8 and M.689-2

(title and/or number and date of issue of the standard(s) or other normative document(s))

For assessment, see

- EC type-examination (MODULE-B) certificate N° 04212003/AA/00 of 18 October 2004 issued by Telefication, The Netherlands
- Production Quality System (MODULE D) Certificate No. P 112 of 20 August 2002 issued by Telefication, The Netherlands
- Test reports 99553530, 99553531, 99553532 and 99553533 of 15 October 2004 issued by Telefication, The Netherlands
- Test reports FLI 12-04-047 of 5 August 2004, FLI 12-04-052 of 16 September 2004 and FLI 12-04-057 of 12 October 2004 prepared by Furuno Labotech International Co., Ltd., Japan

This declaration is issued according to the provisions of European Council Directive 96/98/EC on marine equipment amended by the Commission Directive 2002/75/EC.

On behalf of Furuno Electric Co., Ltd.

Hiroaki Komatsu
Manager,
International Rules and RegulationsNishinomiya City, Japan
October 21, 2004

(Place and date of issue)

(name and signature or equivalent marking of authorized person)

Free Manuals Download Website

<http://myh66.com>

<http://usermanuals.us>

<http://www.somanuals.com>

<http://www.4manuals.cc>

<http://www.manual-lib.com>

<http://www.404manual.com>

<http://www.luxmanual.com>

<http://aubethermostatmanual.com>

Golf course search by state

<http://golfingnear.com>

Email search by domain

<http://emailbydomain.com>

Auto manuals search

<http://auto.somanuals.com>

TV manuals search

<http://tv.somanuals.com>