

Full-Auto Electric Washing Machine

Model: DWF-200M/240M

INSTRUCTION MANUAL

- First applying the Radical Technology in the world ... go beyond washing, sterilize your clothes and deodorize a bad smell.
- First applying the Air Bubble Washing System in the world.
- Improving washing performance by more than 35%, while reducing power consumption by 40%.
- Applying One-Touch Operation System.
- Realizing calm washing through the innovational low-noise design.
- Before operating this washer, please read this instruction completely. Thank you

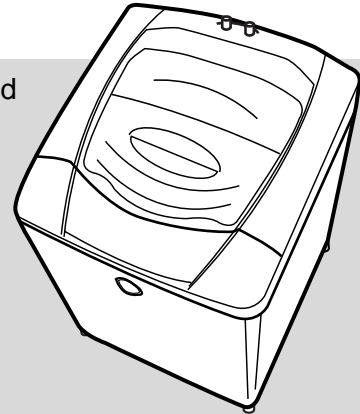

The First Radical Technology and Air Bubble Washing System in the World	CONTENTS	Page
<ul style="list-style-type: none"> ➤ Your washer is adopted the Radical Technology that can sterilize your clothes and deodorize a bad smell and prevent discoloration. ➤ Your washer is equipped with the bubble generator that generates a great deal of air bubble. ➤ The air bubbles knock the dirt out of the clothes during wash and they push up the heavy dirt to remove it during rinse. ➤ Because the double washing method using both air bubble & water current is applied to this washer, wash efficiency is excellent in comparison with the original washer system. 	<ul style="list-style-type: none"> PARTS AND FEATURES.....2 WASHER SAFETY.....3 INSTALLATION INSTRUCTIONS.....4 ELECTRICAL REQUIREMENTS.....5 INLET HOSE CONNECTION.....6 OPERATING YOUR WASHER.....7 THE FUNCTIONS OF THE CONTROL PANEL.....8 WASHING PROCEDURE AND COURSE SELECTION.....9 GENERAL PROCEDURE FOR OPERATION.....11 CARING FOR YOUR WASHER.....12 HOW TO CLEAN THE FILTER.....13 REMOVING STAINS.....14 TROUBLE SHOOTING.....15 SPECIFICATION.....16 	

A NOTE TO YOU

Thank you for buying a DAEWOO appliance.

DAEWOO washers are easy to use, save time, and help you manage your home better.

This manual contains valuable information about how to operate and maintain your washer properly and safely.

Please read it carefully.

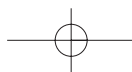

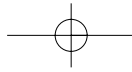

PARTS AND FEATURES



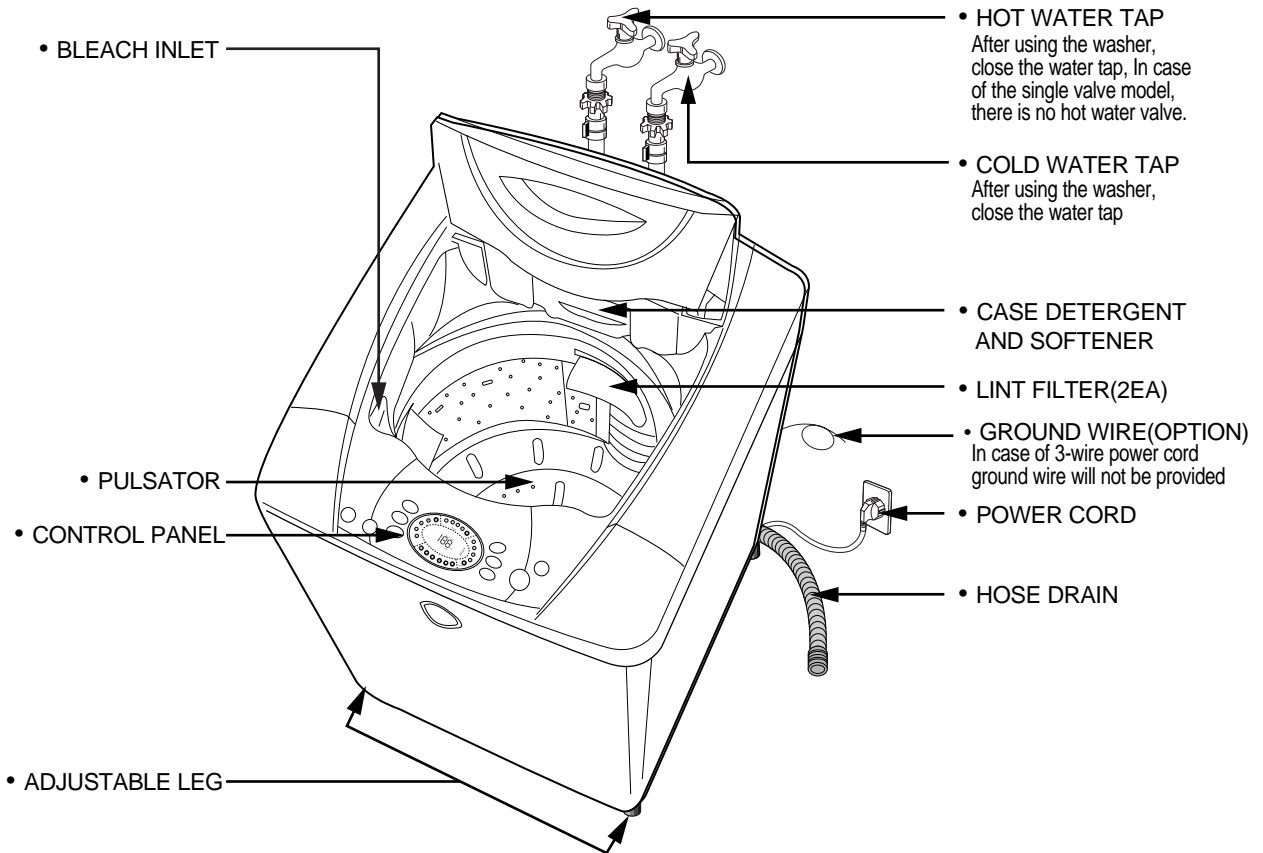

The parts and features of your washer are illustrated on this page. Become familiar with all parts and features before using your washer.

NOTE

- The drawings in this book may vary from your washer model. They are designed to show the different features of all models covered by this book, Your model may not include all features.

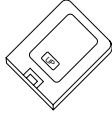
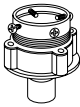
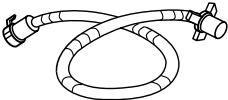
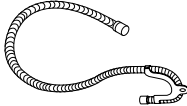

ACCESSORIES

DRYTEN (OPTION)	COVER UNDER (OPTION)	WATER TAP ADAPTER	INLET HOSE
			
HOSE DRAIN (FOR PUMP)	HOSE DRAIN CLAMP	HOSE DRAIN (FOR NON-PUMP)	CONNECTOR INLET(OPTION)
			

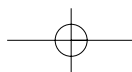

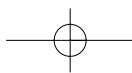

WASHER SAFETY

Save these instructions

Your safety is important to us.

To reduce the risk of fire, electrical shock, or injury when using your washer, follow basic precautions including the following:

Read all instructions before using your washer	
<ul style="list-style-type: none"> • Flammable fluids (dry-cleaning solvents, kerosene, gasoline, etc.) should not be used or stored in near your washer. Do not add flammable fluids to your wash water. These substances give off vapors that can create a fire hazard or explosion. • Do not allow children to operate, play with, or crawl on or inside your washer. Supervise children closely when your washer is used near them. • After starting a cycle, do not reach into the spin basket unless all motion stops. • Do not tamper with the controls. • If the supply cord is damaged, it must be replaced by the manufacturer or its service agent or a similarly qualified person in order to avoid a hazard • If the appliance is supplied from a cord extension set or electrical portable outlet device it should be positioned so it is not subjected to splashing or ingress of moisture. 	<p>Please ...</p> <ul style="list-style-type: none"> • Have only a qualified person install, repair, or replace parts on washer. • Maintain washer properly. • Protect washer from the weather and keep it where the temperature will not fall below freezing. • Do not install the washer at a place of extremely high humidity. It could cause an Electrical shock or a short circuit. • Connect washer to the correct outlet, electrical supply, water supply, and drain. • Ground washer properly.

Understanding your responsibilities

- Do not wash items that are soiled with vegetable or cooking oil. These items may contain some oil after laundering. Due to the remaining oil, the fabric may smoke or catch fire by itself.
- Do not use chlorine bleach and ammonia or acid (Such as vinegar or rust remover) in the same wash. Hazardous fumes can form.
- Unplug power supply cord before attempting to service your washer.
- Do not wash fiber glass materials. Small particles can stick to fabrics and cause skin irritation.
- Do not use hot water that temperature is over 50°C (120°F). It can cause a deformation of plastic parts.
- Do not spray water on the control panel and back cover of the washer. It can cause a fire or an electric shock.

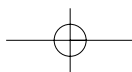

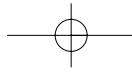

INSTALLATION INSTRUCTIONS

Location of washer

Check location where washer will be installed. Make sure you have everything necessary for correct installation.

Proper installation is your responsibility.

- Do not place or store your washer below 0°C (32°F) to avoid any damage from freezing.
- Install the washer on the horizontal solid floor.

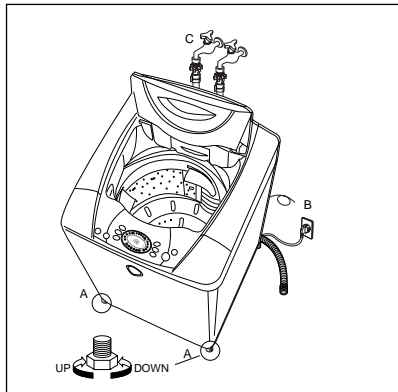

If the washer is installed on an unsuitable floor, it could make considerable noise, vibration and cause a malfunction. If washer is not level, adjust the front leg(A) up or down for horizontal setting.

- Earthed electrical outlet(B) is required with 20cm of bottom back of washer cabinet.
- Hot and cold water faucets (C) must be within 1M of the upper back of the washer cabinet and provide water pressure 0.3kgf/cm²-8kgf/cm² (29.4kPa-784.5kPa).

Drain system

Never forget to install drain hose before operating your washer.

The packing box is opened, there are a drain hose, and a hose clamp in the washer.

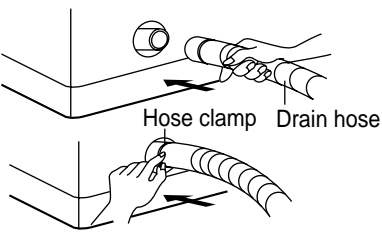
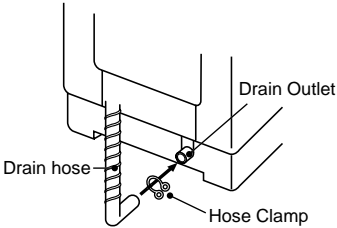
Non-Pump Model	Pump Model
<ul style="list-style-type: none"> • Connect the drain hose to the drain outlet at the back of the washer, and fasten it tightly with the clamp attached. 	<ul style="list-style-type: none"> • Connect the drain hose to the drain outlet at the back of the washing machine, and fasten it tightly with the clamp supplied. 

NOTES

- The opening must not be obstructed by carpeting when the washing machine is installed on a carpeted floor.

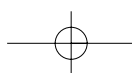

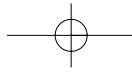

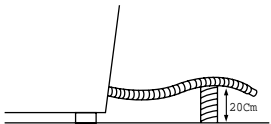
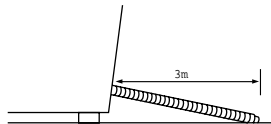
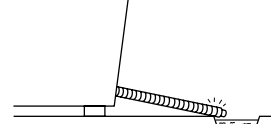
Non-Pump Model		
<p>① In case that it goes over a door sill. Don't let the height of the drain hose exceed 20cm from the bottom of washer.</p> 	<p>② In case of extending the drain hose. Don't let the total length exceed 3m.</p> 	<p>③ Be careful that the end of the drain hose is not immersed in water.</p> 

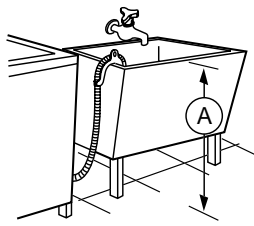
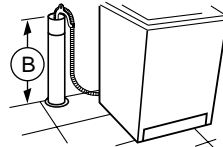
Pump Model	
Laundry tub drain system	Standpipe drain system
<ul style="list-style-type: none"> • Top of tub must be at least 86cm (34inches) high and no higher than 130cm from bottom of washer (A) 	<ul style="list-style-type: none"> • Needs a 3cm minimum diameter standpipe with minimum carry away capacity of 30liters per minute. • Top of tub must be at least 86cm (34inches) high and no higher than 130cm from bottom of washer (B) 

ELECTRICAL REQUIREMENTS

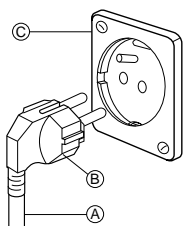
WARNING	electrical shock hazard:failure to follow these instructions could result in death or serious injury.	
<ul style="list-style-type: none"> • Electrical earth is required on this washer • If it does not fit the outlet, have a proper outlet installed by a qualified electrician. 	<ul style="list-style-type: none"> • Don't earth to a gas pipe • Don't change the power supply cord plug. • Check with a qualified electrician if you are not sure the washer is properly earthed. 	
Recommended earthing method		
	<p>For your personal safety, this washer must be earthed. This washer is equipped with a power supply cord (A) having a earthing plug (B). To minimize possible shock hazard, the cord must be plugged into a mating earthing-type wall receptacle (C). If a mating wall receptacle is not available, it is the personal responsibility and obligation of the customer to have the proper earthed wall receptacle installed by a qualified electrician.</p>	

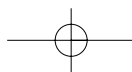

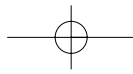



INLET HOSE CONNECTION

*Be careful not to confuse hot water inlet and cold water inlet.
In using only one water tap or in case of attached one water inlet valve, connect the inlet hose to the cold water inlet valve.*

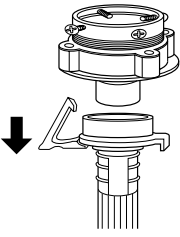
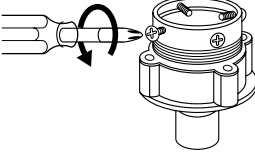
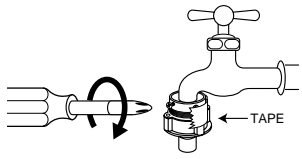
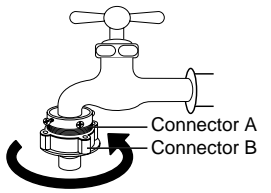
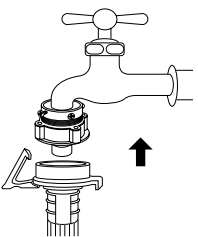
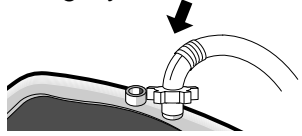
For Ordinary Tap

<p>① Pull down the collar of the inlet hose to separate it from the water tap adapter.</p> 	<p>② Loosen the four screws properly in fitting into water tap.</p> 	<p>③ Fit the water tap adapter into the water tap and tighten the four screws evenly while pushing up the adapter so that the rubber packing can attach to the water tap tightly.</p> 
<p>④ Remove the tape, and screw connector B into connector A tightly.</p> 	<p>⑤ Connect the inlet hose to the water tap adapter by pulling down the collar of the hose end.</p> 	<p>⑥ Connect the inlet hose adapter of the hose to the water inlet of the washer by turning it clockwise to be fixed tightly.</p>  <ul style="list-style-type: none"> • Please check the rubber packing inside the inlet hose adapter of the hose.

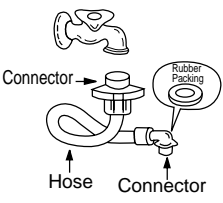
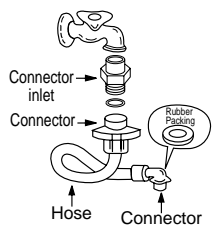
For Screw-Shaped Tap

<p>① Connect the inlet hose to the water tap by screwing the connector tightly.</p> 	<p>② Connect the connector-inlet supplied if necessary.</p> 	<p>③ Insert the inlet hose adapter into the water inlet of a washer and turn it to be fixed.</p>  <p>*Check the packing in the inlet</p>
---	---	---

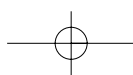

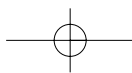

OPERATING YOUR WASHER

To obtain the best washing results, you must operate your washer properly. This section gives you this important information.

Preparing clothes for washing

- | | |
|---|--|
| <ul style="list-style-type: none"> • Close zippers, snaps, and hooks to avoid snagging other items.
Remove pins, buckles, and other hard objects to avoid scratching the washer interior. • Empty pockets and turn them inside out. | <ul style="list-style-type: none"> • Turn down cuffs and turn synthetic knits out to avoid pilling. • Tie strings and sashes so they will not tangle. • Treat spots and stains.
(see "Removing stains" on page14) |
|---|--|

Sorting

- | |
|---|
| <ul style="list-style-type: none"> • Separate heavily soiled items from, lightly soiled ones, even if they would normally be washed together. • Separate dark colors from light colors, color |
|---|

Loading



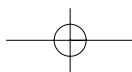

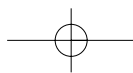





- | | |
|--|---|
| <ul style="list-style-type: none"> • Drop items into washer loosely. Items should move easily through wash water for best cleaning and wrinkle-free results. • Load washer properly and select correct load size setting.
Overloading and selecting a setting too small for the wash load can: <ul style="list-style-type: none"> - cause poor cleaning - increase wrinkling - create excessive lint - wear out items faster (because of pilling) | <ul style="list-style-type: none"> • Mix large and small items in each load. Load evenly to maintain washer balance. An off balance load can make the washer vibrate during spin. • Reduce wash time when using a small load size setting. Loads with only a few small items need less wash time. • Use a large load size setting to reduce wrinkling with permanent press clothes and some synthetic knits. These items should have more room to move in the water than heavy items (towels, jeans) |
|--|---|





THE FUNCTIONS OF THE CONTROL PANEL



	<ul style="list-style-type: none"> Press this button to turn the power "ON" or "OFF".
	<ul style="list-style-type: none"> It can be used to choose water temperature to be supplied. As the button is pressed, water temperature will be repeated. COLD → COLD + HOT → HOT In case of the single valve model, there is no washing temperature selector function.
	<ul style="list-style-type: none"> It can be used to adjust amount of water according to the size of the load to be washed. As the button is pressed, water level is selected by MEDIUM → • → HIGH → E.LOW → • → LOW → •
	<ul style="list-style-type: none"> It can be used to adjust washing time. As the button is pressed, you will see the repeated. 6 → 10 → 14 → 18 → SOAK(WASH 18 MIN. + SOAK 60 MIN.) → OFF
	<ul style="list-style-type: none"> This button selects the number of times you want to rinse. As the button is pressed, It will repeat. 1 time rinse → 1 time shower feed → 2 times rinse → 2 times shower feed → 3 times rinse → 3 times shower feed → 4 times rinse → 4 times shower feed → OFF In case of the pump model, there is no shower rinse or spray rinse selector function.
	<ul style="list-style-type: none"> It can be used to change spin time. As the button is pressed, it will repeat. 5 → 7 → 9 → OFF → 1 → 3
	<ul style="list-style-type: none"> It can be used to pre-engage time for wash.
	<ul style="list-style-type: none"> It can be used to select the full-automatic course. As the button is pressed, course will be selected by following order: FUZZY → BLANKET → WOOL → LIGHT → HEAVY → ECONOMY.
	<ul style="list-style-type: none"> It can be used to select the economic course.
	<ul style="list-style-type: none"> Operation and temporary stop is repeated as it is pressed. When you want to change course in operating; press the "START/HOLD" button → Select the course that you want to change → press the "START/HOLD" button again.

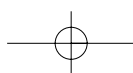

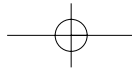

WASHING PROCEDURE AND COURSE SELECTION

FULL AUTOMATIC COURSE

1. FUZZY COURSE (SENSOR);

- This selection is for general washing except extraordinary clothes.
- Artificial brain sensor selects properly the various kind of washing condition such as washing time, rinse times, spin time and water level.
- It is possible for changing water temperature what you want.

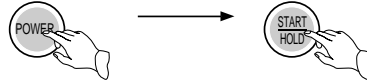

2. BLANKET COURSE;

- This selection is effective for blanket, curtain, carpet, etc ...
 - Do not wash general-electric blanket absolutely. (4kg's limitation for one-time-wash)
- Procedure to press the button;

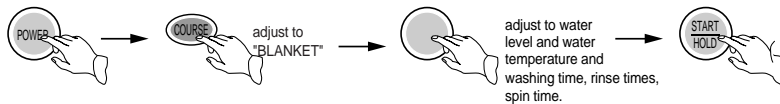

3. WOOL COURSE

- This selection is effective for wool clothes.
- Do not put leather clothes, or chamois clothes into the washing tub for washing. It may cause shrinkage or deformation to the clothes.
- Please use the neutral deter gents only
- The water temperature is fixed to "COLD"
- The water level is fixed to "MEDIUM".
- 1.5kg's limitation for one-time-wash.



4. LIGHT COURSE

- This selection is effective for washing light or less dirty wash. Procedure to press the button;
- Washing time, Rinse times and spin time are selected by artificial brain sensor automatically depend on amount of Laundry.
- Also, it is possible for changing water temperature what you want.



5. HEAVY COURSE

- This selection is effective for blue-jean, climbing clothes, ruck sack, sports wear, etc ...
- Washing time, Rinse times and spin time are selected by artificial brain sensor automatically depend on a mount of Laundry.
- Also, it is possible for changing water temperature what you want.



6. ECONOMY COURSE;

- This selection is useful to reduce water consumption and washing time for less dirty clothes.
- It is possible to use exclusive button.

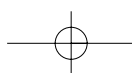
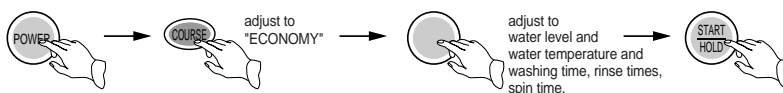

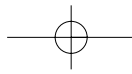

GUIDES FOR OTHER USEFUL PROGRAMS

Reserved Washing

- Reservation can be made from 2 hours to 48hours.
example) To make reservation to complete washing in 8hours.

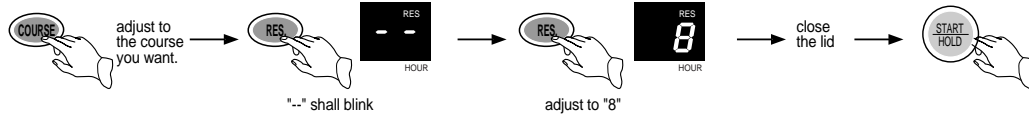

- Now the reservation is mode.
- WOOL course is not selected.
- The displaying time shows the finishing time you want.

Partial Selection Among Wash, Rinse or Spin

Partial process	Procedure of processing				
Only Wash	① Press the Power button 	② Select the washing time what you want. 	③ Select the water level and water temperature what you want.	④ Press the Start/Hold button with closing Lid(Door) 	After process, the buzzer give the information. And then, The Power switch will be soon turned off automatically.
Only Rinse		② Select the rinsing times what you want. 		 After this process, the Drain Process is not happen. If want, use the Spin button. (Refer to below)	
Wash & Rinse		② Select the washing time & rinsing times what you want. 			
Wash & Spin		② Select the washing time & spinning time what you want. 			
Only Spin		② Select the spinning time what you want. 	③ Press the Start/Hold button with closing Lid(Door) 		
Again the Rinse & Spin, after washing		② Select the rinsing times & spinning time what you want. 			
Only Drain		② Press the Spin button. 	③ Press the Start/Hold button with opening Lid(Door) 	After process, the buzzer give the information and PCB display the "LE" signal. But, The Power switch is not turned off automatically.	

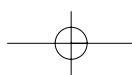

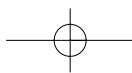

GENERAL PROCEDURE FOR OPERATION

1. Add measured detergent to the washer, (Follow manufacturer's directions for safe use)
2. OPTIONAL STEP
If desired, add measured liquid chlorine bleach to the bleach inlet, use only liquid chlorine in the bleach inlet
* Follow manufacturer's direction for safe use.

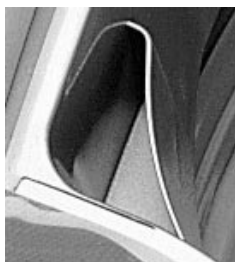

NOTE

- Do not let bleach splash, drip, or run down into washer basket.
Undiluted bleach will damage any fabric it touches.
- Do not use this dispenser to add powdered chlorine or color safe bleach to your wash load. The dispenser is for liquid chlorine bleach use only.

3. OPTIONAL STEP
 - Pour liquid fabric softener into the dispenser using the amount recommended on the package. Avoid dripping or spilling any fabric softener on the load.
 - Dilute fabric softener with warm water.
Fill dispenser with warm water until liquid reaches the base line in the case.
The dispenser is for liquid fabric softener use only. (See page 2)
 - The liquid fabric softener will be put into the TUB automatically when final Rinse process.

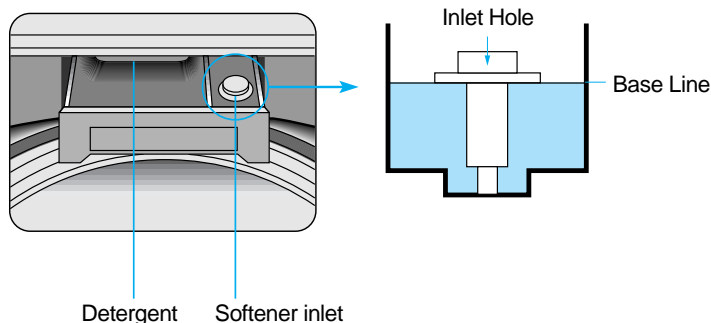

4. Close the washer lid (door)
5. Press the power button.
6. Select the cycle. The full automatic cycle has four settings; FUZZY, BLANKET, WOOL, LIGHT HEAVY, ECONOMY.(See page 9)
7. Press the START/HOLD button.

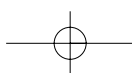

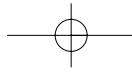

CARING FOR YOUR WASHER

Proper care of your washer can extend its life. This section explains how to care for your washer properly and safely.

Cleaning your washer

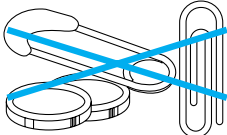
Exterior	Interior
<p>Wipe up detergent, bleach, and other spills with a soft, damp cloth or sponge as they occur. Occasionally wipe the outside of the washer to keep it looking like new one.</p> 	<p>Clean interior with 250ml of chlorine bleach mixed with 500ml of detergent. Run washer through a complete cycle. Repeat process if necessary.</p>
<p>Do not put sharp or metal object in your washer, they can damage the finish. Check all pockets for pins, clips, money, bolts, nuts, etc. Do not lay these objects on your washer after emptying pockets.</p> 	

Winter storage or moving care

Install and store your washer where it will not freeze. Because some water may stay in the hoses, freezing can damage your washer.

If storing or moving your washer during freezing weather, winterize it.

To winterize washer	To use washer again
<ul style="list-style-type: none"> • Turn off water faucet. • Disconnect and drain water inlet hoses • Run washer on a drain and spin setting (see page 10) for 1 minute. • Unplug the power supply cord. 	<ul style="list-style-type: none"> • Flush water pipes and hoses. • Reconnect water inlet hoses. • Turn on water faucet. • Reconnect power supply cord.

Non-use or vacation care

Operate your washer only when you are at home.

If will be on vacation or not using your washer for an extended period of time, you should:

- Unplug the power supply cord or turn off electrical power to the washer.
- Turn off the water supply to the washer .

This helps avoid accidental flooding (due to a water pressure surge) while you are away.

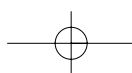

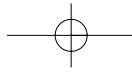

HOW TO CLEAN THE FILTER

Cleaning the Lint Filter

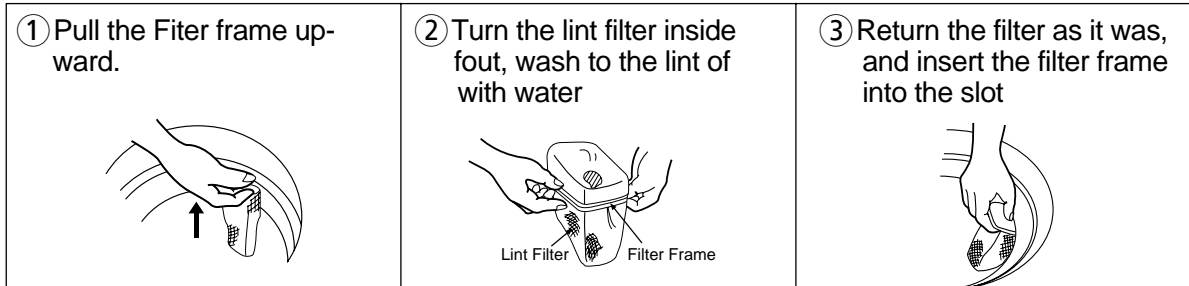

Cleaning the water inlet filter

- Clean the filter when water leaks from, the water inlet.

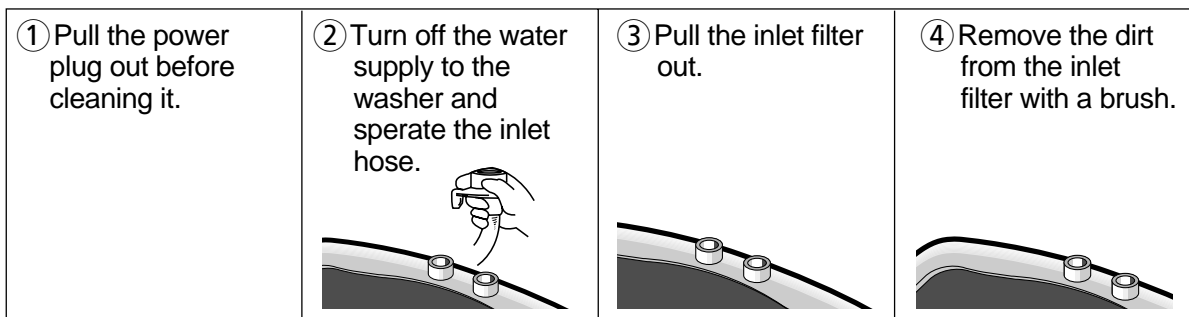

Cleaning the drain filter

- In case "Pump-Model" drain hose, this filter's equipped at the back side of washer.
- This drain filter is to screen the foreign stuffs such as threads, coins, pins, buttons etc ...
- If the drain filter is not cleaned at proper time (every 10 times of use), Drain problem could be caused.

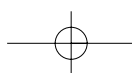
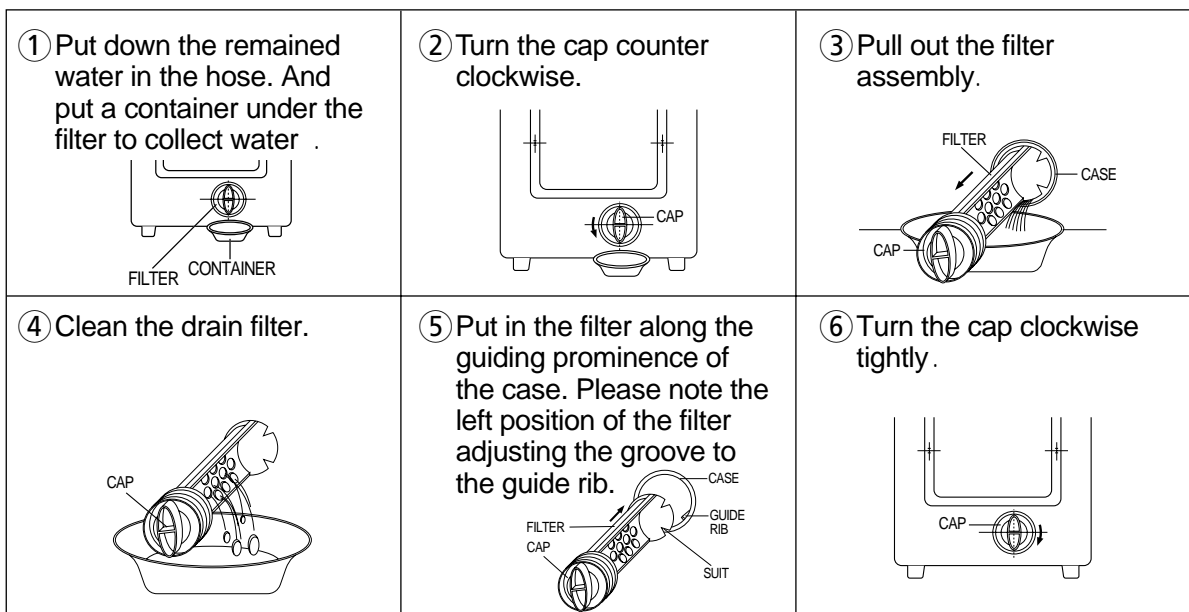

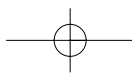

REMOVING STAINS

Stained, heavily-soiled, or greasy items may need to be prewashed or soaked for best results. Soaking helps remove protein-type stains like blood, milk, or grass. Prewashing helps loosen soil before washing.

Stain removal rules

- Use warm water for soaking or prewashing stained laundry. Hot water can set stains.
- Most stains are easier to remove when they are fresh. Old or set stains may not come out.
- Before treating any stain, find out what kind of stain it is, how old the stain is, what kind of fabric it is, and if the fabric is color fast. (Check the care label)
- Washing and drying can set some stains.
- Start with cold or warm water, hot water can set some stain.
- When bleach is recommended, use a bleach that is safe for the fabric.
- Put the stained area face down on a paper towel or white cloth. Apply the stain remover to the back of the stain. This forces the stain off fabric instead of through it.

Stain removal guide

STAIN	TO REMOVE
Blood	Rinse immediately in COLD water. If stain remains, soak in cold water with an enzyme prewash.
Chewing gum	Use ice in plastic bag to harden the gum. Scrape off what you can and then sponge with white spirits.
Cocoa, Chocolate	Sponge with COLD water and soak in an enzyme prewash. If stains persist, rub in a little detergent and rinse in cold water.
Coffee	Blot up quickly and rinse out in COLD water. Rub in a little detergent and wash in the maximum temperature allowed for the fabric type.
Cream/Milk Ice cream	Rinse in COLD water and wash normally. If stain is still apparent, sponge with white spirits.
Deodorant	Rub affected area with white vinegar and then rinse under running COLD water. Sponge with white spirits. Treat stiffened areas with enzyme prewash
Egg	Soak in a COLD enzyme prewash, rinse and wash normal.
Fabric/Softener	Rub affected area with bar soap and wash normally.
Fruit stains	Treat as soon as possible by sponging with COLD water. Rub a little detergent on the stain and wash normally
Grass	Sponge with white spirits. Rub in an enzyme prewash and wash as normal
Grease and oil	Lay the affected area face down on an absorbent cloth and work from the back. Sponge with white spirits or dry cleaning fluid. Wash normally.
Iron or rust	Apply lemon juice and salt and place in the sun. Wash normally.
Lipstick	Sponge with white methylated spirits and wash normally.
Mildew	Wash in WARM water and detergent. Moisten area with lemon juice, dry in the sun and wash normally. If stain persists and the fabric allows, use a bleach.
Mud	Brush off any dry mud. Rinse in cold water. If stain persists rub in a little detergent and wash normally.
Paint-oil based	Scrape off any fresh paint and sponge with a non flammable dry cleaning fluid and wash normally.
Paint-water based	Treat while still wet, rinse in WARM water and wash normally.
Scorch marks	Dampen a cloth with hydrogen peroxide, lay it over the affected area and press with a fairly hot iron.

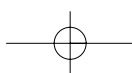

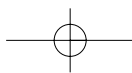

TROUBLE SHOOTING

*Most problems are easily solved if you understand the cause.
Check the following list for problem before calling for service.*

Before calling for service, check these

PROBLEM	CHECK POINT
<ul style="list-style-type: none"> The washer will not operate at all. 	<ul style="list-style-type: none"> Is there a power failure? Is the power cord correctly connected to an electric outlet? Is the electric fuse broken? Did you turn on the power? Did you press Start/Hold button? Is there correct amount of water in the tub?
<ul style="list-style-type: none"> Water is not supplied; If water supply is not finished within 20 minutes, the lamp LE will light up, and the buzzer will sound to indicate a problem. 	<ul style="list-style-type: none"> Did you connect the inlet hose and open the water tap? Is the inlet hose or the water tap frozen? Is the water supply shut off? Does foreign matter block up the inlet hose filter?
<ul style="list-style-type: none"> The washer will not drain; If the drain is not finished within selected time, lamp LE will light up, and the buzzer will sound to indicate a problem. 	<ul style="list-style-type: none"> Is the drain hose frozen or blocked up by dirt? Is the drain hose kinked or deformed? Is the end of the drain hose immersed in water? Is there excessive dirt inside the pump housing?
<ul style="list-style-type: none"> The washer will not spin; If the clothes is collected on one side during spin and the tub becomes unbalanced, the spin operation will be interrupted, and then this unbalanced condition will be corrected by following operation: WATER SUPPLY → RINSE → DRAIN However if the unbalanced condition is unchanged despite repeating the above operation, the lamp LE will light up, and the buzzer will sound to indicate a problem. 	<ul style="list-style-type: none"> Is the clothe in the tub collected on one side? Is the washing machine installed on an uneven floor or is the vibration serious? Is the lid open? (The lamp LE will light up in this case.)
<ul style="list-style-type: none"> <i>These cases are not malfunctions</i> <i>The sound "wing" heard during water supply is the operating sound made by the water inlet valve.</i> <i>The sound "sha" heard in stopping the tub is the sound that comes from the autobalancer of the tub.</i> <i>The sound "wung" heard during wash or spin is the operating sound made by the air bubble generator.</i> 	

NOTE

*Please check the point before calling for a service.
If the supply cord is damaged, it must only be replaced by a repair shop appointed by manufacturer, because special purpose tools are required.*

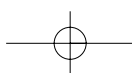

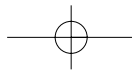

SPECIFICATION

MODEL NO.	DWF-200M		DWF-240M	
Power Source	AC110~127V, 220V/60Hz	AC220~240V/50Hz	AC100~127V, 220V/60Hz	AC220~240V/50Hz
Power Consumption	550W	480W	600W	550W
Dimension (W×H×D, mm)	630 × 1040 × 670		630 × 1060 × 670	
Unit Weight	47kg / 48kg (Pump)		49kg / 50kg (Pump)	
Standard Water Consumption	250 ℓ		270 ℓ	
Standard Water Level	•HIGH (97 ℓ) •LOW (66 ℓ)	•MEDIUM (77 ℓ) •E.LOW (42 ℓ)	•HIGH (103 ℓ) •LOW (70 ℓ)	•MEDIUM (87 ℓ) •E.LOW (43 ℓ)
Operating Water Pressure	0.3kgf/cm ² ~8kgf/cm ² (29.4kPa~784.5kPa)			
Wash Mode	Multi — Washing Type (Radical + Air-Bubble + Pulsator)			

NOTE

- In case of moving Washing Machine, please follow the following picture.

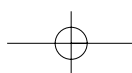

Free Manuals Download Website

<http://myh66.com>

<http://usermanuals.us>

<http://www.somanuals.com>

<http://www.4manuals.cc>

<http://www.manual-lib.com>

<http://www.404manual.com>

<http://www.luxmanual.com>

<http://aubethermostatmanual.com>

Golf course search by state

<http://golfingnear.com>

Email search by domain

<http://emailbydomain.com>

Auto manuals search

<http://auto.somanuals.com>

TV manuals search

<http://tv.somanuals.com>