

INSTALLATION MANUAL
VEHICLE SECURITY SYSTEM
CE-SS200

FUSION®

FUSION CULTURE

There's no point doing something if no one notices. We've always believed the way to make things happen is by getting noticed. From our product, to our demo cars, to our events, FUSION is about making some noise.

Now you are ready. Step out of the shadows and announce you've arrived in a world where the old limits are left behind. Where technology is creatively combined with the latest in product innovation. Where new levels of entertainment are delivered with outstanding performance and quality. Our development team create distinctively different products; subwoofers, amplifiers, speakers and peripherals that redefine what can be done in car audio.

Leave the old behind and push the limits of what can be achieved in car audio. Make some noise.

For more information about FUSION Electronics visit our website at www.fusionelectronics.com or email technical@fusionelectronics.co.nz

PROFESSIONAL INSTALLATION STONGLY RECOMMENDED

Installation Precautions:

1. Roll down window to avoid locking keys in vehicle during installation
2. Avoid mounting components or routing wires near hot surfaces
3. Avoid mounting components or routing wires near moving parts
4. Tape or loom wires under hood for protection and appearance
5. Use grommets when routing wires through metal surfaces
6. Use a voltmeter for testing and verifying circuits

V 2.0

TABLE OF CONTENTS

- PROGRAMMING REMOTES pg 4
- ALARM FEATURES PROGRAMMING pg 5
- ADJUSTING THE SENSITIVITY LEVEL pg 8
- WIRING DIAGRAMS..... pg 9
- CENTRAL LOCKING DIAGRAMS pg 11
- SPECIFICATIONS pg 15

RECORD YOUR PRODUCT DETAILS HERE:

MODEL NUMBER _____ DATE OF PURCHASE _____

AFFIX RECEIPT HERE

PROGRAMMING REMOTES

1. Turn the ignition switch 'OFF/ON' 3 times (within 15 seconds) and leave in the ON position.
2. Push the valet switch 3 times, and hold on the 3rd push until a long chirp is heard from the siren, and then release the valet switch. You are now in the remote programming mode.
3. Press and hold any button of the remote until the siren responds with a confirming chirp, this indicates the remote has been stored into memory.
4. If you have additional remotes (up to 4 in total) that need to be programmed, repeat step 3 for each remote.

Exit Programming: Turn ignition to 'OFF' position, or wait for 15 seconds. Three long chirps and three indicator light flashes will confirm exit.



Note: This mode will only retain the last 4 remote transmitters programmed. If the remote memory is exceeded, the security system will start deleting remotes from memory in chronological order.

ALARM FEATURES PROGRAMMING:





ALARM FEATURE "I" PROGRAMMING:

1. Turn the ignition 'switch 'ON/OFF' 3 times (within 15 seconds) and leave in the OFF position on the 3rd time.
2. Push the valet switch twice, and hold on the 2nd push until one short chirp, followed by one long chirp is heard then release the valet switch. You are now in the alarm feature 'I' programming mode.
3. **A;** Press and release the remote button  corresponding to the feature '1' to be changed.
The siren will chirp and the LED will indicate the new setting

B; Press and release the remote button  corresponding to the feature '2' to be changed.
The siren will chirp and the LED will indicate the new setting

C; Press and release the remote buttons  +  corresponding to the feature '3' to be changed.
The siren will chirp and the LED will indicate the new setting

Note: The factory default setting is always [1] LED flash, [1] chirp.



Press remote button	One Chirp / LED one flash Factory Default Setting	Two Chirps / LED two flashes
1 	Chirps on	Chirps off
2 	Automatic Rearm On	Automatic Rearm Off
3  + 	Instant Door Ajar Warning	45 second Delay Door Ajar warning

Exit Programming: Turn ignition to 'ON' position, or wait 15 seconds. Three long chirps will confirm exit.





ALARM FEATURE "II" PROGRAMMING:

1. Turn the Ignition 'switch 'ON/OFF' 3 times (within 15 seconds), and leave in the OFF position.
2. Push the valet switch 4 times and hold on the 4th push until two short chirps and one long chirp is heard, and then release the valet switch. You are now in the alarm feature 'II' programming mode.
3. **A;** Press and release the remote button  corresponding to the feature '1' to be changed.
The siren will chirp and the LED will indicate the new setting.

B; Press and release the remote button  corresponding to the feature '2' to be changed.
The siren will chirp and the LED will indicate the new setting.

C; Press and release the remote buttons  +  corresponding to the feature '3' to be changed.
The siren will chirp and the LED will indicate the new setting.

Note: The factory default setting is always [1] LED flash, [1] chirp.



Press remote button	One Chirp / LED one flash Factory Default Setting	Two Chirps / LED two flashes	Three Chirps / LED three flashes
1 	0.9 - second door lock pulses	3.0 - second door lock pulse	double pulse unlock
2 	Active arming	Passive arming without passive door locking	Passive arming with passive door locking
3  + 	Ignition controlled door locks & unlocks	Without ignition controlled door locks & unlocks	

Exit Programming: Turn ignition to 'ON' position, or wait for 15 seconds. Three long chirps will confirm exit.





ALARM FEATURE "III" PROGRAMMING:

1. Turn the ignition 'switch 'ON/OFF' 3 times (within 15 seconds), and leave in the OFF position.
2. Push the valet switch 6 times and hold on the 6th push until three short chirps and one long chirp is heard, and then release the valet switch. You are now in the Alarm feature 'III' programming mode.
3. **A;** Press and release the remote button  corresponding to the feature '1' to be changed.
The siren will chirp and the LED will indicate the new setting.

B; Press and release the remote button  corresponding to the feature '2' to be changed.
The siren will chirp and the LED will indicate the new setting.







C; Press and release the remote buttons  +  corresponding to the feature '3' to be changed.
The siren will chirp and the LED will indicate the new setting.

Note: The factory default setting is always [1] LED flash, [1] chirp.

Press remote button	One Chirp / LED one flash Factory Default Setting	Two Chirps / LED two flashes
1 		Shock sensor program mode
2 	Red/white wire = trunk/boot (Channel 3) output	Red/white wire = two step door unlock output
3  + 	Anti car jacking off	Anti car jacking on

Exit Programming: Turn Ignition to 'ON' position, or wait for 15 seconds. Three long chirps will confirm exit.

ADJUSTING THE SENSITIVITY LEVEL OF THE SHOCK SENSOR

1. Turn the ignition 'switch 'ON/OFF' 3 times (within 15 seconds) and leave in the OFF position.
2. Push the valet switch 6 times and hold on the 6th push until three short chirps and one long chirp is heard, and then release the valet switch. You are now in the alarm feature 'Shock Sensor' programming mode.
3. Press and hold  button for 2 seconds. One long siren chirp will indicate the unit is ready to accept adjustments of the second stage of the shock sensor (full alarm).
4. Pressing the  button on the remote once will decrease the sensitivity level by one, each time a decrease is made the siren will respond with one chirp, while 2 chirp's indicates the minimum sensitivity setting.
5. Pressing  button on the remote once will increase sensitivity level by one, each time an increase is made the siren will respond with one chirp, while 2 chirp's indicates the maximum sensitivity setting.
6. Hit the bumper or strong metal part of the vehicle to test the threshold level of the sensor.
 - a). Activate the warn-away (first stage of the shock sensor), the siren will emit a short chirp.
 - b). Activate the full alarm (second stage of the shock sensor), the siren will emit a long chirp.
7. When you are satisfied with the second stage of the shock sensor settings, press and hold  and  buttons simultaneously for 2 seconds. Two long siren chirps will indicate the unit is ready to accept adjustments of the first stage of the shock sensor (warn-away).
8. Follow the steps 4, 5 and 6 to adjust the warn-away sensitivity.
9. When you are satisfied with the setting, press  and  buttons simultaneously. One long siren chirp indicates the unit has confirmed the setting.

Note: If 20 seconds of inactivity expire, or the ignition is turned on during the above steps, the unit will exit the programming mode and return to the disarmed mode. Three long chirps will confirm exit.

WIRING DIAGRAM

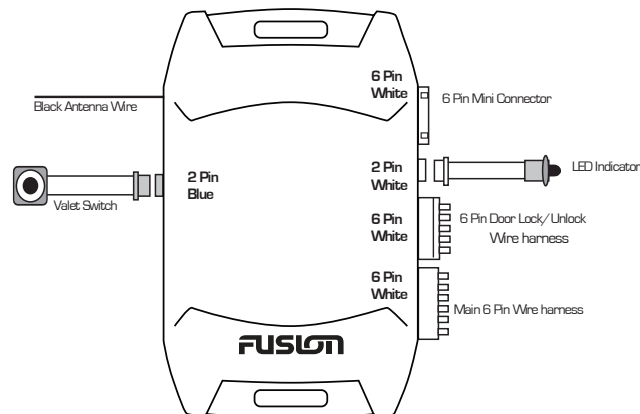

A: MAIN 6 PIN WIRE HARNESS:

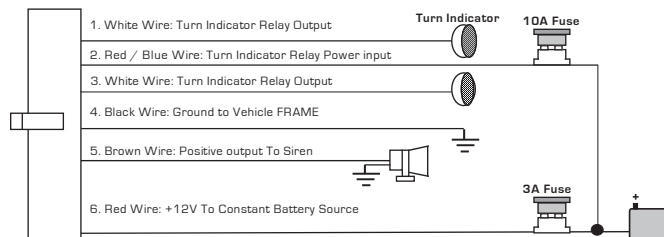

POSITIVE TRIGGER DOOR LOCK SYSTEM

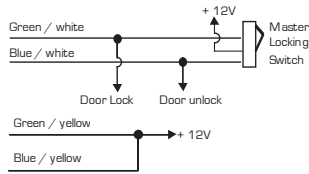

ALTERNATING DOOR LOCKS

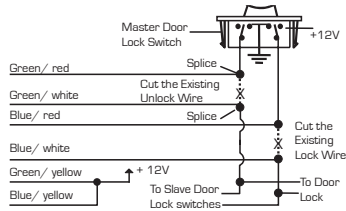

VACUUM OPERATED DOOR LOCKING SYSTEM

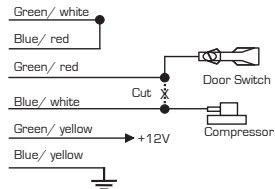

2 STEP DOOR UNLOCK WIRE CONNECTIONS FOR 5 WIRE ALTERNATING DOOR LOCKS

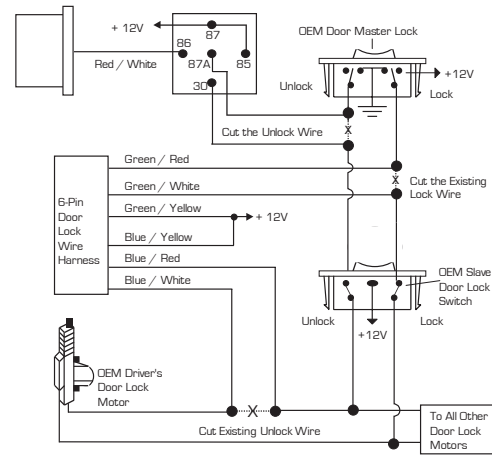

2 STEP DOOR UNLOCK WIRE CONNECTIONS FOR GROUND SWITCHED DOOR LOCKS

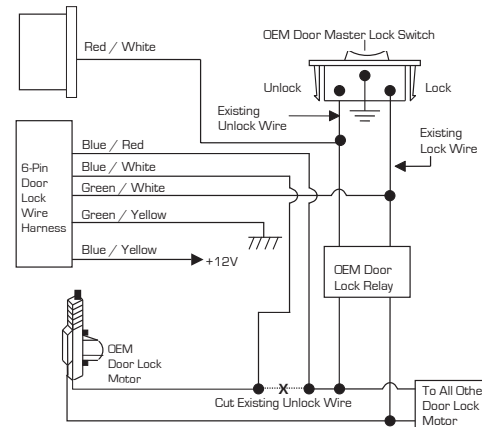

2 STEP DOOR UNLOCK WIRE CONNECTIONS FOR POSITIVE SWITCHED DOOR LOCKS

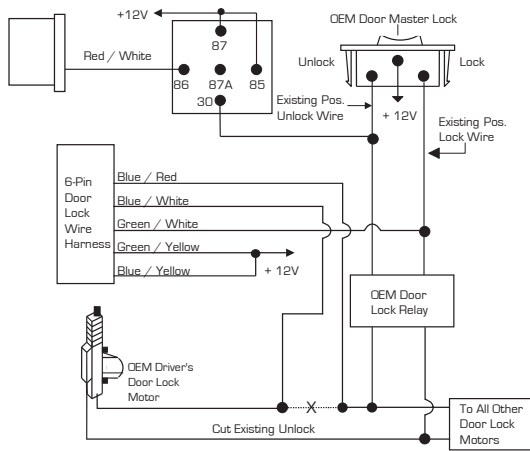

SPECIFICATIONS:

Power supply:	10 VDC - 16 VDC
Operating temperature:	-40 °C - +80 °C (-40 °F - +176 °F)
TX Frequency:	433.92 M Hz

POWER CONSUMPTION:

Indicator light flash output:	15 Amp
Door Lock:	10 Amp
Door Unlock:	10 Amp
Security system (disarmed):	15 mA

Note: Remote control range is dependant on weather conditions and alarm installation.

THE FUSION CE-SS200 SECURITY SYSTEM COMPLIES WITH:

FCC:

This device complies with part 15 of the FCC rules. Operation is subject to the following two conditions.

- (1) This device may not cause harmful interference, and
- (2) This device must accept any interference received, including interference that may cause undesired operation.



YOU CAN HELP PROTECT THE ENVIRONMENT!

Please remember to respect the local regulations:
Hand in the non-working electrical equipment
to an appropriate waste disposal center.



PUBLISHED BY FUSION ELECTRONICS LIMITED:

© Copyright 2007 by FUSION Electronics Limited.
All rights reserved. Specifications and design are
subject to change without notice.

•• Specifications and design are subject to change without notice ••

Free Manuals Download Website

<http://myh66.com>

<http://usermanuals.us>

<http://www.somanuals.com>

<http://www.4manuals.cc>

<http://www.manual-lib.com>

<http://www.404manual.com>

<http://www.luxmanual.com>

<http://aubethermostatmanual.com>

Golf course search by state

<http://golfingnear.com>

Email search by domain

<http://emailbydomain.com>

Auto manuals search

<http://auto.somanuals.com>

TV manuals search

<http://tv.somanuals.com>