

Operating and assembly instructions

# ED 220/221-6..

Built-in steam oven



**GAGGENAU**

**Preface**

<b>Important safeguards</b>	Page 3
<b>Important instructions</b>	Page 4
<b>1. Important notes</b>	Page 5-6
1.1 For your safety	Page 5
1.2 About use	Page 6
<b>2. Appliance and accessories</b>	Page 7-8
2.1 Appliance description	Page 7
2.2 Display	Page 7
2.3 Accessories / special accessories	Page 8
<b>3. Operating for the first time</b>	Page 9-12
3.1 Important notes	Page 9
3.2 Calibration	Page 9-10
3.3 What to do, when ...	Page 10
3.4 Determining water hardness	Page 11
3.5 Entering the water hardness	Page 12
<b>4. Operation</b>	Page 13-19
4.1 Switching on and off	Page 13
4.2 Control knobs	Page 13
4.3 Operating modes	Page 14
4.4 Operating the timer	Page 15-19
<b>5. Special functions</b>	Page 20-25
5.1 Child lock	Page 20
5.2 Options menu	Page 21
5.3 Core temperature sensor	Page 22-23
5.4 Steaming	Page 24
5.5 Condensing	Page 24
5.6 Display of the current cooking compartment temperature	Page 25
5.7 Power failure protection	Page 25
5.8 Holiday protection	Page 25
5.9 Cleaning aid	Page 25
<b>6. Further uses</b>	Page 26-27
<b>7. Cooking table, Baking table</b>	Page 28-32
<b>8. Tips and tricks</b>	Page 33
<b>9. Cleaning and care</b>	Page 34-37
9.1 Manual cleaning	Page 34
9.2 Cleaning the side plate	Page 35
9.3 Cleaning aid	Page 36-37
<b>10. Maintenance</b>	Page 38-41
10.1 General	Page 38
10.2 Lamp replacement	Page 38
10.3 Descaling	Page 39
10.4 Disassembly of the front window	Page 40
10.5 Remedy small malfunctions yourself	Page 41

# Preface

**With your steam oven you can experience modern professional cooking technology in your own household.**

The steam oven offers the following advantages:

- Cooking with steam allows gentle preparation. The valuable substances contained in the foodstuffs you prepare are retained almost completely.
- Diverse meals can be prepared without any transfer of taste.
- Thanks to a special combined steaming method, foodstuffs are neither dried out nor drained of their goodness.
- Gently re-heating up food is possible, and prepared meals retain their natural appearance.

To ensure that you will be able to use this appliance in all its diversity, read through the operating and assembly instructions conscientiously before operating it for the first time. The instructions contain important notes on use, installation and maintenance of the appliance.

On the following pages you will find important notes on safety and operation. These notes will serve to ensure your personal safety and the lasting value of your appliance.

The chapters entitled **“Structure and operating principle”** and **“Operation”** tell you all about what your appliance can do and how you operate it.

The chapter entitled **“Cleaning and care”** will make sure that your appliance will stay operable and beautiful for a long time.

We have also compiled some **“Tips and tricks”** for you.

**And now we wish you lots of fun with your steam oven.**



Fig. 1

# Important safeguards

---

1. **Read all instructions.**
2. Do not touch hot surfaces. Use handles or knobs.
3. To protect against electrical shock do not immerse cord or plug in water or liquid.
4. Close supervision is necessary when any appliance is used by or near children.
5. Unplug from outlet when not in use and before cleaning. Allow to cool before putting on or taking off parts.
6. Do not operate any appliance with a damaged cord or plug or after the appliance malfunctions or has been damaged in any manner. Return appliance to the nearest authorized service facility for examination, repair, or adjustment.
7. The use of accessory attachments not recommended by the appliance manufacturer may cause injuries.
8. Do not use outdoors.
9. Do not let cord hang over edge of table or counter, or touch hot surfaces.
10. Do not place on or near a hot gas or electric burner, or in a heated oven.
11. Extreme caution must be used when moving an appliance containing hot oil or other hot liquids.
12. Do not use appliance for other than intended use.
13. To reduce the risk of fire, do not place any heating or cooking appliance beneath the appliance.
14. To reduce the risk of fire, do not mount unit over or near any portion of a heating or cooking appliance.
15. **Save these instructions.**

# Important instructions

1. a) **Proper installation** - Be sure your appliance is properly installed and grounded by a qualified electrician.
- b) **Never use your appliance for warming or heating the room.**
- c) **Do not leave children alone** - Children should not be left alone or unattended in areas where the appliance is in use. They should never be allowed to sit or stand on any part of the appliance.
- d) **Wear proper apparel** - Loose-fitting or hanging garments should never be worn while using the appliance.
- e) **User servicing** - Do not repair or replace any part of the appliance unless specifically recommended in the manual. All other servicing should be referred to a qualified technician.
- f) **Storage in appliance** - Flammable materials should not be stored in an oven or near surface units.
- g) **Do not use water on grease fires** - Smother fire or flame or use dry chemical or foam type extinguisher.
- h) **Use only dry pot holders** - Moist or damp pot holders on hot surfaces may result in burns from steam. Do not let pot holders touch hot heating elements. Do not use a towel or other bulky cloth.
2. a) **Use care when opening door** - Let hot air or steam escape before removing or replacing food.
- b) **Do not heat unopened food containers** - Build-up of pressure may cause container to burst and result in injury.
- c) **Keep oven vent ducts unobstructed.**
- d) **Use care when using meat probe**, that it does not contact any heating elements.
- e) **Placement of oven racks** - Always place oven racks in desired location while oven is cool. If rack must be moved while oven is hot, do not let pot holder contact hot heating element in oven.
- f) **Accessories** supplied with this oven are intended only for use in this oven.
3. **DO NOT TOUCH HEATING ELEMENTS OR INTERIOR SURFACES OF OVEN** - Heating elements may be hot even though they are dark in color. Interior surfaces of an oven become hot enough to cause burns. During and after use, do not touch, or let clothing or other flammable materials contact heating elements or interior surfaces of oven until they have had sufficient time to cool. Other surfaces of the appliance may become hot enough to cause burns.
4. a) **Do not clean door gasket** - The door gasket is essential for a good seal. Care should be taken not to rub, damage, or move the gasket.
- b) **Do not use oven cleaners** - No commercial oven cleaner or oven liner protective coating of any kind should be used in or around any part of the oven.
- c) **Clean only parts listed in manual.**
- d) Oven must be in the **OFF** position before attempting to attach or install any accessory.

# 1. Important notes

---

## 1.1 For your safety

You must not operate the appliance if it is damaged.

The appliance must only be connected by an **authorised specialist**, paying attention to the relevant regulations of the power supply companies and the regional construction regulations.

**Observe the assembly instructions!**

**Caution: Fire risk!** Do not store any combustible objects in your appliance. When operating the appliance, only ever leave the inner parts inside the cooking compartment that you actually need.

As the user, you yourself are responsible for maintenance and proper use in the household.

Only ever operate the appliance under supervision. Disconnect the unit from the water mains when it is not in operation.

**Caution!** The appliance gets hot during operation. Keep children away!

**Caution!** There is a risk of injuries if the door is not closed properly. You could jam and crush your fingers and hands.

**Caution!** Steam may billow out when you open the door. If there is steam in the oven, do not reach in with your hands! **Risk of burns!**

**Caution!** When removing the cooking insert hot water may drip from the oven top. **Risk of scalding!** Be careful when removing the cooking insert as hot liquid might spill. Use heat resistant oven gloves.

Leads of other electrical appliances that are used in the proximity of the cooker must not be jammed in by the hot oven door.

Do not clean the appliance with a steam cleaning apparatus or with water pressure – risk of short-circuits!

Disconnect the appliance from the water and electricity mains. Switch off the corresponding fuse and turn off the tap.

**Caution!** For technical reasons the lamp cover cannot be removed. Lamp must only be replaced by Gaggenau after-sales service.

**Repairs** may only be carried out by authorised electricians.

**Note:** the appliance must not be connected to the hot water supply.

**No warranty claims** can be lodged for any damage resulting from failure to observe these instructions.

**Technical modifications reserved.**

---

## 1.2 About use

The appliance is intended solely for use in the household and must not be put to any other uses.

Use the appliance to prepare meals only. It must not be used to heat up the room in which it is installed.

**Only ever use the included cooking inserts** or order the special accessories.

Do not place any items in the oven compartment that might rust. Rusty accessories will lead to further rusting in the oven compartment!

**Do not use any silver tableware** in the cooking compartment.

The cooking compartment may become discoloured during prolonged operation. This does not have a detrimental influence on operability of the appliance.

Operation is only possible when the door is closed, otherwise there is a risk that water will spray out of the appliance or that hot steam will come out.

The steam oven uses unpressurized steam, therefore the door can be opened at any time during cooking. To prevent extreme steam from escaping when you open the door, you can condense beforehand. Water may drip when opening the door.

Steam may escape during operation and when opening the door.

The  (Heating) symbol in the control panel goes off as soon as the required temperature has been reached.

Turn the "Temperature" control knob (right control knob) to the 0 position after use.

**In the event of malfunctions**, first of all check the household fuses. If the problem has nothing to do with the power or water supply, please contact your specialist dealer or your local Gaggenau after-sales service.

The door window may fog up at all moisture levels (above all at the 100 % moisture level).

Operating noise may occur in all operating modes. Opening and closing of the air flap causes clicking noise.

The appliance rinses automatically when switched on if it has not been in operation **for a prolonged period of time** or after a prolonged power failure (several hours). This removes water that is left over in the pipes.

The food being cooked must not come into contact with the sides or the grease filter.

At set temperatures below 65°C / 150°F, the light is switched off after a few seconds to ensure that the halogen lamp will not additionally heat up the oven compartment. This ensures more precise temperature coordination. The light in the oven compartment is switched on again for a few seconds if you turn one of the two control knobs or if you press a key.

### **Calibration**

#### **(automatic boiling point-adjustment):**

the boiling point of water depends on the barometric pressure. The barometric pressure changes with the altitude of the place where the appliance is installed. During self-adjustment, the appliance adapts itself to the pressure conditions prevailing at the appliance's location.

**The appliance cannot be operated if it has not been calibrated!**

The appliance features a **descaling display**. When it flashes, this is an indication that the appliance must be descaled. Before commencing operation, you must enter the water hardness in your household on the appliance.

## 2. Appliance and accessories

### 2.1 Appliance description

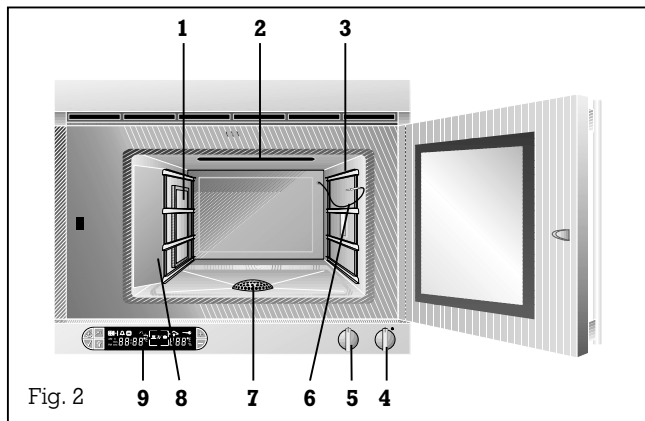

- 1 Grease filter
- 2 Air flap
- 3 Slide-in grills
- 4 "Temperature" control knob
- 5 "Moisture level" control knob
- 6 Core temperature sensor
- 7 Base strainer with siphon trap
- 8 Side plate
- 9 Display

### 2.2 Display

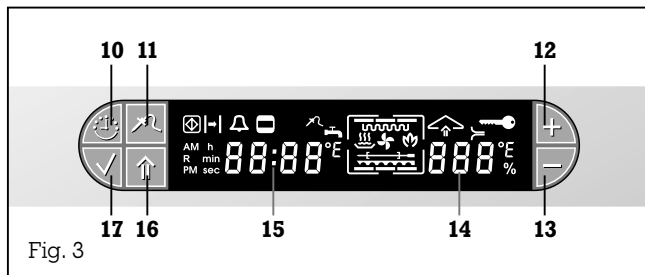

- 10 Timer key
- 11 Core temperature sensor key
- 12 Plus key
- 13 Minus key
- 14 Temperature / Moisture level display
- 15 Time display
- 16 Steaming / condensing key
- 17 Confirmation key

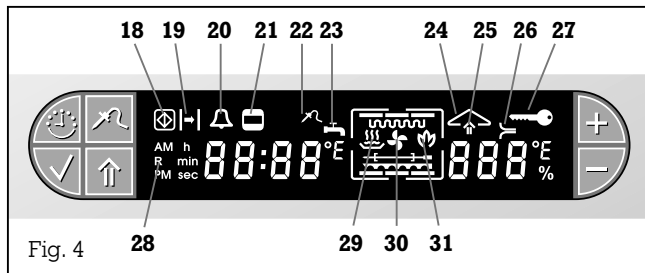

- 18 "Child lock" symbol (symbol flashes)
- 19 "Duration, end" symbol
- 20 "Short timer" symbol
- 21 "Cooking time" symbol
- 22 "Core temperature sensor" symbol
- 23 "Water connection" symbol
- 24 "Heating" symbol
- 25 "Steaming / condensing" symbol
- 26 "Descaling" symbol
- 27 "Door lock" symbol
- 28 "Start calibration" symbol
- 29 "Steaming" symbol
- 30 "Hot air" symbol
- 31 "Cleaning aid" symbol



## 2.3 Accessories / special accessories

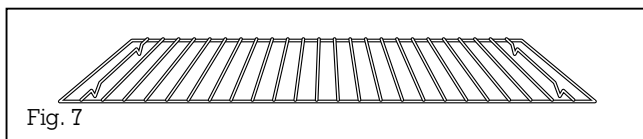
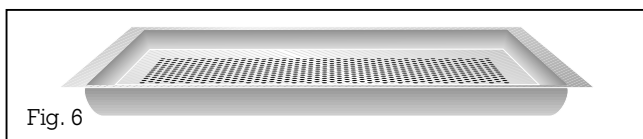
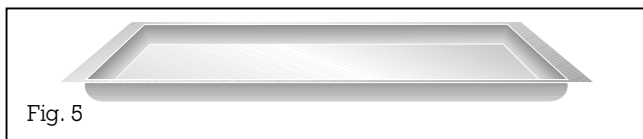

**As standard**, the appliance comes with the following accessories:

- Stainless steel cooking insert GN 2/3, unperforated, 40 mm / 1 1/2" deep (Fig. 5)
- Stainless steel cooking insert GN 2/3, perforated, 40 mm / 1 1/2" deep (Fig. 6)
- Wire grill (Fig. 7)
- Water connection pipe (10 ft)
- Waste water pipe (10 ft)

You can order the following **special accessories**:

- **DR 220-010:** Pressure reducer, connection accessory for water pressure 6-10 bar
- **GZ 010-011:** Extension pipes for water connections
- **WF 040-020:** Brita descaling system (filter head and filter cartridge). If the hardness of the water exceeds 7° (American water hardness), you must install a descaling system before the appliance.
- **WF 040-021:** Set of 3 filter cartridges
- **KB 220-114:** Stainless steel cooking insert GN 1/3, unperforated, 40 mm / 1 1/2" deep
- **KB 220-124:** Stainless steel cooking insert GN 1/3, perforated, 40 mm / 1 1/2" deep

## 3. Operating for the first time

### 3.1 Important notes

Before operating the appliance for the first time, please pay attention to the following notes:

Read through these instructions attentively before operating the appliance for the first time.

Remove the packaging from the appliance and dispose of it properly.  
Pay attention to the fact that there are accessories in the base of the packaging.  
Keep packaging elements away from children.

Thoroughly clean the appliance and accessories before using them for the first time. This will eliminate any “newness” smells and soiling (see Chapter 9).

Every appliance is subjected to a thorough check before it arrives in your home. It is therefore possible that there is still water in the appliance.

Before operating the appliance for the first time, make sure that the water connection is properly secured.

When you operate the appliance for the first time, the suggested time 8:00 appears on the display. You can now choose the required time of day by pressing the + and - keys. Press the ✓ (Confirmation) key to confirm the entered value.

### 3.2 Calibration

The boiling point of water depends on the barometric pressure at mean sea level.

During calibration, the appliance is adjusted to the pressure conditions prevailing at the altitude where the appliance is installed.

Recalibrate the appliance manually if you should move home to a different altitude (see chapter entitled “Options menu” on Page 21).

#### **Important:**

the calibration process cannot be interrupted.

Should the calibration process be interrupted by opening the door or switching off the appliance, the steam oven will not function. The appliance will automatically start calibration until the operation has been completed.

Recalibration is not necessary after a power failure.

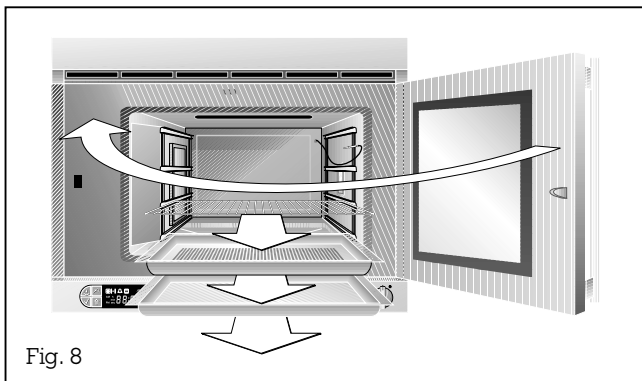



Fig. 8



Fig. 9

### Proceed as follows:

- Install the appliance at the required location (see assembly instructions).
- Remove all loose parts from the oven compartment (baking tray etc.).
- Close the appliance door.
- Open the water tap.
- Self-adjustment starts automatically as soon as you turn the "Temperature" control knob to any temperature. This takes around 15 minutes. The elapsing time appears in the display. The **"CAL"** symbol for calibration appears in the display.
- An audible signal sounds after completion of calibration. The appliance is now ready for operation. **"--:--"** appears on the display. The  (Duration) and  (Cooking time) symbols flash on the display.
- Turn the "Temperature" control knob back to the 0 position. The appliance is now ready for operation.

### 3.3 What to do, when ...

The display repeatedly flashes the symbol  (water connection).

The appliance receives no water. Turn the water connection on. Check that the pipe is correctly connected and free from bends. Turn the "Temperature" control knob to 0 and then to the required temperature.

The **R** symbol appears on the display.

The appliance has not been calibrated. Switch the appliance on, the calibration process starts automatically.

The  symbol appears on the display. The appliance does not calibrate or heat up, although the heating symbol appears on the display.

The appliance is in show room mode without heating function. Disconnect the appliance from power supply for a few seconds (by switching off the fuse), then within 3 minutes press + key and keep pressed and turn "Temperature" control knob to any temperature (not light!).

The  symbol flashes on the display.

The child lock is operating (see page 20).

The **CAL** and **40°C / 104°F** symbol flash alternating on the display.

The temperature in the oven is above 40°C / 104°F. Therefore the calibration cannot take place. The actual temperature appears on the left of the display. The appliance automatically cools the oven below 40°C / 104°F and re-starts the calibration.

**F 61** or **F 62** lights on the display.

Check the power and water supply. If these are functioning correctly call the Gaggenau after-sales service.

### 3.4 Determining water hardness

Water **hardness range 4** has been pre-entered on the appliance. If the hardness of the water in your household should deviate from this value, the correct water hardness range (between 1 and 4) must be entered **before commencing operation of the appliance**. You can find out the hardness of the water in your household either by consulting your waterworks or by using the included test strip.

- Run water from the tap for about 20 seconds to drain off stale water.
- Fill a glass with tap water and briefly (no more than 1 second) dip the test strip into the water, making sure that all test points are wetted.
- Remove the strip from the water and shake off any surplus water drops.
- You can read off the result after one minute.
- If your water contains lime, one or more of the test areas is/are of a reddish colour and the others stay light or greenish. The number of light (green) areas defines the right water hardness range setting on the appliance.

The test set must be used even if a water descaling system is already installed in your household because, depending on the descaling method, not all scale-forming ions are removed.

Number of light (green) areas on the test strip	Water hardness (German hardness)	Water hardness range
3 or more	1-7°	1
2	7-14°	2
1	14-21°	3
None	>21°	4

Please also note that different designations are used outside Germany to describe the hardness of water.

Water hardness range	1	2	3	4
American hardness	1-7°	7-14°	14-21°	>21°
French hardness	1-12°	12-25°	25-37°	>37°
British hardness	1-9°	9-18°	18-26°	>26°
Russian hardness	1-50°	50-100°	100-150°	>150°

### 3.5 Entering the water hardness

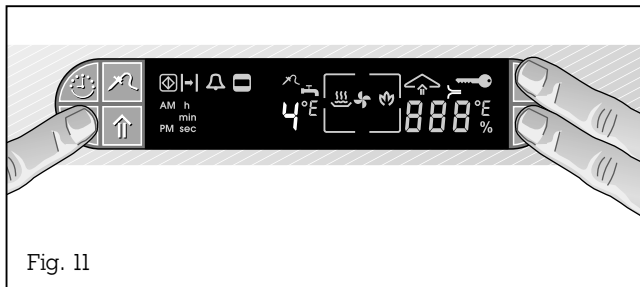
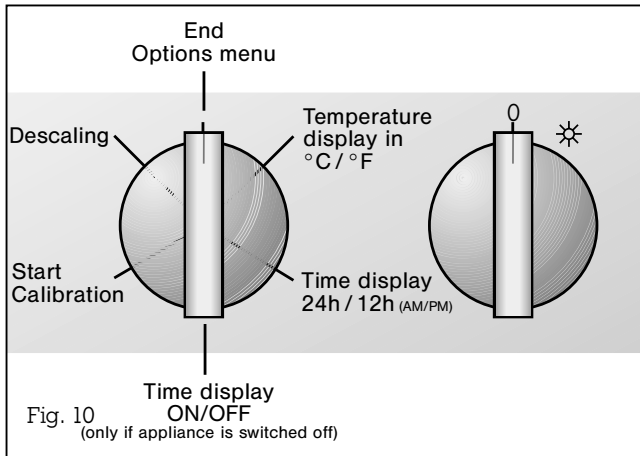

If the hardness of the water in your household deviates from the value that is set at the works (water hardness range 4), you must enter the right water hardness in the options menu for commencing operation of the appliance.

#### **Proceed as follows:**

- Turn the two control knobs to the topmost position.
- Press the √ (Confirmation) key and keep it pressed.
- Turn the "Moisture level" knob to the right.
- Release the √ (Confirmation) key.
- The various options appear on the display. Turn the "Moisture level" control knob to the right to the descaling position.
- With the + and - keys, set the water hardness (between 1 and 4) (Fig. 11).
- Press the √ (Confirmation) key.
- To quit the options menu, turn the "Moisture" control knob back up or turn the "Temperature" control knob.

## 4. Operation

### 4.1 Switching on and off

#### Switching on

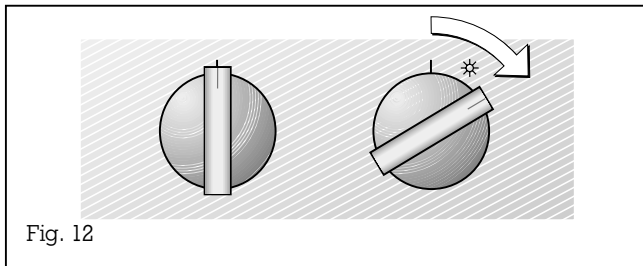

The appliance rinses automatically when switched on, if it has not been in operation for some days. This removes water that is left over in the pipes and will take no longer than 1 minute.

#### Switching off

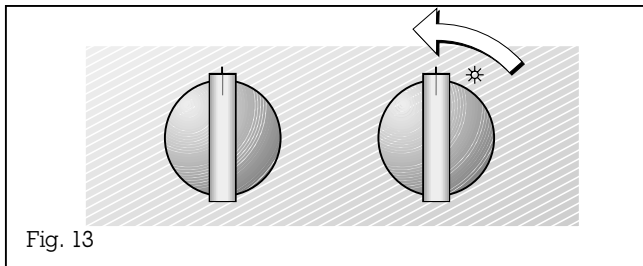

### 4.2 Control knobs

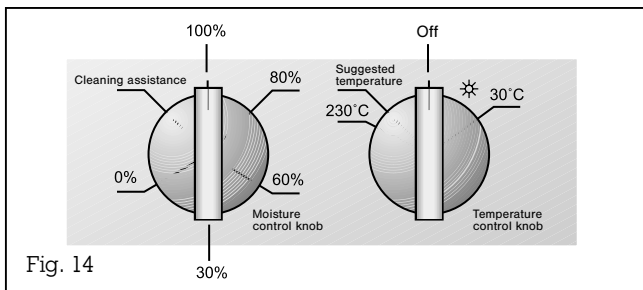

#### Switching on

– Turn the “Temperature” control knob by one latching position to the right (Fig. 12).  
The lighting goes on:

– Turn the “Moisture level” control knob to the moisture level you require.

– Turn the “Temperature” knob to the temperature you require.

When you turn the “Temperature” knob one latching position to the left, the **suggested temperature** for the chosen moisture level appears on the display.

100 %	–	100 °C / 210 °F
80 %	–	120 °C / 250 °F
60 %	–	120 °C / 250 °F
30 %	–	165 °C / 330 °F
0 %	–	165 °C / 330 °F

When the “Moisture” control knob is turned, the moisture is displayed for a few seconds.

#### Switching off:

To switch off, turn the “Temperature” knob to the 0 position (Fig. 13).

The steam oven lighting goes off.

#### “Temperature” control knob:

The temperature can be set between 30 °C / 85 °F and 230 °C / 450 °F .

#### “Moisture” control knob:

You can select the following moisture levels: 100 %, 80 %, 60 %, 30 % und 0 %

## 4.3 Operating modes

Moisture	Temperature	Display	Particularly suitable for...	Principle	Remarks
100%	150 - 230 °C 300 - 450 °F		Bread poultry, puff pastry	<b>Steam baking:</b> The high moisture prevents the food from drying out. Thanks to the high temperature, the surface become crispy brown all-round.	
100%	100 °C 210 °F		Vegetables, side dishes, blanching, sterilising, juice extraction	<b>Steaming:</b> The food is completely surrounded by steam. Steaming is a very gently method with which the food is not deprived of its goodness and retains its natural colour.	You can use several cooking inserts at the same time.
100%	120 °C 250 °F		Potatoes, pulses and beans	<b>Fast steaming:</b> The higher temperature accelerates steaming. Not suitable for sensitive foodstuffs.	
100%	80 - 90 °C 175 - 195 °F		Fish	<b>Low-temperature steaming:</b> The air in the cooking compartment is saturated with steam. The heat is transferred without any drying out whatever. Protein leaking is avoided by the lower temperature.	
80% 60%	30 - 45 °C 85 - 115 °F	 	Yeast dough, sour dough mixture Yoghurt	<b>Fermenting, rising:</b> Thanks to the moisture, the heat is distributed particularly evenly. The surfaces of doughs do not dry out so much.	Light goes off after a few seconds.
80% 60%	150 - 230 °C 300 - 450 °F	 	Casserole dishes, gratin, roast	<b>Combined steaming:</b> the middle way between steam baking and hot air operation makes it possible to achieve the optimum cooking climate for every food.	
60%	120 °C / 250 °F 160 °C / 320 °F		Plated dishes	<b>Reheating:</b> cooked food can be reheated gently. Thanks to the supply of steam, the food is not dried out. Reheat food served on plates at 120 °C / 250 °F and baked items at 160 °C / 320 °F.	Meals can be heated directly on the plate.
30%	150 - 230 °C 300 - 450 °F		Yeast pastry	In this mode of operation, the cooking compartment is sealed hermetically. The remaining moisture prevents the drying effect of conventional hot air.	
30%	70 - 80 °C 160 - 175 °F		Roast beef, leg of lamb	<b>Low-temperature cooking:</b> briefly seared meat can mature slowly and gently over a long cooking time.	
0%	150 - 230 °C 300 - 450 °F		Fruit cake	<b>Convection:</b> the cooking compartment is ventilated and vented through an opening so that the moisture produced can be dissipated. This is particularly advantageous for baked items that have to give off moisture during the baking process.	
100%	60 °C 140 °F			<b>Cleaning aid</b> The cleaning aid makes it possible to loosen soiling with steam.	

---

## 4.4 Operating the timer

The required moisture level and temperature can be set before and after time programming by turning the "Temperature" or "moisture level" knob.

As long as one or several symbol(s) in the display flash(es), no input is possible and no value is programmed or an invalid value has been programmed.

All time values are entered by means of the ☺ (timer), +, - and ✓ (confirmation) keys. Every input triggers an audible and a visible signal.

If you select a program (e.g. end), but you do not enter a value, the current time will appear on the display after 20 seconds.

An entered value (e.g. duration programming) must be confirmed within 20 seconds ✓ (Confirm) key. Entered values are not stored if they are not confirmed.

Press the ✓ (Confirm) key if you wish to confirm a value during programming.

If you press any other key instead, the entered value will not be stored and will disappear.

You can query set values by pressing the ☺ (timer) key. The value appears on the display for around 10 seconds. During this time, you can modify the value by pressing the + or - key and you can confirm it by pressing the ✓ (Confirm) key.

Press the + and - keys at the same time if you wish to clear a value.

If you have already programmed a time value once (e.g. a duration) on the appliance, this previously programmed value will be proposed to you when programming a value again.

The longer you press the + or - key when programming a time, the faster the time elapses on the display.

After completion of time programming, the corresponding symbol flashes on the display. For example, if you have programmed an end time, the -| (end time) symbol will flash. An audible signal is also sounded. Heating is deactivated and the oven lighting goes off. You can restart the previously selected mode by pressing any key on the display. You end the baking process by turning the "Temperature" knob to 0.

During a time programming it is possible at any time to turn the "Temperature" control knob back to 0. The steam oven will then no longer heat. The previously programmed value is retained. An audible signal sounds after the entered time has elapsed.

Every alarm goes off after 3 minutes.

Note: all time programming functions can be programmed simultaneously.



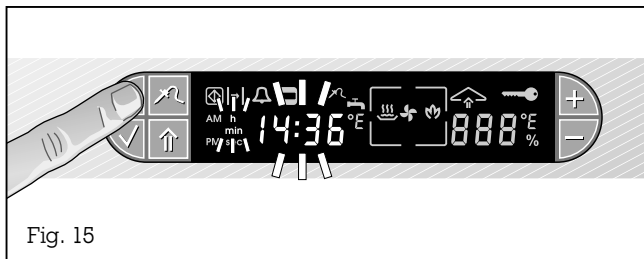

### Setting the time of day

#### Proceed as follows:

- Press the ⌚ (Timer) key **3 times**. The <sup>h</sup> min (Time unit) symbol flashes on the display.  
The time display shows the currently set time of day (Fig. 15).
- You can select the required time by pressing the + or - key.
- Press the ✓ (Confirmation) key to confirm the entered value. An audible signal is sounded.

After first installation or a power failure lasting several hours, 08:00 and the time unit symbol will flash in the display. You can set the current time by pressing the + and - keys. 08:00 will be stored as the time of day if you turn one of the control knobs.

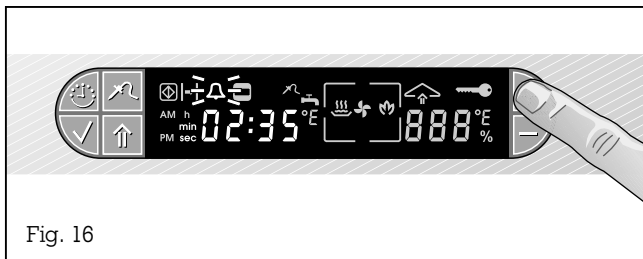

Fig. 16

The last programmed value is proposed to you every other time you program a short time.

### Short time

You can program a period of time with the short time function without automatic activation or deactivation. You can use this mode of operation even when the appliance is switched off as an egg timer, for example. The range that can be set is between ten seconds (00:10) and 23.59 hours (23:59)

#### Proceed as follows:

- Press the + key. The short time symbol  $\Delta$  flashes (Fig. 16).
- The entered value appears on the display, which you can modify by pressing the + or - key. The time unit symbol  $\frac{\text{min}}{\text{sec}}$  lights up.
- Press the  $\checkmark$  (Confirm) key to confirm the entered value.
- The elapsing time is displayed.

**Note:** if nothing is entered for 5 seconds, the short time starts even if the  $\checkmark$  key (Confirm) is not pressed.

Once the short time has elapsed, an audible signal sounds and the  $\Delta$  (Short time) symbol flashes on the display. The signal goes off when you press any key. The short time reminder can be switched off at any time by pressing the + and - minus keys at the same time.

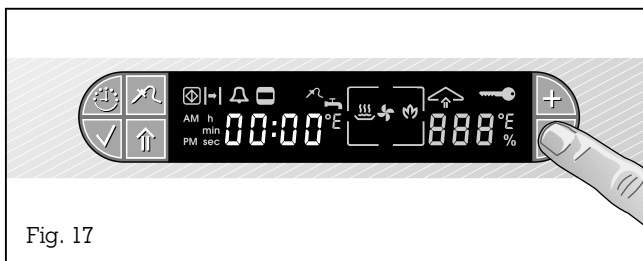

Fig. 17

### Elapsing timer

#### Proceed as follows:

- Press the - key (Fig. 17).
- The time, beginning at 00:00, is displayed (maximum display: value 12 hours). Thus, you can continuously display the elapsed cooking time without programming automatic deactivation. When you press the - key again, the time is switched off.

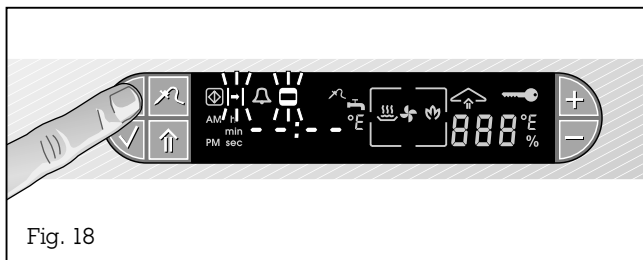

Fig. 18

### Programming a duration

The appliance is operated for a specific period of time. The range that can be set is between one minute (00:01) and 23 hours and 59 minutes (23:59).

#### Proceed as follows:

- Press the ☺ (Timer) key once. The ⌂ (Duration) symbol and the ◻ (Cooking time) symbol flash on the display. Dashes appear on the display (i.e. no value programmed).
- Press the + or the - key to set the required duration.
- Press the ✓ (Confirm) key to confirm the set value. An audible signal is sounded. The ◻ (Cooking time) symbol lights up on the display.

The end time is displayed automatically if you press the ☺ (Timer) key twice.

Every other time you program a duration, the value programmed last is proposed to you when you press the + key.

- A signal is sounded after the programmed duration has elapsed. At the same time, the steam oven switches off automatically.
- By pressing any key, you can switch off the signal and heating will start again. Turn the temperature selector switch to 0 to end the operation.

#### Clearing incorrectly programmed values:

- Press the ☺ (Timer) key once.
- Press the + and - keys at the same time. An audible signal is sounded.

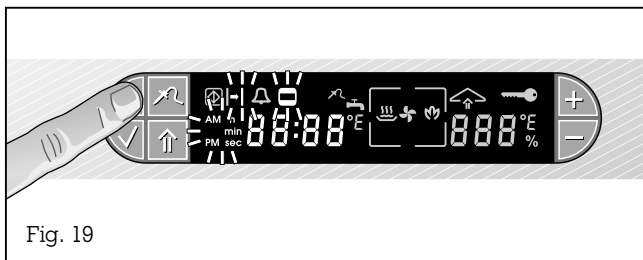

Fig. 19

**Note:** the time of day that is set on the appliance is the starting point for programming the switch-off time.

You can query the entered value by pressing the ☹️ (Timer) key twice.

### Programming a switch-off time

The appliance switches off automatically at a time that you have chosen. The starting point is the time of day set on the appliance.

#### Proceed as follows:

- Press the ☹️ (Timer) key twice. The + (End) and ☐ (Cooking time) symbols flash.
- Press the + or - key to set the required time. You can choose any switch-off time within a period of 24 hours.
- Press the ✓ (Confirm) key to confirm the entered value. An audible signal is sounded. The ☐ (Cooking time) symbol lights up on the display.

After the set time has elapsed, the ☐ (Cooking time) symbol flashes and an audible signal is sounded.

By pressing any key, you can switch off the signal and heating will start again. Turn the temperature selector switch to 0 to end the operation.

### Programming a duration and an off time

This mode enables you to start and end baking and cooking in your absence.

#### Proceed as follows:

- Enter a required duration (see page 18).
- Press the ✓ (Confirmation) key.
- Enter the required switch-off time (see above).
- Press the ✓ (Confirmation) key.

The automatic mode becomes active as soon as the switch-off time is programmed and you have pressed the ✓ (Confirm) key.

## 5. Special functions

### 5.1 Child lock

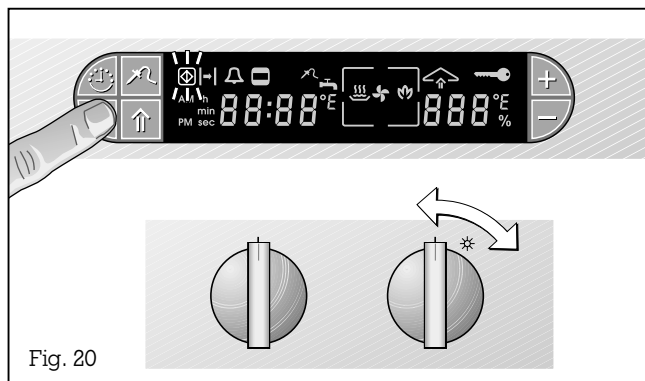

Fig. 20

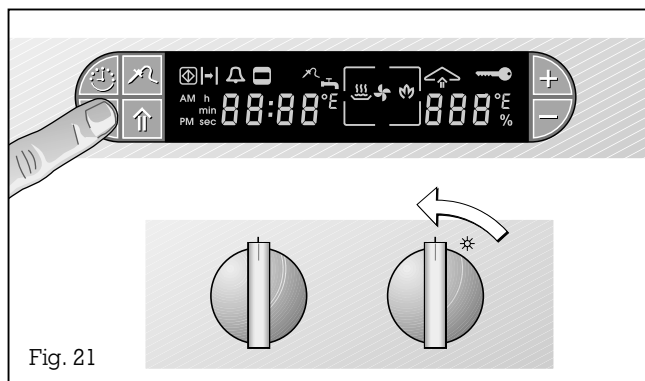

Fig. 21

The child lock prevents inadvertent activation of the steam oven.

#### **Proceed as follows:**

##### **Switching on:**

- Turn the "Temperature" control knob to the right to any temperature position (not light).
- Press the √ (Confirm) key and keep it pressed.
- Turn the "Temperature" control knob to the 0 position (Fig. 20).

The ☒ (Child lock) symbol on the display flashes.

##### **Switching off:**

- Press the √ (Confirm) key and keep it pressed.
- Turn the "Temperature" control knob to the right to any temperature position (not light).
- Release the √ (Confirmation) key.
- Turn the "Temperature" control knob to the 0 position (Fig. 21).

The ☒ (Child lock) symbol on the display goes off.

## 5.2 Options menu

- With the aid of the Options menu, you can
- choose between °C and °F on the temperature display.
  - choose between 12h and 24h on the time display.
  - turn the timer on and off.
  - start calibration.
  - reset the descaling display.

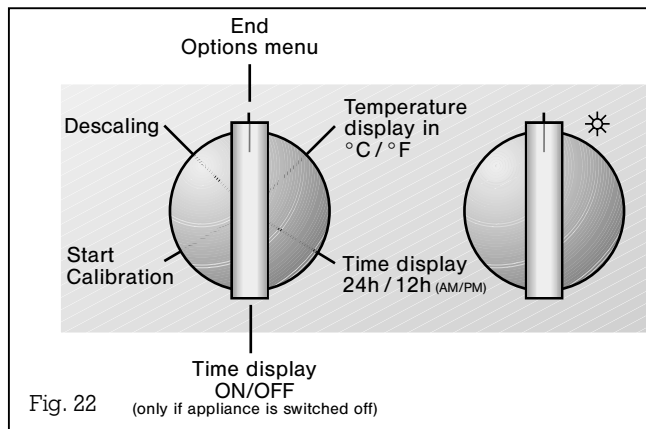

### Proceed as follows:

- Turn the two control knobs to the topmost position.
- Press the √ (Confirm) key and keep it pressed.
- Turn the "Moisture level" knob to the right.
- Release the √ (Confirmation) key.
- By turning the "Moisture level" control knob, you can now choose the various functions (Fig. 22):
  - Position 1: temperature display either in °C or °F
  - Position 2: time display in 24 hours or 12 hours (am and pm)
  - Position 3: optional deactivation of the time display when the appliance is off
  - Position 4: calibration – you can now start the calibration process when you turn the "Temperature" control knob to any position except light.
  - Position 5: descaling, enter water hardness
- Set the required option by pressing the + or - key.
- Press the √ (Confirmation) key
- To quit the options menu, turn the "Moisture" control knob back up or turn the "Temperature" control knob.

### 5.3 Core temperature sensor

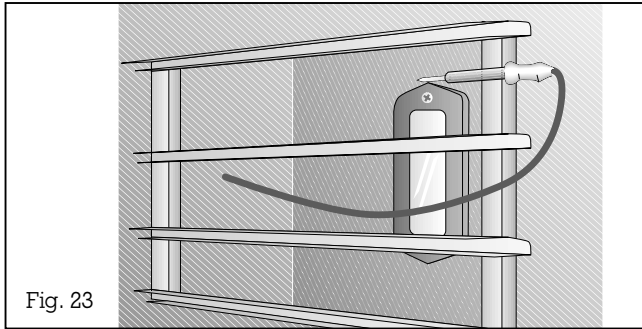

Fig. 23

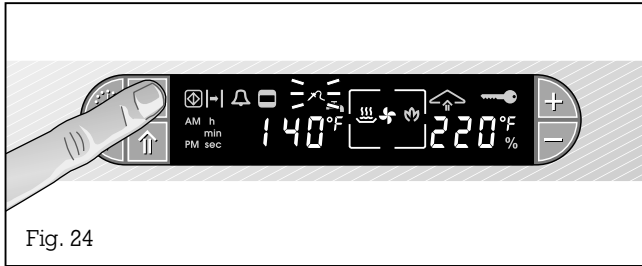

Fig. 24

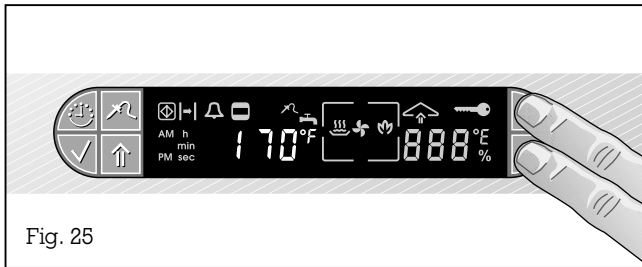

Fig. 25

Using the core temperature sensor, during the cooking process you can measure the core temperature of the food you are preparing exactly between 1°C / 5°F and 99°C / 210°F. The sensor measures the temperature in the interior of the meat. It indicates when the set core temperature has been reached and the meat has been cooked to satisfaction.

The core temperature sensor

- enables exact cooking to the spot.
- prevents overcooking of roasts.
- provides you with a display of the actual temperature for total control of the cooking process.

#### Proceed as follows:

- Preheat the oven.
  - Insert the cooking insert with the food.
  - Insert the tip of the core temperature sensor in the middle of the food, at its thickest point; not in the middle in the case of poultry (hollow), but between the belly and the thigh. The measuring tip must not touch any bones and should not be inserted into fatty tissue.
- Caution:** the core temperature sensor and the sides are hot. Use a glove.
- Close the oven door.
  - Press the ^ (Core temperature sensor) key twice. The ^ (Core temperature sensor) symbol flashes and the suggested value of 60°C / 140°F can be seen on the display (Fig. 24).
  - You can enter a value between 1°C / 5°F and 99°C / 210°F (see table) by pressing the + and - keys (Fig. 25).
  - Press the ✓ (Confirmation) key to confirm the entered value. An audible signal is sounded.

An audible signal sounds as soon as the programmed core temperature has been reached. The oven switches off automatically. The ^ (Core temperature sensor) and -| (End) symbols flash on the display.

**Caution:** pull out the core temperature sensor before removing the food. Use a glove to do this because the core temperature sensor gets very hot during operation.

**Note:** when you press the ^ (Core temperature sensor) key **once**, the temperature on the core temperature sensor is displayed for a few seconds.

**Clearing the core temperature:**

- Press the ^ (Core temperature sensor) key **twice**. The ^ (Core temperature sensor) symbol flashes on the display.

- Press the + and - keys at the same time.

- An audible signal sounds and the ^ (Core temperature sensor) symbol goes off.

**To clean** it, simply rub the core temperature sensor with a moist cloth.

**Note:**

you cannot set a temperature on the core temperature sensor that is lower than the core temperature of the food you are preparing.

If you set programming with the core temperature sensor and the timer at the same time, the programming that reaches the entered value first will switch off the oven.

Recommended core temperature values

**Beef**

Roast beef / fillet of beef		
	rare	45-50 °C/115-120 °F
	medium-rare	55-65 °C/130-150 °F
	well-done	70-80 °C/160-175 °F
Beef roast		80-85 °C/175-185 °F
Boiled fillet of beef		90 °C/195 °F

**Pork**

Roast pork		75-80 °C/165-175 °F
Back of pork		65-70 °C/150-160 °F
Meat loaf		85 °C/185 °F

**Veal**

Roast veal		75-80 °C/165-175 °F
Breast of veal, stuffed		75-80 °C/165-175 °F
Back of veal	medium-rare	65-70 °C/150-160 °F

**Venison**

Leg of venison		75-80 °C/165-175 °F
Back of hare / venison		65-70 °C/150-160 °F

**Poultry**

Chicken		85 °C/185 °F
Goose		85-90 °C/185-195 °F
Turkey, duck		80-85 °C/175-185 °F
Duck breast		70 °C/160 °F

**Lamb**

Leg of lamb	medium-rare	55-65 °C/130-150 °F
Lamb	well-done	75-80 °C/165-175 °F

**Mutton**

Leg of mutton	medium-rare	75-80 °C/165-175 °F
Back of lamb	well-done	80 °C/175 °F

**Bread**

90 °C/195 °F



## 5.4 Steaming

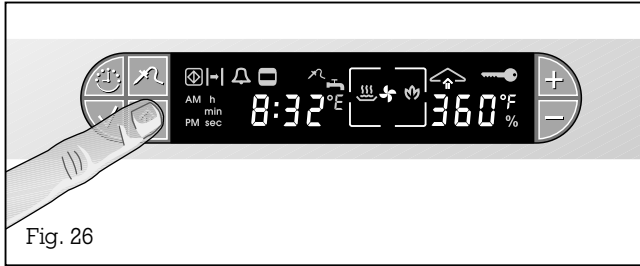

Fig. 26

You have a possibility of deliberately adding more moisture to the food you are cooking (e.g. bread, bread rolls).

**Note:** steaming is only possible at the "Convection" stage (0%) or with 30% moisture (0%).

### Proceed as follows:

- Press the  $\uparrow$  (Steaming / Condensing) key (Fig. 26).
- Steaming lasts for as long as you keep the  $\uparrow$  key pressed, but no more than 8 seconds. You can trigger steaming again by pressing the  $\uparrow$  (Steaming / Condensing) key yet again.

## 5.5 Condensing

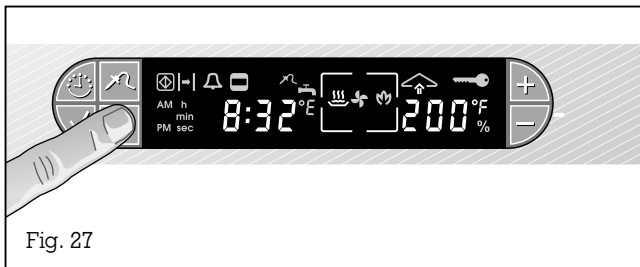

Fig. 27

Before opening the door it is possible to remove the steam in the oven using the condensation mode. Water is added to the cooking compartment. This causes the cooking compartment to cool. So, when opening the door after condensing, less steam blows into your face.

**Note:** condensing is only possible by a humidity of 100 %, 80 % and 60 % and at a temperature below 130°C / 265°F.

### Proceed as follows:

- Press the  $\uparrow$  (Steaming / Condensing) key for approx. one second (Fig. 27).
- Condensation starts to run only when the door is closed.
- After condensation (approx. 20 sec.), an audible signal sounds. If the door is not opened, the appliance continues heating after a few seconds.
- You can end the process by opening the door (**Caution!** Drops of water may drip from the door) or pressing the condensing key.

## 5.6 Display of the current cooking compartment temperature (ThermoTest)

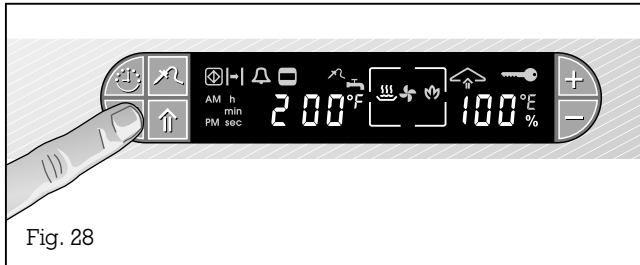

## 5.7 Power failure protection

## 5.8 Holiday protection

## 5.9 Cleaning aid

When you press the ✓ (Confirmation) key, the current temperature in the cooking compartment and the moisture level appears on the display for a few seconds (Fig. 28).

**Note:** if the appliance is operated for a prolonged period unavoidable temperature fluctuations of up to 5°C / 10°F may occur. When the setting 100°C / 210°F and 100 % humidity has been selected the appliance will heat until boiling point. The boiling point is dependent on the position above sea level and is usually, in fact, below 100°C / 210°F . In order to steam at boiling point you must select 100°C / 210°F .

When the steam oven is on, heating is interrupted if the power should fail and if it should then return again.

**Note:** the appliance bridges a power failure lasting 5 minutes. The cooking process can be continued unhindered. A prolonged power failure may have a negative influence on the cooking process. This is why cooking stays interrupted. You must switch the appliance off and then on again.

For your protection, the appliance features holiday protection. Every heating operation is switched off after 15 hours if the appliance is not operated during this time. Dashes appear on the display. Turn the two control knobs to 0. You can then operate the appliance in the way to which you are accustomed. This function is not active when a time has been programmed.

The cleaning assistance feature loosens soiling, which can then be removed with greater ease (see Chapter 9.3).

## 6. Further uses

### Low-temperature cooking

Vigorously browned meat matures over a longer time at a lower temperature.

- Preheat the appliance to 70 - 80°C / 160 - 175°F (depending on the size of the food). To do this, turn the "Moisture content" control knob to the 30 % position.
- Briefly roast the meat on all sides in a pan.  
Note: the longer you roast the meat in the pan, the shorter the roasting time in the oven.
- Place the meat on a preheated plate in the oven.
- Larger pieces of meat (e.g. entrecote, roast beef or leg of lamb) need 2 - 4 hours).  
Smaller pieces of meat (steak or diced chicken) take 30 - 60 minutes.
- You can reduce the temperature to 60°C / 140°F towards the end of the cooking time. For larger pieces of meat, you can extend the cooking time by 2 - 4 hours or for smaller pieces you can extend it by 30 - 45 minutes.

### Reheating

Warming up ready-cooked meals without quality losses.

- Heat up the appliance to 120°C / 250°F . To do this, turn the "Moisture" control knob to the 60 % position.
- Portion cooked but cold meals on plates.
- Place the plates on the wire grill.
- Cooking time: 7 - 15 minutes.

Note: to reheat vegetables or pastas choose a temperature of 100°C / 210°F and a moisture of 100 %.

### Fermenting

Raising yeast dough, self-raising flour and sour dough mixtures

- Place the bowl containing the dough on the wire grill.
- Turn the "Temperature" knob to 30 - 40°C / 85 - 105°F and the "Moisture content" knob to 60 %.

### Extracting juice

The steam oven allows you to extract juices even without a special juice extraction pot.

- Place the fruit or berries in the perforated cooking insert.
- Insert the perforated cooking insert with the fruit in the 3rd level from below.
- Place the deep unperforated cooking insert one level lower to collect the juice.
- Turn the "Temperature" knob to 100°C / 210°F and the "Moisture content" knob to 100 %.

Leave the fruit in the appliance until juice no longer appears (1 - 2 hours depending on the type of fruit).

### Sterilising

Preserving fruit, vegetables and meats in preserving jars.

- Place the filled preserving jars on the gridiron or the perforated cooking insert. Important: the jars must not touch each other.
- Turn the "Temperature" knob to 100°C / 210°F and the "Moisture content" knob to 100 %.
- Turn the "Temperature" knob to 0 as soon as the contents of the jars begin to bubble.

Do not remove the preserving jars from the oven until they have cooled down completely.

## Thawing

Thawing deep frozen products gently and in a short time.

- Place the frozen foodstuff in the perforated cooking receptacle.
- Insert the perforated cooking insert with the frozen food in the 2nd level from below.
- Insert the unperforated cooking insert one level lower to collect the thawing liquid.
- Turn the "Temperature" knob to 45 - 50°C / 115 - 120°F and the "Moisture content" knob to 80 %.

The time it takes to thaw depends on the size and weight of the frozen food.

Application examples:

Chicken (1000 g)	55 - 65 minutes
Chicken legs (400 g)	30 - 35 minutes
Vegetable frozen in a block (e.g. spinach) (400 g)	20 - 30 minutes
Berries (300 g)	8 - 10 minutes
Fish fillet (400 g)	15 - 20 minutes

After the thawing time has elapsed, leave thawed food for another 10-15 minutes in the appliance after switching off to ensure that the food is able to thaw right down to its interior.

## Blanching

By blanching, vegetables that are to be frozen, for example, retain their natural colour.

- Place the food in a perforated cooking receptacle.
- Turn the "Temperature" knob to 100°C / 210°F and the "Moisture content" knob to 100 %.
- As soon as the temperature has been reached, place the cooking receptacle in the second level from below and place the unperforated cooking receptacle one level lower.

- After 1-2 minutes, remove the cooking receptacle from the oven again and place the vegetables in iced water to cool them.

- Allow the food to drip off well.

## Preparing yoghurt

Preparing yoghurt the do-it-yourself way.

- Heat milk (except long-life milk) on the hob to 90°C / 195°F to avoid disturbing the bacteria in the lactic acid.
- Cool the milk to 40°C / 104°F in a water bath.
- Stir natural yoghurt (without fruit) into the milk (1-2 teaspoons for every 100 ml).
- Pour the yoghurt into clean jars.
- In the case of yoghurt ferment, pay attention to the notes on the packet.
- Turn the "Temperature" knob to 45°C / 115°F and the "Moisture content" knob to 80 %. Allow the yoghurt to mature for 4 - 6 hours.

**Note:** the time needed for maturity will be lengthened if you use cold milk to produce the yoghurt.

On completion, place the yoghurt in the fridge!

**Tip:** before heating the milk, add skimmed milk powder (1 - 2 tablespoons for every litre) to obtain yoghurt that will not go off.

To kill off undesirable germs, before preparing the yoghurt place the yoghurt jars in the oven compartment for a few minutes at 100°C / 210°F and 100 % moisture. **Caution!** The yoghurt jars are hot. Allow them to cool down before taking them out of the oven.

## 7. Cooking table

Dish	Cooking insert selection *	Quantity (end weight)
<b>VEGETABLES **</b>		
Leaf spinach	perforated / unperforated	500 g
Cauliflower	perforated	1 head
Cauliflower and carrots	perforated	together approx. 1 kg
Broccoli	perforated	1 kg
Peas	perforated / unperforated	1 kg
Stuffed vegetables (courgette, aubergine, peppers)	unperforated	
Green beans	perforated	1 kg
Kohlrabi	perforated	1 kg
Leek	perforated / unperforated	1 kg
Carrots	perforated	1 kg
Jacket potatoes	perforated	1 kg (average size)
Boiled potatoes	unperforated	1 kg
Asparagus, green	perforated	1 kg
Asparagus, purple	perforated	1 kg
Skinned tomatoes	perforated	
<b>MISCELLANEOUS</b>		
Vegetable pudding / vegetable flan	perforated, wire grill	
Potato gratin	unperforated	
Dumplings	perforated / unperforated	
Lasagne	unperforated	
Soufflé	shelf, perforated	
Soup ingredients (cooked-egg-garnish, semolina dumpling)	unperforated	
<b>PULSES / RICE ***</b>		
Long grain rice	unperforated	250 g + 600 ml water
Parboiled rice	unperforated	250 g + 600 ml water
Lentils	unperforated	250 g + 750 ml water
Pre-soaked white beans	unperforated	250 g + 1 l water

\* Place the cooking insert on the second shelf from bottom. When steaming you can use two cooking inserts simultaneously. Use the second and third shelves from bottom.

\*\* Some types of vegetables can be "quick steamed" at 100 % and temperatures between 102 - 120 °C / 215 - 250 °F. The higher temperature shortens the cooking time. Not recommended for sensitive foods!

\*\*\* Follow packaging instructions.

Preparation	Temperature	Moisture	Core temp.	Cooking times (approx. in min.)
plucked	100 °C / 210 °F	100%		2 - 5
whole	100 °C / 210 °F	100%		20 - 30
in roses / in slices	100 °C / 210 °F	100%		20 - 25
in roses	100 °C / 210 °F	100%		10 - 15
	100 °C / 210 °F	100%		12 - 18
	160 - 180 °C / 320 - 355 °F	80 - 100%		20 - 30
whole	100 °C / 210 °F	100%		20 - 35
in slices	100 °C / 210 °F	100%		15 - 25
in slices	100 °C / 210 °F	100%		9 - 12
in slices	100 °C / 210 °F	100%		15 - 25
prick with fork	100 °C / 210 °F	100%		35 - 50
quartered, salted	100 °C / 210 °F	100%		15 - 25
whole	100 °C / 210 °F	100%		10 - 15
whole	100 °C / 210 °F	100%		15 - 20
whole	100 °C / 210 °F	100%		1 - 2
bain marie, 1,5 l	100 °C / 210 °F	100%		60 - 70
see recipe book	180 - 200 °C / 355 - 390 °F	30 - 60%		30 - 45
	100 °C / 210 °F	100%		15 - 25
see recipe book	175 - 200 °C / 350 - 390 °F	80%		35 - 45
in soufflé dish, see recipe book	175 - 200 °C / 350 - 390 °F	60 - 100%		10 - 20
	100 °C / 210 °F	80 - 100%		10 - 20
	100 °C / 210 °F	100%		20 - 30
	100 °C / 210 °F	100%		15 - 20
	120 °C / 250 °F	100%		30 - 40
	120 °C / 250 °F	100%		55 - 65

**Note:**

the cooking times and quantities given here are rough values for 4 people. Smaller quantities shorten cooking time. Always preheat the steam oven. If the appliance is not preheated, cooking times are lengthened by about 5 minutes.

# Cooking table

Dish	Cooking insert selection *	Quantity (end weight)
<b>MEAT</b>		
Fillet in puff pastry	perforated with baking paper	1 - 1,5 kg
Roast pork with rind	wire grill, unperforated	1,5 kg
Leg of lamb (Low-temperature cooking)	perforated	1,5 - 2,5 kg
Roast beef (Low-temperature cooking)	perforated	1,5 - 2,5 kg
Roast pork (collar / shoulder)	wire grill, unperforated	1,5 kg
Boiled fillet of beef	unperforated	1 kg
<b>POULTRY</b>		
Duck (whole)	wire grill, unperforated	2 - 3 kg
Duck breast	unperforated	
Chicken (whole)	wire grill	1 - 1,5 kg
Leg of chicken	wire grill	4 - 6 pieces
<b>FISH</b>		
Bream	perforated	
Fish tureen	wire grill	
Trout (whole)	perforated / unperforated	2 à 300 g
Salmon fillet	perforated / unperforated	800 g
Mussels	perforated/unperforated	1,5 kg
Rolled sole, stuffed	perforated / unperforated	
<b>DESSERTS</b>		
Crème Brûlée	wire grill / perforated	
Yeast dumplings	unperforated	
Sweet soufflé	wire grill	
<b>REHEATING</b>		
Food served on plates	wire grill	
Vegetables, starch side dishes (potatoes, rice, pasta)	unperforated	0,5 - 1 kg

\* Place the cooking insert on the second shelf from bottom. When steaming you can use two cooking inserts simultaneously. Use the second and third shelves from bottom.

\*\*\*\* Change to the second moisture or temperature value 15 - 20 min. before the end of the cooking.

Preparation	Temperature	Moisture	Core temp.	Cooking times (approx. in min.)
see recipe book	180 - 200°C / 355 - 390°F	80 - 100%		50 - 60
cut the rind between step 1 and 2 and season	1) 100°C / 210°F	100%	80-85°C/175-185°F	5
	2) 160 - 170°C / 320 - 340°F	60 - 80%		50 - 60
	3) 210°C / 410°F	0%		KT
first brown vigorously on hob	75 - 80°C / 165 - 175°F	0 - 30%		180 - 240
first brown vigorously on hob	75 - 80°C / 165 - 175°F	0 - 30%		180 - 240
0,5 l liquid and vegetables	200 - 220°C / 390 - 430°F	60%	80-85°C/175-185°F	(60 - 70)
	100°C / 210°F	100%	90°C/195°F	100 - 120
see recipe book	160/200°C - 320/390°F ****	60 - 80%	80-85°C/175-185°F	70 - 100
first brown on hotplate	160°C / 320°F	0 - 30%	70°C/160°F	15 - 20
	200°C / 390°F	100 / 0% ****	85°C/185°F	45 - 55
	180°C / 355°F	100 / 0% ****		20 - 35
tureen	80° - 90°C / 175 - 195°F	100%		15 - 25
	75°C / 165°F	80%		40 - 50
	80 - 90°C / 175 - 195°F	100%		12 - 15
	80 - 90°C / 175 - 195°F	100%		12 - 18
	100 - 120°C / 210 - 250°F	100%		12 - 15
see recipe book	150°C / 300°F	80%		8 - 10
see recipe book	160°C / 320°F	60%		10 - 15
	100°C / 210°F	100%		15 - 25
in oven proof dish, see recipe book	150°C / 300°F	60%		8 - 10
	120°C / 250°F	60%		7 - 15
	90 - 100°C / 195 - 210°F	80 - 100%		7 - 15

**Note:**

the cooking times and quantities given here are rough values for 4 people. Smaller quantities shorten cooking time. Always preheat the steam oven. If the appliance is not preheated, cooking times are lengthened by about 5 minutes.



# Baking table

Cakes and biscuits	Temperature	Moisture	Cooking time (app. in min.)	Special notes
Apple tart	170 - 190°C / 340 - 375°F	30%	30 - 45	
Swiss roll	190 - 210°C / 375 - 410°F	0 - 30%	7 - 9	
Small flaky pastry cakes	180 - 200°C / 355 - 390°F	80 - 100%	15 - 25	
Bread (1 kg) **	200/165°C - 390/330°F *	80 - 100%	50 - 55	
Bread rolls **	200 - 220°C / 390 - 430°F	80 - 100%	20 - 30	
Plaited buns **	165 - 170°C / 330 - 375°F	30 - 60%	35 - 45	see recipe book
Ring cake (yeast)	160 - 175°C / 340 - 350°F	30 - 60%	45 - 50	
Fruit pie made of yeast dough	160 - 175°C / 340 - 350°F	0 - 30%	40 - 55	see recipe book
Biscuits	160 - 175°C / 340 - 350°F	0 %	15 - 20	
Quiche, fruit tarts	180 - 210°C / 355 - 410°F	0 - 30%	35 - 45	see recipe book
Sponge cake	160 - 175°C / 340 - 350°F	0 - 30%	50 - 60	see recipe book
Cream puffs	200 - 210°C / 390 - 410°F	0 - 30%	20 - 30	
Onion pie	170 - 180°C / 340 - 355°F	60 - 80%	40 - 50	see recipe book

**Note:** the cooking times and quantities given here are rough values for 4 people. Smaller quantities shorten cooking time. Always preheat the steam oven. You can only bake on one level. Use the second level from bottom.

\* Reduce to the second temperature value after 15 min.

\*\*Bread and bread rolls can be successfully baked as follows: Preheat at 220 °C / 430 °F and 30 % moisture. After placing them in the oven, steam once or twice. After 5 minutes reduce to 0 % moisture and 190 °C / 375 °F .

## 8. Tips and tricks

### General:

- The appliance does not need long to heat up. It therefore operates in an extremely energy and time-saving fashion.
- Cooking times depend on the quality, weight and height of the food. This is why specified values can only serve as recommendations.
- Food being cooked must not come into contact with the oven compartment, the grease filter or the air baffle.
- The steam oven door must seal well. So always keep the door seal faces clean.
- Do not place too much on wire grill and in receptacles. This will ensure optimum circulation of the air.

### What are all the things you can do better with the steam oven?

- Cook potatoes in the perforated receptacle. By doing so, you will ensure that the steam can reach the potatoes from all sides. This will make cooking more intensive.
- Use the perforated insert to boil large quantities of eggs. Please note: Compared to an egg boiler, the cooking time is extended by 2-3 minutes. You will have to preheat the appliance if you want to boil soft eggs.
- You can collect vegetable juices by placing the unperforated insert in the bottom rack.
- For foods that are sensitive to pressure (such as dumplings), you are best using two low cooking receptacles rather than just one. By doing so, you will ensure that items do not lie on one another and cannot get crushed.
- Peel tomatoes: cut into the tomatoes and place them in the steam for 1 to 2 minutes. Then dip the tomatoes in ice water.
- You can even decrystallise honey with your steam oven. To do this, set a temperature of 60°C / 140°F and a moisture level of 100 % steam.

### Tips on how to save energy and protect the environment:

- Give good thought to what foods you can cook at the same time. This will ensure an even load on your appliance and will save you time and energy.
- Avoid opening the steam oven door frequently and for prolonged periods. Otherwise, generated steam and heat can escape unhindered and then has to be generated again. This involves a loss of large amounts of energy and prolongs the cooking time.
- You can often use several levels at once (when steaming with up to 100°C / 210°F, not when baking).

### Thawing tips:

- Only thaw the quantity you need.
- Please remember: once food has been thawed, it may not be possible to keep it for as long as intended and it will perish faster than fresh food.
- Thawing: thaw pieces of meat that you intend to bread long enough to ensure that spices and the bread crumbs will adhere to the meat.
- Thawing poultry: remove poultry from its packaging before thawing. Important: pour away the thawed water.
- You can store kitchen herbs frozen and you can use them unthawed.
- Thawing and heating in steam is possible instead of a bain-marie. Leave the meal in the bag or put in directly on a plate.

### Sterilising:

- If possible preserve foodstuffs immediately after buying or harvesting them. Prolonged storage reduces their vitamin content and leads easily to fermentation.
- Only ever use fruit and vegetables that are in a perfect state. Examine preserving jars and rubber rings exactly. Check clips and springs. Sterilise the jars and clean the rubber rings. Rinse them with hot water.

## 9. Cleaning and care

### 9.1 Manual cleaning

You should thoroughly clean the appliance **before operating it for the first time and after every use**. By doing so, you avoid baking in of residues. After residues have baked in several times, they are then difficult to remove.

Never use any abrasive or aggressive cleaning agents such as abrasive agents, steel wool, saponified steel wool, metal sponges, plastic sponges or sponges with an abrasive surface.

After cleaning, remove all cleaning agent residues without leaving any on the appliance.

When you wish to clean the appliance manually, switch it off and allow it to cool down.

Clean **accessory parts** (cooking inserts etc.) in a dishwasher or with hot water and rinsing detergent. You can loosen food remainders that have burnt into the cooking inserts by placing a little water and rinsing detergent in the cooking insert. Soak these in the steam oven at 70°C / 160°F and 100 % moisture.

The **outer surfaces** must only be cleaned with a soft cloth. Do not use any commercially available stainless steel cleaners as these may be aggressive to the printed markings.

Clean **operator controls and glass surfaces** with a soft cloth and light rinsing detergent and wipe them dry with a soft dry cloth. Do not use any abrasive or nitro polishing agents for cleaning. Do not use any abrasive sponges either. Do not spray anything onto the switch panel. Do not use strongly alkaline cleaning agents (such as oven spray) because these are aggressive to the aluminium surface.

Do not scrape off **burnt-in food remainders**. Remove them by means of the cleaning aid function instead (see Chapter 9.3).

**Caution:** do not clean this appliance with a steam cleaning unit or with water pressure - risk of short-circuits!

Empty the **drip channel** and clean it.

Clean the **grease filter** at regular intervals. Remove the support grills. Push up the grease filter and then remove it.

Clean the **strainer and the siphon** at regular intervals. To do this, unscrew the strainer from the bottom plate.

## 9.2 Cleaning the side plate

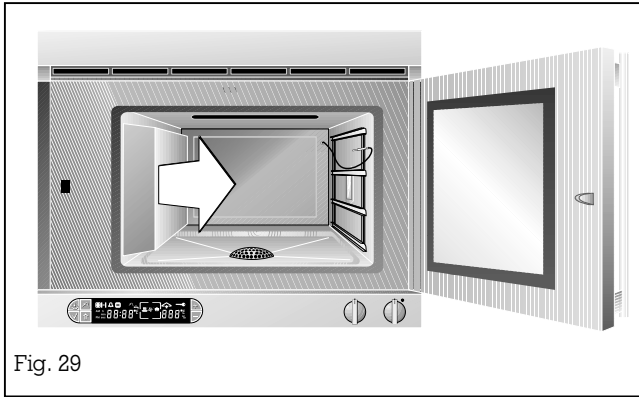

Fig. 29

- Allow the appliance to cool down completely before cleaning it.
- Be careful that no small parts fall into the base strainer.
- Pull out the left shelf after undoing the knurled nut on the front side.
- The grease filter can be detached in the upward direction.
- To remove the side plate, undo the 4 nuts with a socket spanner (8 mm). Be careful not to scratch the inside of the cooker.
- Do not use any abrasive cleaning agents to clean the side plate.
- Limescale deposits on the side panel and on the fan are harmless and do not detrimentally influence functioning of your appliance.
- The inlet pipe should be cleaned regularly. See chapter 10.3 entitled Descaling.
- Re-insert the side plate. Re-attach the grease filter and the shelves.
- Check that all parts are fitted securely before commencing operation of the appliance.

## 9.3 Cleaning aid

Stubborn soiling can be loosened by means of the cleaning aid and may then be removed more easily.

You should not detach the grease filter. It protects the fan against cleaning agent residues. You can then clean the grease filter and shelves in a dishwasher.

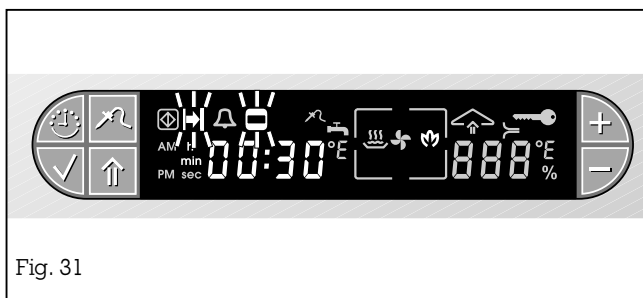
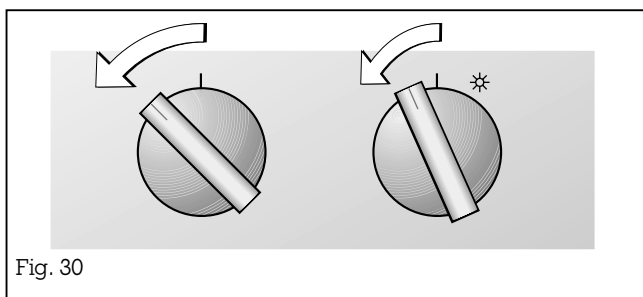

- Allow the appliance to cool down completely before cleaning it.
- Remove the shelves by undoing the knurled nuts. The appliance can be wiped out better later on.
- Spray a household cleaning agent that is suitable for stainless steel onto the cold appliance.  
**Note:** be careful that no cleaner comes in contact with the aluminium panel while cleaning.
- Close the appliance door.
- Leave the agent to act according to manufacturer's instructions.
- Starting in the initial position, turn the two control knobs by one latching position to the left (Fig. 30).
- The ♥ (Cleaning aid) symbol lights up on the display. The ▣ (Duration) and ▢ (Cooking time) flash on the display (Fig. 31).
- The cleaning time of 30 minutes is shown on the display. For heavy soiling you can change the cleaning time to 40, 50 minutes or 1 hour by pressing the + key.
- Press the ✓ (Confirmation) key to start the operation.

**Note:** the light in the oven compartment is off during the cleaning process.

- 
- By pressing the 🕒 (Clock) key you can query the remaining time. An audible signal sounds once the cleaning aid has finished.
  - Press the ✓ (Confirmation) key to switch off the signal. Do not turn the control knobs.
  - Immediately clean the inside of the oven with a soft brush, and wipe with a soft cloth. By pressing the ⬆ (Steaming / condensing) key you can add fresh water to aid cleaning (only when both control knobs remain in the position cleaning aid).  
**Note:** the ⬆ (Steaming / condensing) key must not be pressed when the side plate has been removed. Risk of splashing!
  - Should you leave the door open too long, that the inside of the oven is too dry, repeat the process.
  - To rinse the oven, close the door and heat the oven for some minutes at 100% moisture and 100°C / 210°F.
  - Let the oven cool. You can now dry and polish the inside of the oven and the glass panel with a soft dry cloth.
  - Turn the control knobs back to the starting position. Reattach the grease filter and the shelves. Check that all parts are fitted securely before commencing operation of the appliance.

# 10. Maintenance

---

## 10.1 General

**The appliance must always be disconnected from the mains when being repaired.**

If the appliance does not function correctly, check the fuses and the water supply connection first.

If the power and water supply is functioning correctly, but your appliance still does not work, please contact your Gaggenau dealer who will provide you with the address and telephone number of your nearest manufacturer's authorized service agent or contact **Gaggenau USA on (800) 828-9165**. Specify the appliance type (see rating plate located on the inner side of the door and also included with these instructions).

Repairs may only be carried out by authorised electricians, in order to guarantee the safety of the appliance.

Unauthorised tampering with the appliance will invalidate any warranty claims.

## 10.2 Lamp replacement

For technical reasons the lamp cover cannot be removed. Lamp must only be replaced by Gaggenau after-sales service.

**Important:** do not detach the lamp cover.

## 10.3 Descaling



Fig. 32

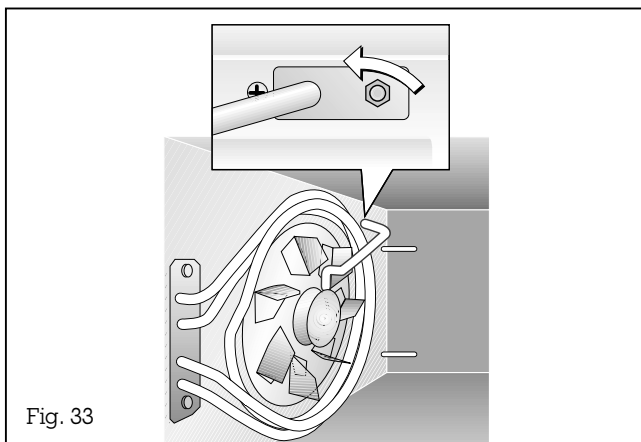

Fig. 33

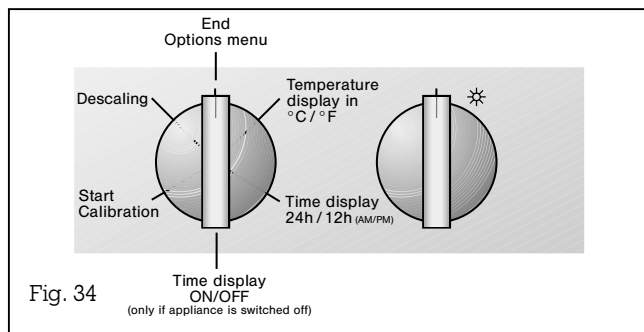



Fig. 34

(only if appliance is switched off)

The water evaporates behind the side plate. Scaling therefore drops out there and is washed into the oven compartment. Scale can be wiped away with a moist cloth.



The **inlet pipe** must be descaled at regular intervals. The oven is equipped with a device which counts the operational hours. Depending on the hardness of the water entered, after a certain number of hours the symbol  (Descal) will constantly blink on the display. This shows that the inlet pipe should be descaled (Fig. 32). This symbol flashes even when the appliance is off.

To **descal the inlet pipe**, proceed as follows:

- Remove the shelf and the side plate on the left. (see Chapter 9.2).
- Dismantle the inlet pipe by first removing the nut (8 mm) and by then pulling the inlet pipe out of the mount (Fig. 33).
- Clean the inlet pipe by soaking it in vinegar essence, citric acid or descaler.
- Reinstall the inlet pipe in the reverse order.  
**Note:** the conical side of the nut must face the appliance side.

After descaling, the descaling display must be turned off manually.

**Proceed as follows:**

- Turn the two control knobs to the topmost position.
- Press the  (Confirmation) key and keep it pressed.
- Turn the “Moisture level” knob to the right.
- Release the  (Confirmation) key.
- Turn the “Moisture level” control knob to the “Descaling” position on the right (Fig. 34).
- Press the  (Confirmation) key.

The  (Descaling) symbol goes off.

### Important!

On assembly, pay attention to a good fit of the inlet pipe. It should be exactly in the middle over the distributor wheel and should not scrape on its edges.



## 10.4 Disassembly of the front window

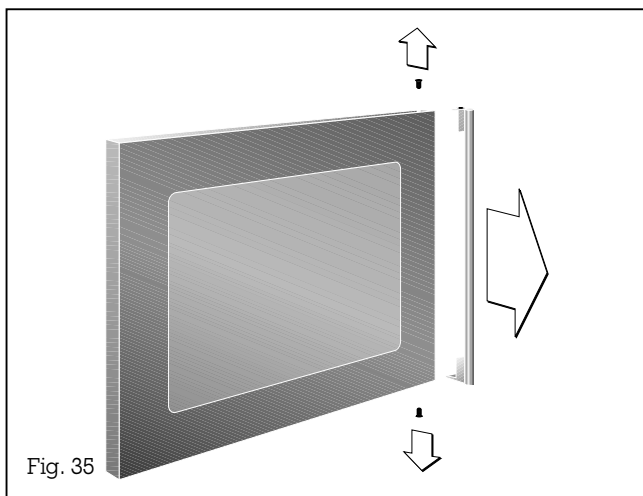

### Proceed as follows:

- Remove the bottom screw from the door handle.
- Remove the top screw from the door handle and detach the door handle.
- Hold the front window with one hand and lightly shake the door to and fro. The glass window can be removed towards you.  
You can now clean the front window.

### Install in the reverse order.



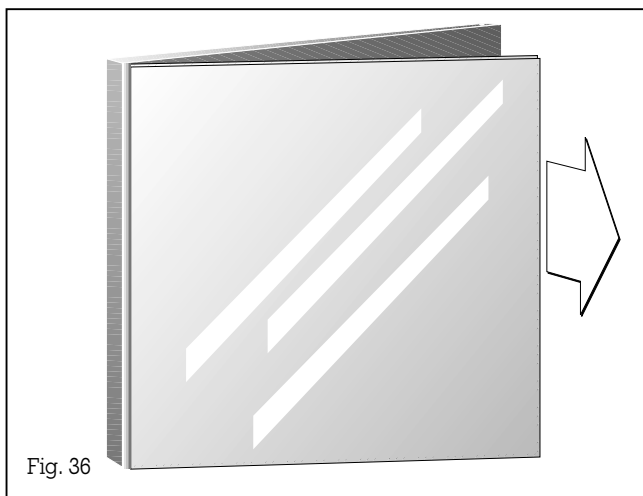

In doing so, make sure that you first insert the window on the hinge side and that you hold it with one hand to stop it from falling out.



## 10.5 Remediating small malfunctions yourself

If you cannot remedy a malfunction yourself with reference to the list below:

- Switch off the steam oven and isolate the appliance from the mains.
- Shut off the water supply.
- Do not open the housing of the appliance.
- Call Gaggenau after-sales service.

What to do if... ?	The cause	The solution!
... The display stays off?	No voltage on the appliance.  The time display has been switched off on the options menu.	Insert the mains plug in the socket. Check the household fuse. Should you wish, switch the time display on using the options menu.
... "R" appears on the display?	Calibration has not been done or has been ended prematurely.	Complete calibration.
... The  (Heating up) symbol does not appear on the display?	Appliance door is not closed.	Close the appliance door.
... The  (Tap) symbol flashes on the display?	No water in the appliance.	Check the water connection.
... Water drips down the door?	Condensation.  Collecting channel on the appliance door is full.	The window always steams up at temperatures up to 100 °C / 210 °F. Condensation is normal with steam. Wipe out the collecting channel.
... Steam escapes from the appliance despite condensation?	Not all the steam can be quenched because the food itself steams as the result of its own heat.	Caution when opening the door! Risk of scalding! Wait until quenching has ended.
... You can hear a humming noise?	The drain pump is emptying the drain tank.	This is normal.
... The  symbol flashes on the display?	The child lock has been activated.	Switch off the child lock (see chapter 5.1).
... The  symbol lights on the display and the appliance does not heat up?	The appliance is set to show room mode without heating function.	Disconnect appliance from power supply for a few seconds (switch off fuse), then within 3 minutes press + key and keep pressed and turn "Temperature" control knob to any temperature (not light!).
... The temperature display does not indicate the set value?	The appliance is still heating up.	Small-scale periodic fluctuations of the cooking compartment temperature are normal.
... The oven lighting goes off?	At low target temperatures, the light is switched off automatically because the lamp additionally heats up the cooking compartment.	The light is activated for a few seconds every time a key or control knob is operated.
... No steam is generated?	The inlet pipe is clogged with scale.	See Chapter entitled "Descaling".
... The water in the cooking compartment does not drain off?	The drain is clogged.	Clean the drain filter and siphon and rinse through the drain.
... The pump repeatedly starts periodically?	The drain pipe is not laid in a gradient.	Refit the drain hose as described in the installation instructions.
... The inside walls are covered in scale?	Water is too hard.	Connect a water softener.
... Steam escapes during boiling point adjustment?	More steam is needed for the boiling point adjustment.	No longer occurs later on during normal operation.
... an error sign appears in the display (e.g. F20, F23, etc.)?	The appliance has recognized an error.	Disconnect the appliance from the mains for about 10 minutes (e.g. by switching off relevant fuse). If after renewed switching on the error is still shown in the display, please call the Gaggenau after-sales service.

# **GAGGENAU**

GAGGENAU HAUSGERÄTE GMBH  
P.O. BOX 10 02 50 · 80076 MÜNCHEN  
GERMANY

☎ (089) 45 90-03  
FAX (089) 45 90-23 47

# **GAGGENAU**

5551 McFADDEN AVENUE  
HUNTINGTON BEACH, CA 92649  
USA

☎ (800) 828-9165 · FAX (714) 901-0979  
[www.gaggenau-usa.com](http://www.gaggenau-usa.com)

## Free Manuals Download Website

<http://myh66.com>

<http://usermanuals.us>

<http://www.somanuals.com>

<http://www.4manuals.cc>

<http://www.manual-lib.com>

<http://www.404manual.com>

<http://www.luxmanual.com>

<http://aubethermostatmanual.com>

Golf course search by state

<http://golfingnear.com>

Email search by domain

<http://emailbydomain.com>

Auto manuals search

<http://auto.somanuals.com>

TV manuals search

<http://tv.somanuals.com>