

EB 270/271

EB 290/291

Preface

1. Important notes	Page 3-4
1.1 For your safety	Page 3
1.2 Operating for the first time	Page 3
1.3 About use	Page 4
2. Structure and operating principle	Page 5-10
2.1 Structure	Page 5
2.2 Accessories / special accessories	Page 6
2.3 Operating principle of the operating modes	Page 7-9
2.4 Special functions	Page 10
3. Operation	Page 11-24
3.1 Overview	Page 11
3.2 Operating the timer	Page 12-16
Time of day	Page 13
Short time	Page 14
Elapsing timer	Page 14
Programming a duration	Page 15
Programming a switch-off time	Page 16
Duration and switch-off time programming	Page 16
3.3 Hot air operation	Page 17
3.4 Top and bottom heat	Page 18
3.5 Hot air and bottom heat	Page 18
3.6 Grilling	Page 19
3.7 Rotary spit	Page 20
3.8 Core temperature sensor	Page 21-22
3.9 Special functions	Page 23-24
Display of the current oven temperature	Page 23
Child lock	Page 23
Holiday safeguard	Page 24
Options menu	Page 24
4. Baking and roasting table	Page 25-28
5. Cleaning and care	Page 29-31
5.1 Manual cleaning	Page 29
5.2 Auto pyrolysis (Self-cleaning)	Page 30-31
6. Maintenance	Page 32-33
6.1 General	Page 32
6.2 Replacing the lamp	Page 32
6.3 Disassembly of the front window	Page 33
7. Tips and tricks	Page 34-36
8. Assembly instructions	Page 37-39
8.1 Technical data	Page 37
8.1.1 Technical data EB 270	Page 37
8.1.2 Technical data EB 290	Page 37
8.2 How to do it	Page 38-39

Preface

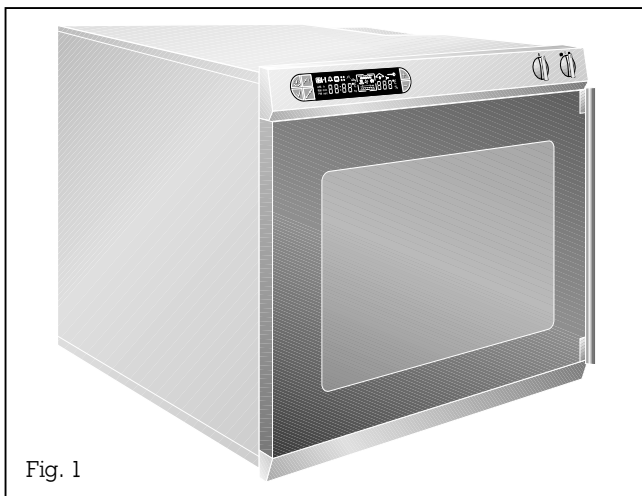

Fig. 1

Baking with your new oven will be even more fun than before.

The appliance offers you the following **advantages:**

- **SuperQuick** feature for particularly fast heating up.
- The appliance features **CleanEmail** and a catalytic cleaning function for air cleaning.
- The **autopyrolysis** function automatically achieves an optimum cleaning result with a reduced energy consumption.

To ensure that you will be able to use this appliance in all its diversity, read through the operating and assembly instructions conscientiously **before operating** it for the first time. The instructions contain **important notes on use, installation and maintenance** of the appliance.

You will find notes on Page 3 that you ought to observe **before operating the appliance for the first time.**

The chapters entitled **"Structure and operating principle"** and **"Operation"** will tell you all the things your oven is capable of doing and how it is operated.

The chapter entitled **"Cleaning and care"** will make sure that your appliance will stay operable and beautiful for a long time.

We have also compiled some **"Tips and tricks"** for you.

And now we wish you lots of fun with your oven.

1. Important notes

1.1 For your safety

You must not operate the appliance if it is damaged.

The appliance must only be connected by an **authorised specialist**, paying attention to the relevant regulations of the power supply companies and the regional construction regulations.

Observe the assembly instructions!

When connecting electrical appliances and devices in the proximity of cooking surfaces and ovens, make sure that **connecting cables** do not become jammed under the hot oven door or come into contact with hot cooking surfaces.

As the user, you yourself are responsible for maintenance and proper use in the household.

Only ever operate the appliance under supervision.

Caution: fire risk! Do not store any combustible items in your oven. During operation, only leave the parts in the cooking compartment that you actually need.

Caution! The appliance and, until the cooling fan is switched on, also the control panel get hot during operation. Keep children away!

Note: to avoid jeopardising the electrical safety of the appliance, **it is forbidden** to use high-pressure or steam jet cleaning devices.

The appliance must be isolated from the mains during all **maintenance**. To this end, remove the mains plug or actuate the corresponding fuse.

Repairs may only be carried out by authorised electricians, in order to guarantee the safety of the appliance.

No **warranty claims** can be lodged for any damage resulting from failure to observe these instructions.

Technical modifications reserved.

1.2 Operating for the first time

Before operating the appliance for the first time, please pay attention to the following notes:

Read through these instructions attentively before operating your appliance for the first time.

The appliance must be installed and connected by a specialist.

Remove the packaging from the appliance and dispose of it properly. Pay attention to the fact that there are accessories in the base of the packaging. Keep **packaging elements** away from children.

Before using the oven for the first time, remove all removable interior parts (gridiron, tray ...). Now operate the oven for one hour at 300 °C in the hot air mode. During this time, pay attention to ensuring that the room is ventilated well, thus removing any newness smells.

Thoroughly clean the appliance and accessories before using them for the first time. (see chapter entitled "Cleaning and care").

After first installation or a power failure, the symbol  (Door lock) flashes in the display. Please do not open the oven door! Then, 08:00 and the time unit symbol flash in the display. You can set the current time by pressing the + and - keys. When you turn one of the control knobs or press a key, the displayed time of day is set as the current time of day.

Before operating the appliance for the first time, make sure that the mains connection is in proper working order.

The rating plate for this appliance is visible when you open the appliance door. An additional rating plate is included on a separate sheet of the instructions. **For guarantee reasons**, store this rating plate in the same location as your operating and assembly instructions.

1.3 About use

The appliance is intended solely for use in the household and must not be put to any other uses.

Use the appliance to prepare meals only. It must not be used to heat up the room in which it is installed.

Caution! You will subject yourself to an accident risk if you close the door improperly. You might jam and crush your fingers and hands.

Do not store any combustible objects in your oven and, when operating the oven, never leave any items inside the oven compartment other than the ones needed.

Make sure that the bottom of the oven compartment is never covered up during operation or lined with aluminium foil.

Never pour water directly into the hot oven. This could damage the enamel.

Always preheat your oven in the mode in which you intend to bake or roast.

Tip: you have a possibility of heating up the appliance very quickly. To do this, use the  hot air and bottom heat program.

The  (Heating) symbol in the control panel goes off as soon as the set temperature has been reached.

Observe caution with oils and fats. They may overheat and burn easily.

Note! Fruit acids such as the juice of lemons or plums etc. should be removed after every baking operation, thus making sure that they will not cause spots on the oven's enamel.

After baking/roasting, open the door completely or close it. The oven door must not be left half open as otherwise the control panel and kitchen furniture may be damaged.

Caution: risk of burns. The inside of the door gets very hot during operation; observe appropriate caution when opening the appliance. Make sure that the open door does not swing back when you are standing in front of the appliance.

Built-in temperature protection prevents overheating of the appliance and of kitchen furniture.

Return the "Temperature" knob to "0" after baking.

If malfunctions should occur, first check the fuses in your household. If there is no fault in the power supply, consult your dealer or the nearest authorised Gaggenau service centre.

All heating elements and the fan are switched off when you open the door.

After completion of baking or roasting, the cooling fan will continue to run for a time and will then switch off automatically.

2. Structure and operating principle

2.1 Structure

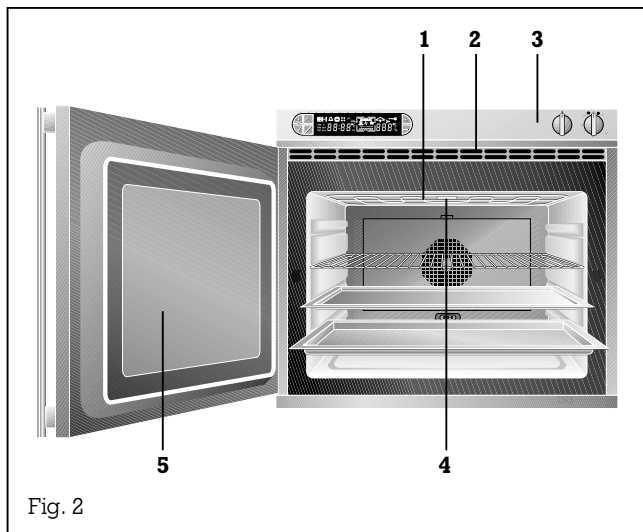

Fig. 2

- 1 Grill and top heating elements
- 2 Ventilation slots
- 3 Control panel
- 4 Oven lighting
- 5 Oven door

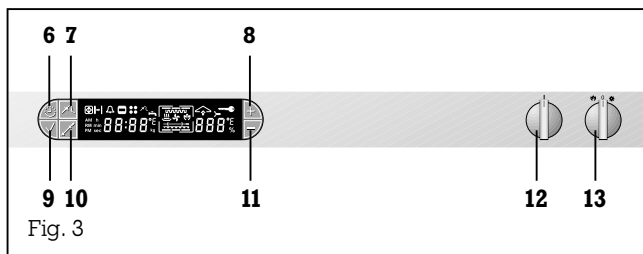

Fig. 3

- 6 "Clock" key
- 7 "Core temperature sensor" key
- 8 "Plus" key
- 9 "Confirmation" key
- 10 "Rotary spit" key
- 11 "Minus" key
- 12 "Mode" knob
- 13 "Temperature" knob

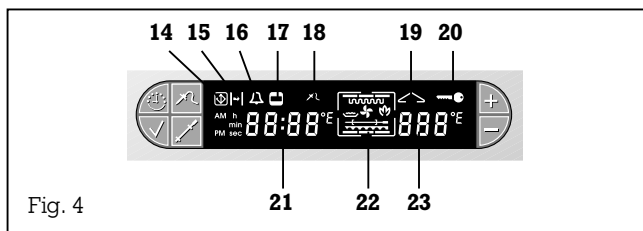

Fig. 4

- 14 "Child lock" symbol
- 15 "Duration, end" symbol
- 16 "Short timer" symbol
- 17 "Cooking time" symbol
- 18 "Core temperature sensor" symbol
- 19 "Heating" symbol
- 20 "Door lock" symbol
- 21 Time display
- 22 Mode display
- 23 Temperature display

2.2 Accessories/special accessories

Fig. 5



Fig. 6



Fig. 7



Fig. 8

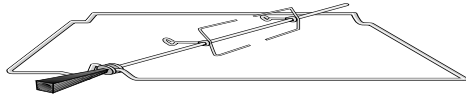

Fig. 9



Fig. 10



Fig. 11



Fig. 12

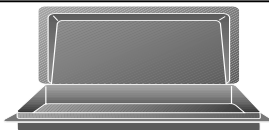

As standard, your appliance comes with the following **accessories**:

- **GR 200-046 (EB 270), GR 200-054 (EB 290):**
Gridiron for cake tins, roasts, grilled pieces and crockery (Fig. 5)
- **KB 200-046 (EB 270), KB 091-054 (EB 290):**
Baking tray for cakes, biscuits and crisp-up items (Fig. 6)
- **GP 200-046 (EB 270), GP 091-054 (EB 290):**
Grilling tray for roasts or as a fat collecting tray (Fig. 7)
- Rotary spit with support frame (Fig. 8)
- Core temperature sensor (Fig. 9)

You can order the following **special accessories**:

- **KB 110-046 (EB 270):**
Glass tray for soufflés and much more (Fig. 10)
- **PS 026-001 (EB 270), PS 027-001 (EB 290):**
Pizza stone (Fig. 11) and wooden pizza spatula
- **BT 026-001 (EB 270):**
Roaster (Fig. 12)
- **HZ 026-001:**
Heating element for roaster and pizza stone, variable up to 300 °C
- **GR 082-046 (EB 270), GR 090-054 (EB 290):**
Gridiron
- **GR 085-046 (EB 270), GR 095-054 (EB 290):**
Gridiron for grilling tray

2.3 Operating principle of the operating modes

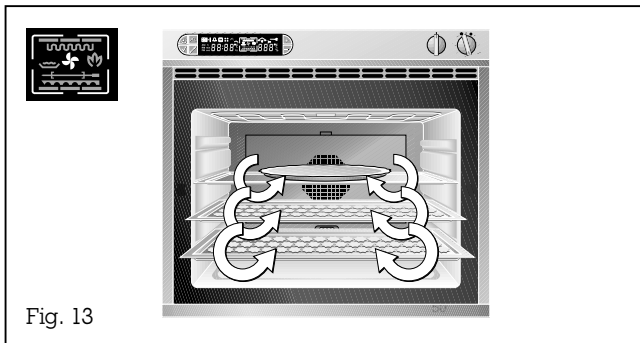

Fig. 13

Hot air

In the hot air mode, all prepared meals are cooked at the same temperature. Diverse or similar meals can be prepared on several levels without any transfer of taste.

You can bake, roast and sterilise with hot air.

Baking with hot air

This is the ideal operating mode for baking several trays and tins at the same time. (Fig. 13)

Roasting with hot air

Meat is evenly browned on all sides. When cooking on the grid, push the grilling tray one level lower to collect dripping fat.

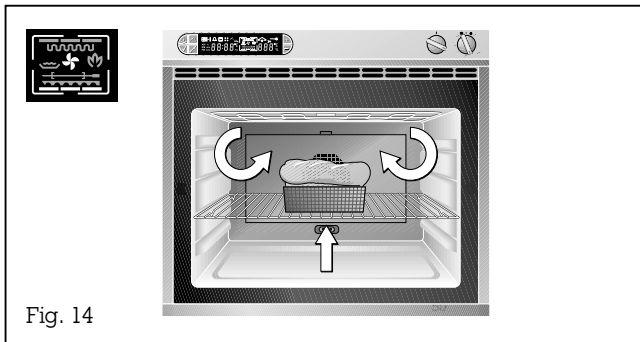

Fig. 14

Hot air and bottom heat

When this function is used, the bottom heating element is additionally in operation.

The fan wheel ensures a uniform distribution of heat. Heat is also generated from below. (Fig. 14)

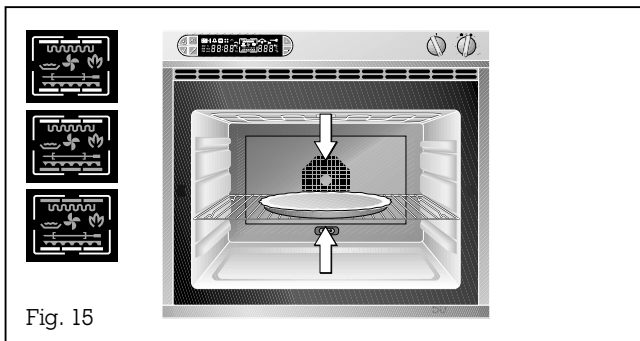

Fig. 15

Top and bottom heat

Two heating elements (top and bottom heat) are operated jointly.

When baking with top and bottom heat, you can only use one level. You get the best baking and roasting results on the second level from below. (Fig. 15)

This unit allows you to select the top and bottom heat elements separately. In these modes of operation you can deliberately choose to bake or roast food from the top or the bottom.

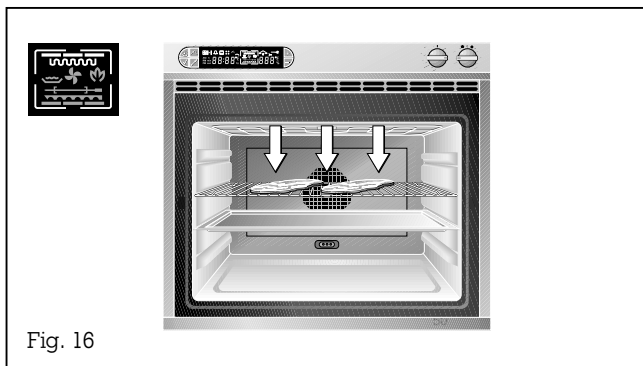

Grilling

When grilling, food is cooked/roasted at a temperature of 150-300 °C from above. A distinction can be made between the following kinds:

Temperature-controlled grilling:

During temperature-controlled grilling, the heating element emits a greater or lesser amount of infrared radiation depending on the setting of the temperature selector switch. (Fig. 16)

This method of grilling is suitable for flat pieces of meat and for browning or gratins.

Do not forget to turn grilled food!

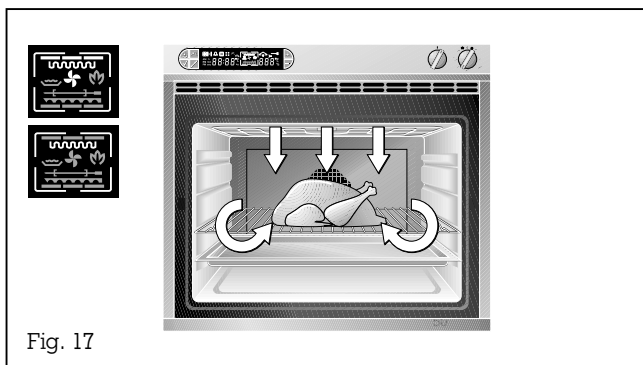

Grilling with the hot air fan

therefore ensures better all-round warming-up, even when the grill is full. There is no need to turn the food frequently. (Fig. 17)

Economy grilling

Only the middle area of the grill heating element is heated.

Do not forget to turn grilled food!

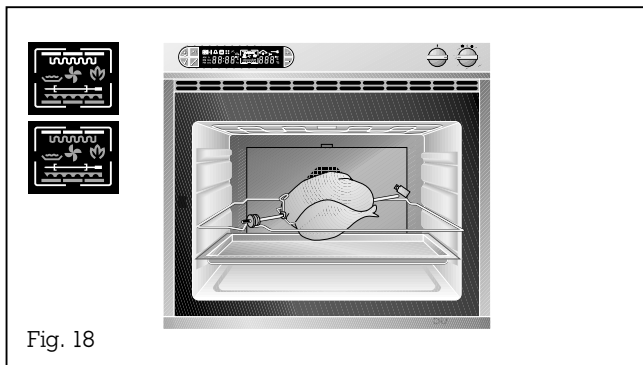

Grilling with the rotary spit produces a crispy crust and even browning all-round. (Fig. 18) Insert the support frame for the rotary spit in the second level from below. Insert the grilling tray one level further down to collect fat.

Please note: the core temperature sensor cannot be used in combination with the rotary spit. The rotary spit will not function if the core temperature sensor is plugged in the socket in the oven.

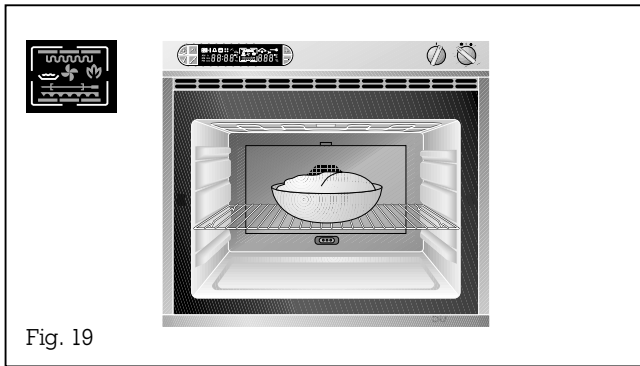

Fig. 19

Fermenting

When using the fermenting function, you can raise dough at 38 °C or you can thaw frozen food swiftly and gently. (Fig. 19)

The light is off in this mode of operation because it would otherwise additionally heat up the oven compartment. You can switch on the lighting for a few seconds by pressing any key.



Fig. 20

Baking stone operation (with special accessories PS 026/027 and HZ 026 only)

Be it crispy pizza or fresh bread - with the baking stone you produce baking results that are comparable to those of a solid stone oven (Fig. 20).



Fig. 21

Roaster operation (with special accessories BT 026 and HZ 026 only)

Using the cast roaster you can brown and gently roast large quantities of meat, or you can prepare a Christmas turkey or a large oven-baked dish (Fig. 21).

2.4 Special functions

Display of the current oven temperature (Thermostest)

The current oven temperature is displayed for a few seconds.

Note: when the oven is operated continuously, temperature fluctuations of up to 5 °C, which are inherent to the system, may occur.

Note: during the pyrolysis process, it is not possible to display the current oven temperature.

Power failure safeguard

When the oven is on, the heating process is interrupted when the power returns after a failure.

Note: the appliance bridges a power failure lasting 5 minutes without any consequences.

Holiday safeguard

Every oven heating process is cancelled after 12 hours if the oven has not been operated during this time. This function is not active if the timer has been programmed.

Child lock

The child lock prevents inadvertent activation of the oven.

Auto pyrolysis (cleaning)

In the cleaning mode, the oven is heated up to a temperature of 485 °C. At this high temperature, even the most stubborn of soiling is burnt away.

ECO operation

When you use the power-saving ECO mode, the light is switched off during the cooking process. If a cooking time has been programmed, the oven also switches off the heating element before expiry of the programmed time to make use of the residual heat. You can switch the ECO mode on and off in the options menu.

3. Operation

3.1 Overview

Inserting the baking tray

- Insert the baking tray at the same height on both sides.
- Make sure that the notch on the baking tray is at the rear or that the handle is at the front.

Switching on

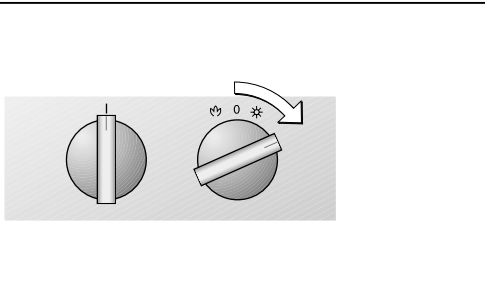

Fig. 22

Switching off

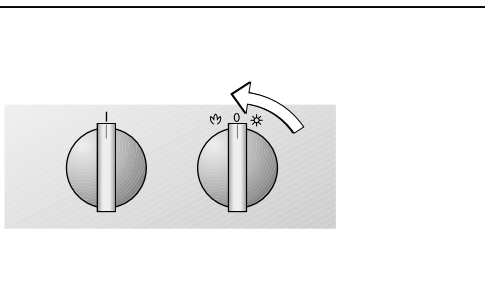

Fig. 23

"Temperature" knob:

The temperature can be set within the range from 50-300 °C in 5 ° steps.

"Mode" knob:

You can choose from 12 programs:

- Hot air
- Grilling with hot air
- Grill
- Economy grill
- Hot air with bottom heat
- Bottom heat
- Top and bottom heat
- Top heat
- Pizza function (with special accessory pizza stone PS 026/027 and heating element HZ 026)
- Roaster function (with special accessory roaster BT 026 and heating element HZ 026)
- Fermenting
- Auto pyrolysis (self-cleaning)

Switching on (Fig. 22)

- Turn the "Temperature" control knob by one latching position to the right. The lighting goes on and the symbol assigned to the set mode lights up in the display.
- Turn the "Modes" control knob until the temperature you require is displayed.
- Turn the "Temperature" knob to the temperature you require. The set temperature is shown on the display for a few seconds.
- While the oven is in operation, you can display the current oven temperature for a few seconds by pressing the key ✓ (Confirmation).

Switching off (Fig. 23)

- To switch off, turn the "Temperature" control knob to the 0 position. The lighting goes off.

3.2 Operating the timer

The required mode and temperature can be set before and after time programming by turning the "Temperature" or "Mode" knob.

As long as one or several symbol(s) in the display flash(es), no input is possible and no value is programmed or an invalid value has been programmed.

All time values are entered by means of the 🕒 (timer), +, - and ✓ (confirmation) keys. Every input triggers an audible and a visible signal.

If you select a program (e.g. end), but you do not enter a value, the current time will appear on the display after 20 seconds.

An entered value (e.g. duration programming) must be confirmed within 20 seconds ✓ ("Confirm" key). Entered values are not stored if they are not confirmed.

Press the ✓ (Confirm) key if you wish to confirm a value during programming. If you press any other key instead, the entered value will **not** be stored and will disappear.

You can query set values by pressing the 🕒 (timer) key. The value appears on the display for around 10 seconds. During this time, you can modify the value by pressing the + or - key and you can confirm it by pressing the ✓ (Confirm) key.

Press the + and - keys at the same time if you wish **to clear a value**.

If you have already programmed a time value once (e.g. a duration) on the appliance, this previously programmed value will be proposed to you when programming a value again.

The longer you press the + or - key when programming a time, the faster the time elapses on the display.

After completion of time programming, the corresponding symbol flashes on the display. For example, if you have programmed an end time, the 🕒 (end time) symbol will flash. An audible signal is also sounded. Heating is deactivated and the oven lighting goes off. You can restart the previously selected mode by pressing any key on the display. You end the baking process by turning the "Temperature" knob to 0.

Switching from the automatic mode to the "normal mode":

Turn the temperature control knob back to 0. The oven will then no longer heat. The previously programmed time value is retained. An audible signal sounds after the entered time has elapsed.

Note: If the time is not displayed exactly on the timer, this is not due to a technical defect. The mains frequency of the public power supply is the time base for the timers. In Europe, this is a standard frequency of 50 Hz (Hertz). As far as this point is concerned, power supply networks that are fed from power stations in eastern Europe fluctuate. This is why an incorrect time may be displayed. This discrepancy has **no influence** on the functions and program sequences of the appliance.

Every **alarm** goes off after 3 minutes.

Note: all time programming functions can be programmed simultaneously.

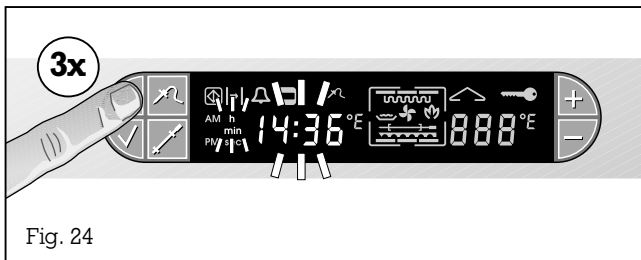

Setting the time of day

Proceed as follows:

- Press the 🕒 (Timer) key 3 times. The ^hmin (Time unit) symbol flashes on the display. The time display shows the currently set time of day (Fig. 24).
- You can select the required time by pressing the + or - key.
- Press the ✓ (Confirmation) key to confirm the entered value. An audible signal is sounded.

Note: After first installation or a power failure, the symbol 🔑 (Door lock) flashes in the display. Please do not open the oven door! Then, 08:00 and the time unit symbol flash in the display. You can set the current time by pressing the + and - keys. When you turn one of the control knobs or press a key, the displayed time of day is set as the current time of day.



Fig. 25

The last programmed value is proposed to you every other time you program a short time.

Short time

You can program a period of time with the short time function without automatic activation or deactivation. You can use this mode of operation even when the appliance is switched off as an egg timer, for example. The range that can be set is between ten seconds (00:10) and 23.59 hours (23:59)

Proceed as follows:

- Press the + key. The short time symbol Δ flashes (Fig. 25).
- The entered value appears on the display, which you can modify by pressing the + or - key. The time unit symbol $\frac{\text{min}}{\text{sec}}$ lights up.
- Press the \checkmark (Confirm) key to confirm the entered value.
- The elapsing time is displayed.

Note: if nothing is entered for 5 seconds, the short time starts even if the \checkmark key (Confirm) is not pressed.

Once the short time has elapsed, an audible signal sounds and the Δ (Short time) symbol flashes on the display. The signal goes off when you press any key. The short time reminder can be switched off at any time by pressing the + and - minus keys at the same time.

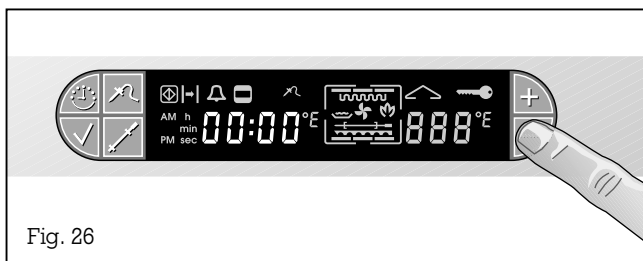
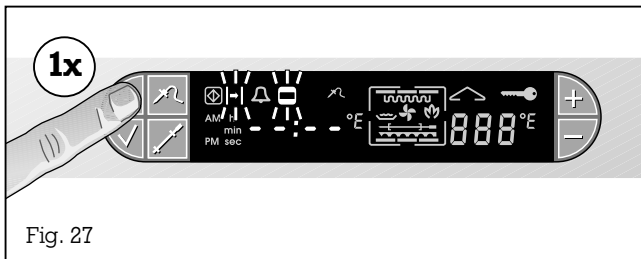

Fig. 26

Elapsing timer

Proceed as follows:

- Press the - key while the appliance is on (Fig. 26).
- The time, beginning at 00:00, is displayed (maximum display: value 12 hours). Thus, you can continuously display the elapsed cooking time without programming automatic deactivation. When you press the - key again, the time is switched off.



Programming a duration

The appliance is operated for a specific period of time. The range that can be set is between one minute (00:01) and 23 hours and 59 minutes (23:59).

Proceed as follows:

- Press the ⌚ (Timer) key once. The ⏱ (Duration) symbol and the ◻ (Cooking time) symbol flash on the display. Dashes appear on the display (i.e. no value programmed) (Fig. 27).
- Press the + or the - key to set the required duration.
- Press the ✓ (Confirm) key to confirm the set value. An audible signal is sounded. The ◻ (Cooking time) symbol lights up on the display.

Note:

- A signal is sounded after the programmed duration has elapsed. At the same time, the oven switches off automatically.
- Press any key to switch off the signal.
- The programmed duration can only be queried by pressing the ⌚ (Timer) key.

Clearing incorrectly programmed values:

- Press the ⌚ (Timer) key once.
- Press the + and - keys at the same time. An audible signal is sounded.

The end time is display automatically if you press the ⌚ (Timer) key twice.

Every other time you program a duration, the value programmed last is proposed to you when you press the + key.

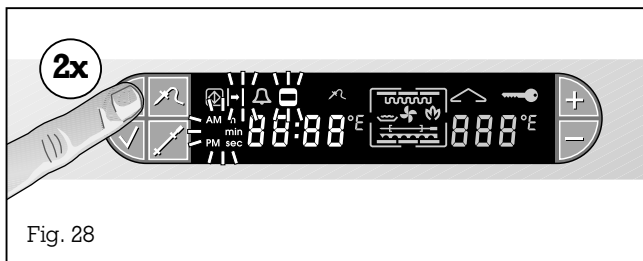

Fig. 28

Note: the time of day that is set on the appliance is the starting point for programming the switch-off time.

You can query the entered value by pressing the ☹️ (Timer) key twice

Programming a switch-off time

The appliance switches off automatically at a time that you have chosen. The starting point is the time of day set on the appliance.

Proceed as follows:

- Press the ☹️ (Timer) key twice. The + (End) and ☐ (Cooking time) symbols flash.
- Press the + or - key to set the required time. You can choose any switch-off time within a period of 24 hours.
- Press the ✓ (Confirm) key to confirm the entered value. An audible signal is sounded. The ☐ (Cooking time) symbol lights up on the display.

After the set time has elapsed, the ☐ (Cooking time) symbol flashes and an audible signal is sounded.

By pressing any key, you can switch off the signal and heating will start again. Turn the temperature selector switch to 0 to end the operation.

Programming a duration and an off time

This mode enables you to start and end baking and cooking in your absence.

Proceed as follows:

- Enter a required duration (see Page 15)
- Press the ✓ (Confirmation) key
- Enter the required switch-off time (see above)
- Press the ✓ (Confirmation) key

The automatic mode becomes active as soon as the switch-off time is programmed and you have pressed the ✓ (Confirm) key.

3.3 Hot air operation

Switching on

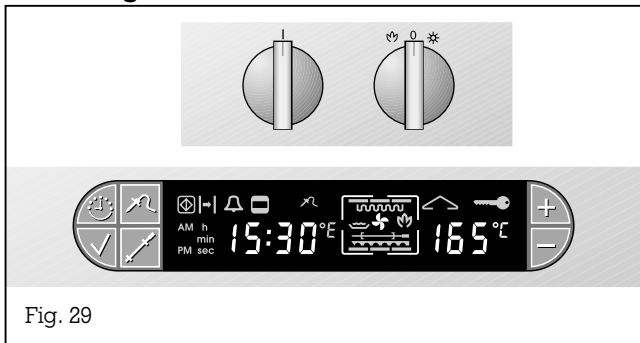



Fig. 29

Turn the "Temperature" control knob to the temperature you require. Turn the "Modes" control knob until the  (Hot air) symbol appears on the display (Fig. 29).

You can bake, roast, and sterilise with hot air.

When roasting on the gridiron, insert the grilling tray/glass tray one level lower than the food you are cooking to collect dripping fat.

Switching off

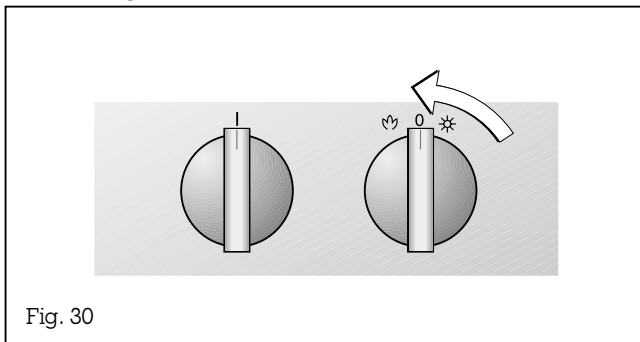

Fig. 30

Turn the temperature selector switch to the 0 position. The oven lighting goes off and the hot air fan switches off. (Fig. 30)

Sterilising

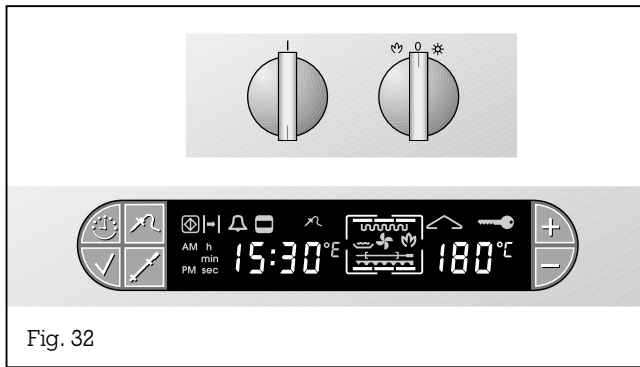

Fig. 31

When placing bottles (no more than 6) containing fruit or vegetables in the grill pan / glass tray filled with water, make sure that they do not touch each other. (Fig. 31) Heat them at 175 °C until the liquid in the glasses begins to bubble, then

- Sterilise vegetables at 80-100°C for app. 30-60 minutes
- After the onset of bubbling, switch off the oven to sterilise fruit for app. 5-15 minutes.

3.4 Top and / or bottom heat



Switching on:

Turn the "Temperature" control knob to the temperature you require. Turn the "Modes" control knob until the ☀ (top and bottom heat) symbol appears on the display (Fig. 32).

Switching off:

Turn the "Temperature" knob to the 0 position. The oven lighting goes off.

Please observe the following notes:

Baking with top and bottom heat

In this mode of operation, you can only bake on one level, in the way to which you are accustomed.

Roasting with top and bottom heat

Place the meat on the gridiron or in the grilling tray/glass tray. When roasting on the gridiron, insert the grilling tray/glass tray one level lower than the food you are cooking to collect dripping fat. You also have a possibility of choosing top and bottom heat separately. With these modes of operation, you can brown your baked or roasted food from above or below.

3.5 Hot air and bottom heat

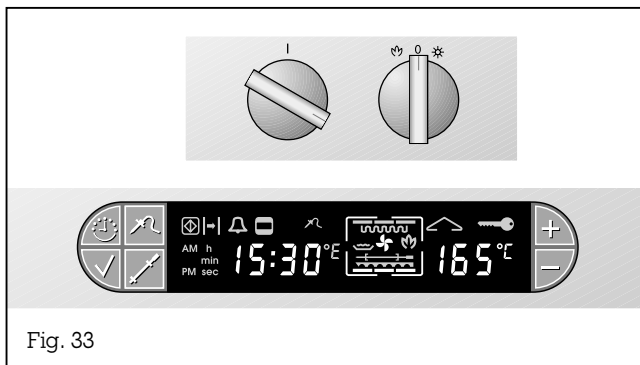

Switching on

Turn the "Temperature" control knob to the temperature you require. Turn the "Modes" control knob until the ☀ (Hot air and bottom heat) symbol appears on the display (Fig. 33).

Switching off:

Turn the "Temperature" knob to the 0 position. The oven lighting goes off.

3.6 Grilling

Temperature-controlled grilling

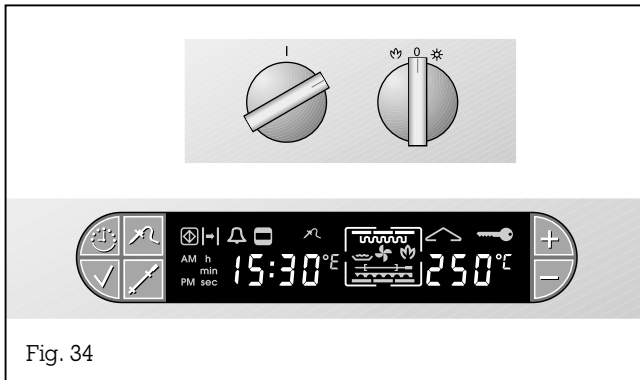

Fig. 34

Grilling with the hot air fan

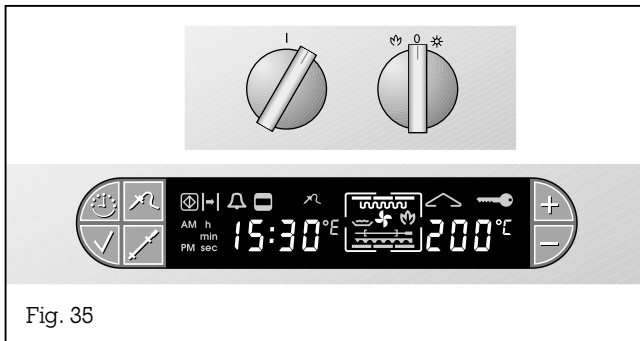



Fig. 35

Caution!

Very high temperatures occur during grilling, and these also warm up doors and frames. Observe the appropriate caution and keep children away!

Temperature-controlled grilling

Switching on:

Turn the "Temperature" control knob to the temperature you require. Turn the "Modes" control knob until the  (grill) symbol appears on the display (Fig. 34).

Switching off:

Turn the "Temperature" control knob to the 0 position.

Note:

When grilling, insert the grilling tray/glass tray one level lower than the food you are cooking to collect dripping fat.

Grilling with the hot air fan

Switching on:

Turn the "Temperature" control knob to the temperature you require. Turn the "Modes" control knob until the  (Grilling with hot air) symbol appears on the display (Fig. 35).

Switching off:

See above.

Economy grilling

Switching on:

Turn the "Temperature" control knob to the temperature you require. Turn the "Modes" control knob until the  (Economy grilling) symbol appears on the display. The "Temperature" control knob can be turned to any temperature.

Switching off:

See above.

3.7 Rotary spit

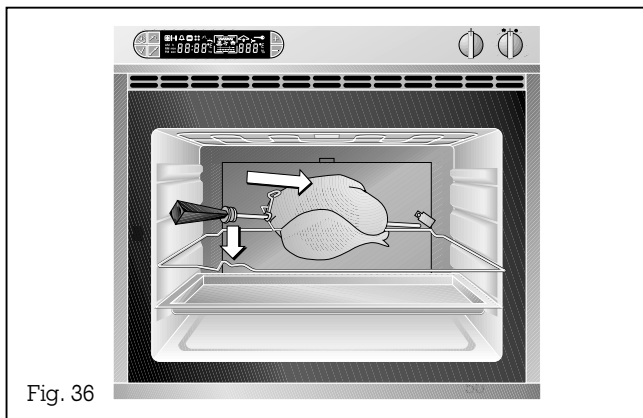

Fig. 36

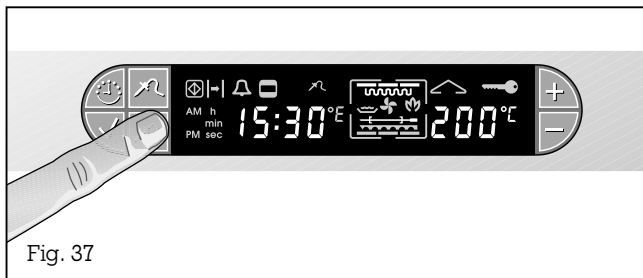





Fig. 37

Grilling with the rotary spit produces a crispy crust and even browning all-round. You can use the rotary spit in all modes except the pizza and the roaster functions. You get the best results in the **grill or top heat modes**, however.

Proceed as follows:

- Insert the support frame for the rotary spit in the second level from below. Insert the grilling tray one level lower down to collect dripping fat.
- Turn the "Temperature" control knob to the temperature you require. Turn the "Modes" control knob until the  symbol (Grill) or the  symbol (Top heat) appears on the display. Preheat the oven.
- Place the food you want to prepare on the rotary spit and secure it with the two retaining clips. Secure protruding parts (e.g. wings) to make sure they do not touch the grill heating elements.
- Fit the rotary spit in the rotary spit drive (Fig. 36). Unscrew the handle from the rotary spit and close the oven door.
- Press the key  (Rotary spit) (Fig. 37).

Note:

The core temperature sensor cannot be used in combination with the rotary spit. The rotary spit will not function if the core temperature sensor is plugged in the socket in the oven.

3.8 Core temperature sensor

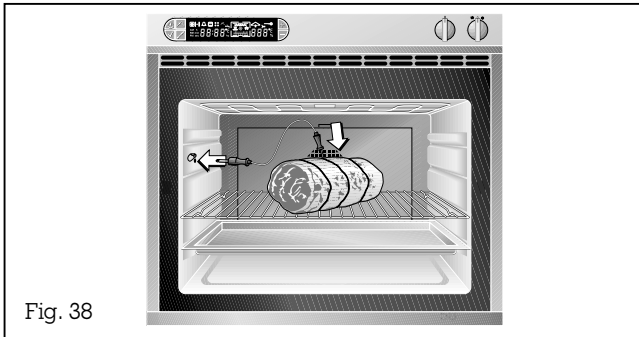

Fig. 38



Fig. 39



Fig. 40

Note:

You cannot set a temperature on the core temperature sensor that is lower than the core temperature of the food you are preparing.

If you set programming with the core temperature sensor and the timer at the same time, the programming that reaches the entered value first will switch off the oven.

Using the core temperature sensor, during the cooking process you can measure the core temperature of the food you are preparing exactly between 1 °C and 99 °C. The sensor measures the temperature in the interior of the meat. It indicates when the set core temperature has been reached and the meat has been cooked to satisfaction.

The core temperature sensor

- enables exact cooking to the spot.
- prevents overcooking of roasts.
- provides you with a display of the actual temperature for total control of the cooking process.

Proceed as follows:

- Preheat the oven.
- Insert the cooking insert with the food.
- Insert the core temperature sensor in the front left socket in the oven (Fig. 38).

Caution: the side panels are hot. Use a glove.

- Insert the tip of the core temperature sensor in the middle of the food, at its thickest point; not in the middle in the case of poultry (hollow), but between the belly and the thigh.
The measuring tip must not touch any bones and should not be inserted into fatty tissue.
- Close the oven door.
- Press the ^ (Core temperature sensor) key twice. The ^ (Core temperature sensor) symbol flashes and the suggested value of 60°C can be seen on the display (Fig. 39).
- You can enter a value between 1 °C and 99 °C (see table) by pressing the + and - keys (Fig. 40).

– Press the ✓ (Confirmation) key to confirm the entered value. An audible signal is sounded.

An audible signal sounds as soon as the programmed core temperature has been reached. The oven switches off automatically. The ^ (Core temperature sensor) and -| (End) symbols flash on the display.

Caution: Pull out the core temperature sensor before removing the food. Use a glove to do this because the core temperature sensor gets very hot during operation.

Note:

When you press the ^ (Core temperature sensor) key **once**, the temperature on the core temperature sensor is displayed to you for a few seconds.

Clearing the core temperature:

– Press the ^ (Core temperature sensor) key **twice**. The ^ (Core temperature sensor) symbol flashes on the display.

– Press the + and - keys at the same time.

– An audible signal sounds and the ^ (Core temperature sensor) symbol goes off.

To clean it, simply rub the core temperature sensor with a moist cloth.

Note:

Remove the core temperature sensor from the oven when it is not in use.

Never use the core temperature sensor and the rotary spit at the same time. The rotary spit function is locked when the core temperature sensor is plugged in the socket.

Only ever use the included original temperature sensor. You can order the core temperature sensor as a spare part (Order No. 156838)

Recommended core temperature values

Beef

Roast beef / fillet of beef		
	rare	45-50 °C
	medium-rare	55-65 °C
	well-done	70-80 °C

Beef roast		80-85 °C
Boiled fillet of beef		90 °C

Pork

Roast pork		80-85 °C
Back of pork		65-70 °C
Meat loaf		85 °C

Veal

Roast veal		75-80 °C
Breast of veal, stuffed		75-80 °C
Back of veal	medium-rare	65-70 °C

Venison

Leg of venison		75-80 °C
Back of hare / venison		65-70 °C

Poultry

Chicken		85 °C
Goose		85-90 °C
Turkey, duck		80-85 °C
Duck breast		70 °C

Lamb

Leg of lamb	medium-rare	55-65 °C
Lamb	well-done	75-80 °C

Mutton

Leg of mutton	medium-rare	75-80 °C
Back of lamb	well-done	80 °C

Bread

90 °C

3.9 Special functions

Display of the current oven temperature (Thermostest)

The current oven temperature will appear on the display for a few seconds when you press the ✓ (confirmation) key.

Note: during the pyrolysis process, it is not possible to display the current oven temperature.

Child lock

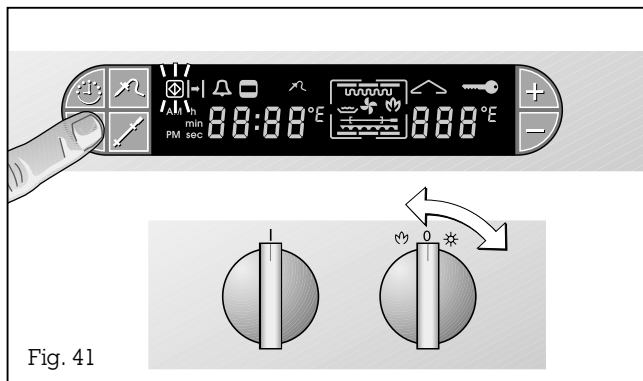

The child lock prevents inadvertent activation of the oven.

Proceed as follows:

Switching on:

- **Turn** the “Temperature” control knob to any position on the right.
- **Press** the ✓ (Confirm) key and keep it pressed.
- **Turn** the “Temperature” control knob to the 0 position (Fig. 41).

The ☼ (Child lock) symbol on the display flashes.

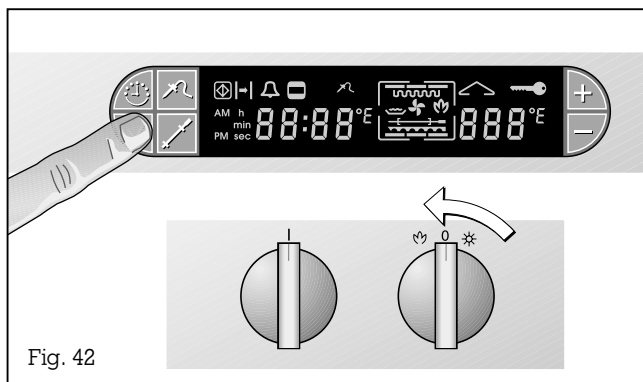

Switching off:

- **Press** the ✓ (Confirm) key and keep it pressed.
- **Turn** the “Temperature” control knob to any position on the right.
- **Release** the ✓ (Confirmation) key.
- **Turn** the “Temperature” control knob to the 0 position (Fig. 42).

The ☼ (Child lock) symbol on the display goes off.

Holiday safeguard

For your protection, the oven features holiday safeguard. Every heating operation is switched off after 12 hours if the appliance is not operated during this time. Flashing dashes appear on the display.

Turn the two control knobs to 0. You can then operate the appliance in the way to which you are accustomed.

Options menu

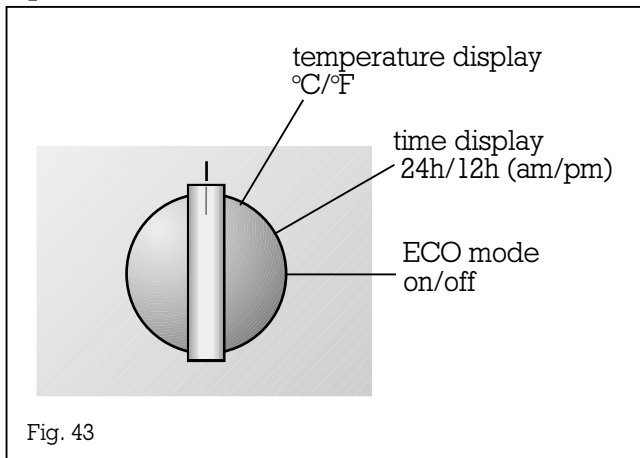

Fig. 43

- With the aid of the **Options menu**, you can
- choose between °C and °F on the temperature display.
 - choose between 12h and 24h (am/pm) on the time display.
 - switch the ECO mode (power-saving mode) on or off. When you use the power-saving ECO mode, the light is switched off during the cooking process. When a duration is programmed, the oven also switches off the heating element before the cooking time has elapsed, thus exploiting the residual heat.

Proceed as follows:

- Turn the two control knobs to the topmost position.
- Press the √ (Confirmation) key and keep it pressed.
- Turn the "Modes" knob to the right.
- Release the √ (Confirmation) key.
- By turning the "Modes" control knob, you can now choose the various functions (Fig. 43):
 - Position 1: temperature display either in °C or °F
 - Position 2: time display in 24 hours or 12 hours (am and pm)
 - Position 3: ECO mode on or off
- Set the required option by pressing the + or - key.
- Press the √ (Confirmation) key.
- To quit the options menu, turn the "Modes" control knob back up or turn the "Temperature" control knob.

4. Baking table

Cakes and biscuits	Hot air		Hot air and bottom heat		Top and bottom heat		Baking time
	Level*	Temp. °C	Level*	Temp. °C	Level*	Temp. °C	min.
Swiss roll					2	210	7-9
Flan base					2	175	30-35
Fruit flan on yeast dough	2	165			2	175	40-45
Fruit flan on short-crust pastry	2	165	2	165	2	175	40-45
Small flaky pastry cakes**	1+3 / 2	180			2	190	15-20
Cheesecake (high)	2	165	2	165	2	165-175	90-100
Cheesecake slices (flat)	2	165	2	165	2	165-175	45-50
Cake mix (round)	2	160-175			2	175-180	50-60
Loaf cake	2	160-175			2	175-180	50-60
Yeast dough ring cake (tall)	1	160-175			1	175	40-50
Biscuits**	1+3 / 2	160-175			2	175	15-20
'Hefezopf'	2	165			2	165-175	30-40
Cake baked on a tray (dry coating)	2	165-170			2	175	40-50
Cake baked on a tray (moist coating)			2	170	2	175	40-50
Cream puffs	1+3 / 2	180			2	190	20-25
Mixed-grain bread***	2	200/170			2	210/170	40-50

* Level from below

** In the hot air mode, you can bake simultaneously on several levels.

*** Preheat the appliance to the specified temperature. Switch back to the second temperature when inserting the food.

Note: the values given above must be looked upon as recommended values. You are advised to always preheat the oven. The recommended mode is printed in bold.

Roasting table

Dish	Level from below	Hot air Temp. °C	Grill and hot air Temp. °C	Top and bottom heat Temp. °C	Cooking time minutes	Core temperature sensor
Beef						
Roast beef (casserole*) 1,5 kg	2	180		180	60-90	
Roast beef rare 1,5 kg**	2	230/180	230/180		45-50	45-50 °C
Roast beef medium 1,5 kg**	2	230/180	230/180		60-70	55-65 °C
Roast beef well-done 1,5 kg**	2	230/180			90-100	70-80 °C
Pork						
Pork roast 1,5 kg**	2	230/180	230/180		60-70	75-80 °C
Pork roast with rind 1,5 kg***	2	180/200	180/200		60-70	75-80 °C
Smoked pork 1,5 kg**	2	180/160			40-50	
Leg of pork***	2	150/200	150/200		50-60	
Collared roast**	2	230/180	230/180		60-70	75-80 °C
Veal						
Roast veal**	2	230/180		230/180	60-70	75-80 °C
Leg of veal***	2	150/180	150/180		50-60	75 °C
Loin of veal	2	160-170			20	70-75 °C
Stuffed breast of veal*	2	120-130			120	

* First brown the meat all-round in the casserole on the cooker.

** Brown the meat at a high heat level, switching back to a lower temperature after 15-20 minutes.

*** Cook the meat at a low temperature and set the temperature higher during the last 15-20 minutes.

Note: the values given above must be looked upon as recommended values. You are advised to always preheat the oven. The recommended mode is printed in bold.

Roasting table

Dish	Level from below	Hot air Temp. °C	Grill and hot air Temp. °C	Top and bottom heat Temp. °C	Cooking time minutes	Core temperature sensor
Venison						
Roast boar (casserole*)		170-180			60-90	
Leg of venison (casserole*)		170-180			60-80	
Saddle of venison	2	165-175		170-180	20-25	
Leg of lamb (casserole*)		180-200			35-45	65-75°C
Poultry						
Duck 2-3 kg**	2	160/190		160/190	100-120	90°C
Duck breast	2	160		160	15-20	90°C
Goose 2-3 kg**	2	160/190		160/190	100-120	90°C
Turkey 3-4 kg**	2	160/190		160/190	120-180	90°C
Roast chicken	2	180	180		50-60	90°C

* First brown the meat all-round in the casserole on the cooker.

** Cook the meat at a low temperature and set the temperature higher during the last 15-20 minutes.

Note: the values given above must be looked upon as recommended values. You are advised to always preheat the oven.
The recommended mode is printed in bold.

Grilling table

Dish	Level*	Pre-heat	Temp. °C	Grill minutes		Grill and hot air minutes		Total cooking time [min]
				1. side	2. side	1. side	2. side	
Sliced pork belly	3	X	180-200	6	4	5	5	
Kebab	3	X	190			8	8	
Fried sausage	3	X	200	5	4			
Merguez (grilled sausage)	3	X	200			6	6	
Roast chicken**	2		180			30	30	
Leg of chicken	3	X		20	20	15	15	
Spare ribs	3	X	180-200	15	15	12	12	
Leg of pork***	2	X	150/200					50-60
Trout	3	X	180-200	8	8			
Vegetable kebabs	3	X	200	7	7			
Shrimp kebab	3	X	175	7	7			
Preparing au gratin								
Toasted sandwich	3	X	190					5-7
Crème caramel****	4		250					
Crème brûlée****	4		250					
Cake with meringue****	3	X	200					

Important: only ever grill with the oven door closed.

You are advised to place the grilling tray in the lowest level to collect dripping fat.

* Level from below

** In the case of appliances featuring a rotary spit, you are advised to use the spit in the grill mode.

*** Do not turn the leg of pork. Set the temperature high for the last 15-20 minutes.

**** You must bake this dish au gratin until it has reached the level of browning you require.

Note: the values given above must be looked upon as recommended values. You are advised to always preheat the oven. The recommended mode is printed in bold.

5. Cleaning and care

5.1 Manual cleaning

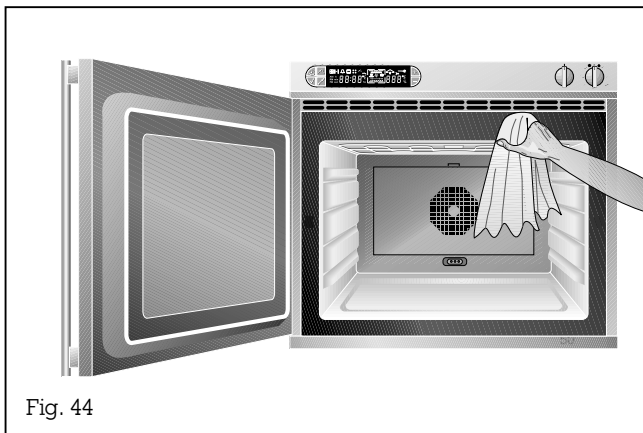

Fig. 44

Thoroughly clean the appliance before operating it for the first time and after every use, thus avoiding baking in of residues. After residues have baked in several times, they are then difficult to remove.

Commercially available oven sprays must not be used to clean the oven.

The outer surfaces must only be cleaned using a soft cloth. Please do not use any commercially available stainless steel cleaners as these may be aggressive to the coating (especially the door of the appliance).

Clean control panel areas, glass surfaces operator controls with a moist cloth and gentle rinsing detergent and wipe them dry with a soft dry cloth. Do not use any abrasive or nitro polishing agents for cleaning!

Do not use any abrasive sponges either. Use commercially available window cleaner and apply it to a soft, moist cloth. Do not spray it onto the switch panel.

If possible, only clean accessories (baking tray, gridiron and grill pan) with hot water or detergent.

Do not scrape off baked in food remainders. Soften them with a moist cloth and detergent instead.

Cleaning (Baking stone)

Remove coarse soiling from the baking stone. Turn the baking stone round before using it again. This will ensure self-cleaning. Dough residues can then be removed using a soft brush.

Note

Do not clean the baking stone with water and detergents.

Note:

To avoid jeopardising the electrical safety of the appliance, it is forbidden to use high-pressure or steam jet cleaning devices – risk of short circuits!

5.2 Auto pyrolysis (Self-cleaning)

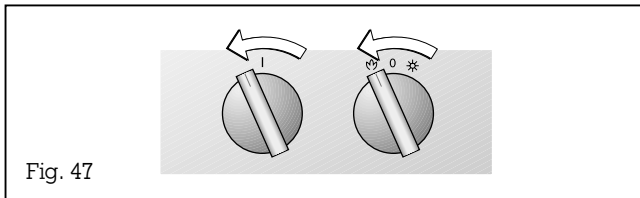
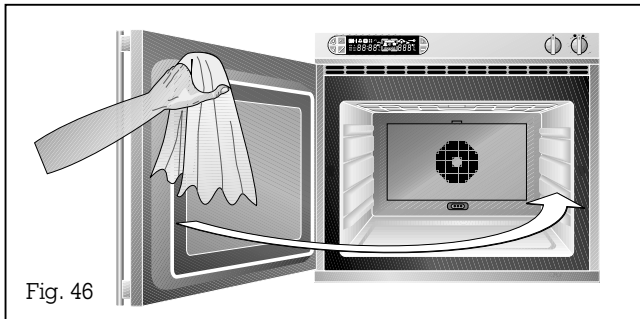
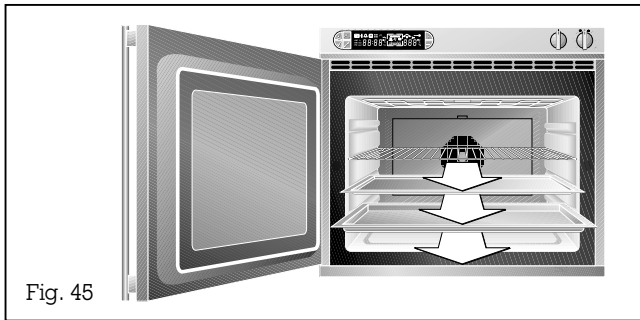

Caution!

Very high temperatures occur during the pyrolytic self-cleaning process.

Observe the appropriate caution and keep children away.

Gaggenau baking trays and grilling trays are coated with pyrolysis-proof enamel. To arrive at an optimum cleaning result, you are nevertheless advised to remove all accessories from the oven before the pyrolytic cleaning process. Only this will ensure optimum heat distribution.

If you would like to remove burnt-in residues from your baking tray or your grilling tray, it is imperative that you observe the following

safety notes:

- Remove extreme fatty soiling, roast juice and food remainders before the pyrolytic cleaning process. These can cause a fire risk!
- Only ever insert one baking tray or one grill tray in the lowest shelf in the oven.
- Insert the baking tray or your grill tray fully.
- The gridiron, the rotary spit or the baking stone must not be cleaned pyrolytically.

Before you start auto pyrolytic cleaning

- Remove extreme soiling from the oven.
- Manually clean the door seals, the inside of the door and the glass pane because the pyrolytic cleaning process does not clean these parts.

Important!

Check that the oven door is firmly closed on the oven.

Proceed as follows Switching On

- Remove all loose interior parts (e.g. gridiron or core temperature sensor) from the oven compartment. **There must be no objects left in the oven compartment!**
- Close the oven door.
- Turn the "Temperature" and "Mode" control knobs by one latching position to the left.

– Press the ✓ (Confirm) key to start pyrolysis. An audible signal is sounded.

– In the display, the 🔒 (Door lock) and 🔥 (Pyrolysis) symbols light up.

For your safety, the oven door is locked immediately. The 🔒 (Door lock) symbol lights up in the display. The oven lighting goes off and the 🔥 (Heating) symbol lights up in the display. The oven starts the pyrolysis process and, depending on the degree of soiling, automatically selects the required pyrolysis time between 2:00 and 3:30 h.

The pyrolysis locking and unlocking process takes about 30 seconds. The 🔒 (Door lock) symbol lights up during this time.

Do not try to open the oven door during the self-cleaning process.

End of pyrolysis

After pyrolysis process has ended, an audible signal sounds and the 🕒 (Cooking time) and 🔥 (Pyrolysis) symbols flash. Press any key and turn the "Temperature" control knob to the 0 position and the "Modes" knob to a position other than Pyrolysis. Pay attention to the fact that the door is not unlocked until at a temperature of 150 °C or less.

Ending the pyrolysis process before expiry of the entered time

– Turn the "Temperature" control knob to the 0 position and the "Mode" control knob to a position other than Pyrolysis.

– Pay attention to the fact that the door is not unlocked until at a temperature of 150 °C or less.

Tip: wait until the appliance indicates that the pyrolysis process has ended. This ensures that you will achieve an optimum cleaning result.

Note: during the pyrolysis process, it is not possible to query the temperature value nor the time.

Starting pyrolysis at a later time

– Enter the required switch-off time (see Chapter 3).

– Turn the control knob to the Pyrolysis setting as described above.

Note: if a switch-off time is programmed, the oven assumed the maximum pyrolysis time of 3:30 h.

In this mode of operation (auto pyrolysis), even stubborn soiling is burnt away at temperatures around 485°C.

After the pyrolytic cleaning process, you can remove the ash easily from the oven using a moist cloth.

6. Maintenance

6.1 General

The appliance must always be disconnected from the mains when being repaired.

If the appliance does not function correctly, check the fuses first.

If the **power supply** is functioning correctly, but your appliance still does not work, please contact your dealer or your local Gaggenau customer service agency. Specify the appliance type (see rating plate).

Repairs may only be carried out by authorised electricians, in order to guarantee the safety of the appliance.

Unauthorised tampering with the appliance will invalidate any warranty claims.

6.2 Replacing the lamp

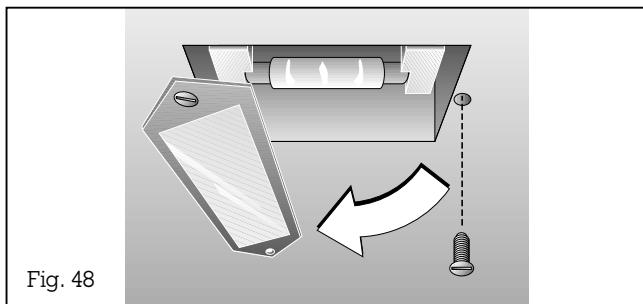

Fig. 48

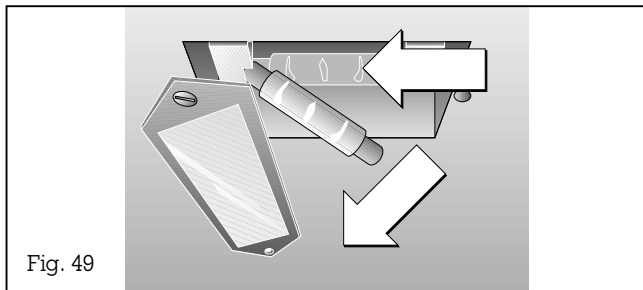

Fig. 49

Replacing the lamp

You can obtain **spare lamps** (Order No. 157312) from Gaggenau Customer Service or a dealer. We recommend that you use these lamps only.

Proceed as follows:

- Disconnect fuses
- Remove one of the lamp cover screws. Unscrew the grill heating element partly or completely if you have problems unscrewing the cover.
- Swivel the cover to the side.

Caution: in certain circumstances, the lamp cover may still be hot.

- Push the lamp to the side by about 4-5 mm. The lamp can now be tilted down and removed.
- Insert the lamp in the reverse order. Swivel the cover back to its original position and screw it on. (Caution: Secure the seal properly!) If you have removed the grill heating element, also screw it down again.

Note: do not touch the halogen lamp with your hands. Use a cloth and only touch the edges of the lamp.

6.3 Disassembly of the front window

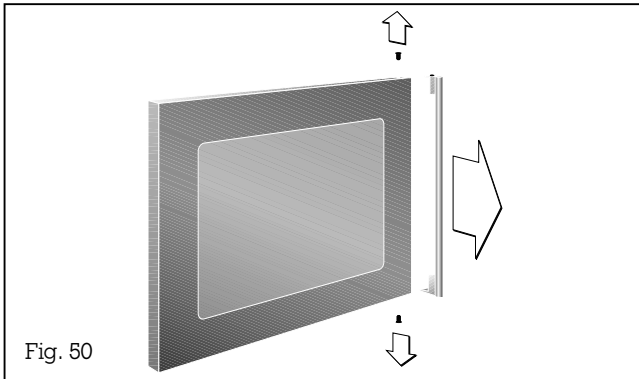

The oven door is actively ventilated. Dust and grease particles may therefore settle after some time. Detach the front window to remove this soiling.

Proceed as follows:

- Remove the bottom screw from the door handle.
- Remove the top screw from the door handle and detach the door handle.
- Hold the front window with one hand and lightly shake the door to and fro. The glass window can be removed towards you.

You can now clean the front window.

Install in the reverse order. In doing so, make sure that you first insert the window on the left hinge side and that you hold it with one hand to stop it from falling out.

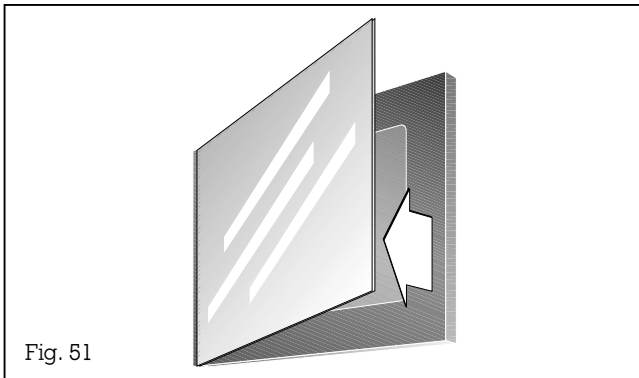

7. Tips and tricks

Baking

What to do if ... ?	The solution !
... a cake baked in a tray is too light at the bottom?	Push the cake in deeper and remove all objects from the oven that you do not need.
... a cake baked in a form is too light at the bottom?	Do not insert the baking form in the oven on the tray, but on the grid.
... a cake/small cakes and pastries are too dark at the bottom?	Insert the cake/pastries at a higher level.
... a cake is too dry?	Set the oven temperature to a slightly higher value. Preheat the oven.
... a cake is too slippery or doughy on the inside or if meat is not cooked on the inside?	Set the baking or roasting temperature to a slightly lower value. Important: baking or roasting times cannot be shortened by selecting higher temperatures. It is better to choose a slightly longer baking or roasting time and to allow the dough to bake longer.
... a cake baked with hot air in a form or a rectangular form is too dark at the back?	Do not place the baking form directly in front of the rear wall of the oven, but in the middle.
... a cake sags?	Use less fluid the next time or set the oven temperature to a value that is lower by 10 degrees. Pay attention to the stirring times specified in the recipe. Do not open the oven door too soon.
... a cake has risen in the middle and is lower at the edges?	Do not grease the edge of the spring form. After baking, carefully loosen the cake with a knife.
... a cake is too dark at the top?	Push it in deeper, select a lower temperature and bake the cake for a slightly longer time.
... a cake is too dark at the bottom?	Insert it at a higher level and choose a lower temperature the next time.
... a fruit cake is too light at the bottom and the fruit juices spill over?	The next time, you are best advised to use the deeper universal pan for baking.
... a cake is too dry at the bottom?	Use a toothpick to make small holes in the finished cake. Then sprinkle fruit juice or an alcoholic beverage over it. The next time, choose a temperature that is higher by 10 degrees and shorten the baking time.
... bread or a cake looks good from the outside, but is slippery on the inside (watery stripes)?	The next time, use slightly less fluid and bake slightly longer at a lower temperature. In the case of cakes with a moist covering, first bake the base, sprinkle almonds or bread-crumbs over it and then add the covering. Pay attention to recipes and baking times.
...you have baked on several levels and your cakes on the top tray are darker than on the bottom one?	If you select a slightly lower temperature, your cakes and pastries will be browned more evenly. Trays inserted at the same time need not be ready at the same time. Allow the bottom trays to bake for 5-10 minutes longer and insert them at an appropriately earlier time.
... biscuits stick to the tray?	Briefly reinsert the tray in the oven and remove the biscuits immediately.
... a cake does not come loose when turned out?	Carefully loosen the edge with a knife. Turn out the cake again and cover the form several times with a cold wet cloth. The next time, grease the form well and additionally sprinkle breadcrumbs into it.

Roasting and grilling

... a roast has become dark and parts of the crust are burnt?	Check the insertion height and the temperature.
... a roast looks good, but the sauce is burnt?	The next time, choose a smaller roasting dish and add more fluid.
... a roast looks good, but the sauce is too light and has become watery?	The next time, choose a larger roasting dish and use less fluid.
... the table does not list a weight for the roast?	Choose the next lowest weight in the list and prolong the roasting time.

- You can use any **heat-resistant crockery**. Place crockery in the middle of the grid. You can also use the universal pan for large roasts. After removing glass crockery, place it on a dry kitchen cloth or grid. Do not place it on a cold or wet support surface. The glass could crack.
- You are advised to use dark metal **baking forms**. You may also use light baking forms in the hot air mode. In this case, the baking time is longer.
- The values in the **cooking tables** apply to the preheated oven. The temperature and duration depend on the quantity and consistency of the dough. This is why the tables list temperature ranges. You are advised to begin with the lowest temperature the first time. If required, set it higher the next time. Remember: a lower temperature ensures more even browning.
- If you want to bake according to your own **recipes**, orientate yourself to similar recipes in the table.
- **To find out** if your cake mixture has baked properly, insert a wooden stick at the highest point of the cake around 5-10 minutes before expiry of the baking time specified in the recipe. The cake is ready if dough no longer sticks to the wood.
- **Moist baked and roasted food** may produce abundant steam. Briefly and carefully open the oven door once or twice and allow the steam to escape. This will ensure that dripping water will not spoil your oven or your built-in furnishings.
- The **result of roasting** depends on the type and quality of the meat. Add 2 to 3 tablespoons of liquid to lean meat. Depending on the size, add 8 to 10 tablespoons to pot roasts. Turn large roasts after half of the roasting time.
- Always grill in the closed oven. If possible, grilled pieces should be equally thick, at least 2 to 3 cm. When this is the case, they will brown evenly and will stay nice and juicy. **Never grill steaks salted!** Place pieces for grilling directly on the grid.
- **Poultry** becomes particularly crispy brown if you coat it with butter, salt water, dripped-off fat or orange juice.
- At 38°C, even **sensitive frozen food** is thawed gently and fast. Place the frozen food on the gridiron and turn the "Mode" control knob to the "Ferment" position. Use the grill pan to collect the liquid from thawing.
- If you only want to grill one piece of meat, place it in the middle of the grid for best results. Place the universal pan on the first level. This ensures that the juices of the meat are collected and the oven stays clean.
- **Turn grilled pieces** after two-thirds of the time specified in the tables.
- You might notice that the **grill element** goes on and off automatically during the grilling time. This is normal. The number of times it switches itself on and off depends on the cooking level you have chosen.
- In the case of **duck or goose**, pierce the skin under the wings to allow the fat to drain off.

Energy-saving tips

- Use **dark baking forms**. These absorb the temperature better.
- In the case of **long baking times**, you can switch off the oven 5-10 minutes before the end of the baking time and you can use the remaining heat to complete the baking process.
- If you want to bake **several cakes**, do not bake them on different levels, but next to one another.

Cleaning and care

- Do not use any **abrasive cleaning agents**, strong agents or implements that might produce scratches.
- **Do not scrape off baked-in** remainders of food. Instead, soak them with a moist cloth and detergent.
- Do not use any special cleaners such as sprays for **aluminium and plastic parts**.
- Do not use a hot detergent rinse to clean the **enamel and glass**.
- You should not use any commercially available stainless steel cleaners for **stainless steel frontages** because they may be aggressive to the imprint. Do not use any sponges with rough surfaces either.
- Apply commercially available detergents on a soft, moist cloth or a window leather.
- If your appliance features a **reflecting glass frontage**, do not use any abrasive agents or sponges with rough surfaces.
- Use commercially available **window containing detergents** and apply them on a soft, moist cloth or a window-cleaning cloth. Do not spray the switch panel.
- You are best advised to clean the oven **after every use**, particularly after roasting or grilling. By doing so, you will prevent food residues from becoming baked-in because it is difficult to remove residues that have baked onto the oven surface after several baking operations.
- If the oven is only **slightly soiled**, clean it with a hot detergent rinse while it is still warm and leave it open to dry.
- Do not use a **steam pressure cleaner** as this poses a risk of short-circuits.

8. Assembly instructions

8.1.1 Technical data EB 270

Rating: 230 V AC, 16 A

Heating power:

Infrared grill	3100W
Hot air heating element	2300W
Top heat	1100 W
Bottom heat	1100 W
Power circuit	3600W

Dimensions:

Outer: 590 x 590 x 550 mm

Inner: 460 x 365 x 400 mm

You can order the following spare parts by stating the specified numbers:

Baking tray	KB 200-046
Gridiron	GR 200-046
Grilling tray	GP 200-046
Halogen lamp	157312
Core temperature sensor	FT 100-060

8.1.2 Technical data EB 290

Rating: 230 V AC, 20 A

Heating power:

Infrared grill	3200W
Hot air heating element	2600W
Top heat	1200W
Bottom heat	1300W
Power circuit	4150W

Dimensions:

Outer: 690 x 590 x 550 mm

Inner: 545 x 365 x 400 mm

You can order the following spare parts by stating the specified numbers:

Baking tray	KB 091-054
Gridiron	GR 200-054
Grilling tray	GP 091-054
Halogen lamp	157312
Core temperature sensor	FT 100-060

Technical modifications without notice.

8.2 How to do it

The appliance must only be connected by an **authorised specialist**, paying attention to the relevant regulations of the power supply companies and the regional construction regulations.

The electrician is responsible for the correct functioning of the appliance at the time of installation. He must instruct the user on how to operate the appliance correctly on the basis of the Operating Instructions, and the user must be instructed on how to disconnect the appliance in an emergency.

We accept no liability for **damage** caused by failure to comply with these instructions.

If it is not possible to disconnect the appliance from the mains via an easily accessible plug and permanent cable connection, an isolating switch with a contact clearance of at least 3 mm must be fitted on the installation side.

Repairs carried out improperly may involve substantial risks for you.

Connection to the power mains

On the top of the appliance there is a cover that has to be unscrewed. The wiring diagram stuck onto the top of the appliance shows the connection variant.

For 230 V only: the oven is connected in one phase. (EB 270 - 1x16 A / EB 290 - 1x20 A)

For 400 V only: the oven is connected in two phases, i.e. L1, L2 and N.

The appliance must be earthed.
The manufacturer cannot be held liable for damages that might arise from improper or non-existent earthing of the appliance.
Screw the cover back on.

EB 270

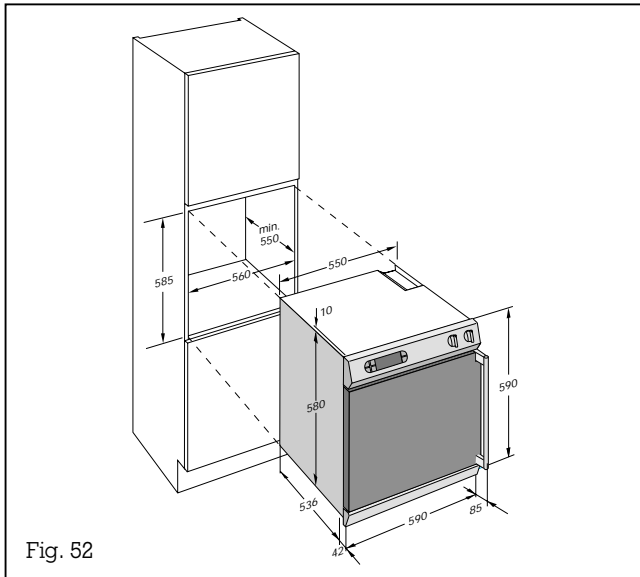

Fig. 52

EB 290

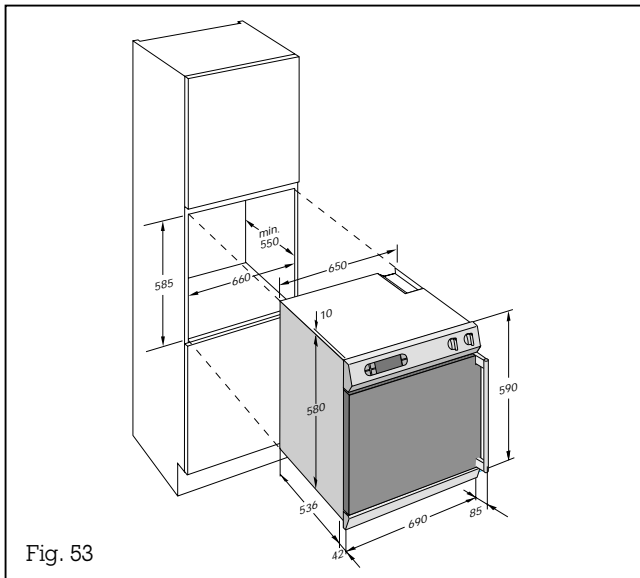

Fig. 53

Proceed as follows:

- When unpacking the appliance, check it for transport damage.
- Please remove the adhesive tapes that protect the door during transport.
- A flexible cable should be used as the mains lead. The cross-section must be selected according to the rated current consumption and the type of connection.
- Push the appliance into the item of furnishing. Use the included wood screw to firmly bolt it to the face timber surface of the conversion cabinet on the handle and hinge side, directly underneath the bottom panel.
- After installing, ensure that wires are protected against contact.
- Finally test the oven for correct functioning.
- Thoroughly clean the appliance and accessories before using them for the first time. (see "Cleaning and Care")

Free Manuals Download Website

<http://myh66.com>

<http://usermanuals.us>

<http://www.somanuals.com>

<http://www.4manuals.cc>

<http://www.manual-lib.com>

<http://www.404manual.com>

<http://www.luxmanual.com>

<http://aubethermostatmanual.com>

Golf course search by state

<http://golfingnear.com>

Email search by domain

<http://emailbydomain.com>

Auto manuals search

<http://auto.somanuals.com>

TV manuals search

<http://tv.somanuals.com>