

AquaContour automatic Art. 1559

D Betriebsanleitung

Vielflächen-Versenkregner

GB Operating Instructions

Large-Area Pop-up Irrigation

F Mode d'emploi

Arroseur escamotable multisurfaces

NL Instructies voor gebruik

Verzonken multi-instelbare sproeier

S Bruksanvisning

AquaContour automatic Pop-up

I Istruzioni per l'uso

Irrigatore Pop-up per superfici irregolari

E Manual de instrucciones

Aspersor emergente de múltiples superficies

P Instruções de manejo

Aspersores embutidos de grandes superficies

DK Brugsanvisning

AquaContour automatic Pop-up

GARDENA Large-Area Pop-Up Irrigation AquaContour automatic

Welcome to the Garden of GARDENA...



Translation of the original instructions from German.
Please read these operating instructions carefully and observe the information they contain. Use these operating instructions to familiarise yourself with the GARDENA Large-Area Pop-up Irrigation, its proper use and the notes on safety.



For safety reasons, children under the age of 16 as well as people who are not familiar with the operating instructions should not use the large-area pop-up irrigation. Persons with reduced physical or mental abilities may use the product only if they are supervised or instructed by a responsible person.

→ Please keep these instructions in a safe place.

Contents :

1. Where to use Your GARDENA Large-Area Pop-Up Irrigation	11
2. Safety instructions	11
3. Function	12
4. Initial Operation	12
5. Operation	13
6. Putting into Storage	15
7. Maintenance	15
8. Troubleshooting	16
9. Accessories	17
10. Technical Data	18
11. Service / Warranty	18

1. Where to use Your GARDENA Large-Area Pop-Up Irrigation

Intended Use:

The GARDENA Large-Area Pop-Up Irrigation forms part of the GARDENA Irrigation System and is designed to be used solely outdoors in domestic and private gardens to water lawns and garden areas.

Please note:



It is not permitted to use the large-area pop-up irrigation for industrial or commercial applications and in conjunction with chemicals, foodstuffs, highly combustible or explosive substances.

2. Safety instructions

Rechargeable battery:

The large-area pop-up irrigation unit contains rechargeable lithium-ion batteries, which are automatically charged via a built-in solar cell.

When the rechargeable battery is almost flat (e.g. due to soiling of the protective panel of

the solar cell), irrigation will only cover a minimal range.

To fully charge the flat rechargeable battery it will take approx. 4 days of sunshine (8 hours each) or some 10 days with cloudy weather until the battery is fully charged again.

Information about usage:

The large-area pop-up irrigation should not be combined with other sprinklers in one irrigation line.

If there is a change in the range of the large-area pop-up irrigation, the pressure conditions will change in the irrigation line, so altering the range of the other sprinkler.

→ Only use separate individual water channels for watering. Do not install in series with other sprinklers.

The ranges selected may vary with major fluctuations in pressure in the water pipe.

Pressure Tank Units (with pressure chamber) to supply water to the sprinkler are not recommended as they cause fluctuations in pressure with the switch-on/off pressure.

Sand and other abrasive substances in the water will result in faster wear and reduced output.

→ With water containing sand a Central Filter (e.g. GARDENA Central Filter Art. 1510) should be used.

Do not run over sprinklers installed level with ground with a lawn rake or aerator.

3. Function

Control panel:

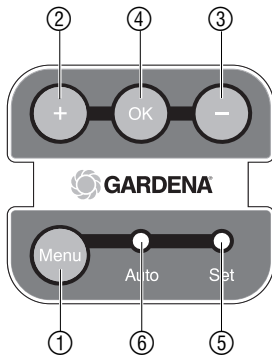

The GARDENA Large-Area Pop-up Irrigation AquaContour automatic can be used to water individual garden areas. A jet of water slowly turns in a circle to the end of the programmed sector, stops, and turns back again, altering the spray range depending on the ranges programmed. The control panel is used to programme the irrigation contour points.

- ① **Menu button:** Choose between programming mode (Set) and operating mode (Auto).
- ② **“+” button:** Increases irrigation range.
- ③ **“-” button:** Decreases irrigation range.
- ④ **OK button:** Stores the irrigation range selected.
- ⑤ **Set LED:** Indicates programming mode.
- ⑥ **Auto LED:** Indicates automatic operating mode. The LED flashes every 10 seconds.

4. Initial Operation

Select correct location for Large-Area Pop-Up Irrigation:

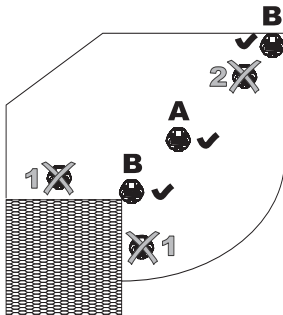

Correct location:

A Circle water distribution:

- With circle water distribution the large-area pop-up irrigation should be positioned as centrally as possible in the watering area to ensure that the irrigation width is not greatly affected by external influences such as wind.

B Sector water distribution:

- With sector water distribution the large-area pop-up irrigation should be positioned right at the edge of the watering area (e.g. at the corner of the house).
- The large-area pop-up irrigation must be positioned at a point in the watering sector from which it is possible to water the entire garden area required. The maximum range is 9 m (with 2 bar flow pressure at the irrigation unit).
- The large-area pop-up irrigation must be installed in a position which is sunny all year round to ensure the solar cell receives sufficient light.

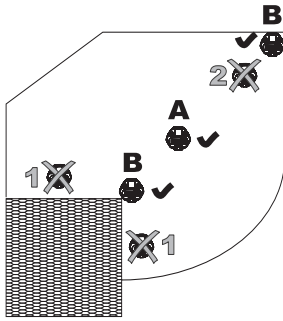

Install Large-Area Pop-Up Irrigation:

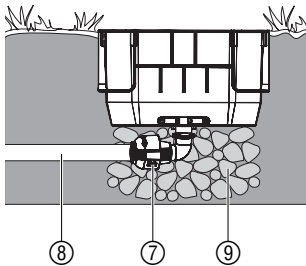

Remove protective plastic film of solar cell:

Incorrect location:

1:

- No obstacles (e.g. walls, trees, etc.) should be located in the watering sector. It must be possible to access every contour point of the areas to be watered in a straight line. With the maximum range the spray height can reach approx. 5 m.

2:

- The minimum range is 2.5 m (at 2 bar). With circle water distribution the large-area pop-up irrigation must therefore be located 2.5 m from the edge in all directions **(A)**. If this is not possible the large-area pop-up irrigation should be positioned at the edge and the watering area will be a circle sector **(B)**.

Before installing the large-area pop-up irrigation, you must set up an above-ground test to check whether the large-area pop-up irrigation can actually water the required area at this location.

The large-area pop-up irrigation has a 3/4" female thread and is connected to the 25 mm Connecting Pipe ⑧ Art. 2700 / 2701 using the GARDENA L-piece ⑦ Art. 2781.

1. Install the above-ground test set-up and check whether the large-area pop-up irrigation can water the required area (see 5. Operation).
2. If the large-area pop-up irrigation has watered the required area in the test, install a pack of coarse gravel ⑨ approx. 20 cm x 20 cm x 20 cm in size underneath the unit.
This ensures proper functioning of the drain valve.
3. Install the upper edge of the large-area pop-up irrigation level with the turf. *This prevents any damage when mowing the lawn.*

→ Take off transportation protective plastic film from the protective panel of of the solar cell.

5. Operation

Select watering sector:

A watering sector from 25° to 360° can be selected. To prevent areas being watered unintentionally (e.g. house), the sector should first be selected roughly (slightly too small).

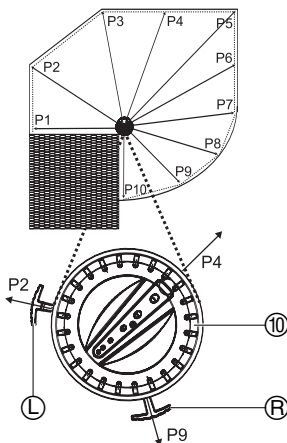

Roughly select sector:

1. Close water supply.
2. Turn the nozzle head ⑩ by hand to the middle of the watering sector (e.g. P4).
3. Roughly select watering sector: turn right sector stop ⑧ to right-hand side (e.g. P9) and left sector stop ⑨ to left-hand side (e.g. P2).

Re-adjust sector:

1. Open water supply.
2. Watch watering sector and re-adjust the sector-stops ⑨ and ⑧ according to the sector limits (P1 and P10) until the change in direction matches the required irrigation limits.
If watering in a complete circle, the two sector stops ⑨ and ⑧ must be completely pushed together between P1 and P10.

Programme contour points of irrigation sector:

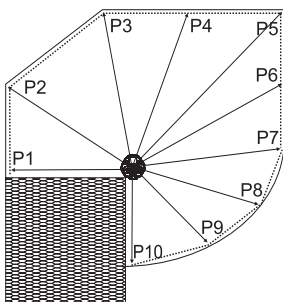
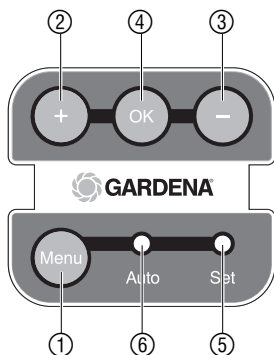
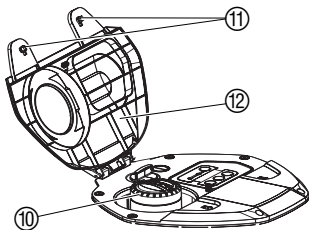

Anti-vandal device:

If the nozzle head is turned beyond the sector stops with the sector stops held, the anti-vandal device will be triggered. As soon as the water supply is opened, the large-area pop-up irrigation will automatically return to the watering sector. The head of the Large-Area Irrigation can turn around 360° before the original position is reached again.

The watering sector has to be selected before programming. Up to 50 contour points can be programmed with the large-area pop-up irrigation. The more points that are programmed, the more precisely the contour will be described (e.g. with a circular arc P7 – P10).

1. Open the two locks ⑪ and raise the cover ⑩.
2. Open water supply.
When using for the first time, the minimum range (2.5 m with a flow pressure of 2 bar at the sprinkler) is selected.
3. Press **OK** button ④. *The green Auto LED ⑥ lights up.*
4. Press **Menu** button ①. *The red Set LED ⑤ lights up.*
5. Turn the nozzle head ⑩ on the orange ring **by hand** to the left-hand sector limit (in the example P1) and hold.
6. Use the two buttons “+” button ② and “-” button ③ to set the range so that it reaches P1.
7. Press **OK** button ④.
The green Auto LED ⑥ lights up for 1 second and the first point P1 has been stored.
8. Turn the nozzle head ⑩ on the orange ring **by hand** to the next irrigation point (e.g. P2) and hold.
9. Use the two buttons “+” button ② and “-” button ③ to set the range so that it reaches P2 for example.
10. Press **OK** button ④.
The green Auto LED ⑥ lights up for 1 second and the point has been stored.
11. Repeat the process from step 8 to 10 until the right-hand sector limit is reached (in the example P10).
12. Press **Menu** button ①.
The red Set LED ⑤ goes out, programming is complete, and the green Auto LED ⑥ lights up for 1 minute. The Auto LED then flashes every 10 seconds.
13. Release nozzle head ⑩ and check contour area watered.
14. If the contour is watered correctly, close the water supply.
15. Close cover ⑫ and both locks ⑪.

Information about programming:

As soon as the first point is programmed, any existing programme will be deleted. After programming has been completed, no further points can be deleted or added later on. If the contour has not been set as required, reprogramming with more points will have to be carried out. If no button is pressed for 60 seconds during programming, programming will be automatically ended and the contour stored.

Start / end watering:

Before irrigation can be started, the large-area pop-up irrigation must have been programmed.

Start watering:

→ Fully open water supply.
Watering will start automatically and the contour of the watering sector previously programmed will be watered.

End watering:

→ Close water supply.
Watering will end. The programme remains unchanged.

6. Putting into Storage

Storage / Overwintering:



The large-area pop-up irrigation is frostproof so it can be left in the ground during winter.

1. Close cover and both locks.
2. Close water supply.
The large-area pop-up irrigation is automatically emptied via the built-in drain valve.

Disposal:
(in accordance with RL 2002/96/EC)



The product must not be added to normal household waste. It must be disposed of in line with local environmental regulations.

→ Important: Make sure that the unit is disposed of via your municipal recycling collection centre.

Disposal of rechargeable battery:



Li-ion

The large-area pop-up irrigation contains lithium-ion cells that should not be discarded with normal household waste at the end of their life.

Important:

Proper disposal is ensured by your GARDENA dealer or municipal recycling collection centre.

1. Discharge lithium-ion cells completely.
2. Dispose of lithium-ion cells properly.

7. Maintenance

Clean dirt filter:

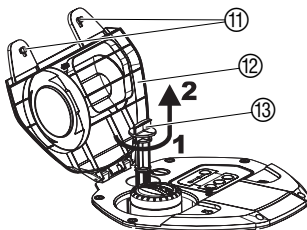

1. Open both locks ⑪ and raise the cover ⑫.
2. Turn the dirt filter ⑬ anticlockwise **1** and pull out carefully **2** (bayonet coupling).
3. Clean dirt filter ⑬ under clean running water.
4. Refit dirt filter ⑬ in reverse order.
5. Close cover ⑫ and both locks ⑪.

Clean nozzles:

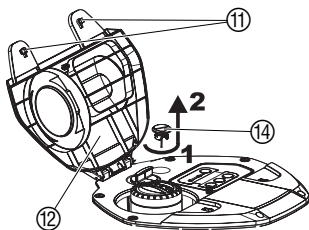

If the watering pattern is no longer even, the nozzles can be cleaned using the cleaning needle provided.

1. Open both locks ⑪ and raise the cover ⑫.
2. Turn the cleaning needle ⑭ (e.g. with a coin) anticlockwise through 180° **1** and pull out carefully **2** (bayonet coupling).
3. Clean nozzles ⑮ with cleaning needle ⑭.
4. Refit cleaning needle ⑭ in reverse order.
5. Close cover ⑫ and both locks ⑪.

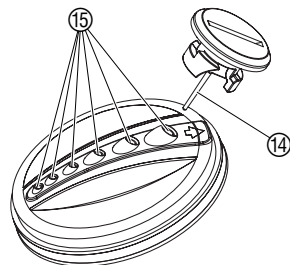

Clean protective panel of solar cell:

To make sure that the rechargeable battery is always sufficiently charged, the protective panel of the solar cell has to be cleaned if soiled.

No caustic / abrasive cleaning agents or hard objects should be used.

→ Clean protective panel of solar cell with a damp cloth.

8. Troubleshooting

Fault	Possible cause	Remedy
Irrigation width smaller than on initial start-up	Dirt filter soiled.	→ Clean dirt filter.
	Tap not opened sufficiently.	→ Open tap further.
	Water pressure too low.	→ Increase water pressure / water supply.
	Rechargeable batteries almost flat (Auto and Set LED flashing) / Protective panel of solar cells soiled.	→ Ensure solar cells are exposed to sufficient sunlight / clean protective panel. If the rechargeable battery is almost flat, the range is reduced to the min. level.
	Large-area pop-up irrigation is in energy-saving mode (4 weeks without energy supply or operation).	→ Press OK button.
Watering pattern uneven	Irrigation range is programmed incorrectly.	→ Reprogramme irrigation range.
	Nozzles soiled.	→ Clean nozzles.
	Nozzle head soiled.	→ Clean nozzle head.
Auto and Set LED flashing simultaneously	Nozzle head damaged.	→ Contact GARDENA Service.
	Rechargeable batteries almost discharged.	→ Ensure solar cell is exposed to sufficient sunlight.

Fault	Possible cause	Remedy
No LED flashing	Large-area pop-up irrigation is in energy-saving mode.	→ Press OK button.
	Rechargeable battery defective.	→ Contact GARDENA Service.
Nozzle head leaking	Soiling on nozzle head.	→ Press down nozzle head several times during operation.

! In the event of other faults please contact **GARDENA Service**. Repairs should only be carried out by **GARDENA service centres or dealers authorised by GARDENA**.

9. Accessories

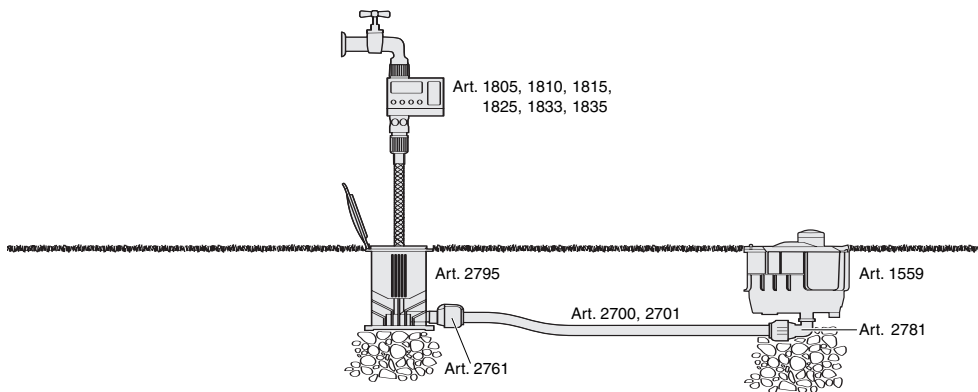

GARDENA Water Computer	For automatic watering control	Art. 1805, 1810, 1815, 1825, 1833, 1835, 1860, 1862, 1864, 1866
GARDENA L-piece	For connection to below-ground water supply	Art. 2781
GARDENA Connecting Pipe 25 mm	For below-ground installation of water supply	Art. 2700, 2701, 2718
GARDENA Connector	For below-ground installation of water supply	Art. 2761
GARDENA Connecting Point	For below-ground installation of water supply	Art. 2795

10. Technical data

AquaContour automatic (Art. 1559)

Rechargeable battery:	Lithium-ion cells 1100 mAh (charged via solar cell)
Operating life of rechargeable battery:	approx. 5 years
Connection:	3/4" female thread
Operating temperature range:	5 – 60 °C
Pressure range:	1 – 6 bar
Irrigation width:	2.5 – 9 m at 2 bar / 4 – 10,5 m at 4 bar
Watering area:	255 m ² at 2 bar / 350 m ² at 4 bar
Watering sector:	25 – 360°
Water flow rate with max. range:	approx. 600 l/h (at 2 bar) / approx. 800 l/h (at 4 bar)

11. Service / Warranty

Warranty

GARDENA guarantees this product for 2 years (from date of purchase). This guarantee covers all serious defects of the unit that can be proved to be material or manufacturing faults. Under warranty we will either replace the unit or repair it free of charge if the following conditions apply:

- The unit must have been handled properly and in keeping with the requirements of the operating instructions.
- Neither the purchaser or a non-authorized third party have attempted to repair the unit.

As a wear part the dirt filter is not covered by the guarantee.

This manufacturer's guarantee does not affect the user's existing warranty claims against the dealer/seller.

If a fault occurs with your large-area pop-up irrigation, please return the faulty unit together with a copy of the receipt and a description of the fault, with postage paid to one of the GARDENA Service Centres listed on the back of these operating instructions.

<p>D <i>Produkthftung</i></p>	<p>Wir weisen ausdrücklich darauf hin, dass wir nach dem Produkthaftungsgesetz nicht für durch unsere Geräte hervorgerufene Schäden einzustehen haben, sofern diese durch unsachgemäße Reparatur verursacht oder bei einem Teileaustausch nicht unsere Original GARDENA Teile oder von uns freigegebene Teile verwendet werden und die Reparatur nicht vom GARDENA Service oder dem autorisierten Fachmann durchgeführt wird. Entsprechendes gilt für Ergänzungssteile und Zubehör.</p>
<p>GB <i>Product Liability</i></p>	<p>We expressly point out that, in accordance with the product liability law, we are not liable for any damage caused by our units if it is due to improper repair or if parts exchanged are not original GARDENA parts or parts approved by us, and, if the repairs were not carried out by a GARDENA Service Centre or an authorised specialist. The same applies to spare parts and accessories.</p>
<p>F <i>Responsabilité</i></p>	<p>Nous vous signalons expressément que GARDENA n'est pas responsable des dommages causés par ses appareils, dans la mesure où ces dommages seraient causés suite à une réparation non conforme, dans la mesure où, lors d'un échange de pièces, les pièces d'origine GARDENA n'auraient pas été utilisées, ou si la réparation n'a pas été effectuée par le Service Après-Vente GARDENA ou l'un des Centres SAV agréés GARDENA. Ceci est également valable pour tout ajout de pièces et d'accessoires autres que ceux préconisés par GARDENA.</p>
<p>NL <i>Productaansprakelijkheid</i></p>	<p>Wij wijzen er nadrukkelijk op, dat wij op grond van de wet aansprakelijkheid voor producten niet aansprakelijk zijn voor schade ontstaan door onze apparaten, indien deze door onvakkundige reparatie veroorzaakt zijn, of er bij het uitwisselen van onderdelen geen gebruik gemaakt werd van onze originele GARDENA onderdelen of door ons vrijgegeven onderdelen en de reparatie niet door de GARDENA technische dienst of de bevoegde vakman uitgevoerd werd. Ditzelfde geldt voor extra-onderdelen en accessoires.</p>
<p>S <i>Produktansvar</i></p>	<p>Tillverkaren är inte ansvarig för skada som orsakats av produkten om skadan beror på att produkten har reparerats felaktigt eller om, vid reparation eller utbyte, andra än Original GARDENA reservdelar har använts. Samma sak gäller för kompletteringsdelar och tillbehör.</p>
<p>I <i>Responsabilità del prodotto</i></p>	<p>Si rende espressamente noto che, conformemente alla legislazione sulla responsabilità del prodotto, non si risponde di danni causati da nostri articoli se originati da riparazioni eseguite non correttamente o da sostituzioni di parti effettuate con materiale non originale GARDENA o comunque da noi non approvato e, in ogni caso, qualora l'intervento non venga eseguito da un centro assistenza GARDENA o da personale specializzato autorizzato. Lo stesso vale per le parti complementari e gli accessori.</p>
<p>E <i>Responsabilidad de productos</i></p>	<p>Advertimos que conforme a la ley de responsabilidad de productos no nos responsabilizamos de daños causados por nuestros aparatos, siempre y cuando dichos daños hayan sido originados por arreglos o reparaciones indebidas, por recambios con piezas que no sean piezas originales GARDENA o bien piezas autorizadas por nosotros, así como en aquellos casos en que la reparación no haya sido efectuada por un Servicio Técnico GARDENA o por un técnico autorizado. Lo mismo es aplicable para las piezas complementarias y accesorios.</p>
<p>P <i>Responsabilidade sobre o produto</i></p>	<p>Queremos salientar que segundo a lei da responsabilidade do fabricante, nós não nos responsabilizaremos por danos causados pelo nosso equipamento, quando estes ocorram em decorrência de reparações inadequadas ou da substituição de peças por peças não originais da GARDENA, ou peças não autorizadas. A responsabilidade tornar-se-à nula também depois de reparações realizadas por oficinas não autorizadas pela GARDENA. Esta restrição valerá também para peças adicionais e acessórios.</p>
<p>DK <i>Produktansvar</i></p>	<p>Vi gør udtrykkeligt opmærksom på at i henhold til produktansvarsloven er vi ikke ansvarlige for skader forårsaget af vores udstyr, hvis det skyldes uautoriserede reparationer eller hvis dele er skiftet ud og der ikke er anvendt originale GARDENA dele eller dele godkendt af os, eller hvis reparationerne ikke er udført af GARDENA-service eller en autoriseret fagmand. Det samme gælder for ekstra udstyr og tilbehør.</p>

<p>D EU-Konformitätserklärung Maschinenverordnung (9. GSGVO) / EMVG / Niedersp. RL Der Unterzeichnete GARDENA Manufacturing GmbH, Hans-Lorenser-Str. 40, D-89079 Ulm, bestätigt, dass die nachfolgend bezeichneten Geräte in der von uns in Verkehr gebrachten Ausführung die Anforderungen der harmonisierten EU-Richtlinien, EU-Sicherheitsstandards und produktspezifischen Standards erfüllen. Bei einer nicht mit uns abgestimmten Änderung der Geräte verliert diese Erklärung ihre Gültigkeit.</p>	Bezeichnung des Gerätes: Vielflächen-Versenkregner Description of the unit: Large-Area Pop-up Irrigation Désignation du matériel : Arroseur escamotable multisurfaces Omschrijving van het apparaat: Verzonken multi-instelbare sproeier Produktbeskrivning: AquaContour automatic Pop-up Descrizione del prodotto: Irrigatore Pop-up per superfici irregolari Descripción de la mercancía: Aspersor emergente de múltiples superficies Descrição do aparelho: Aspersores embutidos de grandes superficies Beskrivelse af enhederne: AquaContour automatic Pop-up
<p>GB EU Certificate of Conformity The undersigned GARDENA Manufacturing GmbH, Hans-Lorenser-Str. 40, D-89079 Ulm, hereby certifies that, when leaving our factory, the units indicated below are in accordance with the harmonised EU guidelines. EU standards of safety and product specific standards. This certificate becomes void if the units are modified without our approval.</p>	
<p>F Certificat de conformité aux directives européennes Le constructeur, soussigné : GARDENA Manufacturing GmbH, Hans-Lorenser-Str. 40, D-89079 Ulm, déclare qu'à la sortie de ses usines le matériel neuf désigné ci-dessous était conforme aux prescriptions des directives européennes énoncées ci-après et conforme aux règles de sécurité et autres règles qui lui sont applicables dans le cadre de l'Union européenne. Toute modification portée sur ce produit sans l'accord express de GARDENA supprime la validité de ce certificat.</p>	Typ: Art.-Nr.: Type: Art. No.: Type : Référence : Type : AquaContour Art. nr.: Modello: automatic Art. nr. : 1559 Tipo: Art. Nº: Tipo: Art. Nº: Type: Varenr. :
<p>NL EU-overeenstemmingsverklaring Ondergetekende GARDENA Manufacturing GmbH, Hans-Lorenser-Str. 40, D-89079 Ulm, bevestigt, dat het volgende genoemde apparaat in de door ons in de handel gebrachte uitvoering voldoet aan de eis van, en in overeenstemming is met de EU-richtlijnen, de EU-veiligheidsstandaard en de voor het product specifieke standaard. Bij een niet met ons afgestemde verandering aan het apparaat verliest deze verklaring haar geldigheid.</p>	EU-Richtlijnen : EU directives : Directives européennes : EU-richtlijnen : EU direktiv : Direttive UE : Normativa UE : Directrizes da UE : EU Retningslinier :
<p>S EU Tillverkarintyg Undertecknad firma GARDENA Manufacturing GmbH, Hans-Lorenser-Str. 40, D-89079 Ulm, intygar härmed att nedan nämnda produkter överensstämmer med EU:s direktiv, EU:s säkerhetsstandard och produktspecifikation. Detta intyg upphör att gälla om produkten ändras utan vårt tillstånd.</p>	98/37/EC : 1998 2006/42/EG : 2006 2004/108/EC
<p>I Dichiarazione di conformità alle norme UE La sottoscritta GARDENA Manufacturing GmbH, Hans-Lorenser-Str. 40, D-89079 Ulm, certifica che il prodotto qui di seguito indicato, nei modelli da noi commercializzati, è conforme alle direttive armonizzate UE nonché agli standard di sicurezza e agli standard specifici di prodotto. Qualunque modifica apportata al prodotto senza nostra specifica autorizzazione invalida la presente dichiarazione.</p>	Harmonisierte EN: EN ISO 1200-1:04/04 EN ISO 1200-2:04/04
<p>E Declaración de conformidad de la UE El que suscribe GARDENA Manufacturing GmbH, Hans-Lorenser-Str. 40, D-89079 Ulm, declara que la presente mercancía, objeto de la presente declaración, cumple con todas las normas de la UE, en lo que a normas técnicas, de homologación y de seguridad se refiere. En caso de realizar cualquier modificación en la presente mercancía sin nuestra previa autorización, esta declaración pierde su validez.</p>	Anbringningsår der CE-Kennzeichnung : Year of CE marking : Date d'apposition du marquage CE : Installatiejaar van der CE-aanduiding : CE-Mærkningsår: 2006 Anno di rilascio della certificazione CE : Colocación del distintivo CE : Ano de marcação pela CE : CE-Mærkningsår:
<p>P Certificado de conformidad da UE Os abaixo mencionados GARDENA Manufacturing GmbH, Hans-Lorenser-Str. 40, D-89079 Ulm, por este meio certificam que ao sair da fábrica o aparelho abaixo mencionado está de acordo com as diretizes harmonizadas da UE, padrões de segurança e de produtos específicos. Este certificado ficará nulo se a unidade for modificada sem a nossa aprovação.</p>	
<p>DK EU Overensstemmelse certificat Undertegnede GARDENA Manufacturing GmbH, Hans-Lorenser-Str. 40, D-89079 Ulm bekræfter hermed, at enheder listet herunder, ved afsendelse fra fabrikken, er i overensstemmelse med harmoniserede EU retningslinier, EU sikkerhedsstandarder og produktspecifikationsstandarder. Dette certifikat træder ud af kraft hvis enhederne er ændret uden vor godkendelse.</p>	
	 Peter Lameli Ulm, den 01.08.2006 Ulm, 01.08.2006 Fait à Ulm, le 01.08.2006 Ulm, 01-08-2006 Ulm, 2006.08.01 Ulm, 01.08.2006 Ulm, 01.08.2006 Ulm, 01.08.2006 Ulm, 01.08.2006 Ulm, 01.08.2006 Technische Leitung Technische Dept. Manager Direction technique Hoofd technische dienst Technical Director Direzione Tecnica Dirección Técnica Director Técnico Teknisk direktør

Deutschland / Germany

GARDENA
Manufacturing GmbH
Central Service
Hans-Lorenser-Straße 40
D-89079 Ulm
Produktfragen:
(+49) 731 490-123
Reparaturen:
(+49) 731 490-290
service@gardena.com

Argentina

Husqvarna Argentina S.A.
Vera 745
(C1414AOO) Buenos Aires
Phone: (+54) 11 4858-5000
diego.poggi@ar.husqvarna.com

Australia

Husqvarna Australia Pty. Ltd.
Locked Bag 5
Central Coast BC
NSW 2250
Phone: (+61) 1800 802831
customer.service@
husqvarna.com.au

Austria / Österreich

Husqvarna Austria GmbH
Consumer Products
Industriezeile 36
4010 Linz
Tel.: (+43) 732 77 01 01 - 90
consumer.service@husqvarna.at

Belgium

GARDENA Belgium NV/SA
Sterrebeekstraat 163
1930 Zaventem
Phone: (+32) 2 72092 12
Mail: info@gardena.be

Brazil

Palash Comércio e
Importação Ltda.
Rua São João do Araguaia, 338
- Jardim Califórnia -
Barueri - SP - Brasil -
CEP 06409-060
Phone: (+55) 11 4198-9777
eduardo@palash.com.br

Bulgaria

Хускварна България ЕООД
1799 София
Бул. „Андрей Ляпчев“ № 72
Тел.: (+359) 2 80 99 424
www.husqvarna.bg

Canada

GARDENA Canada Ltd.
100 Summerlea Road
Brampton, Ontario L6T 4X3
Phone: (+1) 905 792 9330
info@gardenacanada.com

Chile

Antonio Martinic y Cia Ltda.
Cassillas 272
Centro de Cassillas
Santiago de Chile
Phone: (+56) 2 20 10 708
garfar_cl@yahoo.com

Costa Rica

Compania Exim
Euroberoamericana S.A.
Los Colegios, Moravia,
200 metros al Sur del Colegio
Saint Francis - San José
Phone: (+506) 297 68 83
exim_euro@racsa.co.cr

Croatia

KLIS d.o.o.
Stanciceva 79
10419 Vukovina
Phone: (+385) 1 622 777 0
gardena@klis-trgovina.hr

Cyprus

FARMOKIPIKI LTD
P.O. Box 7098
74, Digeni Akritas Ave.
1641 Nicosia
Phone: (+357) 22 75 47 62
condam@spidernet.com.cy

Czech Republic

GARDENA spol. s r.o.
Tuřanka 115
627 00 Brno
Phone: (+420) 548 217 777
gardena@gardenabrno.cz

Denmark

GARDENA
Husqvarna Consumer Outdoor
Products
Salgsafdelning Danmark
Box 9003
S-200 39 Malmö
info@gardena.dk

Estonia

Husqvarna Eesti OÜ
Consumer Outdoor Products
Kesk tee 10, Aaviku küla
Rae vald, Harju maakond
75305
kontakt.etj@husqvarna.ee

Finland

Oy Husqvarna Ab
Consumer Outdoor Products
Lautatarhankatu 8 B / PL 3
00581 HELSINKI
info@gardena.fi

France

GARDENA France
Immeuble Expositel
9 - 11 allée des Pierres Mayettes
ZAC des Barbanniers, B.P. 99
-F- 92232 GENNEVILLIERS
cedex
Tél. (+33) 01 40 85 30 40
service.consommateurs@
gardena.fr

Great Britain

Husqvarna UK Ltd
Preston Road
Aycliffe Industrial Park
Newton Aycliffe
County Durham
DL5 6UP
info.gardena@
husqvarna.co.uk

Greece

HUSQVARNA GREECE S.A.
Branch of Koropi
Ilfestou 33A
Industrial Area Koropi
194 00 Athens - Greece
V.A.T. EL094094640
Phone: (+30) 210 66 20 225
info@husqvarna-consumer.gr

Hungary

Husqvarna
Magyarország Kft.
Ezred u. 1 - 3
1044 Budapest
Phone: (+36) 80 20 40 33
gardena@gardena.hu

Iceland

Ó. Johnson & Kaaber
Tunguhalsi 1
110 Reykjavik
ooj@ojk.is

Ireland

Michael McLoughlin & Sons
Hardware Limited
Long Mile Road
Dublin 12

Italy

GARDENA Italia S.p.A.
Via Donizetti 22
20020 Lainate (Mi)
Phone: (+39) 02.93.94.79.1
info@gardenaitalia.it

Japan

KAKUICHI Co. Ltd.
Sumitomo Realty &
Development Kojimachi
BLDG., 8F, 5-1 Nibanncyo,
Chiyoda-ku, Tokyo 102-0084
Phone: (+81) 33 264 4721
m_ishihara@kaku-ichi.co.jp

Latvia

SIA „Husqvarna Latvija“
Consumer Outdoor Products
Bakūžu iela 6, Rīga, LV-1024
info@husqvarna.lv

Lithuania

UAB Husqvarna Lietuva
Consumer Outdoor Products
Atleities pl. 77C
LT-52104 Kaunas
centras@husqvarna.lt

Luxembourg

Magasins Jules Neuberg
39, rue Jacques Stas
Luxembourg-Gasperich 2549
Case Postale No. 12
Luxembourg 2010
Phone: (+352) 40 14 01
api@neuberg.lu

Netherlands

GARDENA Nederland B.V.
Postbus 50176
1305 AD ALMERE
Phone: (+31) 36 521 00 00
info@gardena.nl

Neth. Antilles

Jonka Enterprises N.V.
Sta. Rosa Weg 196
P.O. Box 8200, Curaçao
Phone: (+599) 9 767 66 55
pgm@jonka.com

New Zealand

Husqvarna New Zealand Ltd.
PO Box 76437
Manukau City 2241
Phone: (+64) 09 9202410

Norway

GARDENA
Husqvarna Consumer Outdoor
Products
Salgskontor Norge
Klevereveien 6
1540 Vestby
info@gardena.no

Poland

Husqvarna Poland Spółka z o.o.
Oddział w Szymanowie
Szymanów 9 d
05-532 Baniocha
Phone: (+48) 22 727 56 90
gardena@gardena.pl

Portugal

GARDENA Portugal Lda.
Sintra Business Park
Edifício 1, Fracção 0-G
2710-089 Sintra
Phone: (+351) 21 922 85 30
info@gardena.pt

Romania

MADEX INTERNATIONAL SRL
Soseaua Odaii 117-123,
Sector 1,
București, RO 013603
Phone: (+40) 21 352 76 03
madex@ines.ro

Russia

ООО ГАРДЕНА PVC
123007, г. Москва
Хорошевское шоссе, д. 32А
Тел.: (+7) 495 380 31 92
info@gardena-rus.ru

Singapore

Hy - Ray PRIVATE LIMITED
40 Jalan Pemimpin
#02-08 Tat Ann Building
Singapore 577185
Phone: (+65) 6253 2277
shiyang@hyray.com.sg

Slovak Republic

GARDENA spol. s r.o.
Tuřanka 115
627 00 Brno
Phone: (+420) 548 217 777
gardena@gardenabrno.cz

Slovenia

GARDENA d.o.o.
Brodšiče 15
1236 Trzin
Phone: (+386) 1 580 93 32
servis@gardena.si

South Africa

GARDENA
South Africa (Pty.) Ltd.
P.O. Box 11534
Vorna Valley 1686
Phone: (+27) 11 315 02 23
sales@gardena.co.za

Spain

GARDENA IBÉRICA S.L.U.
C/ Basauri, nº 6
La Florida
28023 Madrid
Phone: (+34) 91 708 05 00
atencioncliente@gardena.es

Sweden

GARDENA
Husqvarna Consumer Outdoor
Products
Försäljningskontor Sverige
Box 9003
200 39 Malmö
info@gardena.se

Switzerland / Schweiz

GARDENA Schweiz AG
Consumer Products
Industriestrasse 10
5506 Mägenwil
Phone: (+41) (0) 848 800 464
info@gardena.ch

Turkey

GARDENA / Dost Diş Ticaret
Müessesilik A.Ş. Sanayi
Çad. Adil Sokak No. 1
Kartal - Istanbul
Phone: (+90) 216 38 93 939
info@gardena-dost.com.tr

Ukraine / Україна

ТОВ «ГАРДЕНА УКРАЇНА»
Васильківська, 34, 204-Г
03022, Київ
Тел. (+38 044) 498 39 02
info@gardena.ua

1559-29.960.03/1208
© GARDENA
Manufacturing GmbH
D-89070 Ulm
http://www.gardena.com

Free Manuals Download Website

<http://myh66.com>

<http://usermanuals.us>

<http://www.somanuals.com>

<http://www.4manuals.cc>

<http://www.manual-lib.com>

<http://www.404manual.com>

<http://www.luxmanual.com>

<http://aubethermostatmanual.com>

Golf course search by state

<http://golfingnear.com>

Email search by domain

<http://emailbydomain.com>

Auto manuals search

<http://auto.somanuals.com>

TV manuals search

<http://tv.somanuals.com>