



SERVICE MANUAL

INDUCTION COOKERS WITH RTCS TECHNOLOGY (REAL TIME TEMPERATURE CONTROL SYSTEM) COUNTER TOP/BUILT IN/WOK MODELS



IMPORTANT NOTE:

INDUCTION COOKERS MANUFACTURED WITH RTCS TECHNOLOGY WILL HAVE FIVE DIGITS IN THE CENTER OF THE SERIAL NUMBER: EXAMPLE: BA06.00001.0505

MODELS

GIU 1.5 (BH/BA 1500)

GIU 1.8 (BH/BA 1800)

GIU 2.5 (BH/BA 2500)

GIU 3.5 (SH/BA 3500)

GIU 5.0 (SH/BA 5000)

GIU 2.5 BI (BH/IN 2500)

GIU 3.5 BI (SH/IN 3500)

GIU 5.0 BI (SH/IN 5000)

GIWOK 3.5 (SH/WO 3500)

GIWOK 5.0 (SH/WO 5000)

GIWOK 3.5 BI (SH/WO/IN 3500)

GIWOK 5.0 BI (SH/WO/IN 5000)

GARLAND COMMERCIAL INDUSTRIES
185 East South Street
Freeland, Pennsylvania 18224
Phone: (570) 636-1000
Fax: (570) 636-3903

GARLAND COMMERCIAL RANGES, LTD.
1177 Kamato Road, Mississauga, Ontario L4W 1X4
CANADA
Phone: 905-624-0260
Fax: 905-624-5669

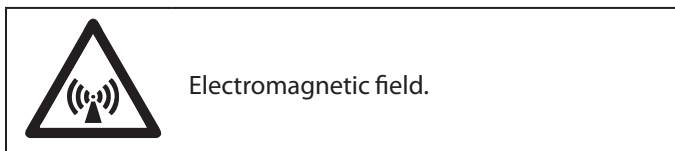
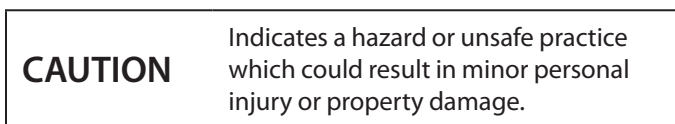
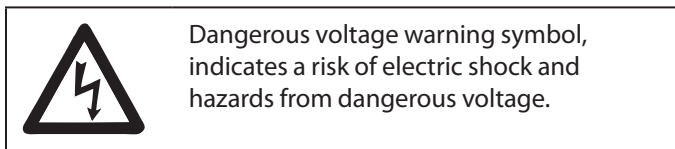
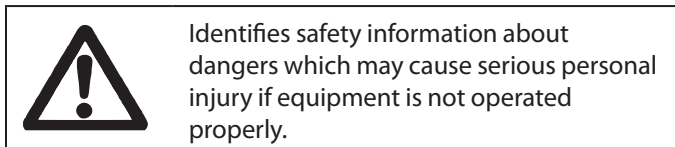
Enodis UK LTD.
Swallowfield Way, Hayes, Middlesex UB3 1DQ ENGLAND
Telephone: 081-561-0433
Fax: 081-848-0041

TABLE OF CONTENTS

SECTION 1 –SAFETY	3
Description Of Warning Signs	3
Personnel Qualification And Training	3
Safety Information, Installation And Service.....	3
Unauthorized Reconstruction And Use Of Spare Parts.....	3
Improper Operating Methods	3
SECTION 2 – TECHNICAL INFORMATION	4
SECTION 3 – OPERATION	5
Adjusting The Performance Rate	5
Temperature Check	5
Protection Overload Current	5
SECTION 4 – TESTS	6
Pan Material For Induction Cookers.....	6
Pan Detection	6
Test With Pans	6
Test With Metallic Plates	6
Power Rating	7
Fan	7
Test Of The Components	7
Rectifier	7
Transistor module (IGBT)	8
CU (RTCS) Sensors	8
Potentiometer	8
SECTION 5 – MAINTENANCE/SERVICE	9
SECTION 6 – FAULT FINDING	12
General Information	12
Error Messages.....	12
Flow chart to fault finding.....	14
SECTION 7 – EXCHANGE OF SPARE PARTS	15
To Open The Induction Unit (Counter Top Models)	15
To Open The Induction Unit (Built In Models)	15
SECTION 8 – ADJUSTMENT OF PROCESS PARAMETERS	15
Initializing CU Sensors By The Short Circuit Plug.....	15
Initializing The Induction Unit By PC Or Laptop	16
Change Of The Parameters	16
Parameters For (Mains) Power Current And Pan Detector	18
SECTION 9 – IR (INFRARED) INTERFACE	19
SECTION 10 – WIRING BLOCK SCHEMATIC	22

SECTION 1 –SAFETY

Description Of Warning Signs



Warning signs mounted directly on the cooker must be observed at all times and kept in a fully legible condition.

Personnel Qualification And Training

All persons involved in assembly, installation, commissioning, operation and maintenance must have the appropriate qualifications. The scope of responsibility, competence and supervision of the staff must be defined and controlled.

Safety Information, Installation And Service

Operators of the equipment must ensure that all installation, service and as well as all inspections, are performed by authorized and qualified personnel. Before attempting to operate the equipment carefully read the information and instructions outlined in the "Installations and Operating" manual. For all installations, service, maintenance, repair and or overhaul of the induction cookers, personnel must be specially qualified and must have attended a technical training course authorized by Garland.

Do not attempt to perform any repairs or replace any part of the induction cooker unless, all power supply to the cooker has been disconnected.

Unauthorized Reconstruction And Use Of Spare Parts

Reconstruction of the cooker or changes to the cooker are not allowed. Contact the manufacturer if you intend to do any changes to the cooker. To guarantee safety, use only genuine OEM spare parts and accessories, authorized by the manufacturer. Garland will not be held liable for any damage or injury caused by used of other components.

Improper Operating Methods

The operating reliability of the cookers can only be guaranteed when the cooker is used appropriately. The limit values stated in this manual must not be exceeded.

SECTION 2 – TECHNICAL INFORMATION

Model BH/BA (Counter models)	120 V/1 Ph	208 V/1 Ph	240 V/1 Ph
Wattage kW	1.5/1.8 kW	2.5/3.5 kW	2.5/3.5 kW
Current A	12.5/15	12/14.5/17	10/12.5/14.5
Power factor Cos φ	>0.95	>0.95	>0.95
Discharge rate mA	4	4	4
Ø Coil mm	190 (7.5")	190 (7.5")	190 (7.5")

Model BH/IN (Counter Models)	208 V/1 Ph	240 V/1 Ph
Wattage kW	2.5 kW	2.5 kW
Current A	12	10
Power factor Cos φ	>0.95	>0.95
Discharge rate mA	4	4
Ø Coil mm	190 (7.5")	190 (7.5")

Model SH/BA (Counter Models)	208 V/1 Ph	240 V/1 Ph	208 V/3 Ph
Wattage kW	3.5 kW	3.5 kW	5 kW
Current A	max. 16	14.5	max. 16
Power factor Cos φ	>0.95	>0.95	>0.95
Discharge rate mA	4	4	4
Ø Coil mm	190 (7.5")	190 (7.5")	190 (7.5")

Model SH/IN (Built in Models)	208 V/1 Ph	240 V/1 Ph	208 V/3 Ph
Wattage kW	3.5 kW	3.5 kW	5 kW
Current A	max. 16	14.5	max. 16
Power factor Cos φ	>0.95	>0.95	>0.95
Discharge rate mA	4	4	4
Ø Coil mm	190 (7.5")	190 (7.5")	190 (7.5")

Model SH/WO (Counter Wok Models)	208 V/1 Ph	240 V/1 Ph	208 V/3 Ph
Wattage kW	3.5 kW	3.5 kW	5 kW
Current A	max. 16	14.5	max. 16
Power factor Cos φ	>0.95	>0.95	>0.95
Discharge rate mA	4	4	4
Ø Coil mm	190 (7.5")	190 (7.5")	190 (7.5")

Model SH/WO/IN (Built in Wok Models)	208 V/1 Ph	240 V/1 Ph	208 V/3 Ph
Wattage kW	3.5 kW	3.5 kW	5 kW
Current A	max. 16	14.5	max. 16
Power factor Cos φ	>0.95	>0.95	>0.95
Discharge rate mA	4	4	4
Ø Coil mm	190 (7.5")	190 (7.5")	190 (7.5")

Maximum tolerance of power supply	Nominal voltage +6/-10 %
Frequency	50/60 Hz
Protection class	IP X0
Min. diameter of pans	Approx. 12 cm (4.7")
Max. ambient temperature: stockage	-20°C to 70°C (-4°F to 158°F)
Max. ambient temperature: function	-5 °C to 40°C (23°F to 104 °F)
Max. relative humidity of air: stockage	10 to 90 %
Max. relative humidity of air: function	30 to 90 %

SECTION 3 – OPERATION

Adjusting The Performance Rate

The performance rate is adjusted by the potentiometer (control knob). The inductive performance depends on the position of the potentiometer:

- Position 1 = minimum power.
- Position 9 (resp. Position 12) = maximum power.

Temperature Check

Induction coil

The temperature of the induction coil is checked by a temperature sensor. If the coil is heated over the maximum temperature, the heating process stops. As soon as the coil has cooled down, the Induction unit can be re-started. Turn the position of the control knob to "0" and then to the required power level (See Error Message, Section 6).

Power board

The temperature of the power board is checked by a temperature sensor. As soon as the heat sink is heated over 70°C (158°F), a cooling fan starts. A heat sink temperature of more than 80°C (176°F) automatically reduces the power in order to keep the induction cooker working under normal conditions. The internal temperature of the unit is supervised as well. The power is reduced by 50% if the temperature reaches 75°C (167°F). As soon as the temperature reaches 90°C (194°F) the unit stops working and shows the error code "E06" (See Error message, Section 6).

Protection Overload Current

When inappropriate pan material or magnetic objects are detected on the heating area, the current in the induction coil may raise excessively. In order to protect the power board, the coil current is checked and as soon as the current in the coil exceeds the maximum tolerance, the generator stops and there is no further active energy exchange. The unit can be re-started as soon as normal working conditions are reached.

SECTION 4 – TESTS

Pan Material For Induction Cookers

When cooking with induction it is very important to use the appropriate pan material. The bottom of the pan is the element that closes the magnetic field generated by the induction coil. We highly recommend only appropriate induction pans be used with this equipment.

A quick test can be performed to determine if a pan is appropriate. For this test you will need 1- Liter (34 ounces) of water at a temperature of 20°C (68°F). Heat up the pan with the cooker set to maximum power and measure the time it takes for the water to boil. Compare your time that referenced by Garland: (2.5kW → approx. 240 sec., 3.5kW → approx. 140 sec., 5kW → approx. 80 sec., 8kW → approx. 60 sec.). This heat-up time gives you information regarding the efficiency of the pan tested. Bad pans have considerably longer heating-up times for the same quantity of water.

A magnet can be used to determine whether the pan material is appropriate for induction cooking. The magnet must attach its self to the bottom of the pan. Please note, this magnet test will not determine the material structure of the pan or its efficiency. In some cases the magnet will attach itself to the bottom of the pan however, the pan may not be suitable for use with induction cooking. Always use pans which are suitable and designed for induction cooking.

Pan Detection

ATTENTION

The heating area is warmed up by the hot pan. To avoid injuries (burns) do not touch the heating area.

These tests show whether the induction cooker is operating correctly when small diameter pans are used and, when small metallic objects are heated-up on the heating area.

This test will require the following material:

An appropriate pan with a bottom diameter of 12cm (4.7") or two untreated round iron plates, approximately 4mm (0.16") thick:

- iron plate 1: diameter d = 12 cm (4.7")
- iron plate 2: diameter d = 7 cm (2.75")

Test With Pans

Step	Action	Level	Result
1	Place the pan in the middle of the heating area	1...9 (12)	Heat, the indicator lights
2	Push the pan until the edge of the pan is in the middle of the heating area	1...9 (12)	No heating, the indicator does not light

Test With Metallic Plates

Step	Action	Level	Result
1	Place the metallic plate 1 in the middle of the heating area	1...9 (12)	Heat, the indicator lights
2	Place the metallic plate 2 in the middle of the heating area	1...9 (12)	No heating, the indicator does not light

Power Rating

ATTENTION	The heating area is warmed up by the hot pan. To avoid injuries (burns) do not touch the heating area.
------------------	--

Step	Action	Level	Result
1	Place the pan on the heating area until water is boiling	9 (12)	Heat, water is boiling
2	Reduce the power by turning slowly the control knob	(12) 9...1	Heat rating reduces (water does not boil anymore), phase current reduces continuously

Fan

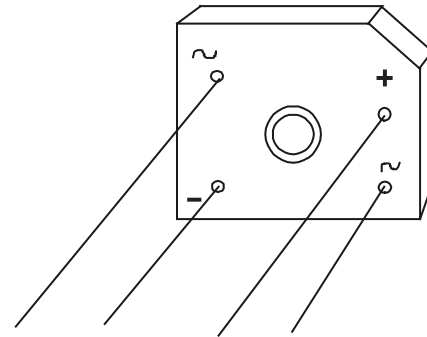
With this test, the fan observation as well as the degree of soiling is verified. At the beginning of the test, the induction cooker should be cold. You need a pan with a bottom diameter of 28 cm (11").

Step	Action	Level	Result
1	Place a pan on the heating area and fill it up with 1-Liter or (34 oz) of water	9 (12)	Heat
2	Measure the time until the fan starts working	9 (12)	The fan should start working after 6-8 minutes
3	Go on cooking for about 30 minutes	9 (12)	The heating process may periodically be interrupted for a period of 2 seconds. Unit keeps working.
4	Stop the induction cooker	0	The fan keeps working.

Test Of The Components

CAUTION	The power cord must be disconnected from the power supply.
----------------	--

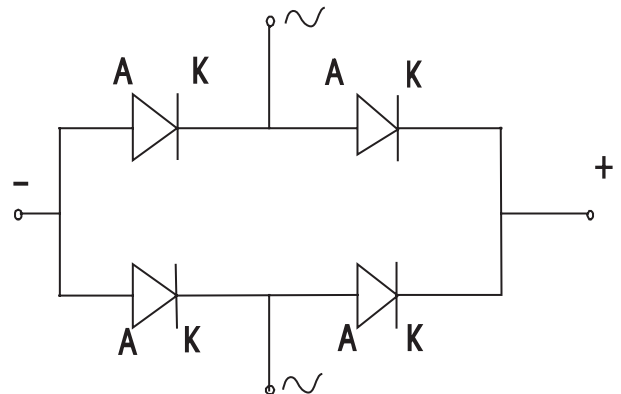
Rectifier



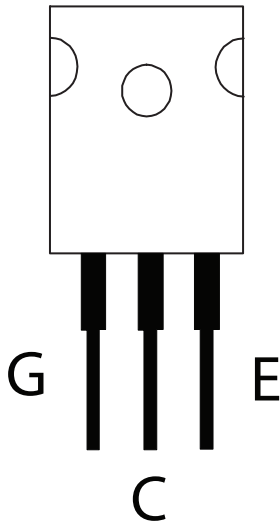
The rectifier is fixed at the power board with four wires. Rectifier connections must be unsoldered for correct test results. To begin, you have to measure the forward voltage between anode – cathode by means of the multimeter (please use only multimeters with diode check as an additional function).

The forward voltage for this diode is of about 0.5VDC in direction **A – K**, in the opposite direction is "NO" current flow.

If one of the four diodes shows a short circuit or an interruption, the rectifier is defective and must be replaced.



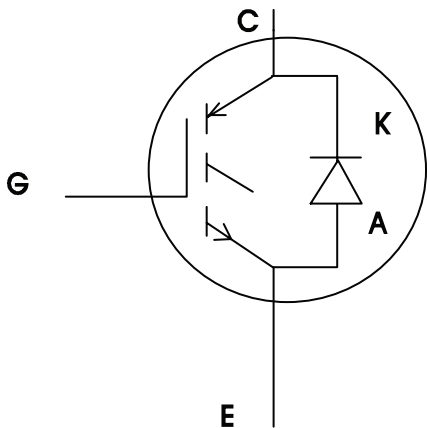
Transistor module (IGBT)



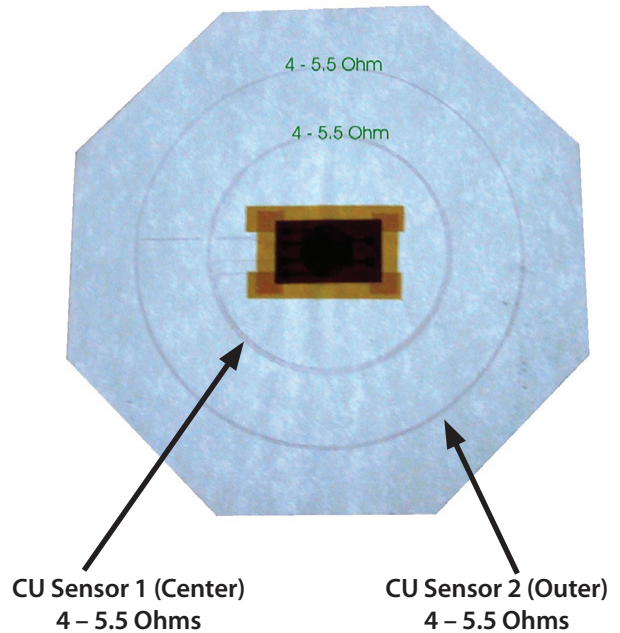
The IGBT (**I**nsulated **G**ate **B**ipolar **T**ransistor) is fixed onto the power print (board) with three solder connections.

The IGBT Transistor has as a supplementary protection an integrated recovery diode. To begin, measure the on-state voltage of this diode. The forward voltage of this diode is approximately **0.5VDC**.

If the recovery diode shows a short circuit or an interruption, the IGBT transistor is defective and must be replaced.



CU (RTCS) Sensors

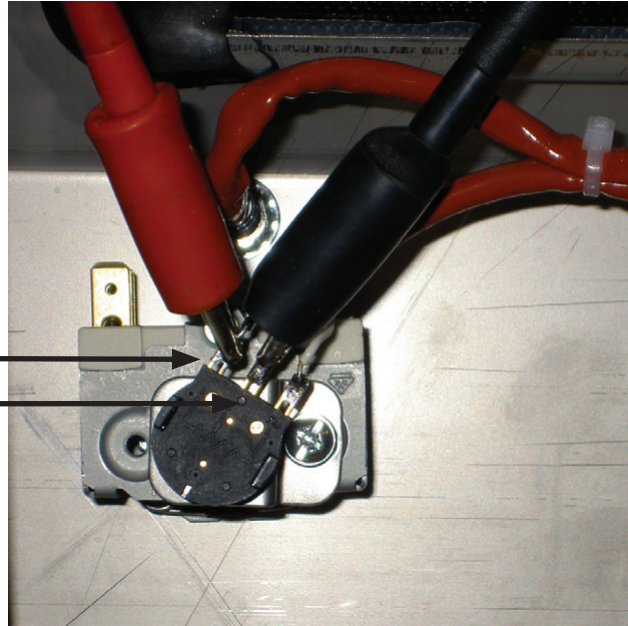


The two CU sensors are mounted directly on top of the coil for base-line, (counter top) cookers. Both the center and outer sensors, will measure approximately 4 - 5.5 Ohms.

Potentiometer

The potentiometer is mounted onto the main power switch. On setting "0" the reading will be 0 - Ohms and on the maximum level, the resistor will read 10kOhm (10,000 Ohms). Resistor is proportional (linear) to swing angle. (see following photo for measurement points).

Measurements taken across points shown.



SECTION 5 – MAINTENANCE/SERVICE

Maintenance work must only be completed by authorized personnel. Before beginning any maintenance work, ensure that all power supply is disconnected and the appliance has had an opportunity, to cool down. It is important that the following maintenance procedures be performed as recommended. Such preventative maintenance measures will extend the life of this equipment and will provide trouble free operation. The length of time used each and the use frequency will determine how often maintenance is required. Every cooker must be checked at least once a year. The following routine maintenance should and must be completed periodically.

Fan

Function of the cooker can only be guaranteed if all electronic components are operated within their normal working conditions (temperatures).

- The air inlet and air outlet slots must not be blocked.
- The air filter must not be blocked by dirt or grease.

- The airducts must be free of dirt.
- The air must circulate unhindered through the heat sink (no hindrance).
- The fan is correctly installed and in good operation.
- The heat sinks are installed correctly and in place.

Check Induction coil

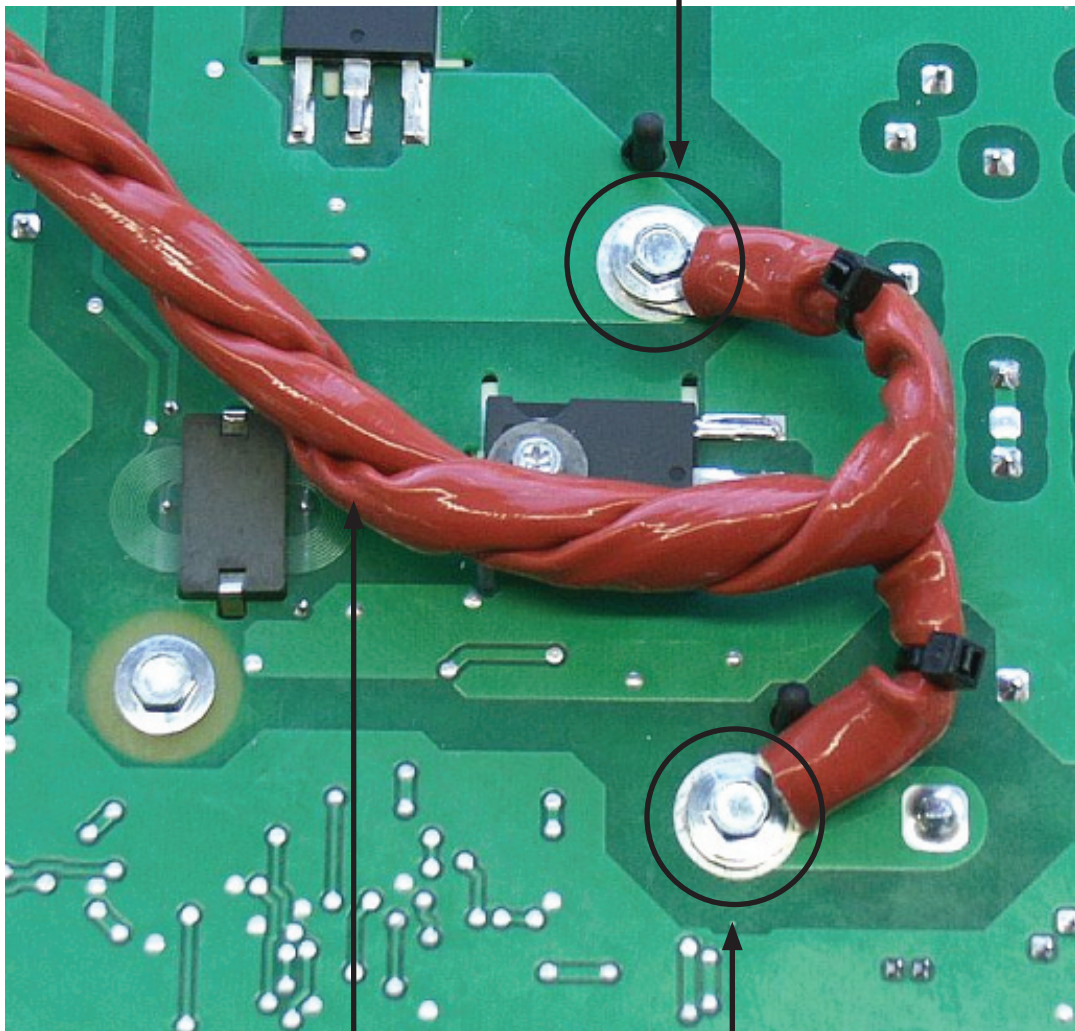
- Mechanical, screw mountings (screws all tightened)?
- Coil adhesive (coil wire in place o.k.)?
- Ferrites (all mounted and in place o.k.)?
- Copper coil (wire in place o.k.)?
- Coil connections to power board ok? (Refer to the following Figures #1 and #2 for correct and incorrect, coil connections).

General Checks

- Protection connection grounded?
- Screwed connections all tight?
- Isolations of cables?
- Any kind of liquids that have entered the cooker?
- Dirt in the cooker?

Figure # 1 - Correct Coil (Spoil) Connection

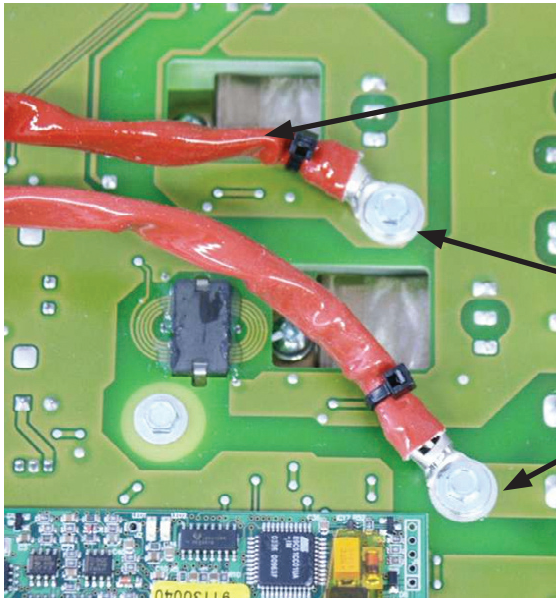
This connection must be well insulated and slightly bent upwards so the terminal end, does not make contact with the high voltage section on the power board.



Coil wires must be tightly twisted together and precisely placed.

Coil terminals must be connected in the direction shown in photo.

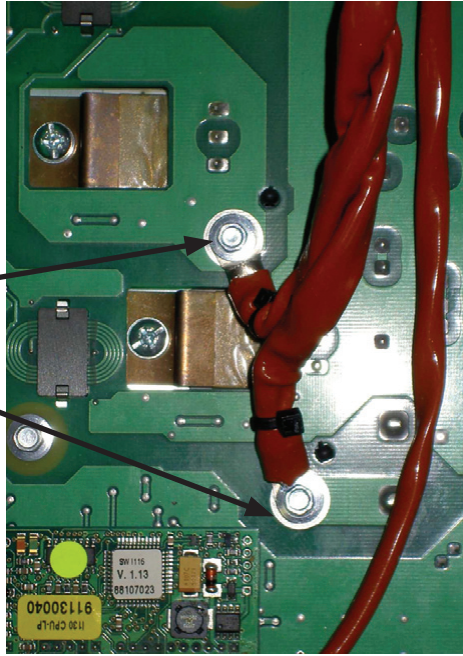
Figure # 2 – Examples of Incorrect Coil (Spoil) Connections



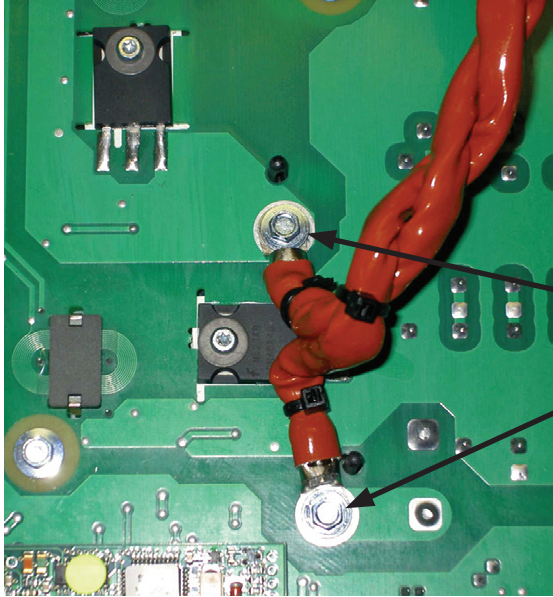
Coil wires not twisted tightly together or precisely placed.

Coil terminals connected in the incorrect direction.

Coil terminals connected in the incorrect direction.



Coil terminals connected in the incorrect direction.



SECTION 6 – FAULT FINDING

General Information

CAUTION Do not attempt to open the cooker when it is connected to the power supply. Dangerous high voltage components will be exposed!

The induction cooker may only be serviced by authorized service personnel.

Should the (Ceran Glass) become broken or cracked, turn off the cooker immediately and disconnect the electrical power supply to the unit. Do not touch any parts inside the cooker.

Before replacing a part, check the wiring. Pay close attention to the following faults:

- Broken cables
- Squeezed cables
- Defective isolations of cables
- Bad soldering joints

You must not attempt to do any repairs on the circuit boards. It is important, however to do routine maintenance after every repair see Section 5 Maintenance/Service for details.

Error Messages

Order of error message for error code 1-8:

The indicator lamp located directly above the control knob flashes for an interval of 0.6 seconds. The number of the following short flashes have to be counted in order to determine the type of failure. These flashes will inform you about the kind of error or failure, corresponding to the code system below.

Number Of Flashing Signals Error Code	Significance (Asterisk Refers To Notes At End Of Chart)	Measures To Take
3 -...-...-	Temperature heat sink***	a. Heat sink temperature too high – wait until the temperature has cooled down under 40°C/104°F b. Check supply of cooling air – perhaps blocked – check function of fan c. Check temperature of heat sink – replace power circuit.
4 -...-...-	Temperature cooking surface***	a. Temperature of the cooking surface too high b. Check CU measure coil – index value at 20°C (68°F) – approx. 5 - Ohms
6 -.....-.....-.....	Temperature inside the unit too high ***	a. Check whether the unit is next to a source of heat ex: fryer, broiler etc. b. Check whether hot air is taken in – generator has no air exhaust system
7 -.....-.....-.....	Empty cooking sensor*	a. Check cooking material in the pan

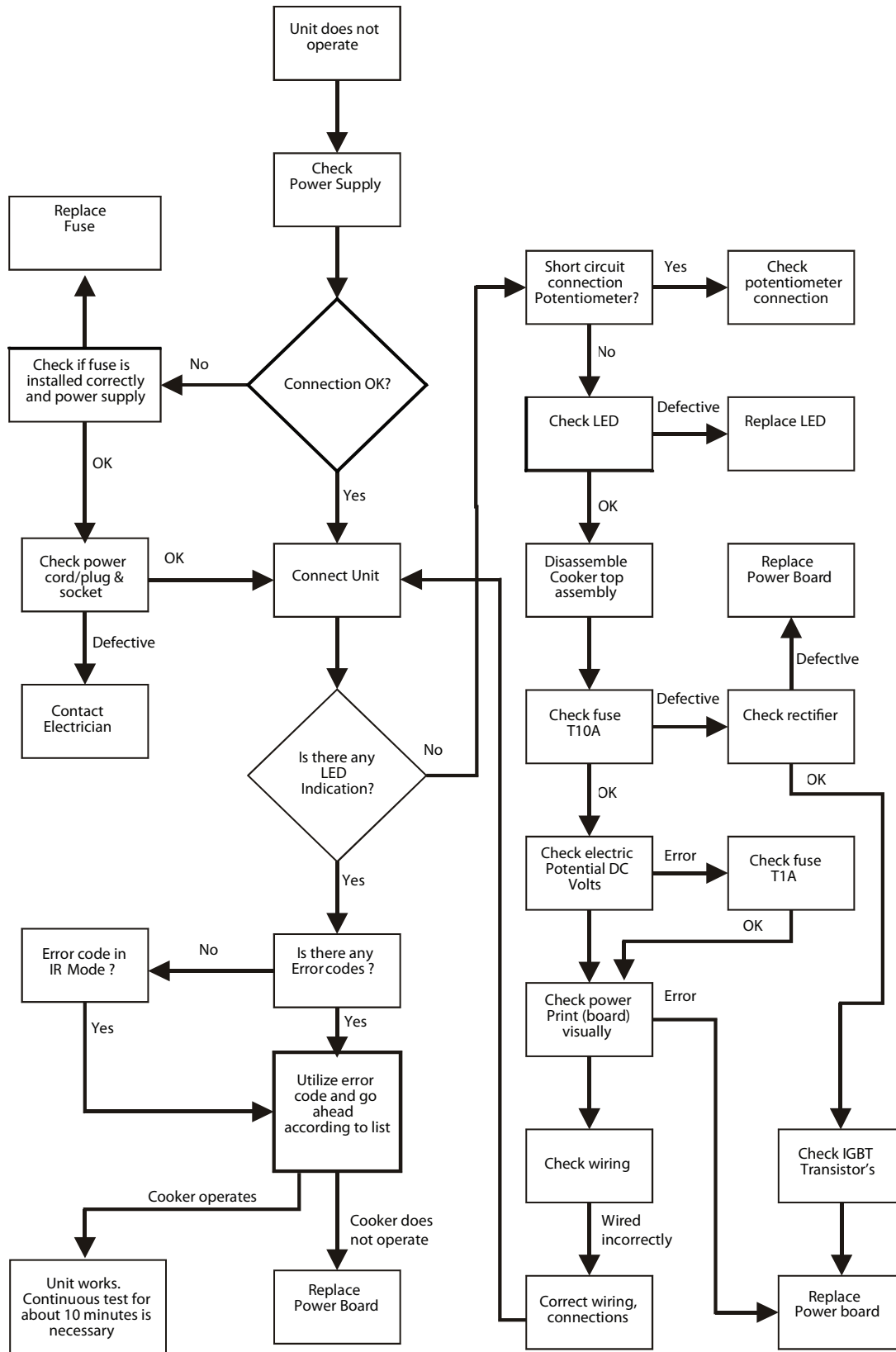
Number Of Flashing Signals Error Code	Significance (Asterisk Refers To Notes At End Of Chart)	Measures To Take
8 -.....-.....-.....	Sensor error***	a. Check Cu coil b. Check heat sink sensor c. Check RTCS-sensor d. Check board sensor
12	Power reduction, heat sink temperature **	a. Turn the power level down b. Check fan
13	Power reduction, temperature of cooking surface ** CU sensor 1 Warning temperature	a. Take pan off until cooking area has cooled down b. Wait until it has cooled down c. Check coil
17	CU sensor 1 over temperature ***	a. Temperature of the cooking field too high b. Check CU sensor 1, index value 5 -Ohms at 25°C (77°F)
18	CU sensor 2 over temperature ***	a. Temperature of the cooking field too high b. Check CU sensor 2, index value 5 -Ohms at 25°C (77°F)
19	CU sensor 2, high temperature warning	a. Temperature of the cooking field too high b. Turn the power down
20	Power reduction generator inside temperature **	a. Check for heat sources around the generator and remove them if any b. Check air circulation
21	Heat sink sensor error ***	a. Contact the factory
24	Board temp. sensor error ***	a. Exchange power unit
25	CU sensor 1 error ***	a. Check CU sensor 1 for short circuit or discontinuation, index value 5 Ohms at 25°C (77°F).
26	CU Sensor 2 error ***	a. Check CU sensor 2 for short circuit or discontinuation, index value 5 Ohms at 25°C (77°F)
27	Empty cooking detector CU sensor 1 *	a. Check cooking material in the pan
28	Empty cooking detector CU sensor 2 **	a. Check cooking material in the pan

* The induction unit can only be restarted by turning the control knob first to the "OFF" position, and then back to the "ON" position to reset.

** The induction unit continues working

*** The induction unit does not heat.

Flow chart to fault finding



SECTION 7 – EXCHANGE OF SPARE PARTS

CAUTION All spare parts and or accessories, may only be replaced by authorized service personnel.

CAUTION In order to guarantee safety, use only genuine OEM spare parts and accessories purchased directly from a Garland authorized part/service distributor. If other components are used, no liability will be accepted.

CAUTION The electrical supply must be disconnected.

To Open The Induction Unit (Counter Top Models)

- Turn the induction unit.
- Remove M4x8 screws.

- Turn induction unit back in normal position.
- Lift cover, turn away at the right side, put it at the side panel.
- Remove coil carrier: remove 2 stop nuts at the left.
- Remove M4 screws.
- Remove screws A1 and A2.
- Turn away coil carrier at the left.

To Open The Induction Unit (Built In Models)

- Remove M4 screws on the right side.
- Lift cover with the glass.
- Remove M4 screws, remove coil carrier.
- Remove PT-sensor and coil connections.

SECTION 8 – ADJUSTMENT OF PROCESS PARAMETERS

The induction unit (excluding all WOK-units) with new Cu sensors can be adjusted. This can be done either by means of the short circuit service plug (Poti-LED) part number (94900096) or by PC/Laptop. In addition, the pan detection and the power performance, can be adjusted by the hyperterminal program of the PC/Laptop. Please refer to Section 9 "IR Interface" for instructions on how to use the hyperterminal program.

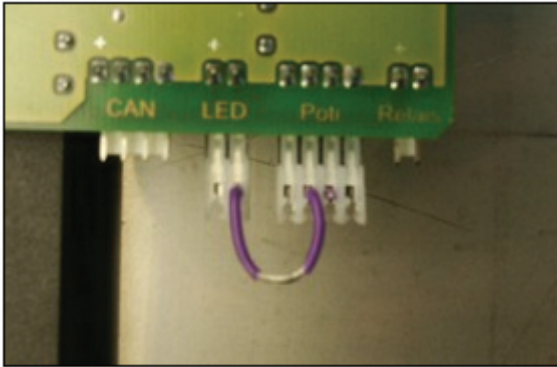
Initializing CU Sensors By The Short Circuit Plug

If only the CU sensor is exchanged, the new CU sensor can be initialized by means of the short circuit service plug (Poti-LED). For this, you will not need the PC or Laptop. The pan detection and the performance will not have to be changed.

Procedure of Initialization:

- The cooking area must be clear of any items.
- Surrounding temperature 25°C (+/- 3°C) or 77°F (+/- 37.4°F).
- Disconnect the induction unit from the main power supply.

- Place short circuit service plug into the power print board across the (Poti-LED) as showed in the photo below.



- Connect the induction unit to the main power supply.
- The CU sensors initialize automatically.
- After successful initialization, the green LED on the small CPU-print (board) illuminates.
- In case the system finds an error during initialization, the red LED will illuminate.
- Disconnect the induction unit from the main power supply.
- Check the CU sensors at the plug by means of the Ohm meter.
- Re-start the procedure of initialization.
- Disconnect the unit from the main power supply.
- Remove the short circuit service plug from both the Poti and LED connections.

Initializing The Induction Unit By PC Or Laptop

The initialization of the CU (RTCS) sensors (**excluding all WOK models**), as well as adjustments of the pan detection and power performance, can be performed by means of the hyperterminal program. Please refer to Section 9 "**IR Interface**" for instructions on how to use the hyperterminal program. The following adjustments must be done in the hyperterminal program: 2400bps, 8bit, no parity, 1 stop bit, hardware protocol.

IMPORTANT NOTE: When replacing the power board and or induction coil with RTCS sensors, you must reset all parameters.

IMPERATIVE! Pay close attention to whether you receive a feedback signal from the PC or Laptop after every change. This will be your signal that the change has been accepted successfully.

- 12345 Entry to the mode of adjustment (password)
- ; Initialize Cu sensor (temperature of the coil ca. 25°C/77°F) excluding WOK.
- N Increase the limit of the mains current (+)
- n Decrease the limit of the mains current (-)
- " Save the limit of the mains (power) current
- T Increase pan detector (+)
- t Decrease pan detector (-)
- = Save pan detector
- ? Leave the mode of adjustment
- . State software version

Change Of The Parameters

- Connect the RS232 connection cable to the PC/Laptop and straighten the IR-adapter to the left lower corner of the ceran glass. For counter top cookers, refer to Section (9) figure #3 for correct IR adapter positioning. For all Wok cookers, you will be required to remove the top wok bowl assembly. Place the IR-adapter in the left hand corner directly over the rectangular opening located on the metal sheet with ferrit stripes. Please refer to Section (9) figure #4 for Wok cooker IR adapter positioning.
- Start HT2400 (see chapter 9) and turn unit on!
- Input "12345" and the mode of adjustment will now begin. The following message will appear on the monitor:

IR= On
WELCOME REPAIRMEN

4. Not valid for WOK cookers. The parameters on the CPU can now be changed! The unit temperature and the ambient temperature must amount to 25°C (+/- 4°C) or 77°F (+/- 39°F). Press the key [;]. On the console appears the message “**please confirm**”. Press the key [;] again. The CU (RTCS) sensor will now be initialized on 25°C (77°F). The following message now appears on the monitor:

save CU sensor : 25°C

5. Set the limit of the (mains) power current. (see mains current parameters in this section):

- N increase the limit of the mains current (+)
- n decrease the limit of the mains current (-)

The following message appears on the monitor:

linecurrent limit=

6. Save the limit of the (mains) power current with the key ["]. On the console appears the message “**please confirm**”. Press the key ["] again. The following message appears on the monitor:

save linecurrent limit:

7. Set the pan detector (see pan detector, Section 4):

- T increase pan detector (+)
- t decrease pan detector (-)

The following message appears on the monitor:

pan detector limit=

8. Save the pan detector with the key [=]. On the console appears the message “**please confirm**”. Press the key [=] again. The following message appears on the monitor:

save pan detector limit:

9. By input [-?] the mode of adjustment will be left. The following message appears on the monitor:

see you again!

- 10 The mode for adjustment has a time-out function. After a 10 minute period, the mode of adjustment will automatically reset.

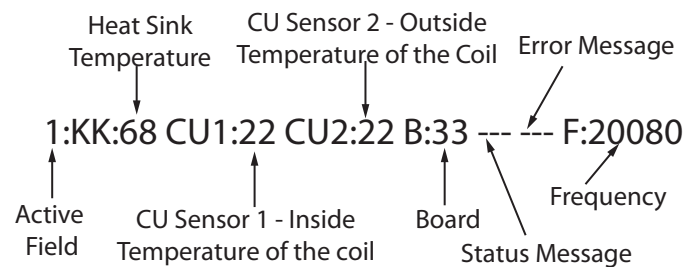
The adjustments are now completed and it is not possible to make any other adjustments at this point. If further adjustments are necessary, you will be required to start from the beginning again!

Technical information regarding the induction cooker is also available in real-time, in the clients mode. The following parameters listed below can be read:

Output on the hyperterminal:

```
1: KK:68 CU1:22 CU2:22 B:33 --- F:20080
1: KK:68 CU1:22 CU2:24 B:33 --- F:20080
1: KK:67 CU1:22 CU2:24 B:33 --- F:20080
1: KK:67 CU1:22 CU2:24 B:33 --- F:20080
```

Meaning:



The internal cooling fan will be activated once the heat sink temperature rises to 70°C (158°F).

Parameters For (Mains) Power Current And Pan Detector

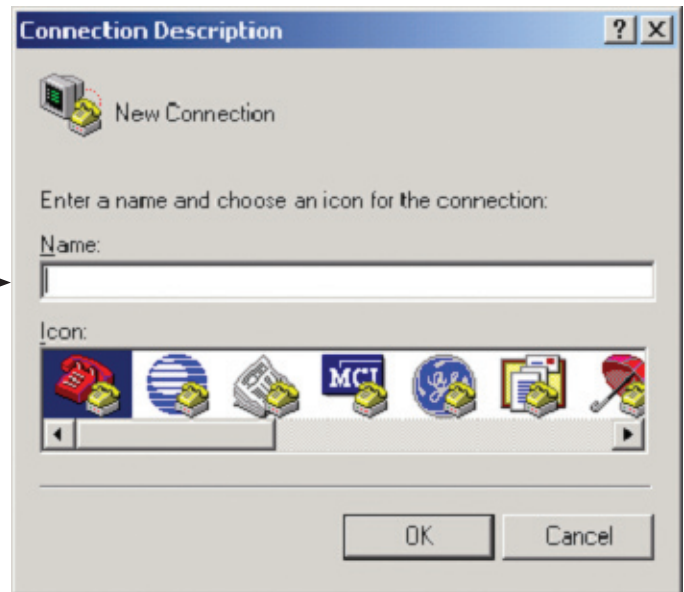
Item Number (Article No.)	Induction Cooker Model	Mains-Power Current	Pan Detector
99560101	BH/BA 1500, 120VAC, 1N, 1,5kW (GIU 1.5)	162	21
99560102	BH/BA 1800, 120VAC, 1N, 1,8kW (GIU 1.8)	187	21
99560103	BH/BA 2500, 208VAC, 1N, 2,5kW (GIU 2.5)	153	23
99560104	BH/BA 2500, 230VAC, 1N, 2,5kW (GIU 2.5)	140	27
99560105	BH/BA 2500, 240VAC, 1N, 2,5kW (GIU 2.5)	192	26
99560106	BH/BA 3000, 208VAC, 1N, 3kW (GIU 3.0)	180	26
99560107	BH/BA 3000, 230VAC, 1N, 3kW (GIU 3.0)	163	28
99560108	BH/BA 3000, 240VAC, 1N, 3kW (GIU 3.0)		
99560109	BH/BA 3500, 208VAC, 1N, 3,5kW (GIU 3.5)	192	26
99560110	BH/BA 3500, 230VAC, 1N, 3,5kW (GIU 3.5)	187	28
99560111	BH/BA 3500, 240VAC, 1N, 3,5kW (GIU 3.5)		
99560112	BH/BA 2300, 230VAC, 1N, 2,3kW (GIU 3.5)		
99580001	BH/IN 2500, 208VAC, 1N, 2,5kW (GIU 2.5BI)		
99580002	BH/IN 2500, 230VAC, 1N, 2,5kW (GIU 2.5BI)		
99580003	BH/IN 2500, 240VAC, 1N, 2,5kW (GIU 2.5BI)		
99560004	SH/BA 3500, 208VAC, 1N, 3,5kW (GIU 3.5)	192	36
99560005	SH/BA 3500, 230VAC, 1N, 3,5kW (GIU 3.5)	192	35
99560006	SH/BA 3500, 240VAC, 1N, 3,5kW (GIU 3.5)	185	23
99560007	SH/BA 5000, 208VAC, 3N, 5kW (GIU 5.0)	167	21
99560008	SH/BA 5000, 400VAC, 3N, 5kW (GIU 5.0)		
99560009	SH/BA 5000, 440VAC, 3N, 5kW (GIU 5.0)		
99580004	SH/IN 3500, 208VAC, 1N, 3,5kW (GIU 3.5BI)		
99580005	SH/IN 3500, 230VAC, 1N, 3,5kW (GIU 3.5BI)		
99580006	SH/IN 3500, 240VAC, 1N, 3,5kW (GIU 3.5BI)		
99580007	SH/IN 5000, 208VAC, 3N, 5kW (GIU 5.0BI)		
99580008	SH/IN 5000, 400VAC, 3N, 5kW (GIU 5.0BI)		
99580009	SH/IN 5000, 440VAC, 3N, 5kW (GIU 5.0BI)		
99570001	SH/VO 3500, 208VAC, 1N, 3,5kW (GIWOK 3.5)	192	29
99570002	SH/VO 3500, 230VAC, 1N, 3,5kW (GIWOK 3.5)	192	31
99570003	SH/VO 3500, 240VAC, 1N, 3,5kW (GIWOK 3.5)	185	41
99570004	SH/VO 5000, 208VAC, 3N, 5kW (GIWOK 5.0)	167	23
99570005	SH/VO 5000, 400VAC, 3N, 5kW (GIWOK 5.0)	90	11
99570006	SH/VO 5000, 440VAC, 3N, 5kW (GIWOK 5.0)	78	10
99570008	SH/VO 8000, 400VAC, 3N, 8kW (GIWOK 8.0)		
99580016	SH/VO/IN 3500, 208VAC, 1N, 3,5kW (GIWOK 3.5BI)	192	29
99580017	SH/VO/IN 3500, 230VAC, 1N, 3,5kW (GIWOK 3.5BI)	192	20
99580018	SH/VO/IN 3500, 240VAC, 1N, 3,5kW (GIWOK 3.5BI)	185	41
99580019	SH/VO/IN 5000, 208VAC, 3N, 5kW (GIWOK 5.0BI)	167	23
99580020	SH/VO/IN 5000, 400VAC, 3N, 5kW (GIWOK 5.0BI)		
99580021	SH/VO/IN 5000, 440VAC, 3N, 5kW (GIWOK 5.0BI)		
99580025	SH/VO/IN 8000, 400VAC, 3N, 8kW (GIWOK 8.0BI)	141	15

SECTION 9 – IR (INFRARED) INTERFACE

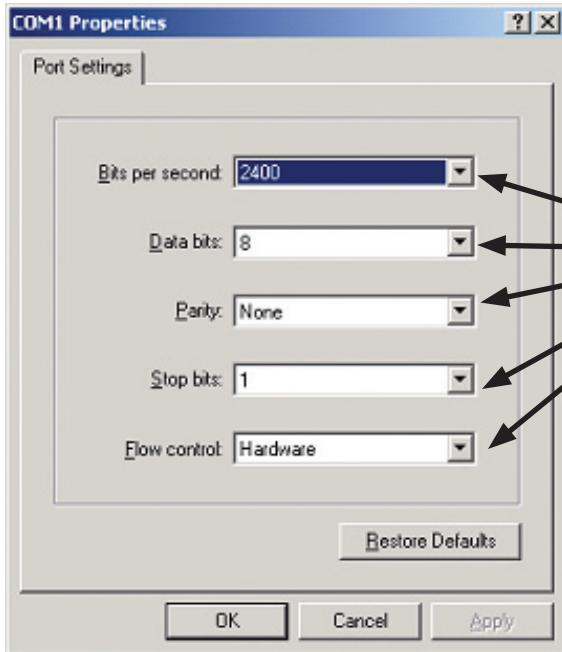
To begin the IR communication, you will need the HyperTerminal software which is available in Microsoft Windows under, **Start =>Program=>Accessories => HyperTerminal**. Prior to the first use, HyperTerminal should be configured properly. Garland service requires the following settings listed below: 2400bps, 8bit, no parity, 1 stop bit, hardware protocol.

First connect the IR adapter into your PC or laptop computer. Place the IR sensor section onto the ceran glass towards the bottom left hand corner for counter top cookers. Position the IR sensor to the generator. Refer to figure #3 in this section for correct positioning. For all Wok cookers, you will be required to first remove the top wok bowl assembly. Place the IR adapter into the left hand corner, directly over the rectangular opening located on the metal sheet with ferrit stripes. For Wok cookers please refer to figure #4 for IR adapter positioning.

Start HyperTerminal and put the access name, e. g. IR2400.ht.



Select the communication via COM1 (or where your IR adapter has been connected).



Select the following settings: 2400 Bits/sec., 8 Databits, no parity, 1 Stop bit, Hardware protocol.

Setting IR 2400.ht should be saved so that there will be no need to put them again and the connection can be built-up by selecting symbol IR2400.ht.

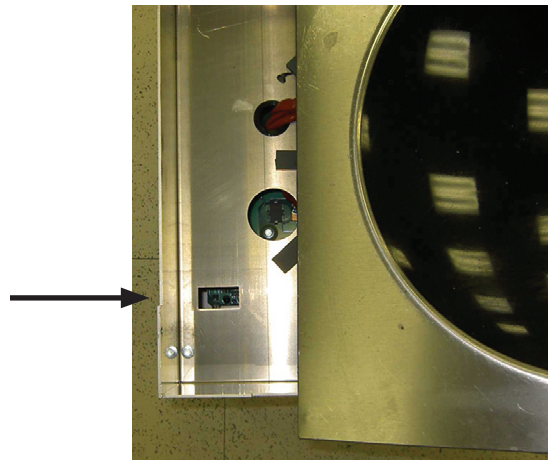
Figure # 3 – IR Adapter position for counter top (base-line) cookers

For all counter top induction cookers (excluding all WOK models), position the IR adapter tool to the lower left hand corner of the ceran glass as shown in photo.

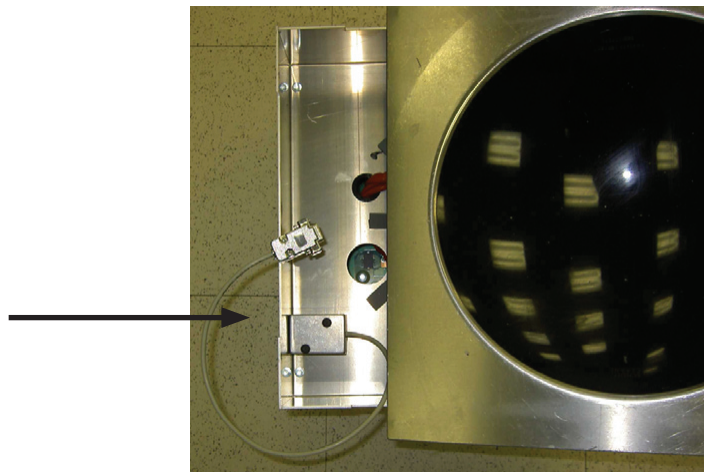


Figure # 4 – IR Adapter position for built-in (install-line) cookers

IR Adapter to be positioned directly over rectangular opening, shown in photo.



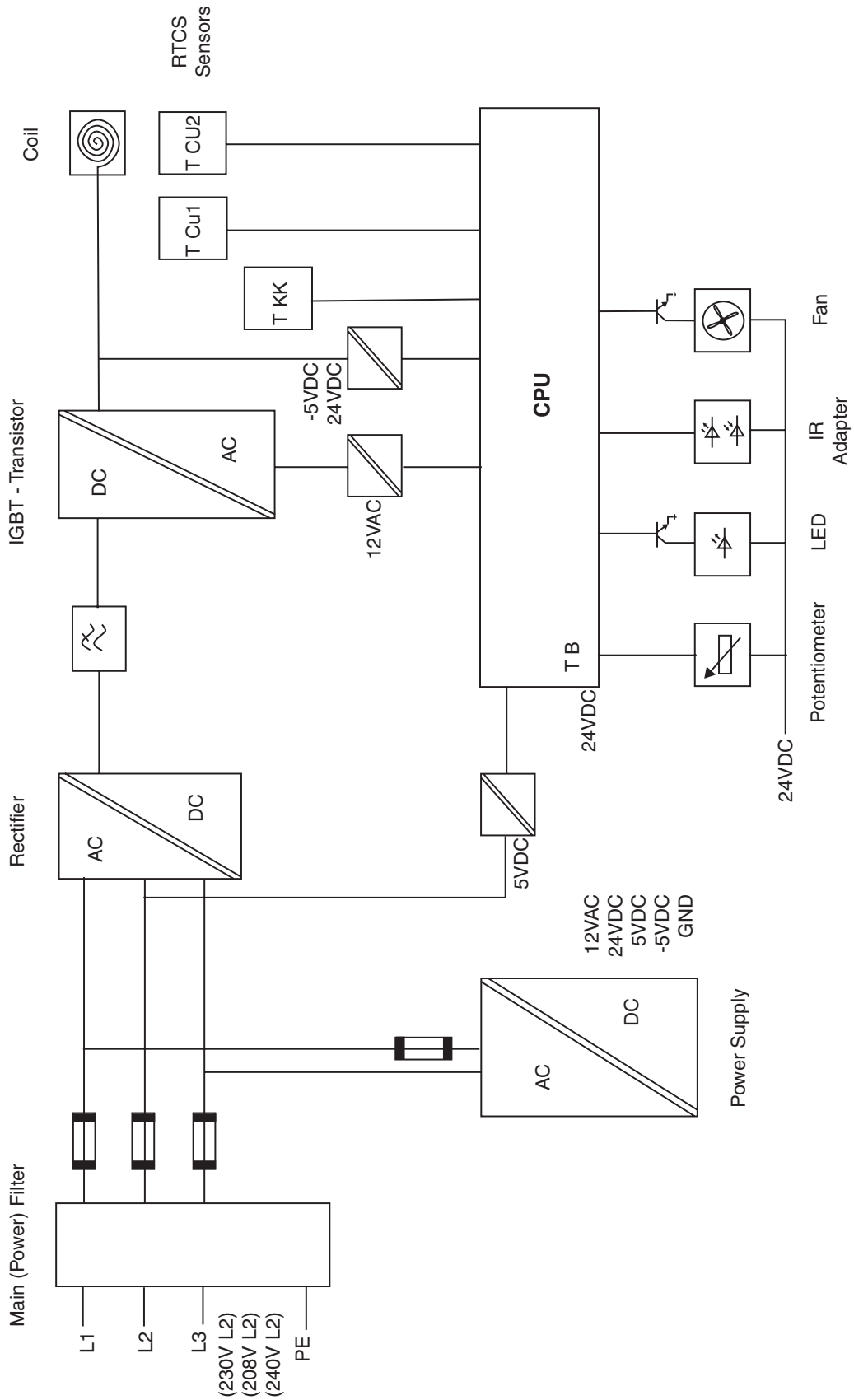
IR Adapter tool in position.



Place Wok Bowl top assembly back onto cooker as shown and, begin testing using IR adapter tool.



SECTION 10 – WIRING BLOCK SCHEMATIC





Free Manuals Download Website

<http://myh66.com>

<http://usermanuals.us>

<http://www.somanuals.com>

<http://www.4manuals.cc>

<http://www.manual-lib.com>

<http://www.404manual.com>

<http://www.luxmanual.com>

<http://aubethermostatmanual.com>

Golf course search by state

<http://golfingnear.com>

Email search by domain

<http://emailbydomain.com>

Auto manuals search

<http://auto.somanuals.com>

TV manuals search

<http://tv.somanuals.com>