



INSTALLATION AND OPERATION MANUAL

GARLAND INDUCTION SINGLE, MULTI-FUNCTIONAL TABLE TOP UNITS, MODELS: GMIU3.5 & GMIU5.5



FOR YOUR SAFETY:
DO NOT STORE OR USE GASOLINE
OR OTHER FLAMMABLE VAPORS OR
LIQUIDS IN THE VICINITY OF
THIS OR ANY OTHER
APPLIANCE

WARNING:
IMPROPER INSTALLATION, ADJUSTMENT,
ALTERATION, SERVICE OR MAINTENANCE
CAN CAUSE PROPERTY DAMAGE, INJURY,
OR DEATH. READ THE INSTALLATION,
OPERATING AND MAINTENANCE
INSTRUCTIONS THOROUGHLY
BEFORE INSTALLING OR
SERVICING THIS EQUIPMENT

CONFORMS TO UL-197 & NSF-4 CERTIFIED TO
CAN/CSA C22.2NO. 109 VDE EN60335-2-38.

PLEASE READ ALL SECTIONS OF THIS MANUAL
AND RETAIN FOR FUTURE REFERENCE.

THIS PRODUCT HAS BEEN CERTIFIED AS
COMMERCIAL COOKING EQUIPMENT AND
MUST BE INSTALLED BY PROFESSIONAL
PERSONNEL AS SPECIFIED.

INSTALLATION AND ELECTRICAL CONNECTION
MUST COMPLY WITH CURRENT CODES:
IN CANADA - THE CANADIAN ELECTRICAL
CODE PART 1 AND / OR LOCAL CODES.
IN USA - THE NATIONAL ELECTRICAL CODE
ANSI / NFPA - CURRENT EDITION.

Users are cautioned that maintenance and repairs must be performed by a Garland authorized service agent using genuine Garland replacement parts. Garland will have no obligation with respect to any product that has been improperly installed, adjusted, operated or not maintained in accordance with national and local codes or installation instructions provided with the product, or any product that has its serial number defaced, obliterated or removed, or which has been modified or repaired using unauthorized parts or by unauthorized service agents. For a list of authorized service agents, please refer to the Garland web site at <http://www.garland-group.com>. The information contained herein, (including design and parts specifications), may be superseded and is subject to change without notice.

GARLAND COMMERCIAL INDUSTRIES
185 East South Street
Freeland, Pennsylvania 18224
Phone: (570) 636-1000
Fax: (570) 636-3903

GARLAND COMMERCIAL RANGES, LTD.
1177 Kamato Road, Mississauga, Ontario L4W 1X4
CANADA
Phone: 905-624-0260
Fax: 905-624-5669

Enodis UK LTD.
Swallowfield Way, Hayes, Middlesex UB3 1DQ ENGLAND
Telephone: 081-561-0433
Fax: 081-848-0041

Part # 4520897 (01/31/08)

© 2004 Garland Commercial Industries, Inc.

TABLE OF CONTENTS

DIMENSIONS AND SPECIFICATIONS,	4
Operation And Control.....	5
Operation Conditions	5
INTRODUCTION.....	5
Application.....	5
Purpose of induction cookers.....	5
Description of products.....	5
INSTALLATION.....	6
Location.....	6
Installation Ambience.....	6
Clearances.....	6
Electrical Connections	6
OPERATION.....	7
Display	7
Function Test	7
Heating	8
Comfort	8
Cooking Process With Temperature Probe	8
Hold Function	8
Pan Detection	9
Control Of The Heating Area.....	9
Out Of Operation	9
SAFETY CONCERNS	9
Description Of Danger Signs	9
Safety Conscious Work.....	9
Operator/Operating Personnel Safety Information.....	9
Unauthorized Reconstruction And Use Of Spare Parts	10
TROUBLE SHOOTING.....	11
Error Messages	11
Troubling Shooting Guide.....	12
CLEANING AND SERVICING	13
Cleaning.....	13
Support	13

DIMENSIONS AND SPECIFICATIONS,

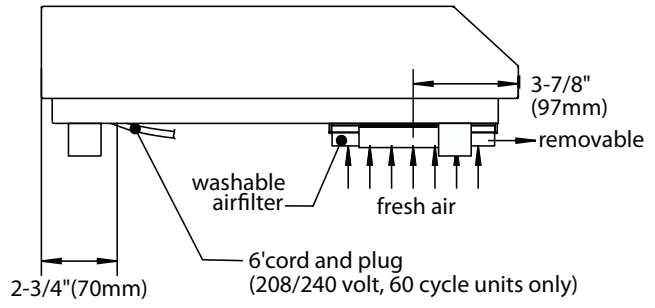
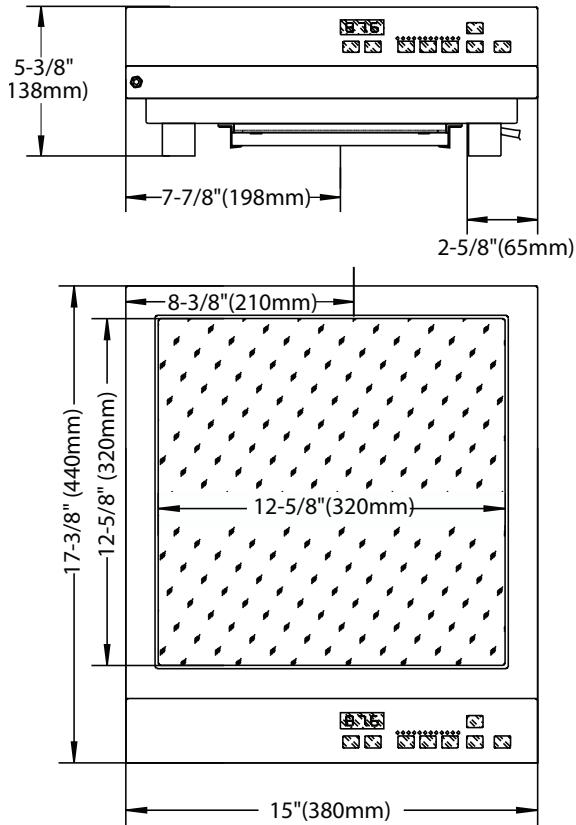

view A: exhaust

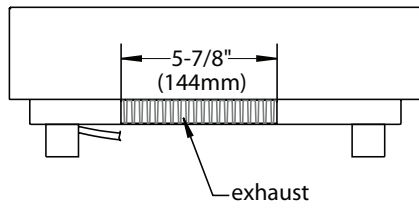

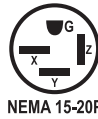
Plug Configurations:		
Model	Electrical Characteristics	Plug
GMUI-3.5	208V/60Hz/1Ø 240V/60Hz/1Ø	 NEMA 6-20P
GMUI-5.5	208V/60Hz/3Ø	 NEMA 15-20P

Electrical Loading:							
Model	Watts	208/60/1	208/60/3	240/60/1	230/50/1	400/50/3	440/60/3
GMIU-3.5	3500	16 amp	N/A	14 amp	15 amp	N/A	N/A
GMIU-5.5	5500	N/A	16 amp	N/A	N/A	9 amp	8 amp

DIMENSIONS AND SPECIFICATIONS, Continued

Operation And Control

Lamp operation 24V DC/max. 40mA (red)

Key pad and LED display

Operation Conditions

Max. Tolerance Of The Nominal Supply Voltage	+6/-10%
Supply Frequency	50/60 Hz
Protection Class	1P 43
Minimal Diameter Of The Pan	5" (127mm)

INTRODUCTION

Application

The following instructions contain information, which is fundamentally important and must be taken into account during assembly, operation and maintenance. They must therefore read very carefully before installation and operation by the responsible specialist staff and the operator(s). They must always be available for consultation at the place of operation.

Purpose of induction cookers

The Garland induction unit cookers are especially suitable as cookers in the kitchen and for the preparation of meals on the table. A cooker can be used for cooking, warming up, keeping warm, flambéing, roasting, etc. The cookers are to be used only with pans made of material which is suitable for induction. There are specific manufacturers who sell special types of pots and pans for induction cooking.

DO NOT use induction cookers to heat up any other metallic objects other than pots and pans provided for it.

Description of products

We manufacture several basic types of induction cookers with various performances and measurements. All are built to last; they are also compact and powerful with a revolutionary technology in a complete case of stainless steel. All of our accessories are designed to coordinate with the induction units and since each unit is equipped with continuous control, they allow efficient cooking.

Features include:

- Simple operation by key pad
- Power display with LED
- Compact powerful electronics enable flat construction and safe operation
- A maximum of safety thanks to multiple safety functions
- Short cooking time
- Electronic checking
- Compact measurement – light weight
- Meets all current standards: VDE EN 60335-1/-2/36, CE-conforming
- UL197; CAN/CSA/C22.2 No., 109, NSF 4-1996

INSTALLATION

Location

The cooker has to be set up on a stable place like a table. It requires an area of at least 400 x 480 mm (15.7" x 18.9"). The air inlet and air outlet must not be obstructed, the table must be able to withstand a loading of 40 kg (88 lbs). The cooker doesn't have to be fixed on the table. The key pad to operate the cooker must be easily accessible. It must be set up in such a way that it cannot fall down or move in an uneven position.

1. The induction unit is equipped with an additional grease filter. Make sure that the induction unit does not take is hot or grease laden air (concerns units standing side by side, or one behind the other, or standing near a frying pan or oven).
2. The induction unit must not be placed near or on a hot surface.
3. The air intake temperature must be under 104°F (40°C).
5. The operating staff has to make sure that installation, support and inspection is done by qualified personnel.

Installation Ambience

CONDITIONS	STORAGE	FUNCTION
Max. Ambient Temperature	> -4°F(-20°C) to 158°F(70°C)	> 41°F (5°C) to 104°F (40°C)
Max. Relative Humidity Of Air	> -10% to 90%	> 30% to 90%

Clearances

There is a minimum clearance of 1.6" (40mm) from the back wall.

This induction unit is equipped with an air cooling system. Make sure that the air supply and air exhaust are not blocked (wall, fabric etc).

Induction Unit Side View

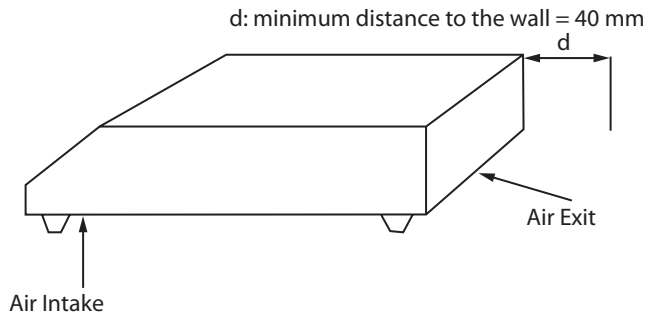

Electrical Connections

Push "OFF" on the key pad before connecting the cooker with the voltage supply.

The operator has to insure that all installation, maintenance and inspection work is carried out by authorized and qualified personnel.

1. Check and ensure that the supply voltage matches the voltage given on the specification plate.
2. The electrical connections must satisfy local house installation regulations. The valid national and local regulations must be observed.
3. The cooker is provided with a cord and plug (60 cycle units only).

OPERATION

Display

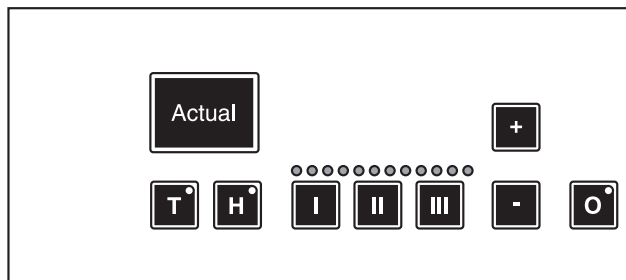

Actual = Is actual value

With use of an external temperature probe **+** / **-** the variables can be regulated infinitely.

T = Actual temperature key with use of the temperature probe,

H = Hold keeping warm facility.

I **II** **III** = Cooking level "low, mid and high", are preprogrammed, but can be changed individually by **+** / **-** keys.

O = On/Off key.

Function Test

Before carrying out function checks, the operator must know how to operate the cooker.

Induction Unit Surface View

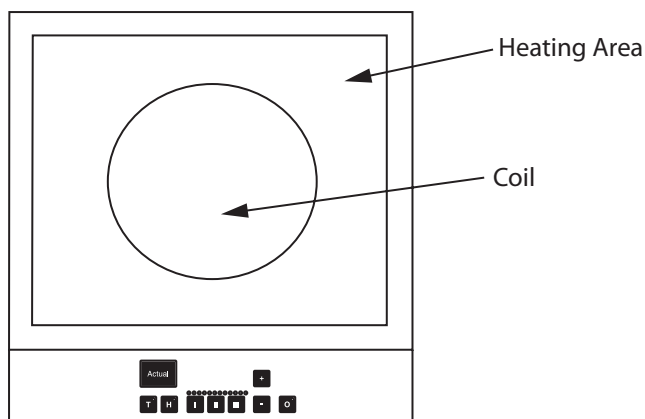

Your cooker must be positioned in a suitable place and connected to a voltage supply. Make sure the cooker is well positioned and free from exposure to vibration.

Make sure the unit is in the "OFF" position.

Remove all objects from the glass ceramic cooking zone, verify if this area is neither cracked not broken. Don't continue with use when the glass ceramic cooking zone is cracked or broken, immediately switch off and disconnect the cooker from the outlet.

CAUTION The glass ceramic cooking zone is warmed up from the heat of the pan. To avoid injuries (burning) do not touch this area.

Use a pan that is suitable for induction cooking, having a bottom diameter of at least 127 mm (5 inches).

1. Put some water in the pan and place the pan in the center of the heating area.
2. Push "ON" as well as a position between 1 and 12. The indicator will illuminate lights (red) and the water will be heated.
3. Take the pan away from the heating area, the indicator light will flash.
4. Place the pan back on the heating area, the indicator light will illuminate and the heating process will continue.
5. Push "OFF", the heating process will stop, indicator light turns off.

The shining indicator light operation means that energy is being transferred to the pan.

If the indicator operation remains off, check the following:



1. Is the cooker connected to the outlet?
2. Are the indicator lights "ON"?
3. Did you use a suitable pan (bottom diameter at least 127mm (5 inches), pan made of suitable material)?
4. Is the pan placed in the center of the heating area?

To verify if the pan is suitable, use a permanent magnet and find out if it sticks to the bottom of the pan. If not, your pan is not suitable for induction cooking. Choose a pan which is recommended for induction cooking.

If in spite of all positive controls and tests the cooker doesn't work, refer to the Trouble Shooting Section.

OPERATION Continued

Heating



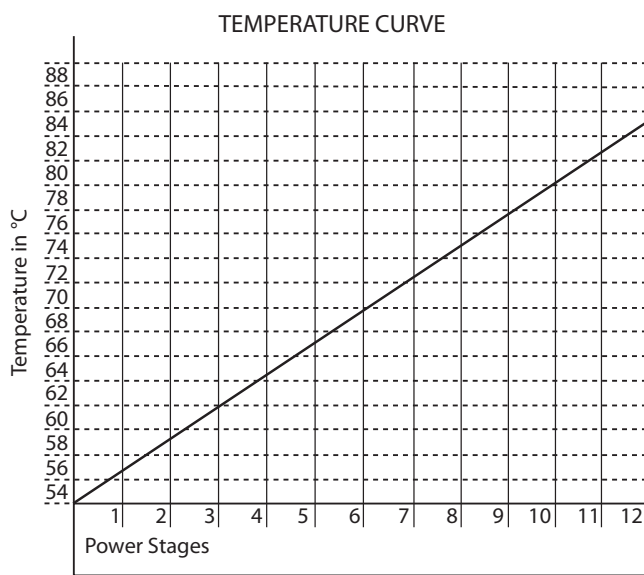

The induction cooker is immediately ready for operation by pushing the "ON/OFF" key. The shining indicator operation lights shows that energy is transferred to the pan. The power ratings "low, mid and high" are fixed and can be changed infinitely by pushing the  /  keys. The inductive power depends on the power stage (LED indicator).

LED position 1 > minimum power

LED position 12 > maximum power



Due to the following characteristics the operator must be more attentive when using the induction cooker than would be required with other appliances.

The heat storage capacity of this system is very low. If the heating level is changed by pushing the  /  keys, the food is immediately exposed to a different temperature. **Do not put empty pans on the glass ceramic cooking zone**, first put grease or liquid into the pan and start cooking process after that. Empty pans and pots will heat up very quickly. Adjust carefully the heating level to the required cooking mode adjusting the temperature with  /  keys.

The pan should always remain in the center of the heating area, otherwise the bottom of the pan is heated unequally and the food inside the pan may burn. When heating oil or grease, constantly check the pan to prevent oil and grease from overheating and burning.

Comfort



The cooker only transmits energy if a pan is placed on the heating area, independently of the position of the control knob. If you take the pan away from the heating area, power transfer stops immediately. If the pan is put back on the heating area, the selected power will be transferred to the pan again.

After switching the cooker to the OFF position the cooking process will stop.

Cooking Process With Temperature Probe



You can use the temperature probe to set and control the operation of the unit when cooking sauces, soups, creams etc.

Temperature control

The temperature probe can be fixed with the holding device at the pan and put into the liquid, then connect the probe plug into the receptacle. You can now choose the required temperature for cooking or keeping warm by using the  /  keys. Pressing on the temperature key will show the actual temperature.

When finished with the temperature probe, disconnect it completely and stop the induction unit by pressing the "OFF/ON" key.

Hold Function

The hold function can be used as simple keeping warm function. The temperature control is done by the sensing element that is placed directly under the Ceran plate. You can choose the required temperature by pressing on  /  keys.

OPERATION Continued

Pan Detection

During pan detection, the indicator operation flashes. No power is transferred and the indicator lamp flashes if no pan or an unsuitable pan is detected. Pans having a diameter smaller than 127 mm (5") are not detected.

Control Of The Heating Area

The heating area is controlled with a temperature sensor. Overheated pans (hot oil, empty pans) will be detected. Energy transfer will be stopped. The induction unit must be restarted after it has cooled down.

Out Of Operation

If the cooker is out of operation make sure that the control knob is in the "OFF" position. If you don't use the cooker for a longer period (several days) unplug the unit. Make sure that no liquid can enter into the cooker and don't clean the cooker with a jet of water.

SAFETY CONCERNS

Description Of Danger Signs



This symbol identifies the safety information which may cause danger (personal injury) for people at non-observance of proper operation.

CAUTION

Indicates a hazard or unsafe practice which could result in minor personal injury or property damage.

Information signs mounted directly on the cooker must be observed at all times and kept in a fully legible condition.

EXAMPLE:

CAUTION Refer to instructions before operating or servicing the unit.

Safety Conscious Work

The safety information contained in these instructions for use, the existing national regulation for the prevention of accidents as well as any internal working operating and safety regulations stipulated by the operator must be observed.

Certain risks may be associated with non-observance of precautions, including:

1. Danger to persons through electrical causes.
2. Danger to persons through overheated pans.
3. Danger to persons through an overheated cooking platform (ceran plate).

The operating reliability of the cookers can only be guaranteed with proper use.

Operator/Operating Personnel Safety Information

Any risks from electric power must be eliminated. The induction unit shall only be used if the installation of the electricity is fitted by an approved installation contractor in accordance with specific national and local regulations.

The heating area is warmed up from the heat of the pan. To avoid injuries (burning) do not touch the heating area.

1. To avoid overheating of pans by means of evaporating the contents, don't heat up pans unattended.

SAFETY CONCERNS Continued

2. Switch the control knob off if you take the pan away for a while. This will avoid having the heating process continue automatically when a pan is placed back on the heating area. So, if any person starts to use the cooker, he/she will have to start the heating process by turning the control knob in the ON-position.
3. Do not insert any piece of paper, cardboard, cloth, etc. between the pan and the heating area, as this might initiate a fire.
4. As metallic objects are heated up very quickly when placed on the operating heating area, do not place any other objects (closed cans, aluminum foil, cutlery, jewelry, watches etc.) on the induction cooker. Persons with a pacemaker should ask their doctor whether they are safe near an induction cooker or not.
5. Do not place credit cards, phone cards, cassette tapes, or other objects that are sensitive to magnetism on the Ceran plate.
6. The induction cooker has an internal air-cooling system. Do not obstruct the air inlet-and air outlet-slots with objects (cloth). This would cause overheating and therefore the cooker would switch off.
7. This induction unit is equipped with a grease filter, placed at the bottom of the case. The grease filter is fixed on a mounting with support angles and can be pulled out from the operator's side.
8. Make sure that this filter is cleaned in the dishwasher once a week otherwise the air cooling system can not work perfectly and this would lead to overheating the unit.
9. Avoid liquid entering into the cooker. Do not let water or food overflow the pan. Do not clean the Cooker with a jet of water.
10. If the heating area (Ceran plate) is cracked or broken, the induction cooker must be switched off and disconnected from the electric connection. Don't touch any parts inside the cooker.

Unauthorized Reconstruction And Use Of Spare Parts

Reconstruction of the cooker or changes to the cooker are not allowed. Contact the manufacturer if you intend to make any changes on the cooker. To guarantee the safety, use only genuine spare parts and accessories authorized by the manufacture. The use of other components voids all warranties.

TROUBLE SHOOTING

CAUTION Do not open the cooker, dangerous electric voltage inside

The cookers may only be opened by authorized service personnel.

Stop any actions if the heating area (Ceran plate) is cracked or broken, the induction cooker must be switched off and disconnected from the electric supply. Don't touch any parts inside the cooker.

Error Messages

Order of error message: The indicator lamp "ON" flashes for an interval of 0.6 sec. The number of the following short flashes has to be counted and indicating the kind of error corresponding to the following mentioned code system.

NUMBER OF FLASHING SIGNALS – CODE	SIGNIFICATION	NOTES
--	No fault, normal operation	
01	No spool current, Hardware overcurrent	
02	High spool current, Software overcurrent	***
03	Temperature cooling plate	
04	Temperature cooking platform, overheating	*
05	Power rotary switch line break	
06	Raised inside temperature	
07	Sensing element of cooking platform, short circuit	*
08		
09		
10		
11		
12	Power reduction cooling plate temperature	**
13	Power reduction cooking platform temperature	**
14	Power reduction caused by bad pan material	**

* The induction unit continues working but the temperature of the cooking platform is not controlled anymore.

** The induction unit continues working with reduced power cycles.

*** Bad pan material.

TROUBLE SHOOTING Continued

Troubling Shooting Guide

Fault	Possible Cause	Action to take through operator or operating personnel
No heating indicator operation is OFF (dark)	No electrical supply	Check if the electrical supply (cable plugged in the wall socket), check preliminary fuses
	Control in off-position	Push control on
	Pan too small (bottom diameter less than 5" (127 mm)	Use a suitable pan
	Pan is not placed in the center of the heating area (the cooker can't detect the pan)	Move the pan to the center of the heating area
	Unsuitable pan	Choose a pan which is recommended for induction cooking *
	Cooker defective	Ask your supplier for repair service, unplug the cooker from the electrical supply
Poor heating, indicator operation is ON (shines)	Used pan is not ideal	Use a pan which is recommended for induction cooking, compare results with 'your' pan
	Air-cooling system obstructed	Verify, that air inlet and air outlet are not obstructed with objects
	Ambient temperature is too high (the cooling system is not able to keep the cooker in normal operating conditions **	Verify, that no hot air is sucked in by the fan. Reduce the ambient temperature. The air inlet temperature must be lower than 40°C/110°F
	One phase is missing (only with three phase supply)	Check preliminary fuses
	Cooker defective	Ask your supplier for repair service, unplug the cooker from the electrical supply
No reaction to control knob positions	Control knob defective	Ask your supplier for repair service, unplug the cooker from the electrical supply
Heating cycle switches off and on within minutes, fan is active	Air inlet or outlet obstructed	Remove objects from air inlet and air outlet slots, clean the slots
	Grease filter is dirty	Clean grease filter
Heating switches off and on within minutes, fan is never active	Fan defective	Ask your supplier for repair service
	Fan control defective	

TROUBLE SHOOTING Continued

Fault	Possible Cause	Action to take through operator or operating personnel
After a longer permanent operating time, the heating switches off and on within minutes	Coil overheated, cooking area too hot	Switch cooker off, remove pan and wait until the cooking area has cooled off
	Empty pan	
	Pan with overheated oil	
Small metallic objects (e.g. Spoon) are heated up within the cooking area	Pan detection tuned incorrectly	Control logic board

* To verify if the pan is suitable, use a permanent magnet and find out if it sticks on the bottom of the pan. If not, your pan is not suitable for induction cooking. Choose a pan which is recommended for induction cooking. Choose pan material suitable for induction appliances.

** The cooling-system (fan) starts to operate when the heat temperature exceeds 55°C/130°F. At heat temperatures higher than 70°C/160°F, the controller automatically reduces the power to keep the power unit in normal operating conditions. The cooker runs in a non continuous mode. This mode can be heard.

CLEANING AND SERVICING

Cleaning

Common types of soiling and recommendations how to treat them:

Slight soiling, no burned residues

Wipe with a moist cloth (scotch), without cleaning agent

Lime deposits, caused by water which has boiled over

These spots can be removed with vinegar or a special cleaning agent

Grease filter

Clean this filter once a week by putting it in the dishwasher

Make sure that no liquid can enter in the induction unit. Do not clean the Cooker with a jet of water.

Support

Good maintenance of the induction cooker requires regular cleaning, care and servicing. The operator has to ensure that all components relevant to safety are in perfect working order at all times.

The cooker has to be examined at least once a year by an authorized technician.

CAUTION Do not open the cooker, dangerous electric voltage inside.

The cookers may only be opened by authorized personnel.



Free Manuals Download Website

<http://myh66.com>

<http://usermanuals.us>

<http://www.somanuals.com>

<http://www.4manuals.cc>

<http://www.manual-lib.com>

<http://www.404manual.com>

<http://www.luxmanual.com>

<http://aubethermostatmanual.com>

Golf course search by state

<http://golfingnear.com>

Email search by domain

<http://emailbydomain.com>

Auto manuals search

<http://auto.somanuals.com>

TV manuals search

<http://tv.somanuals.com>