

Epson Stylus® NX300/305 Series



Quick Guide

Basic Printing, Copying, Scanning, and Faxing
Maintaining Your All-in-One
Solving Problems

Contents

Introduction	4
Loading Paper	5
Using Special Papers	6
Placing Originals for Copying, Scanning, or Faxing	8
Using the Scanner Glass	8
Using the Automatic Document Feeder	9
Copying a Document or Photo	11
Copying a Document	11
Copying a Photo	12
Faxing a Document or Photo	14
Connecting a Phone or Answering Machine	14
Setting Up Fax Features	16
Sending a Fax	20
Receiving Faxes	22
Using the One-touch Dial Buttons	23
Printing From Your Computer	24
Printing in Windows	24
Printing With a Macintosh	26
Selecting the Correct Paper Type	30
Scanning a Document or Photo	31
Basic Scanning	31
Scanning Multiple Pages	33

Maintaining Your Product	34
Checking the Print Head Nozzles	34
Cleaning the Print Head	35
Checking the Ink Cartridge Status	36
Purchasing Epson Ink Cartridges	37
Replacing Ink Cartridges	38
Solving Problems	40
Checking for Software Updates	40
Error Indicators	41
Problems and Solutions	41
Where to Get Help	44
Notices	45

Introduction

After you have set up your Epson Stylus® NX300/305 Series as described on the *Start Here* sheet, turn here to:

- Load paper
- Make a copy of a document or photo
- Fax a document or photo
- Get the basic steps for printing from your computer
- Scan multiple pages
- Perform routine maintenance
- Solve simple problems

This book tells you how to do most of these things without ever turning on your computer! Of course, your NX300/305 Series can do a lot more when you connect it to your Windows® or Macintosh® computer. For additional instructions, see the online *User's Guide* by double-clicking its icon on your desktop (requires an Internet connection).

Please follow these guidelines as you read your NX300/305 Series instructions:

Warning:

Warnings must be followed carefully to avoid bodily injury.

Caution:

Cautions must be observed to avoid damage to your equipment.

Note:

Notes contain important information about your NX300/305 Series.

Tip:

Tips contain hints for better faxing, copying, scanning, and printing.

Loading Paper

You can print documents and photos on a variety of paper types and sizes. For details, see page 6.

1. Open the paper support and pull up the extensions. Then open the output tray, pull out the extension, and raise the paper stopper.

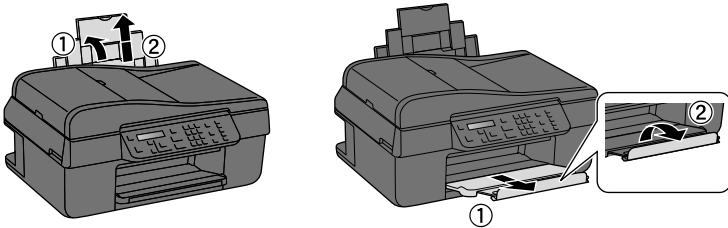

2. Pinch the edge guide and slide it to the left.

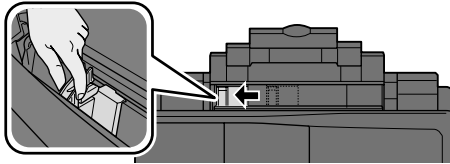

3. Insert paper, glossy or printable side up, against the right side and behind the tab. (Load letterhead or pre-printed paper top edge first.)

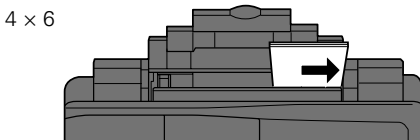
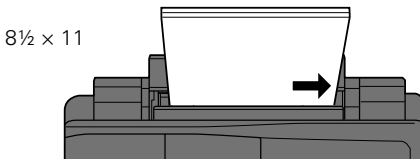

Always load paper short edge first, even for landscape printing.

You can load up to 100 sheets of plain paper, or 20 sheets of photo paper. Load other special papers one sheet at a time.

Note:

The type of paper you choose affects the way your printout looks. If you are just making a copy or printing a rough draft, plain paper is fine. However, for the best results, you'll want to use one of Epson's special ink jet papers designed for your printer (see "Using Special Papers" for more information).

4. Slide the edge guide against the paper, but not too tightly.

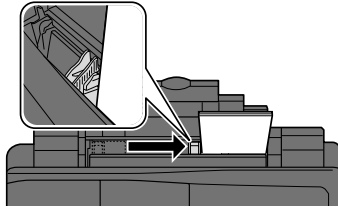

Note:

For details on paper and instructions on loading envelopes, see your online *User's Guide*.

Using Special Papers

Epson offers a wide array of high quality papers, making it easy to maximize the impact of your photos, presentations, and creative projects.

You can purchase genuine Epson ink and paper at Epson Supplies CentralSM at www.epson.com/ink3 (U.S. sales) or www.epson.ca (Canadian sales). You can also purchase supplies from an Epson authorized reseller. To find the nearest one, call 800-GO-EPSON (800-463-7766).

Paper name	Size	Part number	Sheet count
Epson Bright White Paper	Letter (8.5 × 11 inches)	S041586	500
Epson Presentation Paper Matte	Letter (8.5 × 11 inches)	S041062	100
	Legal (8.5 × 14 inches)	S041067	100
Epson Premium Presentation Paper Matte	Borderless 8 × 10 inches	S041467	50
	Letter (8.5 × 11 inches)	S041257 S042180	50 100

Paper name	Size	Part number	Sheet count
Epson Premium Presentation Paper Matte Double-sided	Letter (8.5 × 11 inches)	S041568	50
Epson Premium Photo Paper Glossy	Borderless 4 × 6 inches	S041808 S041727	40 100
	Borderless 5 × 7 inches	S041464	20
	Borderless 8 × 10 inches	S041465	20
	Letter (8.5 × 11 inches)	S042183 S041667	25 50
Epson Ultra Premium Photo Paper Glossy	Borderless 4 × 6 inches	S042181 S042174	60 100
	Borderless 5 × 7 inches	S041945	20
	Borderless 8 × 10 inches	S041946	20
	Letter (8.5 × 11 inches)	S042182 S042175	25 50
Epson Premium Photo Paper Semi-gloss	Borderless 4 × 6 inches	S041982	40
	Letter (8.5 × 11 inches)	S041331	20
Epson Photo Paper Glossy	Borderless 4 × 6 inches	S041809 S042038	50 100
	Letter (8.5 × 11 inches)	S041141 S041649 S041271	20 50 100
Epson Ultra Premium Presentation Paper Matte	Letter (8.5 × 11 inches)	S041341	50
Epson Photo Quality Self-adhesive Sheets	A4 (8.3 × 11.7 inches)	S041106	10
Epson Iron-on Cool Peel Transfer paper	Letter (8.5 × 11 inches)	S041153	10

Placing Originals for Copying, Scanning, or Faxing

Before you copy, scan, or fax, place your documents or photos on the scanner glass (below) or in the Automatic Document Feeder (see page 9).

Using the Scanner Glass

You can place two photos or a document up to letter-size (or A4) on the scanner glass to make color or black-and-white copies.

1. Open the document cover and place your original face-down on the scanner glass, with the top against the back left corner.

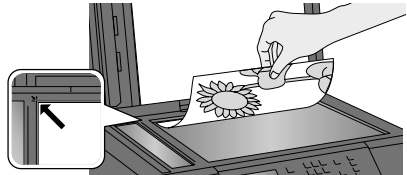

If you're scanning 3 × 5- or 4 × 6-inch photos with your computer, you can place up to two at a time on the scanner glass. Place them at least 1/4 inch (5 mm) apart.

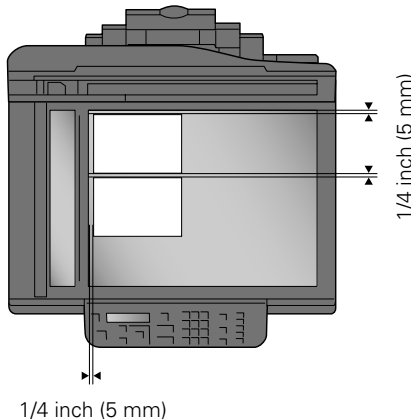

2. Close the cover gently so you don't move the original(s).

Using the Automatic Document Feeder

You can place up to 30 letter-size sheets or 10 legal-size sheets in the Automatic Document Feeder.

1. Tap the originals on a flat surface to even the edges.
2. Open the ADF paper support.

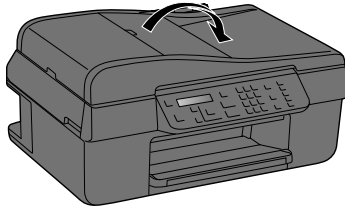

3. Slide the edge guide to the side.



4. Insert the originals face-up.

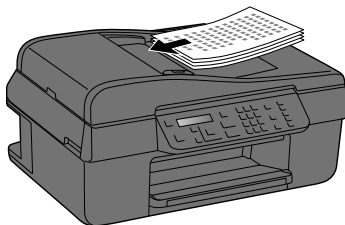

5. Slide the edge guide against the originals. Once they're loaded, you can copy, scan, or fax.

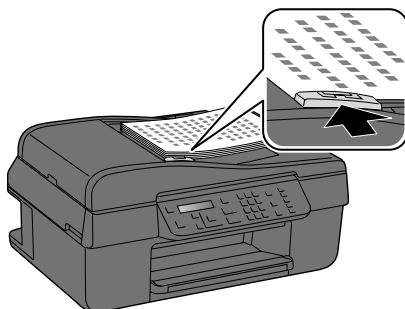

Note:

When you use the Copy function, letter-size paper is automatically selected for your printed copies. If you copy a legal-size document, the image will be cropped to fit letter-size paper.

Copying a Document or Photo

Follow the instructions in this section to make color or black-and-white copies.

Note:

To turn off the “beep” heard when you press a button, press **Copy/Fax**, press **Menu**, press **▲** or **▼** to select **Maintenance** and press **OK**, press **▲** or **▼** to select **Sound** and press **OK**, and select **Off**.

Copying a Document

You can copy documents onto letter-size (or A4) plain paper, Epson Bright White Paper, or Epson Presentation Paper Matte, just like you would on a copy machine. If you use the Automatic Document Feeder, you can copy up to 30 sheets at a time onto letter-size (or A4) plain paper.

1. Press the **⏻** **On** button to turn on the NX300/305 Series.
2. Load letter- or A4-size plain paper, Epson Bright White Paper, or Epson Presentation Paper Matte in the sheet feeder (see page 5).
3. Place your original document(s) on the scanner glass or in the Automatic Document Feeder (see page 8 or 9).
4. Press the **Copy/Fax** button to enter Copy mode.
5. Press **▲** or **▼** or use the numeric keypad to select the number of copies you want (up to 99).
6. To adjust print settings, press **Menu**, then press **▲** or **▼** and select your settings:
 - To adjust the copy size, select **Reduce/Enlarge** and choose either **Actual**, **Custom** (to select a percentage using **▲** or **▼** or the numeric keypad), or **Auto Fit Page** (to automatically size the image to fit your paper).
 - Select **Paper Size** to choose the size of paper you loaded.

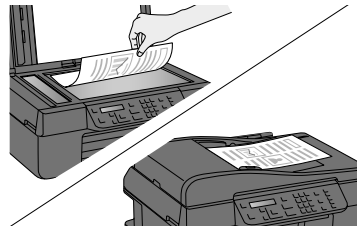

- Select **Paper Type** and make sure **Plain Paper** is selected for copying documents.
- To change the copy quality, select **Quality** and choose **Standard Quality**, **Best**, or **Draft** (for plain paper only).
- To adjust the darkness or lightness of the copy, select **Copy Density** and choose a higher (darker) or lower (lighter) setting.

Note:

Not all **Paper Type**, **Paper Size**, **Layout**, and **Quality** settings may be available depending on the options you choose.

7. After you finish selecting your settings, press **OK** and then **Menu** to exit settings.
8. Press the **◆ B&W** or **◆ Color** button to begin copying. To cancel copying, press **⊗ Stop/Clear Settings**.

Copying a Photo

You can copy a photo onto 4 × 6-inch, 5 × 7-inch, or letter-size Epson photo paper (various types available—see page 6) for instant photo reprints.

1. Press the **⏻ On** button to turn on the NX300/305 Series.
2. Load Epson photo paper in the sheet feeder (see page 5).
3. Place your photo on the scanner glass (see page 8).
4. Press the **Copy/Fax** button to enter Copy mode.
5. Press **▲** or **▼** or use the numeric keypad to select the number of copies you want (up to 99).
6. To change the layout, press **Menu**, press **▲** or **▼** to select **Layout**, and press **OK**.

◆1.Layout
▶With Border

Press **▲** or **▼** to select **With Border** to leave a small margin around the image or **Borderless** to expand the image all the way to the edge of the paper (slight cropping may occur).

Note:

To adjust the amount of image expansion when printing borderless photos, select **Expansion** and choose **Standard**, **Medium**, or **Minimum**.

7. Select **Paper Size** and choose the size of paper you loaded.
8. Select **Paper Type** and choose the type of photo paper you loaded:

Paper type	Paper Type setting
Epson Photo Quality Self-adhesive Sheets Epson Iron-on Cool Peel Transfer paper	Plain Paper
Epson Premium Presentation Paper Matte Epson Premium Presentation Paper Matte Double-sided Epson Ultra Premium Presentation Paper Matte	Matte
Epson Premium Photo Paper Glossy Epson Premium Photo Paper Semi-gloss	Prem. Glossy
Epson Ultra Premium Photo Paper Glossy	Ultra Glossy
Epson Photo Paper Glossy	Glossy

9. To change any other print settings, press ▲ or ▼ and select your settings (see page 11).
10. When you're done, press **OK** and then **Menu** to exit settings.
11. Press the ◊ **Color** button to begin copying. To cancel copying, press ⓧ **Stop/Clear Settings**.

Faxing a Document or Photo

Your NX300/305 Series lets you send faxes by entering fax numbers, selecting entries from a speed dial list, or using the one-touch dial buttons. Using the Automatic Document Feeder, you can fax up to 30 pages at a time.

Note:

For more information on faxing and fax settings, see the online *User's Guide*.

Connecting a Phone or Answering Machine

1. Connect the phone cable from the wall jack to the **LINE** port on the back of the NX300/305 Series.

Note:

If you're connecting the NX300/305 Series to a DSL phone line, you must plug a DSL filter into the wall jack or you won't be able to use the fax or telephone equipment as described below. Contact your DSL provider for the necessary filter.

Epson cannot guarantee compatibility with VoIP, cable phone systems, or fiber-optic digital services such as FiOS™.

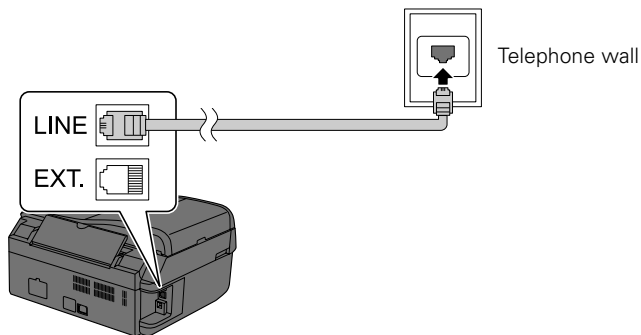

2. To use a telephone or answering machine, you need a second phone cable. Connect one end of the cable to the telephone or answering machine, and connect the other end to the **EXT.** port on the back of the NX300/305 Series.

Note:

Remove the cap from the **EXT.** port, if you haven't already done so, before connecting a phone or answering machine.

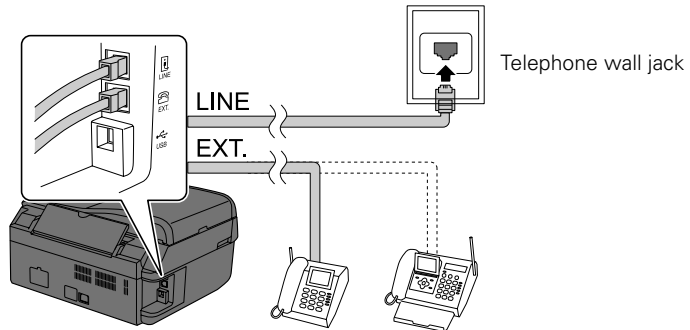

If your answering machine is set to pick up on the fourth ring, you should set the NX300/305 Series to pick up on the fifth ring or later:

1. Press the **Copy/Fax** button to select Fax mode, then press **Menu**.
2. Press **▲** or **▼** to select **Fax Setting**, then press **OK**.
3. Press **▲** or **▼** to select **Communication**, then press **OK**.
4. Press **▲** or **▼** to select **Rings to Answer**, then press **OK**.
5. Press **▲** or **▼** or use the numeric keypad to select the number of rings, then press **OK**. Select more than the number of rings needed for the answering machine to pick up.

In Auto Answer mode, if the incoming call is a fax and you pick up the phone or the answering machine answers, the NX300/305 Series automatically begins receiving the transmission. If the other party is a caller, the phone can be used as normal or a message can be left on the answering machine.

Note:

A phone or answering machine must be connected to the **EXT.** port for the NX300/305 Series to detect an incoming fax call when a phone is picked up. If a fax call comes in, and you pick up the phone without having a phone or answering machine connected to the **EXT.** port, the call will be disconnected when you hang up and the NX300/305 Series will not receive the fax.

Setting Up Fax Features

Before sending or receiving faxes, create a fax header and select your fax preferences.

Note:

To change other settings or print fax reports, see the online *User's Guide*.

Entering Fax Header Information

You should enter your name and phone number in the fax header before sending faxes so that recipients can identify the origin of the fax.

Note:

If you leave the NX300/305 Series unplugged for a long period of time, the date and time settings may get lost. See the online *User's Guide* for instructions on setting the date and time.

Entering Your Sender Name

1. Press the Copy/Fax button to select Fax mode, then press Menu.
2. Press ▲ or ▼ to select Fax Setting, then press OK.
3. Press ▲ or ▼ to select Header, then press OK.
4. Select Fax Header, then press OK.
5. Use the numeric keypad to enter your sender name or other header information (see page 17). You can enter up to 40 digits.
6. Press OK. You return to the Fax Header screen.

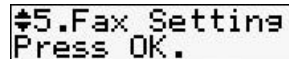

5.Fax Setting
Press OK.

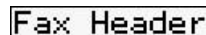

Fax Header

Entering Your Phone Number

1. From the Fax Header screen, press ▲ or ▼ to select Your Phone Number, then press OK. You see the phone number input screen.
2. Use the numeric keypad to enter your phone number (see page 17). You can enter up to 20 digits.
3. Press OK. You return to the Your Phone Number screen.



Your Phone Numbe

Using the Keypad to Enter Numbers and Characters

When entering phone numbers and text in Fax mode, follow these guidelines:

- To move the cursor, add a space, or delete a character:

Button	Function
◀ or ▶	Moves the cursor to the left or right.
Auto Answer/Space	Inserts a space and moves the cursor one character to the right.
Speed Dial/Group Dial/ Backspace	Deletes a character and moves the cursor one space to the left.

- To enter a fax number, use the numeric keypad. Use the # button to type the + symbol when entering a phone number in international dialing format.
- To enter characters, press a keypad number repeatedly to switch between uppercase, lowercase, or numbers.

Press **1symb** to enter these special characters: ! # % & ' () * + , - . / : ; = ? @ ~

Select Scan and Print Settings

Use these settings to adjust the image quality of incoming and outgoing faxes, select the paper size loaded in your NX300/305 Series, select the size at which faxes are printed, and choose the printed reports you want.

1. Press the **Copy/Fax** button to select Fax mode, then press **Menu**.
2. Press **▲** or **▼** to select **Fax Setting**, then press **OK**.
3. Press **▲** or **▼** to select **Scan & Print Setup**, then press **OK**.
4. Adjust any of the following settings:

5.Fax Setting
Press OK.

Setting and options	Description
Resolution	Sets the scan resolution and print quality of incoming and outgoing faxes. Select Fine for small print or detailed line art, Photo for pictures, or Standard for basic faxes.
Contrast	Sets the contrast when scanning and printing. Positive values increase the contrast of the image, negative values decrease the contrast.
Paper Size	Indicates the size of paper you loaded (letter, legal, or A4).
Auto Reduction	Indicates whether large incoming faxes are reduced to fit on the selected Paper Size (On), or printed at their original size on multiple sheets (Off).
Last Transmission Report	Indicates when the NX300/305 Series prints a report on the last transmitted fax. Select Off to turn off report printing, On Error to print reports only when an error occurs, or On Send to print reports for every fax you send.

Setting Up a Speed Dial and Group Dial List

You can create a speed dial list of fax numbers so you can quickly select them for faxing. You can also set up a group dial list to automatically send the same fax message to multiple speed dial numbers.

You can create up to 60 combined speed dial and group dial entries, add names to identify the recipients, and print a list for easy reference (see page 20). You can quickly access the first five entries using the one-touch dial buttons (see page 23).

Creating a Speed Dial List

1. Press the **Copy/Fax** button to select Fax mode, then press **Menu**.
2. Press **▲** or **▼** to select **Fax Setting**, then press **OK**.
3. Press **▲** or **▼** to select **Speed Dial Setup**, then press **OK**.
4. Press **▲** or **▼** to select **Create**, then press **OK**.
You see the list of available entries.



[01]Speed Dial
01

Note:

To edit or delete an entry from an existing list, select **Edit** or **Delete** instead.

5. Select or type the number of the entry you want to add, then press **OK**.
6. Use the numeric keypad to enter the fax number (see page 17), then press **OK**.
7. Use the numeric keypad to enter a name to identify the speed dial entry (see page 17), then press **OK**. You return to the **Create** menu.
8. To add another speed dial entry, press **OK** and repeat the steps above.

Creating a Group Dial List

1. Press the **Copy/Fax** button to select Fax mode, then press **Menu**.
2. Press **▲** or **▼** to select **Fax Setting**, then press **OK**.
3. Press **▲** or **▼** to select **Group Dial Setup**, then press **OK**.
4. Press **▲** or **▼** to select **Create**, then press **OK**.
You see the list of available entries.



[04]Group Dial
04

Note:

To edit or delete an entry from an existing list, select **Edit** or **Delete** instead.

5. Select or type the number of the entry you want to add, then press **OK**.
6. Use the numeric keypad to enter a name to identify the group dial entry (see page 17), then press **OK**.
7. Select or type the number of a speed dial entry to add and press * to add the entry to the group dial list. Up to 30 speed dial entries may be added to each group dial list.

Note:

Press * again to cancel adding the speed dial entry that you selected.

8. Repeat the steps above to add additional speed dial entries to the group.
9. When finished, press **OK**.

Printing Your Speed Dial List

To print your speed dial list, follow these steps:

1. Press the **Copy/Fax** button to select Fax mode, then press **Menu**.
2. Press **▲** or **▼** to select **Fax Setting**, then press **OK**.
3. Press **▲** or **▼** to select **Print Report**, then press **OK**.
4. Press **▲** or **▼** to select **Speed Dial List**. You see the list of available entries.

Note:

To print a group dial list, select **Group Dial List** in step 4.

5. Make sure letter-size paper is loaded in the NX300/305 Series, then press the **◆ Color** button to print your list.

Sending a Fax

You can send a fax by manually entering a fax number or redialing the previous fax number, selecting an entry from your speed dial list, or using a connected telephone to dial the number (see page 19).

1. Place your original(s) for faxing (see page 8).
2. Press the **Copy/Fax** button to select Fax mode.

Fax	10:12 AM
-----	----------

3. Do one of the following to dial the fax number:

- Use the numeric keypad to manually enter the fax number. You can enter up to 64 digits.
- Press **Redial/Pause** to redial the last fax number you used. The last fax number is displayed on the screen.
- Press **Speed Dial/Group Dial/Backspace** to select a speed dial/group dial entry. Select or type the number of the speed dial/group dial entry you want to use, then press **OK**.

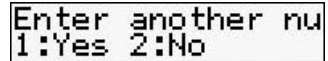

Enter another nu
1:Yes 2:No

You see the screen at right. Press 1 to enter another number or press 2 to continue with your selection.

- Press a one-touch dial button to select one of the first five speed dial/group dial entries, then press **OK**. Press 1 to enter another number or press 2 to continue with your selection. (See page 23 for the paper insert.)
- If you've connected a telephone to the NX300/305 Series, dial the number from the phone. You see the screen at right. Press 1 to confirm.

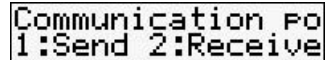

Communication Fo
1:Send 2:Receive

Note:

Don't hang up the phone until you begin transmitting the fax in step 5.

4. Press **Menu** to change any of the following fax settings:

- **Resolution** to increase the scanning resolution of a faxed document.
- **Contrast** to change the contrast of the faxed document.
- **Send Fax Later** to specify a different time to send your fax. (You cannot send another fax until the delayed fax has been sent or cancelled.)
- **Fax Mode** to select **Sending** (to send faxes as usual) or **Poll to Receive** (to receive a fax from another fax machine to which you have dialed, such as a fax information service).

Press **Menu** when you're done selecting settings.

5. Press the **◇ B&W** or **◇ Color** button to send your fax. To cancel faxing, press **⊙ Stop/Clear Settings** at any time.

Note:

If the recipient's fax machine prints only in black and white, your fax is automatically sent in black and white even if you select color.

If you are scanning with the Automatic Document Feeder, your document is automatically scanned and faxed.

If you placed your document on the scanner glass, you see this screen after the first page is scanned:

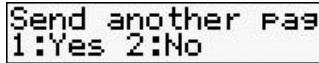

Send another Page
1:Yes 2:No

If you need to fax additional pages, place your original on the scanner glass or in the Automatic Document Feeder. Then press **1** to continue. If you do not need to fax another page, press **2**. Your document is faxed.

Note:

If the fax number is busy, you see a redialing message and the NX300/305 Series redials after one minute. To redial immediately, press **Redial/Pause**.

Receiving Faxes

Before receiving faxes, make sure you load plain paper and select the **Paper Size** setting that matches the size of paper you've loaded (see "Select Scan and Print Settings" on page 18). If the incoming fax pages are larger than the paper size you loaded, the fax size is reduced to fit or printed on multiple pages, depending on the **Auto Reduction** setting you select (see page 18).

If you run out of paper during printing, you see the error message **Paper out**. Load more paper and press the **OK** button to continue.

To receive faxes automatically, make sure the **Auto Answer** light is turned on. To turn it on, press the **Auto Answer/Space** button and press **OK**.

Note:

To change the number of rings before the NX300/305 Series answers, see page 15.

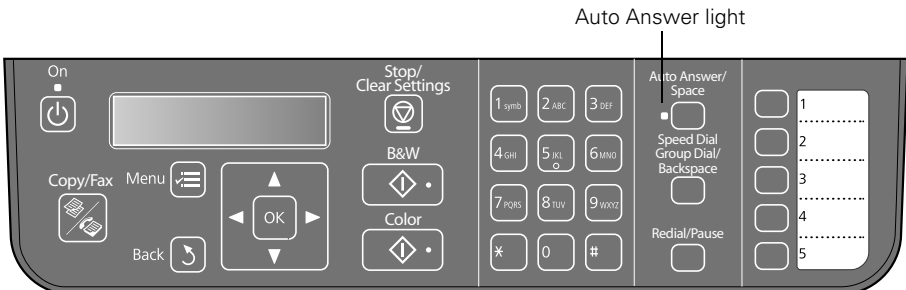

To receive faxes manually, turn off the **Auto Answer** light and follow these steps:

1. When your telephone rings, lift the phone off the hook. You see this screen:

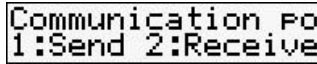

Communication Po
1:Send 2:Receive

2. Press 2 to receive.

3. To receive the fax transmission, press 1 at the next screen.

4. After all the pages are received, you see the screen shown above. Replace the phone on the hook.

5. Press OK to print the fax after receiving the data.

Using the One-touch Dial Buttons

After creating a speed dial/group dial list (see page 19), you can use the one-touch dial buttons to quickly select the first five entries. Follow these steps to make a quick-reference card so you can easily identify the buttons.

1. Copy the template below and carefully cut it out with scissors.

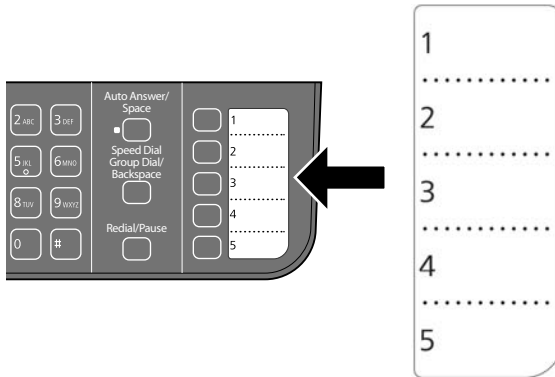

2. Write the names of the first five entries in your speed dial/group dial list on the paper cutout.

3. Remove the clear protective plastic from the area shown above on the control panel. Insert the paper cutout and replace the plastic over it.

Printing From Your Computer

This section describes the basic steps for printing a document or photo stored on your Windows or Macintosh computer. For detailed instructions on printing, see the online *User's Guide*.

Before you start, make sure you've installed your printer software and connected the NX300/305 Series to your computer as described on the *Start Here* sheet.

Tip:

It's a good idea to check for updates to your NX300/305 Series software. See "Checking for Software Updates" on page 40 for instructions.

Printing in Windows

1. Open a document or photo in a printing program, open the File menu, and select Print.

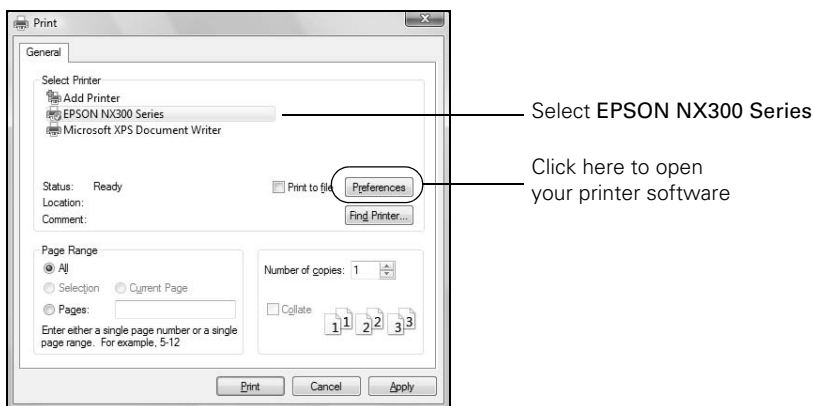

2. Select EPSON NX300 Series and click the Preferences or Properties button.

Note:

If you see a **Setup**, **Printer**, or **Options** button, click it. Then click **Preferences** or **Properties** on the next screen.

3. On the Main tab, select the basic print settings. Make sure you choose the correct paper **Type** setting for your paper (see page 30).

Select the type of document you're printing (choose **Photo** or **Best Photo** for pictures)

Select your paper **Type**

Select your paper **Size**

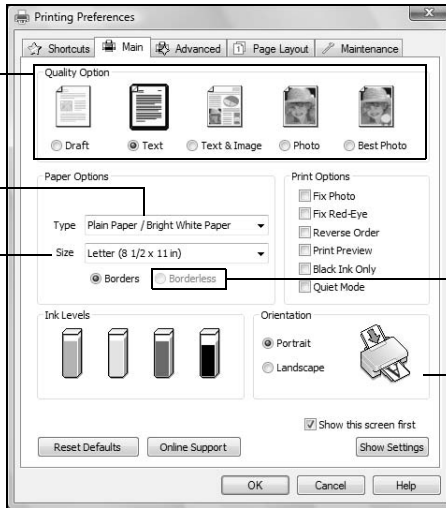

Click here for borderless photos

Select your document or photo **Orientation**

Tip:

For quick access to the most common settings, click the **Shortcuts** tab and select one of the presets. You can create your own presets by clicking the **Save Settings** button on the **Advanced** tab.

4. To reduce or enlarge your printout or print double-sided, click the **Page Layout** tab and select settings as necessary.
5. For more printing options, click the **Advanced** tab.

Note:

For more information about print settings, click **Help** or see your online *User's Guide*.

6. Click **OK** to save your settings.

7. Click **OK** or **Print** to start printing. This window appears and shows the progress of your print job.

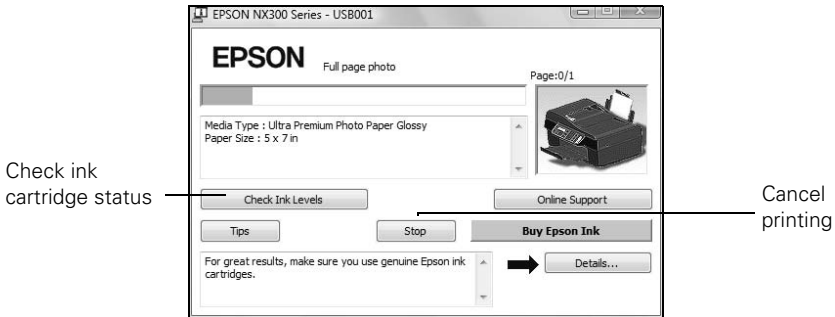

Printing With a Macintosh

See the section below for your Mac OS® operating system.

Mac OS X 10.5 or 10.6

1. Open a document or photo in an application, open the **File** menu, and select **Print**.
2. Select **EPSON Stylus NX300** as the Printer setting.

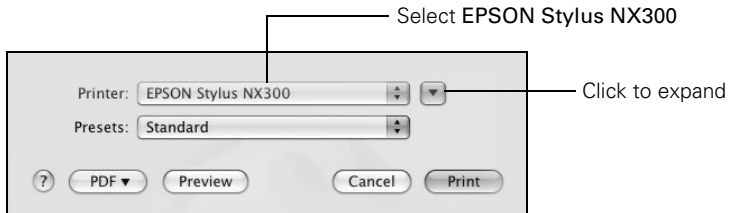

3. Click the arrow to expand the Print window, if necessary.

- Select the basic copy and page settings. For borderless photos, choose a **Paper Size** setting with a **Sheet Feeder - Borderless** option.

Note:

If the setting you want isn't shown (for example, **Scale**), check for it in your application before printing. Or check for it in the settings for your application at the bottom of this window. (If you're printing from Preview, you see the settings shown below.)



- Choose **Print Settings** from the pop-up menu, and select the following print settings:

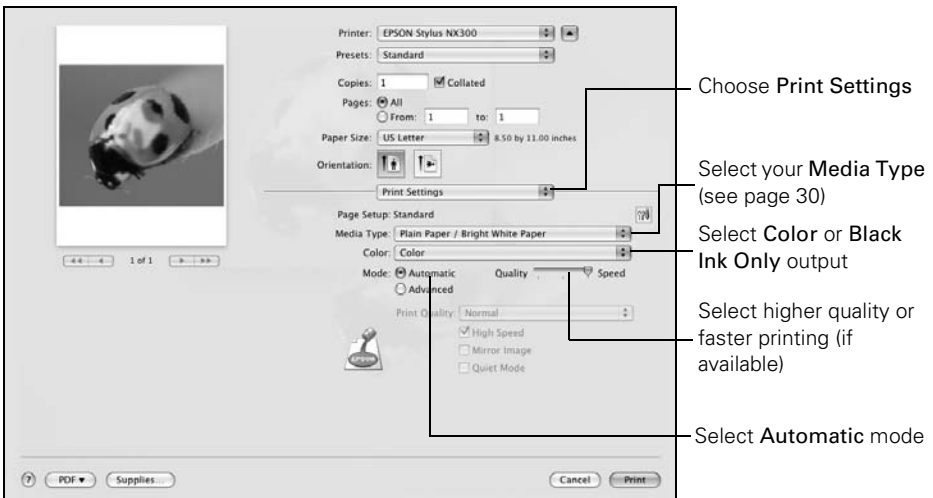

- Choose any other printing options you may need from the pop-up menu. See the online *User's Guide* for details.
- Click **Print**.
- To monitor your print job, click the  printer icon in the dock.

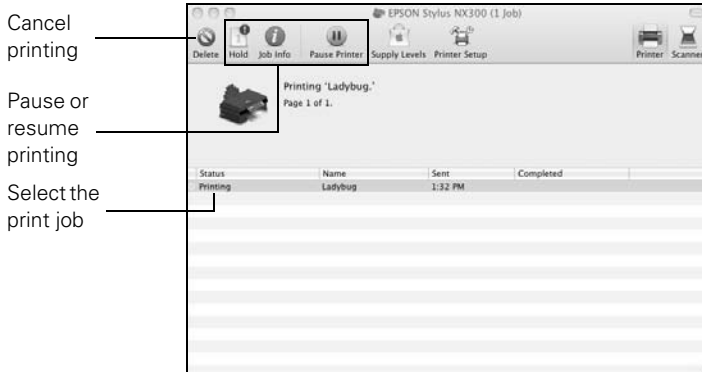

Mac OS X 10.4

- Open a document or photo in an application, open the **File** menu, and select **Page Setup**.
- Select **Stylus NX300** as the **Format for** setting.
- Select the following basic page settings. For borderless printing, choose a **Sheet Feeder - Borderless** option in the **Paper Size** list.

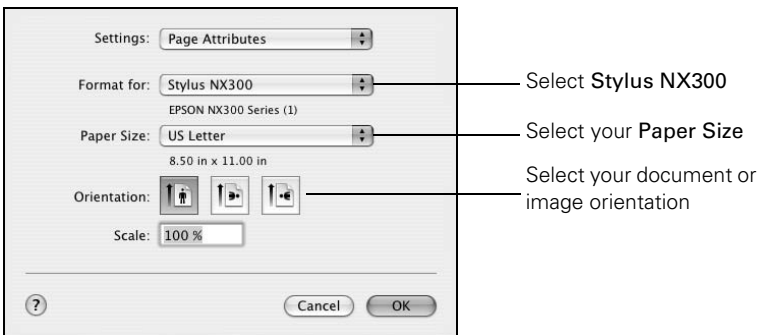

- Click **OK**.
- Open the **File** menu and select **Print**.
- Make sure **Stylus NX300** is selected as the **Printer** setting.

7. Choose **Print Settings** from the pop-up menu, and select the following print settings:

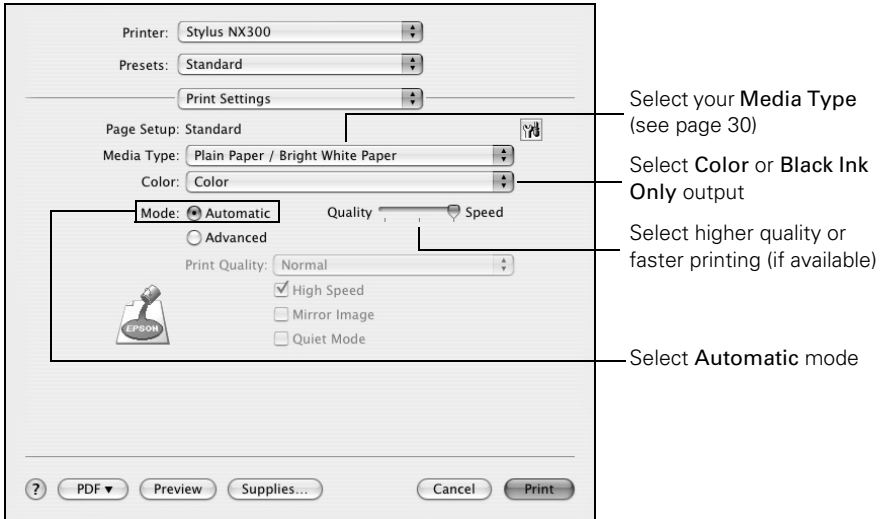

Note:

In certain programs, you may need to select **Advanced** before you can select **Print Settings**. For more information about printer settings, click the ? button.

8. Choose any other printing options you may need from the pop-up menu. See the online *User's Guide* for details.
9. Click the **Advanced** button to change additional settings.

Note:

For more information on advanced settings click ?.

10. Click **Print**.

11. To monitor your print job, click the  printer icon in the dock.

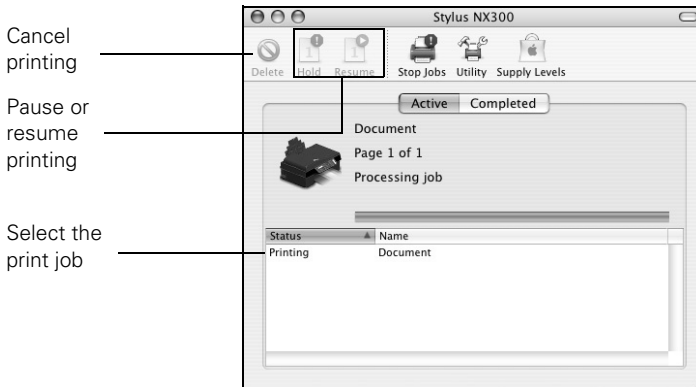

Selecting the Correct Paper Type

Select the correct **Type** (see page 25) or **Media Type** (see page 28) setting in your printer software so the ink coverage can be adjusted accordingly.

For this paper/media	Select this setting
Plain paper Epson Bright White Paper Epson Presentation Paper Matte Epson Photo Quality Self-adhesive Sheets Epson Iron-on Cool Peel Transfer paper	Plain Paper/Bright White Paper
Epson Ultra Premium Photo Paper Glossy	Ultra Premium Photo Paper Glossy
Epson Premium Photo Paper Glossy	Premium Photo Paper Glossy
Epson Photo Paper Glossy	Photo Paper Glossy
Epson Premium Photo Paper Semi-gloss	Premium Photo Paper Semi-gloss
Epson Premium Presentation Paper Matte Epson Premium Presentation Paper Matte Double-sided Epson Ultra Premium Presentation Paper Matte	Premium Presentation Paper Matte
Envelopes	Envelope

Scanning a Document or Photo

You can use your Epson Stylus NX300/305 Series to scan original documents and photos and save them as digital files on your computer or other device.

You can also convert your scanned documents to editable/searchable text using the included ABBYY® FineReader® Sprint Plus OCR software. For more information, see the online *User's Guide*.

Basic Scanning

You can scan from any TWAIN-compliant application using Epson Scan. Or you can start Epson Scan directly from your computer and save your image to a file.

Note:

For detailed scanning instructions, see the online *User's Guide*.

1. Open the document cover and place your original face-down on the glass, in the back left corner, as shown on page 8.
2. Close the cover gently so you don't move the original.
3. Do one of the following to start Epson Scan:
 - **Windows:**
Double-click the EPSON Scan icon on your desktop.
 - **Macintosh:**
Double-click EPSON Scan in the Applications folder.
 - If you are scanning from an application, start your application. Then open the File menu, choose **Import** or **Acquire**, and select your Epson Stylus NX300/305 Series (if necessary).

4. Epson Scan opens in Office Mode the first time you use it. You can change the scan mode using the Mode selector in the upper right corner.
 - **Office Mode** scans text documents quickly and lets you use the Automatic Document Feeder.
 - **Home Mode** is good for scanning photos and graphics and provides several preset options.
 - **Professional Mode** provides a full array of tools.



Click here to change the scan mode

Note:

You cannot use Home mode to scan with the Automatic Document Feeder.

5. Click **Scan** and select the name, location, and format (such as PDF) for your scanned document.
6. Click **OK**. The image is scanned and you see its icon in Windows Explorer or Macintosh Finder.

Scanning Multiple Pages

You can scan a document and save it on your computer in PDF or another format. With the Automatic Document Feeder, you can scan up to 30 pages at a time.

Note:

For detailed scanning instructions, see the online *User's Guide*.

1. Place your document in the Automatic Document Feeder (see page 9).
2. Start Epson Scan (see page 31).
3. Select **Office Mode** in the upper right.
4. Select the **Image Type**.
5. Select **Auto Detect** or **ADF** (Automatic Document Feeder) as the **Document Source** setting.
6. Select the **Size** of the originals.
7. Select the scanning **Resolution** based on how you will use the scanned image:
 - E-mail, view on a computer screen, or post on the web: 96 to 150 dpi
 - Print or convert to editable text (OCR): 300 dpi
 - Fax: 200 dpi
8. Click the **Preview** button to scan and eject the first page. Place the page back on top of the other pages and reload them in the feeder.
9. If desired, draw a marquee (or box) around the area you want to scan in the Preview window. Adjust the image quality, if necessary.
10. Click **Scan**.
11. Select the name, location, and format (such as PDF) for your scanned document and click **OK**. The document is scanned and you see its icon(s) in Windows Explorer or Macintosh Finder.

Note:

Depending on the file format you select, Epson Scan may create one file containing all of the pages in your document or create one file for each page of your document. For more information, see the online *User's Guide*.

To open the file, double-click it in Windows Explorer or Macintosh Finder.

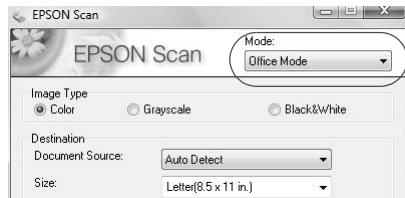

Maintaining Your Product

Follow the instructions in this chapter for checking and cleaning the print head nozzles and replacing ink cartridges. To align the print head, if necessary, see your online *User's Guide*.

Checking the Print Head Nozzles

If your printouts are faint or have gaps in them, some of the nozzles in the print head may be clogged or ink may be running low in one or more of the ink cartridges. Follow the steps below to check the print head nozzles.

1. Load letter-size plain paper in the sheet feeder.
2. Press the **Copy/Fax** button, then press **Menu**.
3. Press **▲** or **▼** to select **Maintenance**, then press **OK**.
4. Press **▲** or **▼** to select **Nozzle Check**, then press the **◇ Color** button.
5. Check the nozzle check pattern that prints to see if there are gaps in the lines.

A rectangular LCD screen with a black border. The text on the screen is in a monospaced font. The top line reads "2.Nozzle Check" and the bottom line reads "Press the Color".

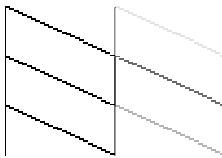

Nozzles are clean

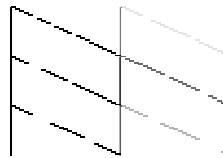

Nozzles need cleaning

6. If there are no gaps, the print head is clean and you can continue printing. Press **1** to finish.

If there are gaps or the pattern is faint, press **2** to clean the print head. See page 35 for details.

Cleaning the Print Head

If print quality has declined and the nozzle check indicates clogged nozzles, you can clean the print head. Print head cleaning uses ink, so clean it only if necessary.

Note:

You cannot clean the print head if an ink cartridge is expended, and may not be able to clean it when a cartridge is low. You must replace the cartridge first (see page 38).

1. Load letter-size plain paper in the sheet feeder.
2. Press the **Copy/Fax** button, then press **Menu**.
3. Press **▲** or **▼** to select **Maintenance**, then press **OK**.
4. Press **▲** or **▼** to select **Head Cleaning**, then press the **◇ Color** button.

A rectangular display screen with a black border. The text on the screen is in a pixelated font. The top line reads '3.Head Cleaning' and the bottom line reads 'Press the Color'. There is a small square icon to the left of the number '3'.

Cleaning lasts around 1 minute. When it's finished, you see a message on the display screen.

Caution:

Never turn off the printer during a cleaning cycle or you may damage it.

5. Press **1** to finish or **2** to run a nozzle check and confirm that the print head is clean.

Note:

If you don't see any improvement after cleaning the print head three times, turn off your NX300/305 Series and wait at least six hours to let any dried ink soften. Then try printing again. If quality does not improve, one of the ink cartridges may need to be replaced. If that doesn't help, contact Epson as described on page 44.

If you do not use your NX300/305 Series often, it is a good idea to print a few pages at least once a month to maintain good print quality.

Checking the Ink Cartridge Status

You can check the ink cartridge status anytime using the NX300/305 Series display screen. To check the ink cartridge status with your Windows or Macintosh software, see the instructions in your online *User's Guide*.

Note:

You cannot print or copy when an ink cartridge is expended even if the other cartridges are not expended. Replace any expended cartridges before printing or copying.

1. Press the **Copy/Fax** button, then press **Menu**.
2. Press **▲** or **▼** to select **Maintenance**, then press **OK**.
3. Press **▲** or **▼** to select **Ink Levels**, then press **OK**.
4. The cartridge status is displayed for each ink color: Cyan, Magenta, Yellow, and Black. In this example, the cartridges are full or nearly full.

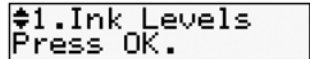

See page 38 to replace a cartridge, if necessary.

A window may also appear on your computer screen when you try to print when ink is low. This window can optionally display ink offers and other updates from Epson.

Note:

To disable checking for ink offers or updates from Epson, see the instructions in your online *User's Guide*.

Purchasing Epson Ink Cartridges

You can purchase genuine Epson ink and paper at Epson Supplies Central at www.epson.com/ink3 (U.S. sales) or www.epson.ca (Canadian sales). You can also purchase supplies from an Epson authorized reseller. To find the nearest one, call 800-GO-EPSON (800-463-7766).

Purchase genuine Epson cartridges and use them within six months of installing them and before the expiration date on the cartridge box. When you purchase new ink, use the following Epson ink cartridge numbers:

Ink color	Moderate use	Standard capacity	High capacity
Black	88	69	68
Cyan	88	69	—
Magenta	88	69	—
Yellow	88	69	—

Note:

We recommend that you use genuine Epson cartridges and do not refill them. The use of other products may affect your print quality and could result in printer damage.

Yields vary considerably based on images printed, print settings, paper type, frequency of use, and temperature. For print quality, a small amount of ink remains in the cartridge after the “replace cartridge” indicator comes on. The printer ships with full cartridges and part of the ink from the first cartridges is used for priming the printer.

For best printing results, use up a cartridge within six months of opening the package.

Store ink cartridges in a cool, dark place. If cartridges have been exposed to cold temperatures, allow them to warm up to room temperature for at least 3 hours before using them.

Replacing Ink Cartridges

Make sure you have a new ink cartridge before you begin. You must install new cartridges immediately after removing the old ones.

Caution:

Do not open ink cartridge packages until you are ready to install the ink. Cartridges are vacuum packed to maintain reliability.

Leave the expended cartridge(s) installed until you have obtained a replacement, or the ink remaining in the print head nozzles may dry out.

1. Turn on the NX300/305 Series.

If an ink cartridge is low or expended, you see a message on the NX300/305 Series display screen indicating which color to replace. Press OK.

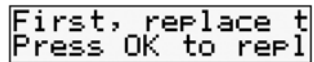

If you're replacing a cartridge before you see a message on the NX300/305 Series display screen, press the **Copy/Fax** button, press **Menu**, press **▲** or **▼** to select **Maintenance**, and press **OK**. Then select **Ink Cartridge Replacement** and press **OK**.

2. Lift up the scanner, then open the cartridge cover.

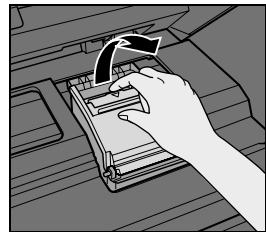
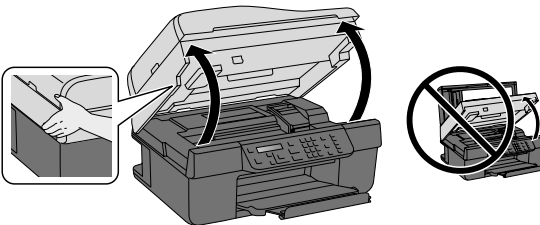

3. Squeeze the tab on the cartridge and lift it up. Dispose of it carefully. Do not take the used cartridge apart or try to refill it.

Warning:

If ink gets on your hands, wash them thoroughly with soap and water. If ink gets into your eyes, flush them immediately with water. Keep ink cartridges out of the reach of children.



- Before you open the new cartridge package, shake it four or five times. Then remove it from the package.

Caution:

Do not touch the green chip on the back of the cartridge, or you may damage it.

- Remove the yellow tape from the bottom of the ink cartridge.

Caution:

Do not remove any other labels or seals, or ink will leak.

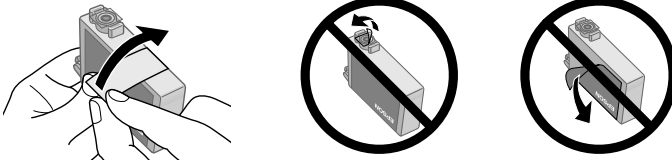

- Insert the new ink cartridge into the holder and push it down until it clicks into place.

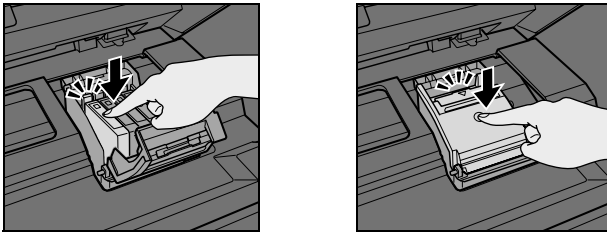

- Once you replace all the cartridges that need replacing, close the cartridge cover and push it down until it clicks into place.
- Lower the scanner.
- Press **OK** to begin charging the ink. This takes about 2 minutes. When you see a completion message on the display screen, ink charging is finished.
- Press **Menu** to exit.

Caution:

Never turn off the NX300/305 Series while ink is charging, or you'll waste ink. If you see an ink replacement message on the display screen, press **OK** and press down all the cartridges securely.

If you remove a low or expended ink cartridge, you cannot reinstall and use the cartridge.

Solving Problems

If you have a problem with your NX300/305 Series, check the messages on the display screen to diagnose the cause.

You can also check “Problems and Solutions” on page 41 for basic troubleshooting suggestions, or double-click the *User’s Guide* icon on your computer desktop for more detailed help.

Checking for Software Updates

Periodically, it’s a good idea to check Epson’s support website for free updates to your Epson Stylus NX300/305 Series software.

Open your online *User’s Guide* and select **Download the Latest Software** or visit Epson’s support website at **epson.com/support** (U.S.) or **epson.ca/support** (Canada).



With Windows, you can select **Driver Update** on the **Maintenance** tab in the printer settings window. You can also click  or **Start**, select **All Programs** or **Programs**, select **EPSON**, select **EPSON NX300 Series**, and click **Driver Update**.

Error Indicators

Follow the instructions on the display screen to solve most common problems. If you see one of the error messages below, follow the steps here to proceed.

LCD display screen message	Problem and solution
Printer error See your documentation.	Turn the NX300/305 Series off, make sure no paper is jammed inside (see page 42), and turn it back on. If the error is not resolved, contact Epson for help (see page 44).
Scanner error See your documentation.	Turn the NX300/305 Series off and then back on. If the error is not resolved, contact Epson for help (see page 44).
The printer's ink pads are nearing the end of their service life.	Contact Epson to replace ink pads before the end of their service life (see page 44). When the ink pads are saturated, you must replace them to continue printing.
The printer's ink pads are at the end of their service life.	Contact Epson to replace ink pads (see page 44).

Problems and Solutions

Check the solutions below if you're having trouble using your all-in-one.

Note:

If the screen shows only the clock, the NX300/305 Series is in sleep mode to save power. Press any button (except the  **On** button) to wake it up.

Printing and Copying Problems

- Make sure your paper is loaded printable side up (usually the whiter, brighter, or glossy side). Load it short edge first, and against the right edge guide. Don't load paper above the arrow mark inside the left edge guide.
- Make sure the type of paper you loaded matches the paper size and paper type settings on the control panel when copying or faxing, or in your printer software when printing from your computer (see page 30).

- Use the Automatic Document Feeder to fax or scan legal-size documents, but not to copy them. Letter-size paper is automatically selected for copying. If you copy a legal-size document, your image will be cropped.
- Make sure your original is positioned against the back left corner of the scanner glass. If the edges are cropped, move your original away from the edges slightly.

Paper Feeding Problems

If paper doesn't feed correctly when printing, remove the paper and flip through the stack to separate the sheets. Reload the paper against the right side and slide the edge guide against it. Do not load too many sheets at once. Load up to 20 sheets of photo paper or 100 sheets of plain paper. Load other special papers one sheet at a time.

If paper has jammed, follow these steps:

1. Gently pull out jammed paper from the output tray or sheet feeder.
2. If paper is stuck inside, press the  On button to turn off the NX300/305 Series. Then lift the scanner, remove the jammed paper and torn pieces, close the scanner, and turn the NX300/305 Series back on.

If documents don't feed correctly in the Automatic Document Feeder, make sure the corners of the paper are not bent, folded, or curled up. Do not load more than 30 sheets of letter- or 10 sheets of legal-size paper at a time. If documents have jammed:

1. Open the ADF cover and remove any jammed paper.



Caution:

Do not try to remove the paper without opening the ADF cover first, or you could damage the mechanism.

2. The message on the display screen asks if the paper has been removed. Press 1 to clear the message.
3. Close the ADF cover and reload the paper.

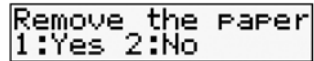

Remove the Paper
1:Yes 2:No

Faxing Problems

- Make sure the recipient's fax machine is turned on and working.
- Make sure the **LINE** port on the NX300/305 Series is connected to a telephone wall jack. Verify that the telephone wall jack works by connecting a phone to it.
- If the line has static, press **Setup**, select **Fax Settings**, select **Communication**, and turn off the **V.34** and **ECM** (Error Correction Mode) settings.
- If the NX300/305 Series is connected to a DSL phone line, you must have a DSL filter connected to the phone jack. Contact your DSL provider for the necessary filter.
- If you answer the phone and hear a fax tone and the call disconnects when you hang up, make sure the phone is connected to the **EXT.** port on the NX300/305 Series (see page 14).

Print Quality Problems

- For the best print quality, use genuine Epson paper (see page 6) and ink cartridges (see page 37).
- If you notice light or dark bands across your printouts or they are too faint, run a nozzle check (see page 34) to see if the print head needs cleaning.
- If you notice jagged vertical lines, you may need to align the print head. See the online *User's Guide* for instructions.
- The ink cartridges may be low on ink. Check your cartridge status (see page 36) and replace cartridges, if necessary (see page 38).
- If you're copying, place the document flat against the scanner glass.
- Clean the scanner glass with a soft, dry, lint-free cloth (paper towels are not recommended), or use a small amount of glass cleaner on a soft cloth, if necessary. Do not spray glass cleaner directly on the glass.

Where to Get Help

Epson Technical Support

Internet Support

Visit Epson's support website at epson.com/support and select your product for solutions to common problems. You can download drivers and documentation, get FAQs and troubleshooting advice, or e-mail Epson with your questions.

Speak to a Support Representative

Before you call Epson for support, please have the following information ready:

- Product name (Epson Stylus NX300/305 Series)
- Product serial number (located on the label in back)
- Proof of purchase (such as a store receipt) and date of purchase
- Computer configuration and description of the problem

Then call:

- U.S.: (562) 276-4382, 6 AM – 6 PM, Pacific Time, Monday through Friday
- Canada: (905) 709-3839, 6 AM – 6 PM, Pacific Time, Monday through Friday

Days and hours of support are subject to change without notice. Toll or long distance charges may apply.

Purchase Supplies and Accessories

You can purchase genuine Epson ink and paper at Epson Supplies Central at www.epson.com/ink3 (U.S. sales) or www.epson.ca (Canadian sales). You can also purchase supplies from an Epson authorized reseller. To find the nearest one, call 800-GO-EPSON (800-463-7766).

Other Software Technical Support

ABBYY® FineReader®

Phone: (510) 226-6717

www.abbyyusa.com

support@abbyyusa.com

Notices

Important Safety Instructions

Before using your all-in-one, read and follow these safety instructions:

- Be sure to follow all warnings and instructions marked on the product.
- Use only the type of power source indicated on the product label.
- Use only the power cord that comes with the product. Use of another cord may cause fires or shock. Do not use the cord with any other equipment.
- Place the product near a wall outlet where the plug can be easily unplugged.
- If you won't be using the product for a long period, unplug the power cord from the electrical outlet.
- Always turn off the product using the ⏻ On button, and wait until the ⏻ On light stops flashing before unplugging the printer or cutting off power to the electrical outlet.
- Avoid plugging the product into an outlet on the same circuit as a photocopier or air conditioning system that regularly switches on and off, or on an outlet controlled by a wall switch or timer.
- Do not let the power cord become damaged or frayed.
- If you use an extension cord with the product, make sure the total ampere rating of the devices plugged into the extension cord does not exceed the cord's ampere rating. Also, make sure the total ampere rating of all devices plugged into the wall outlet does not exceed the wall outlet's ampere rating.
- Place the product on a flat, stable surface that extends beyond its base in all directions. It will not operate properly if it is tilted or at an angle.
- When storing or transporting the product, do not tilt it, stand it on its side, or turn it upside down; otherwise ink may leak from the cartridges.
- Avoid placing the product in locations that are subject to rapid changes in heat or humidity, shocks or vibrations, or dust.
- Leave enough room around the product for sufficient ventilation. Make sure the product is at least 4 inches (10 cm) away from the wall.
- Do not place the product near a radiator or heating vent or in direct sunlight.
- Do not block or cover openings in the product case or insert objects through the slots.

- Do not use aerosol products that contain flammable gases inside or around the printer. Doing so may cause fire.
- Do not press too hard on the document table when placing the originals.
- Do not open the scanner section while the product is in use.
- Do not touch the flat white cable inside the product.
- Do not spill liquid on the product.
- Adjust only those controls that are covered by the operating instructions. Except as specifically explained in your documentation, do not attempt to service the product yourself.
- Unplug the product and refer servicing to qualified service personnel under the following conditions: if the power cord or plug is damaged; if liquid has entered the product; if the product has been dropped or the case damaged; if the product does not operate normally or exhibits a distinct change in performance.

LCD Screen Safety

- Use only a dry, soft cloth to clean the LCD screen. Do not use liquid or chemical cleansers.
- If the LCD screen is damaged, contact Epson. If the liquid crystal solution gets on your hands, wash them thoroughly with soap and water. If the liquid crystal solution gets into your eyes, flush them immediately with water. If discomfort or vision problems remain after a thorough flushing, see a doctor immediately.

Ink Cartridge Safety Instructions

- Keep ink cartridges out of the reach of children and do not drink the ink.
- Be careful when you handle used ink cartridges; there may be ink remaining around the ink supply port. If ink gets on your skin, wash it off with soap and water. If it gets in your eyes, flush them immediately with water. If you still have discomfort or vision problems, see a doctor immediately.
- Do not put your hand inside the product or touch any cartridges during printing.
- Install a new ink cartridge immediately after removing an expended one. Leaving cartridges uninstalled can dry out the print head and may prevent the product from printing.
- If you remove an ink cartridge for later use, protect the ink supply area from dirt and dust and store it in the same environment as the product. Note that there is a valve in the ink supply port, making covers or plugs unnecessary, but care is needed to prevent the ink from staining items that the cartridge touches. Do not touch the ink cartridge ink supply port or surrounding area. Do not store the cartridge upside down.

Telephone Equipment Safety Instructions

When using telephone equipment, you should always follow basic safety precautions to reduce the risk of fire, electric shock, and personal injury, including the following:

- Do not use the Epson product near water.
- Avoid using a telephone during an electrical storm. There may be a remote risk of electric shock from lightning.
- Do not use a telephone to report a gas leak in the vicinity of the leak.

Caution:

To reduce the risk of fire, use only a No. 26 AWG or larger telecommunication line cord.

Epson America, Inc., Limited Warranty

What Is Covered: Epson America, Inc. (“Epson”) warrants to the original retail purchaser that the Epson printer covered by this limited warranty statement, if purchased and operated only in the United States or Canada, will be free from defects in workmanship and materials for a period of one (1) year from the date of original purchase. For warranty service, you must provide proof of the date of original purchase.

What Epson Will Do To Correct Problems: Should your Epson printer prove defective during the warranty period, please call the Epson ConnectionSM at (562) 276-4382 (U.S.) or (905) 709-3839 (Canada) for warranty repair instructions and return authorization. An Epson service technician will provide telephone diagnostic service to determine whether the printer requires service. If service is needed, Epson will, at its option, exchange or repair the printer without charge for parts or labor. If Epson authorizes an exchange for the defective unit, Epson will ship a replacement printer to you, freight prepaid, so long as you use an address in Canada or the U.S. (excluding Puerto Rico and U.S. Possessions). Shipments to other locations will be made freight collect. You are responsible for securely packaging the defective unit and returning it to Epson within five (5) working days of receipt of the replacement. Epson requires a debit or a credit card number to secure the cost of the replacement printer in the event that you fail to return the defective one. If your printer is being repaired, Epson will direct you to send your printer to Epson or its authorized service center, where the printer will be fixed and sent back to you. You are responsible for packing the printer and for all costs to and from the Epson authorized service center. When warranty service involves the exchange of the printer or a part, the item replaced becomes Epson property. The replacement printer or part may be new or refurbished to the Epson standard of quality, and, at Epson’s option, may be another model of like kind and quality. Epson’s liability for replacement of the covered printer will not exceed the original retail selling price of the covered printer. Exchange products and parts assume the remaining warranty period of your original product covered by this limited warranty.

What This Warranty Does Not Cover: This warranty covers only normal use in the United States and Canada. Using this product for continuous production or similar high duty purposes is not considered normal use; damage, maintenance or service from such use will not be covered under this warranty. This warranty is not transferable. This warranty does not cover any color change or fading of prints or reimbursement of materials or services required for reprinting. This warranty does not cover damage to the Epson product caused by parts or supplies not manufactured, distributed or certified by Epson. This warranty does not cover ribbons, ink cartridges or third party parts, components, or peripheral devices added to the Epson product after its shipment from Epson, e.g., dealer or user-added boards or components. Epson is not responsible for warranty service should the Epson label or logo or the rating label or serial number be removed or should the product fail to be properly maintained or fail to function properly as a result of misuse, abuse, improper installation, neglect, improper shipping, damage caused by disasters such as fire, flood, and lightning, improper electrical current, software problems, interaction with non-Epson products, or service other than by an Epson Authorized Servicer. If a claimed defect cannot be identified or reproduced, you will be held responsible for the costs incurred.

THE WARRANTY AND REMEDY PROVIDED ABOVE ARE EXCLUSIVE AND IN LIEU OF ALL OTHER EXPRESS OR IMPLIED WARRANTIES INCLUDING, BUT NOT LIMITED TO, THE IMPLIED WARRANTIES OF MERCHANTABILITY, NON-INFRINGEMENT OR FITNESS FOR A PARTICULAR PURPOSE. SOME LAWS DO NOT ALLOW THE EXCLUSION OF IMPLIED WARRANTIES. IF THESE LAWS APPLY, THEN ALL EXPRESS AND IMPLIED WARRANTIES ARE LIMITED TO THE WARRANTY PERIOD IDENTIFIED ABOVE. UNLESS STATED HEREIN, ANY STATEMENT OR REPRESENTATIONS MADE BY ANY OTHER PERSON OR FIRM ARE VOID. EXCEPT AS PROVIDED IN THIS WRITTEN WARRANTY, NEITHER EPSON AMERICA, INC. NOR ITS AFFILIATES SHALL BE LIABLE FOR ANY LOSS, INCONVENIENCE, OR DAMAGE, INCLUDING DIRECT, SPECIAL, INCIDENTAL OR CONSEQUENTIAL DAMAGES, RESULTING FROM THE USE OR INABILITY TO USE THE EPSON PRODUCT, WHETHER RESULTING FROM BREACH OF WARRANTY OR ANY OTHER LEGAL THEORY.

In Canada, warranties include both warranties and conditions.

Some jurisdictions do not allow limitations on how long an implied warranty lasts, and some jurisdictions do not allow the exclusion or limitation of incidental or consequential damages, so the above limitations and exclusions may not apply to you. This warranty gives you specific legal rights and you may have other rights which vary from jurisdiction to jurisdiction.

To find the Epson Authorized Reseller nearest you, visit our website at:
<http://www.epson.com>.

To find the Epson Customer Care Center nearest you, visit: <http://epson.com/support>.

You can also write to:

Epson America, Inc., P.O. Box 93012, Long Beach, CA 90809-3012

Declaration of Conformity

According to 47CFR, Part 2 and 15 for: Class B Personal Computers and Peripherals;
and/or CPU Boards and Power Supplies used with Class B Personal Computers:

We: Epson America, Inc.
Located at: MS 3-13
3840 Kilroy Airport Way
Long Beach, CA 90806
Telephone: (562) 290-5254

Declare under sole responsibility that the product identified herein, complies with 47CFR Part 2 and 15 of the FCC rules as a Class B digital device. Each product marketed is identical to the representative unit tested and found to be compliant with the standards. Records maintained continue to reflect the equipment being produced can be expected to be within the variation accepted, due to quantity production and testing on a statistical basis as required by 47CFR §2.909. Operation is subject to the following two conditions: (1) this device may not cause harmful interference, and (2) this device must accept any interference received, including interference that may cause undesired operation.

Trade Name: Epson
Type of Product: Multifunction printer
Model: C362A

FCC Compliance Statement

For United States Users

This equipment complies with Part 68 of the FCC rules and the requirements adopted by the ACTA. On the back side is a label that contains, among other information, the FCC registration number and the **ringer equivalence number (REN)** for this equipment. You must, upon request, provide this information to your local telephone company. The information associated with the services the equipment is to be connected are REN: **0.1B**, Jack type: **RJ-11C**.

The REN is useful to determine the quantity of devices that you may connect to your telephone line and still have all of those devices ring when your telephone number is called. In most, but not all areas, the sum of the RENs of all devices connected to one line should not exceed five (5.0). To be certain of the number of devices that you may connect to your line, you may want to contact your local telephone company to determine the maximum REN for your calling area. For products approved after July 23, 2001, the REN for this product is part of the product identifier that has the format **US: BKMEFA01BC362A**. The digits represented by 01 are the REN without a decimal point (e.g., 01 is a REN of 0.1). For earlier products, the REN is separately shown on the label.

This equipment may not be used on coin service provided by the telephone company. Connection to party lines is subject to state tariffs.

Should this equipment cause harm to the telephone network, the telephone company may discontinue your service temporarily. If possible they will notify you in advance that temporary discontinuance of service may be required. But if advanced notice isn't practical, the telephone company will notify you as soon as possible. You will be informed of your right to file a complaint with the FCC. The telephone company may make changes in its facilities, equipment, operations or procedures that could affect the proper functioning of your equipment. If they do, you will be notified in advance to give you an opportunity to maintain uninterrupted telephone service.

This product is not intended to be repaired. If you experience trouble with this equipment, please contact:

Name: Epson America, Inc.
Address: 3840 Kilroy Airport Way, Long Beach, CA 90806 U.S.A.
Telephone: (562) 981-3840

The telephone company may ask that you disconnect this equipment from the network until the problem has been corrected or until you are sure that the equipment is not malfunctioning.

A plug and jack used to connect this equipment to the premises wiring and telephone network must comply with the applicable FCC Part 68 rules and requirements adopted by the ACTA. A compliant telephone cord and modular plug is provided with this product. It is designed to be connected to a compatible modular jack that is also compliant. See installation instructions for details.

The Telephone Consumer Protection Act of 1991 makes it unlawful for any person to use a computer or other electronic device, including fax machines, to send any message unless such message clearly contains in a margin at the top or bottom of each transmitted page or on the first page of the transmission, the date and time it is sent and an identification of the business or other entity, or other individual sending the message and the telephone number of the sending machine or such business, other entity, or individual. In order to program this information into your fax machine, follow the instructions in “Entering Fax Header Information” on page 16.

According to the FCC’s electrical safety advisory, we recommend that you may install an AC surge arrester in the AC outlet to which this equipment is connected. Telephone companies report that electrical surges, typically lightning transients, are very destructive to customer terminal equipment connected to AC power sources and that this is a major nationwide problem.

If your home has specially wired alarm equipment connected to the telephone line, ensure the installation of this equipment Model C362A does not disable your alarm equipment. If you have questions about what will disable alarm equipment, consult your telephone company or a qualified installer.

This equipment has been tested and found to comply with the limits for a Class B digital device, pursuant to Part 15 of the FCC Rules. These limits are designed to provide reasonable protection against harmful interference in a residential installation. This equipment generates, uses, and can radiate radio frequency energy and, if not installed and used in accordance with the instructions, may cause harmful interference to radio or television reception. However, there is no guarantee that interference will not occur in a particular installation. If this equipment does cause interference to radio and television reception, which can be determined by turning the equipment off and on, the user is encouraged to try to correct the interference by one or more of the following measures:

- Reorient or relocate the receiving antenna.
- Increase the separation between the equipment and receiver.
- Connect the equipment into an outlet on a circuit different from that to which the receiver is connected.
- Consult the dealer or an experienced radio/TV technician for help.

WARNING

The connection of a non-shielded equipment interface cable to this equipment will invalidate the FCC Certification of this device and may cause interference levels which exceed the limits established by the FCC for this equipment. It is the responsibility of the user to obtain and use a shielded equipment interface cable with this device. If this equipment has more than one interface connector, do not leave cables connected to unused interfaces. Changes or modifications not expressly approved by the manufacturer could void the user's authority to operate the equipment.

For Canadian Users

1. This product meets the applicable Industry Canada technical specifications.

Le présent matériel est conforme aux spécifications techniques applicables d'Industrie Canada.

2. The Ringer Equivalence Number is an indication of the maximum number of devices allowed to be connected to a telephone interface. The termination on an interface may consist of any combination of devices subject only to the requirement that the sum of the RENs of all the devices does not exceed five.

L'indice d'équivalence de la sonnerie (IES) sert à indiquer le nombre maximal de terminaux qui peuvent être raccordés à une interface téléphonique. La terminaison d'une interface peut consister en une combinaison quelconque de dispositifs, à la seule condition que la somme d'indices d'équivalence de la sonnerie de tous les dispositifs n'excède pas 5.

This Class B digital apparatus complies with Canadian ICES-003.

Cet appareil numérique de la classe B est conforme à la norme NMB-003 du Canada.

Copyright Notice

All rights reserved. No part of this publication may be reproduced, stored in a retrieval system, or transmitted in any form or by any means, electronic, mechanical, photocopying, recording, or otherwise, without the prior written permission of Seiko Epson Corporation. The information contained herein is designed only for use with this Epson product. Epson is not responsible for any use of this information as applied to other equipment.

Neither Seiko Epson Corporation nor its affiliates shall be liable to the purchaser of this product or third parties for damages, losses, costs, or expenses incurred by purchaser or third parties as a result of: accident, misuse, or abuse of this product or unauthorized modifications, repairs, or alterations to this product, or (excluding the U.S.) failure to strictly comply with Seiko Epson Corporation's operating and maintenance instructions.

Seiko Epson Corporation shall not be liable for any damages or problems arising from the use of any options or any consumable products other than those designated as Original Epson Products or Epson Approved Products by Seiko Epson Corporation.

Responsible Use of Copyrighted Materials

Epson encourages each user to be responsible and respectful of the copyright laws when using any Epson product. While some countries' laws permit limited copying or reuse of copyrighted material in certain circumstances, those circumstances may not be as broad as some people assume. Contact your legal advisor for any questions regarding copyright law.

Trademarks

Epson and Epson Stylus are registered trademarks, Epson Exceed Your Vision is a registered logomark, and Supplies Central is a service mark of Seiko Epson Corporation.

Epson Connection is a service mark of Epson America, Inc.

General Notice: Other product names used herein are for identification purposes only and may be trademarks of their respective owners. Epson disclaims any and all rights in those marks.

This information is subject to change without notice.

© 2009 Epson America, Inc. 12/09



EPSON[®]
EXCEED YOUR VISION



411881000

CPD-27761R1
Printed in XXXXXX

Free Manuals Download Website

<http://myh66.com>

<http://usermanuals.us>

<http://www.somanuals.com>

<http://www.4manuals.cc>

<http://www.manual-lib.com>

<http://www.404manual.com>

<http://www.luxmanual.com>

<http://aubethermostatmanual.com>

Golf course search by state

<http://golfingnear.com>

Email search by domain

<http://emailbydomain.com>

Auto manuals search

<http://auto.somanuals.com>

TV manuals search

<http://tv.somanuals.com>