

zūmoTM 500/550



the personal motorcycle navigator

© 2006–2007 Garmin Ltd. or its subsidiaries

Garmin International, Inc.
1200 East 151st Street,
Olathe, Kansas 66062, USA
Tel. 913/397.8200
or 800/800.1020
Fax 913/397.8282

Garmin (Europe) Ltd.
Liberty House, Hounslow Business Park,
Southampton, Hampshire, SO40 9RB UK
Tel.+44 (0) 870.8501241 (outside the UK)
0808 2380000 (within the UK)
Fax +44 (0) 870.8501251

Garmin Corporation
No. 68, Jangshu 2nd Road,
Shijr, Taipei County, Taiwan
Tel. 886/2.2642.9199
Fax 886/2.2642.9099

All rights reserved. Except as expressly provided herein, no part of this manual may be reproduced, copied, transmitted, disseminated, downloaded or stored in any storage medium, for any purpose without the express prior written consent of Garmin. Garmin hereby grants permission to download a single copy of this manual onto a hard drive or other electronic storage medium to be viewed and to print one copy of this manual or of any revision hereto, provided that such electronic or printed copy of this manual must contain the complete text of this copyright notice and provided further that any unauthorized commercial distribution of this manual or any revision hereto is strictly prohibited.

Information in this document is subject to change without notice. Garmin reserves the right to change or improve its products and to make changes in the content without obligation to notify any person or organization of such changes or improvements. Visit the Garmin Web site (www.garmin.com) for current updates and supplemental information concerning the use and operation of this and other Garmin products.

Garmin® and MapSource® are trademarks of Garmin Ltd. or its subsidiaries, registered in the USA and other countries. zūmo™, MyGarmin™, Garmin Travel Guide™, Garmin TourGuide™, Garmin Lock™, GTM™, and

GXM™ are trademarks of Garmin Ltd. or its subsidiaries. These trademarks may not be used without the express permission of Garmin.

The Bluetooth® word mark and logos are owned by the Bluetooth SIG, Inc. and any use of such marks by Garmin is under license. Windows® is a registered trademark of Microsoft Corporation in the United States and/or other countries. Mac® and iTunes® are registered trademarks of Apple Computer, Inc. The Winamp trademark is the property of Nullsoft, Inc. and its parent company, America Online, Inc. Audible.com® and AudibleReady® are registered trademarks of Audible, Inc. © Audible, Inc. 1997-2005. SiRF®, SiRFstar® and the SiRF logo are registered trademarks of SiRF Technology, Inc. SiRFstarIII™ and SiRF Powered™ are trademarks of SiRF Technology, Inc. Google™ and Google Earth™ are trademarks of Google Inc. RDS-TMC Traffic Information Services France © ViaMichelin 2006. SaversGuide® is a registered trademark of Entertainment Publications, Inc. XM™ is a trademark of XM Satellite Radio Inc. Other trademarks and trade names are those of their respective owners.



February 2007

Part Number 190-00697-00 Rev. B

PREFACE

Thank you for purchasing the Garmin® zūmo™.

Manual Conventions

When you are instructed to “touch” something, use your finger to touch an item on the screen. You will see arrows (>) used in the text. They indicate that you should touch a series of items. For example, if you see “touch **Where to > Favorites**,” you should touch the **Where to** button, and then touch **Favorites**.

Contact Garmin

Contact Garmin if you have any questions while using your zūmo. In the USA, contact Garmin Product Support by phone: 913/397.8200 or 800/800.1020, Monday–Friday, 8 AM–5 PM Central Time; or go to www.garmin.com/support, and click **Product Support**.

In Europe, contact Garmin (Europe) Ltd. at +44 (0) 870.8501241 (outside the UK) or 0808 2380000 (within the UK).

myGarmin™

Go to <http://my.garmin.com> to access the latest services for your Garmin products. From the myGarmin Web site, you can:

- Register your Garmin unit.
- Subscribe to online services for safety camera information (see [page 55](#)).
- Unlock optional maps.

Return to myGarmin often for new Garmin product services.

About Google Earth™

Go to <http://earth.google.com> to download the Google Earth application. With Google Earth installed on your computer, you can view waypoints, tracks, and routes saved in MapSource®. From the View menu, select **View in Google Earth**.

Preface	i	Go Home	12
Manual Conventions.....	i	Finding Points of Interest.....	12
Contact Garmin	i	Recently Found Locations.....	14
myGarmin.....	i	Favorites.....	14
About Google Earth.....	i	Creating a Saved Route	16
Important Information	iv	Finding a Location Using the Map	18
Getting Started	1	Entering Coordinates.....	19
Looking at Your zūmo.....	1	Expanding Your Search.....	19
Quick Links.....	2	Using the Main Pages	20
zūmo Tips and Shortcuts.....	2	Map Page	20
Adjusting the Volume.....	2	Trip Information Page.....	21
Adjusting the Brightness.....	2	Turn List Page	22
Mounting the zūmo on Your Motorcycle.....	3	Next Turn Page	22
Configuring Your zūmo	7	Compass Page.....	22
Acquiring Satellites.....	7	Using Hands-free Features	23
Using Your zūmo	7	Pairing Your Device	23
Finding Your Destination	8	Getting a Call.....	25
Following Your Route	9	Phone Menu	26
Adding a Stop.....	9	Traffic Information	30
Adding a Detour	10	Traffic in Your Area	30
Stopping the Route.....	10	Traffic on Your Route.....	30
Locking Your zūmo	10	Traffic Codes and Symbols	31
Where to	11	Purchasing Traffic Subscriptions....	32
Finding an Address.....	11		
Go Page Options.....	11		

Using XM	33	Charging the zūmo	52
Listening to XM Radio	33	Resetting the zūmo	52
Managing Files on Your zūmo	35	Calibrating the Screen	52
Supported File Types.....	35	Updating the zūmo Software	52
Deleting zūmo Files.....	37	Purchasing and Loading Additional Map Data	53
Using the Media Player	38	Optional Accessories.....	53
Listening to MP3 Files	38	Battery Information	57
Listening to Audible Books	39	Using a Remote Antenna	58
Customizing the zūmo	41	Caring for Your zūmo	58
Changing the Map Settings	41	About GPS Satellite Signals.....	60
Changing the System Settings	42	Specifications	60
Localizing Your zūmo	42	zūmo Troubleshooting	62
Managing User Data	43	USB Interface Troubleshooting	63
Bluetooth Technology Settings	45	Index	65
Changing the Navigation Settings	46		
Customizing the Display	47		
Changing the Keyboard.....	48		
Managing Traffic Settings.....	48		
Restoring All Settings	48		
Clearing All User Data.....	48		
Appendix	49		
zūmo Audio Options	49		
Installing the zūmo in Your Automobile	50		



Important Information

See the *Important Safety and Product Information* guide in the product box for product warnings and other important information.





Declaration of Conformity

Hereby, Garmin declares that this product is in compliance with the essential requirements and other relevant provisions of Directive 1999/5/EC.

To view the full Declaration of Conformity, see the Garmin Web site for your Garmin product: www.garmin.com/products/zumo500 or www.garmin.com/products/zumo550. Click **Manuals**, and then click **Declaration of Conformity**.

GETTING STARTED

Looking at Your zūmo

- A.  Power button
- B.  Zoom in, raise volume, or increase brightness.
- C.  Zoom out, lower volume, or decrease brightness.
- D.  Page button—scroll through the Map, Compass, Trip Information, Media Player, and Phone Menu pages. Press and hold to adjust brightness.
- E.  Speak button—press to adjust volume level. Press and hold to announce voice directions.

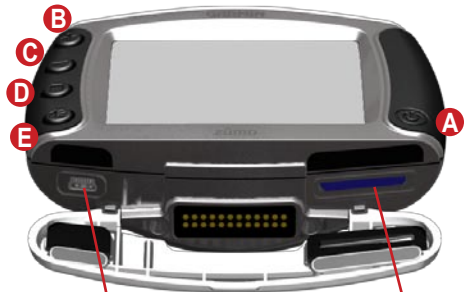

Mini-USB port for AC power, USB Mass Storage mode, and updating software





SD card slot







Battery pack (see [page 57](#))

MCX connector under weather cap (see [page 58](#))



zūmo Tips and Shortcuts

- Touch and hold  to quickly return to the Menu page.
- Press  to return to the map.
- Touch  and  to see more choices.
- Touch  to adjust settings such as volume, brightness, language, and keyboard.

Adjusting the Volume

Press , and then use  and  to adjust the volume. For advanced volume settings, touch  >  **Volume**.

Adjusting the Brightness

Press and hold , and then use  and  to adjust the brightness. See [page 47](#) for additional display settings.

Quick Links

- Finding an address: [page 11](#)
- Viewing the map: [page 20](#)
- Using hands-free mobile phone features: [page 23](#)
- Using the Garmin Lock™ anti-theft feature: [page 10](#)
- Listening to MP3 files: [page 38](#)
- Transferring files to your zūmo: [pages 35–37](#)
- zūmo audio options, see [page 49](#)
- Cleaning and storing your zūmo: [page 58](#)
- Mounting the zūmo in your automobile: [page 50](#)

Fill out the product documentation survey. Go to www.garmin.com/contactUs, and click **Product Documentation Survey**.

Mounting the zūmo on Your Motorcycle



WARNING: The terms of the Garmin warranty require that the power cable with bare wire leads be installed by experienced installers having the proper knowledge of automotive electrical systems and skill in the use of special tools or hardware required for installation.

1: Connect Power to the Mount

Select a suitable and secure location to mount the zūmo on your motorcycle based on available power sources and safe cable routing.



About Connecting Audio

Standard jacks for microphone (2.5 mm) and audio out (3.5 mm) are located on the left side of the mount (under a weather cap). When connecting your audio system to the zūmo, be sure to consider the pathways needed to route the necessary cables. For information about hands-free audio and phone options, see [page 23](#). For additional audio configurations, see [page 49](#).

2: Install the Handlebar Base

The zūmo includes parts for two handlebar installation solutions. Custom mounts can require additional hardware (www.ram-mount.com).

A) To install the U-bolt and handlebar base:

1. Place the U-bolt around the handlebar, and thread the ends through the handlebar base.
2. Tighten the nuts to secure the base. Do not overtighten.



NOTE: The recommended torque is 50in-lb. Do not exceed maximum torque of 80in-lb.

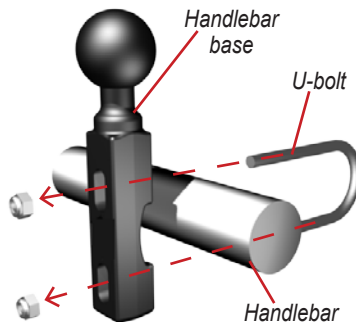

B) To install the handlebar base to the clutch/brake clamp bracket:



NOTE: Both 1/4" standard and M6 bolts are included. Match the size of the factory bolts on your clutch/brake clamp bracket.

1. Remove the two factory bolts on your clutch/brake clamp bracket.
2. Thread the new bolts through the handlebar base, spacers, and clamp bracket.
3. Tighten the bolts to secure the base.

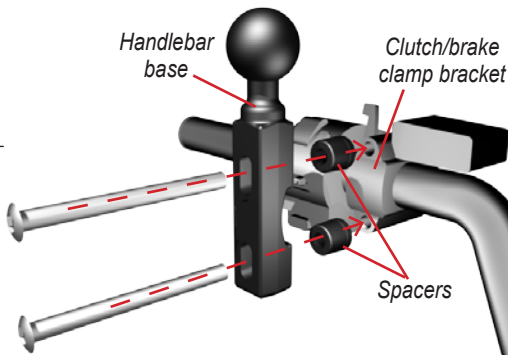

3: Attach the Base Plate to the zūmo Mount

1. Thread the M4 x 40 mm flathead bolts and nuts to attach the base plate to the zūmo mount.
2. Tighten the nuts to secure the base plate.

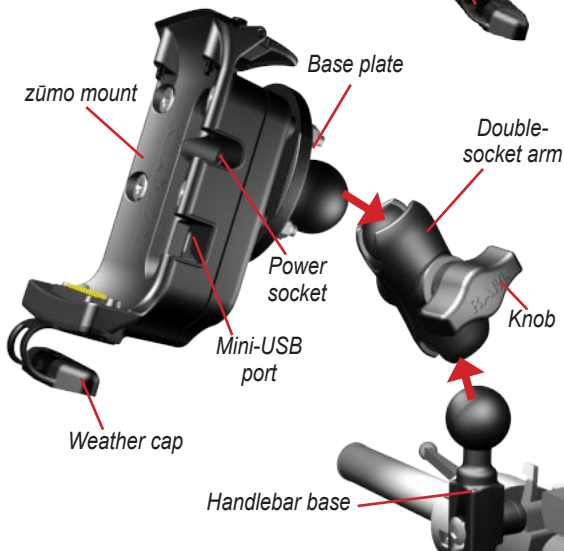
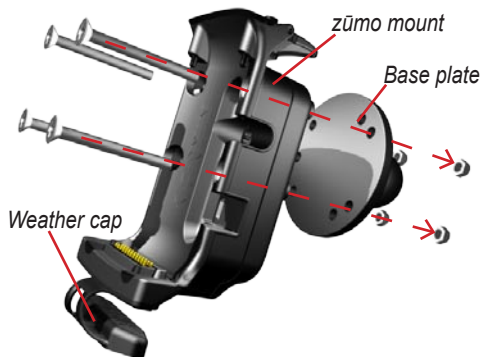

4: Attach the Base Plate to the Handlebar Base

1. Align the ball of the handlebar base and the ball of the base plate with the double-socket arm.
2. Tighten the knob slightly.
3. Adjust for better viewing and operation.
4. Tighten the knob to secure the mount.

5: Install the zūmo in the Mount

1. Plug the power cable into the zūmo mount.
For a better seal, tighten the screws on the power connector.
2. Flip the lever up.
3. Flip the weather cap down and under (magnetic).
4. Place the zūmo into the mount, and flip the lever down.
5. Tighten the security screw.



About the Security Screwdriver

Use the security screw to better secure the zūmo to the mount. You can connect the screwdriver to your key chain for easy access.



Configuring Your zūmo

To turn on your zūmo, press and hold . Follow the on-screen instructions to configure your zūmo.

Acquiring Satellites

Go outdoors to an open area, out of garages, and away from tall buildings. Stop your vehicle, and turn on the zūmo. Acquiring satellite signals may take a few minutes.

The  bars indicate GPS satellite strength. When the bars are green, your zūmo has acquired satellite signals, and you can start navigating.

Using Your zūmo

- A** Displays satellite strength.
- B** Displays phone and headset connection status.
- C** Displays battery status.
- D** Touch to find a destination.
- E** Touch to view the map.
- F** Touch to open the Phone menu (when connected to a mobile phone with Bluetooth® wireless technology).
- G** Touch to view traffic incidents (requires antenna or receiver and subscription).
- H** Touch to view XM weather and radio tuner (requires antenna and subscription).
- I** Touch to open the Media Player.
- J** Touch to adjust the zūmo's settings.



Finding Your Destination

The  Where to menu provides several different categories for you to use when you search for locations.

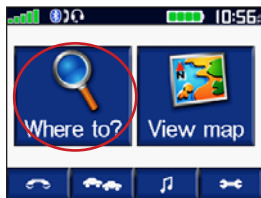

1 Touch  **Where to.**

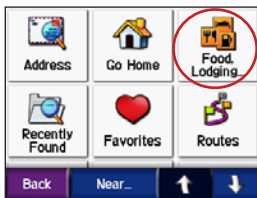

2 Select a category.

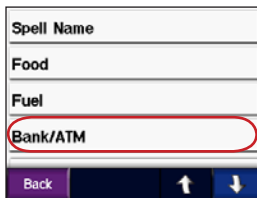

3 Select a sub-category.

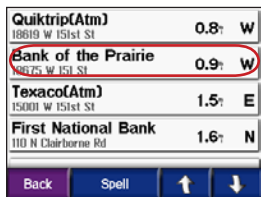

4 Select a destination.

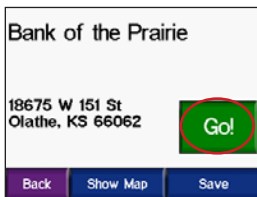

5 Touch **Go.**



6 Enjoy the route!

TIP: Touch  and  to see more choices.

Following Your Route

As you travel, your zūmo guides you to your destination with voice prompts, arrows on the map, and directions at the top of the map. If you depart from the original route, your zūmo recalculates the route and provides new directions.

*Your route is marked with a purple line.
Follow the arrows as you take turns.*

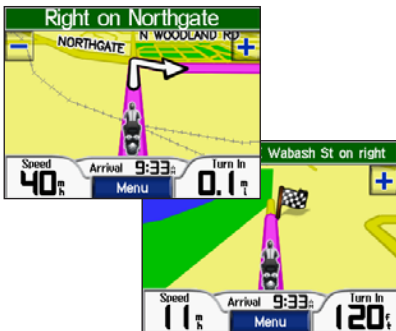

A checkered flag marks your destination.

Adding a Stop

You can add a stop (via point) to your route. The zūmo gives you directions to the stop and then to your final destination.



TIP: If you want to add more than one stop to the route, consider editing the active route. See [page 16](#).

1. With a route active, touch **Menu** on the map, and touch **Where to**.
2. Search for the extra stop.
3. Touch **Go**.
4. Touch **Add as Via Point** to add this stop before your destination. Touch **Set as new Destination** to make this your new final destination.

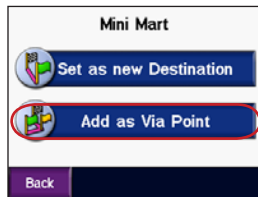

Adding a Detour



If a road on your route is closed, you can take a detour.

1. With a route active, touch **Menu**.
2. Touch **Detour**.

Stopping the Route

1. With a route active, touch **Menu**.
2. Touch **Stop**.

Locking Your zūmo

1. Touch  >  **System** > **Garmin Lock**.
2. Touch **OK**, and enter a four-digit PIN.
3. Re-enter your four-digit PIN.
4. Touch **OK**.
5. Drive to a security location, and touch **Set**.

Each time you turn on the zūmo, enter the four-digit PIN or drive to the security location.

What is a Security Location?

You can select any location, such as your home or office, for your security location. If you are at your security location, you do not need to enter a PIN. If you forget your PIN, drive to your security location to unlock the zūmo.



NOTE: To unlock your zūmo at your security location, the zūmo must have acquired satellite signals.





NOTE: If you forget your PIN and your security location, you must send your zūmo to Garmin to get it unlocked. You must also send a valid product registration or proof of purchase.

WHERE TO

The Where to menu provides several different categories you can use to search for locations. To learn how to perform a simple search, see [page 8](#).

Finding an Address

1. Touch  **Where to** >  **Address**.
2. Select a country, state/province, and city/postal code, if necessary.
3. Enter the address number, and touch **Done**.
4. Enter the street name until a list of streets appears, or touch **Done**.
5. Select the street and city, if necessary.
6. Select the address, if necessary. The Go page opens.
7. Touch **Go** to create a route to this address.

TIP: Do not enter the street prefix or suffix. For example, to find North Main Street enter Main, and to find Highway 7 enter 7.

About Postal Codes

You can search for a postal code. Enter the postal code instead of the city name. Not all map data provides postal code searching.

Intersections

Finding an intersection is very similar to finding an address. Touch  **Intersection**, and enter the two street names.

Go Page Options

Touch an item in the search results list to view the Go page.

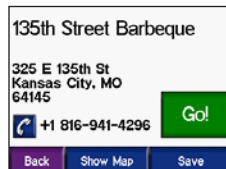

Touch **Go** to create a turn-by-turn route to this location.



Touch **Show Map** to view this location on the map. If the GPS is off, touch **Set Loc.** to set this as your current location.

Touch **Save** to save this location as one of your Favorites. See [page 14](#).

If a mobile phone with Bluetooth wireless technology is connected, touch  to call this location.

Go Home

You can set a home location for the place you return to most often.



1. Touch  **Where to** >  **Go Home**.
2. Select an option.

Going Home



After you set your home location, you can route to it at any time by touching

 **Where to** >  **Go Home**.

Changing Your Home Location



1. Touch  >  **User Data** > **Set Home Location**.
2. Select **Yes, enter my Address** or **Yes, use my current location**.

Finding Points of Interest

1. Touch  **Where to** >  **Food, Hotels**.
2. Select a category and a sub-category, if necessary. (Touch the arrows to see more categories.)
3. Select a destination.
4. Touch **Go**.

Finding a Location by Spelling the Name

If you know the name of the location you are looking for, you can spell it using the on-screen keyboard. You can also enter letters contained in the name to narrow the search.



1. Touch  **Where to** >  **Food, Hotels.**
2. Touch **Spell Name.**
3. Using the on-screen keyboard, enter letters in the name. Touch **Done.**
4. Touch the location you are looking for, and touch **Go.**

Using the On-Screen Keyboard

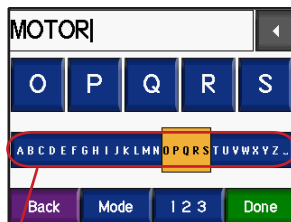
Touch and slide the yellow box to view the characters. Touch a character button to enter it.



TIP: Tap anywhere on the alphabet row to quickly move the yellow box.

Touch  to delete the last character entered; touch and hold  to delete the entire entry.

Touch  to change the keyboard mode to use diacritical characters or special characters.

Touch  to enter numbers.

To change the keyboard display, see [page 48](#).

Recently Found Locations

Your zūmo stores the last 50 of your recent finds in the Recently Found list.

The most recently viewed locations appear at the top of the list. Touch 

Where to >  **Recently Found** to view your recently found items.

Touch **Save** > **OK** to add a recently found location to your  Favorites.

Touch **Clear** > **Yes** to delete all locations from the Recently Found list.



NOTE: When you delete recently found locations, all items are removed from the list. It does not delete the actual location from your unit.

Favorites



You can save up to 500 locations in your Favorites, so you can quickly find them and create routes to them. Your home location is also stored in Favorites.

Saving Locations You Find

1. After you have found a location you want to save, touch **Save**.
2. Touch **OK**. The location is saved in  **Favorites**.

Sharing Locations

Share your Favorites with other zūmo owners. You must insert an SD card with available storage space.

1. Touch  **Where to** >  **Favorites**.
2. Select the location you want to share.
3. Touch **Share**.

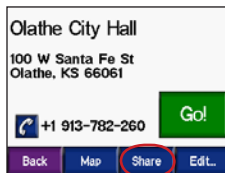

4. Verify that the correct location is selected, and then touch **Export**.
5. Touch **OK**.
6. Eject your SD card, and insert it into another zūmo.
7. A message appears. Touch **Yes** to import the shared locations.
8. Touch **Favorites**, and then touch the location you want to import.



9. Touch **Import**, and then touch **OK**.
10. Touch **Done** to go back to the Menu page.

Finding Saved Locations

Touch **Where to** > **Favorites**.
The locations are listed by distance from your current location. Touch **Spell** to narrow your search.

Saving Your Current Location

From the map, touch the vehicle icon. Touch **Yes** to save your current location as a Favorite.

Editing Saved Locations

1. Touch **Where to** > **Favorites**.
2. Touch the location you want to edit.
3. Touch **Edit**.





4. To edit the location:
Touch **Change Name**. Enter a name, and touch **Done**.
Touch **Change Map Symbol**. Touch a symbol.

Touch **Change Phone Number**. Enter a phone number, and touch **Done**.



Touch **Delete** to remove this item. A list of all your Favorites appears. Touch the item you want to delete. Touch **Delete** > **Yes**.

Creating a Saved Route



Use your zūmo to create and save routes before your next trip. You can save up to 50 routes.

1. Touch  **Where to** >  **Routes** > **New**.
2. Touch **Add New Start Point**.
3. Find a location as your starting point, and touch **Select**.
4. Touch **Add New End Point**.
5. Find a location as your ending point, and touch **Select**.



6. Touch  to add another location to your route. **TIP:** Touch **Near** to narrow your search, see [page 19](#). Touch  to remove a location.
7. Touch **Map** to calculate your route, and view it on the map.
8. Touch **Back** to exit and save the route.

Editing Saved Routes

1. Touch  **Where to** >  **Routes**.
2. Select the route you want to edit.
3. Touch **Edit**.

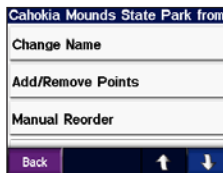

4. To edit the route:



- Touch **Change Name**. Enter a new name, and touch **Done**.
- Touch **Add/Remove Points** to add new start, via, or end points to the route.
- Touch **Manual Reorder** to change the order of points along your route.
- Touch **Optimal Reorder** to automatically order the points according to straight line distance between your start and end points.
- Touch **Recalculate** to change the route preference to calculate by faster time, shorter distance, or off road.
- Touch **Delete** to remove this item. A list of all your routes appears. Touch the item you want to delete. Touch **Delete > Yes**.



NOTE: Your changes are automatically saved when you exit any of the route edit pages.

Sharing Routes

Share your saved routes with other zūmo owners. You must insert an SD card with available storage space.

1. Touch  **Where to** >  **Routes**.
2. Select the route you want to share.
3. Touch **Share**.

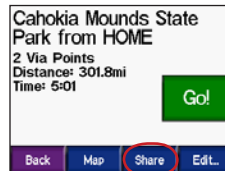

4. Verify that the correct route is selected, and then touch **Export**.
5. Touch **OK**.
6. Eject your SD card, and insert it into another zūmo.
7. A message appears. Touch **Yes** to import the shared route.
8. Touch **Routes**, and then touch the route you want to import.



9. Touch **Import**, and then touch **OK**.
10. Touch **Done** to go back to the Menu page. To view your imported routes, touch **Where to > Routes**.



NOTE: You can also share routes using Google Earth. Go to <http://earth.google.com>.

Finding a Location Using the Map

Touch **View map** to open the map. Touch and drag anywhere on the map to browse and view different parts of the map. You can also touch **Where to >** **>** **Browse Map**.

Tips for Browsing the Map

- Touch the map and drag to view different parts of the map.
- Touch and to zoom in and out.
- Touch any object on the map. An arrow appears pointing at the object you selected.
- Touch **Back** to return to the previous screen.
- Touch **Save** to save this location to your Favorites.
- Touch **Go** to create a turn-by-turn route to the location.
- If the GPS is off, touch **Set Loc.** to set the arrow location as your current location.

Entering Coordinates

If you know the geographic coordinates of your destination, you can use your zūmo to navigate to any location using its latitude and longitude coordinates.

Touch  **Where to** >  > 
Coordinates.

Enter Coordinates			
N	38 °	51 ' 23.5 "	
W	94 °	47 ' 57.1 "	
<div style="display: flex; justify-content: space-between;"> Back Format Next </div>			

Touch **Format** to change the type of coordinates. Because different maps and charts use different position formats, the zūmo allows you to choose the correct coordinate format for the type of map you are using.

Touch **Next** for more options:

- Touch **Go** to create a turn-by-turn route to the coordinates.
- Touch **Show Map** to view this location on the map.

- Touch **Save** to save this location to your  Favorites.

Expanding Your Search

1. Touch  **Where to** > **Near**.
2. Select an option:

Where I Am Now—searches near your current location.

A Different City—searches near the city you specify.

My Current Route—searches along the route you are currently navigating.

My Destination—searches for locations near your current route destination.



3. Touch **OK**.



NOTE: Your zūmo automatically searches near your current location.

USING THE MAIN PAGES

Map Page

On the Menu page, touch  **View map** to open the map. The  vehicle icon shows your current location.

*Touch the vehicle icon to view your current coordinates and elevation. Then touch **Yes** to save this location.*

Touch  to zoom out.

Touch **Menu** to return to the Menu page.

Touch **Speed** to open the Trip Information page.

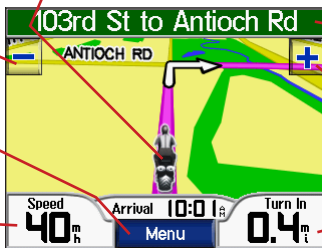

Touch the directions bar to open the Turn List page.

Touch  to zoom in.

Touch **Turn In** to open the Next Turn page.

Map Page while Navigating a Route



Trip Information Page

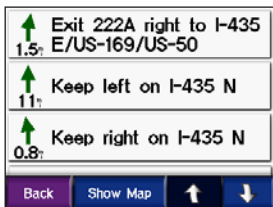

Turn List Page



Next Turn Page

Trip Information Page

The Trip Information page shows your current speed and provides helpful statistics about your trip. To view the Trip Information page, touch **Speed** on the map.

Resetting Trip Information

If you want accurate trip information, reset the trip information before beginning a trip. If you make frequent stops, leave the zūmo turned on so it can accurately measure elapsed time during the trip.

Touch **Reset** to reset the odometer, maximum speed, trip data, fuel gauge, and miles per tank.

Touch **More** to view speed data and travel time data.

Using the Fuel Gauge

The fuel gauge is for motorcycle use only. You can track your fuel usage when the zūmo is in the motorcycle mount. The fuel gauge is only as accurate as the data you enter.



1. On the map, touch **Speed** to open the Trip Information page.
2. Touch **Reset > Miles Per Tank**.
3. Enter an amount, and touch **Done**.
4. A message appears when you have 30 miles (~48.3 km) remaining.
5. On the map, touch the  icon to search for a nearby fuel station. Touch **OK**.
6. To reset the fuel gauge, go to the Trip Information page, and touch the fuel gauge > **Yes**.



Turn List Page

When you are navigating a route, the Turn List page shows turn-by-turn instructions for your entire route and the distance between turns. Touch the directions bar on the top of the map to open the Turn List page. Touch a turn on the list to view the Next Turn page for that turn. Touch **Show Map** to view the entire route on the map.

Next Turn Page

To view an upcoming turn on the map, touch **Turn In** on the map, or touch any turn from the Turn List page. When you are navigating a route, the Next Turn page shows the turn on the map and the distance and time left before you reach the turn. Touch  and  to view other turns in the route.

Compass Page

To view the Compass page, touch **Driving** on the map or press .

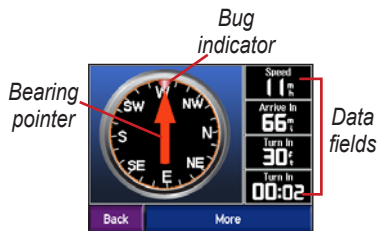

When you are navigating a route, the compass rotates and the bug indicator shows the direction you should be travelling to stay on the route. The bearing pointer indicates your current direction. If the arrow points up, you are going directly to the destination. If the arrow points any other direction, navigate the direction of the bug indicator until the arrow points up. Touch **More** to see additional data fields.

USING HANDS-FREE FEATURES

Using Bluetooth® wireless technology, your zūmo can connect to your mobile phone and wireless headset to become a hands-free device. To see if your device with Bluetooth technology is compatible with the zūmo, visit www.garmin.com/bluetooth.

Bluetooth wireless technology establishes a wireless link between devices, such as a mobile phone, wireless headset, and the zūmo. The first time you use two devices together you must “pair” them by establishing a relationship using a PIN/ passkey. After the initial pairing, the two devices can connect automatically each time you turn them on.



NOTE: You might have to set your device to connect automatically when the zūmo is turned on.

Why should I pair my phone and headset with my zūmo?

To get the full features of the zūmo, you should pair your phone to the zūmo and also pair your headset to the zūmo. In addition to hands-free phone use, you can also hear zūmo navigation prompts through your headset.

For additional zūmo audio options, see [page 49](#).

Pairing Your Device

To pair and connect, your device and the zūmo must be turned on and be within 10 meters of each other.

Initiate pairing from your zūmo or from your mobile phone. Refer to your phone’s instructions.

To pair using the zūmo settings:

1. On the zūmo's Menu page, touch

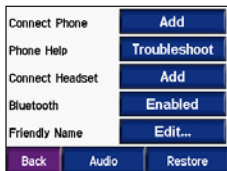

2. Touch the **Add** button next to the "Connect Phone" or "Connect Headset" option.
3. Enable your device's Bluetooth component and enable Find Me/ Discoverable/Visible mode. These settings might be in a Bluetooth, Connections, or Hands-free menu.
4. Touch **OK** on the zūmo.
5. Select your device, and touch **OK**.
6. Enter the zūmo's Bluetooth PIN (**1234**) in your phone, if necessary.
7. On the zūmo, touch and hold **Back** to return to the Menu page.



To pair using the phone settings:

1. Enable the phone's Bluetooth component. This might be in a menu called Settings, Bluetooth, Connections, or Hands-free.
2. Initiate a search for Bluetooth devices. This might be located in a menu called Bluetooth, Connections, or Hands-free.
3. Select the zūmo from the list of devices.
4. Enter the zūmo's Bluetooth PIN (**1234**) into your phone.
5. On the zūmo, touch and hold **Back** to return to the Menu page.



NOTE: Each time you turn on the zūmo, it tries to connect to the last device with which it was connected.

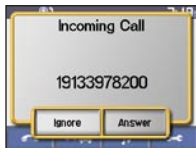

Getting a Call

When your phone is connected with the zūmo, the  icon appears in the upper-left corner. When your headset is connected with the zūmo, the  icon appears in the upper-left corner. When you get a call, the Incoming Call window opens.



Touch **Answer** to answer the call. Touch **Ignore** to ignore the call and stop the phone from ringing.

In a Call

After you have made or answered a call, the  **In Call** icon appears on the screen. Touch  for more options:

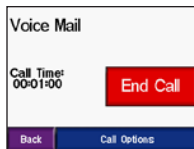

Touch **End Call** to hang up.

Touch **Call Options** view the following in call settings:

Touch Tones—displays a keypad page so you can use automated systems, such as voice mail.

Transfer Audio To Phone—to switch audio to your phone. This is helpful if you plan to turn off the zūmo, but want to stay on the call. You can also transfer a call to your phone if you need privacy or your headset is malfunctioning. To switch back, touch **Transfer Audio To Device**.

Mute Microphone—to mute the microphone during a call. It mutes a wired microphone, wireless headset microphone, or the internal microphone on the automotive mount.

Using Call Waiting



NOTE: If your phone does not support call waiting through Bluetooth, this feature will not work.

If you get a call during a call, the Incoming Call window appears. Touch **Answer** to answer the call. The first call is placed on hold.

To switch between calls:

1. Touch  to open the In Call menu.

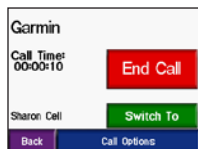

2. Touch **Switch To**.
3. Touch **End Call** to hang up; this does not disconnect the call on hold.

Phone Menu

On the Menu page, touch  to open the Phone menu. Not all phones support all features of the zūmo Phone menu. Refer to your phone's instructions.

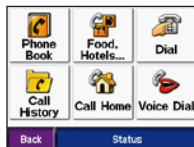

Press **Status** to view the connected phone's signal strength, battery level, carrier, and name.



Using Your Phone Book



NOTE: The phone book feature is only available if your phone supports phone book transfer.

Each time your mobile phone connects with the zūmo, the phone book is automatically loaded into the zūmo. It may take a few minutes for the phone book to be available.

1. Touch > **Phone Book**.

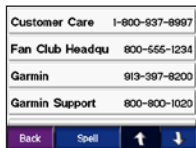

2. Touch the phone book entry you want to call.
3. Touch **Dial**.

Dialing a Point of Interest

1. Touch > **Food, Hotels**.
2. Search for the point of interest you want to call.

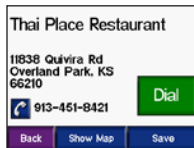

3. Touch **Dial** or .

Dialing a Number

1. Touch > **Dial**.





2. Enter the number, and touch **Dial**.

Viewing Your Call History



NOTE: Call history is only available if your phone supports call history transfer.

Each time your phone connects to the zūmo, your call history is automatically transferred to the zūmo. It may take a few minutes to transfer this data to the zūmo.

1. Touch  >  **Call History**.
2. Touch **Missed**, **Dialed**, or **Received** to view those calls. The calls are listed in chronological order; the most recent calls are at the top of the list.
3. Touch an entry, and touch **Dial**.

Calling Home

Enter a phone number for your home location, so you can quickly call home.



Enter a Home Phone Number

1. Touch  >  **Call Home**.



2. Touch **Enter Phone Number** to use the keypad page or **Select From Phonebook** (only available if your phone supports phone book transfer).
3. Touch **Done** > **Yes**. The zūmo dials your home phone number.



NOTE: To edit home location or phone number, touch  **Where to** >  **Favorites** > **Home** > **Edit**.

Call Your Home

Touch  >  **Call Home.** The zūmo dials your home phone number.

Placing Calls Using Voice Dial



NOTE: Voice dial is only available if your phone supports voice dialing.

You can place calls by speaking the contact's name into the microphone.

1. Touch  >  **Voice Dial.**
2. Speak the contact name.



NOTE: You may need to “train” your mobile phone to recognize your voice commands. Refer to your phone's instructions.

TRAFFIC INFORMATION

Your zūmo can receive and use traffic information using an optional FM TMC (Traffic Message Channel) traffic receiver (such as the GTM™ 20) or an XM smart antenna (such as the GXM™ 30). When a traffic message is received, your zūmo displays the incident on the map and can change your route to avoid the traffic incident.



NOTE: Garmin is not responsible for the accuracy of the traffic information. The traffic receiver or antenna simply receives signals from the traffic service provider and displays that information on your zūmo.







NOTE: You can only access the traffic information if the zūmo is connected to a traffic receiver or antenna (see [page 54](#)).

Traffic in Your Area

On the Menu page, touch  or  > **Traffic**.

Traffic on Your Route

The map displays  or  when there is a traffic delay on your route. The number in the icon represents the delay time in minutes. The delay time is automatically calculated into the arrival time shown on the map.

1. Touch  or  to view a map and more information.

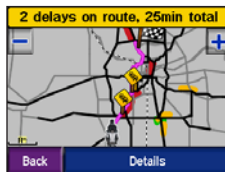

2. Touch the yellow text bar for more information. If there is more than one delay, touch **Details**.



3. Touch **Avoid** to recalculate your route to avoid this delay.

Traffic Codes and Symbols

Green = Low severity; traffic is flowing normally.

Yellow = Medium severity; traffic is a bit congested.

Red = High severity; traffic is heavily congested or stopped.

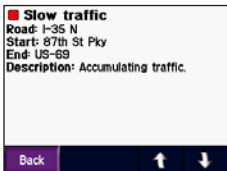



North American	Meaning	International
	Road condition	
	Road construction	
	Road closed	
	Slow traffic	
	Accident	
	Incident	
	Information	

Purchasing Traffic Subscriptions

You can renew and purchase new subscriptions at www.garmin.com/traffic.

Adding a Subscription

1. Touch  >  >  **Services** or **Traffic**.
2. Touch **FM Traffic** or **XM Subscriptions**.
3. Touch **Add** or **Subscribe**.
4. Follow the on-screen instructions.



NOTE: Additional documentation is included with your Garmin traffic receiver or antenna.

FM Traffic

For more information about an FM traffic receiver, go to www.garmin.com/traffic. For participating FM traffic subscription providers and coverage cities, go to www.garmin.com/fmtraffic.



NOTE: The FM traffic receiver and zūmo must be in data range of an FM station transmitting TMC data to receive traffic information.

XM Traffic

For more information about an XM smart antenna, go to www.garmin.com/xm. For subscription information and coverage cities for XM NavTraffic, go to www.xmnavtraffic.com.



NOTE: XM subscriptions are available for North America only.

USING XM

Your zūmo can receive XM radio and XM weather using an optional XM smart antenna (such as the GXM™ 30). For more information about an XM smart antenna and XM subscriptions, go to www.garmin.com/xm.



NOTE: You must purchase and activate your XM service before you can use the XM features.

On the Menu page, touch .





- **XM Radio**—opens the XM tuner.
- **Local Weather**—displays current weather conditions based on your present location. Touch **Forecast** to view a five-day weather forecast for this area.

- **Weather Map**—displays current weather conditions on the map. See [page 18](#) for tips on browsing the map.
- **Traffic**—displays a list of current traffic events. Touch an item for more details.

Listening to XM Radio

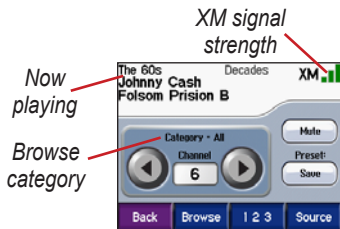
1. Connect the antenna to the zūmo mount (see [pages 3 and 54](#)). External power is required.
2. On the Menu page, touch  to open the Media Player.
3. Touch **Source** to view the XM tuner. See [page 38](#), to learn about the MP3 player.



Touch  to go to the next channel in the browse category.

Touch  to go to the previous channel in the browse category.

Touch **Browse** to search a category, such as Recent Channels, Kids, or Urban. Next to each channel is the current program information. Touch a channel to listen to that channel.



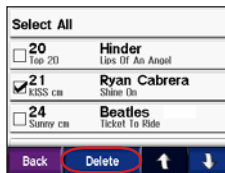

Touch **123** to enter an XM channel. Then touch **Done** to listen to that channel.

Touch **Save** to save a channel to Presets (maximum of 20).

Touch  to remove the current channel from your Presets. To delete more than one channel from Presets, touch **Browse** > **Presets** > **Delete**. A list of all your Presets appears. Touch the items you want to delete. Touch **Delete** > **Yes**.



Removing Channels From Presets

Adjusting the Volume
 Press , and then use  and  to adjust the volume. For advanced volume settings, touch  >  **Volume**. For zūmo audio options, see [page 49](#).

MANAGING FILES ON YOUR zŪMO

You can load files to the internal memory or an optional SD card.



NOTE: The zŪmo is not compatible with Windows® 95, Windows 98, or Windows Me operating systems. This is a common limitation of most USB Mass Storage Devices.

Supported File Types

- MP3 music files
- M3U playlist files
- JPEG and JPG image files for splash screen or picture viewer
- GPI custom POI files from Garmin's POI Loader
- GPX waypoint files and maps from MapSource



NOTE: The zŪmo does not support iTunes® M4A/M4P files.

Step 1: Insert an SD Card (Optional)

To insert or remove the card, press it in until it clicks.

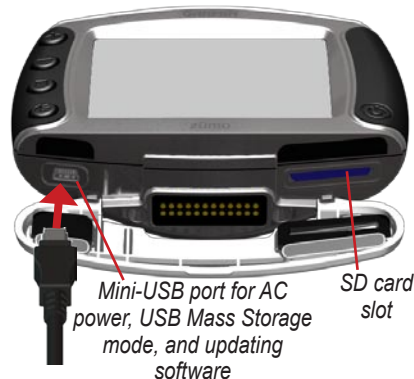

Step 2: Connect the USB Cable

1. Plug the small end of the USB cable into the mini-USB port.
2. Connect the larger end of the USB cable to an available USB port on your computer.

Two additional drives appear in your computer's list of drives. "Garmin" is the available storage in the zŪmo's internal memory. The other removable disk drive is the SD card.



NOTE: If the drive is not named automatically, see your Help file or [page 63](#) to rename the drive.

Step 3: Transfer Files to Your zŪmo

For Windows

1. Connect the zŪmo to your computer.
2. Double-click  **My Computer**.
3. Browse your computer for the file you want to copy.
4. Highlight the file, and select **Edit > Copy**.
5. Open the Garmin drive or the SD card drive.

6. Select **Edit > Paste**. The file appears in the list of files on the Garmin or SD card drive.



NOTE: You can also drag and drop files to and from your drives.

For Mac®

1. Connect the zŪmo to your computer. Your Garmin and SD card drives should mount onto your Mac desktop as two mounted volumes.
2. To copy files to your Garmin or SD card drive, drag and drop any file or folder onto the volume icon.





Step 4: Eject and Unplug

For Windows

When you are finished transferring files, double-click the  **Unplug or Eject** icon in your Windows system tray.

Select **USB Mass Storage Device**, and click **Stop**. Select the drive, and click **OK**. You can unplug the USB cable from your zūmo now.

For Mac

When you are finished transferring files, drag the volume icon to the **Trash**  (it turns into an **Eject**  icon) to unmount the device. You can unplug the USB cable from your zūmo now.

Deleting zūmo Files

You can delete files from your zūmo just as you would delete files from your computer.

Connect the zūmo to your computer, and open your Garmin or SD card drive. Select the file that you want to delete, and press the **Delete** key on your computer's keyboard.



CAUTION: If you are not sure about a file's purpose, do **not** delete it. Your zūmo memory contains important system files that should **not** be deleted. Be cautious of files located in folders entitled "Garmin."

USING THE MEDIA PLAYER

Listening to MP3 Files

Load MP3 files to the internal memory or an optional SD card. See [pages 35–37](#) for more information.

1. On the Menu page, touch  to open the Media Player.
2. Touch **Source** to view the MP3 player.
3. Touch **Browse**.
4. Touch a category.
5. To play the entire category from the beginning of the list, touch **Play All**. To play all starting with a specific song, touch the title.



Album art

Touch the album art to view details about the MP3 file.

Touch  to adjust the volume. For zūmo audio options, see [page 49](#).

Tap  to go to the beginning of the song; touch and hold to skip back.

Tap  to skip to the next song; touch and hold to skip ahead.

Touch  to pause the song.

Touch  to repeat.

Touch  to shuffle.



NOTE: The zūmo plays MP3 files only; it does not support iTunes® M4A/M4P files.

Using a Playlist

This feature involves managing files on your zūmo (see [pages 35–37](#)).

1. Using your computer and an audio program such as Winamp™, create a playlist of MP3 files.
2. Save the playlist as an M3U file.



NOTE: You may need to edit the M3U file with a text editor, such as Notepad, to remove the path (location) to the MP3. The M3U file should only list the MP3 files in your playlist, not their location. Refer to the audio program's Help file for instructions.

3. Transfer the playlist and the associated MP3 files to the Garmin or SD card drive. The M3U file must be in the same location as the MP3 files.
4. On the zūmo, touch  > **Source** to open the MP3 player.

5. Touch **Browse** > **Import Playlist**.
The available playlists appear.

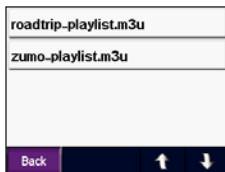

6. Touch a playlist to start playing the MP3 files.



NOTE: You cannot change the order of the playlist from your zūmo.

Listening to Audible Books

To purchase books from Audible.com, go to <http://garmin.audible.com>. See [page 40](#) to load books to your zūmo.

1. On the Menu page, touch  > **Source** to open the audible book player.
2. Touch **Browse**, and touch a category.
3. To play a book, touch the title.

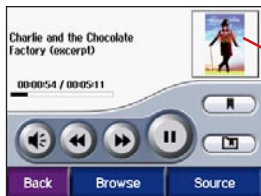



Book cover art

Moving Around the Book



Touch  to adjust the volume.

Touch the book cover art to view more detailed information about the book.

Touch  to skip a section and  to jump back. Press and hold those buttons to move forward or backward through the book.

Touch  to pause the book.

Using Bookmarks

To create a bookmark, touch  and **Bookmark**. To view your bookmarks, touch  and then touch a bookmark. Touch **Play** to listen to the book from the bookmark.

Loading Audible Books to Your zūmo

1. Create an Audible.com account at <http://garmin.audible.com>.
2. Purchase a book.
3. Download AudibleManager to your computer.
4. Activate your zūmo. The first time you open AudibleManager, you are led through the activation process. This is a one-time process.
5. Connect the zūmo to your computer.
6. Download the book to your computer.
7. Open AudibleManager and use it to transfer the book to your Garmin or SD card drive.



TIP: Refer to AudibleManager's Help file for detailed instructions. Select **Help** from the menu, and click **Help**.

CUSTOMIZING THE ZŪMO

1. From the Menu page, touch .
2. Touch the setting you want to change. Each setting contains a submenu or a list.



Changing the Map Settings

Touch  >  **Map**.

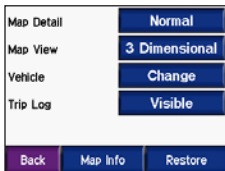

Map Detail—adjust the amount of detail shown on the map. Showing more detail may cause the map to redraw slower.

Map View—change the perspective of the map.

- **Track Up**—display the map in 2 dimensions (2D) with your direction of travel at the top.
- **North Up**—display the map in 2D with North at the top.
- **3D**—display the map in 3 dimensions (3D) in Track Up.

Vehicle—touch **Change** to change the icon used to show your position on the map. Touch the icon you want to use, and then touch **OK**. Download additional vehicle icons at www.garmin.com/vehicles.

Trip Log—touch **Show** to display your current trip log on the map as a thin blue line. To manage your trip log data, touch  > **User Data** > **Manage Trip Log**.

Map Info—view the maps loaded on your zūmo and their version. Touch a map to enable (check mark) or disable (no check mark) that map.

Restore—restore the default map settings.

Changing the System Settings

Touch  >  **System.**

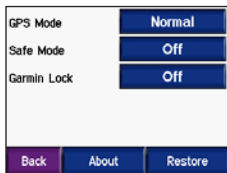

GPS Mode—enable and disable GPS and WAAS/EGNOS. Turning on the WAAS/EGNOS setting might improve GPS accuracy, but it consumes more battery power. Go to www.garmin.com/aboutGPS/waas.html for information about WAAS/EGNOS.

Safe Mode—turn Safe Mode on or off. When your vehicle is moving, Safe Mode disables all functions that require significant operator attention and could become a distraction while driving.

Garmin Lock—turn on Garmin Lock to lock your zümo. Enter a 4-digit PIN, and set a security location. For more information, see [page 10](#).

About—display your zümo’s software version number, unit ID number, and audio version number. You need this information when you update the system software (see [page 49](#)) or purchase additional map data (see [page 53](#)).

Restore—restore the default system settings.

Localizing Your zümo

Touch  >  **Locale.**





To change a setting, touch the button next to the icon.

To change all settings, touch **Change All**. In each screen, select the setting, and then touch **OK**.

Locale—select your location.

 **Text Language**—set all on-screen text to the selected language. Changing the text language does not change the language of user-entered data or map data, such as street names.

 **Voice Language**—set the language for voice prompts. Languages noted with a person's name are text-to-speech (TTS) voices, which have an extensive vocabulary and pronounce the street names as you approach turns. The prerecorded voices (those without a person's name) have a limited vocabulary and do not speak names of locations or streets.

 **Time Format**—choose a 12-hour, 24-hour, or UTC time format.

Time Zone—select a time zone or nearby city from the list.

Daylight Saving—set to **On**, **Off**, or **Auto**, if it is available.

 **Units**—set units of measure to **Kilometers** or **Miles**.

Managing User Data

Touch  >  **User Data**.

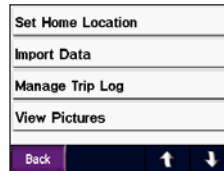

Set Home Location—enter or change your home location. See [page 12](#).

Import Data—load Favorites, routes, trip logs, and pictures from your Garmin drive or SD card.

Manage Trip Log—view the current trip log usage. This is shown as a percent of the total available space. You can manage the most current 10,000 points of trip data on your zūmo. Beyond 10,000 points, the zūmo moves the oldest trip data from the current log to an archive file on the zūmo’s internal memory. Archive files can store up to 1 MB each, and a maximum of 20 archive files can be stored on the internal memory, depending on the space available. Using this method, the zūmo can store as many as 200,000 points of trip data for very long rides.





NOTE: Archived trip logs are intended to be used on your computer with MapSource, Google Earth, or myGarmin Web site. Archived trip logs are not visible on the zūmo.

To view available space in your Garmin drive, connect the zūmo to your computer, and select the Garmin drive. See [page 35](#).

- **Clear Trip Log**—reset the trip log before your next big trip. Clearing a large trip log may take a few minutes.
- **Save As Route**—select and save a recent trip log as a route. This allows you to reuse recent trip data. For more information about routes, see [page 16](#).

To view your trip log on the map, touch  > **Map** > **Trip Log** > **Show**.

View Pictures—view pictures saved to your Garmin drive or SD card. Touch a thumbnail to view the image. Touch the image again to zoom using  and . Touch the picture and drag to view different parts of the picture.

To share pictures with another zūmo user:

1. Touch a thumbnail.
2. Touch **Share**.



- Eject your SD card, and insert it into another zūmo.
- A message appears. Touch **Yes** to import the shared picture.
- Touch **Pictures** > touch a thumbnail > **Import**.

Touch **Slide Show** to display each image for a few seconds and then display the next image. During the slide show, touch the screen at any time to stop and see more options.

Bluetooth Technology Settings

Touch  >  **Bluetooth**.

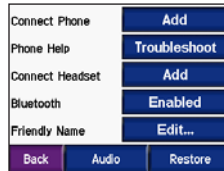

Connect Phone—select **Add Device** > **OK** to pair with a mobile phone that has Bluetooth® wireless technology. See [pages 23–29](#).



NOTE: The zūmo's PIN code (or passkey) is **1234**.

- Drop**—select the phone you want to disconnect, and touch **Yes**.
- Remove**—select the phone you want to delete from the zūmo's memory, and touch **Yes**.

Phone Help—scroll through the list containing compatible devices. If your phone is not in this list, go to

www.garmin.com/bluetooth for more information.

Connect Headset—connect to a headset that has already been paired, or select **Add Device**.

Bluetooth—enable and disable the Bluetooth component. The  **Bluetooth** icon appears on the Menu page if the Bluetooth component is enabled. To prevent a phone from automatically connecting, select **Disabled**.

Friendly Name—touch **Edit** to enter a friendly name that identifies your zümo on devices with Bluetooth technology. Touch **Done**.

Audio—specify which types of audio are sent to the Bluetooth headset.

Restore—restore the default Bluetooth settings. Restoring the Bluetooth settings does not clear the pairing information.

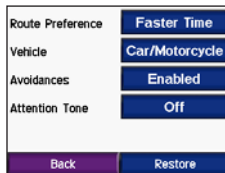

Changing the Navigation Settings

Touch  >  **Navigation**.



Route Preference—select a preference for calculating your route:

- **Faster Time**—to calculate routes that are faster to drive but can be longer in distance.
- **Shorter Distance**—to calculate routes that are shorter in distance but can take more time to drive.

- **Off Road**—to calculate point-to-point routes (without roads). On the map, touch  or press  to scroll to the Compass page.



Vehicle Type—specify your vehicle type to optimize routes.

Avoidances—select the road types you want to avoid on your routes. The zūmo uses these road types only if alternative routes take you too far out of your way or if no other roads are available. If you have a traffic receiver or antenna, you can also avoid traffic incidents.

Attention Tone—turn on or off the attention tone.

Restore—restore the default navigation settings.

Customizing the Display

Touch  >  **Display**.

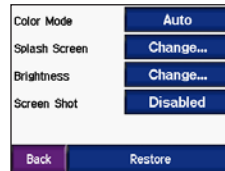

Color Mode—select **Daytime** for a light background, **Nighttime** for a dark background, or **Auto** to automatically switch between the two.

Splash Screen—select an image to be shown when you turn on the zūmo. First, load JPEG images. See [pages 35–37](#).

Brightness—raise and lower the backlight brightness using **–** and **+**.

Screen Shot—enable Screen Shot mode. Touch the  camera icon to take a picture of the screen. The picture bitmap file is saved in the **Garmin\scrn** folder on the Garmin drive.

Changing the Keyboard

Touch  >  **Keyboard**.



Standard—displays a full alphabetic keyboard.



Large Buttons—displays a large button touch-screen keyboard. This option is suited for motorcyclists wearing gloves. See [page 13](#).

Auto—select to automatically switch between the standard keyboard when using the zūmo in the automotive mount and the large button keyboard when using the zūmo in the motorcycle mount.

Managing Traffic Settings

Touch  >  >  **Services** or **Traffic** to view optional FM and XM subscription information and settings.

Traffic Source—select **Auto**, **FM**, or **XM** based on which optional traffic accessory is connected.

Restoring All Settings

Touch  > **Restore** > **Yes**. This restores all of the factory default settings.

Clearing All User Data



CAUTION: This deletes all user-entered information including Favorites, routes, trip logs, settings, and recent finds.

1. Hold your finger on the lower-right corner of the zūmo's screen while turning on the zūmo.
2. Keep your finger pressed until a message appears.
3. Touch **Yes**.

APPENDIX

zūmo Audio Options



NOTE: Audio from MP3s and XM radio is stopped during phone calls and navigation prompts. Navigation prompts are muted during phone calls.

Power Source	Audio Option	Navigation Prompts	MP3	XM Radio	Phone	Notes
Motorcycle mount with external power	Wired headset or helmet with microphone	●	●	●	●	
	Bluetooth headset	●	●	○	●	
Automotive mount with external power (included with zūmo 550)	Internal speaker and microphone	●	●	●	●	
	Wired headset or headphones with wired microphone	●	●	●	●	
	Bluetooth headset and internal speaker	○	○	○	●	Adjust volume on headset.
Battery power	Bluetooth headset	●	●	○	●	Adjust volume on zūmo. Fully charged battery lasts up to 4 hours.

● Audio available, ○ No audio available, - Not applicable

Installing the zūmo in Your Automobile

Your zūmo 550 includes an additional mount for your automobile so you can easily transfer the unit. Select a suitable location in your vehicle for safe cable routing and safe operation. Clean and dry the selected area of your windshield.

Mounting on Your Windshield

1. Place the suction cup on the windshield. Flip the suction lever back, toward the windshield.
2. Plug the power cable into the side of the mount.
3. Place the zūmo into the automotive mount, and flip the lever down.
4. Plug the power cable into a power receptacle in your vehicle. Your zūmo should turn on automatically if the vehicle is running.



Mounting on Your Dashboard

Use the enclosed mounting disk to mount your zūmo on the dashboard and to comply with state regulations.



NOTE: The **permanent** mounting adhesive is extremely difficult to remove after it is installed.

1. Clean and dry the dashboard where you want to place the disk.
2. Remove the backing from the permanent mounting adhesive on the bottom of the disk.
3. Place the disk on the dashboard.
4. Remove the clear plastic cover from the top of the disk.
5. Place the suction cup part of the automotive mount on top of the disk.
6. Flip the suction lever down (toward the disk).
7. Follow steps 2–4 on [page 50](#).

Removing the zūmo from the Mount

To remove the zūmo from the mount, flip up the lever on the mount. Lift out the zūmo.

You can separate the suction cup from the automotive mount. Turn the mount as far as you can to the right or left. Apply pressure in that direction until the mount snaps off the arm.



NOTE: Reconnecting the suction cup to the automotive mount requires significant force. Press the ball end firmly into the socket.

To remove the suction cup from the windshield or mounting disk, flip the suction lever up. Pull the tab on the suction cup toward you.

Charging the zūmo

1. Connect the power cable to a mount and a power source.
2. Place the zūmo in the mount, and flip the lever down.

OR

1. Charge the zūmo with the AC power cable. Plug the small end of the AC power cable into the mini-USB port on the bottom of the zūmo.
2. Plug the other end into a standard wall outlet.

Resetting the zūmo

If your unit freezes up, press and hold

 and press .

Calibrating the Screen

If the touch screen is not responding properly, calibrate the touch screen. Turn the unit off. Press and hold  for about one minute until the calibration screen appears. Follow the on-screen instructions.

Updating the zūmo Software

1. Go to www.garmin.com/products/webupdater to download the WebUpdater program to your computer.
2. Connect the zūmo to your computer using the mini-USB cable.

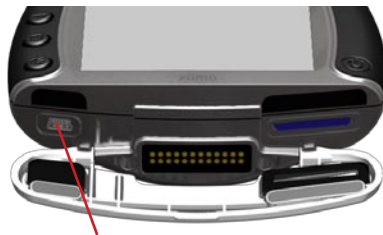



Mini-USB port for AC power, USB Mass Storage mode, and updating software

3. Run WebUpdater, and follow the screen prompts. After confirming that you want to perform an update, WebUpdater automatically downloads the update and installs it on your zūmo.
4. Eject and unplug your zūmo (see [page 37](#)).

Register your zūmo to receive notification of software and map updates. To register your zūmo, go to <http://my.garmin.com>.

You can also download software updates from www.garmin.com/products/zumo500 or www.garmin.com/products/zumo550. Click **Updates and Downloads**, and follow the instructions.

Purchasing and Loading Additional Map Data

To find out the version of the maps that are loaded on your zūmo, touch  >  **Map** > **Map Info**. To unlock additional maps, you need your unit ID and serial number.

Check www.garmin.com/unlock/update.jsp to see if an update for your map software is available.

You can also purchase additional map data from Garmin and load the maps to the internal memory or an optional SD card.

Refer to the MapSource Help file for more information about using MapSource and loading maps and waypoints on your zūmo.

Optional Accessories

For more information about optional accessories, go to www.garmin.com/products/zumo500 or www.garmin.com/products/zumo550, and click **Accessories**. You can also contact your Garmin dealer to purchase accessories. Optional accessories include:

- Traffic receiver or antenna
- External remote antenna
- External microphone
- Extras (see [pages 54–56](#))

Connecting Accessories to Your zūmo

Some Garmin traffic receivers and XM antennas must be plugged into a mini-USB port on the zūmo mount. The microphone and audio out jacks are located on the left side of the zūmo mount.

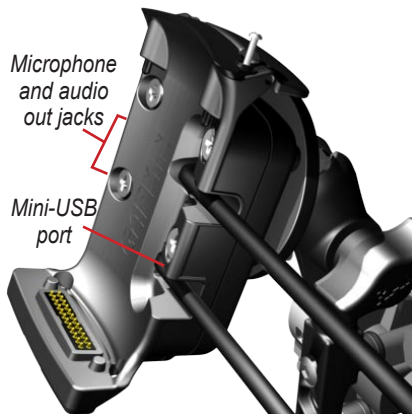

zūmo Motorcycle Mount Shown





TIP: Carefully connect and disconnect cables. To disconnect, do not pull on the cable (cord), pull on the plug.

To see the automotive mount connections, see [page 50](#).

Garmin Travel Guide™

Much like a paper travel guide, the Garmin Travel Guide provides detailed information about locations, such as restaurants and hotels. To purchase the Travel Guide accessory, go to www.garmin.com/extras.

To use the Travel Guide:

1. Insert the SD card into your zūmo.
2. Touch  **Where to** >  **Extras**.
3. Touch the Travel Guide.
4. Touch a category. Touch a sub-category, if necessary.
5. Touch a location in the list.
6. Do one of the following:
Touch **Go** to go to the location.

Touch **Map** to view this item on the map.

Touch **Save** to save this location to your  Favorites.

Touch **More** to view more information about the location.

Safety Cameras

Safety camera information is available in some locations. (Check www.garmin.com/accessories/safetycamera for availability.) For these locations, your zūmo includes the locations of hundreds of safety cameras. Your zūmo alerts you when you are approaching a safety camera and can warn you if you are driving too fast. The data is updated at least weekly, so you always have access to the most up-to-date information.

To get updated safety camera information:

1. Go to <http://my.garmin.com>.
2. Sign up for a subscription.

You can purchase a new region at any time, and you can extend existing subscriptions at any time. Each region that you purchase has its own expiration date.

Custom POIs (Points of Interest)

Load custom points of interest (POIs) onto your zūmo. POI databases are available from various companies on the Internet. Some custom databases contain alert information for points, such as school zones. A warning appears if you are traveling too fast near these custom POIs.

Use the Garmin POI Loader to load POIs on your Garmin drive or SD card. Download the POI Loader from www.garmin.com/extras.

Refer to the POI Loader Help file for more information; press F1 to open the Help file.

To view your custom POIs, touch

 **Where to** >  **Extras** > **Custom POIs**.

To turn on or off custom POIs, touch

 >  **Proximity Points** > **Proximity Alerts**.

To delete the custom POIs from your zūmo, connect your zūmo to your computer. Open the **Garminpoi** folder in the Garmin or SD card drive. Delete the file entitled **poi.gpi**.







CAUTION: Garmin is not responsible for the consequences of using a custom POI database or the accuracy of the safety camera or other custom POI database.

Garmin TourGuide™

The Garmin TourGuide allows your zūmo to play third-party, GPS-guided audio tours. These audio tours can take you on a route while playing interesting facts about historical sites along the way. As you travel, the audio information

is triggered by GPS signals. For more information, go to www.garmin.com/extras and click **POI Loader**.

To view your Garmin TourGuide files, touch  **Where to** >  **Extras** > **Custom POIs**.

To change the Garmin TourGuide settings, touch  >  **Proximity Points** > **TourGuide**. Select **Auto Play** to hear the complete tour as programmed, **Prompted** to show the speaker icon  on the map when tour information is available during your route, or **Off**.

SaversGuide®

The SaversGuide is an optional accessory that is available only in North America (www.garmin.com/extras). With the SaversGuide preprogrammed SD data card and membership card, your zūmo is a digital coupon book that notifies you of merchants near your current location where you are eligible for a discount, such as restaurants, hotels, and movie theaters.

Battery Information







NOTE: See the Important Safety and Product Information guide for additional battery information and warnings.

Your zūmo contains an internal lithium-ion battery. The battery lasts up to 4 hours, depending on usage.

The  battery icon on the Menu page indicates the status of the internal battery. If the icon is not present, your zūmo is connected to external power. For information about charging your zūmo, see [page 52](#).

Maximizing the Battery Life

- Turn off GPS ( >  **System** > **GPS Mode** > **GPS Off**) when you do not need to receive GPS signals, or use **Normal** mode when WAAS or EGNOS is not available.
- Turn the backlight brightness down. Press and hold , and then use  and  to adjust the brightness.

- Do not leave your zūmo in direct sunlight. Avoid prolonged exposure to excessive heat or cold.

Replacing the Battery

To purchase a replacement lithium-ion battery pack, go to www.garmin.com/products/zumo500 or www.garmin.com/products/zumo550, and click **Accessories**.

Unscrew the battery pack and replace the battery. Contact your local waste disposal department for information on properly disposing of the battery.



Using a Remote Antenna

You can use an optional external remote antenna (Garmin GA 25MCX). To purchase, go to www.garmin.com/products/zumo500 or www.garmin.com/products/zumo550, and click **Accessories**.

Pull back the weather cap from the MCX connector located on the back of the zūmo, and connect the antenna.

Caring for Your zūmo

Your zūmo contains sensitive electronic components that can be permanently damaged if exposed to excessive shock or vibration outside normal motorcycle or automobile use. To minimize the risk of damage to your zūmo, avoid dropping your unit and operating it in extreme high-shock and high-vibration environments.

Cleaning the Unit

The zūmo is constructed of high-quality materials and does not require user maintenance other than cleaning. Clean the unit's outer casing (not the touch screen) using a cloth dampened with a mild detergent solution, and then wipe dry. Avoid chemical cleaners and solvents that can damage plastic components.

Cleaning the Touch Screen

Clean the touch screen with a soft, clean, lint-free cloth. Use water, isopropyl alcohol, or eyeglass cleaner, if needed. Apply the liquid to the cloth, and then gently wipe the touch screen.

Protecting Your zūmo

- Carry and store your zūmo in the included carrying case.
- Do not store your zūmo where prolonged exposure to extreme temperatures can occur (such as in the trunk of a car), because it can cause permanent damage.

- Though a PDA stylus can also be used to operate the touch screen, never attempt this while operating a vehicle. Never use a hard or sharp object to operate the touch screen or damage may result.

Avoiding Theft

- To avoid theft, remove the zūmo and mount from sight when not in use.
- Use the Garmin Lock™ feature. See [page 10](#).

Changing the Fuse

If your unit will not charge in your vehicle, you may need to replace the fuse located at the tip of the vehicle adapter.



CAUTION: When replacing the fuse, do not lose any of the small pieces, and make sure they are put back in the proper place.

1. Unscrew the black (or silver), round end piece and remove it.



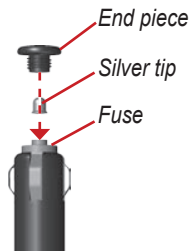

2. Remove the fuse (glass and silver cylinder) and replace with a 3A fast blow fuse.
3. Ensure that the silver tip is placed in the black end piece. Screw on the black end piece.



About GPS Satellite Signals

Your zūmo must acquire GPS (Global Positioning System) satellite signals to operate. If you are indoors, near tall buildings or trees, or in a parking garage, your zūmo cannot acquire satellites. Go outside to an area free from tall obstructions to use your zūmo.

When your zūmo has acquired satellite signals, the signal strength bars on the Menu page are green . When it loses satellite signals, the bars turn red or clear .

For more information about GPS, go to www.garmin.com/aboutGPS.

Specifications

Physical size: 4.4" W x 3.2" H x 2.87" D (11.3 x 8.2 x 7.2 cm)

Weight: 0.59 pounds (269 g)

Display: 2.8" W x 2.1" H (7.2 x 5.4 cm); 320 x 240 pixels; bright, 16-bit LCD, with white backlight and touch screen

Case: IPX7 waterproof

Temperature range: 32°F to 140°F (0°C to 60°C)

Data storage: Internal memory and optional removable SD card. Data stored indefinitely.

Computer interface: USB mass storage, plug-and-play

Charge time: Approximately 6 hours

Power input: DC vehicle power cable or AC power cable.

Usage: 15 W max. @ 13.8 VDC

Battery life: up to 4 hours depending on usage

GPS Performance Specifications

Receiver: WAAS enabled

Acquisition times*:

Warm: < 1 sec

Cold: < 38 sec

Factory Reset: < 45 sec

*On average for a stationary receiver with a clear view of the sky

Update rate: 1/sec, continuous

GPS accuracy:

Position: < 10 meters, typical

Velocity: 0.05 meter/sec RMS





GPS (WAAS) accuracy:

Position: < 5 meters, typical

Velocity: 0.05 meter/sec RMS

For a complete list of specifications, go to www.garmin.com/products/zumo500 or www.garmin.com/products/zumo550, and click **Specifications**.

zūmo Troubleshooting

Problem/Question	Solution/Answer
The zūmo does not acquire satellite signals.	It can take a few minutes to acquire satellite signals. Go to an open area, out of garages, and away from tall buildings. Stop your vehicle, and position the zūmo where there is a clear view of the sky. The bars in the upper-left corner  indicate satellite strength.
How do I clear all my user data?	Hold your finger on the lower-right corner of the zūmo's screen while turning on the zūmo. Keep your finger pressed until the message appears. Touch Yes to clear all user data.
The zūmo is locked up/frozen.	To reset your zūmo, press and hold  and press  .
The suction cup will not stay on my windshield.	Clean the suction cup and windshield. Dry with a clean, dry cloth. Mount the suction cup as described on page 50 .
My battery gauge does not seem accurate.	Allow the unit to fully discharge, and then fully charge it (without interrupting the charge cycle).
The touch screen is not responding to my taps properly.	Calibrate the touch screen. Turn the unit off. Press and hold  for about one minute until the Calibration page appears. Follow the on-screen instructions.
My Bluetooth device will not connect to the zūmo.	Verify that the Bluetooth field is set to Enabled . Make sure your Bluetooth device is turned on and is less than 10 meters (about 33 feet) away from your zūmo. Go to www.garmin.com/bluetooth for a list of compatible phones and headsets.

USB Interface Troubleshooting

Problem/Question	Solution/Answer
<p>How do I know my zūmo is in USB Mass Storage Mode?</p>	<p>When your zūmo is in USB Mass Storage Mode, a picture of a zūmo connected to a computer is shown. Also, you should see a new removable disk drive listed in My Computer (Windows) or a new volume (drive) on your desktop (Mac).</p>
<p>My computer never senses that the zūmo is connected.</p>	<ol style="list-style-type: none"> 1. Unplug the USB cable from your computer. 2. Turn the zūmo off. 3. Plug the USB cable into your computer and your zūmo. The zūmo automatically turns on and goes into USB Mass Storage Mode.
<p>I cannot find any drives named "Garmin" in my list of drives.</p>	<p>If you have several network drives mapped on your computer, Windows may have trouble assigning drive letters to your Garmin or SD drives. Follow the steps on the next page to assign (map) your drive letters.</p>
<p>I get a message saying "Unsafe Removal of Device" when I unplug the USB cable.</p>	<p>Windows: Double-click the Unplug or Eject  icon in your system tray. Select USB Mass Storage Device and click Stop. Select the Garmin drive and click OK. You can unplug your zūmo now.</p> <p>Mac: Drag the volume icon to the Trash. The Trash icon changes to an Eject icon. You can unplug your zūmo now.</p>

Problem/Question	Solution/Answer
How can I rename my Garmin drives in Windows?	<ol style="list-style-type: none">1. Open My Computer.2. Select the drive you want to rename.3. Right-click your mouse, and select Rename.4. Type the new name, and press the Enter key on your computer's keyboard.
How do I assign (map) my Garmin drives in Windows?	<ol style="list-style-type: none">1. Turn off your zūmo.2. Plug the USB cable into the zūmo and your computer. Your zūmo automatically turns on.3. Click Start > Settings > Control Panel > Administrative Tools > Computer Management > Storage > Disk Management.4. Click a zūmo removable disk drive (either the internal memory or your SD card drive). Right-click your mouse, and select Change Drive Letter and Path.5. Select Edit, select a drive letter from the drop-down list, and click OK.

INDEX

Symbols

2-D, 3-D map view 41

A

About button 42
 accessories 53
 address 11
 add a stop 9
 alerts, safety camera 55
 antennas 30, 33, 53, 58
 anti-theft feature 10, 42
 audio
 jacks 3, 50, 54
 options 49
 version 42
 avoiding
 road types 47
 traffic 47

B

battery 57, 60
 Bluetooth technology 23–29
 PIN 24
 settings 45–48
 brightness 2, 47
 browsing the map 18

C

calibrating the touch screen 52
 calling home 28
 call history 28

call waiting 26
 caring for your zūmo 58
 car installation 50
 charging the zūmo 52
 clearing user data 48
 Compass page 22, 47
 computer connection 35
 contact Garmin i
 coordinates 19, 20
 current location, saving 15
 customizing your zūmo 41–48
 Custom POIs 55

D

data storage drives 35, 60
 daylight saving 43
 Declaration of Conformity iv
 deleting
 all user data 48
 character 13
 custom POIs 56
 Favorites 16, 17
 files 37
 detail maps 41
 detours 10
 diacritical characters 13
 display settings 47
 drives, Garmin 36
 driving directions 22

E

editing saved places 15
 EGNOS 42

ejecting the USB 37
 elevation 20
 ending a call 25
 expanding your search 19
 Extras 54–55

F

Favorites 14
 editing 15
 finding 15
 saving 14
 sharing 14
 FCC compliance iv
 files
 deleting 37
 managing 35, 43
 supported types 37
 transferring 35–37
 finding places
 by address 11
 by coordinates 19
 by name 13
 by postal code 11
 intersection 11
 item on the map 18
 near another location 19
 saved places (Favorites) 15
 FM traffic 32
 fuel gauge 21
 fuse, changing 59

G

Garmin Lock 10, 42, 59
Garmin TourGuide
 playing files 56
Garmin Travel Guide 54
going home 12–19
Google Earth i
Go page 11
GPS 7, 60

H

hands-free features 23–29
headsets 23, 49
home location 12

I

importing data 43
intersection 11

K

keyboard 13, 48
kilometers 43

L

languages 43
loading additional maps 53
locking your zūmo 10

M

managing files 35–37
map
 browse 18
 customize 41
 Map Info button 41

 moving 18
 update maps 52
 using the Map page 18, 20
 version 41
 view 18, 41
 zoom 18
MapSource i, 35, 53
menu page 7
miles 43
mini-USB. *See* USB
motorcycle installation 3
mounting the zūmo
 in a car 50, 51
 on a motorcycle 3
MP3 files
 loading 35
 playing 38
mute a call 25
myGarmin i, 53, 55

N

navigation settings 46
Near button 19
Next Turn page 22
North Up map view 41

O

off road, routing 17, 47

P

pairing a headset 24
pairing a mobile phone 24
phone book 27
phone calls 25

picture viewer 44
PIN
 Bluetooth 45
 Garmin Lock 10
playing music 38
POIs, custom 55
position icon 20, 41
postal code 11

R

recently found location 14
registering your zūmo 53
remote antenna 58
removable disk drive 36
removing/deleting a phone 45
removing the mount 51
resetting
 the trip data 21
 your zūmo 52
restoring settings 48
routes 16–18
routing preferences 46

S

safety cameras 55
Safe Mode 42
satellite signals 7, 60
SaversGuide 56
saving
 places you find 12, 14
 routes 16
 your current location 15, 18
school zone database 55

Screen Shot mode 47
SD card 1, 35, 60
 sharing 14, 17
security location 10
settings 41–48
setting your location 12, 18
show map 12, 22
slide show 45
software
 updating 52
 version 42
special characters 13
specifications 60
spelling the name of a place 13
splash screen 47
storing your zūmo 58
supported file types 35
system settings 42

T

text language 43
time format 43
time zone 43
tones 47
touch screen
 aligning 52
 cleaning 58
Track Up map view 41
traffic
 avoiding 30, 47
 incidents 30
 settings 48
 subscriptions 32

transferring files 35–37
Trip Information page 21
trip log 44
troubleshooting 62–64
turn-by-turn directions 22
Turn List page 22

U

unit ID 42
updating
 maps 53
 zūmo software 52
USB
 mass storage mode 35–37
 ports 1, 35, 50, 52, 54
 troubleshooting 62
user data 43

V

vehicle icon 20, 41
vehicle type 47
view pictures 44
voice dial 29
voice language 43
volume 2, 34

W

WAAS 42
WebUpdater 52

X

XM NavTraffic 32
XM radio 33

Z

zoom 18, 20, 44

**For the latest free software updates (excluding map data)
throughout the life of your Garmin products, visit the Garmin
Web site at www.garmin.com.**



© 2006–2007 Garmin Ltd. or its subsidiaries

Garmin International, Inc.

1200 East 151st Street, Olathe, Kansas 66062, USA

Garmin (Europe) Ltd.

Liberty House, Hounslow Business Park, Southampton, Hampshire, SO40 9RB UK

Garmin Corporation

No. 68, Jangshu 2nd Road, Shijr, Taipei County, Taiwan

www.garmin.com

Part Number 190-00697-00 Rev. B

Free Manuals Download Website

<http://myh66.com>

<http://usermanuals.us>

<http://www.somanuals.com>

<http://www.4manuals.cc>

<http://www.manual-lib.com>

<http://www.404manual.com>

<http://www.luxmanual.com>

<http://aubethermostatmanual.com>

Golf course search by state

<http://golfingnear.com>

Email search by domain

<http://emailbydomain.com>

Auto manuals search

<http://auto.somanuals.com>

TV manuals search

<http://tv.somanuals.com>