



**GarrettCom™**

Ethernet at Its Best™

**Magnum 8000X**

## **Mixed-Media Fiber Hubs**



## **Installation and User Guide**

# Magnum™ 8000X Mixed-Media Fiber Hubs

## Installation and User Guide

Part #: 84-000122 (Rev C 04/02)

### Trademarks

Ethernet is a trademark of Xerox Corporation

NEBS is a trademark of Telcordia Technologies

UL is a registered trademark of Underwriters Laboratories

**GarrettCom, Magnum and Personal Switch** are trademarks and **Personal Hub** is a registered trademark of GarrettCom, Inc.

**Important:** The Magnum 8000X Mixed-Media Fiber Hub contains no user serviceable parts. Attempted service by unauthorized personnel shall render all warranties null and void. If problems are experienced with Magnum 8000X Mixed-Media Fiber Hub products, consult Section 6, Troubleshooting, of this User Guide.

Copyright © 2002 GarrettCom, Inc. All rights reserved. No part of this publication may be reproduced without prior written permission from GarrettCom, Inc.

Printed in the United States of America.

## Contacting GarrettCom, Inc

Please use the mailing address, phone and fax numbers and email address listed below:

### **GarrettCom, Inc.**

*47823 Westinghouse Drive*

*Fremont, CA 94539*

***Phone (510) 438-9071***

*Fax (510) 438-9072*

*Website: <http://www.GarrettCom.com>*

***[email support@garrettcom.com](mailto:email.support@garrettcom.com)***

### **Federal Communications Commission**

#### **Radio Frequency Interference Statement**

*This equipment generates, uses and can radiate frequency energy and if not installed and used properly, that is in strict accordance with the manufacturer's instructions, may cause interference to radio communication. It has been tested and found to comply with the limits for a Class A computing device in accordance with the specifications in Subpart J of Part 15 of FCC rules, which are designed to provide reasonable protection against such interference when operated in a commercial environment. Operation of this equipment in a residential area is likely to cause interference, in which case the user at his own expense will be required to take whatever measures may be required to correct the interference.*

# The Magnum Line

## ETHERNET CONNECTIVITY PRODUCTS

"DESIGNED AND MANUFACTURED IN THE USA"

### OVERVIEW

GarrettCom, Inc. offers the premium-quality Magnum™ line of Ethernet LAN connectivity products with industry-standard functionality and built-in fiber configurability. Magnum products are designed for use in demanding Carrier Class, Industrial Grade and OEM applications where reliability is a primary consideration.

**6K25 Managed Fiber Switches**, Gigabit, 100 and 10 Mbps, fiber and copper ports, mix-and match. Features SFF fiber for up to 25 fiber ports in a 1U unit.

**4K-Series Switches**, 100 and 10 Mbps, copper ports with optional fiber port, with auto-negotiating full switching performance.

**Quad-Series Fiber Switches**, 100 & 10Mbps, fiber and copper ports, mixed-speed and mixed-media types, full switching performance.

**"Outdoor" Ethernet Switch**, for temperature uncontrolled locations

6 10/100 and 2 100Mb fiber ports, can be connected in strings

**Mixed-Media Fiber Hub, 16-port Stackable**, 10/100 auto-sensing

**Dual Speed 8-port and 16-port Stackables**, 10/100 auto-sensing

**Stackable Hubs, SNMP Optional**

10Mb series and 100Mb series, both w/ optional port modules

**Personal Switches, 10/100Mb**

8 port dual speed, Auto-negotiable with fiber option

**Personal Hubs, 100Mb or 10/100Mb**

8-port, with two switched ports (1 fiber built in)

**Personal Hubs, 10Mb series**

8-port + AUI, stackable to 5 high, + optional BNC of fiber port

8 or 9-port and 4 or 5-Port Personal Hubs, w/ man. up-link sw.

**Media Converters, 10Mb and 100Mb series**

All media combinations, incl. fiber ST, SC, mm., single mode

**The "X-line" of configurable MiXed Media products:**

**Stackable Concentrators, SNMP optional, 13-Ports**

**Mini-Concentrators, 7 Ports, Repeaters, 2-Ports**

**Repeater Port Modules (RPMs)**, 6 types for Ethernet media

**Bridge Port Modules (BPMs)**, 4 types, for segment isolation

**Transceivers, 10Mb series Mini-Transceivers and Coax Models**

Apr, 02

<u>TABLE OF CONTENTS</u> .....	<u>PAGE</u>
1.0 TECHNICAL SPECIFICATIONS .....	1
1.1 Specifications - Port Modules (PMs) for front ports.....	3
1.2 Specifications - Switch Port Module (SPM) for bonus port.....	3
1.3 Ordering Information.....	4
2.0 INTRODUCTION - MAGNUM 8000X MIXED-MEDIA FIBER HUB.....	5
2.1 Inspecting the Package and Product.....	5
2.2 General Information.....	6
2.3 Product Description - Magnum 8000X Fiber Hub.....	6
2.3.1 The Magnum 8000X Fiber Hub Chassis.....	7
2.4 Port Modules (PMs).....	8
2.5 Switch Port Modules (SPMs).....	9
2.5.1 Magnum SPM-FDST .....	12
2.5.2 Magnum SPM-FDSC.....	13
2.5.3 Magnum SPM-FDSSC.....	13
2.5.4 Magnum SPM-TTX .....	14
2.5.5 Magnum SPM Specifications Summary Table .....	14
2.6 10/100 Speed Auto-Sensing (front ports, copper only).....	15
2.7 Stacking Magnum Mixed-Media 8000X .....	15
2.8 Bridge module between 10/100Mbps domain .....	16
2.9 Feature & Benefits.....	18
2.10 Applications.....	19
3.0 INSTALLATION - MAGNUM 8000X INSTALLATION.....	21
3.1 Locating the Magnum 8000X .....	21
3.2 Connecting Ethernet Media.....	21
3.3 Connecting Fiber Optic ST-type “twist-lock”.....	22
3.4 Connecting Fiber Optic SC-type “snap-in”.....	22
3.5 Connecting Fiber Optic Single-Mode .....	23
3.6 Connecting Twisted-Pair, RJ-45 .....	23
3.6.1 100Mbps collision domain diameter, cable distances and PDV *.....	24
3.6.2 Connection to NICs, that support Auto-negotiation.....	27
3.7 Table-Top or Shelf Mounting .....	27
3.8 Rack-Mounting .....	27
3.9 Port Module (PM) Installation* .....	28
3.9.1 Preparation for Installing and Removing PMs.....	28
3.9.2 Installing PM Cards in the Magnum 8000X*.....	30
3.9.3 Removing PM cards.....	31
3.10 Preparation for Installing and Removing SPMs * .....	32

3.10.1	Installing SPM module in Magnum 8000X *	34
3.10.2	Removing SPM module *	35
3.11	Powering the Magnum 8000X	35
4.0	OPERATION -	37
4.1	Repeater Functionality	37
4.2	Dual Speed Functionality	37
4.3	Auto-negotiation and speed sensing	39
4.4	Chassis LEDs	39
4.5	Power Budget Calculations for Fiber Media *	40
5.0	INTRODUCTION - MAGNUM PORT MODULES (AS SEPARATE ITEMS IN A SHIPMENT)	41
5.1	Inspecting the Package and Product	41
5.2	Product Description	41
5.2.1	FPM-MST (FX), FPM10-MST (FL), Fiber ST “twist-lock” connec.	42
5.2.1a	FPM10-MST ,10Mbps multimode, FC- ST “twist-lock” connec....	42
5.2.2	FPM-MSC (FX), FPM10-MSC (FL), Fiber SC “snap-in” connect	42
5.2.2a	FPM10-MSC 10Mbps multimode FC- SC “snap-in” connector....	43
5.2.3	Single-Mode FPMs, 10 and 100Mbps	43
5.2.3a	FPM10-SSC, 10Mbps Singlemode FC- SC “snap-in” connector....	43
5.2.3b	FPM10-SST,10Mbps Singlemode FC-ST “snap-in” connector.....	44
5.2.4	FPM-MTRJ, FX small-form-factor “plug -in” connector	44
5.2.5	FPM-MV45, FX small-form-factor “plug -in” connector.....	44
5.2.6	FPM-SXMST and -SXMSC (100BASE-SX short wavelength) .....	45
5.2.7	PM-RJ45 & PM-RJ45U (Twisted Pair).....	46
5.2.8	PM-FP.....	47
6.0	TROUBLESHOOTING	48
6.1	Before Calling for Assistance.....	48
6.2	When Calling for Assistance .....	49
6.3	Return Material Authorization (RMA) Procedure.....	49
6.4	Shipping and Packaging Information .....	50
APPENDIX A: WARRANTY INFORMATION		50
APPENDIX B: OPTIONAL 48VDC POWER SUPPLY *		51
APPENDIX C : INTERNAL DC <u>DUAL-SOURCE</u> POWER OPTION		53

Revisions

**Rev D 05/02** : Updated the Rack Mounting and Appendix B & C with 24VDC & 125VDC Power Supply option

**Rev C 05/01** : Change the company name to GarrettCom, Inc. (Formerly it was Garrett Communications). There are no changes to the content of the material at this time

**Rev B 01/01** : Added or changed 100Mbps collision domain diameter, cable distances and PDV; Port Module (PM) Installation; Installing PM Cards in the Magnum 8000X; Preparation for Installing and Removing SPMs; Installing SPM module in Magnum 8000X; Removing SPM module; Power Budget Calculations for Fiber Media; Optional 48VDC power supply; Optional 48V Dual-Source DC power; Optional Dual Power Supply, AC Power; Optional Dual Power Supply, 48VDC Power.

**Rev A 03/99** : This revision is the initial release of the Magnum 8000X Mixed-Media Fiber Hub user manual.

## 1.0 Technical Specifications

**Performance** (hub supports both 10 and 100Mb domains, ports individually selected)

When a port is operating at 100Mbps

Data Rate: 100Mbps

PDV (Path Delay Value): 80BT, exceeds Class II

When a port is operating at 10 Mbps :

Data Rate: 10 Mbps

Partitioning: Enforced after 63 consecutive collisions

Auto-reconnect: Occurs after one packet of error-free reception

### Network Standards

100Mbps : Ethernet IEEE 802.3u , 100BASE-TX, 100BASE-FX, 100BASE-SX

10 Mbps : Ethernet IEEE 802.3, 10BASE-T, 10BASE-FL

RJ-45 ports are auto-sensing for speed: IEEE 802.3u

### Packet-Processing Between Domains (internal 10/100 switch or bridge)

Filtering and Forwarding Rate from 100Mbps ports : 148,800 pps max

Filtering and Forwarding Rate from 10 Mbps ports : 14,880 pps max.

Processing type : Store and Forward

Auto-learning : 8K address table, shared for both traffic domains

Packet buffers : 2MB,dynamically allocated & shared on both domains

Latency (not including packet time) :

100 to 10 Mbps : 5 $\mu$ s

10 to 100Mbps : 5 $\mu$ s

CPU Type : State Machine

### Maximum Ethernet Segment (or Domain) Lengths

10BASE-T (CAT 3, 4, 5 UTP) - 100 m (328 ft)

100BASE-TX (CAT 5 UTP) - 100 m (328 ft)

Shielded twisted pair - 150 m (492 ft)

10BASE-FL multi-mode fiber optic - 2 km (6,562 ft)

10BASE-FL single-mode fiber optic - 10 km (32,810 ft)

100BASE-FX, half-duplex:(multi-mode) - 412 m (1350 ft)

100BASE-SX, short wavelength hdx (m.m.) - 300 m ( 935 ft)

100BASE-FX, full duplex:(multi-mode) - 2.0 km (6,562 ft)

100BASE-FX, half-duplex:(single-mode) - 412 m (1350 ft)

100BASE-FX, full duplex:(single-mode) - 15.0 km (49,215 ft)

### Operating Environment

Ambient Temperature: 32°F to 122°F (0°C to 70°C)

Storage Temperature: -20°C to 70°C

Ambient Relative Humidity: 5% to 95% (non-condensing)

### Power Supply, AC (Internal)

AC Power connector : IEC-type, male recessed, rear of chassis

Power Input Voltage : 90 to 260 VAC (auto ranging)

Power Input Frequency : 47-63 Hz

Power Consumption : 25 watts typical, 30 watts max. P.S. rating



**DC Power Supply (Options)**

**-48VDC Power** Input Voltage : 36 to 70 VDC

**24VDC Power** Input Voltage : 20 to 36VDC

**125VDC Power** Input Voltage : 120 to 160VDC

Std. Terminal Block : “ -, GND, + ”

Power Consumption: same as for AC models, see above

For Dual Source and Redundant DC for -48VDC, 24VDC Power & 125VDC supply options (Optional), see Appendices

For optional 23” Telco rack-mount brackets, order Model # **RMB-23W**

**Network Cable Types (Modular on a per-port basis)**

Fiber ports at 100Mbps and/or at 10 Mbps:

Multi-mode (62.5/125 typical) and single-mode (9/125 typical)

100Mbps copper (RJ-45): Category 5 UTP/STP

10 Mbps copper: Cat 3, 4, 5 UTP (Note: auto-neg. doesn't sense cable type)

**Stacking Cable** - stacking may be up to three units (48 ports) of mixed-media 8000X hubs and/or DS8016-A Dual-Speed hubs.

A stacking cable with 25 pin DB25 male connectors, shielded, 9 inches (23 cm) long, is included with each Magnum 8000X-A add-on unit.

**Manual Switches**

Up-link Switch: RJ-45U Port Module only (for crossover and cascading)

Auto/100 Switch: RJ-45 and RJ-45U port Module (for auto-negotiation or fixed 100Mbps speed operation)

**Packaging**

Enclosure: High strength metal. 1U rack-mounting brackets included.

Suitable for wiring closet shelf, 19” rack or desktop mounting.

Dimensions: 1.75 in H x 17 in W x 9 in D ( 4.4cm x 43.2cm x 22.9cm)

Weight: 4.0 lb. ( 1.8 Kg)

Cooling method: Fan cooled, internal @ 9 cfm

**LED Indicators**

PWR : Steady On when power applied

BR : Steady On, unit has bridge module inside

COL 10 and 100 : Collision LEDs, one for each speed domain

ACT 10 and 100 : Activity LEDs, one for each speed domain

**Agency Approvals**

Safety :UL Listed (UL 1950), cUL, CE

Emissions: meets FCC Part 15, Class A

**Warranty**

Three years, return to factory

Made in USA

## 1.1 Specifications - Port Modules, for front ports of the Magnum 8000X

(For Power Budget data, see Section 4.5)

PM Model #	IEEE Standard	Speed	Connector type	-Mode
FPM-MST	FX	100Mbps	ST “twist-lock”	multi-
FPM-MSC	FX	100Mbps	SC “snap-in”	multi-
FPM-SSC	FX	100Mbps	SC “snap-in”	single-
FPM-MTRJ	FX	100Mbps	MT-RJ “plug-in”	multi-
FPM-MV45	FX	100Mbps	VF-45 “plug-in”	multi-
FPM-SXMST	SX	100Mbps	ST “twist-lock”	multi-
FPM-SXMSC	SX	100Mbps	SC “snap-in”	multi-
FPM10-MST	FL	10Mbps	ST “twist-lock”	multi-
FPM10-MSC	FL	10Mbps	SC “snap-in”	multi-
FPM10-SST	FL	10Mbps	ST “twist-lock”	single-
FPM10-SSC	FL	10Mbps	SC “snap-in”	single-
FPM-MFC	FL	10Mbps	FC “screw-on”	multi-
PM-RJ45	-T, TX	10/100 auto-neg.	RJ-45	twisted pair
PM-RJ45U	-T, TX	10/100 auto-neg.	RJ-45 with up-link sw.	TP
PM-BLNK			Blank cover for an unused port slot	

Two LED indicators per fiber port, in each PM, are “L” for LINK is made, “A” for traffic Activity. Additional LED for RJ-45 ports are “S” for Speed, where flashing indicates auto-negotiation is ready (or nothing is connected), steady ON indicates 100Mbps operation and OFF means 10 Mbps operation has been selected by the last auto-negotiation session.

## 1.2 Specifications - Switching Port Modules (SPMs) for bonus port

\* PDV (path delay value) of an SPM is the same as a user-node i.e. , 50 BT

SPM Type *	SPM-TTX	SPM-FDSC	SPM-FDST	SPM-FDSSC
<b>Physical Signaling Type</b>	100BASE-TX & 10BASE-T	100BASE-FX mm* f. duplex	100BASE-FX mm* f. duplex	100BASE-FX sgl.mode, fdx
<b>Connector Type</b>	RJ-45	Fiber-SC	Fiber-ST	Fiber-SC
<b>LINK LED</b>	yes	yes	yes	yes
<b>Receive (RX) LED</b>	yes	yes	yes	yes
<b>Up-link switch</b>	yes	n.a.	n.a.	n.a.
<b>10/100Mb switch</b>	yes	n.a.	n.a.	n.a.

(For power budget data, see Section 4.5)

### 1.3 Ordering Information (see Appendices for DC power supply options)

#### Magnum 8000X Mixed-Media Fiber Hubs \*\*

**Magnum 8000X** Base Chassis with 16 Port Module (PM) slots for 10/100 operation per port. Any mix of **100Mbps** and 10 Mbps Fiber PMs (see list below) may be factory or field configured. Includes a switch inside that bridges the two internal traffic domains. Has a bonus port for an optional switched fiber or copper (SPM) backbone connection. May be stacked with up to two DS8016-A or -E or 8000X-A add-on units for up to 3 units (48 front ports for users) in a stack. Internal universal power supply.

**Magnum 8000X-A** Add-on Chassis, 16 PM slots, no switch inside, use for stacking  
**8000X Front Port Modules (PMs):**

FPM-MST	Module w/ 100Mbps mm* Fiber FX ST connector
FPM-MSC	Module w/100Mbps mm* Fiber FX SC connector
FPM-SSC	Module w/100Mbps sgl.m* Fiber FX SC connector
FPM-MTRJ	Module w/100Mbps mm* Fiber FX MT-RJ connector
FPM-MV45	Module w/100Mbps mm* Fiber FX VF-45 connector
FPM-SXMST	Module w/100Mbps mm* Fiber SX ST connector ( <u>when available</u> )
FPM-SXMSC	Module w/100Mbps mm* Fiber SX SC connector ( <u>when available</u> )
FPM10-MST	Module w/10Mbps mm* Fiber FL ST connector
FPM10-MSC	Module w/10Mbps mm* Fiber FL SC connector
F PM10-SST	Module w/10Mbps sgl.m* Fiber FL ST connector
FPM10-SSC	Module w/10Mbps sgl.m* Fiber FL SC connector
FPM-MFC	Module w/10Mbps mm* Fiber FX FC “screw-on” connector
PM-RJ45	Module w/ RJ-45 for TP copper, supports 10/100 auto-negotiation
PM-RJ45U	Same as PM-RJ45 except includes an up-link (crossover) switch
PM-BLNK	Blank cover for an unused port.

#### Switch Port Modules (SPMs) for the Bonus Port:

SPM-FDSC	SPM w/ full-duplex multi-mode fiber FX SC connector, includes a separate switch with packet buffers and filter/forward operation
SPM-FDST	Same as -FDSC, but with ST connector
SPM-FDSSC	SPM w/ full-duplex <u>single-mode</u> fiber FX SC connector, includes a separate switch with packet buffers and filter/forward operation
SPM-TTX	SPM with RJ-45, manually selected as 10Mb or 100Mb speed

\* mm = multi-mode, sgl.m = single-mode

\*\* To convey configuration information to the factory, order chassis units followed by the PMs to be configured in it. For example, to order a Model 8000X Hub with a ten FPM10-MST ports factory installed, call out “Qty 1 Model 8000X” and then in sequence “Qty 10 Model FPM10-MST” as separate line items. This signifies that the ten FPM-MST modules are to be factory-configured in the 8000X unit. To order loose modules for field configuration, order “Qty 10 Model FPM10-MST (do not configure)”, for example.

GarrettCom, Inc. reserves the right to change specifications, performance characteristics and/or model offerings without notice.

## 2.0 Introduction - Magnum 8000X Mixed-Media Fiber Hub

### 2.1 Inspecting the Package and Product

Examine the shipping container for obvious damage prior to installing this product; notify the carrier of any damage which you believe occurred during shipment or delivery. Inspect the contents of this package for any signs of damage and ensure that the items listed below are included.

This package should contain:

- 1 - Magnum 8000X Base Unit (may have PMs factory configured)
- 1 - AC Power Cord (U.S. and other 115 vac only)
- 1 - Set of metal "Ears" for optional 19" rack mounting
- 1 - (Model 8000X-A only) Stacking Cable, 9" length
- 1 - Installation and User Guide
- 1 - Product Registration Card

**Note: Port Modules (PMs) purchased with the 8000X unit are usually factory configured and installed, and may be included as part of the 8000X unit when it is received.**

**Port Modules purchased for field installation will be boxed in a "bar-of-soap-size" cardboard carton with labeling to indicate the contents.**

Remove the unit from the shipping container. Be sure to keep the shipping container should the unit need to be shipped at a later date. To validate the product warranty, please complete and return the enclosed Product Registration Card to GarrettCom, Inc. as soon as possible.

In the event there are items missing or damaged contact the supplier. If the unit needs to be returned please use the original shipping container. Refer to Chapter 5, Troubleshooting, for specific product return procedures.

## 2.2 General Information

Designed for “fiber-to-the-desktop” applications that are economical and high performance, the Magnum 8000X accepts a variety of fiber modules so that users can choose the fiber port types desired. A dozen different 100Mbps and 10 Mbps fiber port module types are supported, and they are factory or field configurable.

Rich with configuration options, the 8000X units support either 10 or 100Mbps fiber modules per port, a rear bonus port accepts optional Switch Port Modules for switched backbone connections, stacking up to 3 units high (48 ports) is supported with DS8016-A Hubs configurable in the stacks, rack-mounting is standard, optional 48V DC power supplies (even dual-source DC or redundant DC) are available for telecom equipment applications, and RJ-45 ports when used are auto-sensing for speed.

## 2.3 Product Description

The Magnum 8000X brings you the future of Fiber Optic connectivity. The Magnum 8000X based on new technology is a highly versatile, cost effective Mixed-Media Fiber hubs that provides the flexibility of configurable fiber and RJ-45 ports, of 10 Mbps or 100Mbps Ethernet speed per hub. Each RJ-45 port is independently auto-sensing for 10/100 speed, adapting to match the speed of the connecting device. These capabilities provide the ultimate in flexibility for small to medium sized “fiber to desktop” and “fiber-for-security” networks that are gradually transitioning from 10 Mbps Ethernet to 100Mbps Fast Ethernet. Sixteen port slots are located on the front of the unit, are accommodated in a 1U rack-mount package.

Combinations of standard Ethernet media types are supported. These include 10BASE-FX, 10BASE-T, 100BASE-FX, 100BASE-TX, and (proposed) 100BASE-SX. The Magnum Dual -Speed 8000X supports almost all the popular fiber port connector i.e. ST, SC, FC, MT-RJ, and VF-45 in multi-mode or single-mode as applicable, and can be installed as 100Mbps or 10 Mbps speed (10Mb port connector types are ST, SC and FC only). The Magnum 8000X hubs support two shared traffic domains, one at 100Mbps and one at 10 Mbps, with an internal bridge or switch interconnecting the two domains. The automatic per-port speed-sensing is continuous, allowing a connected device to change speed and re-LINK at any time without impairing the operation of the other ports and connected devices.

The Magnum 8000X is designed with the capability to be stacked with other Magnum 8000X-A's and/or with Magnum 8016-A's. Magnum 8000X units may be

configured in a stack with as many as 3 total units. The two shared traffic domains automatically expand to support all of the ports in the stack. Any combination of 10 and 100Mbps ports, up to the maximum 48 ports (3units) in one stack, can be use at any time. In a stacked configuration, the complete stack operates as one logical dual-speed repeater. Depending upon the stack configuration (any mix of Magnum 8000Xs, Magnum 8016s units), up to 48 front Ethernet segments with any mix of fiber and copper ports is supported.

The Magnum 8000X is compact in design at only 1.75 in. (4.4 cm) high, and has a lightweight metal enclosure. It is easily rack mounted in a standard 19" rack and typically operates as the central hub for a multiple-backbone Ethernet network.

### 2.3.1 The Magnum 8000X Fiber Hub Chassis

The Magnum 8000X chassis houses one main PC board and an internal bridge module (daughter board). There are 16 front slots for mixed-media modules. Each front slot in the dual-speed chassis can accept any 8000X Port Module (PM) which will provide either 10 or 100Mbps operation over either fiber or twisted pair cabling. The 8000X is configured by selecting individual PMs, one per Ethernet port to be used. Configured 8000X units provide two traffic domains, one each with IEEE 802.3 and 802.3u repeater functionality.



Figure 2.3.a: Magnum 8000X, Front View

LEDs to indicate operating status are on the left front side. There are power (PWR) and bridge-inside (BR) indicators for the unit. There are collision (COL) indicators for each of the 10 Mbps and 100Mbps domains for visual indication of the operating status of each domain, and two activity (ACT) indicators for traffic activity on each domain. These LEDs provide a visual assessment of the operational condition and aggregate network activity of all segments installed in the unit.

**Figure 2.3.b: Front Panel LEDs**

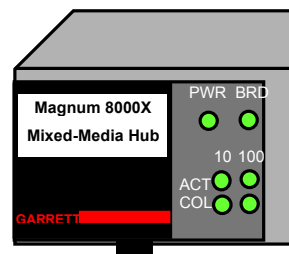

**AC Power Connector:** On the right side rear of the unit is the connection to the auto-ranging internal power supply that automatically adapts to the AC voltage of

the AC power system into which it is being installed. An ON/OFF power switch is used for powering the hub on and off when it is placed in or taken out of service, or when it needs to be reset. AC Power input is auto-ranging, from 100 to 240vac with a frequency of 47

to 63 Hz. When shipped for use in U.S. and Canada, a 115vac power cord is included.

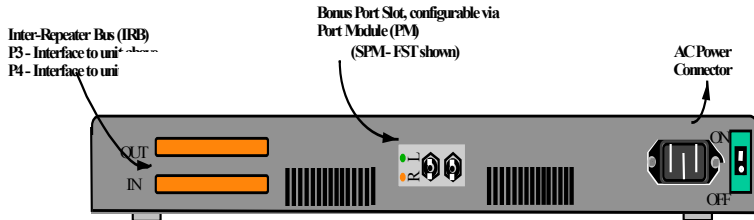

**Figure 2.3.c: Magnum 8000X Rear Panel View**

**Cooling Fan:** The Magnum 8000X is equipped with a low noise 9 cfm fan. The fan will maintain low temperature operation inside the unit to maximize reliability, even in wiring closets with ambient temperatures up to 50°C.

**Bonus Port:** The Magnum 8000X features a bonus port slot that is rear-mounted and is optionally configured with any one of the Switch Port Module (SPM) types. An SPM will segment the 8000X from the other parts of the network connected to it, providing flexibility in the network topology. This flexibility is especially desirable for 100Mb traffic domains which are Path Delay Value (PDV) limited.

PMs for the front slots may not be used in the rear Bonus Port slot.

**Inter-Repeater Bus (IRB):** The IRB allows a Magnum 8000X unit to be stacked with up to two Magnum 8000X-A and/or Magnum DS8016-A units to form one logical dual-speed repeater. Instructions for the using the IRB connectors on the Magnum 8000X are discussed in detail in Section 2.6, "Stacking Magnum 8000Xs".

## 2.4 Port Modules (PMs)

To provide maximum application flexibility, individual Port Modules (PMs) are used with the Magnum 8000X. The Magnum 8000X features 16 PM slots on the front of the unit and a bonus port slot on the rear of the unit, some (minimum of 2) or all of which may be configured at a given time. The bonus slot allows for an optional rear-mounted switched Ethernet segment connection, typically to a backbone. With the bonus slot, the 8000X becomes a 16-port dual-speed hub with one switched up-link.

There are a total of six standard PM cards, each for a specific media cable connector. A seventh module type is used as a face plate when any front slot is not

used. The Magnum 8000X PM network connector types, shown left-to-right in Figure 2.3a below, are “PM-RJ45U” for RJ-45s (10BASE-T or 100BASE-TX, UTP and STP) with an up-link switch, “FPM-MTRJ” for fiber MT-RJ (small form factor 100BASE-FX multi-mode), “FPM-MSC” for 100Mb fiber SC (100BASE-FX multi-mode) and same-in-appearance “FPM-SSC” for 100Mb fiber SC (100BASE-FX single-mode), “FPM-MST” for 100Mb FX fiber ST m.m., “FPM-MV45” for fiber VF-45 (small form factor 100BASE-FX multi-mode), the “FPM-SXMST” for 100BASE-SX (short-wavelength

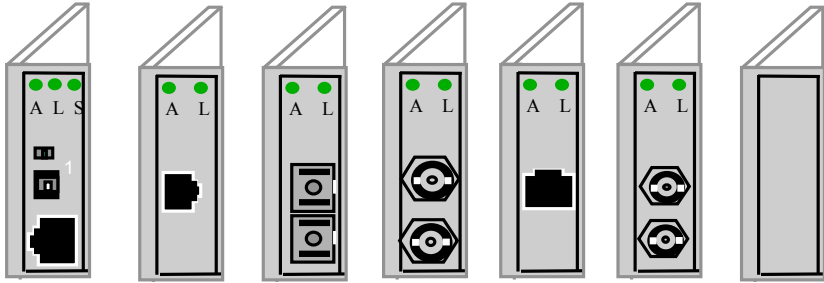

**Figure 2.4: Magnum Port Modules: PM-RJ45U, FPM-MTRJ, FPM-MSC, FPM-MST, FPM-MV45, FPM-SXMST, & PM-FP**

multi-mode ST), designed to be compatible with 10 Mbps FL, when available), and “PM-FP” for the face plate to cover blank slots. PM-RJ-45 (not shown) looks like PM-RJ45U but without the up-link switch. For additional details and descriptions of each Port Module, see Section 5 of this manual.

PMs for other fiber port types (for example, 10 Mbps FC-type) are possible as specials. If you need a different port type from those shown, contact GCI

Magnum PMs are normally installed in the front of Magnum 8000Xs at the factory prior to shipment, but may be installed or changed or removed in the field by a careful technician. The PM removal / addition procedures are described in Section 5.2.1.- 5.2.7.

## 2.5 Switch Port Modules (SPMs)

Magnum Switch Port Modules (SPMs) provide a compact switching port that filters and forwards packets, thus separating internal and external collision domains and enhancing the performance and configurability of the network. Unless specified at the time of order, each Magnum 8000X is shipped from the factory with no bonus port SPM installed. For application flexibility, any of the Magnum SPMs may be specified



for factory configuration at time of order. It is also possible for the rear bonus port to be re-configured in the field by a trained technician to add or exchange a Switching Port Module. Figure 2.5a below shows the internals of the Magnum 8000X with an SPM installed in the Bonus Port, accessible from the rear.

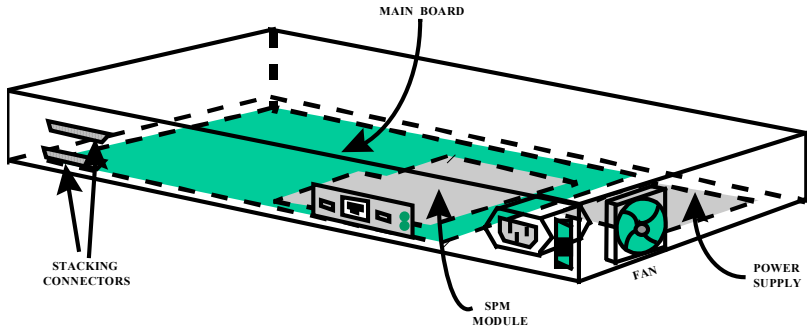

**Figure 2.5a: Inside view of Magnum 8000X with SPM installed. (Rear view)**

For the specifications of available Switch Port Modules (SPMs), see Section 1.3. The functions of an SPM are described below.

### **1. Filtering and Forwarding / Address Learning**

The SPM has two ports - one where media attaches, and one connecting into the inside of the mixed-media fiber hub in which the SPM is mounted. For each packet received by either port of the SPM, a decision is made to either filter the packet or to forward the packet to the other port. Error packets are always filtered. For good packets, the filter or forward decision is made based on the destination address contained in each packet. If the destination address is on the segment from which the packet originated, then it is filtered and not forwarded to the other segment. If the destination address didn't find a match in the address table, then it is forwarded to the other segment. If it is a new address which the SPM didn't previously know about, it "learns" the new address and puts it in the port's address table. The address tables have a capacity of 1K addresses for each port.

With this large address table, SPM port modules can serve the needs of medium-sized to large networks. The address tables are flushed periodically to update the network status and to purge any inactive stations from the tables. See the figure and table that follows:

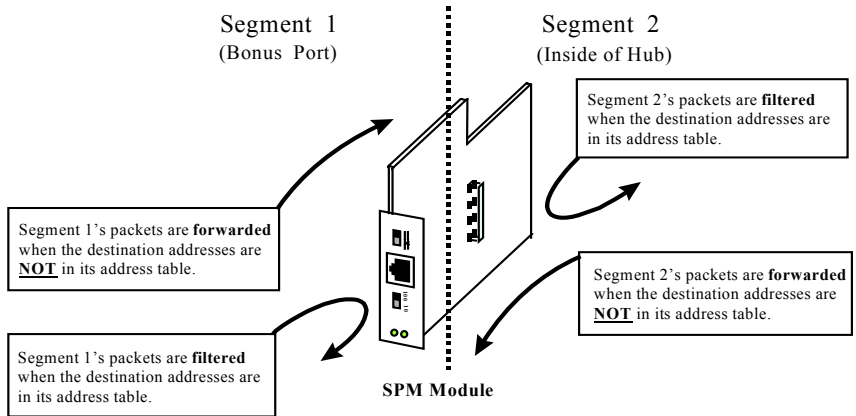

**Figure 2.5b: Forwarding vs. Filtering in SPM Modules**

<u>Packet Source</u>	<u>Source Address</u>	<u>Destination Address</u>	<u>Address Table Maintenance</u>	<u>Filter/Forward Action</u>
Seg. 1	Not in table	Not in table	Add source to table	Forward
Seg. 1	Not in table	In table	Add source to table	Filter
Seg. 1	In table	Not in table	None	Forward
Seg. 1	In table	In table	None	Filter
Seg. 2	Not in table	Not in table	Add source to table	Forward
Seg. 2	Not in table	In table	Add source to table	Filter
Seg. 2	In table	Not in table	None	Forward
Seg. 2	In table	In table	None	Filter

**Table 2.5: SPM Port Module Functionality**

## 2. Throughput Increase / Software Transparency

By selectively forwarding packets from the mixed-media hub's ports (or hub stack's ports) to the rear-connector port based on its switching logic, an SPM increases the available bandwidth for the users on both the hub side and the rear-segment side of the network. As shown in Figure 2.5b, it keeps the local traffic on each side contained, preventing unnecessary packets and bad packets from traveling to the other segment and using up bandwidth needlessly. This results in more available network bandwidth on both sides and a throughput increase for all users on both segments. An SPM needs

no software configuring and is transparent to system and application software, including network management software.

### 2.5.1 Magnum SPM-FDST

The significant feature of the SPM-FDST is that the fiber bonus port operates in full-duplex mode, sending packets on one fiber filament while simultaneously and independently receiving packets on the other. There is no “collision domain” with full- duplex, and while this violates the specs of traditional Ethernet, it is accepted in most situations.

Therefore, the SPM-FDST extends the distance limits of Fast Ethernet. In particular, with multi-mode fiber, it permits Fast Ethernet cable distances of up to 2km, much more than the 412m half-duplex distance limit otherwise obtainable.

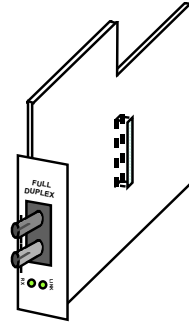

Magnum SPM-FDST

These SPMs can also be configured to operate as a half-duplex switch port. As shown in the figure, the jumper located on the SPM board by default is factory set to full-duplex mode (position 2-3).

By setting the jumper in position 1-2, it will operate as shared (half duplex). To operate properly in either half- or full-duplex mode, the device on the other end of the fiber segment must also be a corresponding device. Since full-duplex Fast Ethernet (802.3x) is a recent 1997 standard, it is recommended that the device on the other end of the segment be another full-duplex fiber SPM or equal.

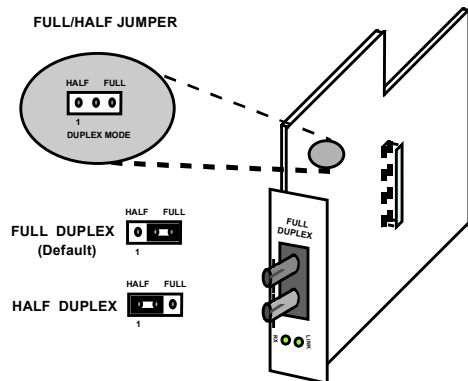

Magnum SPM-FDST

As is typical for bridges and switches, the internal packet buffer space of the SPM-FDST temporarily stores unfiltered packets. It is desirable to have a large packet buffer for temporary storage, particularly when operating at different speeds (such as 10 and 100) or with different traffic types (shared and full-duplex). The SPM-FDST packet

buffer is 1Mbps to maintain high network performance. The MAC address memory is 8KB, suitable for medium to large networks.

In summary, the Magnum SPM-FDST is a multi-mode fiber optic switching port module. It has 100Mb ST-type connectors. There are two LEDs, LINK and RX, to allow monitoring of LINK and packet reception (Activity) status of the SPM. The SPM may be used to connect to another full-duplex 100Mbps hub or switch using fiber cabling and using the 100BASE-FX protocol. It filters and forwards packets in both directions at Fast Ethernet wire speed.

### 2.5.2 Magnum SPM-FDSC

The Magnum SPM-FDSC is a multi-mode, full-duplex fiber optic switching port module with a 100Mb SC-type connector. The module may be used to connect to another 100Mbps hub or switch using fiber cabling and the 100BASE-FX protocol. It filters and forwards packets in both directions at Fast Ethernet wire speed.

The operation and application of the SPM-FDSC is the same as the SPM-FDST described above, except for the connectors on the fiber cable.

### 2.5.3 Magnum SPM-FDSSC

The Magnum SPM-FDSSC is a single-mode, full-duplex fiber optic switching port module with a 100Mb SC-type connector. The module may be used to connect to another 100Mbps hub or switch using fiber cabling and using the 100BASE-FX protocol. It filters and forwards packets in both directions at Fast Ethernet wire speed. Since the SPM module segments the network, it also maintains its address tables to know what node addresses are on which side of the unit.

The Magnum SPM-FDSSC includes full switching functionality and has two LED's - LINK and RX - to allow monitoring of link and activity status of the SPM. The Magnum SPM-FDSSC is a full duplex module. Thus, two

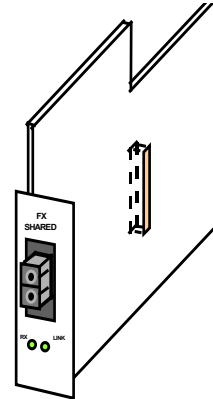

**Magnum SPM-FDSC**

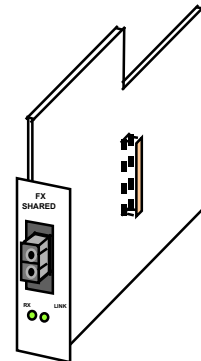

**Magnum SPM-FDSSC**

SPM-FDSSC's can be used together on each end of a fiber segment to get the maximum distance of 15km of single-mode fiber optic cable in a Fast Ethernet network. For an SPM-FDSSC used to connect into a separate collision domain, the cable distances and hop-counts allowable would have to be calculated taking into account all the devices' Path Delay Values (PDVs) that are part of that domain.

An SPM operating at 100Mbps has a PDV of 50 BT, i.e., the same PDV as a DTE or NIC card in a Fast Ethernet collision domain.

### 2.5.4 Magnum SPM-TTX

The Magnum SPM-TTX is a 10 Mbps or 100Mbps device equipped with one RJ-45 port which supports either 10BASE-T and 100BASE-TX. The 10/100 speed selection is done with a manual switch on the unit to prevent ambiguity where it may be used with other devices such as NICs that are auto-sensing.

The SPM-TTX filters and forwards packets, maintains its address tables, and segments the network when used as a 10BASE-T or a 100BASE-TX switch port. See Sections 2.5 and 2.5.1 for a general description of an SPM. The SPM-TTX includes an up-link switch to allow for connection to either user nodes or for cascaded up-link connections to other hubs. The attached devices may be either 10 Mb or 100Mbps.

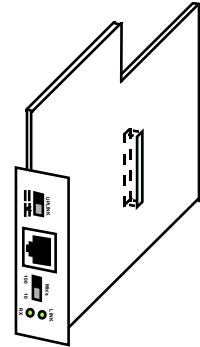

Magnum SPM-TTX

The Magnum SPM-TTX has two LED's - LINK and RX - to allow monitoring of link and packet reception status of the SPM's operation.

### 2.5.5 SPM Specification Summary Table

	Connector	Standard	Mb/s	Traffic	Pkt Buffer	Address
SPM-FDST	Fiber-ST	100BASE-FX	100/200	full-duplex	1MB	8K total
SPM-FDST	Fiber-SC	100BASE-FX	100/200	full-duplex	1MB	8K total
SPM-SSC	Fiber-SC	100BASE-FX	100/200	full-duplex	1MB	8K total
SPM-TTX	RJ-45	10BASE-T & 100-TX	10 or 100	shared	256KB	1024/port

(See also "Specifications - SPMs," Section 1.3)

## 2.6 10 /100 Speed Auto-sensing (8000X front copper ports only)

Twisted pair copper ports (PM-RJ45 or PM-RJ45U only) support auto-sensing for speed, independent of the other ports. Speed-sensing is performed by the Magnum 8000X's electronics in accordance with the standards of the IEEE 802.3u auto-negotiation standard. If the connected device or node indicates that it is capable of 100Mbps speed, then operation on that port will be at 100Mbps. If the connected device does not positively indicate that it is capable of 100Mbps speed, then the operation on that 8000X port will be at 10Mbps. Of course, the hubs' auto-negotiation technique is only for 10 / 100 speed, and does not provide for any full-duplex operation.

When a twisted-pair port is connected and LINK is present, the speed on that port that has been sensed by the Magnum 8000X Mixed-Media Fiber Hub will be indicated by the 'S' LED for that port. The 'S' LED is steady ON when 100Mbps speed is sensed, and is steady OFF when 10Mbps speed is in use. When the port is not connected, the 'S' LED on that port will be blinking to indicate that it is trying to auto-negotiate. (See section 4.3 for the LED's).

## 2.7 Stacking Magnum Mixed-Media 8000X Fiber Hubs

The rear of the Magnum 8000X Mixed-Media Fiber Hubs have an Inter-Repeater Bus (IRB) connector on the left side. The IRB interconnects stacked units with a stacking cable, enabling all stacked Magnum 8000X units to operate as a single dual-speed repeater. There are two 25-pin IRB connectors on each unit: the bottom IRB connector which is used to daisy chain the IRB to the stacked unit below (unused on bottom unit in a Magnum 8000X stack); and the top IRB connector which is used to daisy chain the IRB to the stacked unit above (unused on top unit in a Magnum 8000X stack). The IRB connectors for non-stacked units are unused.

The IRB stacking shielded cables supplied with each Magnum 8000X-A unit are slightly longer than the base unit height. The operation of the stack will not be impaired by longer IRB RS232 cables. Stacks with total IRB lengths of as much as 9-inch long shielded cables can be implemented. However, non-standard IRB cable lengths, longer cables or unshielded cables are not permitted as they will not operate properly at 100Mbps speeds.

The 8000X Mixed-Media Fiber Hub can be stacked with Magnum DS8016-A models, too. (But not with DS8016-B because of the "bridge-inside" conflict)

Normally, one Magnum 8000X hub is needed to provide a switch between the 10 and 100Mbps domains.

With one base model Magnum 8000X, up to two additional 8000X-A “add-on” units or two DS8016-A hub units can be stacked to operate as one 10/100 Dual-Speed repeater with up to 48 dual-speed ports, with any mix of fiber and copper port types.

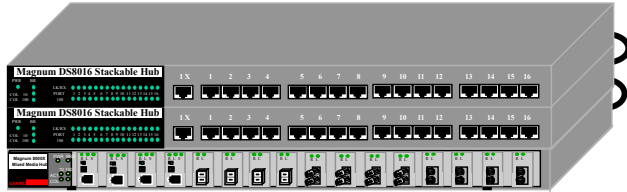

**Fig.2.7a** A stack of one Magnum 8000X and two DS-8016-A's

When connecting mixed-media 8000X's in a stack, use the stacking RS232 cable to connect the “OUT” stacking port from one 8000X unit to the “IN” stacking port of the other. Push in the cable connectors until they seat in firmly. Also, leave space along the left-side area for the exhaust of the internal cooling fan in each 8000X unit.

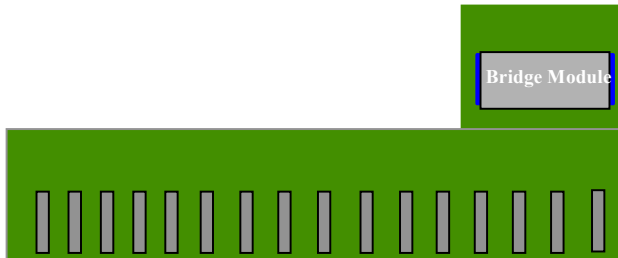

**Figure 2.7b** Magnum 8000X's stacked. Cables connect “Out” and “In”

## 2.8 Bridge Module between the 10 Mbps and 100Mbps Domains

Magnum 8000X's contain a factory-installed bridge module to interconnect the two traffic domains, filtering and selectively forwarding packets to allow only necessary packets to cross between the domains. This enables all of the users and nodes connected into either domain, whether 100Mbps or 10 Mbps , to communicate to each other, and it keeps local traffic on one domain from consuming any of the bandwidth of the other domain.

The bridge operates in the store-and-forward mode, which filters out bad packets and maintains optimum performance in both domains. Packet forwarding delay is only 5 $\mu$ s (plus packet time), much less than traditional store-and-forward bridge products, enabling the 8000Xs to maintain high network performance. The bridge has 8K node address capacity, suitable for use in large networks. Addresses are self-learning so that filtering / forwarding of 10 Mbps and of 100Mbps packets is maintained correctly even when users move their connection, or change speed, or power down.



**Figure 2.8 : Internal view of 8000X with bridge module installed**

The Magnum 8000X's bridge module is implemented as a daughter board. 8000X units have an LED on the front labeled **BR** that will be **ON** when the module is installed internally. (The Model 8000X-A is an "add-on" unit for stacking, and has no bridge inside, so its **BR** LED will be off). In a stack of Magnum 8000X's and / or other compatible hubs, only one unit with a bridge inside may be operating in any one stack.



## 2.9 Features and Benefits

### ■ Supports 10 or 100Mb network connections on each of sixteen ports

Magnum 8000X Dual-Speed Fiber Hubs combine two logical hubs --- one at 10 Mbps and one at 100Mbps --- in one physical box supporting two traffic domains. Each port can operate at either 10 or 100Mbps, independently of the other ports.

### ■ Mixed-Media 10 & 100Mb fiber port types in one unit for maximum flexibility

The Magnum 8000X is configurable with up to 16 economical port modules, and any or all of the ports may be either 10 or 100Mbps fiber. RJ-45 ports may also be configured, with per-port selection. Port Modules with all kinds of fiber connector types are supported, making the 8000X Fiber Hub ideal for “fiber-to-the-desktop” applications.

### ■ Switched port in the rear Bonus Port for a FDX fiber backbone, optional

To segment a Magnum 8000X (or stack) from a connected hub or switch using full-duplex fiber operating at 100Mbps, an optional SPM may be installed. This provides distances up to 2Km for the fiber link, and improved performance for the 8000X’s users.

### ■ Stackable and Scaleable Configurations

The Magnum 8000X is equipped with an inter-repeater bus that allows multiple units (one 8000X and up to two 8000X-A units or two DS8016-A) to be stacked, thus supports up to 48 ports with all ports operating as a single dual-speed mixed-media repeater.

### ■ Auto-sensing for speed, 10 or 100Mbps, on each RJ-45 front port

All RJ-45 ports support 10/100 auto-negotiation for speed, IEEE802.3u. compliant.

### ■ LEDs for Chassis and PM Cards

The Magnum 8000X chassis and each of the 16 front-mounted PM cards are equipped with traffic activity and segment-status LEDs, conveniently monitored from the front.

### ■ Installation is “Plug and Play”, Operation is Transparent to Software

The Magnum 8000X operates as a hardware switch between domains, only forwarding those packets from each domain that are needed on the other domain. Internal address tables are self-learning, enabling users to change port connections or 10 or 100Mbps domains without affecting operations.

### ■ Internal Power Supply, Auto-ranging AC voltage and frequency

An internal universal power supply allows any Magnum 8000X unit to be used with the normal AC power types found around the world. (A 48VDC power supply is optional)

## 2.10 Applications

The 8000X Port Modules are factory and field configurable. This (and the stacking feature) provides for easy expansion of the network, and it provides flexibility to adapt to new fiber port connector types as technology changes. The flexibility of the Magnum 8000X makes it the choice for applications that require a flexible and adaptable 10/100 hub.

See also Section 1.0, Technical Specifications, for additional Magnum 8000X information that may indicate suitable applications.

**Example 1: Upgrade, Expansion, Fiber Flexibility :** A University library has fiber cabling installed in the building from the wiring closet to each PC. They have operated the network setup at 10 Mbps. They have five users, a 10Mbps print server, and Internet access. Now they require higher bandwidth to accelerate their network. They want to upgrade three of their present users to 100Mbps speed and expand for another five 100Mbps users (all with fiber), and they expect a few more users next year.

A Magnum 8000X Dual-Speed Fiber Hub handles all of the users at 10 Mbps and 100Mbps over fiber and copper in the same hub unit. Port modules can be changed or added over time to suit expansion and additional changes. The 8000X is initially configured with eight ports at 100Mbps fiber, two ports at 10Mbps fiber, and three 10/100 RJ-45 copper ports. The Magnum 8000X not only increases the network's bandwidth and efficiency, but it also handles existing 10Mbps nodes over fiber in a economical way. The print server stays at 10Mbps over twisted pair wiring, and is accessible by all users. The file server and the Internet access, devices located adjacent to the 8000X, operate over twisted pair at 100Mbps.

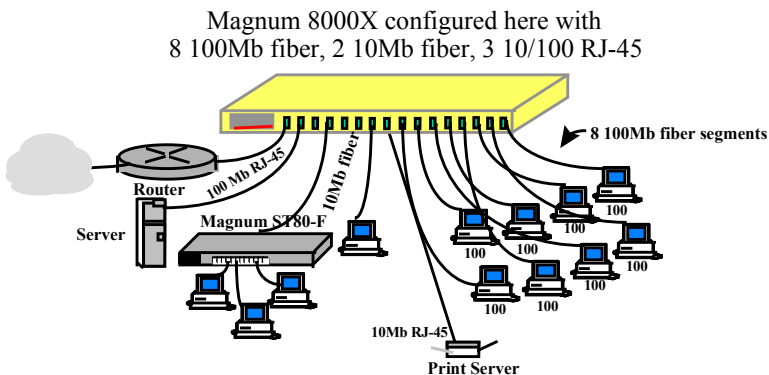

A diagram of the installation is shown here.

**Example 2: Security, Fiber Flexibility:** In a government intelligence agency where a secure network is the first priority, the possibility of eavesdropping (as is possible with copper wiring) must be prevented. Fiber LANs are regularly used to connect to each desktop and each node.

The Magnum 8000X Fiber Hubs support all of the fiber port types (including the latest models), adapting the fiber LAN to changing technology. The Dual-Speed feature provides for growth in performance to higher bandwidth 100Mbps speed, and the port modularity plus stacking provide for port expansion.

Magnum 8000X has 16 ports per unit, is stackable up to 3 units, and economically supports all fiber types for the desktop for maximum **security and flexibility**.

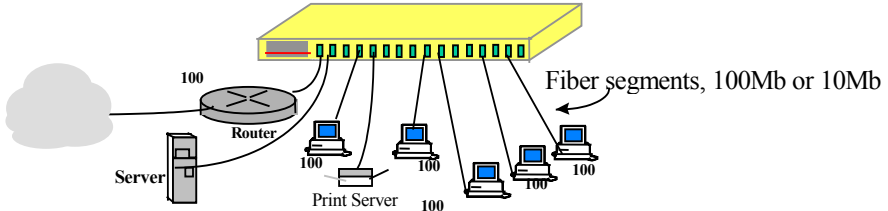

**Example 3: Future-proofing, industrial environments:** In heavy industrial plants (such as steel mills, electrical generating stations, telecom central offices, hospitals, etc.), fiber LAN cables are usually used for noise immunity and electrical ground-isolation. In this kind of environment where computer systems are used to monitor and / or manage operations, an Ethernet fiber link is used to collect real-time data via SNMP agents in the equipment. The SNMP management fiber network almost always operates at 10 Mbps. Network management workstations and network servers use 100Mbps ports to the high performance nodes.

Magnum 8000X offers a full range of fiber port modules (both 10Mb and 100Mb), 10/100 RJ-45, and stackability for the ultimate in “future-proofing”, even noisy specialty environments

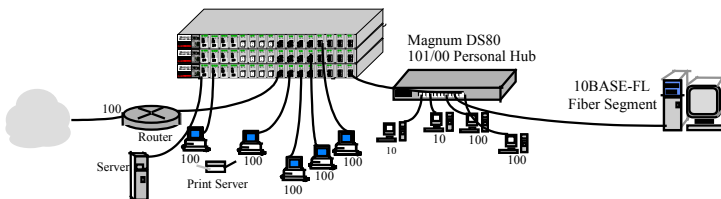

The Magnum 8000X Dual-Speed Fiber Hub is ideal in these situations. The fiber ports are economical and may be a mix of 10 and 100Mbps, and may be any quantity or mix of standard port connector types. Individual 10/100 RJ-45 ports may be configured also, and an optional SPM can segment local users from the rest of the network. Stacking provides capacity for up to 48 ports, and the 8000X can be stacked with a DS8016-A for a mix of RJ-45 and fiber ports. The flexibility results in a “future-proof” fiber hub. The illustration below shows this type of installation.

### 3.0 **Magnum 8000X Installation**

Before installing the equipment, it is necessary to take the following precautions:

- 1.) If the equipment is mounted in an enclosed or multiple rack assembly, the environmental temperature around the equipment must be less than or equal to 50°C.
- 2.) If the equipment is mounted in an enclosed or multiple rack assembly, adequate air flow must be maintained for proper and safe operation.
- 3.) If the equipment is mounted in an enclosed or multiple rack system placement of the equipment must not overload or load unevenly the rack system.
- 4.) If the equipment is mounted in an enclosed or multiple rack assembly, verify the equipment's power requirements to prevent overloading of the building/s electrical circuits.
- 5.) If the equipment is mounted in an enclosed or multiple rack assembly verify that the equipment has a reliable and uncompromised earthing path.

**Installation:** This section describes installation of the Magnum Mixed-Media 8000X Hub, as well as connection of the various Ethernet media types.

### 3.1 **Locating the Magnum 8000X**

The location of the Magnum 8000X is dependent on the physical layout of the network and the area to be served. The unit is typically rack mounted in a wiring closet but because it has rubber feet it can also be installed on a shelf or table top. While stacks of up to 3 units and the associated cabling can be accommodated on a shelf or table top, it is recommended that larger stacks be rack mounted. Each unit is shipped with a pair of metal "ears" that attach to each side of the unit to easily accommodate mounting in standard 19" RETMA racks. (Brackets for 23" telco racks are optional at extra cost).

### 3.2 **Connecting Ethernet Media**

The Magnum 8000X Mixed-Media Fiber Hub is specifically designed to support all standard Ethernet media types within a single hub unit. This is accomplished by using a family of Port Modules (PMs) which can be individually selected and configured per-port. See Section 2.4 for a description of the PMs.

The various media types supported along with the corresponding IEEE 802.3 and 802.3u standards and connector types are as follows:

<u>IEEE Standard</u>	<u>Media Type</u>	<u>Max. Distance</u>	<u>8000X Port Module</u>
<b><u>Fiber:</u></b>			
10BASE-FL	mm <sup>1</sup> Fiber	2.0km(6562 ft)	FPM10-MST, FPM10-MSC
	sgl.m <sup>2</sup> Fiber	10.0km(65620ft)	FPM10-SST, FPM10-SSC
100BASE-FX	mm <sup>1</sup> Fiber	200 m <sup>3</sup> (650 ft)	FPM-MSC, FPM-MST
small form factor	“	“	FPM-MTRJ, FPM-MV45
	sgl.m <sup>2</sup> Fiber	200 m <sup>3</sup> (650 ft)	FPM-SSC
100BASE-SX (proposed, 850nm)	mm <sup>1</sup>	150 m <sup>3</sup> (500 ft)	FPM-SXMST, -SXMSC - short wavelength
<b><u>Copper:</u></b>			
10BASE-T & 100BASE-TX twisted pair		100m (328 ft)	PM-RJ45, PM-RJ45U

<sup>1</sup> mm = multi-mode

<sup>2</sup> sgl.m = single-mode

<sup>3</sup> max. each for two segments in a 100Mb collision domain. Single segment is 412m for FX and 300m for SX.

### 3.3 Connecting Fiber Optic ST-type, “twist-lock”

The following procedure applies to installations using an PM with ST-type fiber connectors. This procedure applies to ports using an FPM-MST, FPM10-MST, FPM10-SST single-mode, FPM-SXMST, and to SPM-FDST.

1. Before connecting the fiber optic cable, remove the protective dust caps from the tips of the connectors on the FPM. Save these dust caps for future use.
2. Wipe clean the ends of the dual connectors with a soft cloth or lint-free lens tissue dampened in alcohol. Make certain the connectors are clean before connecting.

**Note:** *One strand of the duplex fiber optic cable is coded using color bands at regular intervals; you must use the color-coded strand on the associated ports at each end of the fiber optic segment.*

3. Connect the Transmit (TX) port (light colored post) on the Magnum FPM to the Receive (RX) port of the remote device. Begin with the color-coded strand of the cable for this first TX-to-RX connection.
4. Connect the Receive (RX) port (dark colored post on the PM) to the Transmit (TX) port of the remote device. Use the non-color coded fiber strand for this.
5. The LINK LED on the front of the PM will illuminate when a proper connection has been established at both ends (and when power is ON in the unit). If LINK is not lit after cable connection, the normal cause is improper cable polarity. Swap the fiber cables at the Port Module connector to remedy this situation.

### 3.4 Connecting Fiber Optic SC-type, "Snap-In"

The following procedure applies to installations using an PM with SC-type fiber connectors. This procedure applies to ports using an FPM-MSC, FPM-SSC single-mode, FPM10-MSC, FPM10-SSC, FPM-SXMSC, and to SPM-FDSC and -FDSSC single-mode.

When connecting fiber media to SC connectors, simply snap on the two square male connectors into the SC female jacks of the PM until it clicks and secures.

### 3.5 Connecting Single-Mode Fiber Optic

When using single-mode fiber cable, be sure to use single-mode fiber port connectors. Single-mode fiber cable has a smaller diameter than multi-mode fiber cable (9/125 microns for single-mode, 50/125 or 62.5/125 microns for multi-mode where xx/xx are the diameters of the core and the core plus the cladding respectively). Single-mode fiber allows full bandwidth at longer distances, and may be used to connect 10Mb nodes up to 10 Km apart, or 15Km with the SPM-FDSSC.

The same procedures as for multi-mode fiber applies to single-mode fiber connectors. Follow the steps listed in Section 3.3 and 3.4 above.

### 3.6 Connecting Twisted Pair (RJ-45,CAT3, CAT5, Unshielded or Shielded)

The RJ-45 ports of the Magnum 8000X Dual-Speed Hubs can be connected to the following two media types: 10BASE-TX and 10BASE-T. CAT 5 cables should be used when making 10BASE-TX connections. When the ports are used as 10BASE-T ports, CAT 3 may be used. In either case, the maximum distance for unshielded twisted pair cabling is 100 meters (328 ft).

<u>Media</u>	<u>IEEE Standard</u>	<u>Connector</u>
Twisted Pair (CAT 3, 4, 5)	10BASE-T	RJ-45
Twisted Pair (CAT 5)	10BASE-TX	RJ-45

**NOTE :** *It is recommended that high quality CAT. 5 cables (which work for both 10Mb and 100Mb) be used whenever possible in order to provide flexibility in a mixed-speed network, since dual-speed ports are auto-sensing for either 10 and 100Mb/s.*

The following procedure describes how to connect a 10BASE-T or 100BASE-TX twisted pair segment to the RJ-45 port. The procedure is the same for both unshielded and shielded twisted pair cables.

1. Using standard twisted pair media, insert either end of the cable with an RJ-45 plug into the RJ-45 connector of the port. Note that, even though the connector is shielded, either unshielded or shielded cables and wiring may be used.
2. Connect the other end of the cable to the corresponding device
3. Use the LINK LED to ensure proper connectivity by noting that the LED will be illuminated when the unit is powered and proper connection is established

4. For Port #1, if the LINK LED is not illuminated, change to port 1X. If this does not help, ensure that the cable is connected properly and that the device on the other end is powered on and is not defective.

### 3.6.1 100Mbps Collision Domain Diameter, Cable Distances and PDV

#### Calculations

The 100Mbps Collision Domain Diameter is the length of the longest path between any two devices in a single collision domain. A collision domain is defined as a cluster of network devices which are connected by means of a repeater or repeaters such that no bridging devices are present between any two devices in the cluster. In order to install an IEEE 802.3u compliant Fast Ethernet network, the collision domain . . . regardless of the actual network topology . . . must be less than 512 BT (Bit Times). Bit Times are related to media type as shown in Table 3.6.1a.

**Table 3.6.1a: Worst case round-trip delay for Fast Ethernet media\***

Media Type	Round-trip delay in Bit Time per Meter (BT/m)
Fiber Optic	1.000
Shielded TP cable	1.112
Category 5 Cable	1.112
Category 3, 4 Cable	1.140

\*Worst case delays taken from IEEE Std 802.3u-1995, actual delays may be less for a particular cable. Contact your cable supplier for exact cable specifications.

Each Fast Ethernet device component also has an associated BT delay which depends on the physical signaling system employed. Table 3.6.1b shows each Fast Ethernet device component and the associated BT delay. A “DTE” is an end node, such as a user station. Note that there is only one DTE pair associated with any device-to-device path.

**Table 3.6.1b: Worst case round-trip delay for Fast Ethernet device components\***

Component	Round-trip delay in Bit Times (BT)
2 TX DTEs	100
2 FX DTEs	100
1 FX and 1 TX DTE	100
1 T4 and 1 TX or FX DTE	127
Class I Repeater	140
Class II Repeater with any combination of TX and FX ports	92 **

**\*\*Note, the delay is only 80 Bit Times for the 8000X, front-port-to-front-port.**

\*Worst case delays taken from IEEE Std 802.3u -1995.

To determine whether a prospective network topology adheres to the collision domain diameter specification, the following formula should be applied to the worst case path through the network. The worst case path is the path between the two Fast Ethernet devices (DTEs) which have the longest round-trip time.

$$\text{PDV} = (\text{sum of cabling delays}) + (\text{sum of repeater delays}) + (\text{DTE pair delay}) + (\text{safety margin})$$

PDV is the Path Delay Value of the worst case path. For the network to adhere to IEEE standard, this value must be less than 512 BT. The safety margin is specified in BT and may be a value between 0 and 5. This margin can be used to accommodate unexpected delays such as extra long patch cable. A safety margin of about 2 to 4 BT is recommended.

A typical example of a PDV calculation is shown below, and is illustrated in Figure 3.6.1a. Here, an integrator wishes to cascade the 100Mbps collision domains of two Magnum 8000X Mixed-Media Hubs (each having a PDV of 80 BT) for use with standard 100m Category 5 user cable segments (i.e. from computer to hub) and needs to know how long the inter-repeater Category 5 cable segment, used to cascade the hubs, can be. The variable "X" represents the unknown maximum cascade cable delay.

$$\begin{aligned} \text{PDV} &= X + ((111 + 111) + (80 + 80) + (100) + 2) \text{ BT} < 512 \text{ BT} \\ 512 &> (X + 486) \text{ BT} \\ X &< (512 - 486) \text{ BT}, X < 28 \text{ BT} \\ \text{Twisted Pair cable length, TL} &< (28 \text{ BT}) / (1.112 \text{ m/BT}) \\ \text{TL} &< 25 \text{ meters} \\ \Rightarrow & \text{ 25 m maximum total length for Category 5 inter-repeater segment,} \end{aligned}$$

where 111 is the BT delay for 100m of Category 5 cable (1.112 BT/m\* 100m), 80 is the BT delay for each Magnum 8000X, 100 is the BT delay for the TX DTE pair, and a

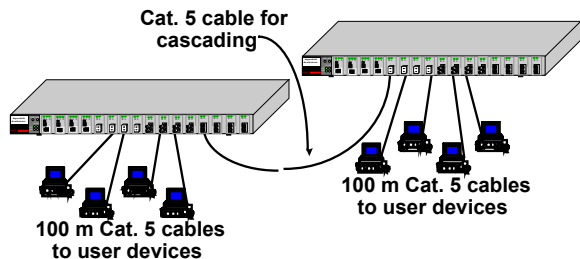

safety margin of 2 was used. **Figure 3.6.1a: Two cascaded Magnum 8000X hubs**



The resulting value tells us that a Category 5 cable with a length of up to 25 meters may be used to cascade the Magnum 8000Xs. Note that this inter-repeater cable length may be increased by shortening the lengths of the 100m hub-to-user cable segments.

It is also possible to cascade a group of up to nine Magnum 8000Xs (serving up to 56 users with full-length 100m cables to each) by using short inter-repeater cable segments. The following is an example of how to calculate the maximum allowable cascade cable segment length. An illustration of this example is shown in Figure 3.6.1b, where the hub-to-user cable lengths are up to 75 meters for Cat 5 twisted pair. The variable “X”, the maximum hub-to-hub cable delay, is calculated as follows:

$$\text{PDV} = X + ((100) + (80 + 80 + 80) + (83 + 83) + 2) \text{ BT} < 512 \text{ BT}$$

$$512 > (X + 508) \text{ BT}, \quad X < 4 \text{ BT}$$

$$\text{Twisted pair user cable length, TL} < (4 \text{ BT}) / (1.112 \text{ m/BT})$$

$$\text{TL} < 3.6 \text{ meters for two hub-to-hub cascading cables}$$

$$\Rightarrow 2 \text{ meters (6 ft.) length max. for each of the cascade segments,}$$

In the above example, 75 is the BT delay for 70m of Category 5 cable (1.112 BT/m), 80 is the bit time delay for each Magnum 8000X front-to-front ports, 100 is the BT delay for the TX DTE pair in the user stations, and 2 BT is the safety margin applied.

### Figure 3.6.1b: Multiple cascaded Magnum 8000X Mixed-Media hubs

Note that the cascading of multiple Magnum 8000X Mixed-Media hubs is a capability beyond what industry

standards normally permit, and is different from what competitive 100Mbps Class II hub products normally allow. This additional cascading level and cable length is due to the relatively shorter bit time (80 BT actually measured, for front-port-to-port) delay of the Magnum 8000X vs. the industry standard delay of 92 BT for Class II repeaters. The installation flexibility and network growth potential is accordingly better with Magnum 8000Xs than with hubs that merely meet the standard. Table 3.6.1c shows maximum cable lengths for common network configurations using industry standard repeater PDV numbers. Calculations such as above should be performed using measured PDV data supplied by the equipment manufacturer in important installations.

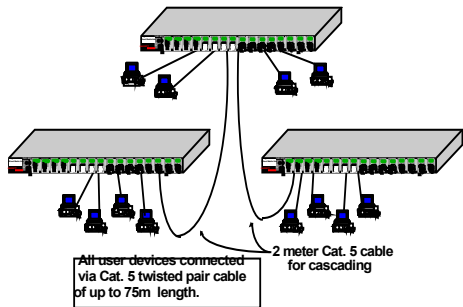

**Table 3.6.1c: Maximum segment lengths for common network configurations**

Number of Hubs	Repeater Hop Count	Max. User Segment Lengths (m)	Max. Inter-Repeater (Cascade) Length (m)	Notes
1	1	100.0	n.a.	All ports TX
2	2	100.0	5.0	All ports TX
2	2	92.0	20.0	All ports TX
3+	3	60.0	1.0	All ports TX

Instructions for connecting the Magnum 8000X Mixed-Media Hubs to the various Fast Ethernet media are given in the following sections.

### 3.6.2 Connections to NICs which support Auto-Negotiation

The Magnum 8000X Mixed-Media Hub will function properly with NICs (Network Interface Cards) which support Auto-Negotiation. The Magnum 8000X will establish link with any NIC which can send and receive the Fast Link Pulse (FLP) coding for the 100BASE-TX signaling system. When connecting a NIC to the 8000X, it may be necessary to reload the NIC drivers on the user device if the NIC has been communicating with a protocol other than 100BASE-TX (such as 10BASE-T). When 100Mb operation is agreed and in use, the 100Mb LINK/ACT LED is illuminated, steady ON if no traffic or blinking when there is traffic.

### 3.7 Table-Top or Shelf Mounting

The Magnum 8000X fiber Hub can be easily mounted on a table-top or any suitable horizontal surface, and has four rubber feet to provide stability without scratching finished surfaces.



### 3.8 Rack-Mounting

Installation of a Magnum 8000X mixed-media fiber Hub in a 19" rack is a simple procedure. The units are 1U (1.70") high. When properly installed, the front-mounted LED status indicators should be in plain view and easy to read. Rack-mount installation requires special 19" rack-mounted brackets and screws (included with each 8000X unit). The brackets attach to the front sides of the hub, which is then fastened into a standard 19" RETMA rack.

The 23" brackets and ETSI brackets are also available (optional) for Rack-mounting of Magnum 8000X Hubs. The 23" brackets are more popular in Telco industry where they are standard for Central Office rack-mounting purposes. The 23" brackets are mainly used for larger equipment assemblies in rack-mounting frames, and are frequently accessed in operation from both sides.

The ETSI (European Telephone standard) brackets are similar to the 19" brackets but use metric dimensions.

The optional 23" brackets and the ETSI brackets come as a pair in a package, along with the necessary screws for

attaching the brackets to the sides of the Magnum Switch unit.

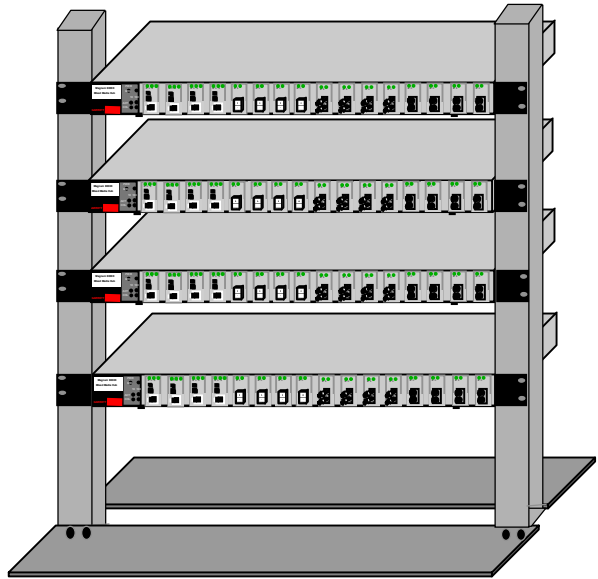

**Fig 3.8 Multiple Magnum 8000X units rack-mounted in a 23"**

**frame**

### 3.9 Port Module (PM) Installation

The Magnum 8000X is normally received from the factory with all required PM modules installed. There may be situations where PM cards need to be added or replaced. In cases where additional PM cards are needed, the face plate for an available front-mounted slot must be removed. The following procedure describes this operation.

#### 3.9.1 Preparation for Installing and Removing PMs

**STOP!!!**

**Be sure the power cord is unplugged from the chassis before attempting to remove and/or replace any PM cards. Failure to do so may result in damage to the unit and will void the warranty.**

**Caution- Avoid Static Discharge: The port modules (like most electronic equipment) are sensitive to static discharge. Use proper ESD measures when handling port modules.**

### Step 1. Remove Chassis Cover

To make the installation of port module easy, the top cover is made in two parts called “front-top” and “rear-top”. There are 6 screws located on front-top of the unit and two screws each on the left and right edges. Remove these screws. Once these are removed, the front-top cover is easily lifted off the chassis base.

When the front-top cover has been removed, the front-interior is exposed.

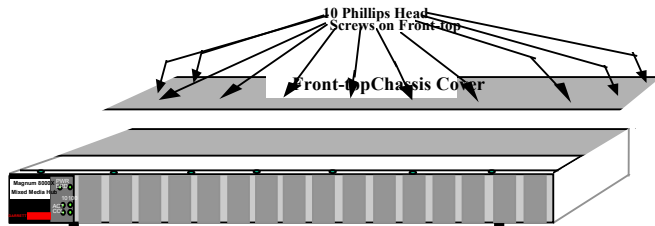

Figure 3.9.1a: Removing Chassis Cover

**Caution: Be careful not to disturb the power supply.**

Looking down into the Magnum 8000X unit, notice that there are individual PM connector sockets for each PM card position. There are 16 PM slots located on the front of the unit and a bonus slot for an SPM in the rear of the unit. A total of seventeen slots for seventeen Ethernet segment connections are available. The extreme left header-position in front is used by the LED Status module. (See Figure 3.9.1b).

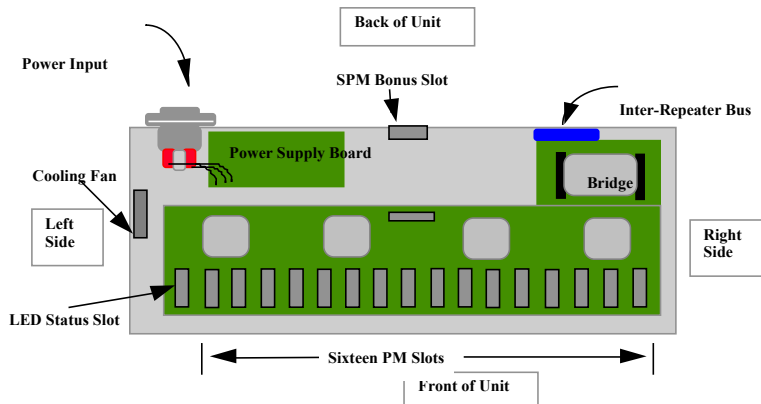
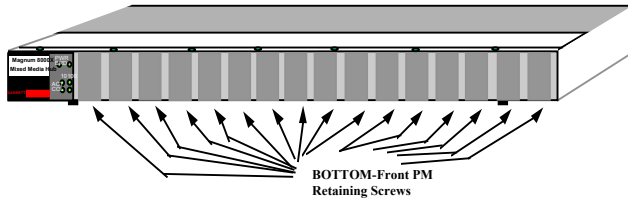

Figure 3.9.1b: Magnum 8000X, Top View with Chassis Cover

## Step 2. Remove bottom-front Retaining Screws in any PM or Face Plates

On the bottom-front of the unit, there is one retaining screw for each PM card slot. These screws are used to secure a PM face plate in position. These screws are also used to secure the individual PM cards, which can be subjected to significant forces from the attached cables. (See Figure 3.9.1c)



**Figure 3.9.1c: Front View - PM Retaining Screws hold Face Plates**

PM card installation is covered in Section 3.9.2. PM card removal is covered in Sect.3.9.3.

### 3.9.2 Installing PM Cards in the Magnum 8000X

Up to sixteen front-mounted PM cards may be installed in one Magnum 8000X Fiber Hub unit. Follow these steps to install a PM.

**Step 1.** Remove front-top chassis cover. See procedure in Section 3.9.1 above.

**Step 2.** The figure here illustrates the basic layout of an individual PM card. Each PM card fits into the selected PM connector socket

slot. Align the

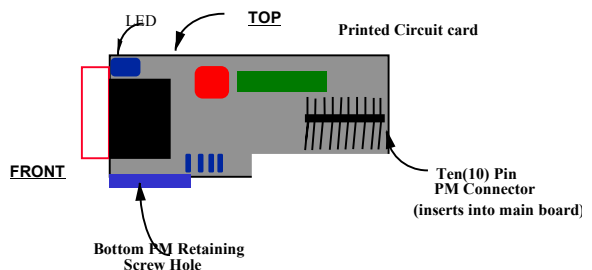

connector pins on the bottom of the PM card with the connector socket inside the unit. The pins are slightly angled to facilitate the installation. (Do NOT straighten the pins before insertion !!)

- Step 3.** Be sure the pins are precisely aligned with the holes in the header, and the PM front panel is guided into the front slot cut-out. Then, slowly and carefully apply enough pressure to insert the PM card's pins into position, see Figure 3.9.2b. (If you force the PM down when the pins are not properly aligned with the holes in the header, the pins will become bent and the PM is damaged).

Once inserted, the PM card will be secured by the header connector, the front panel port slot cut-out, and retaining screws.

**NOTE:** *If a PM is difficult to install, try it in another port slot. Some of the port modules may fit easily in one port slot and be very hard to install in another.*

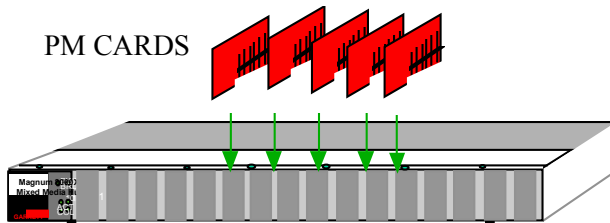

**Figure 3.9.2b: Inserting PM Cards into a Magnum 8000X**

**NOTE:** *All PM slots need not be filled in order for the Magnum 8000X unit to be operational. When leaving PM slots empty, always use a face plate (Magnum PM-FP) to cover the slot opening in the front panel. This will maintain proper cooling air flow, safety, and operation as required by FCC, CE, and other regulations.*

- Step 4.** Once all PM cards have been installed (including face plates for empty slots), the chassis cover should be replaced.

### 3.9.3 Removing PM Cards

To properly remove a PM card from the Fiber Hub, follow the 3 steps below.

- Step 1. Remove chassis cover** See procedure in Section 3.9.1 above.

**Caution: Be sure the power cord is unplugged.**

- Step 2. Remove bottom-front retaining screws for the PM and Face Plate**

On the bottom-front of the unit there is one retaining screws for each PM card and face plate slot. These screws are used to secure a PM card in position (see Figure 3.9.3a). Remove the front screws of the PM to be removed.

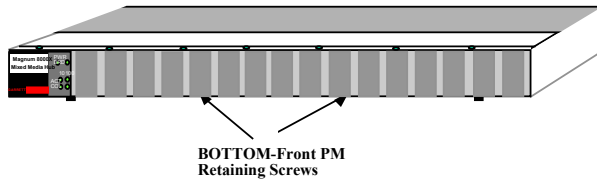

**Figure 3.9.3a: Front View - Face Plate & PM Retaining Screws**

### Step 3. Remove PM Card

Gently pull the PM card up and out of the connector socket (see Figure 3.9.3b).

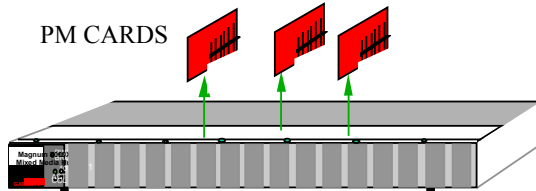

**Figure 3.9.3b: Removing a PM Card**

If the slot from which the PM card has been removed is to remain unused, be sure to install a PM face plate cover in it. If another PM card is replacing the one that has been removed, follow the steps as described for installing an PM card discussed in Section 3.9.1.

## 3.10 Preparation for Installing and Removing SPMs

### Step 1. Remove Chassis Top Cover

**Caution: Be sure the power cord is unplugged.**

The 8000X chassis is connected with 20 screws on the top cover. There are several screws located on top front and back of the unit, and four screws each on the top left and right sides. Remove these 20 screws from the top edges. Once these are removed, the top cover is easily lifted off the chassis base.

When the chassis top cover has been removed, the interior of the unit is exposed.

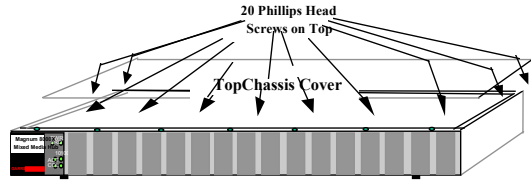
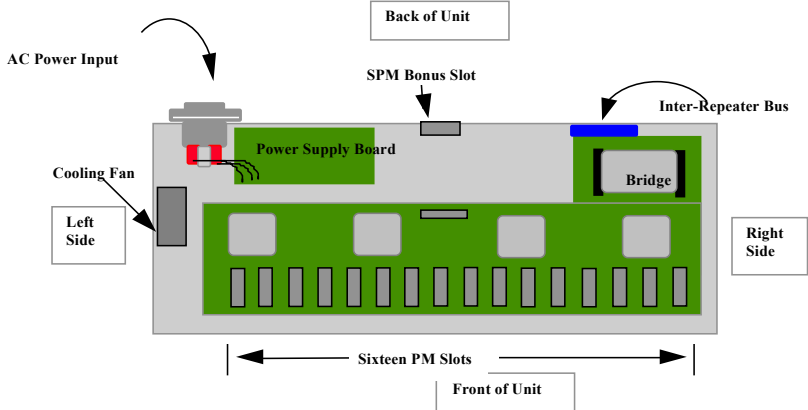

**Figure 3.10a: Removing Chassis Cover**

**Caution: Be sure the power cord is unplugged.**

**Caution: Be careful not to disturb the power supply.**

Looking down into the Magnum 8000X unit, notice that there is one SPM connector header located on the rear part of the main board. (See Figure 3.10b).



**Figure 3.10b: Magnum 8000X, Top View with Chassis Cover Off**

### Step 2. Remove Retaining Screws in Face Plates of SPM Bonus Port

On the rear side of the unit there are two retaining screws for Bonus Port slot. These screws are used to secure an SPM face plate in position. These screws are also used to secure the SPM modules, which can be subjected to significant forces from the attached cables. (See Figure 3.10c)

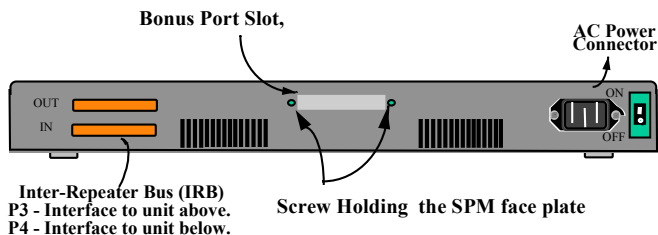

**Figure 3.10c: Rear View - SPM Retaining Screws in Face Plates**



SPM card installation is covered in Section 3.10.1, PM card removal in Sect3.10.2.

### 3.10.1 Installing an SPM Module in the Magnum 8000X

There is only one SPM module may be installed in the Magnum 8000X Fiber Hub unit. The SPM bonus port slot is accessible on the rear of the unit

Follow these steps to install an SPM.

**Step 1.** Remove top chassis cover. See procedure in Section 3.10a above.

**Step 2.** The figure 3.10.1a below illustrates the layout of an SPM module installed in a 8000X unit. The SPM module fits easily into the SPM header.

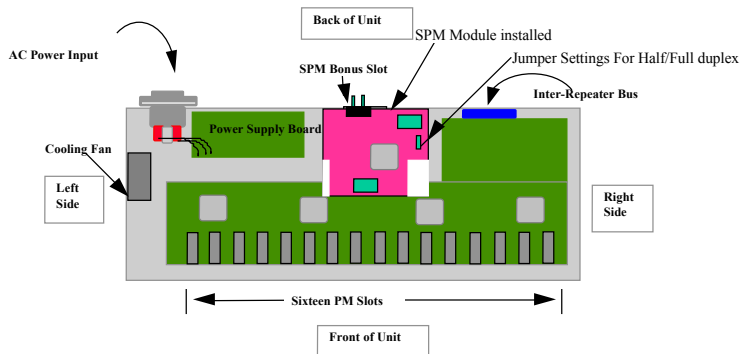

**Fig. 3.10.1a Top View : SPM Module Installed in a 8000X**

Align the 40-pin male header on the main board of the Magnum 8000X with the female sockets on the SPM module carefully. Any misalignment of the pins will prevent proper functioning of the SPM module.

**Step 3.** Slowly and firmly push the SPM into position. Once inserted, the SPM card is then secured by the header connector. Re-insert the retaining screws on the SPM module cooling cover plate to provide stability .

**NOTE:** The *SPM Bonus Port slot* need not be populated in order for the *Magnum 8000X* unit to be operational. When leaving SPM slots empty, always use a face plate (supplied and factory-installed in all non-SPM units) to cover the slot opening in the rear panel. This will maintain proper cooling air flow for safety, and operation as required by FCC, CE, and other regulations.

**Step 4.** Once SPM card has been installed, the user can adjust the jumper settings either to half or full duplex. The SPM module, by default, comes with half-duplex settings. Finally the chassis cover should be replaced and screwed down.

**Note:** *Do not use any other screws(except provided from the factor on the fan side. Non-standard screws may stop the fan from working, and the heat build-up may cause serious hazard to the unit.*

### 3.10.2 Removing an SPM Bonus Port Module

To properly remove an SPM module from the Magnum 8000X Stackable Concentrator follow the three steps below.

#### Step 1. Remove chassis cover

See procedure in Section 3.10 above.

**Caution:** Be sure the power cord is unplugged.

#### Step 2. Remove retaining screws for the SPM, face-plate only

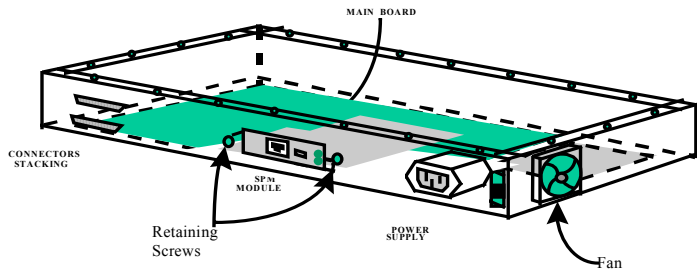

On the rear side of the hub there are two retaining screws for the Bonus Port slot. These are used to secure an SPM module in position. Remove them.

#### Step 3. Remove SPM Card

Keep the face-plate screws available. Gently pull the SPM card up and out of the connector header. If the bonus port from which the SPM card has been removed is to remain unused, be sure to install an SPM face plate cover in it. If another SPM card is replacing the one that has been removed, follow the steps as described for installing an SPM card discussed in Section 3.10 on the preceding pages.

### 3.11 Powering the Magnum 8000X

The Magnum 8000X incorporates an internal universal power supply, and has a male IEC connector for the AC power cord at the right-rear. A six foot 115vac power

cord is supplied with each unit. (Units shipped from the GCI factory to outside the United States and Canada will not include a 115 vac power cord.)

The Magnum 8000X supports installation environments where the AC voltage ranges from 90 - 260 volts with a power input frequency of between 47 - 63 Hz and will consume no more than a maximum of 30 watts. The power connector is located on the back of the unit. In order to power down the unit, simply unplug the unit's power cable. In a stacked configuration, this will NOT affect the operation of other units in the stack. When connecting various Ethernet media, there is no need to power down the 8000X unit. Individual segments of any media type can be connected or disconnected from PMs without concern for AC power -related problems or damage to the unit.

## 4.0 Operation

The operation of the Magnum 8000X is described in this section.

### 4.1 Repeater Functionality

The Magnum 8000X operates as a Mixed-Media Ethernet Hub to support multiple port segments within two (10 and 100Mbps) collision domains. The following describes the basic functionality of the Magnum 8000X Fiber Hub.

- 1. Repeater Functions:** Each front port operates in conjunction with the controller functions of the 8000X chassis as a fully compliant Ethernet repeater. The entire hub (or a stack of multiple units) counts as one Dual-Speed repeater.
- 2. Collisions:** When a collision is detected at a port other than the original receiving port, it generates a jam pattern to the other ports in that domain. When a collision signal is detected at a receiving port, it generates a jam pattern to the other ports. The sequence of jam signals depends on the sequence and location of collisions.
- 3. Partitioning and Re-connection:** An Magnum 8000X will automatically disconnect (partition) any segment (port) when 64 consecutive collisions occur or after 6.5 ms of continuous transmissions. Network integrity is checked every 800 ms and segment (port) reconnection occurs after a 512-bit packet is transmitted without error.
- 4. Link Status:** The Magnum 8000X PMs indicate link integrity for fiber optic and twisted pair segments. LINK is normally lit. Broken cables or a loss of power at any point in such segments will turn off the LINK LED.

### 4.2 Dual-Speed Functionality

The Magnum 8000X handles the two different traffic domains separately. The 8000X provides switched (bridged) connectivity between the Ethernet (10 Mbps) and Fast Ethernet (100Mbps) domains. It joins the two network domains for unified operation, and filters/ forwards packets in both directions to maximize bandwidth utilization and performance. Magnum 8000Xs are hardware plug-and-play devices. There is no software set-up to be done at installation or for maintenance. The functions of the Magnum 8000X are described in this manual.

Each time a packet is received on one domain of the bridge module, the decision is taken to either to filter or forward the packet. Errored packets are always filtered. For good packets, the filter and forward decisions are made based on the destination address contained in each packet. If the destination address is on the same domain from which the packet originated, then it is filtered and not forwarded to the other domain. If the destination address is not found to be a match in the address table for the originating domain, then it is forwarded to the other domain. If it is a new node address coming in which the switch did not previously know about, it “learns” the new address and puts it in the correct port address table. See “Address Learning” for more details. This diagram below shows the filter / forward logic for both domains.

### 1. Address Learning (Address Table Maintenance)

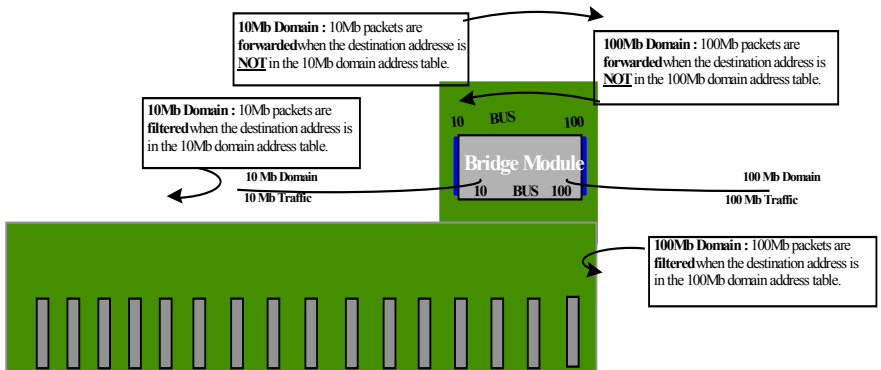

The Magnum 8000X bridge module is a state machine design which has a total address table capacity of 8K addresses. With a large address table, a Magnum 8000X can serve the needs of a medium-sized to large network. Table 4.2 shows what filter / forward action the Magnum 8000X will take in each packet-processing situation, and when a new node address will be added to the internal Address Table. When a new node-address packet comes into a port for the first time, then the new source address is “learned” at the same time that the packet is forwarded. After learning, subsequent packets from the same node address are routinely processed. The address tables are flushed periodically to update the network status and to purge any inactive stations from the tables of both domains.

**Figure 4.2 : Filtering vs. Forwarding in Dual Speed 8000X**

<u>Packet Source</u>	<u>Source Address</u>	<u>Destination Address</u>	<u>Address Table Maintenance</u>	<u>Filter/Forward Action</u>
10 Mbps	Not in table	Not in table	Add source to table	Forward
10 Mbps	Not in table	In table	Add source to table	Filter
10 Mbps	In table	Not in table	None	Forward
10 Mbps	In table	In table	None	Filter
100Mbps	Not in table	Not in table	Add source to table	Forward
100Mbps	Not in table	In table	Add source to table	Filter
100Mbps	In table	Not in table	None	Forward
100Mbps	In table	In table	None	Filter

**Table 4.2: 8000X Dual-Speed Hub Functionality**

### 2. Throughput Increase

By selectively forwarding packets from each domain to the other domain based on its switching (bridging) logic, the Magnum 8000X increases the available bandwidth for the users on both sides of the network. As shown in Figure 4.2, it keeps the local traffic on each side contained, preventing unnecessary packets and bad packets from traveling to the other domain and using up bandwidth needlessly over there. This

results in more available network bandwidth on both sides and a throughput increase on for all users on both domains.

### 3. Software Transparency

The Magnum 8000X Dual-Speed Hubs need no software set-up and are transparent to system and application software, including network management software.

#### 4.3 Auto-negotiation and speed-sensing

The PM-RJ45 and PM-RJ45U ports independently support auto-negotiation for shared 10BASE-T and 100BASE-TX modes. When the ‘S’ LED is flashing on a port, it means that the hub is sending out auto-negotiation pulses on that port. When a LINK connection is initially made, the other device should respond and both sides should agree on the speed capability being signaled. The device connected, depending on what it is, will either signal that it is capable of 10 Mbps or 100Mbps speeds. Silence means the port defaults to 10 Mbps.

When the ‘S’ LED is steady ON, the port has auto-negotiated for 100Mbps operation and is running at 100Mbps. When it is steady OFF, it is at 10 Mbps. If a 8000X copper port is connected to a non-negotiating device, it will default to 10 Mbps speed. Since Magnum 8000Xs are hubs, front ports always operate in half-duplex mode.

General information -

#### **Auto-negotiation per-port for dual-speed hubs occurs when:**

the devices at both ends of the cable are capable of operation at either 10Mb or 100Mb speed, and can send/receive auto-negotiation pulses, and . . .

-- when the second of the two connected devices is powered up\*, i.e., when LINK is established for a port, or

-- when LINK is re-established on a port after being lost temporarily.

**NOTE** – *some NIC cards only auto-negotiate when the computer system that they are in is powered up. These are exceptions to the “negotiate at LINK – enabled” rule, but may be occasionally encountered.*

#### 4.4 Chassis LEDs

The Magnum 8000X is equipped with six LEDs located on the front of the chassis unit (see Figure 2.3b). These LEDs are Power (PWR), Bridge(BRD), Collision (COL) and Activity (ACT) for 10 and 100Mbps speed. They are used to provide visual indication about the operational condition and traffic activity of the 8000X unit and its associated PM cards.

#### **Magnum 8000X chassis unit LEDs**

<u>LED</u>	<u>Description</u>
PWR	Illuminates GREEN to indicate that the unit is receiving power.
BR	GREEN, Steady ON, unit has bridge inside
COL	Flashes YELLOW to indicate a collision, one each for 10 and 100Mbps
ACT	Flashes for packet activity, one each for 10 and 100Mbps domains

#### 4.5 Power Budget Calculations for 8000X FPM's and Fiber Media

Receiver Sensitivity and Transmitter Power are the parameters necessary to compute the power budget. To calculate the power budget of different fiber media installations using Magnum products, the following equations should be used:

$$\text{OPB (Optical Power Budget)} = P_T(\text{min}) - P_R(\text{min})$$

where  $P_T$  = Transmitter Output Power, and  $P_R$  = Receiver Sensitivity

$$\text{Worst case OPB} = \text{OPB} - 1\text{dB (for LED aging)} - 1\text{dB (for insertion loss)}$$

$$\text{Worst case distance} = \{\text{Worst case OPB, in dB}\} / [\text{Cable Loss, in dB/Km}]$$

where the "Cable Loss" for 62.5/125 and 50/125 $\mu\text{m}$  (M.m) is 2.8 dB/km,

and the "Cable Loss" for 100/140 (Multi-mode) is 3.3 dB/km,

and the "Cable Loss" for 9/125 (Single-mode) is 0.5 dB/km

The following data has been collected from component manufacturer's (HP's and Siemens') web sites and catalogs to provide guidance to network designers and installers.

Fiber Port Module	Speed, Std.	Mode	Std. km fdx (hdx)	Wave - length nm	Cable Size $\mu\text{m}$	X'mitr Output $P_T$ , dB	R'cvr Sens. $P_R$ , dB	Worst OPB, dB	Worst* distance Km, fdx	typical OPB, dB	typical* distance Km, fdx
FPM10-MST, MSC	10 Mb FL	Multi-mode	2 (2)	850	62.5/125 100/140 50/125	-15.0 -9.5 -19.5	-31 -31 -31	14 19.5 9.5	5 5.9 3.4	17 23.5 13.5	6 7 4.8
FPM10-SST, SSC	10 Mb FL	Single-mode	10 (5)	1300	9/125	-30	-39	7	14	13	26
FPM-MST, MSC	100Mb FX	Multi-mode	2 (0.4)	1300	62.5/125 50/125	-20 -23.5	-31 -31	9.0 5.5	2.5 2.0	14 12	5 4
FPM-SSC	100Mb FX	Single-mode	18+ (0.4)	1300	9/125	-15	-31	14	28	17.5	35
FPM-MTRJ	100Mb FX	Multi-mode	2 (0.4)	1300	62.5/125 50/125	-20 -23.5	-31 -31	9.0 5.5	3.0 2.0	15.8 12.2	5.5 4.0
FPM-MV45	100Mb FX	Multi-mode	2 (0.4)	1300	62.5/125	-14	-31	15	5	16	5.7
FPM-SX MST, MSC	10/100 Mb SX	Multi-mode	0.3 (0.3)	850	62.5/125	-12	-15	1	0.3	1.5	0.5
SPM-FDST SPM-FDSC	100Mb FX	Multi-mode	2 (n.a.)	1300	62.5/125 50/125	-20 -23.5	-31 -31	9.0 5.5	2.5 2.0	14 12	5 4

\* **Note:** The use of either multi-mode or single-mode fiber to operate at 100Mbps speed over long distances (i.e., over approx. 400 meters) can be achieved **only** if the following factors are both applied:

- The 100Mb fiber segment must operate in full-duplex (FDX) mode, i.e. an SPM (or equal external unit such as 300ES-FDX) must be used, and
- The worst-case OPB of the fiber link must be greater than the fiber cable's passive Attenuation.

(Attenuation = Cable loss + LED aging loss + Insertion loss + safety factor)

## **5.0 Introduction - Magnum 8000X Port Modules**

This chapter describes each Port Module (PM), including appearance, functionality, and status displays.

### **5.1 Inspecting the Package and Product**

This section applies only to PMs shipped as separate items, i.e., PMs not factory installed in a Magnum 8000X PM slot or in bonus port slot.

Examine the shipping container for obvious damage prior to installing a PM; notify the carrier of any damage which you believe occurred during shipment or delivery. Inspect the contents of this package for any signs of damage and ensure that the items listed below are included.

This package should contain:

One or more PMs.

Remove the PM(s) from the shipping container. Be sure to keep the shipping container should you need to ship any of the PMs separately at a later date.

In the event there are items missing or damaged contact your supplier. If you need to return the unit, use the original shipping container if possible. Refer to Chapter 5 for specific return procedures.

### **5.2 Product Description**

An important feature of the Magnum 8000X Hub is the use of individual Port Modules (PMs) for flexible mixed-media connectivity to RJ-45 and fiber media. Since the Magnum 8000X's have dual-speed capability per-port, the front port slots are designed to support all standard Ethernet media types at 10 or 100Mps speed. Each PM provides one port for connecting one Ethernet segment with its individual connector type and media.

For a list and brief illustration of Port Module types, refer to Section 2.4. Each PM is individually described in the following sections.



### 5.2.1 FPM-MST, 100Mbps multi-mode FX-ST-type, “twist-lock” connector

The Magnum FPM-MST is a multi-mode 100Mbps fiber optic module equipped with a dual ST-type connector. It functions as a fiber optics transceiver to support 100BASE-FX network segments. When installed in an 8000X half-duplex hub, it supports fiber optic cable distances only up the IEEE-specified 100Mbps shared-collision-domain distance limits, i.e., typically 200 meters.

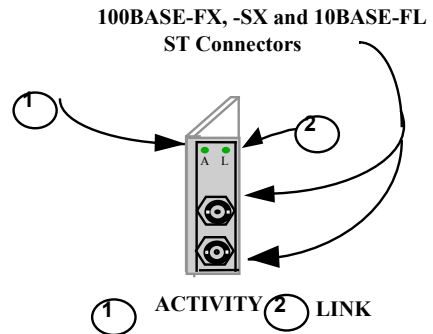

The module is equipped with an Activity (A) LED, and a Link (L) LED which indicates proper connectivity with the remote device when lit. Lettering on the front of the module identifies it as “100 FX” to avoid confusion with other similar-looking FPMs.

#### 5.2.1a FPM10-MST, 10 Mbps multi-mode FL-ST-type, “twist-lock” connector

The Magnum FPM10-MST is a multi-mode 10 Mbps fiber optic module equipped with a dual ST-type connector. It looks similar to the 100Mb FPM-MST, but has the lettering “10 Mb” on the front to distinguish it.

### 5.2.2 FPM-MSC 100Mbps multi-mode FX-SC-type, “snap-in” connector

The Magnum FPM-MSC is also a multi-mode 100Mbps fiber optic transceiver module, similar to the FPM-MST. It has the same LEDs indicating port activity (A), and Link (L) operational, and the same face-plate lettering.

While the functionality of these two modules is the same, the FPM-MSC is equipped with an SC-type “snap-in” connector instead of an ST-type.

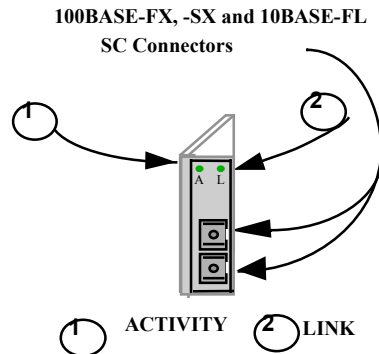

### 5.2.2a FPM10-MSC, 10 Mbps multi-mode FL-SC-type, “snap-in” connector

The Magnum FPM10-MSC is a multi-mode 10 Mbps fiber optic module equipped with a dual SC-type connector. It looks the same as the 100Mb FPM-MSC, but has lettering “10 Mb” on the front to distinguish it.

### 5.2.3 FPM-SSC 100Mbps single-mode FX-SC-type, “snap-in” connector

The Magnum FPM-SSC is a single-mode 100Mbps fiber optic module equipped with a dual SC-type connector. It functions as a full fiber optic transceiver to support single-mode fiber networks.

The FPM-SSC, when installed in a Magnum 8000X hub, supports fiber distances the same as 100Mbps multi-mode ports because of the 100Mbps collision domain limitations, so it is only practical for use where single-mode fiber cable is already installed and must be used.

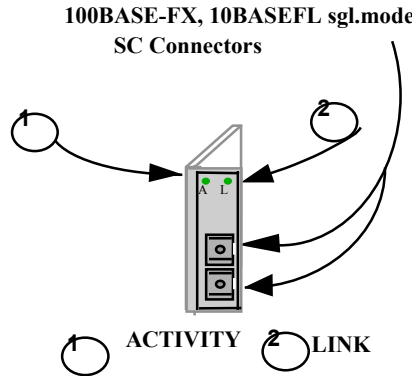

Note - to support long fiber distance with the Magnum 8000X, use either 10Mbps modules in front ports (which can go up to 2Km), or use a 100Mbps full-duplex SPM in the bonus port which has no collision domain limits.

The FPM-SSC is equipped with an Activity (A) LED, and LINK(L) LEDs identical to those of the FPM-MSC. To distinguish the single-mode FPM-SSC from the multi-mode FPM-MSC, the label “Sgl. M.” is at the top of the faceplate of the FPM-SSC.

### 5.2.3a FPM10-SSC, 10Mbps single-mode FL-SC-type, “snap-in” connector

The Magnum FPM10-SSC is a single-mode 10 Mbps fiber optic module equipped with a dual SC-type connector. It looks the same as the 100Mbps FPM-SSC, but has lettering “10 Mbps” on the front to distinguish it.

### 5.2.3b FPM10-SST, 10Mbps single-mode FL-ST-type, “twist-lock” connector

The Magnum FPM10-SST is a single-mode 10 Mbps fiber optic module equipped with a dual ST-type connector. To distinguish the single-mode FPM10-SST from the multi-mode FPM10-MST, the label “Sgl. M.” is at the top of the faceplate of the FPM10-SST.

### 5.2.4 FPM-MTRJ, 100Mb multi-mode FX, MTRJ small-form-factor connector

Magnum FPM-MTRJ is a multi-mode fiber optic module equipped with a small-form-factor MTRJ-type connector. It looks almost like an RJ-45 port, but it is black in color. The MT-RJ’s small size and ease of connection make it a good choice for 100Mbps “fiber-to-the-desktop” Ethernet connectivity. When installed in an 8000X half-duplex hub, it supports fiber optic cable distances only up the 100Mbps shared-collision-domain distance limits, i.e., typically 200 meters.

The functionality of this 100BASE-FX multi-mode FPM is same as the ST and SC-types, and it is equipped with the same ACTIVITY (A) and LINK (L) LEDs to indicate proper connectivity with the remote device. It has the same “100Mb FX” lettering on the faceplate. Note that the other end of the fiber cable may have a different connector, not necessarily an MT-RJ type.

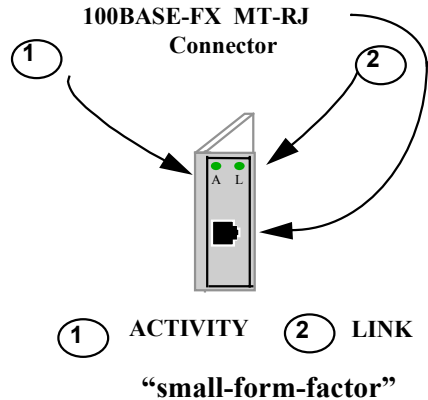

### 5.2.5 FPM-MV45, 100Mbps multi-mode FX, VF-45 small-form-factor connector

Magnum FPM-MV45 is a multi-mode fiber FX “small-form-factor” VF-45 connector used primarily in 100Mbps fiber-to-the-desktop links. Its size is similar to the MT-RJ port, but the VF-45 shell is slightly larger. When not in use, its appearance is distinctive because it has a tiny hinged door over the port hole to act as a dust cover.

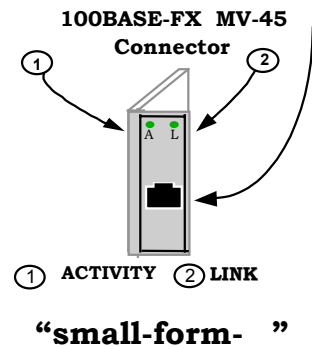

When installed in a Magnum 8000X half-duplex hub, it supports fiber optic cable distances only up to the 100Mbps shared-collision-domain distance limits, i.e., typically 200 meters.

The small size, about the same as an RJ-45, reduces the size of wiring panels in wiring closets while providing the advantage of “future-proof” fiber optic technology.

The cable port is a “plug-in” connector, with both fiber strands terminated in one housing that cannot be improperly inserted. The module is equipped with a LINK (L) LED to indicate proper connectivity with the remote device, and an ACTIVITY (A) LED that flashes to show when Fast Ethernet packets are being received.

### 5.2.6 FPM-SXMST and SXMSC (100BASE-SX) when available !!

The FPM-SXMST port module, better known as “short wavelength Fast Ethernet,” looks essentially identical to other ST and SC connectors. The FPM-SXMST based on 870 nm wavelength comes in multi-mode only, and may eventually become a cheaper solution for Fast Ethernet fiber-to-desk-top segments.

FPM-SXMST supports fiber transmission connectivity up to 300m distance is suitable for the users requiring higher bandwidth in their LANs.

However, the connection of fiber cable to the FPM-SXMST is the same as other ST-type “Twist-lock” connectors. The module is equipped with Activity(A) and Link(L) LEDs to indicate proper connectivity with the remote device.

As an additional indicator, a multi-mode SX port emits light (red in color) that is in the visible spectrum and which can be seen by looking into the port with the power on

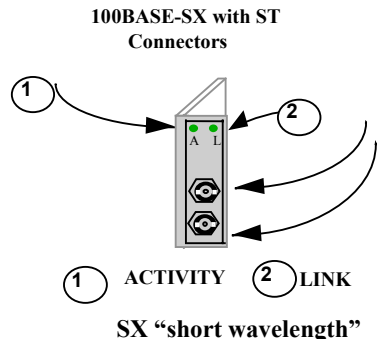

**SX “short wavelength”**

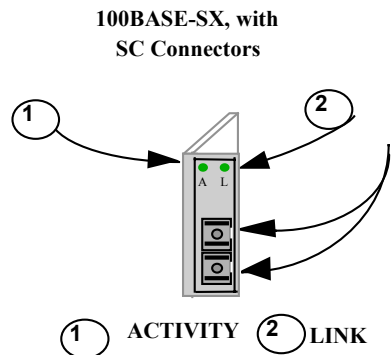

and with no cable connected. The FX port emits light outside of the visible spectrum and will always look dark to the human eye.

### 5.2.7 PM-RJ45 and RJ45U (Twisted Pair)

The PM-RJ45 card supports Ethernet twisted pair segments of any standard length. It is equipped with a single RJ-45 connector and an Auto/100 switch. The RJ-45 connector is shielded to minimize emissions and will allow both unshielded twisted pair (UTP) and shielded twisted pair (STP) cable connections. The Auto/100 switch is provided for user selection between operation in the auto-negotiation mode (Auto) or fixed-at-100Mb (100) with no auto-negotiation and no 10 Mbps.

The PM-RJ45U module is equipped with a Media Dependent Interface-Crossover (MDI-X) push switch to allow for cascaded connections. This feature eliminates the need for a special twisted pair crossover cable.

With the switch in the IN position, the PM-TP port is used for cascaded and up-link connections (i.e.: a connection to another repeater or hub or concentrator typically.) When used for segments going to workstations and other user device connections, the MDI-X switch should be in the OUT position.

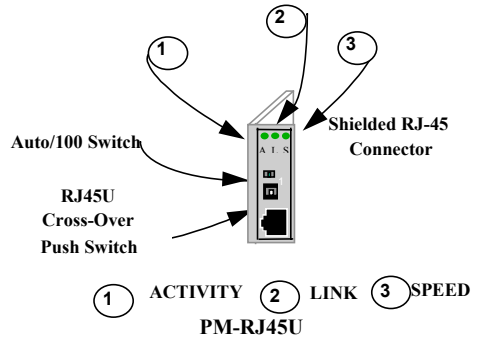

The PM-RJ45 will support 10BASE-T unshielded twisted pair wiring (UTP) environments with maximum segment distances up to 100m (325 ft.), or shielded twisted pair wiring (STP) of 150m (500 ft.). This module is designed with internal transceiver functionality. The PM-RJ45 has ACTIVITY, LINK and SPEED LEDs.

**Important Note:** For the PM-RJ45U Crossover Switch - OUT for workstations and user connections. IN for Up-Link connections to other hubs, etc.

The RJ-45 pins normally (TP crossover switch DOWN) are per the standard for hubs-to-users twisted pair wiring: 1 = receive+, 2 = receive-, 3 = transmit+, 6 = transmit-, other pins not used. When the TP crossover switch is UP, the pins of the RJ-45 port are per the standard for up-links using twisted pair wiring, i.e., the transmit and the receive pairs are exchanged: 1 = transmit+, 2 = transmit-, 3 = receive+, 6 = receive-, other pins not used.

### 5.2.8 PM-FP

The PM-FP is a blank face plate that must be installed in any empty PM slot. When the Magnum 8000X chassis contains less than twelve front-mounted PMs, the

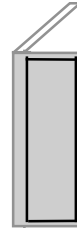

**Note:** The PM-FP must be installed in each empty PM slot.

empty front slots must be covered with the PM-FP face plate **PM-FP** in order to maintain proper cooling air flow, and for safety, etc.

## 6.0 TROUBLESHOOTING

All Magnum Ethernet products are designed to provide reliability and consistently high performance in all network environments. The installation of Magnum 8000X Mixed-Media Fiber Hub is a straightforward procedure (see INSTALLATION, Section 2.6); the operation is also straightforward and is discussed in Section 4.

Should problems develop during installation or operation, this section is intended to help locate, identify and correct these types of problems. Please follow the suggestions listed below prior to contacting your supplier. However, if you are unsure of the procedures described in this section or if the Magnum 8000X Mixed-Media Fiber Hub is not performing as expected, do not attempt to repair the unit; instead contact your supplier for assistance or contact GarrettCom Customer Support.

### 6.1 Before Calling for Assistance

1. If difficulty is encountered when installing or operating the unit, refer back to the Installation Section of the applicable chapter of this manual. Also check to make sure that the various components of the network are interoperable.
2. Check the cables and connectors to ensure that they have been properly connected and the cables/wires have not been crimped or in some way impaired during installation. (About 90% of network downtime can be attributed to wiring and connector problems.)
3. Make sure that an AC power cord is properly attached to each Magnum 8000X Mixed-Media Fiber Hub unit. Be certain that each AC power cord is plugged into a functioning electrical outlet. Use the PWR LEDs to verify each unit is receiving power.
4. If the problem is isolated to a network device other than the Magnum 8000X Mixed-Media Fiber Hub product, it is recommended that the problem device is replaced with a known good device. Verify whether or not the problem is corrected. If not, go to Step 5 below. If the problem is corrected, the Magnum 8000X Mixed-Media Fiber Hub and its associated cables are functioning properly.
5. If the problem continues after completing Step 4 above, contact your supplier of the Magnum 8000X Mixed-Media Fiber Hub unit or if unknown, contact GarrettCom, Inc. by fax, phone or email ([support@garrettcom.com](mailto:support@garrettcom.com)) for assistance.

## 6.2 When Calling for Assistance

Please be prepared to provide the following information.

1. A complete description of the problem, including the following points:
  - a. The nature and duration of the problem;
  - b. Situations when the problem occurs;
  - c. The components involved in the problem;
  - d. Any particular application that, when used, appears to create the problem;
2. An accurate list of GarrettCom product model(s) involved, with serial number(s). Include the date(s) that you purchased the products from your supplier.
3. It is useful to include other network equipment models and related hardware, including personal computers, workstations, terminals and printers; plus, the various network media types being used.
4. A record of changes that have been made to your network configuration prior to the occurrence of the problem. Any changes to system administration procedures should all be noted in this record.

## 6.3 Return Material Authorization (RMA) Procedure

All returns for repair must be accompanied by a Return Material Authorization (RMA) number. To obtain an RMA number, call GarrettCom Customer Service at (510) 438-9071 during business hours in California or email to [support@garrettcom.com](mailto:support@garrettcom.com)). When calling, please have the following information readily available:

Name and phone number of your contact person.

Name of your company / institution

Your shipping address

Product name

Serial Number (or Invoice Number)

Packing List Number (or Sales Order Number)

Date of installation

Failure symptoms, including a full description of the problem.



GarrettCom will carefully test and evaluate all returned products, will repair products that are under warranty at no charge, and will return the warranty-repaired units to the sender with shipping charges prepaid (see Warranty Information, Appendix A, for complete details). However, if the problem or condition causing the return cannot be duplicated by GarrettCom, the unit will be returned as:

**No Problem Found.**

GarrettCom reserves the right to charge for the testing of non-defective units under warranty. Testing and repair of product that is not under warranty will result in a customer (user) charge.

#### **6.4 Shipping and Packaging Information**

Should you need to ship the unit back to GarrettCom, please follow these instructions:

1. Package the unit carefully. It is recommended that you use the original container if available. Units should be wrapped in a "bubble-wrap" plastic sheet or bag for shipping protection. ( You may retain all connectors and this Installation Guide.)

**CAUTION: Do not pack the unit in Styrofoam "popcorn" type packing material. This material may cause electro-static shock damage to the unit.**

2. Clearly mark the Return Material Authorization (RMA) number on the outside of the shipping container.
3. GarrettCom is not responsible for your return shipping charges.
4. Ship the package to:

**GarrettCom, Inc.**

**213 Hammond Ave.**

**Fremont, CA 94539**

**Attn.: Customer Service**

### **APPENDIX A: WARRANTY INFORMATION**

GarrettCom, Inc. warrants its products to be free from defects in materials and workmanship for a period of three (3) years from the date of shipment by GarrettCom.

During this warranty period, GarrettCom will repair or, at its option, replace components in the products that prove to be defective at no charge other than shipping and handling, provided that the product is returned pre-paid to GarrettCom.

This warranty will not be effective if, in the opinion of GarrettCom, the product has been damaged by misuse, misapplication, or as a result of service or modification other than by GarrettCom.

GarrettCom reserves the right to make a charge for handling and inspecting any product returned for warranty repair which turns out not to be faulty.

Please complete the warranty card as this acts as a product registration, and mail it to GarrettCom within two weeks of your purchase.

## APPENDIX B : Internal DC Power Supply Option

### B1.0 SPECIFICATIONS - FOR MAGNUM MIXED -MEDIA 8000X HUBS

#### Power Supply (Internal -48 VDC Option)

DC Power Connector: 3 terminals: “-“, “GND”, “+”

Input Voltage: 36 - 70 VDC

Power Consumption: Model 8000X: 30 watt typical, 50 watts max.

#### Power Supply (Internal 24 VDC Option)

DC Power Connector: 3 terminals: “-“, “GND”, “+”

Input Voltage: 20-36 VDC

Power Consumption: Model 8000X: 30 watt typical, 50 watts max.

#### Power Supply (Internal 125 VDC Option)

DC Power Connector: 3 terminals: “-“, “GND”, “+”

Input Voltage: 120 - 160 VDC

Power Consumption: Model 8000X: 30 watt typical, 50 watts max.

**With the exception of the power supply, all specifications and functions of Magnum 8000X-48VDC models are identical to those listed in the main manual.**

### B2.0 -48VDC, 24VDC & 125VDC POWER OPTION, THEORY OF OPERATION

The -48VDC, 24VDC & 125VDC power options are designed using diodes inside on each DC power input line behind the two external power connection terminals, so that the power from an external source can only flow into the unit. This allows the 8000X to operate only whenever DC power is

correctly applied to the two inputs. It protects the 8000X from incorrect DC input connections. An incorrect polarity connection, for example, will neither affect the 8000X, its internal power supply, nor will it blow the fuse in the internal power supply.

The manual power “On-Off” Switch (optional) is used for powering the unit on and off when it is placed into or taken out of service.

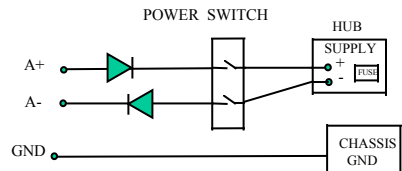

### B3.0 APPLICATIONS FOR DC POWERED ETHERNET HUBS

Magnum 8000X's are easily installed in a variety of applications where -48VDC, 24VDC & 125VDC power is used as the primary power source. The -48VDC, 24VDC & 125VDC power configuration provides an Ethernet networking solution utilizing a special power supply in hubs with a proven track record.

The -48VDC solution is particularly useful in the telecommunication industry, where it is common for facilities to operate on -48VDC power. Such companies include regular and wireless telephone service providers, Internet Service Providers (ISPs) and other communication companies. In addition, many high

availability equipment services, such as broadcasters, publishers, newspaper operations, brokerage firms and other facilities often use a battery backup system to maintain operations in the event of a power failure. It is also frequently used for computer system backup, management and operations monitoring equipment.

The 24VDC & 125VDC solution are particularly useful in the Industrial environment, where it is common for facilities to operate on 24VDC or 125VDC power. The 125VDC solution is mainly used in power utilities, such as electrical substations, electrical generating plants, etc. The 24VDC applications are mainly in the Industrial environment, such as factory floor, HVAC equipment, military equipment, etc.

## B4.0 INSTALLATION

This section describes the installation of the -48 VDC, 24VDC & 125VDC power source leads to the -48 VDC, 24VDC & 125VDC power terminal block on the Magnum 8000X. (see figure at the right).

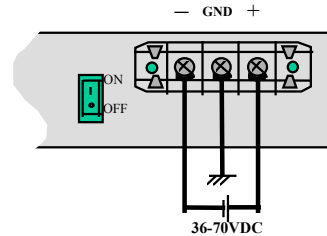

**Figure B4.1: -48VDC Terminal Block on Magnum 8000X -48VDC**

In this picture, the -48VDC terminal block on the Magnum 8000X is located on the rear of the unit and is equipped with three (3) screw-down lead posts. It is similar for 24VDC and 125VDC options on the 8000X. The leads are identified as negative (-), positive (+), and chassis ground (GND).

The actual connection procedure is very straightforward. Simply connect the leads to the Magnum unit, beginning with ground. Ensure that each lead is securely tightened.

**Note:** *The GND should be hooked up first. The 8000X unit has a floating ground, so the user may elect to Ground either + or = terminal to suit the customer's use.*

**Before connecting hot lines to the Terminal Block of -48VDC, 24VDC or 125VDC, always use a digital voltmeter to measure the output voltage of the power supply and determine the lead which is more “+ve potential”. The more “+ve” voltage lead from 48V or -48V supply must be connected to the post labeled “+”.**

An ON-OFF manual switch is optional for DC power. This can be used to cut off power connections, and as a RESET for the Hub.

## B4.1 UL Requirements

1. *Minimum 14 AWG cable for connection to a Centralized DC power source.*
2. *Fastening torque of the lugs on the terminal block: 9 inch pound max.*
3. *Centralized DC Power Source cable securement, use at least four cable ties to secure the cable to the rack at least 4 inches apart with the first one located within 6 inches of the terminal block.*

**B5.0 OPERATION**

Operation of the Magnum 8000X with the optional -48VDC, 24VDC & 125VDC power supply is identical to that of the AC-powered models.

**B6.0 ORDERING INFORMATION**

To order the optional -48VDC power supply factory installed, add a suffix of “-48VDC” after the product’s standard model # Example: **Magnum 8000X-48VDC**.

Similarly, to order the optional 24VDC or 125VDC industrial specific power supply factory installed, add a suffix of “-24VDC or “-125VDC” after the product’s standard model #. Example: **Magnum 8000X-24VDC or Magnum 8000X-125VDC**.

**B7.0 TROUBLESHOOTING** Please refer to Section 6.0**APPENDIX C: Internal DC Dual-Source Power Option****C1.0 SPECIFICATIONS - FOR 8000X MIXED-MEDIA FIBER HUBS****Power Supply (Internal, -48VDC Dual-Source, model # Dual-Src48V)**

DC Power Connector: First Source: “A+”, “A-“, 2nd Source “B-“, “B+”

GND: Terminal for “earth” or ground wire connection to the hub chassis

Input: Two separate sources, each at 36 - 70 VDC

Power Consumption: Model 8000X: 30 watt typical, 50 watts max.

**Power Supply (Internal, 24VDC Dual-Source, model # Dual-Src24V)**

DC Power Connector: First Source: “A+”, “A-“, 2nd Source “B-“, “B+”

GND: Terminal for “earth” or ground wire connection to the hub chassis

Input: Two separate sources, each at 20 - 36 VDC

Power Consumption: Model 8000X: 30 watt typical, 50 watts max.

**Power Supply (Internal, 125VDC Dual-Source, model # Dual-Src125V)**

DC Power Connector: First Source: “A+”, “A-“, 2nd Source “B-“, “B+”

GND: Terminal for “earth” or ground wire connection to the hub chassis

Input: Two separate sources, each at 120 - 160 VDC

Power Consumption: Model 8000X: 30 watt typical, 50 watts max.

With the exception of the dual DC input power connections and the power supply, all specifications and configuration options for the Magnum 8000X-48VDC, 8000X-24VDC & 8000X-125VDC with this Dual-Source option are identical to those listed in the *Magnum 8000X Fiber Hubs Installation and User Guide*, including Appendix B “Internal DC Power Supply Option”

**C2.0 MAGNUM 8000X , with -48VDC, 24VDC & 125VDC Dual-Source option**

The hub models with the internal -48VDC, 24VDC & 125VDC Dual-Source power supply are designed for installations where a battery plant is the power source, and where two separate power sources are utilized in order to increase operational uptime and to simplify maintenance.

The functionality of the Magnum 8000X-48VDC, 24VDC or 125VDC Dual-Source Option hubs are identical to the standard AC-powered models. All Port Module, SNMP and stacking options are available for configuration with Dual-Source Option units. Refer to the main sections of this *Installation and User Guide* for a detailed description of the Magnum 8000X Hubs.

### C3.0 DUAL-SOURCE OPTION, THEORY OF OPERATION

The Dual-Source DC power option is designed using diodes inside of the hub on each DC power input line. A diode is placed in each of the four input lines (behind the four external power connection terminals) so that power from an external source can only flow into the hub. This allows the hub to operate whenever DC power is correctly applied to either or both of the two inputs.

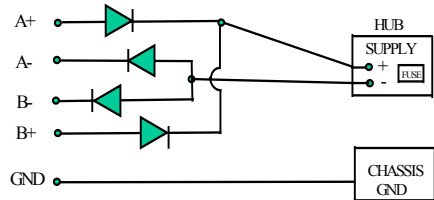

### C4.0 FEATURES AND BENEFITS OF THE DUAL-SOURCE DESIGN

- The hub can receive power from either input, “A” or “B”. The hub will normally draw its power from the DC source with the highest voltage at a given time.
- The hub will not allow power to flow from a higher voltage input to a lower voltage input, i.e. the two DC power sources are not mixed together by the hub.
- When one correct DC input is present, the hub will receive power if the other DC input is absent, or even if it is connected with reverse polarity or shorted or grounded.
- Reverse polarity connections, if they should accidentally occur on either input, will not damage the hub or power supply internally (nor will it blow the fuse in the internal power supply) because of the blocking action of the diodes. This is true even if one input connection is reversed while the hub is operating from the other source.
- The hub will not receive power (and will not work) when both inputs are simultaneously absent or are both incorrectly connected.

### C5.0 INSTALLATION

This section describes the proper connection of the -48VDC, 24VDC & 125VDC dual source leads to the -48VDC, 24VDC & 125VDC power terminal block on the Magnum 8000X hub (shown in Figure C4.0).

The -48VDC terminal block on the Magnum 8000X is located on the right rear of the unit and is equipped with five (5) screw-down lead posts (see Figure C5.0). The primary terminals are identified as positive (A+), negative (A-), and the secondary power terminals as negative (B-), positive (B+). The chassis “earth” or ground (GND), is a threaded post with a #6 nut. The dual source terminal block for 24VDC and 125VDC are similar.

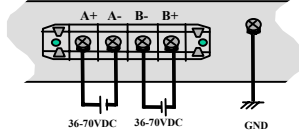

**Figure C5.0: -48V DC Dual-Source, wiring connections to the External Terminal Block on a Magnum 8000X 48VDC with Dual-Source option**

*Note: The GND should be hooked up first. The 8000X unit has a floating ground, so the user may elect to Ground either + or = terminal to suit the customer's use.*

*Before connecting to Terminal Block of -48VDC, 24VDC or 125VDC, always use a digital voltmeter to measure the output voltage of the power supply and determine the lead which is more "+ve potential". The more "+ve" voltage lead from 48V or -48V supply must be connected to the post labeled "+".*

The connection procedure is straightforward. Simply connect the DC leads to the hub's power terminals, positive (+) and negative (-) screws. The use of Ground (GND) is optional; it connects to the hub chassis. Ensure that each lead is securely tightened.

The 24VDC & 125VDC terminal block on Magnum 8000X is similar to that described in the -48VDC info above.

### C5.1 UL Requirements

The following must be adhered to in order to conform to UL requirements:

1. *Minimum 14 AWG cable for connection to a Centralized DC power source.*
2. *Fastening torque of the lugs on the terminal block: 9 inch pound max.*
3. *Centralized DC Power Source cable securement, use at least four cable ties to secure the cable to the rack at least 4 inches apart with the first one located within 6 inches of the terminal block.*

### C6.0 ORDERING INFORMATION

To order the optional Dual-Source -48VDC power supply factory installed, order "Dual-Src-48V" as a separate line item following the product model.

Example: **Magnum 8000X-48VDC**

**Dual-Src48V** for regular model with no ON-OFF switch  
or **Dual-Src48V-SWITCH** for model with ON-OFF switch

Similarly to order "Dual-Src 24V" or "Dual-Src 125V" as a separate line item following the product model.

Example: **Magnum 8000X-24VDC or Magnum 8000X-125VDC**

**Dual-Src48V** for regular model with no ON-OFF switch  
or **Dual-Src48V-SWITCH** for model with ON-OFF switch

**C7.0 OPERATION**

Operation of the Dual-Source Magnum 8000X-48VDC, 24VDC & 125VDC hub models are identical to that of the standard models. Please refer to the applicable sections of the “Installation and User Guide” for more information on the basic hubs.

## Free Manuals Download Website

<http://myh66.com>

<http://usermanuals.us>

<http://www.somanuals.com>

<http://www.4manuals.cc>

<http://www.manual-lib.com>

<http://www.404manual.com>

<http://www.luxmanual.com>

<http://aubethermostatmanual.com>

Golf course search by state

<http://golfingnear.com>

Email search by domain

<http://emailbydomain.com>

Auto manuals search

<http://auto.somanuals.com>

TV manuals search

<http://tv.somanuals.com>