

# **MAGNUM 6K FAMILY OF SWITCHES**

---

Managed Network Software (MNS) for Magnum 6K family of Switches  
– MNS-6K



Release 3.7.1

## **CLI User Guide**

# Preface

---

This guide describes how to use the Command Line Interface (CLI) for the Magnum 6K family of switches. For the Web Management Interface please refer to the Web Management Guide.

Some simple guidelines which will be useful for configuring and using the Magnum 6K family of switches -

- If you need information on a specific command in the CLI, type the command name after you type the word “help” (help <command> ) or just type <command> [Enter].
- If you need information on a specific feature in Web Management Interface, use the online help provided in the interface.
- If you need further information or data sheets on GarrettCom Magnum 6K family of switches, refer to the GarrettCom web links at:

[http://www.garrettcom.com/managed\\_switches.htm](http://www.garrettcom.com/managed_switches.htm) (except MP62 switch shown on the page)

GarrettCom Inc.  
47823 Westinghouse Drive  
Fremont, CA 94539-7437  
Phone (510) 438-9071 • Fax (510) 438-9072  
Email – Tech support – [support@garrettcom.com](mailto:support@garrettcom.com)  
Email – Sales – [sales@garrettcom.com](mailto:sales@garrettcom.com)  
WWW – <http://www.garrettcom.com/>

# Trademarks

---

GarrettCom Inc. reserves the right to change specifications, performance characteristics and/or model offerings without notice. GarrettCom, Magnum, S-Ring, Link-Loss-Learn, Converter Switch, Convenient Switch and Personal Switch are trademarks and Personal Hub is a registered trademark of GarrettCom, Inc.

NEBS is a registered trademark of Telcordia Technologies.

UL is a registered trademark of Underwriters Laboratories.

Ethernet is a trademark of Xerox Corporation.

Copyright © 2007 GarrettCom, Inc. All rights reserved. No part of this publication may be reproduced without prior written permission from GarrettCom, Inc.

Printed in the United States of America.

**Part #: 84-00131**

PK-040207

# Table of Contents

|  |    |
|--|----|
| <b>1 – Conventions Followed</b> .....          | 18 |
| Flow of the User Guide .....                   | 19 |
| <b>2 – Getting Started</b> .....               | 22 |
| Before starting .....                          | 22 |
| MNS-6K Software Updates .....                  | 23 |
| Console connection .....                       | 23 |
| Console setup.....                             | 24 |
| Console screen.....                            | 24 |
| Logging in for the first time .....            | 25 |
| Setting the IP parameters.....                 | 25 |
| Privilege levels.....                          | 28 |
| Operator Privileges.....                       | 28 |
| Manager Privileges.....                        | 28 |
| User management.....                           | 28 |
| Add User.....                                  | 29 |
| Delete User.....                               | 29 |
| Modify Password .....                          | 29 |
| Modify the Privilege Level .....               | 29 |
| Modify Access Privileges for a user .....      | 30 |
| Help.....                                      | 31 |
| Displaying Help for an Individual Command..... | 31 |
| Viewing options for a command.....             | 31 |
| Context help .....                             | 32 |
| Exiting.....                                   | 33 |

|   |           |
|---|-----------|
| List of commands in this chapter .....            | 33        |
| <b>3 – IP Address and System Information.....</b> | <b>35</b> |
| IP Addressing.....                                | 35        |
| Importance of an IP address .....                 | 35        |
| DHCP and bootp .....                              | 36        |
| Bootp Database .....                              | 36        |
| Configuring Auto/DHCP/Bootp/Manual .....          | 37        |
| Using Telnet.....                                 | 38        |
| Setting serial port parameters .....              | 40        |
| System parameters.....                            | 41        |
| Date and time.....                                | 43        |
| Network time .....                                | 44        |
| Saving and loading configuration .....            | 45        |
| Config files.....                                 | 48        |
| Displaying configuration.....                     | 50        |
| Erasing configuration .....                       | 53        |
| Displaying Serial Number.....                     | 54        |
| List of commands in this chapter .....            | 55        |
| Other commands .....                              | 57        |
| <b>4 – IPv6 .....</b>                             | <b>59</b> |
| Assumptions.....                                  | 59        |
| Introduction to IPv6.....                         | 59        |
| What’s changed in IPV6? .....                     | 60        |
| IPv6 Addressing .....                             | 61        |
| Configuring IPv6.....                             | 61        |
| List of commands in this chapter .....            | 62        |
| <b>5 – Access Considerations .....</b>            | <b>64</b> |
| Securing access.....                              | 64        |
| Passwords .....                                   | 64        |
| Port Security.....                                | 65        |

|   |            |
|---|------------|
| Network security.....                         | 65         |
| Configuring Port Security.....                | 65         |
| Logs.....                                     | 71         |
| Authorized managers.....                      | 73         |
| List of commands in this chapter.....         | 75         |
| <b>6 – Access Using RADIUS.....</b>           | <b>77</b>  |
| RADIUS.....                                   | 77         |
| 802.1x.....                                   | 77         |
| Configuring 802.1x.....                       | 80         |
| List of commands in this chapter.....         | 85         |
| <b>7 – Access Using TACACS+.....</b>          | <b>87</b>  |
| TACACS – flavors and history.....             | 87         |
| TACACS+ Flow.....                             | 88         |
| TACACS+ Packet.....                           | 89         |
| Configuring TACACS+.....                      | 89         |
| List of commands in this chapter.....         | 91         |
| <b>8 – Port Mirroring and Setup.....</b>      | <b>93</b>  |
| Port monitoring and mirroring.....            | 93         |
| Port mirroring.....                           | 93         |
| Port setup.....                               | 94         |
| Speed settings.....                           | 95         |
| Flow Control.....                             | 96         |
| Back Pressure.....                            | 97         |
| Broadcast Storms.....                         | 99         |
| Preventing broadcast storms.....              | 100        |
| Port Rate limiting for broadcast traffic..... | 101        |
| List of commands in this chapter.....         | 101        |
| <b>9 – VLAN.....</b>                          | <b>103</b> |
| Why VLANs?.....                               | 103        |
| Tag VLAN or Port VLAN?.....                   | 105        |

|  |            |
|--|------------|
| Private VLANs .....  | 106        |
| Using Port VLANs .....                                       | 107        |
| Creating VLANs.....  | 107        |
| Using Tag VLANs .....  | 111        |
| Tag VLANs and Management .....                               | 118        |
| List of commands in this chapter .....                       | 121        |
| <b>10 – Spanning Tree Protocol (STP).....</b>                | <b>123</b> |
| STP features and operation.....                              | 123        |
| Using STP.....   | 124        |
| List of commands in this chapter .....                       | 134        |
| <b>11 – Rapid Spanning Tree Protocol (RSTP).....</b>         | <b>135</b> |
| RSTP concepts.....   | 135        |
| Transition from STP to RSTP .....                            | 136        |
| Configuring RSTP .....                                       | 137        |
| List of commands in this chapter .....                       | 147        |
| <b>12 – RS-Ring™, S-Ring™ and Link-Loss-Learn™ (LLL) 149</b> |            |
| S-Ring and LLL concepts.....                                 | 150        |
| RS-Ring concepts .....                                       | 151        |
| When to use RS-Ring vs S-Ring .....                          | 152        |
| Comparing resiliency methods.....                            | 153        |
| RSTP/STP Operation without RS-Ring or S-Ring .....           | 154        |
| RSTP/STP Operation with S-Ring.....                          | 156        |
| LLL with S-Ring.....   | 158        |
| Ring learn features.....                                     | 158        |
| Configuring S-Ring .....                                     | 159        |
| RSTP Operation with RS-Ring.....                             | 162        |
| Configuring RS-Ring .....                                    | 164        |
| List of commands in this chapter .....                       | 166        |
| <b>13 – Dual-Homing.....</b>                                 | <b>168</b> |

|  |            |
|--|------------|
| Dual-Homing concepts .....                                 | 168        |
| Dual-Homing Modes.....                                     | 171        |
| Configuring Dual-Homing .....                              | 171        |
| List of commands in this chapter .....                     | 173        |
| <b>14 – Link Aggregation Control Protocol (LACP) .....</b> | <b>174</b> |
| LACP concepts .....  | 174        |
| LACP Configuration.....                                    | 175        |
| List of commands in this chapter .....                     | 185        |
| <b>15 – Quality of Service .....</b>                       | <b>186</b> |
| QoS concepts .....   | 186        |
| DiffServ and QoS.....                                      | 187        |
| IP Precedence .....  | 188        |
| Configuring QoS .....                                      | 189        |
| List of commands in this chapter .....                     | 193        |
| <b>16 – IGMP .....</b>                                     | <b>195</b> |
| IGMP concepts.....   | 195        |
| IGMP-L2.....   | 199        |
| Configuring IGMP.....                                      | 202        |
| List of commands in this chapter .....                     | 207        |
| <b>17 – GVRP.....</b>                                      | <b>209</b> |
| GVRP concepts .....  | 209        |
| GVRP Operations.....                                       | 210        |
| Configuring GVRP .....                                     | 215        |
| GVRP Operations Notes.....                                 | 216        |
| List of commands in this chapter .....                     | 217        |
| <b>18 – SNMP .....</b>                                     | <b>218</b> |
| SNMP concepts .....  | 218        |
| Traps.....   | 220        |
| Standards .....  | 220        |



|  |            |
|--|------------|
| Configuring SNMP .....                                     | 221        |
| Configuring RMON .....                                     | 230        |
| List of commands in this chapter .....                     | 231        |
| <b>19 – Miscellaneous Commands .....</b>                   | <b>235</b> |
| Alarm Relays .....   | 235        |
| Email .....  | 239        |
| Serial Connectivity .....                                  | 244        |
| Miscellaneous commands .....                               | 245        |
| Prompt .....   | 246        |
| Ping.....  | 247        |
| FTP modes .....  | 248        |
| System Events.....   | 248        |
| MAC Address Table .....                                    | 253        |
| List of commands in this chapter .....                     | 254        |
| <b>APPENDIX 1 - Command listing by Chapter .....</b>       | <b>257</b> |
| Chapter 2 – Getting Started.....                           | 257        |
| Chapter 3 – IP Address and System Information.....         | 258        |
| Chapter 4 – IPv6 .....                                     | 261        |
| Chapter 5 – Access Considerations.....                     | 262        |
| Chapter 6 – Access Using Radius .....                      | 263        |
| Chapter 7 – Access using TACACS+ .....                     | 264        |
| Chapter 8 – Port mirroring and setup.....                  | 265        |
| Chapter 9 - VLAN .....                                     | 266        |
| Chapter 10 – Spanning Tree Protocol (STP).....             | 267        |
| Chapter 11 – Rapid Spanning Tree Protocol.....             | 267        |
| Chapter 12 – RS-Ring, S-Ring and Link-Loss-Learn .....     | 268        |
| Chapter 13 – Dual-Homing.....                              | 270        |
| Chapter 14 – Link Aggregation Control Protocol (LACP)..... | 270        |
| Chapter 15 – Quality of Service.....                       | 270        |

|   |                   |
|---|-------------------|
| Chapter 16 - IGMP .....   | 271               |
| Chapter 17 - GVRP .....   | 272               |
| Chapter 18 – SNMP .....   | 272               |
| Chapter 19 – Miscellaneous Commands .....                         | 275               |
| <b>APPENDIX 2 - Commands sorted alphabetically .....</b>          | <b>278</b>        |
| <b>APPENDIX 3 - Daylight Savings .....</b>                        | <b>299</b>        |
| Daylight Savings Time.....  | 299               |
| <b>APPENDIX 4 – Updating MNS-6K Software.....</b>                 | <b>301</b>        |
| <b><i>1. Getting Started .....</i></b>                            | <b><i>302</i></b> |
| Selecting the proper version.....                                 | 303               |
| Downloading the MNS-6K software.....                              | 303               |
| Next steps.....   | 307               |
| <b><i>2. Preparing to load the software.....</i></b>              | <b><i>308</i></b> |
| Accessing the switch.....   | 308               |
| Serial Connection.....  | 308               |
| Network Access .....  | 309               |
| Saving the Configuration .....                                    | 309               |
| Serial Connection.....  | 310               |
| Network Access .....  | 312               |
| Next steps.....   | 313               |
| <b><i>3. Loading the MNS-6K software.....</i></b>                 | <b><i>314</i></b> |
| Before loading the MNS-6K software .....                          | 314               |
| Accessing the switch.....   | 314               |
| Serial Connection.....  | 315               |
| Network Access .....  | 316               |
| Next steps.....   | 317               |
| <b><i>4. (Optional Step) Restoring the configuration.....</i></b> | <b><i>318</i></b> |
| Accessing the switch.....   | 318               |
| Reloading the configuration .....                                 | 318               |

|  |            |
|--|------------|
| Updating boot code over the network..... | 319        |
| <b>Index.....</b>                        | <b>321</b> |

# List of Figures

|   |    |
|---|----|
| <b>FIGURE 1</b> - <i>HyperTerminal screen showing the serial settings</i> .....   | 24 |
| <b>FIGURE 2</b> - <i>Prompt indicating the switch model number as well as mode of operation – note the commands to switch between the levels is not shown here.</i> ..... | 25 |
| <b>FIGURE 3</b> - <i>Setting IP address on the switch</i> .....   | 26 |
| <b>FIGURE 4</b> - <i>Rebooting the switch</i> .....   | 27 |
| <b>FIGURE 5</b> - <i>Viewing the basic setup parameters. You can use ‘show setup’ or ‘show sysconfig’ to view setup parameters</i> .....                                  | 27 |
| <b>FIGURE 6</b> - <i>Switching users and privilege levels. Note the prompt changes with the new privilege level.</i> .....  | 28 |
| <b>FIGURE 7</b> - <i>Adding a user with Manager level privilege</i> .....   | 29 |
| <b>FIGURE 8</b> - <i>Deleting a user</i> .....  | 29 |
| <b>FIGURE 9</b> - <i>Changing the password for a specific user</i> .....  | 29 |
| <b>FIGURE 10</b> - <i>Changing the privilege levels for a user</i> .....  | 30 |
| <b>FIGURE 11</b> - <i>Creating user access privileges</i> .....   | 30 |
| <b>FIGURE 12</b> - <i>Help command</i> .....  | 31 |
| <b>FIGURE 13</b> - <i>Help for a specific command</i> .....   | 31 |
| <b>FIGURE 14</b> - <i>Options for the ‘show’ command</i> .....  | 32 |
| <b>FIGURE 15</b> - <i>Listing commands available (at the operator level)</i> .....  | 32 |
| <b>FIGURE 16</b> - <i>Listing commands starting with a specific character</i> .....   | 32 |
| <b>FIGURE 17</b> - <i>Listing commands options – note the command was not completed and the TAB key completed the command.</i> .....                                      | 33 |
| <b>FIGURE 18</b> - <i>logout command</i> .....  | 33 |
| <b>FIGURE 19</b> - <i>Checking the IP settings</i> .....  | 36 |
| <b>FIGURE 20</b> - <i>Changing the boot mode of the switch</i> .....  | 38 |
| <b>FIGURE 21</b> - <i>Changing telnet access – note in this case, the enable command was repeated without any effect to the switch.</i> .....                             | 38 |
| <b>FIGURE 22</b> - <i>Reviewing the console parameters – note telnet is enabled</i> .....   | 39 |
| <b>FIGURE 23</b> - <i>Example of a telnet session</i> .....   | 39 |
| <b>FIGURE 24</b> - <i>managing and viewing multiple telnet sessions</i> .....   | 40 |

|  |    |
|--|----|
| FIGURE 25 - <i>Querying the serial port settings</i> .....   | 41 |
| FIGURE 26 - <i>System parameters using the show setup command. Most parameters here cannot be changed</i> .....  | 41 |
| FIGURE 27 - <i>System parameters using the show sysconfig command. Most parameters here can be changed.</i> .....  | 42 |
| FIGURE 28 - <i>Setting the system name, system location and system contact information</i> .....   | 42 |
| FIGURE 29 - <i>Setting the system date, time and time zone</i> .....   | 43 |
| FIGURE 30 - <i>Setting the system daylight saving time</i> .....   | 44 |
| FIGURE 31 - <i>Setting up SNTP services</i> .....  | 45 |
| FIGURE 32 - <i>Saving the configuration on a tftp server</i> .....   | 45 |
| FIGURE 33 - <i>Based on the ftp or tftp or xmodem commands – the MNS-6K based switch can upload or download different types of files and images .Other files such as log files, hosts file can also be saved or loaded onto a switch</i> .....                                     | 47 |
| FIGURE 34 - <i>commands to save the configuration using ftp. Similar options will be specified using tftp etc. When using the ftp command, use the host command discussed later in this section to define the ftp server</i> .....   | 48 |
| FIGURE 35 - <i>Contents of the config file</i> .....   | 49 |
| FIGURE 36 - <i>Creating host entries on MNS-6K</i> .....   | 50 |
| FIGURE 37 - <i>‘show config’ command output</i> .....  | 52 |
| FIGURE 38 - <i>displaying specific modules using the ‘show config’ command</i> .....   | 52 |
| FIGURE 39 - <i>displaying configuration for different modules. Note – multiple modules can be specified on the command line</i> .....  | 53 |
| FIGURE 40 - <i>Erasing configuration without erasing the IP address</i> .....  | 54 |
| FIGURE 41 - <i>Display the serial number, factory code and other relevant setup information</i> .....  | 54 |
| FIGURE 42 - <i>Configuring IPv6</i> .....  | 62 |
| FIGURE 43 - <i>Changing password for a given account</i> .....   | 64 |
| FIGURE 44 - <i>Port security configuration mode</i> .....  | 65 |
| FIGURE 45 - <i>Port security configuration mode</i> .....  | 66 |
| FIGURE 46 - <i>Port security – allowing specific MAC addresses on a specified port. (No spaces between specified MAC addresses)</i> .....  | 67 |
| FIGURE 47 - <i>Port security - the port learns the MAC addresses. Note – a maximum of 200 MAC addresses can be learnt per port and a maximum of 500 per switch. Also, the ‘action’ on the port must be set to none before the port ‘learns’ the MAC address information.</i> ..... | 67 |
| FIGURE 48 - <i>Enabling and disabling port security</i> .....  | 67 |

|  |     |
|--|-----|
| <b>FIGURE 49</b> – <i>Viewing port security settings on a switch. On port 9, learning is enabled. This port has 6 stations connected to it with the MAC addresses as shown. Other ports have learning disabled and the MAC addresses are not configured on those ports</i> .....                     | 68  |
| <b>FIGURE 50</b> – <i>Enabling learning on a port. Note – after the learning is enabled, the port security can be queried to find the status of MAC addresses learnt. If there were machines connected to this port, the MAC address would be shown on port 11 as they are shown on port 9</i> ..... | 68  |
| <b>FIGURE 51</b> – <i>Allowing specific MAC address on specific ports. After the MAC address is specified, the port or specific ports or a range of ports can be queried as shown</i> .....  | 69  |
| <b>FIGURE 52</b> – <i>Removing a MAC address from port security</i> .....  | 69  |
| <b>FIGURE 53</b> – <i>Setting the logging on a port</i> .....  | 69  |
| <b>FIGURE 54</b> – <i>Steps for setting up port security on a specific port</i> .....  | 71  |
| <b>FIGURE 55</b> – <i>Show log and clear log command. The show log command indicates the type of log activity in the S column</i> .....  | 73  |
| <b>FIGURE 56</b> – <i>Steps to allow deny or remove specific services</i> .....  | 75  |
| <b>FIGURE 57</b> – <i>802.1x network components</i> .....  | 78  |
| <b>FIGURE 58</b> – <i>802.1x authentication details</i> .....  | 79  |
| <b>FIGURE 59</b> – <i>securing the network using port access</i> .....   | 84  |
| <b>FIGURE 60</b> – <i>Flow chart describing the interaction between local users and TACACS authorization</i> .....   | 88  |
| <b>FIGURE 61</b> – <i>TACACS packet format</i> .....   | 89  |
| <b>FIGURE 62</b> – <i>Configuring TACACS+</i> .....  | 91  |
| <b>FIGURE 63</b> – <i>Enabling port mirroring</i> .....  | 94  |
| <b>FIGURE 64</b> – <i>Port setup</i> .....   | 95  |
| <b>FIGURE 65</b> – <i>Setting up back pressure and flow control on ports</i> .....   | 99  |
| <b>FIGURE 66</b> – <i>Setting up broadcast storm protection. Also shows how the threshold can be lowered for a specific port</i> .....   | 101 |
| <b>FIGURE 67</b> – <i>VLAN as two separate collision domains. The top part of the figure shows two “traditional” Ethernet segments. Up to 32 VLANs can be defined per switch</i> .....   | 103 |
| <b>FIGURE 68</b> – <i>Ports can belong to multiple VLANs. In this figure a simplistic view is presented where some ports belong to VLANs 1, 2 and other ports belong to VLANs 2,3. Ports can belong to VLANs 1, 2 and 3. This is not shown in the figure.</i> .....                                  | 104 |
| <b>FIGURE 69</b> – <i>routing between different VLANs is performed using a router or a Layer 3 switch (L3-switch)</i> .....  | 105 |
| <b>FIGURE 70</b> – <i>configuring VLANs on Magnum 6K switch</i> .....  | 108 |
| <b>FIGURE 71</b> – <i>Example of setting up port based VLANs</i> .....   | 111 |

|  |     |
|--|-----|
| <b>FIGURE 72</b> – <i>Example for Tag VLAN</i> .....   | 118 |
| <b>FIGURE 73</b> – <i>Editing the VLAN information for enabling or disabling management</i> .....  | 121 |
| <b>Figure 74</b> – <i>STP default values – refer to next section “Using STP” for more detailed explanation on the variables</i> .....  | 124 |
| <b>FIGURE 75</b> – <i>Viewing STP configuration</i> .....  | 125 |
| <b>FIGURE 76</b> – <i>STP Port status information</i> .....  | 126 |
| <b>FIGURE 77</b> – <i>Enabling STP</i> .....   | 128 |
| <b>FIGURE 78</b> – <i>Configuring STP parameters</i> .....   | 134 |
| <b>FIGURE 79</b> – <i>Enabling RSTP and reviewing the RSTP variables</i> .....   | 139 |
| <b>FIGURE 80</b> – <i>Reviewing the RSTP port parameters</i> .....   | 140 |
| <b>Figure 81</b> – <i>Path cost as defined in IEEE 802.1d (STP) and 802.1w (RSTP)</i> .....  | 141 |
| <b>FIGURE 82</b> – <i>RSTP information from a network with multiple switches. Note the “show stp ports” command can be executed from the manager level prompt or from rstp configuration state as shown in the screen captures earlier.</i> .....                                  | 141 |
| <b>FIGURE 83</b> – <i>Configuring RSTP on MNS-6K</i> .....   | 147 |
| <b>FIGURE 84</b> – <i>Normal RSTP/STP operations in a series of switches. Note – this normal status is designated RING_CLOSED</i> .....  | 155 |
| <b>FIGURE 85</b> – <i>A fault in the ring interrupts traffic. The blocking port now becomes forwarding so that traffic can reach all switches in the network Note – the mP62 as well as the ESD42 switches support LLL and can participate in S-Ring as an access switch</i> ..... | 156 |
| <b>FIGURE 86</b> – <i>More than one S-Ring pair can be selected and more than one S-Ring can be defined per switch. Note – the mP62 as well as the ESD42 switches support LLL and can participate in S-Ring as an access switch</i> .....  | 157 |
| <b>FIGURE 87</b> – <i>Activating S-Ring on the switch</i> .....  | 159 |
| <b>FIGURE 88</b> – <i>S-Ring configuration commands for root switch</i> .....  | 161 |
| <b>FIGURE 89</b> – <i>Link Loss Learn (LLL) setup. Setup LLL on ports connected to other switches participating in S-Ring</i> .....  | 162 |
| <b>FIGURE 90</b> – <i>More than one RS-Ring cannot be defined per managed Magnum 6K switch. Note – unmanaged switches cannot participate in RS-Ring</i> .....  | 163 |
| <b>FIGURE 91</b> – <i>Activating RS-Ring on the switch</i> .....   | 164 |
| <b>FIGURE 92</b> – <i>RS-Ring configuration commands</i> .....   | 166 |
| <b>FIGURE 93</b> – <i>Dual-homing using ESD42 switch and Magnum 6K family of switches. In case of a connectivity break – the connection switches to the standby path or standby link</i> .....   | 169 |
| <b>FIGURE 94</b> – <i>Dual-homing using Magnum 6K family of switches. Note the end device (video surveillance camera) can be powered using PoE options on Magnum 6K family of switches.</i>  |     |

|   |     |
|---|-----|
| <i>In case of a connectivity break – the connection switches to the standby path or standby link .....</i>  | 169 |
| <b>FIGURE 95</b> – <i>Using S-Ring, RS-Ring and dual-homing, it is possible to build networks resilient not only to a single link failure but also for one device failing on the network.....</i>   | 170 |
| <b>FIGURE 96</b> – <i>configuring dual-homing .....</i>   | 172 |
| <b>FIGURE 97</b> – <i>Some valid LACP configurations. ....</i>  | 176 |
| <b>FIGURE 98</b> – <i>an incorrect LACP connection scheme for Magnum 6K family of switches. All LACP trunk ports must be on the same module and cannot span different modules.....</i>  | 176 |
| <b>FIGURE 99</b> – <i>In this figure, even though the connections are from one module to another, this is still not a valid configuration (for LACP using 4 ports) as the trunk group belongs to two different VLANs.....</i>   | 177 |
| <b>FIGURE 100</b> - <i>In the figure above, there is no common VLAN between the two sets of ports, so packets from one VLAN to another cannot be forwarded. There should be at least one VLAN common between the two switches and the LACP port groups. ....</i>  | 177 |
| <b>FIGURE 101</b> – <i>This configuration is similar to the previous configuration, except there is a common VLAN (VLAN 1) between the two sets of LACP ports. This is a valid configuration. ....</i>  | 178 |
| <b>FIGURE 102</b> – <i>In the architecture above, using RSTP and LACP allows multiple switches to be configured together in a meshed redundant link architecture. First define the RSTP configuration on the switches. Then define the LACP ports. Then finally connect the ports together to form the meshed redundant link topology as shown above.....</i> | 178 |
| <b>FIGURE 103</b> – <i>LACP, along with RSTP/STP brings redundancy to the network core or backbone. Using this reliable core with a dual-homed edge switch brings reliability and redundancy to the edge of the network.....</i>  | 179 |
| <b>FIGURE 104</b> – <i>This architecture is not recommended.....</i>  | 180 |
| <b>FIGURE 105</b> – <i>Creating a reliable infrastructure using wireless bridges (between two facilities) and LACP. “A” indicates a Wi-Fi wireless Bridge or other wireless Bridges.....</i>  | 181 |
| <b>FIGURE 106</b> – <i>Configuring LACP.....</i>  | 183 |
| <b>FIGURE 107</b> – <i>The network for the ‘show lacp’ command listed below.....</i>  | 184 |
| <b>FIGURE 108</b> – <i>LACP information over a network.....</i>   | 185 |
| <b>FIGURE 109</b> – <i>ToS and DSCP.....</i>  | 187 |
| <b>FIGURE 110</b> - <i>IP Precedence ToS Field in an IP Packet Header.....</i>  | 188 |
| <b>FIGURE 111</b> - <i>Port weight settings and the meaning of the setting .....</i>  | 190 |
| <b>FIGURE 112</b> – <i>QoS configuration and setup.....</i>   | 193 |
| <b>FIGURE 113</b> – <i>IGMP concepts – advantages of using IGMP.....</i>  | 197 |
| <b>FIGURE 114</b> – <i>IGMP concepts – Isolating multicast traffic in a network.....</i>  | 198 |
| <b>FIGURE 115</b> - <i>In a Layer 2 network, an IGMP multicast traffic goes to all the nodes. In the figure, T1, a surveillance camera, using multicast, will send the traffic to all the nodes - R1</i>  |     |



|  |     |
|--|-----|
| <i>through R6 - irrespective of whether they want to view the surveillance traffic or not. The traffic is compounded when additional cameras are added to the network. End result is that users R1 through R6 see the network as heavily loaded and simple day to day operations may appear sluggish.....</i>  | 200 |
| <b>FIGURE 116</b> - <i>Using IGMP-L2 on Magnum 6K family of switches, a Layer 2 network can minimize multicast traffic as shown above. Each switch has the IGMP-L2 turned on. Each switch can exchange the IGMP query message and respond properly. R4 wants to view surveillance traffic from T1. As shown by (1), a join request is sent by R4. Once the join report information is exchanged, only R4 receives the video surveillance traffic, as shown by (2). No other device on the network gets the video surveillance traffic unless they issue a join request as well. ....</i> | 201 |
| <b>FIGURE 117</b> – <i>Enabling IGMP and query the status of IGMP .....</i>  | 203 |
| <b>FIGURE 118</b> – <i>Displaying IGMP groups.....</i>   | 204 |
| <b>FIGURE 119</b> – <i>Configuring IGMP.....</i>   | 207 |
| <b>FIGURE 120</b> - <i>Setting IGMP-L2 .....</i>   | 207 |
| <b>FIGURE 121</b> – <i>GVRP operation – see description below.....</i>   | 210 |
| <b>FIGURE 122</b> – <i>VLAN Assignment in GVRP enabled switches. Non GVRP enabled switches can impact VLAN settings on other GVRP enabled switches.....</i>  | 211 |
| <b>FIGURE 123</b> – <i>Port settings for GVRP operations .....</i>   | 212 |
| <b>FIGURE 124</b> – <i>Command to check for dynamically assigned VLANs .....</i>   | 213 |
| <b>FIGURE 125</b> – <i>Converting a dynamic VLAN to a static VLAN.....</i>   | 213 |
| <b>FIGURE 126</b> – <i>GVRP options.....</i>   | 214 |
| <b>FIGURE 127</b> – <i>GVRP configuration example .....</i>  | 216 |
| <b>FIGURE 128</b> – <i>Configuring SNMP – most of the command here are SNMP v3 commands .....</i>  | 230 |
| <b>FIGURE 129</b> – <i>Configuring RMON groups.....</i>  | 231 |
| <b>FIGURE 130</b> – <i>Predefined conditions for the relay .....</i>   | 236 |
| <b>FIGURE 131</b> – <i>Setting up the external electrical relay and alerts.....</i>  | 239 |
| <b>FIGURE 132</b> – <i>setting SMTP to receive SNMP trap information via email.....</i>  | 244 |
| <b>FIGURE 133</b> – <i>Optimizing serial connection (shown for Hyper Terminal on Windows XP). The highlighted fields are the ones to change as described.....</i>  | 244 |
| <b>FIGURE 134</b> – <i>History commands .....</i>  | 246 |
| <b>FIGURE 135</b> – <i>Setting custom prompts.....</i>   | 247 |
| <b>FIGURE 136</b> – <i>Using the ping command.....</i>   | 247 |
| <b>FIGURE 137</b> – <i>Event log shown on the screen.....</i>  | 249 |
| <b>FIGURE 138</b> – <i>Using exportlog to export the event log information .....</i>   | 250 |
| <b>FIGURE 139</b> – <i>Listing of severity - sorted by subsystem and severity .....</i>  | 253 |

|   |     |
|---|-----|
| <b>FIGURE 140</b> – <i>Display of the internal switching decision table.....</i>  | 254 |
| <b>FIGURE 141</b> – <i>Accessing the GarrettCom site for download.....</i>  | 305 |
| <b>FIGURE 142</b> – <i>Select the proper version to use after successful login .....</i>  | 306 |
| <b>FIGURE 143</b> – <i>Navigate to MNS-6K folder to download the latest MNS-6K software and the<br/>release notes.....</i>  | 306 |
| <b>FIGURE 144</b> – <i>Use the copy command to copy the files to the proper location .....</i>  | 307 |
| <b>FIGURE 145</b> - <i>HyperTerminal screen showing the serial settings .....</i>   | 309 |
| <b>FIGURE 146</b> – <i>Using telnet command to connect to a Magnum 6K switch with IP address<br/>192.168.10.11 .....</i>  | 309 |
| <b>FIGURE 147</b> – <i>Example of saveconf command using serial interface.....</i>  | 310 |
| <b>FIGURE 148</b> – <i>Invoke the “Receive File” to start the Xmodem transfer program. In the figure<br/>above the Windows XP based HyperTerminal screen is shown .....</i>             | 311 |
| <b>FIGURE 149</b> – <i>Make sure to select the Xmodem protocol and the proper directory where the<br/>configuration is saved. Click on Receive. This starts the file transfer. ....</i> | 311 |
| <b>FIGURE 150</b> – <i>Status window for Xmodem (using HyperTerminal under Windows XP) .....</i>  | 312 |
| <b>FIGURE 151</b> – <i>Message which shows the completion of the file transfer (from ‘saveconf’ command).....</i>   | 312 |
| <b>FIGURE 152</b> – <i>Example of saveconf command for tftp.....</i>  | 312 |
| <b>FIGURE 153</b> – <i>Upgrade using serial connection .....</i>  | 315 |
| <b>FIGURE 154</b> – <i>File upload status window under Xmodem (using HyperTerminal under Windows<br/>XP).....</i>   | 315 |
| <b>FIGURE 155</b> – <i>upgrading the switch using the serial interface .....</i>  | 316 |
| <b>FIGURE 156</b> – <i>Dialog for upgrading the image using tftp.....</i>   | 317 |
| <b>FIGURE 157</b> – <i>Updating the boot code over the network using the upgrade command. Make sure<br/>to reboot the switch after the boot loader upgrade is completed.....</i>        | 319 |

# 1 – Conventions Followed

*Conventions followed in the manual...*

To best use this document, please review some of the conventions followed in the manual, including screen captures, interactions and commands with the switch, etc.

Box shows interaction with the switch command line or screen captures from the switch or computer for clarity

**Commands typed by a user will be shown in a different color and this font**

**Switch prompt** – shown in Bold font, with a “# or >” at the end. For the document we will use **Magnum6K25#** as the default prompt.

## Syntax rules

Optional entries are shown in [square brackets]

Parameter values within are shown in < pointed brackets >

Optional parameter values are shown again in [square brackets]

Thus

*Syntax* command [**parameter1**=<value1>[, **parameter2**=<value2>]]  
**parameter3**=<value3 | value4>

In the example above:

Parameter 1 and Parameter 2 are optional values

Parameter 2 can be used optionally only if Parameter 1 is specified

Parameter 3 is mandatory.

Parameter 1 has value1 = IP address

Parameter 2 has value2 = string

Parameter 3 has value3 or value4

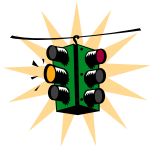


### Related Topics

Related topics show that GarrettCom strongly recommends reading about those topics. You may choose to skip those if you already have prior detailed knowledge on those subjects.



**Tool box** – Necessary software and hardware components needed (or recommended to have) as a prerequisite. These include serial ports on a computer, serial cables, TFTP or FTP software, serial terminal emulation software etc.



**Caution or take notice** – Things to watch out for in case of problems or potential problems. This is also used to draw attention to a special issue, capability or fact.

**Terminology** – Whenever the word PC is used it implies a UNIX, Linux, Windows or any other operating system based work station, computer, personal computer, laptop, notebook or any other computing device. Most of the manual uses Windows-XP based examples. While effort has been made to indicate other Operating System interactions, it is best to use a Windows-XP based machine when in doubt.

**Supported MNS-6K Version** – The documentation reflects features of MNS-6K version 3.4 or later. If your switch is not at the current version, GarrettCom Inc. recommends upgrade to the latest version. Please refer to the GarrettCom Web site for information on upgrading the MNS-6K software on Magnum 6K family of switches.

**Product Family** – this manual is for all the Magnum 6K family of switches.

Finally, at the end of each chapter, is a list of the commands covered in the chapter as well as a brief synopsis of what they do.

## Flow of the User Guide

The manual is designed to guide the user through a sequence of events.

**Chapter 1** – this chapter

**Chapter 2** is the basic setup as required by the Magnum 6K family of switches. After completing Chapter 2, the configuration can be done using the web interface. Chapter 2 is perhaps the most critical chapter in what needs to be done by the network administrator once the switch is received.

**Chapter 3** focuses on operational issues of the switch. This includes time synchronization using the command line or using a time server on the network.

**Chapter 4 through Chapter 6** focuses on security and access consideration. Bad passwords trump any security setup, so setup the manager passwords carefully as described in Chapter 2. Chapter 4 describes how to setup port access using MAC address security. Chapter 5 describes how a RADIUS server can be used for authentication and access. Chapter 6 essentially is similar to Chapter 5, and talks about using a TACACS+ server instead of a RADIUS server.

**Chapter 7** talks about port mirroring and preventing broadcast storms. Port mirroring is necessary in a network to reflect traffic from one port onto another port so that the traffic can be captured for protocol analysis or intrusion analysis.

**Chapter 8** deals with VLANs. VLANs provide security as well as traffic separation. This chapter shows how VLANs can be setup and managed.

At this stage the network and the switch are secured. It is now critical to make the network more reliable. The User Guide switches gears and talks about STP, RSTP and S-Ring technologies which can be used for making the network reliable. These technologies allow resiliency in a network. **Chapters 9 through Chapter 12** discuss some resiliency techniques.

**Chapter 9** shows how STP can be setup and used. Today, RSTP is preferred over STP.

**Chapter 10** shows how RSTP is setup and used as well as how RSTP can be used with legacy devices which support STP only.

**Chapter 11** focuses on S-Ring™ and setup of S-Ring (optional). This chapter also talks about using RS-Ring™ with managed switches.

**Chapter 12** talks about dual homing and how dual homing can be used to bring resiliency to edge devices.

**Chapter 13** describes LACP and how LACP can be used to increase the throughput using 10/100 Mbps ports or in situations where resiliency is needed between switches (trunks).

Once the network is made resilient, the network manager may want to setup prioritization of traffic.

**Chapter 14** focuses on Quality of Service (QoS) and other prioritization issues.

**Chapters 15 and 16** focus on advanced topics such as IGMP and GVRP.

**Chapter 15** focuses on IGMP.

**Chapter 16** focuses on GVRP.

**Chapter 17** shows how the SNMP parameters can be setup for managing the switch with network management software such as Castle Rock SNMPc™

**Chapter 18** includes miscellaneous commands to improve the overall ease of use and other diagnostic information.

## 2 – Getting Started

*First few simple steps ...*

This section explains how the GarrettCom Magnum 6K family of switches can be setup using the console port on the switch. Some of the functionality includes setting up the IP address of the switch, securing the switch with a user name and password, setting up VLAN's and more.

### Before starting



Before you start, it is recommended to acquire the hardware listed below and be ready with the items listed.

For initial configuration through the serial/console port

- 1) A female-female null modem cable. This cable is available from GarrettCom Inc. as well as from LAN store (<http://www.lanstore.com>)
- 2) Serial port – if your PC does not have a serial port, you may want to invest in a USB to serial converter. This is again available from LAN store or from GarrettCom Inc. Alternately a USB to serial cable can also be used. This cable is also available from LAN store or GarrettCom Inc.
- 3) A PC (or a workstation/computer) with a terminal emulation program such as HyperTerminal (included with Windows) or Teraterm-pro, minicom or other equivalent software. (Make sure the software supports Xmodem protocol, as you may need this in the future to update the MNS-6K software)
- 4) Enough disk space to store and retrieve the configuration files as well as copy software files from GarrettCom. We recommend at least 15MB of disk space for this purpose
- 5) Decide on a manager level account name and password for access security
- 6) IP address, netmask, default gateway for the switch being configured

As a default, the switch has no IP (Internet Protocol) address and subnet mask. For first time use, the IP address has to be assigned. This can **only** be done by using the console interface provided.

The same procedure can also be used for other configuration changes or updates – e.g. changing the IP address, VLAN assignments and more. Once the IP address is assigned and a PC is networked to the switch, the switch's command line interface (CLI) can be accessed via telnet. To manage the switch through in-band (networked) access (e.g. telnet, or Web Browser Interface), you should configure the switch with an IP address and subnet mask compatible with your network. You should also change the manager password to control access privileges from the console.

Many other features such as optimizing the switch's performance, traffic engineering and traffic prioritizing, VLAN configuration, and improving network security can be configured through the switch's console interface as well as in-band (networked) access, once the IP address is setup. Besides the IP address, setting up the SNMP parameters allows configuration and monitoring through an SNMP network management station running a network management program (e.g. SNMPc from Castle Rock – available from GarrettCom Inc.)



### MNS-6K Software Updates

Magnum switches already have the necessary software loaded on them. If a software upgrade is needed or the MNS-6K software needs to be updated to the current version, please refer to the GarrettCom web site for information on updating the MNS-6K software. The documentation on how to update the MNS-6K is included as an Appendix in this manual.

The Login prompt is shown when the connection to the GarrettCom Magnum 6K Switch is successful and the switch is ready for the configuration commands. Should you get a boot prompt, please contact GarrettCom technical support.

The IP address of the switch is assigned automatically from a DHCP server or a BootP server. If these servers do not exist, the switch will be assigned an IP address which was previously configured or a static IP address of 192.168.1.2 with a netmask of 255.255.255.0 (if that address is not in use). It is recommended that the user uses Secure Web Management (SWM) capabilities built into MNS-6K to setup and manage the switch. Please refer to the SWM user guide for more information.

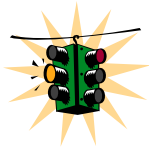
## Console connection

The connection to the console is accessed through the DB-9 RS232 connector on the switch marked on the Magnum 6K family of switches as a console port. This interface provides access to the commands the switch can interpret and is called the Command Line Interface (or CLI). This interface can be accessed by attaching a VT100 compatible terminal or a PC running a terminal emulation program to the console port on the Magnum 6K family of switches.

USB to serial adapters are also available for laptops or computers that do not native serial ports but have access to USB ports.



The interface through the console or the Console Management Interface (or CMI) enables you to reconfigure the switch and to monitor switch status and performance.

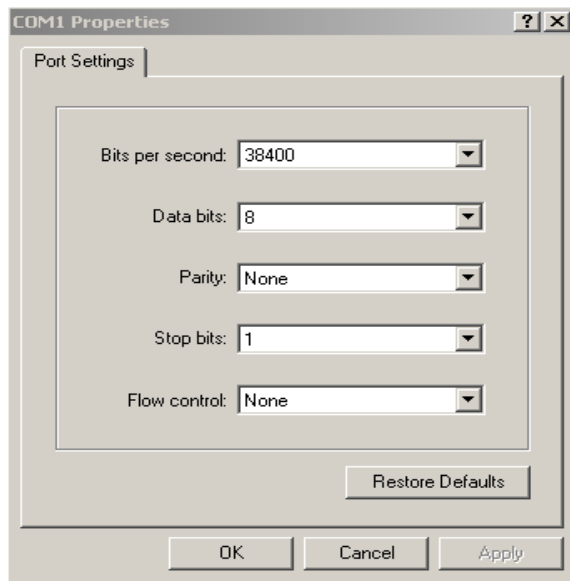


Once the switch is configured with an IP address, the Command Line Interface (or CLI) is also accessible using telnet as well as the serial port. Access to the switch can be either through the console interface or remotely over the network.

The Command Line Interface (CLI) enables local or remote unit installation and maintenance. The Magnum 6K family of switches provides a set of system commands which allow effective monitoring, configuration and debugging of the devices on the network.

## Console setup

Connect the console port on the switch to the serial port on the computer using the serial cable listed above. The settings for the HyperTerminal software emulating a VT100 are shown in Figure 1 below. Make sure the serial parameters are set as shown (or bps = 38400, data bits=8, parity=none, stop bits=1, flow control=none).



**FIGURE 1 -** *HyperTerminal screen showing the serial settings*

## Console screen

Once the console cable is connected to the PC and the software configured, MNS-6K legal disclaimers and other text scrolls by on the screen.

The switch has three modes of operation – Operator (least privilege), Manager and Configuration. The prompts for the switches change as the switch changes modes from Operator to Manager to Configuration. The prompts are shown in Figure 2 below, with a brief explanation of what the different prompts indicate.

|                     |   |
|---------------------|---|
| <b>Magnum6K&gt;</b> | <i>Operator Level – for running operations queries</i>                |
| <b>Magnum6K#</b>    | <i>Manager Level – for setting and reviewing commands</i>             |
| <b>Magnum6K##</b>   | <i>Configuration Level – for changing the switch parameter values</i> |

**FIGURE 2 -** Prompt indicating the switch model number as well as mode of operation – note the commands to switch between the levels is not shown here.

The prompt can be changed by the user. See the Chapter on [Miscellaneous Commands, sub section Prompt](#) for more details. This manual was documented on a Magnum 6K25 switch, and for clarity, the prompt shown in the manual will be **Magnum6K25**



For additional information on default users, user levels and more, see [User Management](#) in this guide.

## Logging in for the first time

For the first time, use the default user name and passwords assigned by GarrettCom for the Magnum 6K family of switches. They are:

|                     |                     |
|---------------------|---------------------|
| Username – manager  | Password – manager  |
| Username – operator | Password – operator |

We recommend you login as manager for the first time to set up the IP address as well as change user passwords or create new users.

## Setting the IP parameters

To setup the switch, the IP address and other relevant TCP/IP parameters have to be specified. A new GarrettCom Magnum switch looks for a DHCP or a BootP server. If a DHCP or a BootP server is present, the switch will be assigned an IP address from those servers. Failing to find these servers, the IP address is automatically assigned to 192.168.1.2 with a netmask of 255.255.255.0.

Should a situation arise when there are multiple new switches powered up at the same time, there could be a situation of duplicate IP addresses. In this situation, only one Magnum switch will be assigned the IP address of 192.168.1.2 and netmask of 255.255.255.0. The other switches will not be assigned an IP address till the static IP address of 192.168.1.2 is freed up or reassigned.

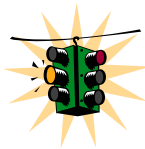
To change the IP address, please ensure that the IP address to be assigned to the switch is known or contact your system/network administrator to get the IP address information. Follow the steps listed below to configure the IP address manually.

- Ensure the power is off
- Follow the steps described [above](#) for connecting the console cable and setting the console software
- Power on the switch
- Once the login prompt appears, login as manager using default password (manager)
- Configure the IP address, network mask and default gateway as per the IP addressing scheme for your network
- Set the Manager Password (recommended—refer to next section)
- Save the settings (without saving, the changes made will be lost)
- Power off the switch (or a software reboot as discussed below)
- Power on the switch – login with the new login name and password
- From the PC (or from the switch) ping the IP address specified for the switch to ensure connectivity
- From the switch ping the default gateway specified (ensure you are connected to the network to check for connectivity) to ensure network connectivity

*Syntax* `ipconfig [ip=<ip-address>] [mask=<subnet-mask>]  
[dgw=<gateway>] [add | del]`

```
Magnum6K25# ipconfig ip=192.168.1.150 mask=255.255.255.0
                dgw=192.168.1.10
Magnum6K25# save
```

**FIGURE 3 -** *Setting IP address on the switch*



This document assumes the reader is familiar with IP addressing schemes as well as how net mask is used and how default gateways and routers are used in a network.

Reboot gives an opportunity to save the configuration prior to shutdown. For a reboot – simply type in the command “reboot”. (Note – even though the passwords are not changed, they can be changed later.)

**Magnum6K25# reboot**

Proceed on rebooting the switch? [ 'Y' or 'N' ] **Y**

Do you wish to save current configuration? [ 'Y' or 'N' ] **Y**

**Magnum6K25#**

**FIGURE 4 - Rebooting the switch**

MNS-6K forces an answer the prompts with a “Y” or a “N” to prevent accidental keystroke errors and loss of work.

The parameters can be viewed at any time by using the ‘show’ command. The show command will be covered in more detail later in various sections throughout the document.

**Magnum6K25# show setup**

```

Version                : Magnum 6K25 build 3.7.1 Sep 27 2007 16:41:37
MAC Address            : 00:20:08:03:05:09
IP Address             : 192.168.5.5
Subnet Mask            : 255.255.255.0
Gateway Address        : 192.168.5.1
CLI Mode               : Manager
System Name            : Magnum 6K25
System Description     : 25 Port Modular Ethernet Switch
System Contact         : support@garrettcom.com
System Location        : Fremont, CA
System Objectid        : 1.3.6.1.4.1.553.12.6
System Serial No       : 43576812
Original Factory Config Code : 6K25-8TP
  
```

**Magnum6K25# show sysconfig**

```

System Name            : Magnum6K25
System Contact         : support@garrettcom.com
System Location        : HO, Fremont, CA
Boot Mode              : manual
Inactivity Timeout(min) : 10
Address Age Interval(min) : 300
Inbound Telnet Enabled : Yes
Web Agent Enabled      : Yes
Time Zone              : GMT-08hours:00minutes
Day Light Time Rule    : USA
System UpTime          : 36 Days 7 Hours 49 Mins 48 Secs
  
```

**Magnum6K25#**

**FIGURE 5 - Viewing the basic setup parameters. You can use ‘show setup’ or ‘show sysconfig’ to view setup parameters**

Some of the parameters in the Magnum 6K family of switches are shown above. The list of parameters below indicates some of the key parameters on the switch and the recommendations for changing them (or optionally keeping them the same).

## Privilege levels

Two privilege levels are available - **Manager** and **Operator**. Operator is at privilege level 1 and the Manager is at privilege level 2 (the privilege increases with the levels). For example, to set up a user for basic monitoring capabilities use lower number or operator level privilege (Level 1)

**The Manager level** provides all **Operator level** privileges plus the ability to perform system-level actions and configuration commands. To select this level, enter the '**enable <user-name>**' command at the Operator level prompt and enter the Manager password, when prompted.

*Syntax* **enable <user-name>**

For example, switching from an Operator level to manager level, using the '**enable**' command is shown below in Figure 6

```
Magnum6K25> enable manager
Password: *****
Magnum6K25#
```

**FIGURE 6** - *Switching users and privilege levels. Note the prompt changes with the new privilege level.*

### Operator Privileges

Operator privileges allow views of the current configurations but do not allow changes to the configuration. A ">" character delimits the Operator-level prompt.

### Manager Privileges

Manager privileges allow configuration changes. The changes can be done at the manager prompt or for global configuration as well as specific configuration. A "#" character delimits any Manager prompt.

## User management

A maximum of five users can be added per switch. Users can be added, deleted or changed from a manager level account. There can be more than one manager account, subject to the maximum number of users on the switch being restricted to five.

## Add User

To add a user, use the command “add” as shown below. The user name has to be a unique name and can be up to 24 characters long. The password is recommended to be at least 8 characters long with a mix of upper case, lower case, numbers and special characters.

*Syntax* **add user=<name> level=<number>**

```
Magnum6K25# user
Magnum6K25(user)## add user=peter level=2
Enter User Password:*****
Confirm New Password:*****
Magnum6K25(user)##
```

FIGURE 7 - Adding a user with Manager level privilege

In this example, user ‘peter’ was added with Manager privilege.

## Delete User

*Syntax* **delete user=<name>**

```
Magnum6K25(user)##delete user=peter
Confirm User Deletion(Y/N): Y
User successfully deleted
Magnum6K25(user)##
```

FIGURE 8 - Deleting a user

In this example, user ‘peter’ was deleted.

## Modify Password

*Syntax* **passwd user=<name>**

```
Magnum6K25(user)## passwd user=peter
Enter New Password:*****
Confirm New Password :*****
Password has been modified successfully
Magnum6K25(user)##
```

FIGURE 9 - Changing the password for a specific user

In this example, password for ‘peter’ was modified.

## Modify the Privilege Level

*Syntax* **chlevel user=<name> level=<number>**

```

Magnum6K25(user)## chlevel user=peter level=1
Access Permission Modified
Magnum6K25(user)##

```

FIGURE 10 - *Changing the privilege levels for a user*

In this example, user ‘peter’ was modified to Operator privileges.

## Modify Access Privileges for a user

*Syntax* `useraccess user=<name> service=<telnet | web> <enable | disable>`

Where

`user=<name>` specifies the user id

`service=<telnet | web>` specifies which service (telnet or web) the user has access to

`<enable | disable>` specifies whether the services are allowed or not allowed.

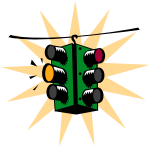
```

Magnum6K25# user
Magnum6K25(user)## add user=peter level=2
Enter User Password :*****
Confirm New Password :*****
Magnum6K25(user)## useraccess user=peter service=telnet disable
Telnet Access Disabled.

```

FIGURE 11 – *Creating user access privileges*

After this command, user Peter will not have telnet access to the switch. User Peter only has console access or SWM access.



The user “peter” has to be added before this command can be successfully executed.

# Help

Typing the **'help'** command lists the commands you can execute at the current privilege level. For example, typing **'help'** at the Operator level shows

```

Magnum6K25> help

logout          ping          set
terminal       telnet       walkmib

Contextless Commands:

!              ?            clear
enable        exit         help
show          whoami

alarm

Magnum6K25>

```

FIGURE 12 - *Help command*

## Displaying Help for an Individual Command

Help for any command that is available at the current context level can be viewed by typing **help** followed by enough of the command string to identify the command.

*Syntax:* **help <command string>**

For example, to list the Help for the **'set time'** command

```

Magnum6K25# help set time
set time          : Sets the device Time

Usage
set time hour=<0-23> min=<0-59> sec=<0-59> [zone=GMT[+/-]hh:mm]
Magnum6K25#

```

FIGURE 13 - *Help for a specific command*

## Viewing options for a command

The options for a specific command can be displayed by typing the command and pressing enter.

*Syntax:* **command <Enter>**

```

Magnum6K25# show <Enter>

```



```

Usage
show active-stp
show active-snmp
show active-vlan
show address-table
show age
show alarm
show arp
show auth <config|ports>
show backpressure
show bootmode
--more--

```

FIGURE 14 - Options for the 'show' command

## Context help

Other ways to display help, specifically, with reference to a command or a set of commands, use the TAB key.

*Syntax* <TAB>

*Syntax* <Command string> <TAB>

*Syntax* <First character of the command> <TAB>

For example, following the syntax listed above, the <TAB> key will list the available commands in the particular privilege level:

```

Magnum6K25> <TAB>
?
alarm
clear
enable
exit
help
logout
ping
set
show
telnet
terminal
walkmib
whoami
Magnum6K25>

```

FIGURE 15 - Listing commands available (at the operator level)

OR

```

Magnum6K25> s <TAB>
set
show
Magnum6K25>

```

FIGURE 16 - Listing commands starting with a specific character

OR

```
Magnum6K25> se<TAB>
password
timeout
vlan
Magnum6K25> set
```

FIGURE 17 - Listing commands options – note the command was not completed and the TAB key completed the command.

## Exiting

To exit from the CLI interface and terminate the console session use the **'logout'** command. The logout command will prompt you to ensure that the logout was not mistakenly typed.

*Syntax:* **logout**

```
Magnum6K25# logout

Logging out from the current session...['Y' or 'N'] Y

Connection to the host lost
```

FIGURE 18 – *logout command*

## List of commands in this chapter

*Syntax:* **ipconfig [ip=<ip-address>] [mask=<subnet-mask>] [dgw=<gateway>]**  
**[add | del]** – to set IP address on the switch

*Syntax:* **save** – save changes made to the configuration

*Syntax:* **reboot** – restart the switch – same effect as physically turning off the power

*Syntax:* **show setup** – show setup parameters

*Syntax:* **show config** – show setup parameters configured

*Syntax:* **enable <user-name>** - changing the privilege level

*Syntax:* **add user=<name> level=<number>** - adding a user

*Syntax:* **delete user=<name>** - deleting a user

*Syntax* **passwd user=<name>** - changing a password for a user

*Syntax* **chlevel user=<name> level=<number>** - changing the user privilege level

*Syntax* **help <command string>** - help for a specific command

*Syntax* **command <Enter>** - options for a command

*Syntax* **<TAB>** - listing all commands available at the privilege level

*Syntax* **<command string> <TAB>** - options for a command

*Syntax* **<first character of the command> <TAB>** - listing commands starting with the character

*Syntax* **logout** – logout from the CLI session

*Syntax* **useraccess user=<name> service=<telnet | web> <enable | disable>**

## 3 – IP Address and System Information

*First simple steps to follow...*

This section explains how the Magnum 6K family of switches can be setup using other automatic methods such as **bootp** and **DHCP**. Besides this, other parameters required for proper operation of the switch in a network are discussed.



### IP Addressing

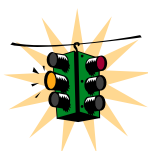
It is assumed that the user has familiarity with IP addresses, classes of IP addresses and related netmask schemes (e.g. class A, Class B and Class C addressing).

## Importance of an IP address

Without an IP address, the switch will operate as a standalone Layer 2 switch. Without an IP address, you cannot

- Use the web interface to manage the switch
- Use telnet to access the CLI
- Use any SNMP Network Management software to manage the switch
- Use NTP protocol or an NTP server to synchronize the time on the switch
- Use TFTP or FTP to download the configurations or upload software updates
- Run ping tests to test connectivity

To set the IP address, please refer to the section in [Chapter 2 – Setting IP Parameters](#).



Once the IP address is set, the CLI can be accessed via the telnet programs as well as the console interface. From now on – all commands discussed are accessible from the CLI – irrespective of the access methods – serial port or in band using telnet.

To verify the IP address settings, the ‘**show ipconfig**’ command can be used.

```
Magnum6K25> show ipconfig
IP Address      : 192.168.1.150
Subnet Mask     : 255.255.255.0
Default Gateway : 192.168.1.10
Magnum6K25>
```

**FIGURE 19** - *Checking the IP settings*

Besides manually assigning IP addresses, there are other means to assign an IP address automatically. The two most common procedures are using DHCP and bootp.



### DHCP and bootp

DHCP is commonly used for setting up addresses for computers, users and other user devices on the network. bootp is the older cousin of DHCP and is used for setting up IP addresses of networking devices such as switches, routers, VoIP phones and more. Both of them can work independent of each other. Both of them are widely used in the industry. It's best to check with your network administrator as to what protocol to use and what the related parameters are. DHCP and bootp require respective services on the network. DHCP and bootp can automatically assign an IP address. It is assumed that the reader knows how to setup the necessary bootp parameters (usually specified on Linux/UNIX systems in `/etc/bootptab1`).

## Bootp Database

Bootp keeps a record of systems supported in a database – a simple text file. On most systems, the bootp service is not started as a default and has to be enabled. A sample entry by which the bootp software will look up the database and update the IP address and subnet mask of the switch would be as follows

```
M6k25switch:\
ht=ether:\
ha=002006250065:\
ip=192.168.1.88:\
sm=255.255.255.0:\
gw=192.168.1.1:\
hn:\
vm=rfc1048
```

where

M6k25switch: is a user-defined symbolic name for the switch

---

<sup>1</sup> Note – on Windows systems – the location of the file will vary depending on which software is being used.

ht: is the “hardware type”. For the Magnum 6K family of switches, set this to **ether** (for Ethernet). *This tag must precede the “ha” tag.*

ha: is the “hardware address”. Use the switch’s 12-digit MAC address

ip: is the IP address to be assigned to the switch

sm: is the subnet mask of the subnet in which the switch is installed

## Configuring Auto/DHCP/Bootp/Manual

By default, the switch is configured for ‘auto’. As described earlier in Chapter 2, in the auto mode, the switch will first look for a DHCP server. If a DHCP server is not found, it will then look for a BootP server. If that server is not found, the switch will first inspect to see if the IP address 192.168.1.2 with a netmask of 255.255.255.0 is free. If the IP address is free, MNS-6K will assign the switch that IP address. If the address is not free, MNS-6K will poll the network for DHCP server then BootP server then check if the IP address 192.68.1.2 is freed up. This mode of assigning the IP address can be changed by using the ‘**set bootmode**’ command.

*Syntax* **set bootmode type=<dhcp | bootp | manual | auto>**

**[booting=<enable | disable>] [bootcfg=[<enable | disable>]** – *assign the boot mode for the switch*

Where

**<dhcp | bootp | manual | auto>** - where

**dhcp** – look only for DHCP servers on the network for the IP address. Disable bootp or other modes

**bootp** – look only for bootp servers on the network. Disable dhcp or other mode

**manual** – do not set the IP address automatically

**auto** - the switch will first look for a DHCP server. If a DHCP server is not found, it will then look for a BootP server. If that server is not found, the switch will check to see if the switch had a pre-configured IP address. If it did, the switch would be assigned that IP address. If the switch did not have a pre-configured IP address, it would inspect if the IP address 192.168.1.2 with a netmask of 255.255.255.0 is free. If the IP address is free, MNS-6K will assign the switch that IP address. If the address is not free, MNS-6K will poll the network for DHCP server then BootP server then check if the IP address 192.68.1.2 is freed up

**booting=<enable | disable>** - valid with type=bootp only. This option allows the switch to load the image file from the BootP server. This is useful when a new switch is put on a network and the IT policies are set to load only a specific MNS-6K image which is supported and tested by IT personnel.

**bootcfg=<enable | disable>** - valid with type=bootp only. This option allows the switch to load the configuration file from the BootP server. This is useful when a new

switch is put on a network and the specific configurations are loaded from a centralized BootP server

```

Magnum6K25# set bootmode type=dhcp
Save Configuration and Restart System
Magnum6K25# set bootmode type=auto
Save Configuration and Restart System
Magnum6K25# set bootmode type=bootp booting=enable bootcfg=disable
Network application image download is enabled.
Network application config download is disabled.
Save Configuration and Restart System
Magnum6K25#

```

FIGURE 20 - Changing the boot mode of the switch

## Using Telnet

By default, the telnet client is enabled on the GarrettCom Magnum 6K family of switches. MNS-6K supports five simultaneous sessions on a switch – four telnet sessions and one console session. This allows many users to view, discuss or edit changes to the MNS-6K. This also becomes useful as two remote people want to view the commands and other settings on the switch. The telnet client can be disabled by using the “**telnet disable**” command. Telnet can also be disabled for a specific user by using the “**useraccess**” command discussed in [Chapter 2](#).

Multiple telnet sessions started from the CLI interface or the command line are serviced by MNS-6K in a round robin fashion – i.e. one session after another. If one telnet session started from MNS-6K interface is downloading a file, the other windows will not be serviced till the file transfer is completed.

*Syntax* telnet <enable | disable>

```

Magnum6K25# configure access
Magnum6K25(access)## telnet enable
Access to Telnet already enabled
Magnum6K25(access)## exit
Magnum6K25#

```

FIGURE 21 - Changing telnet access – note in this case, the enable command was repeated without any effect to the switch

The ‘**show console**’ command can show the status of the telnet client as well as other console parameters.

```

Magnum6K25# show console
Console/Serial Link
  Inbound Telnet Enabled      : Yes
  Outbound Telnet Enabled    : Yes
  Web Console Enabled        : Yes
  SNMP Enabled                : Yes
  Terminal Type               : VT100
  Screen Refresh Interval (sec) : 3
  Baud Rate                   : 38400
  Flow Control                : None
  Session Inactivity Time (min) : 10
Magnum6K25#

```

**FIGURE 22** - Reviewing the console parameters – note telnet is enabled

Users can telnet to a remote host from the Magnum 6K family of switches.

*Syntax* **telnet <ipaddress> [port=<port number>]**  
 The default port for telnet is 23.

```

Magnum6K25# show ipconfig
IP Address      : 192.168.1.11
Subnet Mask     : 255.255.255.0
Gateway Address : 192.168.1.1
Magnum6K25# telnet 192.168.1.1 port=2097

```

**FIGURE 23** - Example of a telnet session

While MNS-6K times out an idle telnet session, it may be useful to see who is currently connected to the switch. It may also be useful for a person to remotely terminate a telnet session. To facilitate this, MNS-6K supports two commands

*Syntax* **show session**

*Syntax* **kill session id=<session>** - terminate a telnet session



```

Magnum6K25# user
Magnum6K25(user)## useraccess user=peter service=telnet enable
Telnet Access Enabled.
Magnum6K25(user)## exit

Magnum6K25# show session
Current Sessions:

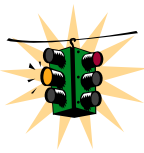
  SL # Session Id  Connection  User Name  User Mode
  ---  ---  ---  ---  ---
  1   1             163.10.10.14  manager   Manager
  2   2             163.11.11.15  peter     Manager
  3   3             163.12.12.16  operator  Operator

Magnum6K25# kill session id=3
Session Terminated.
Magnum6K25#

```

FIGURE 24 – managing and viewing multiple telnet sessions

In the above example, the user with user-id peter is given telnet access (which was disabled earlier in Chapter 2). Then multiple users telnet into the switch. This is shown using the “**show session**” command. The user operator session is then terminated using the “**kill session**” command.



The default port – port 23 is used for telnet.

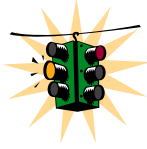
A maximum of four simultaneous telnet sessions are allowed at any time on the switch. The commands in these telnet windows are executed in a round robin – i.e. if one window takes a long time to finish a command, the other windows may encounter a delay before the command is completed. For example, if one window is executing a file download, the other windows will not be able to execute the command before the file transfer is completed. Another example, if a outbound telnet session is started from the switch (through a telnet window) then the other windows will not be able to execute a command till the telnet session is completed.

## Setting serial port parameters

To be compliant with IT or other policies the console parameters can be changed from the CLI interface. This is best done by setting the IP address and then telnet over to the switch. Once connected using telnet, the serial parameters can be changed. If you are using the serial port, remember to set the VT-100 emulation software properties to match the new settings.

*Syntax* **set serial [baud=<rate>] [data=<5|6|7|8>] [parity=<none|odd|even>] [stop=<1|1.5|2>] [flowctrl=<none|xonxoff>]**

Where <rate> = standard supported baud rates



**Warning** – changing these parameters through the serial port will cause loss of connectivity – the parameters of the terminals software (e.g. Hyper Terminal etc.) will also have to be changed to match the new settings.

To see the current settings of the serial port, use the **'show serial'** command.

```
Magnum6K25# show serial
Baud Rate      : 38400
Data           : 8
Parity         : No Parity
Stop           : 1
Flow Control   : None
```

FIGURE 25 - *Querying the serial port settings*

## System parameters

The system parameters can be queried and changed. To query the system parameters, two commands are used frequently. They are **'show sysconfig'** and **'show setup'**. Both the commands are shown below.

```
Magnum6K25# show setup
Version                : Magnum 6K25 build 3.7.1 Sep 27 2007 16:41:37
MAC Address            : 00:20:08:03:05:09
IP Address             : 192.168.5.5
Subnet Mask            : 255.255.255.0
Gateway Address        : 192.168.5.1
CLI Mode               : Manager
System Name            : Magnum 6K25
System Description     : 25 Port Modular Ethernet Switch
System Contact         : support@garrettcom.com
System Location        : Fremont, CA
System Objectld        : 1.3.6.1.4.1.553.12.6
System Serial No.     : 43576812
Original Factory Config Code : 6K25-8TP
Magnum6K25#
```

FIGURE 26 - *System parameters using the show setup command. Most parameters here cannot be changed*

```

Magnum6K25# show sysconfig
System Name           : Magnum6K25
System Contact        : support@garrettcom.com
System Location       : HO, Fremont, CA
Boot Mode             : manual
Inactivity Timeout(min) : 10
Address Age Interval(min) : 300
Inbound Telnet Enabled : Yes
Web Agent Enabled     : Yes
Time Zone             : GMT-08hours:00minutes
Day Light Time Rule   : USA
System UpTime         : 7 Days 12 Hours 30 Mins 46 Secs
Magnum6K25#

```

**FIGURE 27** - System parameters using the `show sysconfig` command. Most parameters here can be changed.

System variables can be changed. Below is a list of system variables which GarrettCom recommends changing.

**System Name:** Using a unique name helps you to identify individual devices in a network.

**System Contact and System Information:** This is helpful for identifying the administrator responsible for the switch and for identifying the locations of individual switches.

To set these variables, change the mode to be SNMP configuration mode from the manager mode.

*Syntax* **snmp**

*Syntax* **setvar [sysname | syscontact | syslocation]=<string>** where string is a character string, maximum 24 characters long

```

Magnum6K25# snmp
Magnum6K25(snm)## setvar ?
setvar : Configures system name, contact or location
Usage:
setvar [sysname|syscontact|syslocation]=<string>
Magnum6K25(snm)## setvar syslocation=Fremont
System variable(s) set successfully
Magnum6K25(snm)## exit
Magnum6K25#

```

**FIGURE 28** - Setting the system name, system location and system contact information

## Date and time

It may be necessary to set the day, time or the time zone manually. This can be done by using the 'set' command with the necessary date and time options. These are listed below:

*Syntax* **set timezone GMT=[+ or -] hour=<0-14> min=<0-59>**

*Syntax* **set date year=<2001-2035> month=<1-12> day=<1-31>**  
**[format=<mmddyyyy | ddmmyyyy | yyyyymmdd>]**

*Syntax* **set time hour=<0-23> min=<0-59> sec=<0-59> [zone=GMT[+/-]hh:mm]**

Thus to set the time to be 08:10 am in the -8 hours from GMT (PST or time zone on west coast of USA) and to set the date to be 15 October 2003, the following set of commands are used.

```
Magnum6K25# set time hour=8 min=30 sec=0 zone=GMT-8:00
success in setting device time
Magnum6K25# show time
Time : 8:30:04
Magnum6K25# show timezone
Timezone : GMT-08hours:00minutes
Magnum6K25# set date year=2003 month=10 day=15
Success in setting device date
Magnum6K25# show date
System Date : Wednesday 10-15-2003 (in mm-dd-yyyy format)
Magnum6K25#
```

FIGURE 29 - Setting the system date, time and time zone

Rebooting the switch resets the time to the default. Synchronizing with the time server resets the time. Other relevant date and time commands are:

*Syntax* **set timeformat format=<12 | 24>**

*Syntax* **set daylight country=< country name>**

```
Magnum6K25# set daylight ?
set daylight      : Sets the day light location

Usage
set daylight country=<name>
Magnum6K25# set daylight country=USA

Success in setting daylight savings to the given location/country USA
Magnum6K25# show daylight
```

Daylight savings location name : USA

**Magnum6K25#**

**FIGURE 30** - *Setting the system daylight saving time*

See Appendix 3 for additional information on Daylight Savings Time. The lists of countries for the time zone are

Australia, Belgium, Canada, Chile, Cuba, Egypt, France, Finland, Germany, Greece, Iraq, Italy, London, Namibia, Portugal, Russia, Spain, Sweden, Switzerland, Syria, USA

## Network time

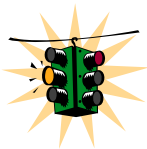
Many networks synchronize the time using a Network time server. The network time server provides time to the different machines using the Simple Network Time Protocol (SNTP). To specify the SNTP server, one has to

- 1) Set the IP parameters on the switch
- 2) Define the SNTP parameters

To set the SNTP parameter, enter the SNTP configuration mode from the manager. The **'setsntp, sync, sntp'** commands can then be used to setup the time synchronization automatically from the SNTP server. Note it is not sufficient to setup the SNTP variables. Make sure to setup the synchronization frequency as well as enable SNTP. The list of relevant commands is listed below.

*Syntax* **setsntp server = <ipaddress> timeout = <1-10> retry = <1-3>**

*Syntax* **sync [hour=<0-24>] [min=<0-59>] (default = 24 hours)**



The time zone and daylight savings time information have to be set for SNTP server to set the proper time

*Syntax* **sntp [enable | disable]**

For example, to set the SNTP server to be 204.65.129.201<sup>2</sup> (with a time out of 3 seconds and a number of retries set to 3 times); allowing the synchronization to be ever 5 hours, the following commands are used

---

<sup>2</sup> There are number of public NTP servers. Search on the internet using 'NTP Servers' yields the necessary server IP addresses.

```

Magnum6K25# sntp

Magnum6K25(sntp)## setsntp server=204.65.129.201 timeout=3 retry=3

SNTP server is added to SNTP server database
Magnum6K25(sntp)## sync hour=5

Magnum6K25(sntp)## sntp enable
SNTP is already enabled.

Magnum6K25(sntp)## exit
Magnum6K25(sntp)#

```

Do not forget to enable sntp  
for time synchronization.

FIGURE 31 - *Setting up SNTP services*

## Saving and loading configuration

After configuration changes are made, all the changes are automatically registered **but not saved** i.e. the effect of the change is immediate, however, if power fails, the changes are not saved and restored, unless the changed are saved using the save command. It is also a good practice to save the configuration on another server on the network using the tftp or ftp protocols. Once the configuration is saved – the saved configuration can be loaded to restore back the settings. At this time the configuration parameter saved or loaded are not in a human readable format. The commands for saving and loading configurations on the network are:

*Syntax* **saveconf mode=<serial | tftp | ftp> [<ipaddress>] [file=<name>]**

*Syntax* **loadconf mode=<serial | tftp | ftp> [<ipaddress>] [file=<name>]**

Make sure the machine specified by the IP address has the necessary services running on it. For serial connections, x-modem or other alternative methods can be used. File name in many situations has to be a unique file name as over-writing files is not permitted by most ftp and tftp servers (or services). Only alpha-numeric characters are allowed in the file name – special characters like `!@#%&*(\|){/};[,]'` (or other control characters e.g. `^G`) are not allowed

```

Magnum6K25# saveconf mode=tftp 192.168.10.1 file=mag6Kmain
Do you wish to upload the configuration? [ 'Y' or 'N' ] Y

```

FIGURE 32 - *Saving the configuration on a tftp server*

The “**saveconf**” and “**loadconf**” commands are used often to update new software to the Magnum 6K family of switches. These commands will be obsoleted in the next release and replaced with the “**ftp**” or “**tftp**” or “**xmodem**” commands listed below. It is advised to start using these commands instead of “**saveconf**” and “**loadconf**”. Before the

software is updated, it is advised to save the configurations. The re-loading of the configuration is not usually necessary; however, in certain situations it may be needed and it is advised to save configurations before a software update. The 'loadconf' command requires a reboot for the new configuration to be active. Without a reboot the older configuration is used by the Magnum 6K family of switches. When Reboot is selected, the user is prompted: 'Reboot Y/N'. Select 'Y', the prompt is then: 'Save Current Configuration?' You must select 'No'.

Along with the ftp command listed below, MNS-6K also supports normal ftp as well as passive ftp. Passive FTP is used by many companies today to work with firewall policies and other security policies set by companies. The commands for setting the type of ftp are:

*Syntax* **set ftp mode=<normal | passive>** - set the ftp mode of operation<sup>3</sup>

*Syntax* **show ftp** - display the current ftp operation mode

With MNS-6K additional capabilities have been added to save and load configurations. The commands are:

*Syntax* **ftp <get | put | list | del> [type=<app | config | oldconf | script | hosts | log>] [host=<hostname>] [ip=<ipaddress>] [file=<filename>] [user=<user>] [pass=<password>]** - upload and download information using ftp command

Where

**<get | put | list | del>** - different ftp operations

**[type=<app | config | oldconf | script | hosts | log>]** - optional type field. This is useful to specify whether a log file or host file is uploaded or downloaded. This can also perform the task of exporting a configuration file or uploading a new image to the switch

**[host=<hostname>] [ip=<ipaddress>] [file=<filename>] [user=<user>] [pass=<password>]** - parameters associated with ftp server for proper communications with the server

*Syntax* **tftp <get | put> [type=<app | config | oldconf | script | hosts | log>] [host=<hostname>] [ip=<ipaddress>] [file=<filename>]** - upload and download information using tftp command

Where

**<get | put>** - different tftp operations – get a file from the server or put the information on the server

---

<sup>3</sup> FTP uses a set of separate ports for the data stream and command stream. This causes problems in security conscious companies who prefer that the client initiate the file transfer as well as the stream for the commands. To accommodate that, ftp added the capability called "passive ftp" in which the client initiating the connection initiates both the data and command connection request. Most companies prefer passive ftp and GarrettCom MNS-6K provides means to operate in those environments.

**[type=<app | config | oldconf | script | hosts | log>]** – optional type field. This is useful to specify whether a log file or host file is uploaded or downloaded. This can also perform the task of exporting a configuration file or uploading a new image to the switch

**[host=<hostname>] [ip=<ipaddress>] [file=<filename>]** – parameters associated with tftp server for proper communications with the server

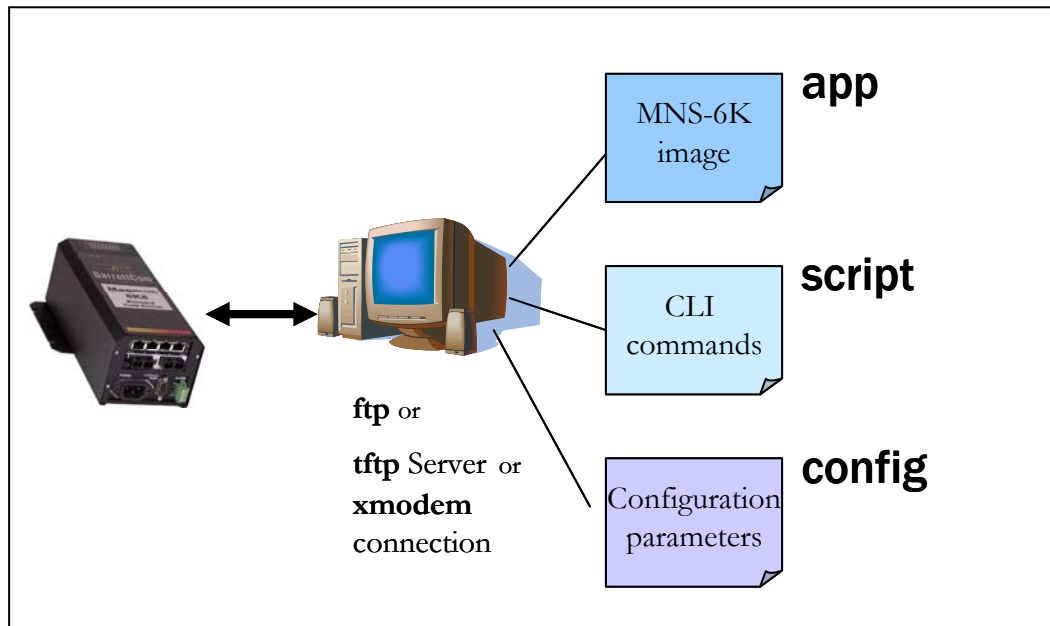
*Syntax* **xmodem <get | put> [type=<app | config | oldconf | script | hosts | log>]** –  
upload and download information using xmodem command and console connection

Where

**<get | put>** - different xmodem file transfer operations – get a file from the server or put the information on the server

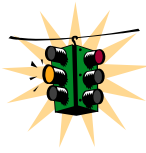
**[type=<app | config | oldconf | script | hosts | log>]** – optional type field. This is useful to specify whether a log file or host file is uploaded or downloaded. This can also perform the task of exporting a configuration file or uploading a new image to the switch

The details are conceptually explained in the figure below.



**FIGURE 33** – Based on the ftp or tftp or xmodem commands – the MNS-6K based switch can upload or download different types of files and images. Other files such as log files, hosts file can also be saved or loaded onto a switch





Prior to Release 3.2, the configuration was saved only as a binary object (file). With Release 3.2 and beyond, the configuration can be saved in the older format – binary object or in a newer format as an ASCII (readable) file. The new format is preferred by GarrettCom and GarrettCom recommends all configuration files be saved in the new format. GarrettCom recommends saving the configuration in the old format only if there are multiple Magnum 6K family of switches on the network and they all run different versions of MNS-6K. GarrettCom recommends to upgrade all switches to the most current release of MNS-6K.

## Config files

As shown in the figure above, MNS-6K can now use the ftp, tftp or xmodem commands to upload and download information to the server running the proper services. One useful capability provided in MNS-6K is the capability to export the CLI commands (as described in this manual) used to configure the switch. To do that, for example, using the tftp command, the sequence of commands are shown below

```

Magnum 6K25# show ftp

Current FTP Mode: NORMAL
Magnum 6K25# set ftp mode=passive

FTP Set to Passive Mode
Magnum 6K25# show ftp

Current FTP Mode: PASSIVE
Magnum 6K25# set ftp mode=normal

FTP Set to Normal Mode
Magnum 6K25# show ftp

Current FTP Mode: NORMAL
Magnum6K25# ftp put type=config ip=192.168.5.2 file=config
Do you wish to export configuration file? ['Y' or 'N'] Y
Successfully exported the configuration
Magnum6K25#

```

**FIGURE 34** – *commands to save the configuration using ftp. Similar options will be specified using tftp etc. When using the ftp command, use the host command discussed later in this section to define the ftp server*

After saving the contents of the saved configuration file are as follows

```

#####
# Copyright (c) 2001-2005 GarrettCom, Inc All rights reserved.
# RESTRICTED RIGHTS
# -----
# Use, duplication or disclosure is subject to U.S. Government
# restrictions as set forth in Sub-division (b)(3)(ii) of the

```

```

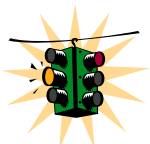
# rights in Technical Data and Computer Software clause at
# 52.227-7013.
#
# This file is provided as a sample template to create a backup
# of Magnum 6K switch configurations. As such, this script
# provides insights into the configuration of Magnum 6K switch's
# settings. GarrettCom recommends that modifications of this
# file and the commands should be verified by the User in a
# test environment prior to use in a "live" production network.
# All modifications are made at the User's own risk and are
# subject to the limitations of the GarrettCom software End User
# License Agreement (EULA). Incorrect usage may result in
# network shutdown. GarrettCom is not liable for incidental or
# consequential damages due to improper use.
#####

#Magnum 6KQ build 3.7.1 Sep 27 2007 16:41:37
#Modules: 39 99 86 0
#Slot A: 4 Port TP-MDIX Module
#Slot B: 2 Port Fiber10 Module
#Slot C: 4 Port Fiber100 Module
#Slot D: 1 10/100/1000T 1 Giga SFP-1000
#####
# System Manager - This area configures System related          #
#      information.                                             #
#####
set bootmode type=auto
set timeout=10
access
telnet enable
snmp enable
web enable
ssl enable
exit
#####
# User Accounts - This area configures user accounts for        #
#      accessing this system.                                   #
#####
user
add user=manager level=2 pass=manager
useraccess user=manager service=telnet enable
useraccess user=manager service=web enable
useraccess user=manager service=acl enable
add user=operator level=1 pass=operator
#####

<additional lines deleted for succinct viewing>

```

**FIGURE 35** – Contents of the config file



**Note 1** – the config file only allows certain portions of the file to be edited by a user. Changing any other part of the file will not allow the file to be loaded as the CRC

computed and stored in the file will not be matched. Should you want to edit, edit the System portion of the file only. GarrettCom recommends editing the “script” file (see below)

**Note 2** – File names cannot have special characters such as \*#!@\$^&\* space and control characters.

To ease the process of uploading and executing a series of commands, the MNS-6K commands are:

**Syntax** `host <add|edit|del> name=<host-name> [ip=<ipaddress>] [user=<user>] [pass=<password>]` – create a host entry for accessing host. This is equivalent to creating a host table on many systems. Maximum of 10 such entries are allowed

**Syntax** `show host` – displays the host table entries

```
Magnum6K25# access
Magnum6K25(access)## host
Usage
host <add|edit|del> name=<host-name> [ip=<ipaddress>] [user=<user>] [pass=<password>]
Magnum6K25(access)## host add name=server ip=192.168.5.2
Host added successfully
Magnum6K25(access)## show host
```

| No | Host | Name   | IP Address  | User | Password |
|----|------|--------|-------------|------|----------|
| 1  |      | server | 192.168.5.2 | --   | *****    |
| 2  |      | --     | --          | --   | --       |
| 3  |      | --     | --          | --   | --       |
| 4  |      | --     | --          | --   | --       |
| 5  |      | --     | --          | --   | --       |
| 6  |      | --     | --          | --   | --       |
| 7  |      | --     | --          | --   | --       |
| 8  |      | --     | --          | --   | --       |
| 9  |      | --     | --          | --   | --       |
| 10 |      | --     | --          | --   | --       |

```
Magnum 6K25(access)##
```

FIGURE 36 – Creating host entries on MNS-6K

## Displaying configuration

To display the configuration or to view specific modules configured, the ‘**show config**’ command is used as described below.

**Syntax** `show config [module=<module-name>]`

Where module-name can be

| Name   | Areas affected  |
|--------|---|
| system | IP Configuration, Boot mode, Users settings (e.g. login names, passwords) |
| event  | Event Log and Alarm settings  |
| port   | Port settings, Broadcast Protection and QoS settings                      |
| bridge | Age time setting  |
| stp    | STP, RSTP, S- Ring and LLL settings                                       |
| ps     | Port Security settings  |
| mirror | Port Mirror settings  |
| sntp   | SNTP settings   |
| llan   | VLAN settings   |
| gvrp   | GVRP settings   |
| snmp   | SNMP settings   |
| web    | Web and SSL/TLS settings  |
| tacacs | TACACS+ settings  |
| auth   | 802.1x Settings   |
| igmp   | IGMP Settings   |
| smtp   | SMTP settings   |

If the module name is not specified the whole configuration is displayed.

#### Magnum6K25# show config

```
[HARDWARE]
type=Magnum6K25
slotB=8 Port TP Module
#####
# System Manager - This area configures System related      #
#      information.                                         #
#####
[SYSTEM]
***Edit below this line only***
system_name=Main
system_contact=someone@joe.com
system_location=Sunnyvale, CA
boot_mode=manual
system_ip=192.168.1.15
system_subnet=0.0.0.0
system_gateway=192.168.1.11
idle_timeout=10
telnet_access=enable
snmp_access=enable
web_access=enable

--more--
```

*<additional lines deleted for succinct viewing>*

FIGURE 37 – ‘show config’ command output

```
Magnum6K25# show config module=snmp
[HARDWARE]
type=Magnum6K25
slotB=8 Port TP Module
#####
# Network Management - This area configures the SNMPv3      #
#      agent.                                           #
#####
[SNMP]
engineid=6K_v3Engine
defreadcomm=public
defwritecomm=private
deftrapcomm=public
authtrap=disable
com2sec_count=0
group_count=0
view_count=1
view1_name=all
view1_type=included
view1_subtree=.1
view1_mask=ff

--more--
<additional lines deleted for succinct viewing>
```

FIGURE 38 – displaying specific modules using the ‘show config’ command

```
Magnum6K25# show config module=snmp,system
[HARDWARE]
type=Magnum6K25
slotB=8 Port TP Module
#####
# System Manager - This area configures System related      #
#      information.                                           #
#####
[SYSTEM]
***Edit below this line only***
system_name=Main
system_contact=someone@joe.com
system_location=Sunnyvale, CA
boot_mode=manual
system_ip=192.168.1.15
system_subnet=0.0.0.0
system_gateway=192.168.1.11
idle_timeout=10
telnet_access=enable
```

```
snmp_access=enable
web_access=enable
```

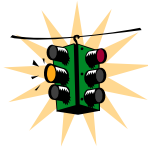
```
--more--
```

*<additional lines deleted for succinct viewing>*

**FIGURE 39** – *displaying configuration for different modules. Note – multiple modules can be specified on the command line*

## Erasing configuration

To erase the configuration and reset the configurations to factory default, you can use the command **'kill config'**. This command is a “hidden command” i.e. the on-line help and other help functions normally do not display this command. The **'kill config'** command resets everything to the factory default. The reset does not take place till the switch reboots.



It is recommended to save the configuration (using **'saveconf'** command discussed above) before using the **'kill config'** command. The **'kill config'** will also reset the IP address and all other parameters as well unless the save option described below is used.

*Syntax* **kill config [save=module-name]** – *resets the system configuration. The module-name option does not reset the specific module parameters. The modules are listed below*

The module-name can be

| Name   | Areas affected  |
|--------|---|
| system | IP Configuration, Boot mode, Users settings (e.g. login names, passwords) |
| event  | Event Log and Alarm settings  |
| port   | Port settings, Broadcast Protection and QoS settings                      |
| bridge | Age time setting  |
| stp    | STP, RSTP, S- Ring and LLL settings                                       |
| ps     | Port Security settings  |
| mirror | Port Mirror settings  |
| sntp   | SNTP settings   |
| llan   | VLAN settings   |
| gvrp   | GVRP settings   |
| snmp   | SNMP settings   |
| web    | Web and SSL/TLS settings  |

|        |                  |
|--------|------------------|
| tacacs | TACACS+ settings |
| auth   | 802.1x Settings  |
| igmp   | IGMP Settings    |
| smtp   | SMTP settings    |

If the module name is not specified the whole configuration is erased.

For example, **'kill config save=system'** preserves the system IP address, netmask and default gateway.

```
Magnum6K25# kill config save=system
Do you want to erase the configuration? ['Y' or 'N'] Y
Successfully erased configuration...Please reboot.
```

**FIGURE 40** – Erasing configuration without erasing the IP address

Once the configuration is erased, please reboot the switch for the changes to take effect.

## Displaying Serial Number

To display the serial number of the unit, use the command “show setup” as shown below. The command also displays other information related to the switch.

*Syntax* **show setup** – display the setup, serial number, factory code information and more

```
Magnum 6K25# show setup

Version                : Magnum 6K25 build 3.7.1 Sep 27 2007 16:41:37
MAC Address            : 00:20:08:03:05:09
IP Address             : 192.168.5.5
Subnet Mask            : 255.255.255.0
Gateway Address        : 192.168.5.1
CLI Mode               : Manager
System Name            : Magnum 6K25
System Description     : 25 Port Modular Ethernet Switch
System Contact         : support@garrettcom.com
System Location        : Fremont, CA
System Objectld        : 1.3.6.1.4.1.553.12.6
System Serial No.      : 43576812
Original Factory Config Code : 6K25-8TP
```

**Magnum 6K25#**

**FIGURE 41** – Display the serial number, factory code and other relevant setup information

## List of commands in this chapter

*Syntax* **set bootmode type=<dhcp | bootp | manual | auto> [bootimg=<enable | disable>] [bootcfg=<enable | disable>]** – assign the boot mode for the switch

Where

**<dhcp | bootp | manual | auto>** - where

**dhcp** – look only for DHCP servers on the network for the IP address. Disable bootp or other modes

**bootp** – look only for bootp servers on the network. Disable dhcp or other mode

**manual** – do not set the IP address automatically

**auto** - the switch will first look for a DHCP server. If a DHCP server is not found, it will then look for a BootP server. If that server is not found, the switch will check to see if the switch had a pre-configured IP address. If it did, the switch would be assigned that IP address. If the switch did not have a pre-configured IP address, it would inspect if the IP address 192.168.1.2 with a netmask of 255.255.255.0 is free. If the IP address is free, MNS-6K will assign the switch that IP address. If the address is not free, MNS-6K will poll the network for DHCP server then BootP server then check if the IP address 192.68.1.2 is freed up

**bootimg=<enable | disable>** - valid with type=bootp only. Allows the switch to load the image file from the BootP server. This is useful when a new switch is put on a network and the IT policies are set to load only a specific MNS-6K image which is supported and tested by IT personnel.

**bootcfg=<enable | disable>** - valid with type=bootp only. Allows the switch to load the configuration file from the BootP server. This is useful when a new switch is put on a network and the specific configurations are loaded from a centralized BootP server

*Syntax* **telnet <enable | disable>** - enables or disables telnet sessions

*Syntax* **telnet <ipaddress> [port=<port number>]** – telnet from the switch

*Syntax* **set serial [baud=<rate>] [data=<5 | 6 | 7 | 8>] [parity=<none | odd | even>] [stop=<1 | 1.5 | 2>] [flowctrl=<none | xonxoff>]** – sets serial port parameters

*Syntax* **snmp** – enter the snmp configuration mode

*Syntax* **setvar [sysname | syscontact | syslocation]=<string>** - sets the system name, contact and location information

*Syntax* **set timezone GMT=[+ or -] hour=<0-14> min=<0-59>** - sets the timezone

*Syntax* **set date year=<2001-2035> month=<1-12> day=<1-31> [format=<mmddyyyy | ddmmyyyy | yyyyymmdd>]** – sets the date and the format in which the date is displayed



*Syntax* **set time hour=<0-23> min=<0-59> sec=<0-59> [zone=GMT[+/-]hh:mm]** – sets the time (as well as the timezone)

*Syntax* **set timeformat format=<12|24>** - sets the display time in the 12/24 hour mode

*Syntax* **set daylight country=<country name>** - sets the daylight saving time

*Syntax* **setsntp server = <ipaddress> timeout = <1-10> retry = <1-3>** - setup the SNTP server

*Syntax* **sync [hour=<0-24>] [min=<0-59>]** – setup the frequency at which the SNTP server is queried

*Syntax* **sntp [enable | disable]** – enables or disables the SNTP services

*Syntax* **saveconf mode=<serial | tftp | ftp> [<ipaddress>] [file=<name>]** – saves the configuration on the network using tftp, ftp or serial protocols

*Syntax* **loadconf mode=<serial | tftp | ftp> [<ipaddress>] [file=<name>]** – loads the previously saved configuration from the network using tftp, ftp or serial protocols

*Syntax* **kill config [save=module\_name]** – resets the system configuration. The *module\_name* option does not reset the specific module parameters. The modules are *system*, *event*, *port*, *bridge*, *stp*, *ps*, *mirror*, *sntp*, *vlan*, *grp* and *snmp*

*Syntax* **show session** – display telnet sessions active on the switch

*Syntax* **kill session id=<session>** - kill a specific telnet session

*Syntax* **set ftp mode=<normal | passive>** - set the ftp mode of operation

*Syntax* **show ftp**- display the current ftp operation mode

*Syntax* **ftp <get | put | list | del> [type=<app | config | oldconf | script | hosts | log>] [host=<hostname>] [ip=<ipaddress>] [file=<filename>] [user=<user>] [pass=<password>]** – upload and download information using ftp command

Where

**<get | put | list | del>** - different ftp operations

**[type=<app | config | oldconf | script | hosts | log>]** – optional type field. This is useful to specify whether a log file or host file is uploaded or downloaded. This can also perform the task of exporting a configuration file or uploading a new image to the switch

**[host=<hostname>] [ip=<ipaddress>] [file=<filename>] [user=<user>] [pass=<password>]** – parameters associated with ftp server for proper communications with the server

*Syntax* **tftp** <get | put> [type=<app | config | oldconf | script | hosts | log>]  
 [host=<hostname>] [ip=<ipaddress>] [file=<filename>] – *upload and download information using tftp command*

Where

<get | put> - different tftp operations – get a file from the server or put the information on the server

[type=<app | config | oldconf | script | hosts | log>] – optional type field. This is useful to specify whether a log file or host file is uploaded or downloaded. This can also perform the task of exporting a configuration file or uploading a new image to the switch

[host=<hostname>] [ip=<ipaddress>] [file=<filename>] – parameters associated with tftp server for proper communications with the server

*Syntax* **xmodem** <get | put> [type=<app | config | oldconf | script | hosts | log>] – *upload and download information using xmodem command and console connection*

Where

<get | put> - different xmodem file transfer operations – get a file from the server or put the information on the server

[type=<app | config | oldconf | script | hosts | log>] – optional type field. This is useful to specify whether a log file or host file is uploaded or downloaded. This can also perform the task of exporting a configuration file or uploading a new image to the switch

*Syntax* **host** <add|edit|del> name=<host-name> [ip=<ipaddress>] [user=<user>]  
 [pass=<password>] – *create a host entry for accessing host. This is equivalent to creating a host table on many systems. Maximum of 10 such entries are allowed*

*Syntax* **show host** – *displays the host table entries*

*Syntax* **climode** <script|console|show> - *set the interactive CLI mode on (console) or off (script). To see the mode – use the show option*

*Syntax* **more** <enable | disable | show> - *enable or disable the scrolling of lines one page at a time*

*Syntax* **show config** [module=<module-name>] – *displays the configuration*

## Other commands

*Syntax* **configure access** – *sets the access parameters (e.g. disable telnet session)*

*Syntax* **show ipconfig** – shows IP parameters set

*Syntax* **show console** – reviews console settings

*Syntax* **show serial** – reviews serial settings

*Syntax* **show setup** – reviews system parameters

*Syntax* **show sysconfig** – reviews settable system parameters

*Syntax* **show time** – shows the system time

*Syntax* **show timezone** – shows the system timezone

*Syntax* **show date** – shows the system date

*Syntax* **show uptime** – shows the amount of time the switch has been operational

*Syntax* **show setup** – display the setup, serial number, factory code information and more

## 4 – IPv6

### *Next generation IP addressing*

**T**his section explains how the access to the GarrettCom Magnum MNS-6K can setup using IPv6 instead of IPv4 addressing described earlier. IPv6 provides a much larger address space and is required today by many.

#### Assumptions



It is assumed here that the user is familiar with IP addressing schemes and has other supplemental material on IPv6, configuration, routing, setup and other items related to IPv6. This user guide does not dwell or probe those details.

## Introduction to IPv6

IPv6 is short for "Internet Protocol Version 6". IPv6 is the "next generation" protocol or IPng and was recommended to the IETF to replace the current version Internet Protocol, IP Version 4 ("IPv4"). IPv6 was recommended by the IPv6 (or IPng) Area Directors of the Internet Engineering Task Force at the Toronto IETF meeting on July 25, 1994 in RFC 1752, The Recommendation for the IP Next Generation Protocol. The recommendation was approved by the Internet Engineering Steering Group and made a proposed standard on November 17, 1994. The core set of IPv6 protocols were made an IETF draft standard on August 10, 1998.

IPv6 is a new version of IP which is designed to be an evolutionary step from IPv4. It is a natural increment to IPv4. It can be installed as a normal software upgrade in internet devices and is interoperable with the current IPv4. Its deployment strategy is designed to not have any dependencies. IPv6 is designed to run well on high performance networks (e.g. Gigabit Ethernet, OC-12, ATM, etc.) and at the same time still be efficient for low bandwidth networks (e.g. wireless). In addition, it provides a platform for new internet functionality that will be required in the near future.

IPv6 includes a transition mechanism which is designed to allow users to adopt and deploy IPv6 in a highly diffuse fashion and to provide direct interoperability between IPv4

and IPv6 hosts. The transition to a new version of the Internet Protocol is normally incremental, with few or no critical interdependencies. Most of today's internet uses IPv4, which is now nearly twenty years old. IPv4 has been remarkably resilient in spite of its age, but it is beginning to have problems. Most importantly, there is a growing shortage of IPv4 addresses, which are needed by all new machines added to the Internet.

IPv6 fixes a number of problems in IPv4, such as the limited number of available IPv4 addresses. It also adds many improvements to IPv4 in areas such as routing and network auto configuration. IPv6 is expected to gradually replace IPv4, with the two coexisting for a number of years during a transition period.

## What's changed in IPV6?

The changes from IPv4 to IPv6 fall primarily into the following categories:

- Expanded Routing and Addressing Capabilities – IPv6 increases the IP address size from 32 bits to 128 bits, to support more levels of addressing hierarchy and a much greater number of addressable nodes, and simpler auto-configuration of addresses. The scalability of multicast routing is improved by adding a "scope" field to multicast addresses.
- A new type of address called a "anycast address" is defined, to identify sets of nodes where a packet sent to an anycast address is delivered to one of the nodes. The use of anycast addresses in the IPv6 source route allows nodes to control the path which their traffic flows.
- Header Format Simplification - Some IPv4 header fields have been dropped or made optional, to reduce the common-case processing cost of packet handling and to keep the bandwidth cost of the IPv6 header as low as possible despite the increased size of the addresses. Even though the IPv6 addresses are four time longer than the IPv4 addresses, the IPv6 header is only twice the size of the IPv4 header.
- Improved Support for Options - Changes in the way IP header options are encoded allows for more efficient forwarding, less stringent limits on the length of options, and greater flexibility for introducing new options in the future.
- Quality-of-Service Capabilities - A new capability is added to enable the labeling of packets belonging to particular traffic "flows" for which the sender requests special handling, such as non-default quality of service or "real-time" service.
- Authentication and Privacy Capabilities - IPv6 includes the definition of extensions which provide support for authentication, data integrity, and confidentiality. This is included as a basic element of IPv6 and will be included in all implementations.

## IPv6 Addressing

IPv6 addresses are 128-bits long and are identifiers for individual interfaces and sets of interfaces. IPv6 addresses of all types are assigned to interfaces, not nodes. Since each interface belongs to a single node, any of that node's interfaces' unicast addresses may be used as an identifier for the node. A single interface may be assigned multiple IPv6 addresses of any type.

There are three types of IPv6 addresses. These are unicast, anycast, and multicast. Unicast addresses identify a single interface. Anycast addresses identify a set of interfaces such that a packet sent to an anycast address will be delivered to one member of the set. Multicast addresses identify a group of interfaces, such that a packet sent to a multicast address is delivered to all of the interfaces in the group. There are no broadcast addresses in IPv6, their function being superseded by multicast addresses.

IPv6 supports addresses which are four times the number of bits as IPv4 addresses (128 vs. 32). This is 4 Billion times 4 Billion times 4 Billion ( $2^{96}$ ) times the size of the IPv4 address space ( $2^{32}$ ). This works out to be:

340,282,366,920,938,463,463,374,607,431,768,211,456

This is an extremely large address space. In a theoretical sense this is approximately 665,570,793,348,866,943,898,599 addresses per square meter of the surface of the planet Earth (assuming the earth surface is 511,263,971,197,990 square meters). In the most pessimistic estimate this would provide 1,564 addresses for each square meter of the surface of the planet Earth. The optimistic estimate would allow for 3,911,873,538,269,506,102 addresses for each square meter of the surface of the planet Earth. Approximately fifteen percent of the address space is initially allocated. The remaining 85% is reserved for future use.

The details on the addressing are covered by numerous articles on the WWW as well as other literature and are not covered here.

## Configuring IPv6

The commands used for IPv6 are the same as those used for IPv4. Some of the commands will be discussed in more details later. The only exception is the 'ping' command where there is a special command for IPv6. That command is 'ping6' and the syntax is as

*Syntax* **ping6** <IPv6 address> - pings an IPv6 station

There is also a special command to ping the status of IPv6. That command is

*Syntax* **show ipv6** - displays the IPv6 information

To configure IPv6, the following sequence of commands can be used.

```

Magnum 6K25# ipconfig ?
ipconfig : Configures the system IP address, subnet mask and gateway

Usage
ipconfig [ip=<ipaddress>] [mask=<subnet-mask>] [dgw=<gateway>]

Magnum 6K25# ipconfig ip=fe80::220:6ff:fe25:ed80 mask=ffff:ffff:ffff:ffff::

Action Parameter Missing. "add" assumed.
IPv6 Parameters Set.
Magnum 6K25# show ipv6

IPv6 Address : fe80::220:6ff:fe25:ed80 mask : ffff:ffff:ffff:ffff::

Magnum 6K25# show ipconfig

IP Address      : 192.168.5.5
Subnet Mask     : 255.255.255.0
Gateway Address : 192.168.5.1
IPv6 Address    : fe80::220:6ff:fe25:ed80 mask : ffff:ffff:ffff:ffff::
IPv6 Gateway    : ::

Magnum 6K25#

```

FIGURE 42 – *Configuring IPv6*

In addition to the commands listed above, the commands which support IPv6 addressing are

*Syntax* **ftp <IPv6 address>** - *ftp to an IPv6 station*

*Example* – **ftp fe80::220:6ff:fe25:ed80**

*Syntax* **telnet <IPv6 address>** - *telnet to an IPv6 station*

*Example* – **telnet fe80::220:6ff:fe25:ed80**

Besides, if the end station supports IPv6 addressing (as most Linux and Windows systems do), one can access the switch using the IPv6 addressing as shown in the example below

**http://fe80::220:6ff:fe25:ed80**

## List of commands in this chapter

*Syntax* **ipconfig [ip=<ip-address>] [mask=<subnet-mask>] [dgw=<gateway>] [add | del]** – *configure and IPv6 address. The add/delete option can be used to add or delete IPv4/IPv6 addresses*

*Syntax* **show ipconfig** – *display the IP configuration information – including IPv6 address*

*Syntax* **ping6** <IPv6 address> - pings an IPv6 station

*Syntax* **show ipv6** - displays the IPv6 information

*Syntax* **ftp** <IPv6 address> - ftp to an IPv6 station

*Syntax* **telnet** <IPv6 address> - telnet to an IPv6 station



## 5 – Access Considerations

*Securing the switch access...*

**T**his section explains how the access to the GarrettCom Magnum MNS-6K can be secured. Further security considerations are also covered such as securing access by IP address or MAC address.



### Securing access

It is assumed here that the user is familiar with issues concerning security as well as securing access for users and computers on a network. Secure access on a network can be provided by authenticating against an allowed MAC address as well as IP address.

## Passwords

Magnum 6K family of switches comes with a factory default password for the manager as well as the operator account. Passwords can be changed from the user id by using the command **'set password'** command.

*Syntax* **set password**

Example

```
Magnum6K25# set password
Enter New Password :*****
Confirm New Password :*****
Password has been modified successfully
Magnum6K25#
```

**FIGURE 43** – *Changing password for a given account*

Other details on managing users and the passwords are covered in [Chapter 2, User Management](#).

# Port Security

The port security feature can be used to block computers from accessing the network by requiring the port to validate the MAC address against a known list of MAC addresses. This port security feature is provided on an Ethernet, Fast Ethernet, or Gigabit Ethernet port. In case of a security violation, the port can be configured to go into the **disable mode** or **drop mode**. The disable mode disables the port, not allowing any traffic to pass through. The drop mode allows the port to remain enabled during a security violation and drop only packets that are coming in from insecure hosts. This is useful when there are other network devices connected to the Magnum 6K family of switches. If there is an insecure access on the secondary device, the Magnum 6K family of switches allows the authorized users to continue to access the network; the unauthorized packets are dropped preventing access to the network.



## Network security

Network security hinges on the ability to allow or deny access to network resources. The access control aspect of secure network services involves allowing or disallowing traffic based on information contained in packets, such as the IP address, MAC address, or other content. Planning for access is a key architecture and design consideration. For example, which ports are configured for port security? Normally rooms with public access e.g. lobby, conference rooms etc. should be configured with port security. Once that is decided, the next few decisions are – who are the authorized and unauthorized users? What action should be taken against authorized as well as unauthorized users? How are the users identified as authorized or unauthorized?

## Configuring Port Security

Login as a level 2 user or as a manager to configure port security. Once logged in, get to the port-security configuration level to setup and configure port security.

*Syntax* **configure port-security**

**Or**

*Syntax* **port-security**

For example

```
Magnum6K25# configure port-security
```

```
Magnum6K25(port-security)##
```

FIGURE 44 – Port security configuration mode

Alternately, the following commands can also be used to enter the port-security configuration mode:

**Magnum6K25# port-security**

**Magnum6K25(port-security)##**

FIGURE 45 – Port security configuration mode

From the port-security configuration mode, the switch can be configured to:

- 1) Auto-learn the MAC addresses
- 2) Specify individual MAC addresses to allow access to the network
- 3) Validate or change the settings

The commands for doing the above actions are:

*Syntax* **allow mac**=<address | list | range> **port**=<num | list | range>

*Syntax* **learn port**=<number-list> <enable | disable>

*Syntax* **show port-security**

*Syntax* **action port**=<num | list | range> <none | disable | drop>

*Syntax* **signal port**=<num | list | range> <none | log | trap | logandtrap>

*Syntax* **ps** <enable | disable>

*Syntax* **remove mac**=<all | address | list | range> **port**=<num | list | range>

*Syntax* **signal port**=<num | list | range> <none | log | trap | logandtrap>

Where

**allow mac** – configures the switch to setup allowed MAC addresses on specific ports

**learn port** – configures the switch to learn the MAC addresses associated with specific port or a group of ports

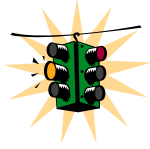
**show port-security** – shows the information on port security programmed or learnt

**action port** – specifies the designated action to take in case of a non authorized access

**ps – port security** – allows port security to be enable or disabled

**remove mac** – removes specific or all MAC addresses from port security lookup

**signal port**=<num | list | range> - observe list of specified ports and notify if there is a security breach on the list of port specified. The signal can be a log entry, a trap to the trap receiver specified as part of the SNMP commands (where is that specified) or both



**Note 1:** There is a limitation of 200 MAC addresses per port and 500 MAC addresses per Switch for Port Security.

**Note 2:** All the commands listed above have to be executed under the port-security configuration mode.

*Syntax* `clear <history | log [1..5 | informational | activity | critical | fatal | debug] | terminal | arp | portstats | addr` – clear command to clear various aspects of the MNS-6K information – most notably clear `addr` – clears the addresses learnt

Let's look at a few examples.

```
Magnum6K25(port-security)## allow mac=00:c1:00:7f:ec:00,00:60:b0:88:9e:00
                             port=18
```

**FIGURE 46** – Port security – allowing specific MAC addresses on a specified port. (No spaces between specified MAC addresses)

```
Magnum6K25(port-security)## action port=9,10 none
Magnum6K25(port-security)## learn port=9,10 enable
```

**FIGURE 47** – Port security - the port learns the MAC addresses. Note – a maximum of 200 MAC addresses can be learnt per port and a maximum of 500 per switch. Also, the 'action' on the port must be set to none before the port 'learns' the MAC address information.

```
Magnum6K25(port-security)## ps enable
Port Security is already enabled
Magnum6K25(port-security)## ps disable
Port Security Disabled
Magnum6K25(port-security)## ps enable
Port Security Enabled
```

**FIGURE 48** – Enabling and disabling port security

```
Magnum6K25(port-security)## show port-security
```

| PORT  | STATE  | SIGNAL | ACTION | LEARN  | COUNT | MAC ADDRESS  |
|-------|--------|--------|--------|--------|-------|--|
| ----- | -----  | -----  | -----  | -----  | ----- | -----  |
| 9     | ENABLE | LOG    | NONE   | ENABLE | 6     | 00:e0:29:2a:f1:bd<br>00:01:03:e2:27:89<br>00:07:50:ef:31:40<br>00:e0:29:22:15:85<br>00:03:47:ca:ac:45<br>00:30:48:70:71:23 |

|    |        |      |      |         |   |                |
|----|--------|------|------|---------|---|----------------|
| 10 | ENABLE | NONE | NONE | DISABLE | 0 | Not Configured |
| 11 | ENABLE | NONE | NONE | DISABLE | 0 | Not Configured |
| 12 | ENABLE | NONE | NONE | DISABLE | 0 | Not Configured |
| 13 | ENABLE | NONE | NONE | DISABLE | 0 | Not Configured |
| 14 | ENABLE | NONE | NONE | DISABLE | 0 | Not Configured |
| 15 | ENABLE | NONE | NONE | DISABLE | 0 | Not Configured |
| 16 | ENABLE | NONE | NONE | DISABLE | 0 | Not Configured |

**Magnum6K25(port-security)##**

**FIGURE 49** – Viewing port security settings on a switch. On port 9, learning is enabled. This port has 6 stations connected to it with the MAC addresses as shown. Other ports have learning disabled and the MAC addresses are not configured on those ports

**Magnum6K25(port-security)## learn port=11 enable**  
Port Learning Enabled on selected port(s)

**Magnum6K25(port-security)## show port-security**

| PORT | STATE  | SIGNAL | ACTION | LEARN   | COUNT | MAC ADDRESS  |
|------|--------|--------|--------|---------|-------|--|
| 9    | ENABLE | LOG    | NONE   | ENABLE  | 6     | 00:e0:29:2a:f1:bd<br>00:01:03:e2:27:89<br>00:07:50:ef:31:40<br>00:e0:29:22:15:85<br>00:03:47:ca:ac:45<br>00:30:48:70:71:23 |
| 10   | ENABLE | NONE   | NONE   | DISABLE | 0     | Not Configured   |
| 11   | ENABLE | NONE   | NONE   | ENABLE  | 0     | Not Configured   |
| 12   | ENABLE | NONE   | NONE   | DISABLE | 0     | Not Configured   |
| 13   | ENABLE | NONE   | NONE   | DISABLE | 0     | Not Configured   |
| 14   | ENABLE | NONE   | NONE   | DISABLE | 0     | Not Configured   |
| 15   | ENABLE | NONE   | NONE   | DISABLE | 0     | Not Configured   |
| 16   | ENABLE | NONE   | NONE   | DISABLE | 0     | Not Configured   |

**Magnum6K25(port-security)##**

**FIGURE 50** – Enabling learning on a port. Note – after the learning is enabled, the port security can be queried to find the status of MAC addresses learnt. If there were machines connected to this port, the MAC address would be shown on port 11 as they are shown on port 9

**Magnum6K25(port-security)## allow mac=00:c1:00:7f:ec:00 port=9,11,13**

Specified MAC address(es) allowed on selected port(s)

**Magnum6K25(port-security)## show port-security port=9,11,13**

| PORT | STATE  | SIGNAL | ACTION | LEARN  | COUNT | MAC ADDRESS       |
|------|--------|--------|--------|--------|-------|-------------------|
| 9    | ENABLE | LOG    | NONE   | ENABLE | 6     | 00:e0:29:2a:f1:bd |

|    |        |      |      |         |   |                   |
|----|--------|------|------|---------|---|-------------------|
|    |        |      |      |         |   | 00:01:03:e2:27:89 |
|    |        |      |      |         |   | 00:07:50:ef:31:40 |
|    |        |      |      |         |   | 00:e0:29:22:15:85 |
|    |        |      |      |         |   | 00:03:47:ca:ac:45 |
|    |        |      |      |         |   | 00:30:48:70:71:23 |
|    |        |      |      |         |   | 00:c1:00:7f:ec:00 |
| 11 | ENABLE | NONE | NONE | ENABLE  | 0 | 00:c1:00:7f:ec:00 |
| 13 | ENABLE | NONE | NONE | DISABLE | 0 | 00:c1:00:7f:ec:00 |

**FIGURE 51** – Allowing specific MAC address on specific ports. After the MAC address is specified, the port or specific ports or a range of ports can be queried as shown

```

Magnum6K25(port-security)## remove mac=00:c1:00:7f:ec:00 port=13

Specified MAC address(es) removed from selected port(s)

Magnum6K25(port-security)## show port-security port=13

```

| PORT | STATE  | SIGNAL | ACTION | LEARN  | COUNT | MAC ADDRESS    |
|------|--------|--------|--------|--------|-------|----------------|
| 13   | ENABLE | LOG    | NONE   | ENABLE | 0     | Not Configured |

```

Magnum6K25(port-security)##

```

**FIGURE 52** – Removing a MAC address from port security

```

Magnum6K25(port-security)## signal port=11 logandtrap

Port security Signal type set to Log and Trap on selected port(s)

```

**FIGURE 53** – Setting the logging on a port

The figures listed above show the necessary commands to setup port security. The recommended steps to setup security are:

- 1) Set the MNS-6K software to allow port security commands (Use **'port-security'** command)
- 2) Enable port security (Use **'enable ps'** command)
- 3) Enable learning on the required ports (Use **'learn port=11 enable'** command for port 11)
- 4) Verify learning is enables and MAC addresses are being learnt on required ports (Use **'show port-security port=11'** command)
- 5) Save the port-security configuration (Use **'save'** command)
- 6) Disable learning on required ports (Use **'learn port=11,15 disable'** command)
- 7) (Optional step) Add any specific MAC addresses, if needed, to allow designated devices to access the network (Use **'add mac=00:c1:00:7f:ec:00 port=11,15'** command)

- 8) Disable access to the network for unauthorized devices (Use **'action port=11 <diabie|drop>'** depending on whether the port should be disabled or the packed dropped. Follow that with a **'show port-security'** command to verify the setting)
- 9) (Optional step) Set the notification to notify the management station on security breach attempts (Use command **'signal port'** to make a log entry or send a trap)

**Magnum6K25# port-security**

**Magnum6K25(port-security)## ps enable**

Port Security is already enabled

**Magnum6K25(port-security)## learn port=11 enable**

Port Learning Enabled on selected port(s)

**Magnum6K25(port-security)## show port-security**

| PORT | STATE  | SIGNAL | ACTION | LEARN   | COUNT | MAC ADDRESS  |
|------|--------|--------|--------|---------|-------|--|
| 9    | ENABLE | LOG    | NONE   | ENABLE  | 6     | 00:e0:29:2a:f1:bd<br>00:01:03:e2:27:89<br>00:07:50:ef:31:40<br>00:e0:29:22:15:85<br>00:03:47:ca:ac:45<br>00:30:48:70:71:23 |
| 10   | ENABLE | NONE   | NONE   | DISABLE | 0     | Not Configured   |
| 11   | ENABLE | NONE   | NONE   | ENABLE  | 0     | 00:c1:00:7f:ec:00  |
| 12   | ENABLE | NONE   | NONE   | DISABLE | 0     | Not Configured   |
| 13   | ENABLE | NONE   | NONE   | DISABLE | 0     | Not Configured   |
| 14   | ENABLE | NONE   | NONE   | DISABLE | 0     | Not Configured   |
| 15   | ENABLE | NONE   | NONE   | DISABLE | 0     | Not Configured   |
| 16   | ENABLE | NONE   | NONE   | DISABLE | 0     | Not Configured   |

**Magnum6K25(port-security)## save**

Saving current configuration

Configuration saved

**Magnum6K25(port-security)## learn port=11 disable**

Port Learning Disabled on selected port(s)

**Magnum6K25(port-security)## action port=11 drop**

Port security Action type set to Drop on selected port(s)

**Magnum6K25(port-security)## show port-security port=11**

| PORT | STATE  | SIGNAL | ACTION | LEARN   | COUNT | MAC ADDRESS       |
|------|--------|--------|--------|---------|-------|-------------------|
| 11   | ENABLE | NONE   | DROP   | DISABLE | 0     | 00:c1:00:7f:ec:00 |

**Magnum6K25(port-security)## signal port=11 logandtrap**

Port security Signal type set to Log and Trap on selected port(s)

**Magnum6K25(port-security)## exit**

**Magnum6K25#****FIGURE 54** – *Steps for setting up port security on a specific port*

Once port security is setup, it is important to manage the log and review the log often. If the signals are sent to the trap receiver, the traps should also be reviewed for intrusion and other infractions.

## Logs

All events occurring on the Magnum 6K family of switches are logged. The events can be as shown below

| Code | Description   |
|------|---|
| 0    | <b>Emergency:</b> system is unusable – called “fatal” in show log command           |
| 1    | <b>Alert:</b> action must be taken immediately                                      |
| 2    | <b>Critical:</b> critical conditions  |
| 3    | <b>Error:</b> error conditions  |
| 4    | <b>Warning:</b> warning conditions  |
| 5    | <b>Notice:</b> normal but significant condition – called “note” in show log command |
| 6    | <b>Informational:</b> informational messages  |
| 7    | <b>Debug:</b> debug-level messages  |

A few point to note about logs

- By default, the logging is limited to the first six levels
- The event log is now automatically saved to flash, so rebooting will not loose them. NOTE – since the event logs are written on the flash, once the flash memory is full, the logs stop writing. It is important to erase the log periodically or use syslog capability to download the logs to a syslog server
- The event log now includes more information, because of the additional flexibility built into the log engine. For example, it now logs the IP address and user name of a remote user login
- The log size parameter is now redefined as the max size of the log that is saved to flash. More events might appear in the log as they happen, but the whole list will be trimmed to the specified max size when a save command is issued, or the system rebooted.

These logs are in compliance with the definitions of RFC 3164, though not all the nuances of the syslog are implemented as specified by the RFC.



The **'show log'** command displays the log information and the **'clear log'** command clears the log entries.

*Syntax* **show log [fatal | alert | crit | error | warn | note | info | debug]** – *display the log*

*Syntax* **clear log [fatal | alert | crit | error | warn | note | info | debug]**– *clear the log*

*Syntax* **set logsize size=<1-1000>** - *set the number of line to be collected in the log before the oldest record is re-written*

Magnum6K25# **show log**

| S    | Date       | Time         | Log Description                                   |
|------|------------|--------------|---|
| --   | -----      | -----        | -----   |
| Note | 04-17-2007 | 09:57:27 P.M | CLI:Session Timed Out for User manager on Telnet: |
| Note | 04-17-2007 | 09:57:27 P.M | CLI:Session Term. User manager on Telnet:         |
| Note | 04-17-2007 | 10:00:06 P.M | CLI:Session Started from Telnet: 192.168.5.2      |
| Note | 04-17-2007 | 10:00:12 P.M | CLI:User manager Login From Telnet: 192.168.5.2   |
| Note | 04-17-2007 | 10:08:58 P.M | CLI:User manager Logout From Telnet: 192.168.5.2  |
| Note | 04-17-2007 | 10:08:58 P.M | CLI:Session Term. User manager on Telnet:         |
| Note | 01-01-2001 | 12:00:00 A.M | SYSMGR:System Was Rebooted By power cycle         |
| Note | 01-01-2001 | 12:00:00 A.M | SNTP:System Clock Set to Default                  |
| Note | 01-01-2001 | 12:01:32 A.M | WEB:Session Started from SWM: 192.168.5.2         |
| Note | 01-01-2001 | 12:01:47 A.M | WEB:User manager Login From SWM: 192.168.5.2      |
| Note | 01-01-2001 | 12:04:16 A.M | SYSMGR:Loaded Application Ver 3.7                 |
| Note | 01-01-2001 | 12:00:00 A.M | SYSMGR:System Was Rebooted By HW Watchdog         |
| Note | 01-01-2001 | 12:00:00 A.M | SNTP:System Clock Set to Default                  |
| Note | 01-01-2001 | 12:01:13 A.M | WEB:Session Started from SWM: 192.168.5.2         |
| Note | 01-01-2001 | 12:01:25 A.M | WEB:User manager Login From SWM: 192.168.5.2      |
| Note | 04-23-2007 | 09:57:01 A.M | SNTP:System Time Zone Set to -08:00               |
| Note | 04-23-2007 | 05:59:02 P.M | SNTP:SNTP Client Started                          |
| Note | 04-23-2007 | 05:59:09 P.M | SNTP:SNTP Time Synchronized                       |
| Note | 04-23-2007 | 05:59:10 P.M | SNTP:SNTP Time Synchronized                       |
| Note | 04-23-2007 | 05:59:36 P.M | CLI:Session Started from Telnet: 192.168.5.2      |
| Note | 04-23-2007 | 05:59:39 P.M | SNTP:SNTP Time Synchronized                       |
| Note | 04-23-2007 | 05:59:40 P.M | SNTP:SNTP Time Synchronized                       |
| Note | 04-23-2007 | 05:59:49 P.M | CLI:User manager Login From Telnet: 192.168.5.2   |
| Note | 04-23-2007 | 06:11:32 P.M | CLI:Session Timed Out for User manager on Telnet: |
| Note | 04-23-2007 | 06:11:32 P.M | CLI:Session Term. User manager on Telnet:         |
| Note | 04-23-2007 | 06:18:05 P.M | CLI:Session Started from Telnet: 192.168.5.2      |
| Note | 04-23-2007 | 06:18:16 P.M | CLI:User manager Login From Telnet: 192.168.5.2   |

Magnum6K25# **clear log**

Clear Logged Events? ['Y' or 'N'] **Y**

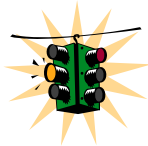
Magnum6K25# **show log**

Magnum6K25#

**FIGURE 55** – *Show log and clear log command. The show log command indicates the type of log activity in the S column*

The log shows the most recent intrusion at the top of the listing. If the log is filled when the switch detects a new intrusion, the oldest entry is dropped off the listing.

As discussed in the prior section, any port can be set to monitor security as well as make a log on the intrusions that take place. The logs for the intrusions are stored on the switch. When the switch detects an intrusion on a port, it sets an “alert flag” for that port and makes the intrusion information available.



The default log size is 50 rows. To change the log size, use the “**set logsize**” command.

When the switch detects an intrusion attempt on a port, it records the date and time stamp, the MAC address, the port on which the access was attempted and the action taken by MNS-6K software. The event log lists the most recently detected security violation attempts. This provides a chronological entry of all intrusions attempted on a specific port.

The event log records events as single-line entries listed in chronological order, and serves as a tool for isolating problems. Each event log entry is composed of four fields

**Severity** – the level of severity (see below)

**Date** – date the event occurred on. See Chapter 3 on setting the [date and time](#) on the switch

**Time** – time the event occurred on. See Chapter 3 on setting the [date and time](#) on the switch

**Log Description** – description of event as detected by the switch

*Severity* is one of 8 severities described at the beginning of this section.

## Authorized managers

Just as port security allows and disallows specific MAC addresses from accessing a network, the MNS-6K software can allow or block specific IP addresses or a range of IP addresses to access the switch. The command used for that is

*Syntax* **access** – *access configuration mode*

*Syntax* **allow** **ip**=<ipaddress> **mask**=<netmask> **service**=<name | list> - *authorize managers*

*Syntax* **deny** **ip**=<ipaddress> **mask**=<netmask> **service**=<name | list> - *deny access to a specific IP address(s) or a subnet*

*Syntax* **remove ip=<ipaddress> mask=<netmask>** - *remove specific IP address(s) or subnet*

*Syntax* **removeall** - *remove all managers*

*Syntax* **show ip-access** - *display list of authorized managers*

**access** – context are the access commands

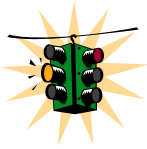
**allow** – allow specified services for specified IP addresses – IP addresses can be individual stations, a group of stations or subnets. The range is determined by the IP address and netmask settings

**deny** – deny specified services for specified IP addresses – IP addresses can be individual stations, a group of stations or subnets. The range is determined by the IP address and netmask settings

**remove** – eliminate specified entry from the authorized manager list

**removeall** – remove all authorized managers

**service** – the services allowed or denied are telnet, web and SNMP



It is assumed here that the user is familiar with IP addressing schemes (e.g. Class A, B, C etc.), subnet masking and masking issues such as how many stations are allowed for a given subnet mask.

In the examples – any computer on 192.168.5.0 network is allowed (note how the subnet mask is used to indicate that). Also a specific station with IP address 192.168.15.25 is allowed (again note how the subnet mask is used to allow only one specific station in the network.) Older station with IP address 192.168.15.15 is removed.

```
Magnum6K25# access
```

```
Magnum6K25(access)## allow ip=192.168.5.0 mask=255.255.255.0 service=telnet
```

Service(s) allowed for specified address

```
Magnum6K25(access)## allow ip=192.168.15.25 mask=255.255.255.255 service=telnet
```

Service(s) allowed for specified address

```
Magnum6K25(access)## remove ip=192.168.15.15 mask=255.255.255.255
```

Access entry removed

```
Magnum6K25(access)## exit
```

| Magnum6K25# show ip-access |                 |         |        |        |  |
|----------------------------|-----------------|---------|--------|--------|--|
| IP Address                 | Mask            | Telnet  | Web    | SNMP   |  |
| 192.168.5.0                | 255.255.255.0   | ALLOWED | DENIED | DENIED |  |
| 192.168.15.25              | 255.255.255.255 | ALLOWED | DENIED | DENIED |  |

FIGURE 56 – Steps to allow deny or remove specific services

## List of commands in this chapter

*Syntax* **set password** – set or change password

*Syntax* **configure port-security** – sets the port authorization based on MAC addresses

*Syntax* **port-security** – configure port security settings

*Syntax* **allow mac=<address | list | range> port=<num | list | range>** - specify a specific MAC address or MAC address list

*Syntax* **learn port=<number-list> <enable | disable>** - learn MAC addresses connected to the Magnum 6K switch

*Syntax* **show port-security** – display port security settings

*Syntax* **action port=<num | list | range> <none | disable | drop>** - action to perform in case of breach of port security

*Syntax* **signal port=<num | list | range> <none | log | trap | logandtrap>** - port to monitor and signal to send in case of breach of port security

*Syntax* **ps <enable | disable>** - enable or disable port security

*Syntax* **remove mac=<all | address | list | range> port=<num | list | range>** - remove a MAC address entry

*Syntax* **show log [fatal | alert | crit | error | warn | note | info | debug]** – display logs and specific types of logs

*Syntax* **clear log [fatal | alert | crit | error | warn | note | info | debug]** – clear logs or specific type of logs

*Syntax* **set logsize size=<1-1000>** - set the log buffer size

*Syntax* **access** – setup access configuration parameters

*Syntax* **allow ip=<ipaddress> mask=<netmask> service=<name | list>** - allow specific IP address or range of addresses as a trusted host(s)

*Syntax* **deny ip=<ipaddress> mask=<netmask> service=<name | list>** - deny specific IP address or range of IP addresses

*Syntax* **remove ip=<ipaddress> mask=<netmask>** - delete a specific IP address from the access or trusted host list

*Syntax* **removeall** – *remove all IP addresses of trusted hosts*

*Syntax* **show ip-access** – *display all trusted hosts*

*Syntax* **clear <history | log [1.5 | informational | activity | critical | fatal | debug] | terminal | arp | portstats | addr]** – *clear command to clear various aspects of the MNS-6K information – most notably “clear addr” – clears the addresses learnt or “clear log” to clear the logs (and the type of logs)*

## 6 – Access Using RADIUS

*Using a RADIUS server to authenticate access...*

The IEEE 802.1x standard, *Port Based Network Access Control*, defines a mechanism for port-based network access control that makes use of the physical access characteristics of IEEE 802 LAN infrastructure. It provides a means of authenticating and authorizing devices attached to LAN ports that have point-to-point connection characteristics. It also prevents access to that port in cases where the authentication and authorization fails. Although 802.1x is mostly used in wireless networks, this protocol is also implemented in LANs. The Magnum 6K family of switches implements the authenticator, which is a major component of 802.1x.



### RADIUS

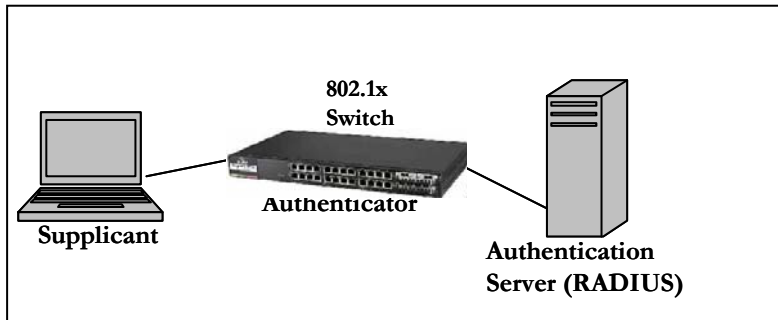
**R**emote **A**uthentication **D**ial-**I**n **U**ser **S**ervice or RADIUS is a server that has been traditionally used by many Internet Service Providers (ISP) as well as Enterprises to authenticate dial in users. Today, many businesses use the RADIUS server for authenticating users connecting into a network. For example, if a user connects a PC into the network, whether the PC should be allowed access or not provides the same issues as to whether or not a dial in user should be allowed access into the network or not. A user has to provide a user name and password for authenticated access. A RADIUS server is well suited for controlling access into a network by managing the users who can access the network on a RADIUS server. Interacting with the server and taking corrective action(s) is not possible on all switches. This capability is provided on the Magnum 6K family of switches.

RADIUS servers and its uses are also described by one or more RFCs.

## 802.1x

There are three major components of 802.1x: - Supplicant, Authenticator and Authentication Server (RADIUS Server). In the figure below, the PC acts as the supplicant. The supplicant is an entity being authenticated and desiring access to the services. The switch is the authenticator. The authenticator enforces authentication before

allowing access to services that are accessible via that port. The authenticator is responsible for communication with the supplicant and for submitting the information received from the supplicant to a suitable authentication server. This allows the verification of user credentials to determine the consequent port authorization state. It is important to note that the authenticator's functionality is independent of the actual authentication method. It effectively acts as a pass-through for the authentication exchange.



**FIGURE 57** – *802.1x network components*

The RADIUS server is the authentication server. The authentication server provides a standard way of providing Authentication, Authorization, and Accounting services to a network. Extensible Authentication Protocol (EAP) is an authentication framework which supports multiple authentication methods. EAP typically runs directly over data link layers such as PPP or IEEE 802, without requiring IP. EAP over LAN (EAPOL) encapsulates EAP packets onto 802 frames with a few extensions to handle 802 characteristics. EAP over RADIUS encapsulates EAP packets onto RADIUS packets for relaying to RADIUS authentication servers.

The details of the 802.1x authentication are shown below

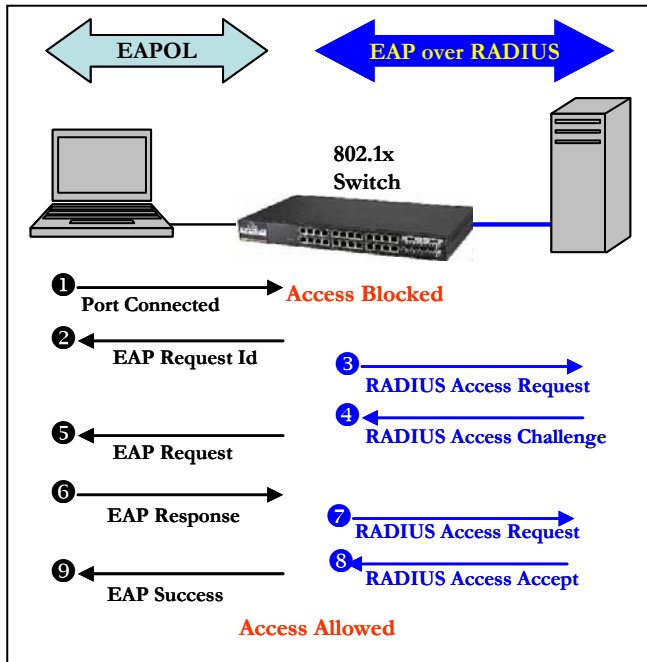


FIGURE 58 – 802.1x authentication details

1. The supplicant (laptop/host) is initially blocked from accessing the network. The supplicant wanting to access these services starts with an EAPOL-Start frame
2. The authenticator (Magnum 6K switch), upon receiving an EAPOL-start frame, sends a response with an EAP-Request/Identity frame back to the supplicant. This will inform the supplicant to provide its identity
3. The supplicant then sends back its own identification using an EAP-Response/Identity frame to the authenticator (Magnum 6K switch.) The authenticator then relays this to the authentication server by encapsulating the EAP frame on a RADIUS-Access-Request packet
4. The RADIUS server will then send the authenticator a RADIUS-Access-Challenge packet
5. The authenticator (Magnum 6K switch) will relay this challenge to the supplicant using an EAP-Request frame. This will request the supplicant to pass its credentials for authentication
6. The supplicant will send its credentials using an EAP-Response packet
7. The authenticator will relay using a RADIUS-Access-Request packet
8. If the supplicant's credentials are valid, RADIUS-Access-Accept packet is sent to the authenticator
9. The authenticator will then relay this on as an EAP-Success and provides access to the network
10. If the supplicant does not have the necessary credentials, a RADIUS-Access-Deny packet is sent back and relayed to the supplicant as an EAP-Failure frame. The access to the network continues to be blocked



The Magnum MNS-6K software implements the 802.1x authenticator. It fully conforms to the standards as described in IEEE 802.1x, implementing all the state machines needed for port-based authentication. The Magnum MNS-6K Software authenticator supports both EAPOL and EAP over RADIUS to communicate to a standard 802.1x supplicant and RADIUS authentication server.

The Magnum MNS-6K software authenticator has the following characteristics:

- Allows control on ports using STP-based hardware functions. EAPOL frames are Spanning Tree Protocol (STP) link Bridge PDUs (BPDU) with its own bridge multicast address.
- Relays MD5 challenge (although not limited to) authentication protocol to RADIUS server
- Limits the authentication of a single host per port
- The Magnum 6K family of switches provides the IEEE 802.1x MIB for SNMP management

## Configuring 802.1x

On enabling 802.1x ports, make sure the port which connects to the RADIUS servers needs to be manually authenticated. To authenticate the port, use the “**setport**” command. The CLI commands to configure and perform authentication with a RADIUS server are

*Syntax* **auth** - configuration mode to configure the 802.1x parameters

*Syntax* **show auth <config | ports>** - show the 802.1x configuration or port status

*Syntax* **authserver [ip=<ip-addr>] [udp=<num>] [secret=<string>]** - define the RADIUS server – use UDP socket number if the RADIUS authentication is on port other than 1812

*Syntax* **auth <enable | disable>** - enables or disables the 802.1x authenticator function on MNS-6K switch

*Syntax* **setport port=<num | list | range> [status=<enable | disable>] [control=<auto | forceauth | forceunauth>] [initialize=<assert | deassert>]** - setting the port characteristic for an 802.1x network

*Syntax* **backend port=<num | list | range> supptimeout=<1-240> [servertimeout=<1-240>] [maxreq=<1-10>]** - configure parameters for EAP over RADIUS

**port** – [mandatory] – port(s) to be configured

**supptimeout** – [optional] This is the timeout in seconds the authenticator waits for the supplicant to respond back. Default value is 30 seconds. Values can range from 1 to 240 seconds.

**servertimeout** – [optional] This is the timeout in seconds the authenticator waits for the backend RADIUS server to respond back. The default value is 30 seconds. Values can range from 1 to 240 seconds.

**maxreq** – [optional] The maximum number of times the authenticator will retransmit an EAP Request packet to the Supplicant before it times out the authentication session. Its default value is 2. It can be set to any integer value from 1 to 10.

*Syntax* **portaccess port=<num | list | range> [quiet=<0-65535>] [maxreauth=<0-10>] [transmit=<1-65535>]** - set port access parameters for authenticating PCs or supplicants

**port** – [mandatory] – ports to be configured

**quiet** – [optional] This is the quiet period, the amount of time, in seconds, the supplicant is held after an authentication failure before the authenticator retries the supplicant for connection. The default value is 60 seconds. Values can range from 0 to 65535 seconds.

**maxreauth** – [optional] The number of re-authentication attempts that are permitted before the port becomes unauthorized. Default value is 2. Values are integers and can range from 0 to 10.

**transmit** – [optional] This is the transmit period, this is the time in seconds the authenticator waits to transmit another request for identification from the supplicant. Default value is 30. Values can be from 1 to 65535 seconds

*Syntax* **reauth port=<num | list | range> [status=<enable | disable>] [period=<10-86400>]** - set values on how the authenticator (Magnum 6K switch) does the re-authentication with the supplicant or PC

**port** – [mandatory] – ports to be configured

**status** – [optional] This enables/disables re-authentication

**period** – [optional] this is the re-authentication period in seconds. This is the time the authenticator waits before a re-authentication process will be done again to the supplicant. Default value is 3600 seconds (1 hour). Values can range from 10 to 86400 seconds.

*Syntax* **show-stats port=<num>** - displays 802.1x related statistics

*Syntax* **trigger-reauth port=<num | list | range>** - manually initiate a re-authentication of supplicant

```

Magnum6K25# show auth config
802.1X Authenticator Configuration
=====
Status          : Disabled
RADIUS Authentication Server
=====
IP Address      : 0.0.0.0
UDP Port       : 1812
Shared Secret   :

Magnum6K25# auth

Magnum6K25(auth)## setport port=2 status=enable control=forceauth initialize=assert

Successfully set port control parameter(s)

```

*Make sure there is no 802.1x or Radius server defined. Note only one RADIUS server can be defined for the whole network.*

*The RADIUS server is on port #2. This port is authenticated manually. If the RADIUS server is several hops away, it may be necessary to authenticate the interconnection ports. Note make sure this command is executed before auth enable command.*

**Magnum6K25(auth)## auth disable**  
802.1X Authenticator is disabled.

*This command is not necessary, however is shown for completeness in case there was a RADIUS server defined and a previously set authentication scheme*

**Magnum6K25(auth)## authserver ip=192.168.1.239 secret=secret**

Successfully set RADIUS Authentication Server parameter(s)

**Magnum6K25(auth)##auth enable**

*Enable the authentication*

802.1X Authenticator is enabled.

**Magnum6K25(auth)## show auth ports**

| Port                  | Status  | Control    | Initialize | Current State |
|-----------------------|---------|------------|------------|---------------|
| 1                     | Enabled | Auto       | Deasserted | Authorized    |
| 2                     | Enabled | ForcedAuth | Asserted   | Unauthorized  |
| 3                     | Enabled | Auto       | Deasserted | Authorized    |
| 4                     | Enabled | Auto       | Deasserted | Unauthorized  |
| 5                     | Enabled | Auto       | Deasserted | Unauthorized  |
| 6                     | Enabled | Auto       | Deasserted | Unauthorized  |
| 7                     | Enabled | Auto       | Deasserted | Unauthorized  |
| 8                     | Enabled | Auto       | Deasserted | Unauthorized  |
| 9                     | Enabled | Auto       | Deasserted | Unauthorized  |
| 10                    | Enabled | Auto       | Deasserted | Unauthorized  |
| 11                    | Enabled | Auto       | Deasserted | Unauthorized  |
| 12                    | Enabled | Auto       | Deasserted | Unauthorized  |
| 13                    | Enabled | Auto       | Deasserted | Unauthorized  |
| 14                    | Enabled | Auto       | Deasserted | Unauthorized  |
| 15                    | Enabled | Auto       | Deasserted | Unauthorized  |
| 16                    | Enabled | Auto       | Deasserted | Unauthorized  |
| -- Port not available |         |            |            |               |

*Port #2 is where RADIUS server is connected*

**Magnum6K25(auth)## show auth config**

*Command included for completeness – validate the RADIUS server settings*

802.1x Authenticator Configuration

=====  
Status : Enabled

RADIUS Authentication Server

=====  
IP Address : 192.168.1.239  
UDP Port : 1812  
Shared Secret : secret

**Magnum6K25(auth)## backend port=2 supptimeout=45 servertimeout=60 maxreq=5**

Successfully set backend server authentication parameter(s)

*Backend command is used for setting characteristics of the timeouts and number of requests before access is denied.*

**Magnum6K25(auth)## show-port backend**

| Port | Supp Timeout (sec) | Server Timeout (sec) | Max Request |
|------|--------------------|----------------------|-------------|
| 1    | 30                 | 30                   | 2           |
| 2    | 45                 | 60                   | 5           |
| 3    | 30                 | 30                   | 2           |
| 4    | 30                 | 30                   | 2           |
| 5    | 30                 | 30                   | 2           |
| 6    | 30                 | 30                   | 2           |
| 7    | 30                 | 30                   | 2           |
| 8    | 30                 | 30                   | 2           |
| 9    | 30                 | 30                   | 2           |
| 10   | 30                 | 30                   | 2           |
| 11   | 30                 | 30                   | 2           |
| 12   | 30                 | 30                   | 2           |
| 13   | 30                 | 30                   | 2           |
| 14   | 30                 | 30                   | 2           |
| 15   | 30                 | 30                   | 2           |
| 16   | 30                 | 30                   | 2           |

The authenticator waits for the supplicant to respond back for 45 seconds; the authenticator waits for 60 seconds for the backend RADIUS server to respond back and the authenticator will retransmit an EAP request packet 5 times to the Supplicant before it times out the authentication session

**Magnum6K25(auth)## portaccess port=2 quiet=120 maxreauth=7 transmit=120**

Successfully set port access parameter(s)

**Magnum6K25(auth)## show-port access**

| Port | Quiet Period (sec) | Max Reauth (sec) | Tx Period |
|------|--------------------|------------------|-----------|
| 1    | 60                 | 2                | 30        |
| 2    | 120                | 7                | 120       |
| 3    | 60                 | 2                | 30        |
| 4    | 60                 | 2                | 30        |
| 5    | 60                 | 2                | 30        |
| 6    | 60                 | 2                | 30        |
| 7    | 60                 | 2                | 30        |
| 8    | 60                 | 2                | 30        |
| 9    | 60                 | 2                | 30        |
| 10   | 60                 | 2                | 30        |
| 11   | 60                 | 2                | 30        |
| 12   | 60                 | 2                | 30        |
| 13   | 60                 | 2                | 30        |
| 14   | 60                 | 2                | 30        |
| 15   | 60                 | 2                | 30        |
| 16   | 60                 | 2                | 30        |

The amount of time, in seconds, the supplicant is held after an authentication failure before the authenticator retries the supplicant for connection is changed to 120 seconds, the number of re-authentication attempts that are permitted before the Port becomes Unauthorized is set to 7 and the time in seconds the authenticator waits to transmit another request for identification from the supplicant is changed to 120 seconds. These values can be changed on all ports depending on devices being authenticated.

**Magnum6K25(auth)## reauth port=1 status=enable period=300**

Successfully set re-authentication parameter(s)

Force the authentication period on port #1 every 5 minutes – all other ports are force authenticated every hour as the show-port reauth command shows.

**Magnum6K25(auth)## show-port reauth**

| Port | Reauth Status | Reauth Period (sec) |
|------|---------------|---------------------|
| 1    | Enabled       | 300                 |
| 2    | Enabled       | 3600                |
| 3    | Enabled       | 3600                |
| 4    | Enabled       | 3600                |
| 5    | Enabled       | 3600                |
| 6    | Enabled       | 3600                |
| 7    | Enabled       | 3600                |
| 8    | Enabled       | 3600                |
| 9    | Enabled       | 3600                |
| 10   | Enabled       | 3600                |
| 11   | Enabled       | 3600                |
| 12   | Enabled       | 3600                |
| 13   | Enabled       | 3600                |
| 14   | Enabled       | 3600                |
| 15   | Enabled       | 3600                |
| 16   | Enabled       | 3600                |

**Magnum6K25(auth)## show-stats port=3**

|                                      |     |
|--------------------------------------|-----|
| Port 3 Authentication Counters       |     |
| authEntersConnecting                 | : 3 |
| authEapLogoffsWhileConnecting        | : 0 |
| authEntersAuthenticating             | : 3 |
| authAuthSuccessesWhileAuthenticating | : 2 |
| authAuthTimeoutsWhileAuthenticating  | : 0 |
| authAuthFailWhileAuthenticating      | : 0 |
| authAuthReauthsWhileAuthenticating   | : 0 |
| authAuthEapStartsWhileAuthenticating | : 1 |
| authAuthEapLogoffWhileAuthenticating | : 0 |
| authAuthReauthsWhileAuthenticated    | : 0 |
| authAuthEapStartsWhileAuthenticated  | : 0 |
| authAuthEapLogoffWhileAuthenticated  | : 0 |
| backendResponses                     | : 5 |
| backendAccessChallenges              | : 2 |
| backendOtherRequestsToSupplicant     | : 0 |
| backendNonNakResponsesFromSupplicant | : 2 |
| backendAuthSuccesses                 | : 2 |
| backendAuthFails                     | : 0 |

**Magnum6K25(auth)## trigger-reauth port=3**

Successfully triggered re-authentication

See [Figure 47](#) for meaning of these statistics.

Force re-authentication on port #3.

**FIGURE 59** – securing the network using port access

## List of commands in this chapter

*Syntax* **auth** - configuration mode to configure the 802.1x parameters

*Syntax* **show auth <config | ports>** - show the 802.1x configuration or port status

*Syntax* **authserver [ip=<ip-addr>] [udp=<num>] [secret=<string>]** - define the RADIUS server – use UDP socket number if the RADIUS authentication is on port other than 1812

*Syntax* **auth <enable | disable>** - enables or disables the 802.1x authenticator function on MNS-6K switch

*Syntax* **setport port=<num | list | range> [status=<enable | disable>] [control=<auto | forceauth | forceunauth>] [initialize=<assert | deassert>]** - setting the port characteristic for an 802.1x network

*Syntax* **backend port=<num | list | range> supptimeout=<1-240> [servertimeout=<1-240>] [maxreq=<1-10>]** - configure parameters for EAP over RADIUS

**port** – [mandatory] – port(s) to be configured

**supptimeout** – [optional] This is the timeout in seconds the authenticator waits for the supplicant to respond back. Default value is 30 seconds. Values can range from 1 to 240 seconds.

**servertimeout** – [optional] This is the timeout in seconds the authenticator waits for the backend RADIUS server to respond back. The default value is 30 seconds. Values can range from 1 to 240 seconds.

**maxreq** – [optional] The maximum number of times the authenticator will retransmit an EAP Request packet to the Supplicant before it times out the authentication session. Its default value is 2. It can be set to any integer value from 1 to 10.

*Syntax* **portaccess port=<num | list | range> [quiet=<0-65535>] [maxreauth=<0-10>] [transmit=<1-65535>]** - set port access parameters for authenticating PCs or supplicants

**port** – [mandatory] – ports to be configured

**quiet** – [optional] This is the quiet period, the amount of time, in seconds, the supplicant is held after an authentication failure before the authenticator retries the supplicant for connection. The default value is 60 seconds. Values can range from 0 to 65535 seconds.

**maxreauth** – [optional] The number of re-authentication attempts that are permitted before the port becomes unauthorized. Default value is 2. Values are integers and can range from 0 to 10.

**transmit** – [optional] This is the transmit period, this is the time in seconds the authenticator waits to transmit another request for identification from the supplicant. Default value is 30. Values can be from 1 to 65535 seconds

*Syntax* **reauth port=<num | list | range> [status=<enable | disable>] [period=<10-86400>]** -  
*set values on how the authenticator (Magnum 6K switch) does the re-authentication with the supplicant or PC*

**port** – [mandatory] – ports to be configured

**status** – [optional] This enables/disables re-authentication

**period** – [optional] this is the re-authentication period in seconds. This is the time the authenticator waits before a re-authentication process will be done again to the supplicant. Default value is 3600 seconds (1 hour). Values can range from 10 to 86400 seconds.

*Syntax* **show-stats port=<num>** - *displays 802.1x related statistics*

*Syntax* **trigger-reauth port=<num | list | range>** - *manually initiate a re-authentication of supplicant*

## 7 – Access Using TACACS+

*Using a TACACS+ server to authenticate access....*

**T**ACACS+, short for Terminal Access Controller Access Control System, protocol provides access control for routers, network access servers and other networked computing devices via one or more centralized servers. TACACS+ provides separate authentication, authorization and accounting services.



### TACACS – flavors and history

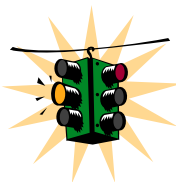
TACACS allows a client to accept a username and password and send a query to a TACACS authentication server, sometimes called a TACACS daemon (server) or simply TACACSD. This server was normally a program running on a host.

The host would determine whether to accept or deny the request and sent a response back.

The TACACS+ protocol is the latest generation of TACACS. TACACS is a simple UDP based access control protocol originally developed by BBN for the MILNET (Military Network). Cisco's enhancements to TACACS are called XTACACS. XTACACS is now replaced by TACACS+. TACACS+ is a TCP based access control protocol. TCP offers a reliable connection-oriented transport, while UDP offers best-effort delivery.

TACACS+ improves on TACACS and XTACACS by separating the functions of authentication, authorization and accounting and by encrypting all traffic between the Network Access Server (NAS) and the TACACS+ clients or services or daemon. It allows for arbitrary length and content authentication exchanges, which allows any authentication mechanism to be utilized with TACACS+ clients. The protocol allows the TACACS+ client to request very fine-grained access control by responding to each component of a request.

The Magnum 6K family of switches implements a TACACS+ client.

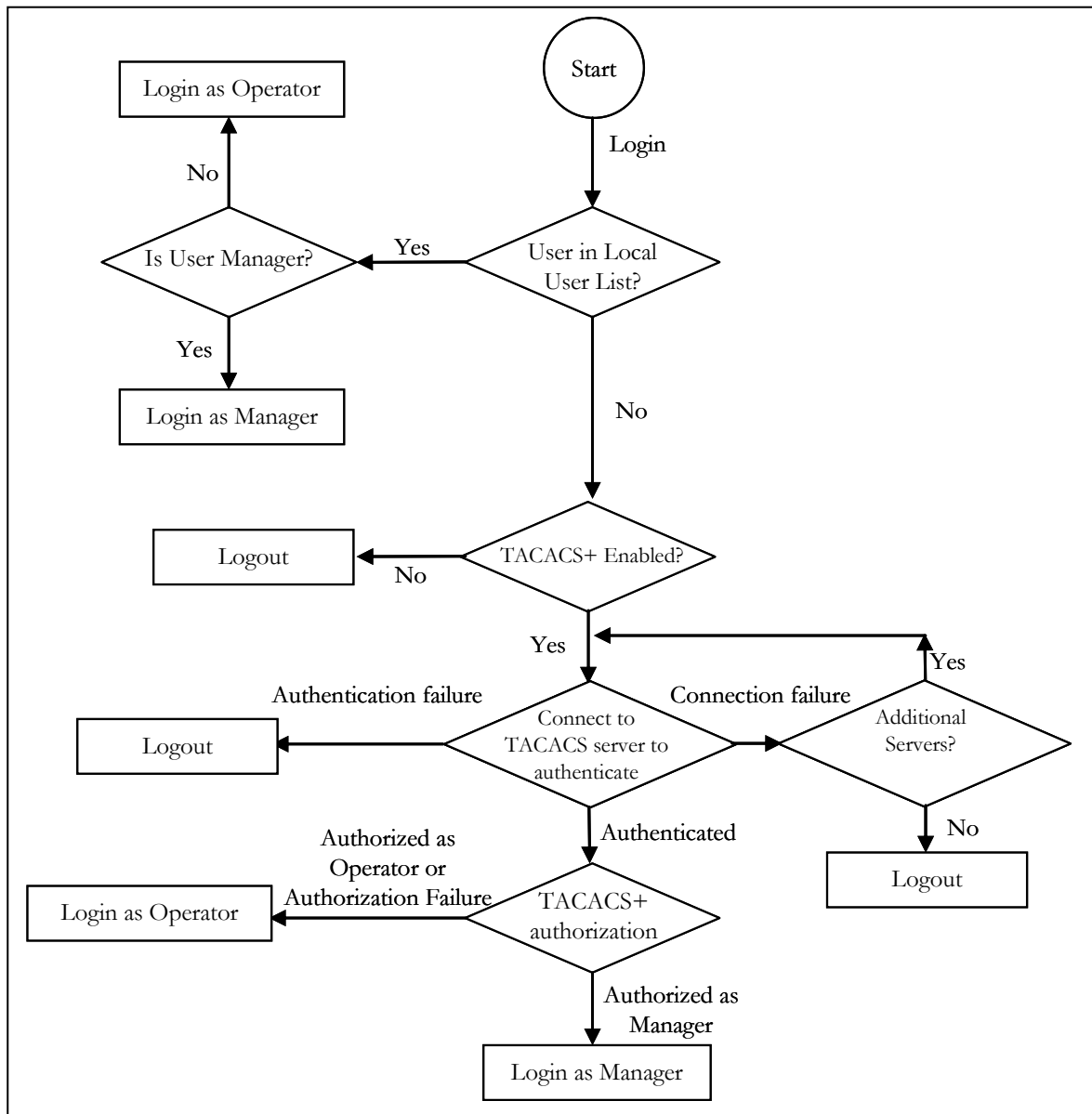


1. TACACS+ servers and daemons use TCP Port 49 for listening to client requests. Clients connect to this port number to send authentication and authorization packets.
2. There can be more than one TACACS+ server on the network. MNS-6K supports a maximum of five TACACS+ servers



## TACACS+ Flow

TACACS works in conjunction with the local user list on the MNS-6K software (operating system.) Please refer to [User Management](#) for adding users on the MNS-6K software. The process of authentication as well as authorization is shown in the flow chart below.



**FIGURE 60** – Flow chart describing the interaction between local users and TACACS authorization

The above flow diagram shows the tight integration of TACACS+ authentication with the local user-based authentication. There are two stages a user goes through in TACACS+. The first stage

is authentication where the user is verified against the network user database. The second stage is authorization, where it is determined whether the user has operator access or manager privileges.

## TACACS+ Packet

Packet encryption is a supported and is a configurable option for the Magnum MNS-6K software. When encrypted, all authentication and authorization TACACS+ packets are encrypted and are not readable by protocol capture and sniffing devices such as EtherReal or others. Packet data is hashed and shared using MD5 and secret string defined between the Magnum 6K family of switches and the TACACS+ server.

|               |               |             |              |        |
|---------------|---------------|-------------|--------------|--------|
| 32 bits wide  |               |             |              |        |
| 4             | 4             | 8           | 8            | 8 bits |
| Major Version | Minor Version | Packet type | Sequence no. | Flags  |
| Session ID    |               |             |              |        |
| Length        |               |             |              |        |

**FIGURE 61** – TACACS packet format

- Major Version – The major TACACS+ version number.
- Minor version – The minor TACACS+ version number. This is intended to allow revisions to the TACACS+ protocol while maintaining backwards compatibility
- Packet type – Possible values are
  - TAC\_PLUS\_AUTHEN:= 0x01 (Authentication)
  - TAC\_PLUS\_AUTHOR:= 0x02 (Authorization)
  - TAC\_PLUS\_ACCT:= 0x03 (Accounting)
- Sequence number – The sequence number of the current packet for the current session
- Flags – This field contains various flags in the form of bitmaps. The flag values signify whether the packet is encrypted
- Session ID – The ID for this TACACS+ session
- Length - The total length of the TACACS+ packet body (not including the header)

## Configuring TACACS+

CLI commands to configure TACACS+ are

*Syntax* **show tacplus <status | servers>** - show status of TACACS or servers configured as TACACS+ servers

*Syntax* **tacplus <enable | disable> [ order=<tac,local | local,tac>]** - enable or disable TACACS authentication, specifying the order in which the server or local database is looked up where "tac,local" implies, first the TACAS+ server, then local logins on the device. Default order is Local then TACACS+ server.

*Syntax* **tacserver <add | delete> id=<num> [ip=<ip-addr>] [port=<tcp-port>] [encrypt=<enable | disable>] [key=<string>] [mgrlevel=<level>] [oprlevel=<level>]** - adds a list of up to five TACACS+ servers where

**<add | delete>** - [mandatory] adds or delete a TACACS+ server.

**id=<num>** - [mandatory] the order in which the TACACS+ servers should be polled for authentication

**[ip=<ip-addr>]** - [mandatory for add] the IP address of the TACACS+ server

**[port=<tcp-port>]** - [optional for add] TCP port number on which the server is listening

**[encrypt=<enable | disable>]** - [optional for add] enable or disable packet encryption

**[key=<string>]** - [optional for add, mandatory with encrypt] when encryption is enabled, the secret shared key string must be supplied

**[mgrlevel=<level>]** and **[oprlevel=<level>]** - [optional] specifies the manager and operator level as defined on the TACACS+ server for the respective level of login

Magnum6K25# **show tacplus servers**

| ID | TACACS+ Server | Port | Encrypt | Key    |
|----|----------------|------|---------|--------|
| 1  | 10.21.1.170    | 49   | Enabled | secret |
| 2  | --             | --   | --      | --     |
| 3  | --             | --   | --      | --     |
| 4  | --             | --   | --      | --     |
| 5  | --             | --   | --      | --     |

This command works in the user configuration mode as well. Note - maximum of five TACACS+ servers.

Magnum6K25# **user**

To configure TACACS+ enter the user configuration mode

Magnum6K25(user)##

Magnum6K25(user)## **show tacplus status**

TACACS+ Status : Disabled

Check the status of TACACS+ authentication. Note - this command was run in the user configuration mode.

Magnum6K25(user)## **tacplus disable**

TACACS+ Tunneling is disabled.

Magnum6K25(user)## **tacserver add id=2 ip=10.21.1.123 encrypt=enable key=some**

TACACS+ server is added.

Magnum6K25(user)## **show tacplus servers**

| ID | TACACS+ Server | Port | Encrypt | Key    |
|----|----------------|------|---------|--------|
| 1  | 10.21.1.170    | 49   | Enabled | secret |
| 2  | 10.21.1.123    | 49   | Enabled | some   |
| 3  | --             | --   | --      | --     |
| 4  | --             | --   | --      | --     |
| 5  | --             | --   | --      | --     |

**Magnum6K25(user)## tacserver delete id=2**

TACACS+ server is deleted.

**Magnum6K25(user)## show tacplus servers**

| ID | TACACS+ Server | Port | Encrypt | Key    |
|----|----------------|------|---------|--------|
| 1  | 10.21.1.170    | 49   | Enabled | secret |
| 2  | --             | --   | --      | --     |
| 3  | --             | --   | --      | --     |
| 4  | --             | --   | --      | --     |
| 5  | --             | --   | --      | --     |

**Magnum6K25(user)## tacplus enable**

TACACS+ is enabled.

**Magnum6K25(user)##**

FIGURE 62 – Configuring TACACS+

## List of commands in this chapter

*Syntax* **show tacplus <status | servers>** - show status of TACACS or servers configured as TACACS+ servers

*Syntax* **tacplus <enable | disable> [ order=<tac,local | local,tac>]** - enable or disable TACACS authentication, specifying the order in which the server or local database is looked up where “tac,local” implies, first the TACAS+ server, then local logins on the device

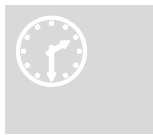
*Syntax* **tacserver <add | delete> id=<num> [ip=<ip-addr>] [port=<tcp-port>] [encrypt=<enable | disable>] [key=<string>] [mgrlevel=<level>] [oprlevel=<level>]** – adds a list of up to five TACACS+ servers where  
**<add | delete>** – [mandatory] adds or delete a TACACS+ server.  
**id=<num>** – [mandatory] the order in which the TACACS+ servers should be polled for authentication  
**[ip=<ip-addr>]** – [mandatory for add] the IP address of the TACACS+ server

**[port=<tcp-port>]** – [optional for add] TCP port number on which the server is listening  
**[encrypt=<enable | disable>]** – [optional for add] enable or disable packet encryption  
**[key=<string>]** – [optional for add, mandatory with encrypt] when encryption is enabled, the secret shared key string must be supplied  
**[mgrlevel=<level>]** and **[oprlevel=<level>]** – [optional] specifies the manager and operator level as defined on the TACACS+ server for the respective level of login

## 8 – Port Mirroring and Setup

*Setup the ports for network speeds, performance as well as for monitoring....*

**T**his section explains how individual characteristics of a port on the GarrettCom Magnum 6K family of switches are setup. For monitoring a specific port, the traffic on a port can be mirrored on another port and viewed by protocol analyzers. Other setup includes automatically setting up broadcast storm prevention thresholds.



### Port monitoring and mirroring

An Ethernet switch sends traffic from one port to another port, unlike a hub or a shared network device, where the traffic is “broadcast” on each and every port. Capturing traffic for protocol analysis or intrusion analysis can be impossible on a switch unless all the traffic for a specific port is “reflected” on another port, typically a monitoring port. The Magnum 6K family of switches can be instructed to repeat the traffic from one port onto another port. This process - when traffic from one port is reflecting to another port - is called port mirroring. The monitoring port is also called a “sniffing” port. Port monitoring becomes critical for trouble shooting as well as for intrusion detection.

## Port mirroring

Monitoring a specific port can be done by port mirroring. Mirroring traffic from one port to another port allows analysis of the traffic on that port. The set of commands for port mirroring are

*Syntax* **show port-mirror** – *displays the status of port mirroring*

*Syntax* **port-mirror** - *enter the port mirror configuration mode*

*Syntax* **setport monitor=<monitor port number> sniffer=<sniffer port number>** - *setup a port mirrior port*

*Syntax* **prtmr <enable | disable>** - *enable and disable port mirroring*

The set of commands show how port 11 is mirrored on port 13. Any traffic on port 11 is also sent on port 13.

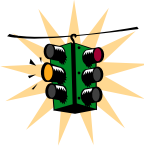
```

Magnum6K25# show port-mirror
Sniffer Port   : 0
Monitor Port   : 0
Mirroring State : disabled
Magnum6K25# port-mirror
Magnum6K25(port-mirror)## setport monitor=11 sniffer=13
Port 11 set as Monitor Port
Port 13 set as Sniffer Port
Magnum6K25(port-mirror)## prtmr enable
Port Mirroring Enabled
Magnum6K25(port-mirror)## exit
Magnum6K25# show port-mirror
Sniffer Port   : 13
Monitor Port   : 11
Mirroring State : enabled
Magnum6K25#

```

FIGURE 63 – Enabling port mirroring

Once port monitoring is completed, for security reasons, GarrettCom strongly recommends that the port mirroring be disabled using the “**prtmr disable**” command.



- 1) Only one port can be set to port mirror at a time
- 2) Both the ports (monitored port and sniffer port) have to belong to the same VLAN
- 3) The mirrored port shows both incoming as well as outgoing traffic
- 4) When port mirror is active, to change mirrored port, first disable port mirror and then assign the new port as described above

## Port setup

Each port on the GarrettCom Magnum 6K family of switches can be setup specific port characteristics. The command for setting the port characteristics are:

*Syntax* **device** – enter the device configuration mode

*Syntax* **setport port=<port# | list | range> [name=<name>] [speed=<10 | 100>] [duplex=<half | full>] [auto=<enable | disable>] [flow=<enable | disable>] [bp=<enable | disable>] [status=<enable | disable>]**

where

**device** – sets up the Magnum 6K switch in the device configuration mode

**name** – assigns a specific name to the port. This name is a designated name for the port and can be a server name, user name or any other name

**speed** – specifically sets the speed to be 10 or 100Mbps. Note – this works only with 10/100 ports – with 10Mbps ports, the option is ignored. No error is shown. See speed settings section below.

**flow** – sets up flow control on the port. See Flow Control section below

**bp** – back pressure – enables back pressure signaling for traffic congestion management

**status** – disable – disables the port from operation

*Syntax* **show port**[=<port number>]

In the example listed below, the ports 11 and 12 are given specific names. Ports 9 and 13 are active, as shown by the link status. Port 13 is set to 100 Mbps – all other ports are set to 10Mbps. All ports are set with auto sensing (speed)

```
Magnum6K25# device

Magnum6K25(device)## setport port=11 name=JohnDoe

Magnum6K25(device)## setport port=12 name=JaneDoe

Magnum6K25(device)## show port

Keys:   E = Enable           D = Disable
        H = Half Duplex    F = Full Duplex
        M = Multiple VLANs NA = Not Applicable
        LI = Listening      LE = Learning
        F = Forwarding     B = Blocking

Port Name  Control  Dplx  Media Link  Speed Part  Auto VlanID GVRP STP
-----
 9  B1      E       H   10Tx  UP    10  No    E    1    -    -
10  B2      E       H   10Tx  DOWN  10  No    E    1    -    -
11  JohnDoe E       H   10Tx  DOWN  10  No    E    1    -    -
12  JaneDoe E       H   10Tx  DOWN  10  No    E    1    -    -
13  B5      E       F  100Tx UP    100 No    E    1    -    -
14  B6      E       H   10Tx  DOWN  10  No    E    1    -    -
15  B7      E       H   10Tx  DOWN  10  No    E    1    -    -
16  B8      E       H   10Tx  DOWN  10  No    E    1    -    -

Magnum6K25(device)## exit
Magnum6K25#
```

FIGURE 64 – Port setup

The port's speed and duplex (data transfer operation) setting are summarized below.

## Speed settings

**Auto (default)** – Senses speed and negotiates with the port at the other end of the link for data transfer operation (half-duplex or full-duplex). “Auto” uses the IEEE 802.3u auto negotiation standard for 100Base-T networks. If the other device does not comply



with the 802.3u standard, then the port configuration on the switch must be manually set to match the port configuration on the other device.

Possible port setting combinations for copper ports are:

- 10HDx: 10 Mbps, Half-Duplex
- 10FDx: 10 Mbps, Full-Duplex
- 100HDx: 100 Mbps, Half-Duplex
- 100FDx: 100 Mbps, Full-Duplex

Possible port settings for 100FX (fiber) ports are:

- 100FDx (default): 100 Mbps, Full-Duplex
- 100HDx: 100 Mbps, Half-Duplex

Possible port settings for 10FL (fiber) ports are:

- 10HDx (default): 10 Mbps, Half-Duplex
- 10FDx: 10 Mbps, Full-Duplex

**Gigabit fiber-optic ports** (Gigabit-SX and Gigabit-LX):

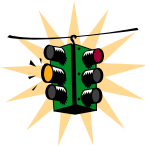
- 1000FDx (default): 1000 Mbps (1 GBPS), Full Duplex only
- **Auto:** The port operates at 1000FDx and auto-negotiates flow control with the device connected to the port

## Flow Control

Flow control is for full duplex operation and the controls provided indicates the number of buffers allowed for incoming traffic before a Rxon or Rxoff information is sent. RXon is sent when the number of buffers used by the traffic falls below the specified level (default is 4). Rxoff is sent when the number of buffers used goes above the specified value (default is 6). The "flowcontrol" command is used to set the above thresholds. It DOES NOT enable or DISABLE flow control

**Disabled (default)** – The port will not generate flow control packets and drops received flow control packets

**Enabled:** The port uses 802.3x Link Layer Flow Control, generates flow control packets, and processes received flow control packets.



With the port speed set to auto (the default) and flow control set to enabled; the switch negotiates flow control on the indicated port. If the port speed is not set to auto, or if flow control is disabled on the port, then flow control is not used.

To set flow control

*Syntax* **flowcontrol xonlimit=<value> xofflimit=<value>**

where

**xonlimit** can be from 3 to 30, default value is 4

**xofflimit** from 3 to 127, default value is 6

*Syntax* **show flowcontrol**

## Back Pressure

Back Pressure is for half duplex operations and the controls provided indicates the number of buffers allowed for incoming traffic before a xon/xoff message is sent.

**Disabled (default)** – The port will not use back pressure based flow control mechanisms.

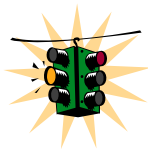
**Enabled** – The port uses 802.3 Layer 2 back off algorithms. Back pressure based congestion control is possible only on half-duplex, 10-Mbps Ethernet ports. Other technologies are not supported on Magnum 6K family of switches.

*Syntax* **backpressure rxthreshold=<value>**

where

**rxthreshold** value can be from 3 to 127, default is 28

*Syntax* **show backpressure**



are widely used today.

Backpressure and Flow control are to be used in networks in which all devices and switches can participate in the flow control and back pressure recognition. In most networks, these techniques are not used as not all devices can participate in the flow control methods and notifications. Alternately, QoS and other techniques

In the example below, the Magnum 6K family of switches are setup with flow control and back pressure.

```

Magnum6K25# device
Magnum6K25(device)## show flowcontrol
  XOnLimit : 4
  XOffLimit : 6
Magnum6K25(device)## flowcontrol xonlimit=10 xofflimit=15
  XOn Limit set successfully
  XOff Limit set successfully
Magnum6K25(device)## show flowcontrol
  XOnLimit : 10
  XOffLimit : 15
Magnum6K25(device)## show backpressure
  Rx Buffer Threshold : 28
Magnum6K25(device)## backpressure rxthreshold=45
  Rx Buffer Threshold set successfully
Magnum6K25(device)## show backpressure
  Rx Buffer Threshold : 45
Magnum6K25(device)## show port

Keys:   E = Enable           D = Disable
        H = Half Duplex     F = Full Duplex
        M = Multiple VLAN's NA = Not Applicable
        L = Listening        LE = Learning
        F = Forwarding      B = Blocking

Port Name  Control  Dplx  Media Link  Speed Part  Auto VlanID GVRP STP
-----
 9  B1     E      H    10Tx  UP    10  No    E    1    -    -
10  B2     E      H    10Tx  DOWN  10  No    E    1    -    -
11  JohnDoe E      H    10Tx  DOWN  10  No    E    1    -    -
12  JaneDoe E      H    10Tx  DOWN  10  No    E    1    -    -
13  B5     E      F   100Tx  UP    100 No    E    1    -    -
14  B6     E      H    10Tx  DOWN  10  No    E    1    -    -
15  B7     E      H    10Tx  DOWN  10  No    E    1    -    -
16  B8     E      H    10Tx  DOWN  10  No    E    1    -    -

Magnum6K25(device)## show port=11
Configuration details of port 11
-----
Port Name           : JohnDoe
Port Link State     : DOWN
Port Type           : TP Port
Port Admin State    : Enable
Port VLAN ID       : 1
Port Speed          : 10Mbps
Port Duplex Mode    : half-duplex
Port Auto-negotiation State : Enable
Port STP State      : NO STP
Port GVRP State     : No GVRP
Port Priority Type   : None
Port Security       : Enable
    
```

```

Port Flow Control      : Disable
Port Back Pressure    : Disable

Magnum6K25(device)## setport port=11 flow=enable bp=enable
Magnum6K25(device)## show port
Keys:   E = Enable           D = Disable
        H = Half Duplex      F = Full Duplex
        M = Multiple VLAN's  NA = Not Applicable
        LI = Listening         LE = Learning
        F = Forwarding       B = Blocking

Port Name  Control  Dplx  Media Link  Speed Part  Auto VlanID GVRP STP
-----
 9  B1      E       H   10Tx  UP    10  No    E    1    -    -
10  B2      E       H   10Tx  DOWN  10  No    E    1    -    -
11  JohnDoe E       H   10Tx  DOWN  10  No    E    1    -    -
12  JaneDoe E       H   10Tx  DOWN  10  No    E    1    -    -
13  B5      E       F  100Tx  UP    100 No    E    1    -    -
14  B6      E       H   10Tx  DOWN  10  No    E    1    -    -
15  B7      E       H   10Tx  DOWN  10  No    E    1    -    -
16  B8      E       H   10Tx  DOWN  10  No    E    1    -    -

Magnum6K25(device)## show port=11
Configuration details of port 11
-----
Port Name           : JohnDoe
Port Link State     : DOWN
Port Type           : TP Port
Port Admin State    : Enable
Port VLAN ID       : 1
Port Speed          : 10Mbps
Port Duplex Mode    : half-duplex
Port Auto-negotiation State : Enable
Port STP State      : NO STP
Port GVRP State     : No GVRP
Port Priority Type   : None
Port Security       : Enable
Port Flow Control   : Enable
Port Back Pressure  : Enable

Magnum6K25(device)## exit
Magnum6K25#
    
```

*Note – the flow control and back pressure is shown as enabled for the specific port. The global “show port” command does not show this detail. The back pressure and flow control parameters are global – i.e. the same for all the ports.*

FIGURE 65 – Setting up back pressure and flow control on ports



### Broadcast Storms

One of the best features of the Magnum 6K family of switches is its ability to keep broadcast storms from spreading throughout a network. Network storms (or broadcast storms) are characterized by an excessive number of broadcast packets being sent over the network. These storms can occur if network equipment is configured incorrectly or the network software is not properly functioning or badly designed programs (including some network games) are used. Storms can reduce network performance and cause bridges, routers, workstations, servers and PC's to slow down or even crash.

## Preventing broadcast storms

The Magnum 6K family of switches is capable of detecting and limiting storms on each port. A network administrator can also set the maximum rate of broadcast packets (frames) that are permitted from a particular interface. If the maximum number is exceeded, a storm condition is declared. Once it is determined that a storm is occurring on an interface, any additional broadcast packets received on that interface will be dropped until the storm is determined to be over. The storm is determined to be over when a one-second period elapses with no broadcast packets received.

*Syntax* **broadcast-protect** <enable | disable> - enable or disable the broadcast storm protection capabilities

*Syntax* **rate-threshold** port=<port | list | range> rate=<frames/sec> - set the rate limit in frames per second

*Syntax* **show broadcast-protect** – display the broadcast storm protection settings

In the example below, the broadcast protection is turned on. The threshold for port 11 is then set to a lower value of 3500 broadcast frames/second.

```

Magnum6K25# device
Magnum6K25(device)## show broadcast-protect
=====
PORT | STATUS | THRESHOLD (frms/sec) | CURR RATE (frms/sec) | ACTIVE
=====
  9   Disabled  19531                0                    NO
 10   Disabled  19531                0                    NO
 11   Disabled  19531                0                    NO
 12   Disabled  19531                0                    NO
 13   Disabled  19531                0                    NO
 14   Disabled  19531                0                    NO
 15   Disabled  19531                0                    NO
 16   Disabled  19531                0                    NO
Magnum6K25(device)## broadcast-protect enable
Broadcast Storm Protection enabled
Magnum6K25(device)## show broadcast-protect
=====
PORT | STATUS | THRESHOLD (frms/sec) | CURR RATE (frms/sec) | ACTIVE
=====
  9   Enabled  19531                0                    NO
 10   Enabled  19531                0                    NO
 11   Enabled  19531                0                    NO
 12   Enabled  19531                0                    NO
 13   Enabled  19531                0                    NO
 14   Enabled  19531                0                    NO
 15   Enabled  19531                0                    NO

```

```

16      Enabled      19531          0          NO
Magnum6K25(device)## rate-threshold port=11 rate=3500
Broadcast Rate Threshold set
Magnum6K25(device)## show broadcast-protect
=====
PORT | STATUS | THRESHOLD (frms/sec) | CURR RATE (frms/sec) | ACTIVE
=====
  9   Enabled   19531             0             NO
 10   Enabled   19531             0             NO
 11   Enabled   3500              0             NO
 12   Enabled   19531             0             NO
 13   Enabled   19531             0             NO
 14   Enabled   19531             0             NO
 15   Enabled   19531             0             NO
 16   Enabled   19531             0             NO

```

**FIGURE 66** – Setting up broadcast storm protection. Also shows how the threshold can be lowered for a specific port

## Port Rate limiting for broadcast traffic

Please refer to the above section on broadcast storms.

## List of commands in this chapter

*Syntax* **show port-mirror** – display port mirror settings

*Syntax* **port-mirror <enter>** - configure port mirror settings

*Syntax* **setport monitor=<monitor port number> sniffer=<sniffer port number>** - set port mirror settings

*Syntax* **prtmr <enable | disable>** - enable or disable port mirror settings

*Syntax* **device** – configure device and port specific settings

*Syntax* **setport port=<port# | list | range> [name=<name>] [speed=<10 | 100>] [duplex=<half | full>] [auto=<enable | disable>] [flow=<enable | disable>] [bp=<enable | disable>] [status=<enable | disable>]** – configure port settings

*Syntax* **show port[=<Port number>]** – display port settings

*Syntax* **flowcontrol xonlimit=<value> xofflimit=<value>** - configure flow control buffers

*Syntax* **show flowcontrol** – *display flow control buffers*

*Syntax* **backpressure rxthreshold=<value>** - *configure backpressure buffers*

*Syntax* **show backpressure** – *display backpressure buffers*

*Syntax* **broadcast-protect <enable | disable>** - *protect switch from broadcast storms*

*Syntax* **rate-threshold port=<port | list | range> rate=<frames/sec>** - *change the allowed broadcast rate threshold*

## 9 – VLAN

*Create separate network segments (collision domains) across Magnum 6K family of switches.....*

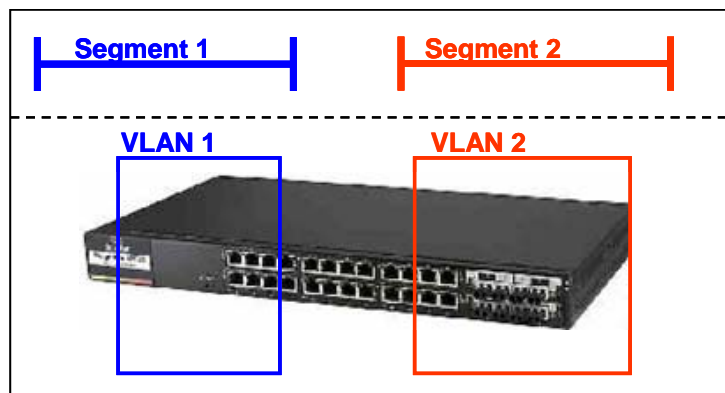
**S**hort for **virtual LAN (VLAN)**, a VLAN creates separate collision domains or network segments that can span multiple Magnum 6K family of switches. A VLAN is a group of ports designated by the switch as belonging to the same broadcast domain. The IEEE 802.1Q specification establishes a standard method for inserting VLAN membership information into Ethernet frames.



### Why VLANs?

VLAN's provide the capability of having two (or more) Ethernet segments co-exist on common hardware. The reason for creating multiple segments in Ethernet is to isolate collision domains.

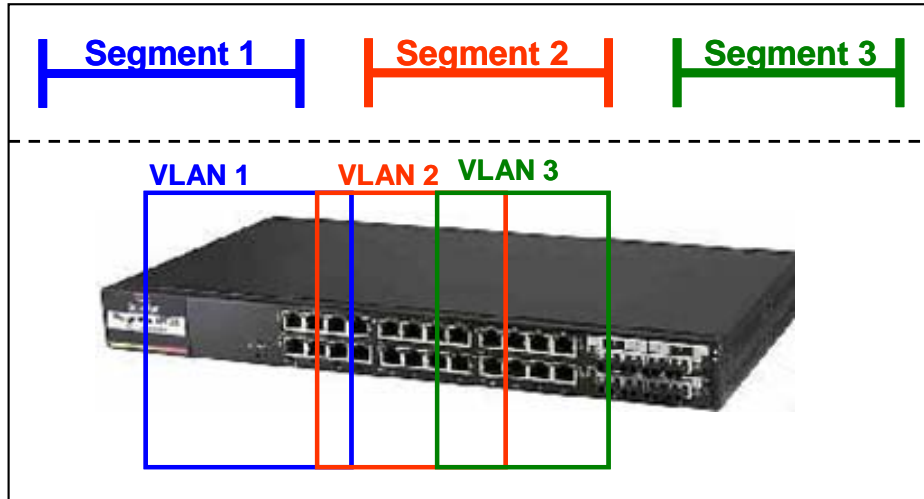
VLANs can isolate groups of users, or divide up traffic for security, bandwidth management, etc. VLANs are widely used today and are here to stay. VLANs need not be in one physical location. They can be spread across geography or topology. VLAN membership information can be propagated across multiple Magnum6K switches.



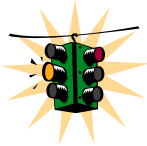
**FIGURE 67** – VLAN as two separate collision domains. The top part of the figure shows two “traditional” Ethernet segments. Up to 32 VLANs can be defined per switch.



A group of network users (ports) assigned to a VLAN form a broadcast domain. Packets are forwarded only between ports that are designated for the same VLAN. Cross-domain broadcast traffic in the switch is eliminated and bandwidth is saved by not allowing packets to flood out on all ports. For many reasons a port may be configured to belong to multiple VLANs.

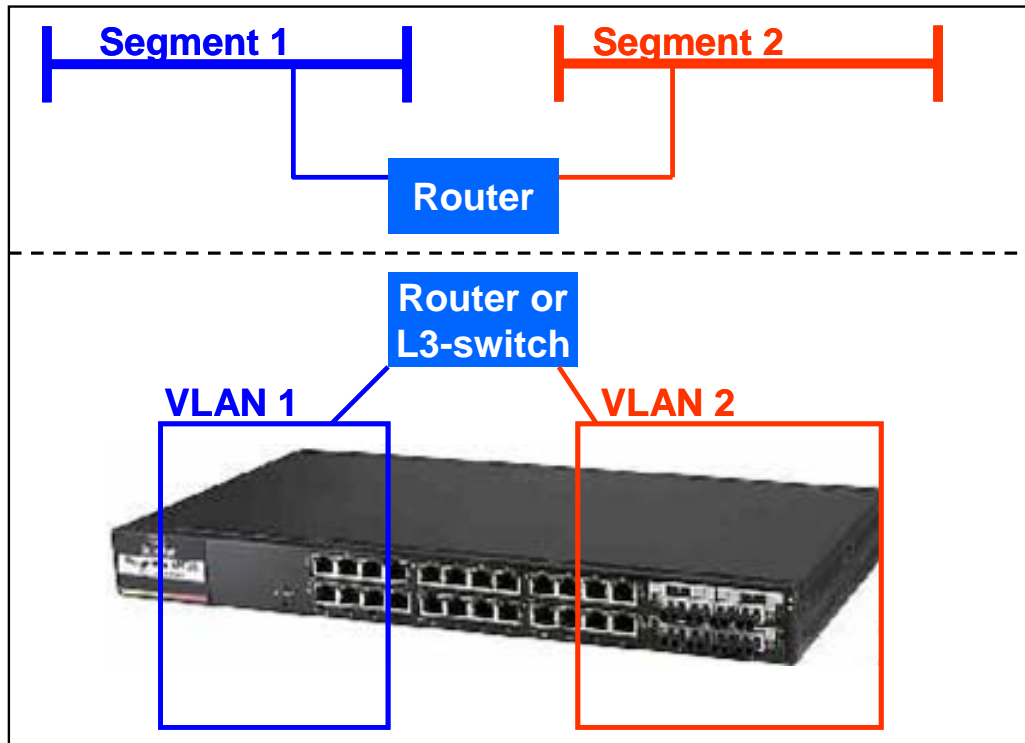


**FIGURE 68** – Ports can belong to multiple VLANs. In this figure a simplistic view is presented where some ports belong to VLANs 1, 2 and other ports belong to VLANs 2,3. Ports can belong to VLANs 1, 2 and 3. This is not shown in the figure.

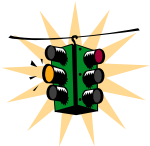


By default, on Magnum 6K family of switches, VLAN support is enabled and all ports on the switch belong to the default VLAN (DEFAULT-VLAN). This places all ports on the switch into one physical broadcast domain.

If VLANs are entirely separate segments or traffic domains – how can the VLANs route traffic (or “talk”) to each other? This can be done using routing technologies (e.g., a router or a L3-switch). The routing function can be done internally to a L3-switch. One advantage of an L3 switch is that the switch can also support multiple VLANs. The L3 switch can thus route traffic across multiple VLANs easily and provides a cost effective solution if there are many VLANs defined.



**FIGURE 69** – routing between different VLANs is performed using a router or a Layer 3 switch (L3-switch)



The Magnum 6K family of switches supports up to 32 VLANs per switch

## Tag VLAN or Port VLAN?

What is the difference between tag and port VLAN? In a nutshell – the term port vlan is specific to a switch and port VLAN assigns a specific port or group of ports belonging to a VLAN. So when ports belong to multiple VLANs and they are specific to a switch, use the Port VLAN to configure that. Port VLANs do not look for VLAN identifier (VID) information nor does it manipulate the VID information. It thus works “transparently” and propagates the VLAN information along.

In the tag VLAN, an identifier called the VLAN identifier (VID) is either inserted or manipulated. This manipulated VLAN tag allows VLAN information to be propagated across devices or switches, allowing VLAN information to span multiple switches.

As described earlier, VLAN is an administratively configured LAN or broadcast domain. Instead of going to the wiring closet to move a cable to a different LAN segment, the same task can be accomplished remotely by configuring a port on an 802.1Q-compliant switch to belong to a different VLAN. The ability to move end stations to different broadcast domains by setting membership profiles for each port on centrally managed switches is one of the main advantages of 802.1Q VLANs.

802.1Q VLANs aren't limited to one switch. VLANs can span many switches. Sharing VLANs between switches is achieved by inserting a tag with a VLAN identifier (VID) into each frame. A VID must be assigned for each VLAN. By assigning the same VID to VLANs on many switches, one or more VLAN (broadcast domain) can be extended across a large network.

802.1Q-compliant switch ports, such as those on the Magnum 6K family of switches, can be configured to transmit tagged or untagged frames. A tag field containing VLAN information can be inserted into an Ethernet frame. If a port has an 802.1Q-compliant device attached (such as another switch), these tagged frames can carry VLAN membership information between switches, thus letting a VLAN span multiple switches. Normally connections between switches can carry multiple VLAN information and this is called port trunking or 802.1Q trunks.

There is one important caveat: administrators must ensure ports with non-802.1Q-compliant devices attached are configured to transmit untagged frames. Many network interface cards such as those for PCs printers and other “dumb” switches are not 802.1Q-compliant. If they receive a tagged frame, they will not understand the VLAN tag and will drop the frame. In situations like these, its best to use port based VLANs for connecting to these devices.

Sometimes a port may want to listen to broadcasts across different VLANs or propagate the VLAN information on to other ports. This port must thus belong to multiple VLANs so that the broadcast information reaches the port accurately. If the port also wants to send broadcast traffic, the proper egress (sending out of information) and ingress (receiving information) has to be configured on the Magnum 6K family of switches. In Tag based VLAN this is similar but only if the port is tagged for each VLAN.

## Private VLANs

Private VLANs are VLANs which are private to a given switch in a network. For Magnum 6K family of switches, the Private VLANs are usually restricted to a single switch. Private VLANs are implemented on Magnum 6K family of switches using Port based VLAN. See the section on Port VLAN for additional information.

The reasons Private VLANs are constructed are for security. For example, if some confidential data were residing on VLAN 5, then only the people connected to that switch on VLAN 5 can have access to that information. No one else can access that VLAN. Similarly, if another switch had video surveillance equipment on VLAN 20 then only ports with access to VLAN 20 can have access to the video surveillance information.

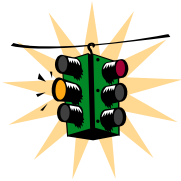
Finally, one port can belong to multiple VLANs – so depending on the function and use, different VLANs information can be shared across a port. Such a port is said to be in promiscuous mode for private VLANs.

## Using Port VLANs

Port VLANs are rarely used in networks which uses the same VLANs across multiple switches. Port VLANs are used when VLANs are setup up on a single switch and connectivity between the system on different VLANs is needed. Broadcast traffic is not isolated to one VLAN in Port VLANs.

General steps for using port VLANs are

- 1) Plan your VLAN strategy and create a map of the logical topology that will result from configuring VLANs. Include consideration for the interaction between VLANs.
- 2) Configure at least one VLAN in addition to the default VLAN
- 3) Assign the desired ports to the VLANs
- 4) Decide on trunking strategy – how will the VLAN information be propagated from one switch to another and also what VLAN information will be propagated across
- 5) (Layer 3 consideration) check to see if the routing between the VLANs is “working” by pinging stations on different VLANs



information

- 1) You can rename the default VLAN, but you cannot change its VID (1) or delete it from the switch
- 2) Any ports *not* specifically assigned to another VLAN will remain assigned to the DEFAULT-VLAN
- 3) Changing the number of VLANs supported on the switch requires the SAVE command to save the new VLAN

## Creating VLANs

**Creating VLAN** and to configure VLAN related commands

*Syntax* `set vlan type=<port | tag | none>`

## VLAN Configuration

*Syntax* **configure vlan type=port**      **OR**

*Syntax* **vlan type=port**

### Adding VLANs

*Syntax* **add id=<vlan Id> [name=<vlan name>] port=<number | list | range>**  
**[forbid=<number | list | range>] [<mgt | nomgt>]**

### Disabling Management on VLAN

Use the <nomgt> option when creating a VLAN as shown in the add command above.

### Starting VLANs

*Syntax* **start vlan=<name | number | list | range>**

### Saving the configuration

*Syntax* **save**

### Editing VLANs

*Syntax* **edit id=<vlan Id> [name=<vlan name>] port=<number | list | range>**  
**[<mgt | nomgt>]**

### Displaying the VLAN information

*Syntax* **show vlan type=<port | tag> [<id=vlanid>]**

```
Magnum6K25#vlan type=port
Magnum6K25(port-vlan)## add id=2 name=test port=1-10
Magnum6K25(port-vlan)## start vlan=all
Magnum6K25(port-vlan)## save
Saving current configuration...
Configuration saved
```

**FIGURE 70** – *configuring VLANs on Magnum 6K switch*

The example below shows how to add three different VLANs. Along with the VLANs, Port 14 is assigned to the four VLANs – the three new ones added plus the DEFAULT-VLAN 1. The following

interaction shows how VLANs 10, 20, 30 are added to port 14 and the VLANs activated. A typical use for such a port would be to connect a “dumb” switch to this port and allow traffic from three different VLANs to pass through transparently to the “dumb” switch, which will be connected to port 14. Note in this example, VLAN information is not propagated on to the “dumb” switch.

**Magnum6K25# set vlan type=port**

VLAN set to Port-based.

*Enter the VLAN configuration mode*

**Magnum6K25# vlan type=port**

**Magnum6K25(port-vlan)## add id=10 name=engineering port=14**

Vlan added successfully with

Vlan id : 10  
Vlan name : engineering  
Ports : 14

**Magnum6K25(port-vlan)## add id=20 name=engineering port=14**

ERROR - Duplicate Vlan name

*Notice – each VLAN needs a unique name – here by mistake, VLAN 10 and 20 had the same name.*

**Magnum6K25(port-vlan)## add id=20 name=sales port=14**

Vlan added successfully with

Vlan id : 20  
Vlan name : sales  
Ports : 14

**Magnum6K25(port-vlan)## add id=30 name=marketing port=14**

Vlan added successfully with

Vlan id : 30  
Vlan name : marketing  
Ports : 14

**Magnum6K25(port-vlan)## show vlan type=port**

VLAN ID : 1  
Name : Default VLAN  
Status : Active

| PORT | STATUS |
|------|--------|
| 9    | UP     |
| 10   | DOWN   |
| 11   | DOWN   |
| 12   | DOWN   |
| 13   | UP     |
| 14   | DOWN   |
| 15   | DOWN   |
| 16   | DOWN   |

VLAN ID : 10  
 Name : engineering  
 Status : Pending

*The VLANs added are not yet active. Each individual VLAN can be activated or all VLANs can be activated*

| PORT | STATUS |
|------|--------|
| 14   | DOWN   |

VLAN ID : 20  
 Name : sales  
 Status : Pending

| PORT | STATUS |
|------|--------|
| 14   | DOWN   |

VLAN ID : 30  
 Name : marketing  
 Status : Pending

| PORT | STATUS |
|------|--------|
| 14   | DOWN   |

*Start all VLANs*

**Magnum6K25(port-vlan)##start vlan=all**

All pending VLAN's started.

**Magnum6K25(port-vlan)##show vlan type=port**

VLAN ID : 1  
 Name : Default VLAN  
 Status : Active

| PORT | STATUS |
|------|--------|
| 9    | UP     |
| 10   | DOWN   |
| 11   | DOWN   |
| 12   | DOWN   |
| 13   | UP     |
| 15   | DOWN   |
| 16   | DOWN   |

VLAN ID : 10  
 Name : engineering  
 Status : Active

*The "Pending" VLAN is now "Active"*

| PORT | STATUS |
|------|--------|
| 14   | DOWN   |

VLAN ID : 20  
 Name : sales

```

Status      : Active
=====
PORT | STATUS
=====
 14  |  DOWN

VLAN ID    : 30
Name       : marketing
Status     : Active
=====
PORT | STATUS
=====
 14  |  DOWN

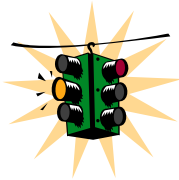
Magnum6K25(port-vlan)## exit
Magnum6K25#

```

FIGURE 71 – Example of setting up port based VLANs

## Using Tag VLANs

When multiple switches are connected on a network, the VLAN information needs to be propagated on to other switches. In such situations – it is best to use tag based VLANs.



Older versions of MNS-6K the use of tag VLANs needed the **set-ingress** and **set-egress** commands to set the flow of incoming and outgoing traffic. These commands are defunct. GarrettCom recommends using the **set-port** command instead.

The commands for setting Tag VLANs are

*Syntax* **set-port port=<number|list|range> default id=<number>** sets the default VLAN id (termed PVID in previous versions). Default VLAN id is the VLAN id assigned to the untagged packets received on that port. For Magnum 6K family of switches, the default VLAN id is 1

*Syntax* **set-port port=<number|list|range> filter status=<enable|disable>** enables or disables the VLAN filtering function. When enabled, the switch will drop the packets coming in through a port if the port is not a member of the VLAN. For example, if port 1 is a member of VLANs 10, 20 and 30, if a packet with VLAN id 40 arrives at port 1 it will be dropped

*Syntax* **set-port port=<number|list|range> tagging id=<number> status=<tagged|untagged>** defines whether the outgoing packets from a port will be tagged or untagged. This definition is on a per VLAN basis. For example the command **set-port port=1 tagging id=10 status=tagged** will instruct the switch to tag all packets going out of port 1 to belong to VLAN 10

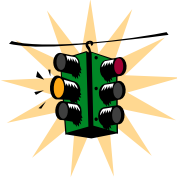
*Syntax* **set-port port=<number|list|range> join id=<number>** adds the specified port(s) to the specified VLAN id. This command works with active or pending VLANs



*Syntax* **set-port port=<number | list | range> leave id=<number>** releases a specific port from a VLAN. For example if port 1 belongs to VLAN 10, 20, 30, 40 the command **set-port port=1 leave id=40** makes port 1 belong to VLAN 10, 20, 30, dropping VLAN 40

*Syntax* **show-port [port=<port | list | range>]** shows all parameters related to tag vlan for the list of ports. If the port parameter is omitted, it will display all ports

In the example below, we start with Port VLAN and convert to TAG VLAN. We define ports 14 through 16 to belong to VLANs 10, 20 and 30 and the rest of the ports belong to the default VLAN – VLAN 1. Filtering is enabled on ports 14-16. The VLAN setup is done before devices are plugged into ports 14-16 as a result the status of the ports show the port status as DOWN.



1. A word of caution – when TAG VLAN filtering is enabled, there can be serious connectivity repercussions – the only way to recover from that it is to reload the switch without saving the configuration or by modifying the configuration from the console (serial) port
2. There can be either TAG VLAN on MSN-6K or Port VLAN. Both VLANs cannot co-exist at the same time
3. There can only be one default VLAN for the switch. The default is set to VLAN 1 and can be changed to another VLAN. A word of caution on changing the default VLAN as well – there can be repercussions on management as well as multicast and other issues
4. Tag VLAN support VLAN ids from 1 to 4096. VLAN ids more than 2048 are reserved for specific purposes and it is recommended they not be used
5. There are a maximum of 32 VLANs per switch which can be defined and supported

```
Magnum6K25# vlan type=port
```

```
Magnum6K25(port-vlan)## show vlan type=port
```

```
VLAN ID: 1
Name : Default VLAN
Status : Active
```

| PORT | STATUS |
|------|--------|
| 9    | UP     |
| 10   | DOWN   |
| 11   | DOWN   |
| 12   | DOWN   |
| 13   | UP     |
| 15   | DOWN   |
| 16   | DOWN   |

VLAN ID: 10  
 Name : engineering  
 Status : Active

```
=====
PORT | STATUS
=====
 14  |  DOWN
```

VLAN ID: 20  
 Name : sales  
 Status : Active

```
=====
PORT | STATUS
=====
 14  |  DOWN
```

VLAN ID: 30  
 Name : marketing  
 Status : Active

```
=====
PORT | STATUS
=====
 14  |  DOWN
```

*To switch to TAG VLAN, the port VLAN has to be disabled or stopped. Only one type of VLAN can co-exist at the same time. Exit out of Port VLAN configuration mode and set the VLAN type to be Tag VLAN.*

**Magnum6K25(port-vlan)## stop vlan=all**

All active VLAN's stopped.

**Magnum6K25(port-vlan)## exit**

**Magnum6K25# set vlan type=tag**

VLAN set to Tag-based.

**Magnum6K25# show active-vlan**

Tag VLAN is currently active.

**Magnum6K25# show vlan type=tag**

VLAN ID: 1  
 Name : Default VLAN  
 Status : Active

```
-----
PORT | MODE | STATUS
-----
 9   | UNTAGGED | UP
10   | UNTAGGED | DOWN
```

```

11 | UNTAGGED | DOWN
12 | UNTAGGED | DOWN
13 | UNTAGGED | UP
14 | UNTAGGED | DOWN
15 | UNTAGGED | DOWN
16 | UNTAGGED | DOWN
    
```

*Note – ports 14-16 are “DOWN” – the VLAN configuration is preferably done before devices are plugged in to avoid connectivity repercussions.*

**Magnum6K25# vlan type=tag**

**Magnum6K25(tag-vlan)## add id=10 name=mkt port=14-16**

```

Tag based vlan Added Successfully.
Vlan id   :10
Vlan name : mkt
Ports    :14-16
    
```

*The edit command can be used to reset the names or other values*

**Magnum6K25(tag-vlan)## edit id=10 name=engineering port=14-16**

```

Tag based vlan edited Successfully.
Vlan id   : 10
Vlan name : engineering
Ports    : 14-16
    
```

**Magnum6K25(tag-vlan)## add id=20 name=sales port=14-16**

```

Tag based vlan Added Successfully.
Vlan id   :20
Vlan name : sales
Ports    :14-16
    
```

*Intentionally done to show the effect of adding a duplicate VLAN.*

**Magnum6K25(tag-vlan)## add id=20 name=marketing port=14-16**

ERROR: Duplicate Vlan Id

**Magnum6K25(tag-vlan)## add id=30 name=marketing port=14-16**

```

Tag based vlan Added Successfully.
Vlan id   :30
Vlan name : marketing
Ports    :14-16
    
```

**Magnum6K25(tag-vlan)## show vlan type=tag**

```

VLAN ID: 1
Name : Default VLAN
Status : Active
    
```

| PORT | MODE     | STATUS |
|------|----------|--------|
| 9    | UNTAGGED | UP     |
| 10   | UNTAGGED | DOWN   |
| 11   | UNTAGGED | DOWN   |

|    |          |      |
|----|----------|------|
| 12 | UNTAGGED | DOWN |
| 13 | UNTAGGED | UP   |
| 14 | UNTAGGED | DOWN |
| 15 | UNTAGGED | DOWN |
| 16 | UNTAGGED | DOWN |

VLAN ID: 10  
 Name : engineering  
 Status : Pending

*Note – the VLANs are not started as yet. Adding the VLAN does not start it by default.*

| PORT | MODE     | STATUS |
|------|----------|--------|
| 14   | UNTAGGED | DOWN   |
| 15   | UNTAGGED | DOWN   |
| 16   | UNTAGGED | DOWN   |

VLAN ID: 20  
 Name : sales  
 Status : Pending

| PORT | MODE     | STATUS |
|------|----------|--------|
| 14   | UNTAGGED | DOWN   |
| 15   | UNTAGGED | DOWN   |
| 16   | UNTAGGED | DOWN   |

VLAN ID: 30  
 Name : marketing  
 Status : Pending

| PORT | MODE     | STATUS |
|------|----------|--------|
| 14   | UNTAGGED | DOWN   |
| 15   | UNTAGGED | DOWN   |
| 16   | UNTAGGED | DOWN   |

**Magnum6K25(tag-vlan)## start vlan=all**

All pending VLAN's started.

*Enable filtering on the ports required. Note – the MNS-6K software will prompt you to be sure that connectivity is not disrupted.*

**Magnum6K25(tag-vlan)## set-port port=14-16 filter status=enable**

WARNING: PVID does not match the port(15)'s VLAN ID(s).  
 If you are using telnet session on this port,  
 setting ingress might stop the session.

Do you want to continue? [ 'Y' or 'N' ] **Y**

WARNING: PVID does not match the port(14)'s VLAN ID(s).

If you are using telnet session on this port,  
setting ingress might stop the session.

Do you want to continue? [ 'Y' or 'N' ] **Y**

WARNING: PVID does not match the port(16)'s VLAN ID(s).

If you are using telnet session on this port,  
setting ingress might stop the session.

Do you want to continue? [ 'Y' or 'N' ] **Y**

Ingress Filter Enabled

**Magnum6K25(tag-vlan)## show vlan type=tag**

VLAN ID: 1

Name : Default VLAN

Status : Active

| PORT | MODE     | STATUS |
|------|----------|--------|
| 9    | UNTAGGED | UP     |
| 10   | UNTAGGED | DOWN   |
| 11   | UNTAGGED | DOWN   |
| 12   | UNTAGGED | DOWN   |
| 13   | UNTAGGED | UP     |

VLAN ID: 10

Name : engineering

Status : Active

| PORT | MODE     | STATUS |
|------|----------|--------|
| 14   | UNTAGGED | DOWN   |
| 15   | UNTAGGED | DOWN   |
| 16   | UNTAGGED | DOWN   |

VLAN ID: 20

Name : sales

Status : Active

| PORT | MODE     | STATUS |
|------|----------|--------|
| 14   | UNTAGGED | DOWN   |
| 15   | UNTAGGED | DOWN   |
| 16   | UNTAGGED | DOWN   |

VLAN ID: 30  
 Name : marketing  
 Status : Active

*VLANs are now active, however, as the packet traverses VLANs the packet should be tagged. This now enabled next.*

| PORT | MODE     | STATUS |
|------|----------|--------|
| 14   | UNTAGGED | DOWN   |
| 15   | UNTAGGED | DOWN   |
| 16   | UNTAGGED | DOWN   |

**Magnum6K25(tag-vlan)## set-port port=14-16 tagging id=10 status=tagged**

Port tagging enabled

**Magnum6K25(tag-vlan)## set-port port=14-16 tagging id=20 status=tagged**

Port tagging enabled

**Magnum6K25(tag-vlan)## set-port port=14-16 tagging id=30 status=tagged**

Port tagging enabled

**Magnum6K25(tag-vlan)## show vlan type=tag**

VLAN ID: 1  
 Name : Default VLAN  
 Status : Active

| PORT | MODE     | STATUS |
|------|----------|--------|
| 9    | UNTAGGED | UP     |
| 10   | UNTAGGED | DOWN   |
| 11   | UNTAGGED | DOWN   |
| 12   | UNTAGGED | DOWN   |
| 13   | UNTAGGED | UP     |

VLAN ID: 10  
 Name : engineering  
 Status : Active

| PORT | MODE   | STATUS |
|------|--------|--------|
| 14   | TAGGED | DOWN   |
| 15   | TAGGED | DOWN   |
| 16   | TAGGED | DOWN   |

VLAN ID: 20  
 Name : sales  
 Status : Active

| PORT | MODE   | STATUS |
|------|--------|--------|
| 14   | TAGGED | DOWN   |
| 15   | TAGGED | DOWN   |
| 16   | TAGGED | DOWN   |

VLAN ID: 30  
Name : marketing  
Status : Active

| PORT | MODE   | STATUS |
|------|--------|--------|
| 14   | TAGGED | DOWN   |
| 15   | TAGGED | DOWN   |
| 16   | TAGGED | DOWN   |

*Before exiting – don't forget to save the configuration or discard the configuration by doing a reboot.*

FIGURE 72 – Example for Tag VLAN

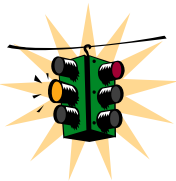
## Tag VLANs and Management

Normally, for security reasons, a user may want to disable management information propagating on a specific VLAN. By default, management information propagates on VLAN 1 (default VLAN). To disable management or to enable management information from propagating on a VLAN, please use the commands listed below:

*Syntax* **add** id=<vlan Id> [name=<vlan name>] port=<number | list | range> [forbid=<number | list | range>] [<mgt | nomgt>] – add VLANs

**GarrettCom recommends to disable management function when the VLANs are added using the add command shown above. By default, management is allowed (enabled) on a VLAN.**

*Syntax* **edit** id=<vlan Id> [name=<vlan name>] port=<number | list | range> [<mgt | nomgt>] – change VLAN assignment



**THE EDIT COMMAND ONLY ASSOCIATES THE PORT WITH THE VLANs. So for example, if VLAN 5 had port 10-14, an edit command on port 14 only will drop ports 10-13 from VLAN 5. See example below.**

Magnum 6K25# **vlan type=tag**

**Magnum 6K25(tag-vlan)## add id=5 name=engineering port=10-14**

Tag based vlan Added Successfully.

Vlan id :5  
 Vlan name : engineering  
 Ports :10-14

**Magnum 6K25(tag-vlan)## add id=10 name=marketing port=15,16 nomgt**

Tag based vlan Added Successfully.

Vlan id :10  
 Vlan name : marketing  
 Ports :15,16

**Magnum 6K25(tag-vlan)## show vlan type=tag**

VLAN ID: 1  
 Name : Default VL  
 Status : Active

| PORT | MODE     | STATUS |
|------|----------|--------|
| 1    | UNTAGGED | UP     |
| 2    | UNTAGGED | DOWN   |
| 3    | UNTAGGED | DOWN   |
| 4    | UNTAGGED | DOWN   |
| 5    | UNTAGGED | DOWN   |
| 6    | UNTAGGED | DOWN   |
| 7    | UNTAGGED | DOWN   |
| 8    | UNTAGGED | DOWN   |
| 9    | UNTAGGED | DOWN   |
| 10   | UNTAGGED | DOWN   |
| 11   | UNTAGGED | DOWN   |
| 12   | UNTAGGED | DOWN   |
| 13   | UNTAGGED | DOWN   |
| 14   | UNTAGGED | DOWN   |
| 15   | UNTAGGED | DOWN   |
| 16   | UNTAGGED | DOWN   |

VLAN ID: 5  
 Name : engineering  
 Status : Pending

| PORT | MODE     | STATUS |
|------|----------|--------|
| 10   | UNTAGGED | DOWN   |
| 11   | UNTAGGED | DOWN   |
| 12   | UNTAGGED | DOWN   |
| 13   | UNTAGGED | DOWN   |
| 14   | UNTAGGED | DOWN   |

VLAN ID: 10



Name : marketing  
 Status : Pending  
 Management Port Excluded from this VLAN

| PORT | MODE     | STATUS |
|------|----------|--------|
| 15   | UNTAGGED | DOWN   |
| 16   | UNTAGGED | DOWN   |

**Magnum 6K25(tag-vlan)## edit id=5 port=14 nomgt**

Tag based vlan edited Successfully.  
 Vlan id : 5  
 Vlan name : engineering  
 Ports : 14

**Magnum 6K25(tag-vlan)## show vlan type=tag id=5**

VLAN ID: 5  
 Name : engineering  
 Status : Pending  
 Management Port Excluded from this VLAN

*Note – ports 10-13 got dropped from VLAN 5. Also note – the management function is excluded for this VLAN*

| PORT | MODE     | STATUS |
|------|----------|--------|
| 14   | UNTAGGED | DOWN   |

**Magnum 6K25(tag-vlan)## show vlan type=tag id=5 port=10-14**

VLAN ID: 5  
 Name : engineering  
 Status : Pending  
 Management Port Excluded from this VLAN

| PORT | MODE     | STATUS |
|------|----------|--------|
| 14   | UNTAGGED | DOWN   |

**Magnum 6K25(tag-vlan)## show vlan type=tag**

VLAN ID: 1  
 Name : Default VLAN  
 Status : Active

| PORT | MODE | STATUS |
|------|------|--------|
|------|------|--------|

```

1 |   UNTAGGED |   UP
2 |   UNTAGGED |  DOWN
3 |   UNTAGGED |  DOWN
4 |   UNTAGGED |  DOWN
5 |   UNTAGGED |  DOWN
6 |   UNTAGGED |  DOWN
7 |   UNTAGGED |  DOWN
8 |   UNTAGGED |  DOWN
9 |   UNTAGGED |  DOWN
10 |  UNTAGGED |  DOWN
11 |  UNTAGGED |  DOWN
12 |  UNTAGGED |  DOWN
13 |  UNTAGGED |  DOWN
14 |  UNTAGGED |  DOWN
15 |  UNTAGGED |  DOWN
16 |  UNTAGGED |  DOWN

VLAN ID: 5
Name : engineering
Status : Pending
Management Port Excluded from this VLAN

-----
PORT |   MODE   |   STATUS
-----
 14 |  UNTAGGED |   DOWN

VLAN ID: 10
Name : marketing
Status : Pending
Management Port Excluded from this VLAN

-----
PORT |   MODE   |   STATUS
-----
 15 |  UNTAGGED |   DOWN
 16 |  UNTAGGED |   DOWN

Magnum 6K25(tag-vlan)##

```

**FIGURE 73** – *Editing the VLAN information for enabling or disabling management*

## List of commands in this chapter

*Syntax* `set vlan type=<port|tag|none>` defines the VLAN type

*Syntax* **configure vlan type=port** enter the VLAN configuration commands

*Syntax* **vlan type=port** enter the VLAN configuration commands

*Syntax* **add id=<vlan Id> [name=<vlan name>] port=<number | list | range> [forbid=<number | list | range>] [<mgt | nomgt>]** - adding VLAN

*Syntax* **edit id=<vlan id> [name=<vlan name>] port=<number | list | range> [<mgt | nomgt>]** - edit existing VLAN name

*Syntax* **start vlan=<name | number | list | range>** activate the VLAN configuration

*Syntax* **save** save the configuration (including the VLAN configuration)

*Syntax* **show vlan type=<port | tag> [<id=vlanid>]** display specific VLAN information

*Syntax* **set-port port=<number | list | range> default id=<number>** sets the default VLAN id. For Magnum 6K family of switches, the default VLAN id is 1, unless changed using this command

*Syntax* **set-port port=<number | list | range> filter status=<enable | disable>** enables or disables the VLAN filtering function.

*Syntax* **set-port port=<number | list | range> tagging id=<number> status=<tagged | untagged>** defines whether the outgoing packets from a port will be tagged or untagged.

*Syntax* **set-port port=<number | list | range> join id=<number>** adds the specified port(s) to the specified VLAN id

*Syntax* **set-port port=<number | list | range> leave id=<number>** releases a specific port from a VLAN

*Syntax* **show-port [port=<port | list | range>]** shows all parameters related to tag vlan for the list of ports. If the port parameter is omitted, it will display all ports

## 10 – Spanning Tree Protocol (STP)

*Create and manage alternate paths to the network*

**S**panning Tree Protocol was designed to avoid loops in an Ethernet network. An Ethernet network using switches can have redundant paths – this may however cause loops and to prevent the loops MNS-6K software uses spanning tree protocol. As a manager of the MNS-6K software, controlling n which span the traffic traverses is necessary. It is also necessary to specify the parameters of STP. STP is available as the IEEE 802.1d protocol and is a standard of the IEEE.



### STP features and operation

The switch uses the IEEE 802.1d Spanning Tree Protocol (STP). When STP is enabled, it ensures that only one path at a time is active between any two nodes on the network. In networks where more than one physical path exists between two nodes, STP ensures only a single path is active by blocking all redundant paths. Enabling STP is necessary to avoid loops and duplicate messages. This duplication leads to a “broadcast storm” or other erratic behavior that can bring down the network.

As recommended in the IEEE 802.1Q VLAN standard, the Magnum 6K family of switches uses **single-instance STP**. This means a single spanning tree is created to make sure there are no network loops associated with any of the connections to the switch. This works regardless of whether VLANs are configured on the switch. Thus, these switches do not distinguish between VLANs when identifying redundant physical links.

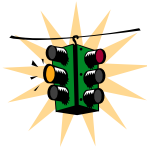
The switch automatically senses port identity and type, and automatically defines port cost and priority for each type. The MNS-6K software allows a manager to adjust the cost, priority, the mode for each port as well as the global STP parameter values for the switch.

While allowing only one active path through a network at any time, STP retains any redundant physical path to serve as a backup (blocked) path in case the existing active path fails. Thus, if an active path fails, STP automatically activates (unblocks) an available backup to serve as the new active path for as long as the original active path is down.

The table below lists the default values of the STP variables.

| Variable or Attribute                    | Default Value |
|--|---------------|
| STP capabilities                         | Disabled      |
| reconfiguring general operation priority | 32768         |
| Bridge maximum age                       | 20 seconds    |
| Hello time                               | 2 seconds     |
| Forward delay                            | 15 seconds    |
| Reconfiguring per-port STP path cost     | 0             |
| Priority                                 | 32768         |
| Mode                                     | Normal        |
| Monitoring of STP                        | Not Available |
| Root Port                                | Not set       |

**Figure 74** – STP default values – refer to next section “Using STP” for more detailed explanation on the variables



1. By default, STP is disabled. To use STP, it has to be manually enabled.
2. If you are using tagged VLANs, at least one untagged VLAN must be available for the BPDU's to propagate through the network to update STP status.

## Using STP

The commands used for configuring STP are listed below.

*Syntax* **show stp <config | ports >** - regardless of whether STP is enabled or disabled (default) this command lists the switch's full STP configuration, including general settings and port settings

**Magnum6K25# show stp config**

STP CONFIGURATION

-----

```
Spanning Tree Enabled(Global) : NO
Spanning Tree Enabled(Ports) : YES, 9,10,11,12,13,14,15,16
Protocol                       : Normal STP
Bridge ID                      : 80:00:00:20:06:25:ed:80
Bridge Priority                 : 32768
Bridge Forward Delay           : 15
```

```

Bridge Hello Time      : 2
Bridge Max Age        : 20
Root Port              : 0
Root Path Cost        : 0
Designated Root       : 80:00:00:20:06:25:ed:80
Designated Root Priority : 32768
Root Bridge Forward Delay : 15
Root Bridge Hello Time : 2
Root Bridge Max Age   : 20

RSTP CONFIGURATION
-----
Rapid STP/STP Enabled(Global) : NO
Magnum6K25#

```

**FIGURE 75** – *Viewing STP configuration*

The variables listed above are:

**Spanning Tree Enabled (Global):** indicates whether STP is enabled or disabled globally i.e. if the value is YES, all ports have STP enabled, otherwise, all ports have STP disabled

**Spanning Tree Enabled (Ports):** indicates which ports have STP enabled – note in the figure the ports 9 through 16 are STP enabled, but STP functionality is not enabled – so STP will not perform on these ports

**Bridge Priority:** specifies the switch (bridge) priority value. This value is used along with the switch MAC address to determine which switch in the network is the root device. Lower values mean higher priority. Value ranges from 0 to 65535. Default value is 32768

**Bridge Forward Delay:** indicates the time duration the switch will wait from listening to learning states and from learning to forwarding states. The value ranges from 4 to 30 seconds. Default value is 15

**Bridge Hello Time:** When the switch is the root device, this is the time between messages being transmitted. The value is from 1 to 10 seconds. Default value is 2 seconds

**Bridge Max Age:** This is the maximum time a message with STP information is allowed by the switch before the switch discards the information and updates the address table again. Value ranges from 6 to 40 seconds with default value of 20 seconds

**Root Port:** indicates the port number, which is elected as the root port of the switch. A root port of “0” indicates STP is disabled

**Root Path Cost:** A path cost is assigned to individual ports for the switch to determine which ports are the forwarding points. A higher cost means more loops, a lower cost means fewer loops. More loops equal more traffic and a tree which takes a long time to converge – resulting in a slower system

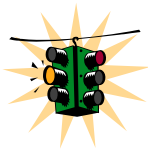
**Designated Root:** shows the MAC address of the bridge in the network elected or designated as the root bridge. Normally when STP is not enabled the switch designates itself as the root switch

**Designated Root Priority:** shows the designated root bridge’s priority. Default value is 32768

**Root Bridge Forward Delay:** indicates the designated root bridge’s forward delay. This is the time the switch waits before it switches from the listening to the forwarding state. The default is 15 seconds. This value can be set between 4-30 seconds

**Root Bridge Hello Time:** indicates the designated root bridge’s hello time. Hello information is sent out every 2 seconds

**Root Bridge Max Age:** indicates the designated root bridge’s maximum age – after which it discards the information as being old and receives new updates



These variables can be changed using the “priority”, “cost”, “port” and “timers” commands described later in this chapter.

```

Magnum6K25# show stp ports

STP Port Configuration
-----
Port#  Type      Priority  Path Cost  State      Des. Bridge      Des. Port
-----
09     TP(10/100) 128      100        Disabled   80:00:00:20:06:25:ed:80  80:09
10     TP(10/100) 128      100        Disabled   80:00:00:20:06:25:ed:80  80:0a
11     TP(10/100) 128      100        Disabled   80:00:00:20:06:25:ed:80  80:0b
12     TP(10/100) 128      100        Disabled   80:00:00:20:06:25:ed:80  80:0c
13     TP(10/100) 128      100        Disabled   80:00:00:20:06:25:ed:80  80:0d
14     TP(10/100) 128      100        Disabled   80:00:00:20:06:25:ed:80  80:0e
15     TP(10/100) 128      100        Disabled   80:00:00:20:06:25:ed:80  80:0f
16     TP(10/100) 128      100        Disabled   80:00:00:20:06:25:ed:80  80:10

Magnum6K25#
    
```

FIGURE 76 – STP Port status information

The variables shown above are

**Port#:** indicates the port number. Value ranges from 01 to max number of ports in the switch

**Type:** indicates the type of port – TP indicates Twisted Pair

**Priority:** STP uses this to determine which ports are used for forwarding. Lower the number means higher priority. Value ranges from 0 to 255. Default is 128

**Path Cost:** This is the assigned port cost value used for the switch to determine the forwarding points. Values range from 1 to 65535

**State:** indicates the STP state of individual ports. Values can be Listening, Learning, Forwarding, Blocking and Disabled.

**Des. Bridge:** This is the port's designated root bridge

**Des. Port:** This is the port's designated root port

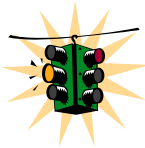
To enable or disable STP, enter the STP configuration mode and use the “**stp <enable | disable>**” command.

*Syntax* **stp** – STP Configuration mode

*Syntax* **stp <enable | disable>** - Start (Enable) or stop (Disable) STP

*Syntax* **set stp type=<stp | rstp>** - set the spanning tree protocol to be IEEE 802.1d or 802.1w (Rapid Spanning Tree Protocol)

*Syntax* **show active-stp** – Display which version of STP is currently active



Incorrect STP settings can adversely affect network performance. GarrettCom Inc. recommends starting with the default STP settings. Changing the settings requires a detailed understanding of STP. For more information on STP, please refer to the IEEE 802.1d standard.

**Magnum6K25# show active-stp**

Current Active Mode: RSTP.  
RSTP is Disabled.

**Magnum6K25# stp**

ERROR: Invalid Command

**Magnum6K25#set stp type=stp**

STP Mode set to STP.

**Magnum6K25# stp**

**Magnum6K25(stp)## stp enable**  
Successfully set the STP status

**Magnum6K25(stp)## show stp config**

*Note –it is always a good idea to check which mode of STP is active. If the proper mode is not active, the configuration command “stp” will not be understood. To set the proper mode, use the “set stp” command.*



```

STP CONFIGURATION
-----
Spanning Tree Enabled(Global) : YES
Spanning Tree Enabled(Ports) : YES, 9,10,11,12,13,14,15,16
Protocol                        : Normal STP
Bridge ID                       : 80:00:00:20:06:25:ed:80
Bridge Priority                  : 32768
Bridge Forward Delay            : 15
Bridge Hello Time               : 2
Bridge Max Age                  : 20
Root Port                       : 0
Root Path Cost                  : 0
Designated Root                 : 80:00:00:20:06:25:ed:80
Designated Root Priority        : 32768
Root Bridge Forward Delay       : 15
Root Bridge Hello Time         : 2
Root Bridge Max Age             : 20

RSTP CONFIGURATION
-----
Rapid STP/STP Enabled(Global) : NO

Magnum6K25(stp)## show stp ports

STP Port Configuration
-----
Port#  Type        Priority  Path Cost  State      Des. Bridge      Des. Port
-----
09    TP(10/100)  128     100        Forwarding 80:00:00:20:06:25:ed:80 80:09
10    TP(10/100)  128     100        Disabled  80:00:00:20:06:25:ed:80 80:0a
11    TP(10/100)  128     100        Disabled  80:00:00:20:06:25:ed:80 80:0b
12    TP(10/100)  128     100        Disabled  80:00:00:20:06:25:ed:80 80:0c
13    TP(10/100)  128     19         Forwarding 80:00:00:20:06:25:ed:80 80:0d
14    TP(10/100)  128     100        Disabled  80:00:00:20:06:25:ed:80 80:0e
15    TP(10/100)  128     100        Disabled  80:00:00:20:06:25:ed:80 80:0f
16    TP(10/100)  128     100        Disabled  80:00:00:20:06:25:ed:80 80:10

Magnum6K25(stp)##
    
```

FIGURE 77 – Enabling STP

- Syntax* **priority [port=<number | list | range>] value=<0-255 | 0-65535>** - specifies the port or switch level priority. When a port(s) are specified the priority is associated with ports and their value is 0-255. If no ports are specified, then the switch (bridge) priority is specified and its value is 0-65535
- Syntax* **cost port=<number | list | range> value=<0-65535>** - cost is specific to a port and the port(s) have to be specified
- Syntax* **port port=<number | list | range> status=<enable | disable>** - specific ports may not need to participate in STP process. These ports typically would be end-stations. If you are not sure – let MNS-6K software make the decisions
- Syntax* **timers forward-delay=<4-30> hello=<1-10> age=<6-40>** - change the STP Forward Delay, Hello timer and Aging timer values

**Priority:** specifies the switch (bridge) priority value. This value is used along with the switch MAC address to determine which switch in the network is the root device. Lower values mean higher priority. Value ranges from 0 to 65535. Default value is 32768

**Cost:** A path cost is assigned to individual ports for the switch to determine which ports are the forwarding points. A higher cost means the link is “more expensive” to use and falls in the passive mode compared to the link with a lower cost. Value ranges from 0 to 65535. Default value is 32768

**Status:** Enables or disables a port from participating in STP discovery. Its best to only allow trunk ports to participate in STP. End stations need not participate in STP process.

**Forward-Delay:** indicates the time duration the switch will wait from listening to learning states and from learning to forwarding states. The value ranges from 4 to 30 seconds. Default value is 15

**Hello:** When the switch is the root device, this is the time between messages being transmitted. The value is from 1 to 10 seconds. Default value is 2 seconds

**Age:** This is the maximum time a message with STP information is allowed by the switch before the switch discards the information and updates the address table again. Value ranges from 6 to 40 seconds with default value of 20 seconds

**Magnum6K25(stp)## show stp config**

STP CONFIGURATION

```

-----
Spanning Tree Enabled(Global) : NO
Spanning Tree Enabled(Ports) : YES, 9,10,11,12,13,14,15,16
Protocol                       : Normal STP
Bridge ID                      : 80:00:00:20:06:25:ed:80
Bridge Priority                 : 32768
Bridge Forward Delay           : 15
Bridge Hello Time              : 2
Bridge Max Age                 : 20
Root Port                     : 0
Root Path Cost                 : 0
Designated Root                : 80:00:00:20:06:25:ed:80
Designated Root Priority       : 32768
Root Bridge Forward Delay      : 15
Root Bridge Hello Time        : 2
Root Bridge Max Age           : 20

```

RSTP CONFIGURATION

```

-----
Rapid STP/STP Enabled(Global) : NO

```

**Magnum6K25(stp)## show stp ports**

STP Port Configuration

| Port# | Type       | Priority | Path Cost | State    | Des. Bridge             | Des. Port |
|-------|------------|----------|-----------|----------|-------------------------|-----------|
| 09    | TP(10/100) | 128      | 100       | Disabled | 80:00:00:20:06:25:ed:80 | 80:09     |
| 10    | TP(10/100) | 128      | 100       | Disabled | 80:00:00:20:06:25:ed:80 | 80:0a     |
| 11    | TP(10/100) | 128      | 100       | Disabled | 80:00:00:20:06:25:ed:80 | 80:0b     |
| 12    | TP(10/100) | 128      | 100       | Disabled | 80:00:00:20:06:25:ed:80 | 80:0c     |
| 13    | TP(10/100) | 128      | 100       | Disabled | 80:00:00:20:06:25:ed:80 | 80:0d     |
| 14    | TP(10/100) | 128      | 100       | Disabled | 80:00:00:20:06:25:ed:80 | 80:0e     |
| 15    | TP(10/100) | 128      | 100       | Disabled | 80:00:00:20:06:25:ed:80 | 80:0f     |
| 16    | TP(10/100) | 128      | 100       | Disabled | 80:00:00:20:06:25:ed:80 | 80:10     |

**Magnum6K25(stp)## stp enable**

Successfully set the STP status

**Magnum6K25(stp)## show stp config**

STP CONFIGURATION

```

-----
Spanning Tree Enabled(Global) : YES
Spanning Tree Enabled(Ports) : YES, 9,10,11,12,13,14,15,16
Protocol : Normal STP
Bridge ID : 80:00:00:20:06:25:ed:80
Bridge Priority : 32768
Bridge Forward Delay : 15
Bridge Hello Time : 2
Bridge Max Age : 20
Root Port : 0
Root Path Cost : 0
Designated Root : 80:00:00:20:06:25:ed:80
Designated Root Priority : 32768
Root Bridge Forward Delay : 15
Root Bridge Hello Time : 2
Root Bridge Max Age : 20
    
```

RSTP CONFIGURATION

```

-----
Rapid STP/STP Enabled(Global) : NO
    
```

**Magnum6K25(stp)## show stp ports**

*Ports which have devices connected to it now participate in STP.*

STP Port Configuration

| Port# | Type       | Priority | Path Cost | State      | Des. Bridge             | Des. Port |
|-------|------------|----------|-----------|------------|-------------------------|-----------|
| 09    | TP(10/100) | 128      | 100       | Forwarding | 80:00:00:20:06:25:ed:80 | 80:09     |
| 10    | TP(10/100) | 128      | 100       | Disabled   | 80:00:00:20:06:25:ed:80 | 80:0a     |
| 11    | TP(10/100) | 128      | 100       | Disabled   | 80:00:00:20:06:25:ed:80 | 80:0b     |
| 12    | TP(10/100) | 128      | 100       | Disabled   | 80:00:00:20:06:25:ed:80 | 80:0c     |
| 13    | TP(10/100) | 128      | 19        | Forwarding | 80:00:00:20:06:25:ed:80 | 80:0d     |

```

14 TP(10/100) 128 100 Disabled 80:00:00:20:06:25:ed:80 80:0e
15 TP(10/100) 128 100 Disabled 80:00:00:20:06:25:ed:80 80:0f
16 TP(10/100) 128 100 Disabled 80:00:00:20:06:25:ed:80 80:10
    
```

**Magnum6K25(stp)## priority value=15535**

Successfully set the bridge priority

**Magnum6K25(stp)## show stp config**

STP CONFIGURATION

```

-----
Spanning Tree Enabled(Global) : YES
Spanning Tree Enabled(Ports) : YES, 9,10,11,12,13,14,15,16
Protocol                       : Normal STP
Bridge ID                      : 80:00:00:20:06:25:ed:80
Bridge Priority                 : 15535
Bridge Forward Delay           : 15
Bridge Hello Time              : 2
Bridge Max Age                 : 20
Root Port                     : 0
Root Path Cost                 : 0
Designated Root                : 80:00:00:20:06:25:ed:80
Designated Root Priority       : 15535
Root Bridge Forward Delay      : 15
Root Bridge Hello Time        : 2
Root Bridge Max Age           : 20
    
```

*STP is now enabled. Note the default values for the different variables discussed.*

RSTP CONFIGURATION

```

-----
Rapid STP/STP Enabled(Global) : NO
    
```

**Magnum6K25(stp)## priority port=13 value=20**

Successfully set the priority for port 13

**Magnum6K25(stp)## show stp ports**

STP Port Configuration

*Note on Port #13, the priority changed, however the Path Cost did not – till the cost command is issued.*

| Port# | Type       | Priority | Path Cost | State      | Des. Bridge             | Des. Port |
|-------|------------|----------|-----------|------------|-------------------------|-----------|
| 09    | TP(10/100) | 128      | 100       | Forwarding | 80:00:00:20:06:25:ed:80 | 80:09     |
| 10    | TP(10/100) | 128      | 100       | Disabled   | 80:00:00:20:06:25:ed:80 | 80:0a     |
| 11    | TP(10/100) | 128      | 100       | Disabled   | 80:00:00:20:06:25:ed:80 | 80:0b     |
| 12    | TP(10/100) | 128      | 100       | Disabled   | 80:00:00:20:06:25:ed:80 | 80:0c     |
| 13    | TP(10/100) | 20       | 19        | Forwarding | 80:00:00:20:06:25:ed:80 | 80:0d     |
| 14    | TP(10/100) | 128      | 100       | Disabled   | 80:00:00:20:06:25:ed:80 | 80:0e     |
| 15    | TP(10/100) | 128      | 100       | Disabled   | 80:00:00:20:06:25:ed:80 | 80:0f     |
| 16    | TP(10/100) | 128      | 100       | Disabled   | 80:00:00:20:06:25:ed:80 | 80:10     |

**Magnum6K25(stp)## cost port=13 value=20**

Setting cost for STP...Successfully set the path cost for port 13

**Magnum6K25(stp)## show stp ports**

STP Port Configuration

| Port# | Type       | Priority | Path Cost | State      | Des. Bridge             | Des. Port |
|-------|------------|----------|-----------|------------|-------------------------|-----------|
| 09    | TP(10/100) | 128      | 100       | Forwarding | 80:00:00:20:06:25:ed:80 | 80:09     |
| 10    | TP(10/100) | 128      | 100       | Disabled   | 80:00:00:20:06:25:ed:80 | 80:0a     |
| 11    | TP(10/100) | 128      | 100       | Disabled   | 80:00:00:20:06:25:ed:80 | 80:0b     |
| 12    | TP(10/100) | 128      | 100       | Disabled   | 80:00:00:20:06:25:ed:80 | 80:0c     |
| 13    | TP(10/100) | 20       | 20        | Forwarding | 80:00:00:20:06:25:ed:80 | 80:0d     |
| 14    | TP(10/100) | 128      | 100       | Disabled   | 80:00:00:20:06:25:ed:80 | 80:0e     |
| 15    | TP(10/100) | 128      | 100       | Disabled   | 80:00:00:20:06:25:ed:80 | 80:0f     |
| 16    | TP(10/100) | 128      | 100       | Disabled   | 80:00:00:20:06:25:ed:80 | 80:10     |

**Magnum6K25(stp)## port port=9 status=disable**

Successfully set the STP status for port 9

**Magnum6K25(stp)## show stp ports**

STP Port Configuration

*Since Port #9 does not participate in STP – it is not listed here. Any changes made to STP parameters on Port #9 will be ignored.*

| Port# | Type       | Priority | Path Cost | State      | Des. Bridge             | Des. Port |
|-------|------------|----------|-----------|------------|-------------------------|-----------|
| 10    | TP(10/100) | 128      | 100       | Disabled   | 80:00:00:20:06:25:ed:80 | 80:0a     |
| 11    | TP(10/100) | 128      | 100       | Disabled   | 80:00:00:20:06:25:ed:80 | 80:0b     |
| 12    | TP(10/100) | 128      | 100       | Disabled   | 80:00:00:20:06:25:ed:80 | 80:0c     |
| 13    | TP(10/100) | 20       | 19        | Forwarding | 80:00:00:20:06:25:ed:80 | 80:0d     |
| 14    | TP(10/100) | 128      | 100       | Disabled   | 80:00:00:20:06:25:ed:80 | 80:0e     |
| 15    | TP(10/100) | 128      | 100       | Disabled   | 80:00:00:20:06:25:ed:80 | 80:0f     |
| 16    | TP(10/100) | 128      | 100       | Disabled   | 80:00:00:20:06:25:ed:80 | 80:10     |

**Magnum6K25(stp)## port port=9 status=enable**

Successfully set the STP status for port 9

**Magnum6K25(stp)## show stp ports**

STP Port Configuration

| Port# | Type       | Priority | Path Cost | State      | Des. Bridge             | Des. Port |
|-------|------------|----------|-----------|------------|-------------------------|-----------|
| 09    | TP(10/100) | 128      | 100       | Forwarding | 80:00:00:20:06:25:ed:80 | 80:09     |
| 10    | TP(10/100) | 128      | 100       | Disabled   | 80:00:00:20:06:25:ed:80 | 80:0a     |
| 11    | TP(10/100) | 128      | 100       | Disabled   | 80:00:00:20:06:25:ed:80 | 80:0b     |
| 12    | TP(10/100) | 128      | 100       | Disabled   | 80:00:00:20:06:25:ed:80 | 80:0c     |
| 13    | TP(10/100) | 20       | 20        | Forwarding | 80:00:00:20:06:25:ed:80 | 80:0d     |
| 14    | TP(10/100) | 128      | 100       | Disabled   | 80:00:00:20:06:25:ed:80 | 80:0e     |
| 15    | TP(10/100) | 128      | 100       | Disabled   | 80:00:00:20:06:25:ed:80 | 80:0f     |
| 16    | TP(10/100) | 128      | 100       | Disabled   | 80:00:00:20:06:25:ed:80 | 80:10     |

**Magnum6K25(stp)## show stp config**

## STP CONFIGURATION

```

-----
Spanning Tree Enabled(Global) : YES
Spanning Tree Enabled(Ports) : YES, 9,10,11,12,13,14,15,16
Protocol                       : Normal STP
Bridge ID                       : 80:00:00:20:06:25:ed:80
Bridge Priority                  : 15535
Bridge Forward Delay            : 15
Bridge Hello Time               : 2
Bridge Max Age                  : 20
Root Port                       : 0
Root Path Cost                  : 0
Designated Root                 : 80:00:00:20:06:25:ed:80
Designated Root Priority        : 15535
Root Bridge Forward Delay       : 15
Root Bridge Hello Time         : 2
Root Bridge Max Age            : 20

```

## RSTP CONFIGURATION

```

-----
Rapid STP/STP Enabled(Global) : NO

```

*The age parameter is out of range as per IEEE 802.1d specifications.*

**Magnum6K25(stp)## timers forward-delay=20 hello=5 age=40**

```

ERROR: Invalid Values
      Max Age <= (2*(Forward-Delay-1)) and Max Age >= (2*(Hello-Time+1))

```

**Magnum6K25(stp)## timers forward-delay=20 hello=5 age=30**

Successfully set the bridge time parameters

**Magnum6K25(stp)## show stp config**

## STP CONFIGURATION

```

-----
Spanning Tree Enabled(Global) : YES
Spanning Tree Enabled(Ports) : YES, 9,10,11,12,13,14,15,16
Protocol                       : Normal STP
Bridge ID                       : 80:00:00:20:06:25:ed:80
Bridge Priority                  : 15535
Bridge Forward Delay            : 20
Bridge Hello Time               : 5
Bridge Max Age                  : 30
Root Port                       : 0
Root Path Cost                  : 0
Designated Root                 : 80:00:00:20:06:25:ed:80
Designated Root Priority        : 15535
Root Bridge Forward Delay       : 20
Root Bridge Hello Time         : 5
Root Bridge Max Age            : 30

```

## RSTP CONFIGURATION

```
-----
Rapid STP/STP Enabled(Global) : NO
```

```
Magnum6K25(stp)##
```

FIGURE 78 – Configuring STP parameters

## List of commands in this chapter

*Syntax* **show stp <config|ports >** - regardless of whether STP is enabled or disabled (default) this command lists the switch's full STP configuration, including general settings and port settings

*Syntax* **stp** – STP Configuration mode

*Syntax* **stp <enable | disable>** - Start (Enable) or stop (Disable) STP

*Syntax* **priority [port=<number | list | range>] value=<0-255 | 0-65535>** - specifies the port or switch level priority. When a port(s) are specified the priority is associated with ports and their value is 0-255. If no ports are specified, then the switch (bridge) priority is specified and its value is 0-65535

*Syntax* **cost port=<number | list | range> value=<0-65535>** - cost is specific to a port and the port(s) have to be specified

*Syntax* **port port=<number | list | range> status=<enable | disable>** - specific ports may not need to participate in STP process. These ports typically would be end-stations. If you are not sure – let MNS-6K software make the decisions

*Syntax* **timers forward-delay=<4-30> hello=<1-10> age=<6-40>** - change the STP Forward Delay, Hello timer and Aging timer values

# 11 – Rapid Spanning Tree Protocol (RSTP)

*Create and manage alternate paths to the network*

**R**apid Spanning Tree Protocol (RSTP), like STP, was designed to avoid loops in an Ethernet network. Rapid Spanning Tree Protocol (RSTP) (IEEE 802.1w) is an evolution of the Spanning Tree Protocol (STP) (802.1d standard) and provides for faster spanning tree convergence after a topology change.



## RSTP concepts

The IEEE 802.1d Spanning Tree Protocol (STP) was developed to allow the construction of robust networks that incorporate redundancy while pruning the active topology of the network to prevent loops. While STP is effective, it requires that frame transfer must halt after a link outage. This halt is until all bridges in the network are sure to be aware of the new topology. Using STP (IEEE 802.1d) recommended values, this period lasts 30 seconds.

Rapid Spanning Tree Protocol (IEEE 802.1w) is a further evolution of the 802.1d Spanning Tree Protocol. It replaces the settling period with an active handshake between switches (bridges) that guarantees topology information to be rapidly propagated through the network. RSTP converges in less than one second to six seconds. RSTP also offers a number of other significant innovations. These include

- Topology changes in STP must be passed to the root bridge before they can be propagated to the network. Topology changes in RSTP can be originated from and acted upon by any designated switch (bridge), leading to more rapid propagation of address information
- STP recognizes one state - blocking for ports that should not forward any data or information. RSTP explicitly recognizes two states or blocking roles - alternate and backup port including them in computations of when to learn and forward and when to block
- STP relays configuration messages received on the root port going out of its designated ports. If an STP switch (bridge) fails to receive a message from its neighbor it cannot be sure where along the path to the root a failure occurred.



RSTP switches (bridges) generate their own configuration messages, even if they fail to receive one from the root bridge. This leads to quicker failure detection

- RSTP offers edge port recognition, allowing ports at the edge of the network to forward frames immediately after activation while at the same time protecting them against loops
- An improvement in RSTP allows configuration messages to age more quickly preventing them from “going around in circles” in the event of a loop

RSTP has three states. They are discarding, learning and forwarding.

The discarding state is entered when the port is first taken into service. The port does not learn addresses in this state and does not participate in frame transfer. The port looks for STP traffic in order to determine its role in the network. When it is determined that the port will play an active part in the network, the state will change to learning. The learning state is entered when the port is preparing to play an active member of the network. The port learns addresses in this state but does not participate in frame transfer. In a network of RSTP switches (bridges) the time spent in this state is usually quite short. RSTP switches (bridges) operating in STP compatibility mode will spend between 6 to 40 seconds in this state. After ‘learning’ the bridge will place the port in the forwarding state. While in this state the port both learns addresses and participates in frame transfer while in this state.

The result of these enhanced states is that the IEEE 802.1d version of spanning tree (STP) can take a fairly long time to resolve all the possible paths and to select the most efficient path through the network. The IEEE 802.1w Rapid reconfiguration of Spanning Tree significantly reduces the amount of time it takes to establish the network path. The result is reduced network downtime and improved network robustness. In addition to faster network reconfiguration, RSTP also implements greater ranges for port path costs to accommodate the higher connection speeds that are being implemented.

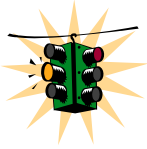
Proper implementations of RSTP (by switch vendors) is designed to be compatible with IEEE 802.1d STP. GarrettCom recommends that you employ RSTP or STP in your network.

## Transition from STP to RSTP

IEEE 802.1w RSTP is designed to be compatible with IEEE 802.1D STP. Even if all the other devices in your network are using STP, you can enable RSTP on your Magnum 6K family of switches. The default configuration values of the RSTP available in MNS-6K software will ensure that your switch will interoperate effectively with the existing STP devices. RSTP automatically detects when the switch ports are connected to non-RSTP devices using spanning tree and communicates with those devices using 802.1d STP BPDU packets.

Even though RSTP interoperates with STP, RSTP is so much more efficient at establishing the network path and the network convergence in case of a failure is very fast. For this reason,

GarrettCom recommends that all your network devices be updated to support RSTP. RSTP offers convergence times typically of less than one second. However, to make best use of RSTP and achieve the fastest possible convergence times there are some changes that you should make to the RSTP default configuration.



1. GarrettCom Inc. provides downloadable software Fault Timing Analyzer (FTA) for testing how quickly a network recovers from a fault, once the redundancy feature such as STP or RSTP is configured on the switches (bridges). This software can be downloaded from the GarrettCom site. This software is available at <http://www.garrettcom.com/ftaform.htm>
2. Under some circumstances it is possible for the rapid state transitions employed by RSTP to result in an increase in the rates of frame duplication and the order in which the frames are sent and received. In order to allow RSTP switches to support applications and protocols that may be sensitive to frame duplication and out of sequence frames, RSTP may have to be explicitly set to be compatible with STP. This explicit setting is called setting the “Force Protocol Version” parameter to be STP compatible. This parameter should be set to all ports on a given switch
3. As indicated above, one of the benefits of RSTP is the implementation of a larger range of port path costs which accommodates higher network speeds. New default values have also been implemented for the path costs associated with the different network speeds. This could create incompatibility between devices running the older implementations of STP a switch running RSTP
4. If you are using tagged VLANs, at least one untagged VLAN must be available for the BPDU's to propagate through the network to update STP status.
- 5. RSTP is needed for RS-Ring on the GarrettCom Magnum 6K family of switches.**

## Configuring RSTP

The commands to setup and configure RSTP on MNS-6K are

*Syntax* **\_set stp type=<stp | rstp>** - Set the switch to support RSTP or change it back to STP. Need to save and reboot the switch after this command

*Syntax* **rstp** – enter the RSTP configuration mode

*Syntax* **rstp <enable | disable>** - enable RSTP – by default, this is disabled and has to be manually activated

*Syntax* **port port=<number | list | range> [status=<enable | disable>] [migration=<enable>] [edge=<enable | disable>] [p2p=<on | off | auto>]**

*Example* **port port=<number | list | range> p2p= off** - Set the “point-to-point” value to off on all ports that are connected to **shared LAN segments** (i.e. connections to hubs). The default value is auto. P2P ports would typically be end stations or computers on the network

*Example* **port port=<number | list | range> edge=enable** – enable all ports connected to other hubs, bridges and switches as edge ports

*Example* **port port=<number | list | range> migration=enable** – set this for all ports connected to other devices such as hubs, bridges and switches known to support IEEE 802.1d STP services, but cannot support RSTP services

*Syntax* **show active-stp** – status whether STP or RSTP is running

*Syntax* **show stp <config | ports>** – display the RSTP or STP parameters

```
Magnum6K25# rstp
```

```
Magnum6K25(rstp)## show rstp config
```

```
RSTP CONFIGURATION
```

```
-----
```

```
Rapid STP/STP Enabled(Global) : NO
```

```
Magnum6K25(rstp)## rstp enable
```

```
Successfully set the RSTP status
```

```
Magnum6K25(rstp)## show active-stp
```

```
Current Active Mode: RSTP.
```

```
RSTP is Enabled.
```

```
Magnum6K25(rstp)## show stp config
```

```
RSTP CONFIGURATION
```

```
-----
```

```
Rapid STP/STP Enabled(Global) : YES
RSTP/STP Enabled Ports       : 9,10,11,12,13,14,15,16
Protocol                       : Normal RSTP
Bridge ID                     : 00:00:00:20:06:25:ed:89
Bridge Priority                : 0
Bridge Forward Delay          : 15
Bridge Hello Time             : 02
Bridge Max Age                : 20
Root Port                     : 0
Root Path Cost                : 0
Designated Root               : 00:00:00:20:06:25:ed:89
```

|                           |      |
|---------------------------|------|
| Designated Root Priority  | : 0  |
| Root Bridge Forward Delay | : 15 |
| Root Bridge Hello Time    | : 02 |
| Root Bridge Max Age       | : 20 |
| Topology Change count     | : 0  |
| Time Since topology Chg   | : 12 |

**FIGURE 79** – *Enabling RSTP and reviewing the RSTP variables*

The variables listed by the “**show stp config**” command are:

**Rapid Spanning Tree Enabled (Global):** indicates whether STP is enabled or disabled globally i.e. if the value is YES, all ports have STP enabled, otherwise, all ports have STP disabled

**Rapid Spanning Tree Enabled Ports:** indicates which ports have RSTP enabled

**Protocol:** indicates type of RSTP protocol active

**Bridge Priority:** specifies the switch (bridge) priority value. This value is used along with the switch MAC address to determine which switch in the network is the root device. Lower values mean higher priority. Value ranges from 0 to 65535. Default value is 0

**Bridge Forward Delay:** indicates the time duration the switch will wait from listening to learning states and from learning to forwarding states. The value ranges from 4 to 30 seconds. Default value is 15

**Bridge Hello Time:** when the switch is the root device, this is the time between messages being transmitted. The value is from 1 to 10 seconds. Default value is 2 seconds

**Bridge Max Age:** this is the maximum time a message with STP information is allowed by the switch before the switch discards the information and updates the address table again. Value ranges from 6 to 40 seconds with default value of 20 seconds

**Root Port:** indicates the port number, which is elected as the root port of the switch. A root port of “0” indicates STP is disabled

**Root Path Cost:** a path cost is assigned to individual ports for the switch to determine which ports are the forwarding points. A higher cost means more loops; a lower cost means fewer loops. More loops equal more traffic and a tree which takes a long time to converge – resulting in a slower system

**Designated Root:** shows the MAC address of the bridge in the network elected or designated as the root bridge.

**Designated Root Priority:** shows the designated root bridge’s priority. Default value is 0

**Root Bridge Forward Delay:** indicates the designated root bridge's forward delay. This is the time the switch waits before it switches from the listening to the forwarding state. The default is 15 seconds. This value can be set between 4-30 seconds

**Root Bridge Hello Time:** indicates the designated root bridge's hello time. Hello information is sent out every 2 seconds

**Root Bridge Max Age:** indicates the designated root bridge's maximum age – after which it discards the information as being old and receives new updates

**Topology Change count:** since the last reboot, the number of times the topology has changed. Use this in conjunction with “show uptime” to find the frequency of the topology changes

**Time Since topology Change:** number of seconds since the last topology change

```
Magnum6K25(rstp)## show stp ports
RSTP Port Configuration
-----
Port#  Type   Priority Path Cost   State        Des. Bridge      Des. Port
-----
09     TP(10/100) 128 2000000 Forwarding 00:00:00:20:06:25:ed:89 00:09
10     TP(10/100) 128 2000000 Disabled   00:0a
11     TP(10/100) 128 2000000 Disabled   00:0b
12     TP(10/100) 128 2000000 Disabled   00:0c
13     TP(10/100) 128 2000000 Forwarding 00:00:00:20:06:25:ed:89 00:0d
14     TP(10/100) 128 2000000 Disabled   00:0e
15     TP(10/100) 128 2000000 Disabled   00:0f
16     TP(10/100) 128 2000000 Disabled   00:10
-----
Magnum6K25(rstp)##
```

**FIGURE 80** – Reviewing the RSTP port parameters

The variables listed by the “**show stp config**” command are:

**Port#:** indicates the port number. Value ranges from 01 to max number of ports in the switch

**Type:** indicates the type of port – TP indicates Twisted Pair

**Priority:** STP uses this to determine which ports are used for forwarding. Lower the number means higher priority. Value ranges from 0 to 255. Default is 128

**Path Cost:** This is the assigned port cost value used for the switch to determine the forwarding points. Values range from 1 to 2000000. Lower the value, lower the cost and hence the preferred route. The costs for different Ethernet speeds are shown below. The Path cost in STP is compared to the path cost in RSTP.

| Port Type | STP Path cost | RSTP Path cost |
|-----------|---------------|----------------|
| 10 Mbps   | 100           | 2,000,000      |
| 100 Mbps  | 19            | 200,000        |
| 1 Gbps    | 4             | 20,000         |
| 10 Gbps   | 2             | 2,000          |

**Figure 81** – Path cost as defined in IEEE 802.1d (STP) and 802.1w (RSTP)

**State:** indicates the STP state of individual ports. Values can be Listening, Learning, Forwarding, Blocking and Disabled.

**Des. Bridge:** this is the port’s designated root bridge

**Des. Port:** this is the port’s designated root port

Another screen capture of the same command, from a larger network with several switches is shown below.

```

Magnum6K25# show stp ports
RSTP Port Configuration
-----
Port#   Type      Priority Path Cost  State          Des. Bridge          Des. Port
-----
01      TP(10/100) 128 2000000  Disabled      00:01
02      TP(10/100) 128 2000000  Disabled      00:02
03      TP(10/100) 128 2000000  Disabled      00:03
04      TP(10/100) 128 2000000  Disabled      00:04
05      TP(10/100) 128 2000000  Disabled      00:05
06      TP(10/100) 128 200000  Forwarding    80:00:00:20:06:30:00:01  00:06
07      TP(10/100) 128 200000  Discarding    80:00:00:20:06:2b:0f:e1  00:07
08      TP(10/100) 128 2000000  Disabled      00:08
09      Gigabit    128 20000    Forwarding    80:00:00:20:06:2b:0f:e1  00:09
10      Gigabit    128 20000    Forwarding    80:00:00:20:06:30:00:01  00:0a
Magnum6K25#

```

**FIGURE 82** – RSTP information from a network with multiple switches. Note the “show stp ports” command can be executed from the manager level prompt or from rstp configuration state as shown in the screen captures earlier.

In this example, ports 9,10 have a path cost of 20,000 and are the least cost paths. These ports are connected to other switches and the ports are enabled as forwarding ports. Ports 6, 7 are also

connected to other switches. From the state column, it indicates that port 7 is in a standby state as that port is discarding all traffic.

More CLI commands associated with RSTP in the RSTP configuration mode are:

*Syntax* **forceversion** <stp | rstp> - set the STP or RSTP compatibility mode

*Syntax* **show-forceversion** - the current force version

*Syntax* **show-timers** – show the values of the timers set for RSTP

*Syntax* **priority** [port=<number | list | range>] value=<0-255 | 0-65535> - specifies the port or switch level priority. When a port(s) are specified the priority is associated with ports and their value is 0-255. If no ports are specified, then the switch (bridge) priority is specified and its value is 0-65535

*Syntax* **cost** port=<number | list | range> value=<0-65535> - cost is specific to a port and the port(s) have to be specified

*Syntax* **port** port=<number | list | range> status=<enable | disable> - specific ports may not need to participate in STP process. These ports typically would be end-stations. If you are not sure – let MNS-6K software make the decisions

*Syntax* **timers** forward-delay=<4-30> hello=<1-10> age=<6-40> - change the STP Forward delay, Hello timer and Aging timer values

**Priority:** specifies the switch (bridge) priority value. This value is used along with the switch MAC address to determine which switch in the network is the root device. Lower values mean higher priority. Value ranges from 0 to 65535. Default value is 32768

**Cost:** A path cost is assigned to individual ports for the switch to determine which ports are the forwarding points. A higher cost means the link is “more expensive” to use and falls in the passive mode compared to the link with a lower cost. Value ranges from 0 to 65535. Default value is 32768

**Status:** Enables or disables a port from participating in STP discovery. It’s best to only allow trunk ports to participate in STP. End stations need not participate in STP process.

**Forward-Delay:** indicates the time duration the switch will wait from listening to learning states and from learning to forwarding states. The value ranges from 4 to 30 seconds. Default value is 15

**Hello:** When the switch is the root device, this is the time between messages being transmitted. The value is from 1 to 10 seconds. Default value is 2 seconds

**Age:** This is the maximum time a message with STP information is allowed by the switch before the switch discards the information and updates the address table again. Value ranges from 6 to 40 seconds with default value of 20 seconds

```

Magnum6K25# rstp

Magnum6K25(rstp)## show stp config
RSTP CONFIGURATION
-----
Rapid STP/STP Enabled(Global) : NO

Magnum6K25(rstp)## show active-stp
Current Active Mode: RSTP.
RSTP is Disabled.

Magnum6K25(rstp)## rstp enable
Successfully set the RSTP status

Magnum6K25(rstp)## show active-stp
Current Active Mode: RSTP.
RSTP is Enabled.

Magnum6K25(rstp)## show stp config
RSTP CONFIGURATION
-----
Rapid STP/STP Enabled(Global)      : YES
RSTP/STP Enabled Ports             : 9,10,11,12,13,14,15,16
Protocol                             : Normal RSTP
Bridge ID                           : 00:00:00:20:06:25:ed:89
Bridge Priority                      : 0
Bridge Forward Delay                : 15
Bridge Hello Time                   : 02
Bridge Max Age                      : 20
Root Port                           : 0
Root Path Cost                      : 0
Designated Root                    : 00:00:00:20:06:25:ed:89
Designated Root Priority             : 0
Root Bridge Forward Delay           : 15
Root Bridge Hello Time              : 02
Root Bridge Max Age                 : 20
Topology Change count               : 0
Time Since topology Chg             : 33

Magnum6K25(rstp)## show stp ports
RSTP Port Configuration
    
```

*Check status of STP or RSTP. This command shows STP or RSTP is disabled.*



| Port# | Type       | Priority | Path Cost | State      | Des. Bridge             | Des. Port |
|-------|------------|----------|-----------|------------|-------------------------|-----------|
| 09    | TP(10/100) | 128      | 2000000   | Forwarding | 00:00:00:20:06:25:ed:89 | 00:09     |
| 10    | TP(10/100) | 128      | 2000000   | Disabled   |                         | 00:0a     |
| 11    | TP(10/100) | 128      | 2000000   | Disabled   |                         | 00:0b     |
| 12    | TP(10/100) | 128      | 2000000   | Disabled   |                         | 00:0c     |
| 13    | TP(10/100) | 128      | 2000000   | Forwarding | 00:00:00:20:06:25:ed:89 | 00:0d     |
| 14    | TP(10/100) | 128      | 2000000   | Disabled   |                         | 00:0e     |
| 15    | TP(10/100) | 128      | 2000000   | Disabled   |                         | 00:0f     |
| 16    | TP(10/100) | 128      | 2000000   | Disabled   |                         | 00:10     |

**Magnum6K25(rstp)## forceversion rstp**

Error: Force Version already set to Normal RSTP

**Magnum6K25(rstp)## forceversion stp**

**Magnum6K25(rstp)## show-forceversion**

Force Version : Force to STP only

**Magnum6K25(rstp)## show stp config**

RSTP CONFIGURATION

```

-----
Rapid STP/STP Enabled(Global)      : YES
RSTP/STP Enabled Ports             : 9,10,11,12,13,14,15,16
Protocol                            : Force to STP only
Bridge ID                           : 00:00:00:20:06:25:ed:89
Bridge Priority                      : 0
Bridge Forward Delay                : 15
Bridge Hello Time                   : 02
Bridge Max Age                      : 20
Root Port                           : 0
Root Path Cost                      : 0
Designated Root                    : 00:00:00:20:06:25:ed:89
Designated Root Priority             : 0
Root Bridge Forward Delay           : 15
Root Bridge Hello Time              : 02
Root Bridge Max Age                 : 20
Topology Change count               : 0
Time Since topology Chg             : 100
    
```

*“forceversion” can be used for compatibility with STP devices. In this example, the switch is forced to STP mode.*

**Magnum6K25(rstp)## forceversion rstp**

**Magnum6K25(rstp)## show-forceversion**

Force Version : Normal RSTP

**Magnum6K25(rstp)## show stp config**

RSTP CONFIGURATION

*Using forceversion the switch is now operating using RSTP. Note the “show stp config” command also indicates the switch protocol is RSTP.*

```

-----
Rapid STP/STP Enabled(Global) : YES
RSTP/STP Enabled Ports       : 9,10,11,12,13,14,15,16
Protocol                       : Normal RSTP
Bridge ID                      : 00:00:00:20:06:25:ed:89
Bridge Priority                 : 0
Bridge Forward Delay          : 15
Bridge Hello Time              : 02
Bridge Max Age                 : 20
Root Port                     : 0
Root Path Cost                 : 0
Designated Root                : 00:00:00:20:06:25:ed:89
Designated Root Priority       : 0
Root Bridge Forward Delay     : 15
Root Bridge Hello Time        : 02
Root Bridge Max Age           : 20
Topology Change count         : 0
Time Since topology Chg      : 141

```

**Magnum6K25(rstp)## show-timers**

```

Forward Delay Timer : 15 sec
Hello Timer         : 2 sec
Max Age             : 20 sec

```

**Magnum6K25(rstp)## show stp ports**

RSTP Port Configuration

```

-----
Port#   Type      Priority Path Cost  State        Des. Bridge      Des. Port
-----
09      TP(10/100) 128 2000000   Forwarding  00:00:00:20:06:25:ed:89  00:09
10      TP(10/100) 128 2000000   Disabled    00:00:00:20:06:25:ed:89  00:0a
11      TP(10/100) 128 2000000   Disabled    00:00:00:20:06:25:ed:89  00:0b
12      TP(10/100) 128 2000000   Disabled    00:00:00:20:06:25:ed:89  00:0c
13      TP(10/100) 128 2000000   Forwarding  00:00:00:20:06:25:ed:89  00:0d
14      TP(10/100) 128 2000000   Disabled    00:00:00:20:06:25:ed:89  00:0e
15      TP(10/100) 128 2000000   Disabled    00:00:00:20:06:25:ed:89  00:0f
16      TP(10/100) 128 2000000   Disabled    00:00:00:20:06:25:ed:89  00:10

```

**Magnum6K25(rstp)## priority port=13 value=100**

**Magnum6K25(rstp)## show stp ports**

RSTP Port Configuration

```

-----
Port#   Type      Priority Path Cost  State        Des. Bridge      Des. Port
-----
09      TP(10/100) 128 2000000   Forwarding  00:00:00:20:06:25:ed:89  00:09
10      TP(10/100) 128 2000000   Disabled    00:00:00:20:06:25:ed:89  00:0a
11      TP(10/100) 128 2000000   Disabled    00:00:00:20:06:25:ed:89  00:0b

```

```

12 TP(10/100) 128 2000000 Disabled 00:0c
13 TP(10/100) 100 200000 Forwarding 00:00:00:20:06:25:ed:89 00:0d
14 TP(10/100) 128 2000000 Disabled 00:0e
15 TP(10/100) 128 2000000 Disabled 00:0f
16 TP(10/100) 128 2000000 Disabled 00:10

```

**Magnum6K25(rstp)## cost port=13 value=250000**

**Magnum6K25(rstp)## show stp ports**

RSTP Port Configuration

```

-----
Port#   Type   Priority Path Cost  State        Des. Bridge        Des. Port
-----
09  TP(10/100) 128 2000000 Forwarding 00:00:00:20:06:25:ed:89 00:09
10  TP(10/100) 128 2000000 Disabled   00:0a
11  TP(10/100) 128 2000000 Disabled   00:0b
12  TP(10/100) 128 2000000 Disabled   00:0c
13  TP(10/100) 100 250000 Forwarding 00:00:00:20:06:25:ed:89 00:0d
14  TP(10/100) 128 2000000 Disabled   00:0e
15  TP(10/100) 128 2000000 Disabled   00:0f
16  TP(10/100) 128 2000000 Disabled   00:10

```

**Magnum6K25(rstp)## port port=9 status=disable**

**Magnum6K25(rstp)## show stp ports**

RSTP Port Configuration

```

-----
Port#   Type   Priority Path Cost  State        Des. Bridge        Des. Port
-----
09  TP(10/100) 128 2000000 NO STP      00:09
10  TP(10/100) 128 2000000 Disabled   00:0a
11  TP(10/100) 128 2000000 Disabled   00:0b
12  TP(10/100) 128 2000000 Disabled   00:0c
13  TP(10/100) 100 250000 Forwarding 00:00:00:20:06:25:ed:89 00:0d
14  TP(10/100) 128 2000000 Disabled   00:0e
15  TP(10/100) 128 2000000 Disabled   00:0f
16  TP(10/100) 128 2000000 Disabled   00:10

```

**Magnum6K25(rstp)## port port=9 status=enable**

**Magnum6K25(rstp)## show stp ports**

RSTP Port Configuration

```

-----
Port#   Type   Priority Path Cost  State        Des. Bridge        Des. Port
-----
09  TP(10/100) 128 2000000 Forwarding 00:00:00:20:06:25:ed:89 00:09
10  TP(10/100) 128 2000000 Disabled   00:0a

```

```

11 TP(10/100) 128 2000000 Disabled 00:0b
12 TP(10/100) 128 2000000 Disabled 00:0c
13 TP(10/100) 100 250000 Forwarding 00:00:00:20:06:25:ed:89 00:0d
14 TP(10/100) 128 2000000 Disabled 00:0e
15 TP(10/100) 128 2000000 Disabled 00:0f
16 TP(10/100) 128 2000000 Disabled 00:10

```

```
Magnum6K25(rstp)## timers forward-delay=20 hello=5 age=30
```

Successfully set the bridge time parameters

```
Magnum6K25(rstp)## show stp config
```

#### RSTP CONFIGURATION

-----

```

Rapid STP/STP Enabled(Global) : YES
RSTP/STP Enabled Ports       : 9,10,11,12,13,14,15,16
Protocol                       : Normal RSTP
Bridge ID                     : 00:00:00:20:06:25:ed:89
Bridge Priority                : 0
Bridge Forward Delay          : 20
Bridge Hello Time             : 05
Bridge Max Age                : 30
Root Port                    : 0
Root Path Cost                : 0
Designated Root               : 00:00:00:20:06:25:ed:89
Designated Root Priority      : 0
Root Bridge Forward Delay     : 20
Root Bridge Hello Time       : 05
Root Bridge Max Age          : 30
Topology Change count        : 0
Time Since topology Chg      : 567

```

```
Magnum6K25(rstp)## exit
```

```
Magnum6K25#
```

FIGURE 83 – Configuring RSTP on MNS-6K

## List of commands in this chapter

*Syntax* **set stp type=<stp | rstp>** - Set the switch to support RSTP or change it back to STP. Need to save and reboot the switch after this command

*Syntax* **rstp** – enter the RSTP configuration mode

*Syntax* **rstp <enable | disable>** - enable RSTP – by default, this is disabled and has to be manually activated

*Syntax* **port port=<number | list | range> [status=<enable | disable>] [migration=<enable>] [edge=<enable | disable>] [p2p=<on | off | auto>]** - set the port type for RSTP

*Example* **port port=<number | list | range> p2p= off** - Set the “point-to-point” value to off on all ports that are connected to **shared LAN segments** (i.e. connections to hubs). The default value is auto. P2P ports would typically be end stations or computers on the network

*Example* **port port=<number | list | range> edge=enable** – enable all ports connected to other hubs, bridges and switches as edge ports

*Example* **port port=<number | list | range> migration=enable** – set this for all ports connected to other devices such as hubs, bridges and switches known to support IEEE 802.1d STP services, but cannot support RSTP services

*Syntax* **show active-stp** – status whether STP or RSTP is running

*Syntax* **show stp <config | ports>** - display the RSTP or STP parameters

*Syntax* **forceversion <stp | rstp>** - set the STP or RSTP compatibility mode

*Syntax* **show-forceversion** - the current force version

*Syntax* **show-timers** - show the values of the timers set for RSTP

*Syntax* **priority [port=<number | list | range>] value=<0-255 | 0-65535>** - specifies the port or switch level priority. When a port(s) are specified the priority is associated with ports and their value is 0-255. If no ports are specified, then the switch (bridge) priority is specified and its value is 0-65535

*Syntax* **cost port=<number | list | range> value=<0-65535>** - cost is specific to a port and the port(s) have to be specified

*Syntax* **port port=<number | list | range> status=<enable | disable>** - specific ports may not need to participate in STP process. These ports typically would be end-stations. If you are not sure – let MNS-6K software make the decisions

*Syntax* **timers forward-delay=<4-30> hello=<1-10> age=<6-40>** - change the STP Forward delay, Hello timer and Aging timer values

## 12 – RS-Ring™, S-Ring™ and Link-Loss-Learn™ (LLL)

*Speed up recovery from faults in Ethernet networks*

**S**-Ring and RS-Ring use ring topology to provide fast recovery from faults. These are based on industry standard STP and RSTP technologies. These technologies have been adapted to ring recovery applications by GarrettCom Inc. and these rings are called S-Ring. In addition, LLL enables a switch to rapidly re-learn MAC addresses in order to participate in S-Ring configurations.

In the last two chapters we looked at how RSTP or STP can be used to bring resiliency to a meshed network. This chapter's focus is to look at ring topologies and how these topologies can be used to provide faster recovery times than what STP or RSTP can offer. Both RSTP and STP are industry standard protocols and can be used with networking switches from different vendors.

LLL triggers action on the device supporting LLL when a connection is broken or there is loss of the link signal on a ring port. LLL can be used with S-Ring on managed switches such as the GarrettCom Magnum 6K family of switches. LLL can also be used on managed switches such as Magnum 6K family of switches, Magnum mP62 as well as on unmanaged switches such as ESD42 switches. Note that LLL can also be used with non-ring topologies (such as mesh topologies) using RSTP or STP where it does the necessary actions for fault recovery (such as re-learn addresses) in case of a link failure.

S-Ring is a ring technology using the GarrettCom MNS-6K software. In a S-Ring, a switch is designated as a “Ring Manager”. Devices in a S-Ring can be managed switches such as the Magnum 6K family of switches, other managed switches such as Magnum mP62 or unmanaged switches such as ESD42 or even hubs which leverages LLL. S-Ring is a licensed product from GarrettCom Inc. GarrettCom Inc. also licenses this technology to other companies who are interested in implementing the resiliency capabilities offered by S-Ring.

RS-Ring provides superior recovery times from failures. It works when

- The ring is made up of devices which are **managed switches** only from Magnum 6K family of switches
- Each of the switches in the ring topology are configured for RSTP
- The RS-Ring product license key is configured on each switch in the ring



### S-Ring and LLL concepts

S-Ring is built upon networking software standards such as IEEE 802.1d Spanning Tree Protocol (STP) or Rapid Spanning Tree Protocol (RSTP) based on IEEE 802.1w.

The purpose of S-Ring is to define two ports which participate in the RSTP/STP tree structure in a ring topology as opposed to a meshed topology. S-Ring running on the ring manager switch leverages this capability to recover quickly from fault situations. The recovery times for S-Ring based networks are within a few hundred milliseconds. Recovery time for STP devices is in tens of seconds (typically 30-50 seconds in most networks) or sub second to a few seconds for RSTP networks. The biggest advantage of S-Ring, besides the fast recovery time, is the defined ring topology which makes the network manageable. S-Ring can also be an overall lower cost solution as there are hubs as well as switches which can be used in the ring.

In the Magnum 6K family of switches as well as in other unmanaged switches such as the ESD42, a feature called Link-Loss-Learn™ (LLL) can be activated to immediately flush its address buffer and relearn the MAC addresses that route packets around the fault. This procedure, which is similar to switch initialization, occurs within milliseconds, resulting in fast ring recovery. An S-Ring implementation watches for link-loss as well as for STP/RSTP BPDU packet failures and responds to whichever occurs first. In most instances the link-loss will be detected faster than the two-second interval at which the BPDU packets are successfully passed around the ring. Typical ring recovery times using S-Ring software and mP62 edge switches with the LLL feature enabled on the ring ports is less than 250 milliseconds, even with 50 or more Magnum 6K family of switches in a ring structure. Without LLL activation, the Magnum 6K family of switches address buffer aging time (5 minutes default) could be the gating factor in ring recovery time. LLL is used on S-Ring and helps speed up the ring recovery time.

S-Ring operates from specifically defined port pairs that participate in a ring-topology. Multiple rings of different pairs on the same switch are also supported; however, intersecting rings or a “ring of rings” or “overlapping rings” is not supported in the current version. While S-Ring builds upon the foundation of RSTP or STP, S-Ring offers an additional topology option to network architects. The two ends of a ring must be connected to two ports in a Magnum 6K Switch that is enabled with the S-Ring software. The end points of the ring provide an alternate path to reach the switch that has failed. The in-out pairs of the ports to other devices in the ring have to be enabled with LLL. Some items to be aware of with S-Ring are as follows:

1. The S-Ring feature is a separately licensed module for the MNS-6K software package. This module must be enabled by means of a software key
2. Only one switch is the “Ring Master”. That switch has S-Ring Software authorized (enabled) for that device. Thus only one license key is needed per ring (and not per switch)
3. There can be multiple S-Rings on a given Magnum 6K switch. There can be multiple ring topologies in a network. Each ring has to be a separate ring. Ring of rings or overlapping rings are not supported at this time
4. S-Ring topologies support one failure in the network. A second failure may create isolated network islands
5. At least one untagged VLAN must be available for the BPDU’s to propagate through the network to update RSTP/STP status
6. S-Ring faults can be software signaled to alarm contacts.



### RS-Ring concepts

Today, more and more situations demand a network to be built using managed switches. These situations also demand a faster recovery time in case of a network failure. The topologies have to be simple for maintenance and other reasons. In these situations, a ring topology provides fault tolerance with the simplicity. RS-Ring feature can be used on managed Magnum 6K family of switches. RS-Ring provides the simple ring topology and provides faster recovery times than S-Ring or STP/RSTP.

RS-Ring is built upon networking software standards such as Rapid Spanning Tree Protocol (RSTP) based on IEEE 802.1w. RS-Ring defines two ports **on each switch** which participates in the ring topology and works with the RSTP tree structure. RS-Ring requires RSTP to be configured across all switches and uses the underlying RSTP protocol to provide simplicity in configuration as well as rapid recovery in the RS-Ring topology. The recovery times for RS-Ring based networks are within milliseconds. While the recovery time for STP devices is in tens of seconds (typically 30 seconds in most networks) or sub second to a few seconds for RSTP networks, RS-Ring offers recovery times typically in less than 100 milliseconds. The biggest advantage of RS-Ring, besides the fast recovery time, is the defined topology which makes the network manageable. RS-Ring is configured on Magnum 6K family of switches and requires RSTP to be enabled on all switches participating in the RS-Ring. RS-Ring cannot be used in a multi-vendor environment.

RS-Ring operates from specifically defined port pairs that participate in a ring-topology. Each of the two ends of a ring must be connected to two ports in a Magnum 6K Switch that is enabled with the RS-Ring software. The end points of the ring provide an alternate path to reach the switch that has failed. Some items for using RS-Ring are as follows:

1. Faster recover times than S-Ring or RSTP are needed by the network
2. The RS-Ring feature is a separately licensed module for the MNS-6K software package. This module must be enabled by means of a software key.
3. The same key can be used for either S-Ring or RS-Ring



4. The same license key needs to be configured for each switch on the ring and RS-Ring capability has to be enabled on all switches (and hence all the devices in the ring have to be a managed Magnum 6K switches)
5. RS-Ring topologies support one failure in the network. The second failure may create isolated network islands
6. RSTP has to be enabled on all Magnum 6K switches in the ring
7. At least one untagged VLAN must be available for the BPDU's to propagate through the network to update RSTP status.

## When to use RS-Ring vs S-Ring

RS-Ring or S-Ring provides resiliency in the network. So does RSTP and STP. The general guidelines for making a decision as to whether to use S-Ring or RS-Ring or for that matter, RSTP or STP, matters a lot on some key criteria, some of which are listed below.

- **Speed** – RS-Ring offers substantially faster recovery times compared to S-Ring. While the recovery time will vary on factors such as number of nodes in a ring, length of the ring etc., on an average, RS-Ring typically recovers in less than 100 mSec vs 300 mSec for S-Ring.
- **Cost** – RS-Rings and S-Rings are licensed features. S-Ring requires at least one device in the network should be a managed switch. RS-Ring requires **all devices** in the ring should be a managed Magnum 6K switches. So while the recovery times are faster for RS-Ring, the cost of building such a ring may be higher
- **Ring Topology** – multiple rings may be implemented with S-Ring running on one managed Magnum 6K switch. Only one RS-Ring per Magnum 6K switch can be configured<sup>4</sup>.
- **Managed Switches** – RS-Ring requires all devices in the ring are managed Magnum 6K family of switches. If there are non managed devices, RS-Ring cannot be used.

---

<sup>4</sup> It is technically possible to have S-Ring and RS-Ring on the same Magnum 6K Switch. GarrettCom Inc. does not recommend nor support such configurations.

## Comparing resiliency methods

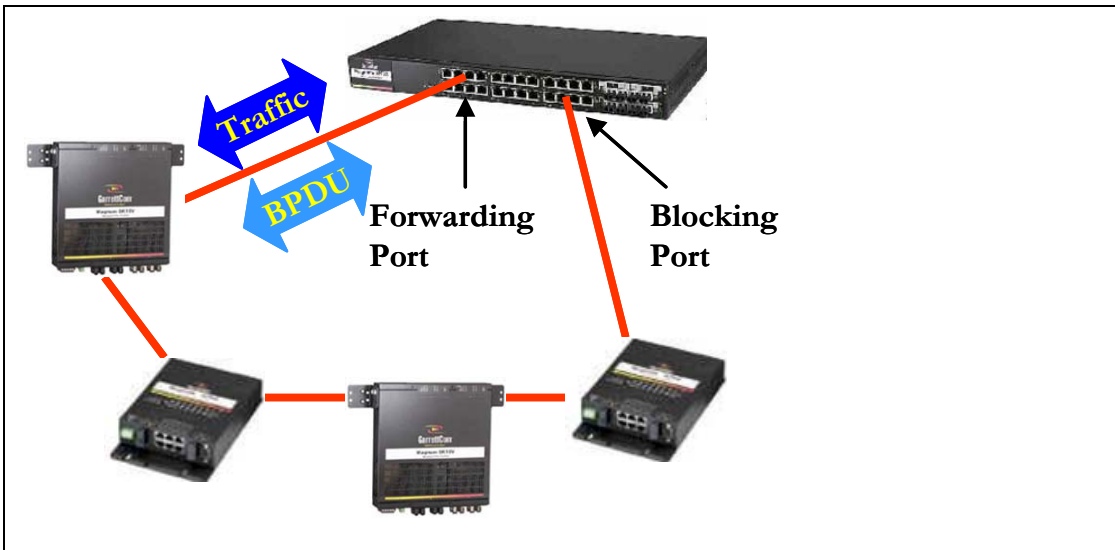
So far we have briefly covered S-Ring with LLL, RS-Ring, RSPT as well as STP. The table below summarizes some decision criteria on selecting RSPT vs STP vs S-Ring (and LLL) vs RS-Ring.

|                          | <b>RS-Ring</b>   | <b>S-Ring with LLL</b>  | <b>RSTP</b>   | <b>STP</b>   |
|--------------------------|--|---|---|--|
| <b>License</b>           | Same license key as S-Ring. One license key needs to be enabled on each Magnum 6K switch | A license key is needed. One key per ring manager switch  | Included in MNS-6K                                      | Included in MNS-6K                                       |
| <b>Spanning Tree</b>     | Works with RSTP  | Works with RSTP or STP devices  | --  | --   |
| <b>Devices supported</b> | Managed Magnum 6K family of switches   | Managed or certain non managed Magnum switches. Requires at least one Magnum 6K switch as ring manager                      | Many  | Many   |
| <b>Recovery decision</b> | Distributed across all switches in the ring. Works with RSTP in each switch              | Centralized to “Ring Manager”. LLL provides triggers to recomputed topology for ring members. Also works with RSTP or STP.  | Typically done using BPDU. Can take time.               | Typically done using BPDU. Can take time.                |
| <b>Topology</b>          | Single ring, multiple rings, no overlapping rings or ring of rings                       | Single ring, multiple rings, no overlapping rings or ring of rings  | Mesh topology – can have multiple paths                 | Mesh topology – can have multiple paths                  |
| <b>Interoperability</b>  | Works with managed Magnum 6K family of switches  | Works with managed 6K family of switches, other managed switches such as mP62 and non managed switches as well as some hubs | Wide range of products, including other vendor products | Wider range of products, including other vendor products |
| <b>Recovery time</b>     | Fastest  | Fast  | Medium – sub second to a few seconds                    | Slow – in tens of seconds                                |

|                       | <b>RS-Ring</b>   | <b>S-Ring with LLL</b>   | <b>RSTP</b>   | <b>STP</b>  |
|-----------------------|--|--|---|---|
| <b>Resiliency</b>     | Fast recovery from a single point of failure. No centralized decision making | Fast recovery from a single point of failure. Ring Master is responsible for decision making | Multiple points of failure – each connected node can be in stand-by | Multiple points of failure – each connected node can be in stand-by |
| <b>Software Cost</b>  | Licensed per ring  | Licensed per ring  | Included in MNS-6K  | Included in MNS-6K  |
| <b>Hardware cost</b>  | Managed 6K switches only   | One Managed 6K per ring. Multiple choices for members of the ring                            | Many choices available, making it cost effective                    | Many choices available, making it cost effective                    |
| <b>Software Alarm</b> | Not available at this time   | Yes  | No  | No  |
| <b>Ring Size</b>      | 50+ nodes  | 50+ nodes  | NA  | NA  |
| <b>Dual-Homing</b>    | Supports dual-homing to members in the ring                                  | Supports dual-homing to members in the ring  | Supports dual-homed device to devices in the network                | Supports dual-homed device to devices in the network                |

## RSTP/STP Operation without RS-Ring or S-Ring

S-Ring supports non managed switches as long as LLL capability is supported on that switch. A ring is a special form of mesh network topology. The two top-of-the-ring ports form an otherwise-illegal redundant path, and standard RSTP/STP causes one of these two ports to block incoming packets in order to enable normal Ethernet traffic flow. All ring traffic goes through the non-blocking port for normal LAN operation. This port is designated Forwarding Port. Meanwhile, there is a regular flow of status-checking multi-cast packets (called BPDUs or Bridge Protocol Data Units) sent out by RSTP/STP that move around the ring to show that things are functioning normally.

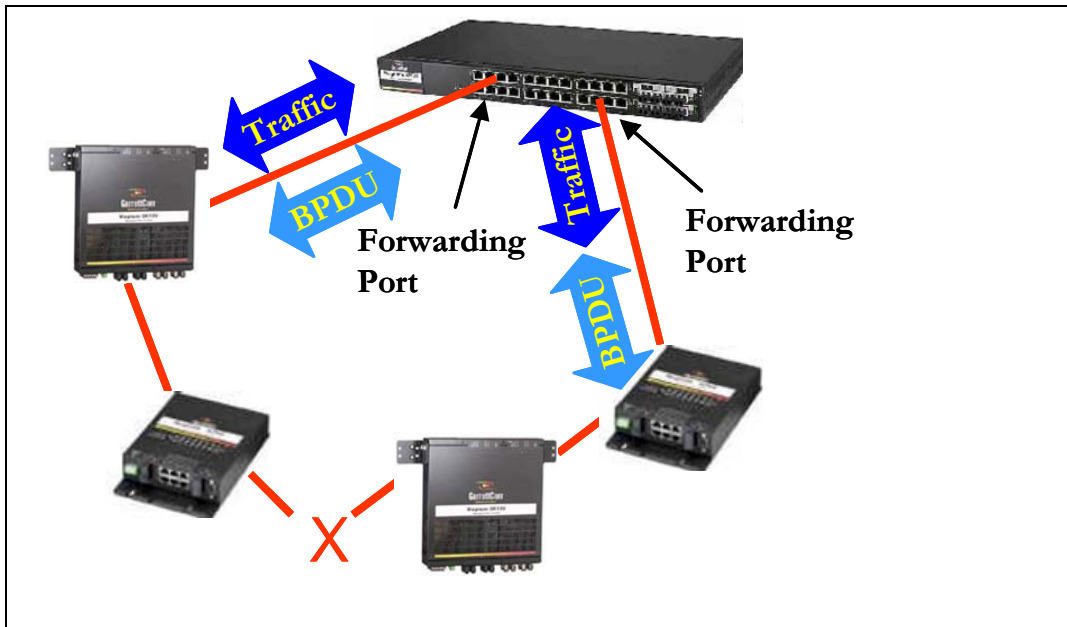


**FIGURE 84** – Normal RSTP/STP operations in a series of switches. Note – this normal status is designated RING\_CLOSED

This normal status is designated as RING\_CLOSED. Operations will continue this way indefinitely until a fault occurs.

A fault anywhere in the ring will interrupt the flow of standard RSTP/STP status-checking BPDU packets, and will signal to RSTP/STP that a fault has occurred. According to the standard RSTP/STP defined sequence, protocol packets are then sent out, gathered up and analyzed to enable RSTP/STP to calculate how to re-configure the LAN to recover from the fault. After the standard RSTP/STP reconfiguration time period (typically 20 to 30 seconds), the RSTP/STP analysis concludes that recovery is achieved by changing the blocking port of the ring port-pair to the forwarding state.

*Intentionally left blank*



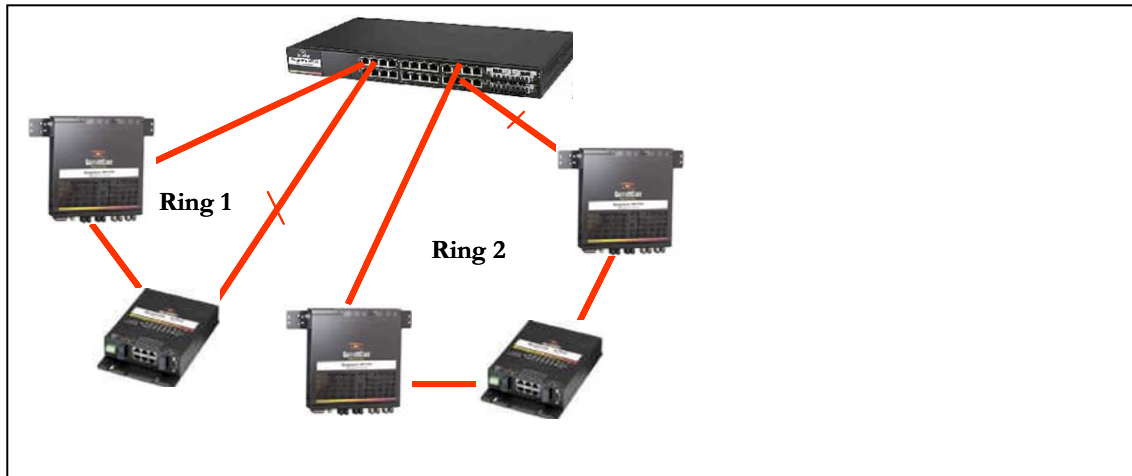
**FIGURE 85** – A fault in the ring interrupts traffic. The blocking port now becomes forwarding so that traffic can reach all switches in the network. Note – the mP62 as well as the ESD42 switches support LLL and can participate in S-Ring as an access switch.

When this change is made by RSTP/STP and both of the ring manager switch's ring ports are forwarding, the fault is effectively bypassed and there is a path for all LAN traffic to be handled properly. This abnormal status is designated RING\_OPEN, and may continue indefinitely, until the ring fault is repaired. At that time, RSTP/STP will change one of the ring control ports to be a blocking port again. This recovery operation may take thirty seconds to a few minutes, depending on the number of switches and other RSTP/STP parameters in operation.

## RSTP/STP Operation with S-Ring

When the Magnum 6K family of switches is used in the network and the S-Ring feature is enabled, the result of a ring-fault is the same but the recovery is faster. The S-Ring capability overrides the normal RSTP/STP analysis for the ring-pair ports of the ring manager (or ring-control) switch, providing quick recovery of the ring fault without conflicting with standard RSTP/STP.

The Magnum 6K family of switches, running MNS-6K software, offer users the choice of selecting S-Ring when RSTP or STP is configured and in use. For the S-Ring, the user must select two ports of one 6K switch to operate as a pair in support of each Ethernet ring, and attach to the two “ends” of each ring as it comes together at the ring control switch.



**FIGURE 86** – More than one S-Ring pair can be selected and more than one S-Ring can be defined per switch. Note – the mP62 as well as the ESD42 switches support LLL and can participate in S-Ring as an access switch

More than one S-Ring port-pair may be selected per ring control switch. Each port-pair will have its own separate attached ring, and each port-pair operates on faults independently. The port-pairs may be of any media type, and the media type does not have to be the same for the pair. With the Magnum 6K family of switches, a port operating at any speed (10Mb, 100Mb, Gb) may be designated as part of an S-Ring port-pair (or RS-Ring port pair) ensuring proper Ethernet configuration of the ring elements.

After selecting a port-pair for a ring, the manager or administrator enables S-Ring (on the selected port-pairs via S-Ring software commands. One command (enable / disable) turns S-Ring on and off. Another command adds / deletes port-pairs. Other commands provide for status reporting on the ring. The MNS-6K software package provides for remote operation, access security, event logs, and other industry-standard managed network capabilities suitable for industrial applications requiring redundancy.

When S-Ring is enabled for a port-pair, fault detection and recovery are armed for the associated ring. The standard RSTP/STP functions are performed by the Magnum 6K family of switches for other ports in the same manner as they would be without S-Ring enabled, when operating in the RING\_CLOSED state. During this state, RS-Ring or S-Ring is also watching the flow of the BPDU packets that move around the ring between the designated part-pair.

The extra capability of S-Ring comes into play when a fault occurs. When the flow of BPDU packets around the ring is interrupted (or when Link-Loss is sensed on one of the ports of the ring port-pair by S-Ring), S-Ring quickly acts to change the blocking port's state to forwarding. No waiting for STP analysis. No waiting for RSTP analysis. No checking for other possible events. No other ports to look at. No 30-second delay before taking action. S-Ring or RS-Ring takes immediate corrective action for quick recovery from the fault in the ring. The ring becomes two strings topologically, as shown above, and there is a path

through the two strings for all normal LAN traffic to move as needed to maintain LAN operations.

When the fault is cured, the re-emergence of the ring structure enables the BPDU packets to flow again between the ring's port-pair. This is recognized by S-Ring (and RSTP/STP) as well as by RS-Ring (and RSTP), and one of the ports in the ring's port pair is changed to the blocking state. S-Ring takes the recovery action immediately, not waiting for the 30-second STP analysis.

Rings are simple structures. Either one port of a pair is forwarding or both are. Not complicated; not much to go wrong.

A Link-loss on one of the Magnum 6K Switch's ring ports is an alternative trigger for S-Ring to initiate fault recovery. The Link-loss trigger almost always comes quicker after a fault (a few milliseconds) than the loss of a BPDU packet which is gated by the standard STP 2-second "hello time" interval. So the Link-loss trigger will almost always provide faster fault detection and faster recovery accordingly.

## LLL with S-Ring

The Link-Loss-Learn™ feature, available on Magnum 6K family of switches can significantly reduce switch address memory decay time, resulting in more rapid reconfiguration. With Link-Loss-Learn (LLL), Magnum 6K family switches in a ring can flush their address memory buffer and quickly re-learn where to send packets, enabling them to participate in a very quick recovery or restoration. Note that a Link-loss on any Magnum 6K Switch port somewhere in the ring is an alternative trigger for S-Ring to act for either fault recovery or ring restoration. The interruption (or the restoration) of the flow of BPDU packets is one trigger, link-loss is another, and action is taken by S-Ring based on whichever occurs first.

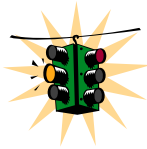
## Ring learn features

One of the S-Ring software commands, "**s-ring learn**", causes the scanning of all ports in the Magnum 6K family of switches for the presence of rings. This command can be a handy tool in setting up the S-Ring product for correct initial operation. During a ring-learn scan, if any port receives a BPDU packet that was also originated by the same switch, the source and destination ports are designated as a ring port-pair and they are automatically added to the S-Ring port-pair list for that 6K Switch. The user can enable or disable ports pairs that are on the S-Ring list by CLI commands in order to exercise final control if needed. This feature is not available with RS-Ring.

# Configuring S-Ring

S-Ring is a licensed software feature from GarrettCom Inc. Before using the S-Ring capabilities; authorize the use of the software with the license key. To obtain the license key, please contact GarrettCom Inc. Sales (for purchasing the S-Ring feature) or Technical Support (to obtain the 12 character key.) If the S-Ring capability was purchased along with the switch, the software license code will be included with the switch.

*Syntax* **authorize <module> key=<security key>** - activate the S-Ring capabilities. Don't forget to use the "save" command to save the key



In the example below – STP is used to show how S-Ring is setup. S-Ring will also work with RSTP. If RSTP is used, GarrettCom Inc. recommends using RS-Ring instead.

```
Magnum6K25# authorize s-ring key=abc123456789
```

```
S-RING Module Successfully Authorized
Please Save Configuration.
```

```
Magnum6K25# save
```

```
Saving current configuration
Configuration saved
```

```
Saving current event logs
Event logs saved
```

```
Magnum 6K25# reboot
```

```
Proceed on rebooting the switch? [ 'Y' or 'N' ] Y
```

```
Do you wish to save current configuration? [ 'Y' or 'N' ] Y
```

```
Saving current configuration
Configuration saved
```

```
Rebooting now...
```

**FIGURE 87** – Activating S-Ring on the switch

Since S-Ring uses RSTP/STP, STP has to be activated and enabled. Please refer to the Chapter on [Spanning Tree Protocol \(STP\)](#) for more information. Some of the commands are repeated here for clarity. Using S-Ring with multiple switches, it is recommended to do the following:

- 1) On the switch which is the root node, authorize the use of S-Ring software
- 2) On the switch which is the root node or where the top of the ring ports are configured, enable STP
- 3) On the root node enable S-Ring and add the necessary ports as S-Ring ports
- 4) On all other switches (except the root node), disable STP
- 5) On all other switches (except the root node), enable LLL



Ports associated with S-Ring should have the following settings

- Auto negotiation - disable
- Speed - Fixed
- Same Speed
- Same Duplex and
- LLL - enable

The necessary commands are

*Syntax* **stp** – STP Configuration mode

*Syntax* **stp <enable | disable>** - Start (Enable) or stop (Disable) STP

*Syntax* **set stp type=<stp | rstp>** - set the spanning tree protocol to be IEEE 802.1d or 802.1w (Spanning Tree Protocol or Rapid Spanning Tree Protocol)

*Syntax* **show active-stp** – Display which version of STP is currently active

*Syntax* **show s-ring** – show the status of S-Ring status and configuration

*Syntax* **s-ring <enable | disable>** - enable or disable S-Ring capabilities

*Syntax* **s-ring learn** – start the learning process to discover the ring and the ports which make up the S-Ring

*Syntax* **s-ring add port=<port1,port2>** - define ports which make up the S-Ring ports. Note as discussed earlier, you can create multiple S-Rings on a switch

*Syntax* **s-ring del port=<port1,port2>** - remove the switch from S-Ring topology by eliminating the end ports on the switch

**Magnum6K25(stp)## show s-ring**

S-Ring Status:

sRing Status: DISABLED

Port 1 Port 2 Status

**Magnum6K25(stp)## s-ring enable**

S-RING Enabled.

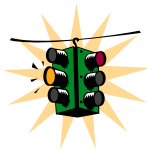
**Magnum6K25(stp)## show s-ring**

S-Ring Status:

sRing Status: ENABLED

| Port 1                                       | Port 2 | Status |
|--|--------|--------|
| <b>Magnum6K25(stp)## s-ring add port=1,7</b> |        |        |
| Ports 1 and 7 Configured for sRing Operation |        |        |
| <b>Magnum6K25# show s-ring</b>               |        |        |
| Magnum Ring Status:                          |        |        |
| sRing Status: ENABLED                        |        |        |
| Port 1                                       | Port 2 | Status |
| 1  | 7      | CLOSED |

**FIGURE 88** – S-Ring configuration commands for root switch



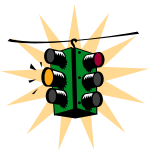
If the BPDU stream is broken, or it finds the *Link-Loss-Learn* signal, the system will immediately force STP to put both ports in forwarding mode. Should that happen, the ring status will be displayed as “OPEN”

If the ring sees BPDUs not belonging to itself on any of the ports, it will set the ring to “UNKNOWN” state, and stop all ring activity on that ring.

The ring activity has several timers and safeguards to prevent erroneous operation. Ring faults are not expected to happen in quick successions. If the ring system sees a sequence of changes in the duration of a less than a second each, it will temporarily ignore the signals and leave STP to reconfigure the ring (network) using the normal IEEE 802.1d algorithms.

With S-Ring it is also critical to setup and configure Link-Loss-Learn as the S-ring can recover from fault situations a lot faster. For configuring LLL, use the commands listed below.

*Syntax III* **<enable | disable>** - enable or disable LLL on the switch



If STP is enabled, Link Loss Learn will not work even though it was enabled. LLL is not enabled on the root node.

*Syntax III* **add port=<port | list | range>** - enable LLL on the list of specified ports

*Syntax III* **del port=<port | list | range>** - disable LLL on the list of specified ports

*Syntax* **show III** – display the status of LLL

```
Magnum6K25# stp
```

```
Magnum6K25(stp)## lll enable
```

Link-Loss-Learn Enabled.

```
Magnum6K25(stp)## lll add port=1,2,3
```

Added Ports: 1,2,3

```
Magnum6K25(stp)## show lll
```

Link-Loss-Learn Status:

LLL Status: ENABLED

LLL Enabled on Ports: 1,2,3

```
Magnum6K25(stp)## lll del port=2,3
```

Deleted Ports: 2,3

```
Magnum6K25(stp)## lll disable
```

Link-Loss-Learn Disabled.

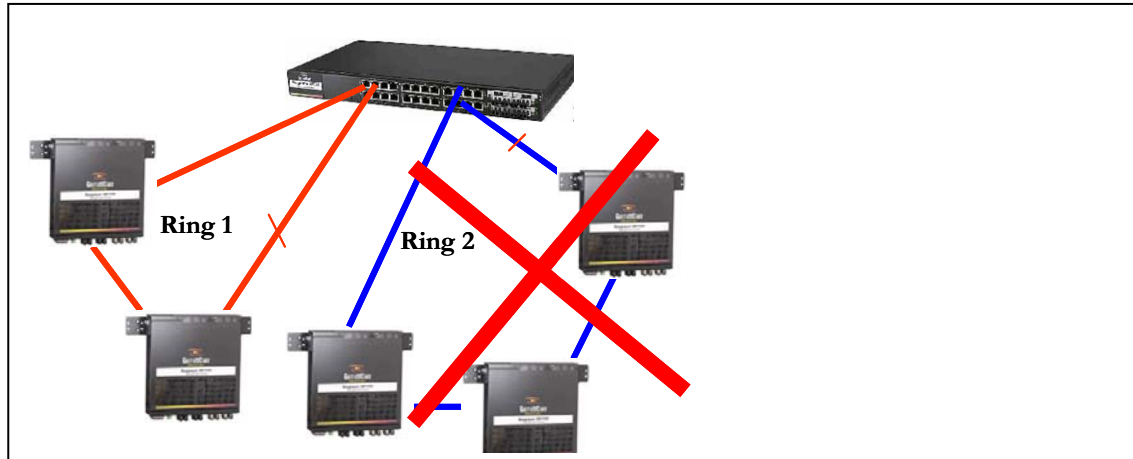
**FIGURE 89** – *Link Loss Learn (LLL) setup. Setup LLL on ports connected to other switches participating in S-Ring*

## RSTP Operation with RS-Ring

When the managed Magnum 6K family of switches is used in the network and the RS-Ring feature is enabled<sup>5</sup>, each of the managed Magnum 6K switch knows of the neighbor and the related associations and topologies. The RS-Ring capability overrides the normal RSTP analysis for the ring-pair ports on each switch, providing quick recovery of the ring fault without conflicting with standard RSTP. Unlike S-Ring, the decision is made by each individual switch and not by the ring master. For RS-Ring, the user must select the two ports (port pairs) and enable RS-Ring on each of the switches in the ring.

---

<sup>5</sup> Note – S-Ring license also enables use of RS-Ring



**FIGURE 90** – More than one RS-Ring cannot be defined per managed Magnum 6K switch. Note – unmanaged switches cannot participate in RS-Ring.

The port-pairs may be of any media type, and the media type does not have to be the same for the pair. With the Magnum 6K family of switches, a port operating at any speed (10Mb, 100Mb, Gb) may be designated as part of a RS-Ring port pair ensuring proper Ethernet configuration of the ring elements.

After selecting a port-pair for a ring, the manager or administrator enables RS-Ring on the selected port-pairs via RS-Ring software commands. One command (enable / disable) turns RS-Ring on and off. Another command adds / deletes port-pairs. Other commands provide for status reporting on the ring. The MNS-6K software package provides for remote operation, access security, event logs, and other industry-standard managed network capabilities suitable for industrial applications requiring redundancy.

When RS-Ring is enabled for a port-pair, fault detection and recovery are armed for the associated ring. The standard RSTP functions are performed by the Magnum 6K family of switches for other ports in the same manner as they would be without RS-Ring enabled, when operating in the RING\_CLOSED state. During this state, RS-Ring is also watching the flow of the BPDUs that move around the ring between the designated port-pair.

The extra capability of RS-Ring comes into play when a fault occurs. When the flow of BPDUs around the ring is interrupted RS-Ring quickly acts to change the blocking port's state to forwarding. No waiting for RSTP analysis. No checking for other possible events. No other ports to look at. No 30-second delay before taking action. RS-Ring takes immediate corrective action for quick recovery from the fault in the ring. The ring becomes two strings topologically, and there is a path through the two strings for all normal LAN traffic to move as needed to maintain LAN operations.

When the fault is cured, the re-emergence of the ring structure enables the BPDUs to flow again between the ring's port-pair. This flow of packets may take as long as 6 seconds in most situations. This is recognized by RS-Ring as well as by RSTP and one of the ports in the defined ring port pair is changed to the blocking state. RS-Ring takes the recovery action immediately, not waiting for the 30-second STP analysis.

Rings are simple structures. Either one port of a pair is forwarding or both are. Not complicated; not much to go wrong.

## Configuring RS-Ring

RS-Ring is a licensed software feature from GarrettCom Inc. Before using the RS-Ring capabilities; authorize the use of the software with the S-Ring license key. The same license key is used for either the S-Ring or RS-Ring. To obtain the license key, please contact GarrettCom Inc. Sales (for purchasing the S-Ring feature) or Technical Support (to obtain the 12 character key.) If the S-Ring capability was purchased along with the switch, the software license code will be included with the switch.

*Syntax* **authorize <module> key=<security key>** - activate the RS-Ring (or S-Ring) capabilities. Don't forget to use the "save" command to save the key

```
Magnum6K25# authorize s-ring key=abc123456789
```

```
S-RING Module Successfully Authorized
Please Save Configuration.
```

```
Magnum6K25# save
```

```
Saving current configuration
Configuration saved
```

```
Saving current event logs
Event logs saved
```

**FIGURE 91** – Activating RS-Ring on the switch

Since RS-Ring uses RSTP, RSTP has to be activated and enabled. Please refer to the Chapter on [Rapid Spanning Tree Protocol \(RSTP\)](#) for more information. Some of the commands are repeated here for clarity. Using RS-Ring with multiple switches, it is recommended to do the following:

- 1) On all switches in the ring topology, authorize the use of RS-Ring software
- 2) On all the switches in the ring, enable RSTP
- 3) On all the switches in the ring designate the ports which make the ring pair
- 4) Only the ports on the RS-Ring must be enabled with RS-Ring capability
- 5) DO NOT enable S-Ring and RS-Ring in a given ring at the same time.
- 6) Enable RS-Ring on each switch

Ports associated with RS-Ring should have the following settings

- Same Speed - 100Mbps connection provides faster recovery than 10 Mbps networks
- Same Duplex capabilities -

The necessary commands are

*Syntax* **rstp** – STP Configuration mode

*Syntax* **rstp** <enable | disable> - Start (Enable) or stop (Disable) STP

*Syntax* **set stp type=<stp | rstp>** - set the spanning tree protocol to be IEEE 802.1w (Rapid Spanning Tree Protocol)

*Syntax* **show active-stp** – Display which version of STP is currently active

*Syntax* **show rs-ring** – show the status of RS-Ring status and configuration

*Syntax* **rs-ring** <enable | disable> - enable or disable RS-Ring capabilities

*Syntax* **rs-ring add port=<port1,port2>** - define ports which make up the RS-Ring ports. Note as discussed earlier, you can create multiple RS-rings on a switch

*Syntax* **rs-ring del port=<port1,port2>** - remove the switch from RS-Ring topology by eliminating the end ports on the switch

**Magnum 6K25# authorize s-ring key=BABABABABABAB**

S-RING Module Successfully Authorized  
Please Save Configuration.

**Magnum 6K25# save**

Saving current configuration  
Configuration saved

Saving current event logs  
Event logs saved

**Magnum 6K25# show rs-ring**

RS-RING status : Disabled  
RS-RING set on ports : NONE

**Magnum 6K25# show active-stp**

Current Active Mode: RSTP.  
RSTP is Disabled.

**Magnum 6K25# rstp**

**Magnum 6K25(rstp)## rstp enable**

Successfully set the RSTP status

**Magnum 6K25(rstp)## show active-stp**

Current Active Mode: RSTP.  
RSTP is Enabled.

**Magnum 6K25(rstp)## rs-ring add port=13,14**

Added Ports: 13,14

**Magnum 6K25(rstp)## show rs-ring**

RS-RING status : Disabled  
RS-RING set on ports : 13,14

```
Magnum 6K25(rstp)## rs-ring enable
```

```
RS-RING enabled.
```

```
Magnum 6K25(rstp)## show rs-ring
```

```
RS-RING status      : Enabled
```

```
RS-RING set on ports : 13,14
```

```
Magnum 6K25(rstp)## rs-ring disable
```

```
RS-RING disabled.
```

```
Magnum 6K25(rstp)## rs-ring del port=13,14
```

```
Deleted Ports: 13,14
```

```
Magnum 6K25(rstp)## show rs-ring
```

```
RS-RING status      : Disabled
```

```
RS-RING set on ports : NONE
```

```
Magnum 6K25(rstp)## exit
```

```
Magnum 6K25#
```

FIGURE 92 – RS-Ring configuration commands

## List of commands in this chapter

*Syntax* **authorize** <module> **key**=<security key> - activate the S-Ring capabilities. Don't forget to use the "save" command to save the key

*Syntax* **stp** – STP Configuration mode

*Syntax* **stp** <enable | disable> - Start (Enable) or stop (Disable) STP

*Syntax* **set stp type**=<stp | rstp> - set the spanning tree protocol to be IEEE 802.1d or 802.1w (Spanning Tree Protocol or Rapid Spanning Tree Protocol)

*Syntax* **show active-stp** – Display which version of STP is currently active

*Syntax* **show s-ring** – show the status of S-Ring status and configuration

*Syntax* **s-ring** <enable | disable> - enable or disable S-Ring capabilities

*Syntax* **s-ring learn** – start the learning process to discover the ring and the ports which make up the S-Ring

*Syntax* **s-ring add port**=<port1,port2> - define ports which make up the S-ring ports. Note as discussed earlier, you can create multiple S-Rings on a switch

*Syntax* **s-ring del port=<port1,port2>** - remove the switch from S-Ring topology by eliminating the end ports on the switch

*Syntax* **lll <enable | disable>** - enable or disable LLL on the switch

*Syntax* **lll add port=<port | list | range>** - enable LLL on the list of specified ports

*Syntax* **lll del port=<port | list | range>** - disable LLL on the list of specified ports

*Syntax* **show lll** – display the status of LLL

*Syntax* **rstp** – STP Configuration mode

*Syntax* **rstp <enable | disable>** - Start (Enable) or stop (Disable) STP

*Syntax* **set stp type=<stp | rstp>** - set the spanning tree protocol to be IEEE 802.1d or 802.1w (Rapid Spanning Tree Protocol)

*Syntax* **show active-stp** – Display which version of STP is currently active

*Syntax* **show rs-ring** – show the status of RS-Ring status and configuration

*Syntax* **rs-ring <enable | disable>** - enable or disable RS-Ring capabilities

*Syntax* **rs-ring add port=<port1,port2>** - define ports which make up the RS-Ring ports. Note as discussed earlier, you can create multiple RS-Rings on a switch

*Syntax* **rs-ring del port=<port1,port2>** - remove the switch from RS-Ring topology by eliminating the end ports on the switch



## 13 – Dual-Homing

*Fault tolerance options for edge devices*

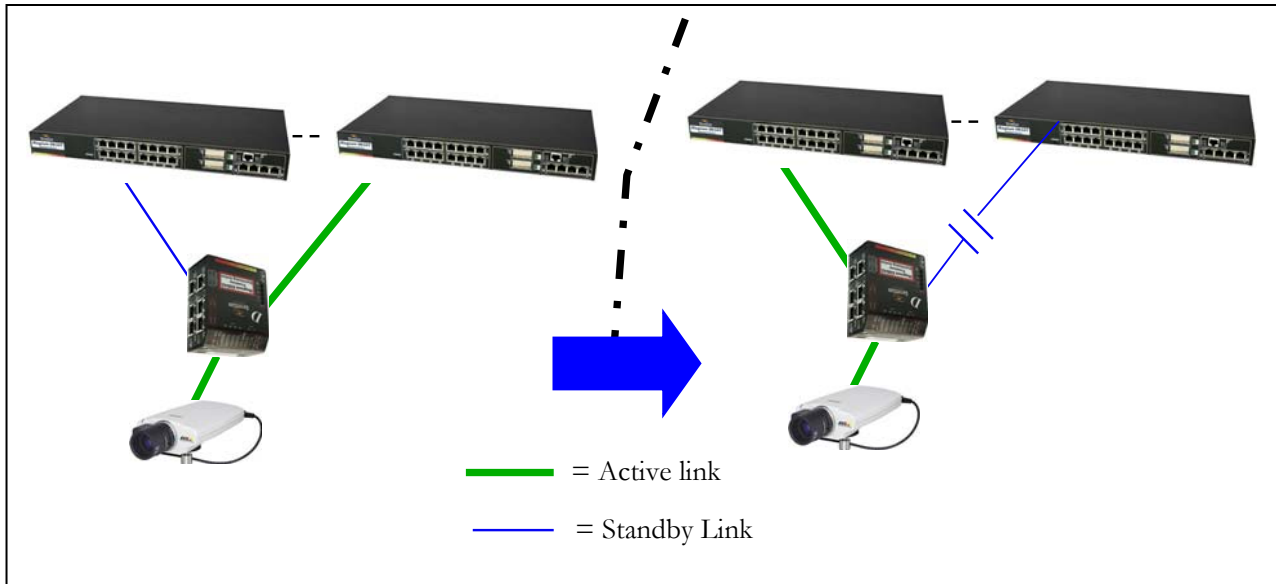
**D**esigning and implementing high-availability Ethernet LAN topologies in networks can be challenging. Traditionally, the choices for redundancy for edge of the network devices were too limited, too expensive, and too complicated to be considered in most networks. Redundancy at the edge of the network is greatly simplified by the using dual-homing.



### Dual-Homing concepts

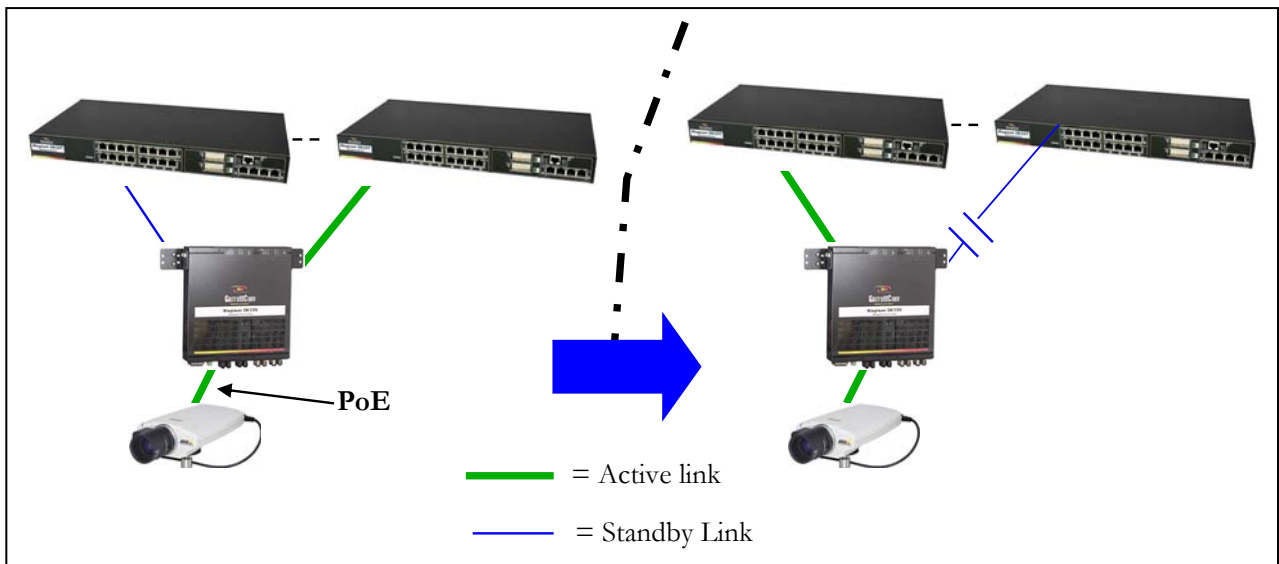
In Ethernet LANs, dual-homing is a network topology that adds reliability by allowing a device to be connected to the network by way of two independent connection points (points of attachment).

One connection point is the operating connection, and the other is a standby or back-up connection that is activated in the event of a failure of the operating connection. A dual-homing switch (such as EDS42) offers two attachments into the network or two independent media paths and two upstream switch connections. In the case of the Magnum 6K family of switches, any two ports can be defined as dual-home ports to provide this level of redundancy. Loss of the Link signal on the operating port connected upstream indicates a fault in that path, and traffic is quickly moved to the standby connection to accomplish a fault recovery.



**FIGURE 93** – Dual-homing using ESD42 switch and Magnum 6K family of switches. In case of a connectivity break – the connection switches to the standby path or standby link

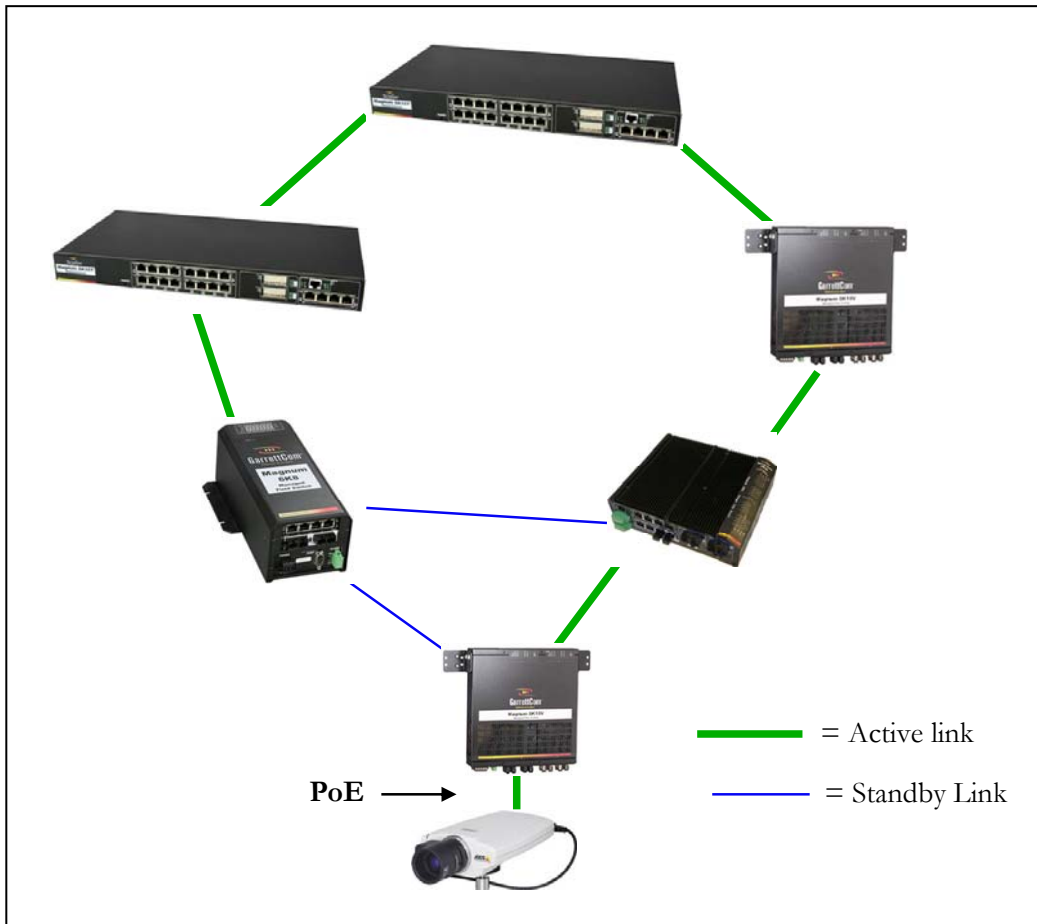
In those situations where the end device is a PoE device (for example, a video surveillance camera, as shown above) a Magnum 6K switch with MNS-6K can provide PoE to the end devices as well as other advantages such as IGMP, managed configuration and more. To provide the managed reliability to the end devices, dual-homing can be used with MNS-6K devices.



**FIGURE 94** – Dual-homing using Magnum 6K family of switches. Note the end device (video surveillance camera) can be powered using PoE options on Magnum 6K family of switches. In case of a connectivity break – the connection switches to the standby path or standby link

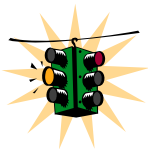
Because it takes advantage of Ethernet standards, the dual-homing redundancy features of the ESD42 as well as those for MNS-6K work with any brands or models of Ethernet

switches upstream. With MNS-6K, the user has to define the set of ports which make up the dual-home ports.



**FIGURE 95** – Using S-Ring, RS-Ring and dual-homing, it is possible to build networks resilient not only to a single link failure but also for one device failing on the network

The following points should be remembered for setting up dual-homing



- **Configure dual-homing before connecting the Ethernet connectors (cables) in the switch<sup>6</sup>**
- **Only one set of dual-homing ports can be defined per switch**
- Port types (Copper vs fiber) as well as speeds can be mixed and matched – both ports need not be identical
- By default dual-homing is turned off – you have to enable it after the ports are defined
- Dual-homing ports can span different modules in a switch

<sup>6</sup> If dual homing is not configured there is a potential a loop can be created and either STP or RSTP will setup the port in the active stand-by mode. Dual-homing may not work if one of the dual-homed port is in active standby. To avoid that situation, it is recommended to configure dual-homing first.

## Dual-Homing Modes

There are two modes in which the dual-homing works. The first one is where the ports are “equivalent” i.e. if one port fails, the other one take over, however, if the first (failed) port recovers, the active port does not switch back.

The second mode of operation is primary-secondary mode. In this mode of operation, the primary port is explicitly defined and the secondary port is explicitly defined. In the primary-secondary mode of operation, if the primary fails, the secondary takes over. When the primary recovers, the secondary switches back from active state to passive state and the primary port is now the active port.

The primary-secondary mode has to be explicitly setup. The primary-secondary mode of operation is only possible on managed switches such as the Magnum 6K family of switches.

The primary-secondary mode of operation allows the network manager to determine on which path the packets will flow (as a default).

## Configuring Dual-Homing

The following commands are used for configuring dual-homing

*Syntax* **dualhome** – enter the dual-homing configuration sub-system

*Syntax* **dualhome** <enable | disable> – enable or disable dual-homing

*Syntax* **dualhome add port1=<port#> port2=<port#>** – dual-homing setup similar to that of unmanaged switches such as ESD42

**OR**

*Syntax* **dualhome add primary=<port#> secondary=<port#>** – dual-homing setup as primary-secondary mode

*Syntax* **dualhome del** – Delete the dual-homing setup

*Syntax* **show dualhome** – Display dual-homing status

The following set of commands show how dual-homing is setup. In the example below both modes of dual-homing operation is setup.

**Magnum 6K25# dualhome ?**

dualhome : Configures Dual homing

Usage

dualhome <enter>

**Magnum 6K25# show dualhome**

Dual Homing Status : DISABLED

**Magnum 6K25# dualhome****Magnum 6K25(dualhome)## dualhome add port1=10 port2=11**

Dual Homing Ports configured

**Magnum 6K25(dualhome)## dualhome enable**

Dual Homing Enabled.

**Magnum 6K25(dualhome)## show dualhome**

Dual Homing Status : ENABLED

Dual Homing Ports : 10 11

Dual Homing Active On Port : 10

**Magnum 6K25(dualhome)## dualhome del**

Dual Homing Ports Deleted and Dual Homing Disabled.

**Magnum 6K25(dualhome)## show dualhome**

Dual Homing Status : DISABLED

**Magnum 6K25(dualhome)## dualhome add primary=10 secondary=11**

Dual Homing Ports configured

**Magnum 6K25(dualhome)## show dualhome**

Dual Homing Status : DISABLED

Dual Homing Ports : Primary: 10, Secondary: 11

**Magnum 6K25(dualhome)## dualhome enable**

Dual Homing Enabled.

**Magnum 6K25(dualhome)## show dualhome**

Dual Homing Status : ENABLED

Dual Homing Ports : Primary: 10, Secondary: 11

Dual Homing Active On Port : 10

**Magnum 6K25(dualhome)## exit****Magnum 6K25#**

FIGURE 96 – *configuring dual-homing*

## List of commands in this chapter

*Syntax* **dualhome** – enter the dual-homing configuration sub-system

*Syntax* **dualhome** <enable | disable> – enable or disable dual-homing

*Syntax* **dualhome add port1=<port#> port2=<port#>** – dual-homing setup similar to that of unmanaged switches such as ESD42

### **OR**

*Syntax* **dualhome add primary=<port#> secondary=<port#>** – dual-homing setup as primary-secondary mode

*Syntax* **dualhome del** – Delete the dual-homing setup

*Syntax* **show dualhome** – Display dual-homing status

# 14 – Link Aggregation Control Protocol (LACP)

*Increase Network throughput and reliability*

**L**ink aggregation Link Aggregation Control Protocol (LACP) is part of an IEEE specification (IEEE 802.3ad) that allows several physical ports to be grouped or bundled together to form a single logical channel. This increases the throughput across two devices and provides improved reliability.



## LACP concepts

The IEEE802.3ad standard provides for the formation of a single Layer 2 link from two or more standard Ethernet links using the Link Aggregation Control Protocol (LACP).

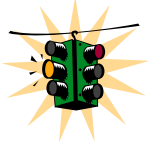
LACP provides a robust means of assuring that both ends of the link are up and agree to be members of the aggregation before the link member is activated. LACP trunking is a method of combining physical network links into a single logical link for increased bandwidth. With LACP the effective bandwidth of a trunk and network availability is increased. Two or more Fast Ethernet connections are combined as one logical trunk in order to increase the bandwidth and to create resilient and redundant links. By taking multiple LAN connections and treating them as a unified, aggregated link, Link Aggregation provides the following important benefits:

- Higher link availability – in case a link fails, the other links continue to operate
- Increased link capacity – the effective throughput is increased
- Better port utilization – allows unused ports to be used as trunk ports allowing better throughput and availability
- Interoperability – being a standard allows LACP to work across different hardware platforms where LACP is supported

Failure of any one physical link will not impact the logical link defined using LACP. The loss of a link within an aggregation reduces the available capacity, but the connection is maintained and the data flow is not interrupted.

The performance is improved because the capacity of an aggregated link is higher than each individual link alone. 10Mbps or 10/100Mbps or 100Mbps ports can be grouped together to form one logical link.

Instead of adding new hardware to increase speed on a trunk – one can now use LACP to incrementally increase the throughput in the network, preventing or deferring hardware upgrades. Some known issues with LACP on the Magnum 6K family of switches are:



- LACP will not work on Half Duplex ports.
- All trunk ports must be on the same module. Trunk ports cannot be spread out across different modules.
- All trunk ports **MUST** have the same speed setting. If the speed is different, LACP shows an error indicating speed mismatch.
- Many switches do not forward the LACPDU by default. So, it is possible to hook up multiple ports to these switches and create an Ethernet loop. (In many cases this is prevented by Spanning Tree running on these switches).
- All ports in a trunk group should be members of the same VLAN. Each port can be a member of multiple VLANs, but each port should have at least one VLAN that is common to **both** the port groups.
- The LACPDU packets are sent out every 30 seconds. It is possible that in configuring LACP, a loop can be created until LACP notification is completed. It is recommended to configure LACP first and then physically connect the ports to avoid this potential issue.
- Port Security will not work with the ports configured for LACP.
- IGMP will work with the primary LACP port only. All IGMP traffic is sent via a primary port. If needed, this port can be mirrored for traffic analysis.

## LACP Configuration

For LACP to work on the Magnum 6K family of switches, only one trunk per module can be created. Some valid connections are shown in the picture below.



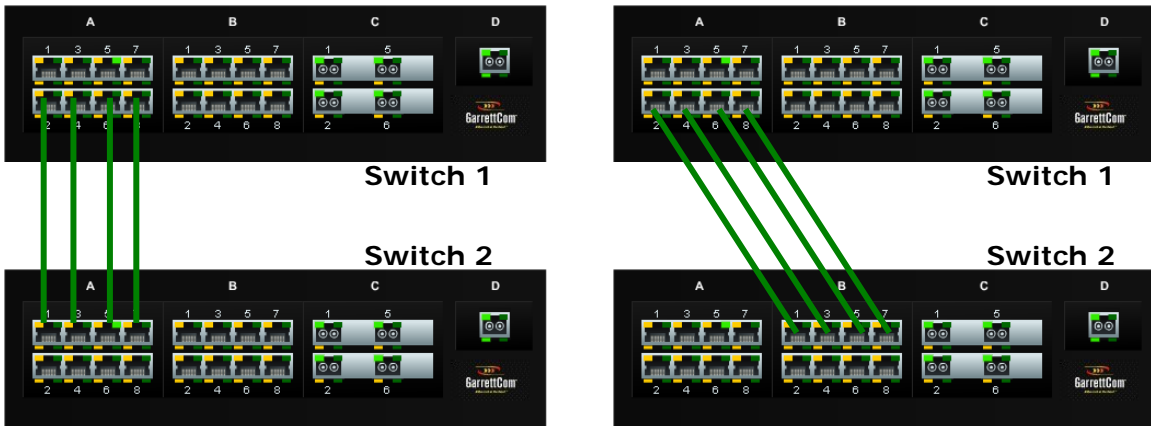


FIGURE 97 – Some valid LACP configurations.

Should trunks be created so as to span multiple ports, a “trunk mismatch” error message is printed on the console. An example of an incorrect configuration is shown below.

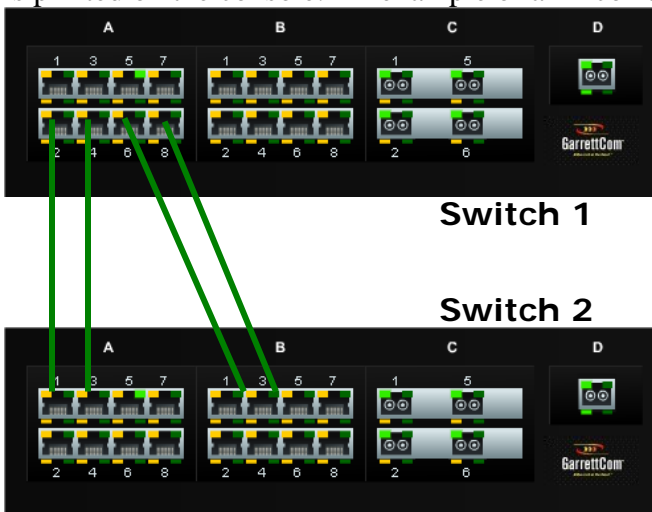
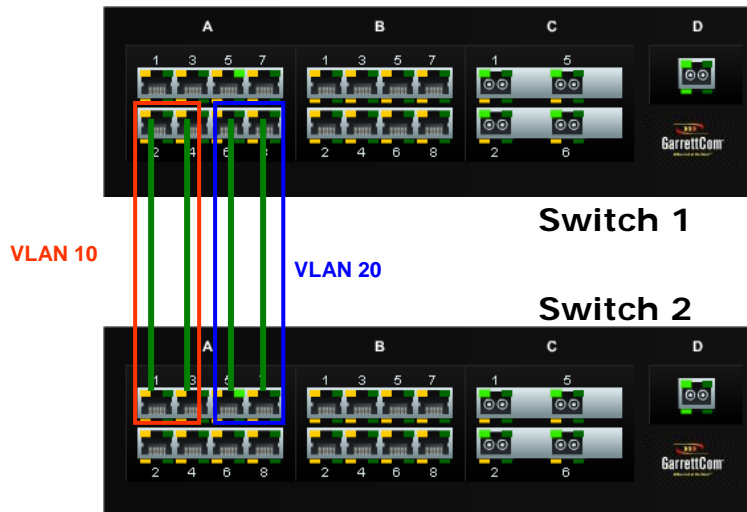


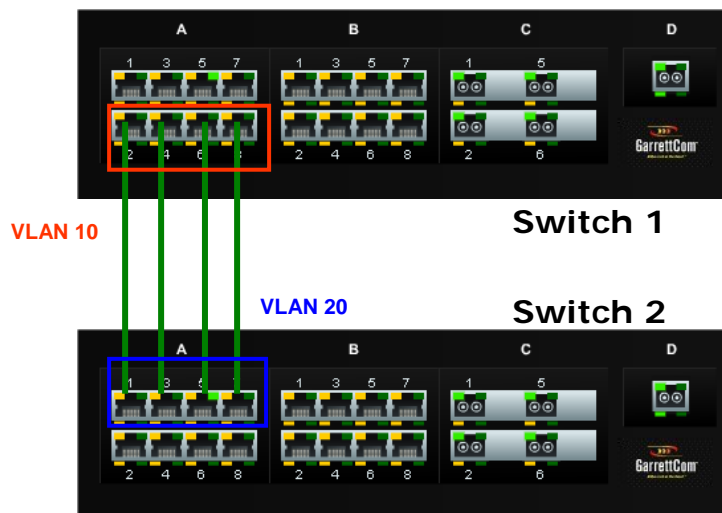
FIGURE 98 – an incorrect LACP connection scheme for Magnum 6K family of switches. All LACP trunk ports must be on the same module and cannot span different modules.

Another example is highlighted below where some ports belong to VLAN 10 (shown in red) and other ports belong to VLAN 20 (shown in blue). If the port groups do not have a common VLAN between them, LACP does not form a connection.

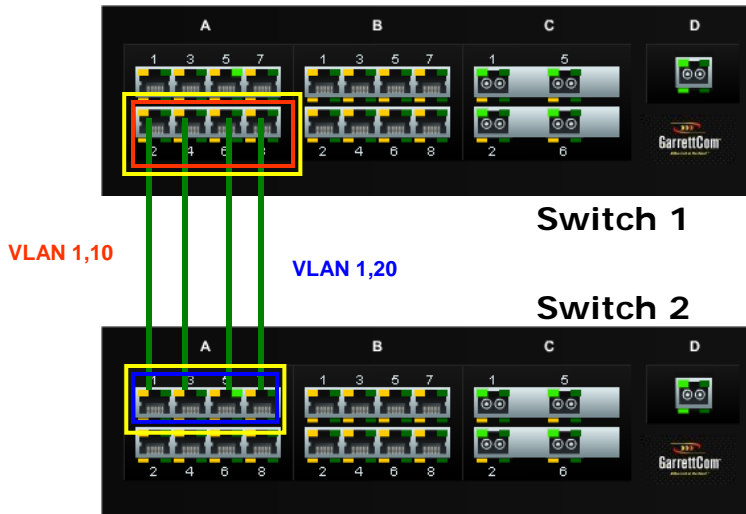


**FIGURE 99** – In this figure, even though the connections are from one module to another, this is still not a valid configuration (for LACP using 4 ports) as the trunk group belongs to two different VLANs.

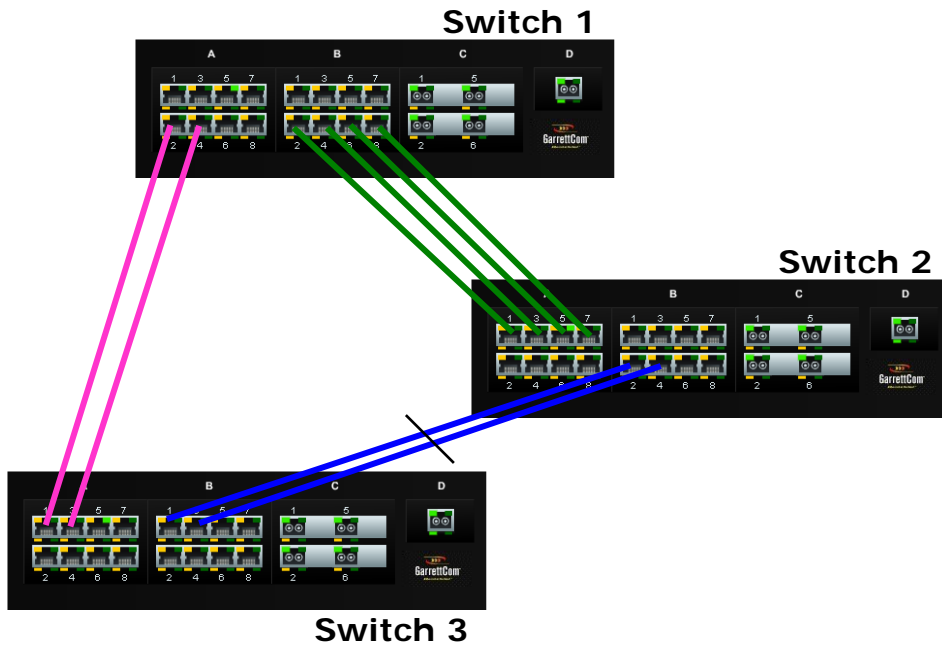
However – on each switch, the set of ports can belong to same VLANs as shown in the figure below. While the ports belong to the same VLANs, there is no common VLAN between the switches and hence the LACPDU cannot be transmitted. This configuration will not work in the LACP mode.



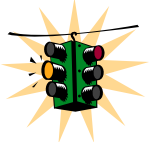
**FIGURE 100** - In the figure above, there is no common VLAN between the two sets of ports, so packets from one VLAN to another cannot be forwarded. There should be at least one VLAN common between the two switches and the LACP port groups.



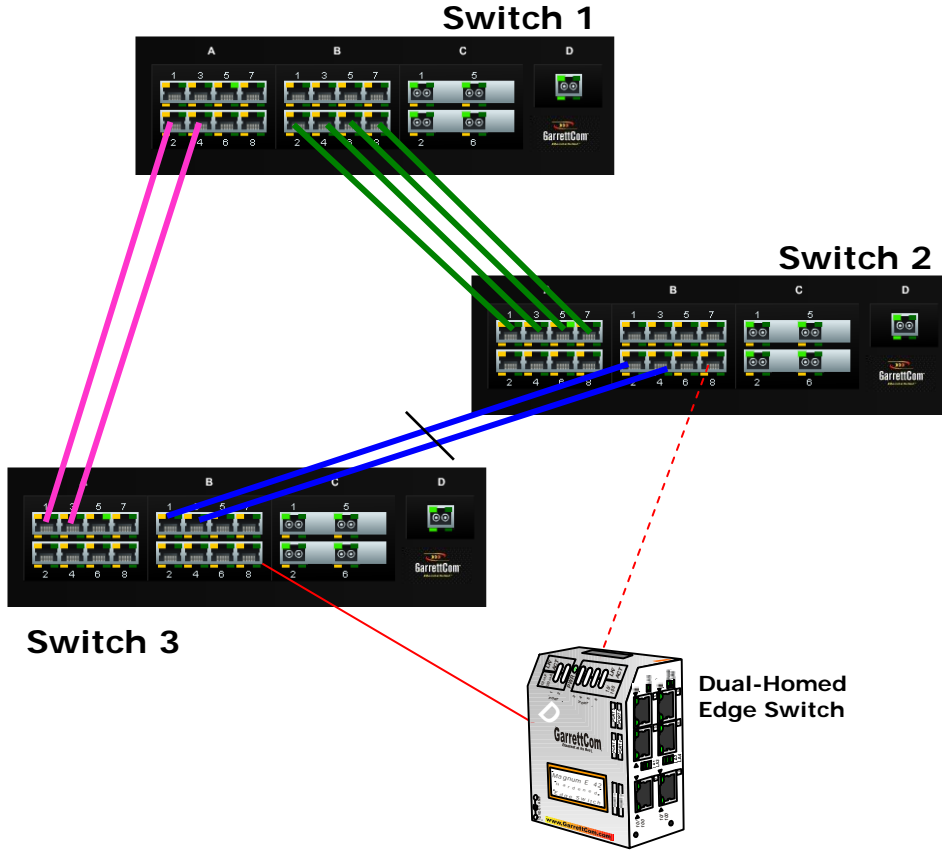
**FIGURE 101** – This configuration is similar to the previous configuration, except there is a common VLAN (VLAN 1) between the two sets of LACP ports. This is a valid configuration.



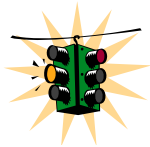
**FIGURE 102** – In the architecture above, using RSTP and LACP allows multiple switches to be configured together in a meshed redundant link architecture. First define the RSTP configuration on the switches. Then define the LACP ports. Then finally connect the ports together to form the meshed redundant link topology as shown above.



Using the Magnum edge switch with dual-homing allows the edge devices to have link level redundancy as well – bringing the fault tolerance from the network to the edge.

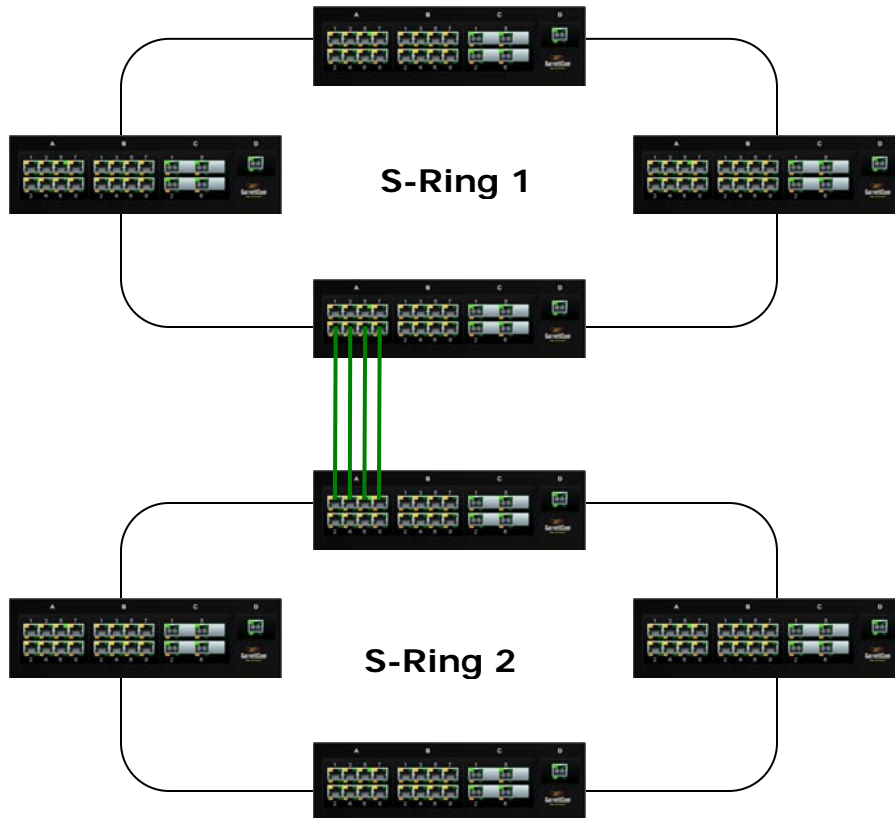


**FIGURE 103** – LACP, along with RSTP/STP brings redundancy to the network core or backbone. Using this reliable core with a dual-homed edge switch brings reliability and redundancy to the edge of the network



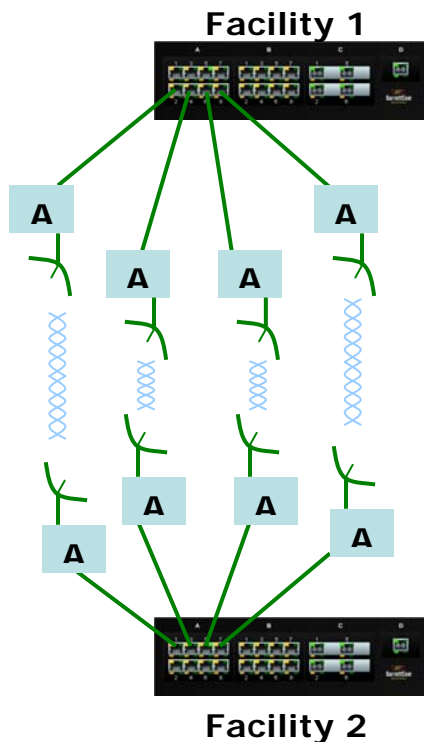
It is recommended not to use LACP with S-Ring at this time.

Since S-Ring and LACP use the same BPDUs (called LACPDUs), the architecture shown below is not supported in this release.



**FIGURE 104** – *This architecture is not recommended*

LACP can be used for creating a reliable network between two facilities connected via a wireless bridge. As shown in the figure below, four trunk ports are connected to four wireless bridge pairs. This increases the effective throughput of the wireless connections and also increases the reliability. If one of the bridges were to stop functioning, the other three will continue to operate, providing a very reliable infrastructure.



**FIGURE 105** – Creating a reliable infrastructure using wireless bridges (between two facilities) and LACP. “A” indicates a Wi-Fi wireless Bridge or other wireless Bridges.

The list of commands to configure, edit and manage LACP on the Magnum 6K family of switches is the following:

**Syntax lacp** - enable the LACP configuration module within CLI

**Syntax lacp** <enable | disable> - enable or disable LACP<sup>7</sup>

**Syntax add port**=<number | list | range> [priority=<0-65535>] – add the specified list of ports to form the logical LACP trunk. Default value for priority is 32768. The lower the value assigned to priority, the higher the priority. The port with the highest priority is the primary port.

**Syntax del port**=<number | list | range> - delete specified ports from the LACP membership

**Syntax edit port**=<number | list | range> [priority=<priority>] - edit the membership of the ports specified. The priority can be from 0 – 65535

**Syntax show lacp** – displays the status and other relevant LACP information

<sup>7</sup> Before enabling, please ensure that the correct ports are configured. If network connectivity is lost due to a port being configured as a LACP port, you will need to physically access the switch via the console to correct this error.

Some other definitions are worth noting are primary port. Primary port is the port over which specific traffic like Multicast (IGMP), unknown Unicast and broadcast traffic is transmitted. As shown by the add port command, the port with the lowest priority value has the highest priority and is designated as the primary port. If traffic analysis is required, it is recommended to mirror the primary port (and physically disconnect the other ports if all traffic needs to be captured).

If multiple ports have the same priority, the first port physically connected becomes the primary port. In case the ports are already connected, the port with the lowest port count becomes the primary port i.e. if ports 4, 5, 6 are designated as the LACP group, port 4 would become the primary port.

If the primary port fails, the next available secondary port is designated as the primary port. So in the example above, if port 4 fails, port 5 will be designated as the primary port.

```

Magnum 6K25# show lacp
LACP is Disabled.

Magnum 6K25# lacp

Magnum 6K25(lacp)## add port=14,15,16

Error : LACP is disabled.
Magnum 6K25(lacp)## lacp enable

LACP Enabled.
Magnum 6K25(lacp)## add port=13-16

Port(s) added successfully.
Magnum 6K25(lacp)## show lacp

Orphan Ports:

Port Priority Trunk
=====
13 32768 Link Down
14 32768 Link Down
15 32768 Link Down
16 32768 Peer Not a Trunk

Magnum 6K25(lacp)## del port=16

Port(s) deleted successfully.
Magnum 6K25(lacp)## show lacp

Orphan Ports:
    
```

*Need to enable LACP before ports can be added to the trunk group*

*Indicates no LACP BPDU can be received from this port. This port was in use and was an error to add this. The next few steps delete this port and add the proper port. See other messages below.*

```

Port Priority Trunk
=====
13 32768 Link Down
14 32768 Link Down
15 32768 Link Down

Magnum 6K25(lacp)## add port=12

Port(s) added successfully.
Magnum 6K25(lacp)## show lacp

Orphan Ports:

Port Priority Trunk
=====
12 32768 Link Down
13 32768 Link Down
14 32768 Link Down
15 32768 Link Down

Magnum 6K25(lacp)## exit

Magnum 6K25# show lacp

Orphan Ports:

Port Priority Trunk
=====
12 32768 Link Down
13 32768 Link Down
14 32768 Link Down
15 32768 Link Down

Magnum 6K25#

```

FIGURE 106 – *Configuring LACP*

The error messages received when a trunk port is not configured properly are as follows:

|                         |   |
|-------------------------|---|
| <b>Link Down</b>        | Link is down or the cable is not connected  |
| <b>Half duplex</b>      | A Half Duplex port – Half Duplex ports cannot participate in LACP   |
| <b>Loop Detected</b>    | Indicates the other side does not have LACP configured. Without LACP configured on both switches, the network will create an Ethernet loop.                   |
| <b>Peer Not a Trunk</b> | When no LACPDU was received (or cannot be received) from the peer. This maybe due to the fact that the port is already in use or is shutdown or not available |
| <b>Speed Mismatch</b>   | All ports in a trunk should have the same speed. If one port's speed does not match the other ports, this specific port cannot join the port group.           |



**Trunk Mismatch** The other switch sent a BPDU which did not match the trunk information associated with this port. This happens when the port is connected to a different switch, or a different module in the Magnum 6K switch

The output of the LACP command in the network shown below

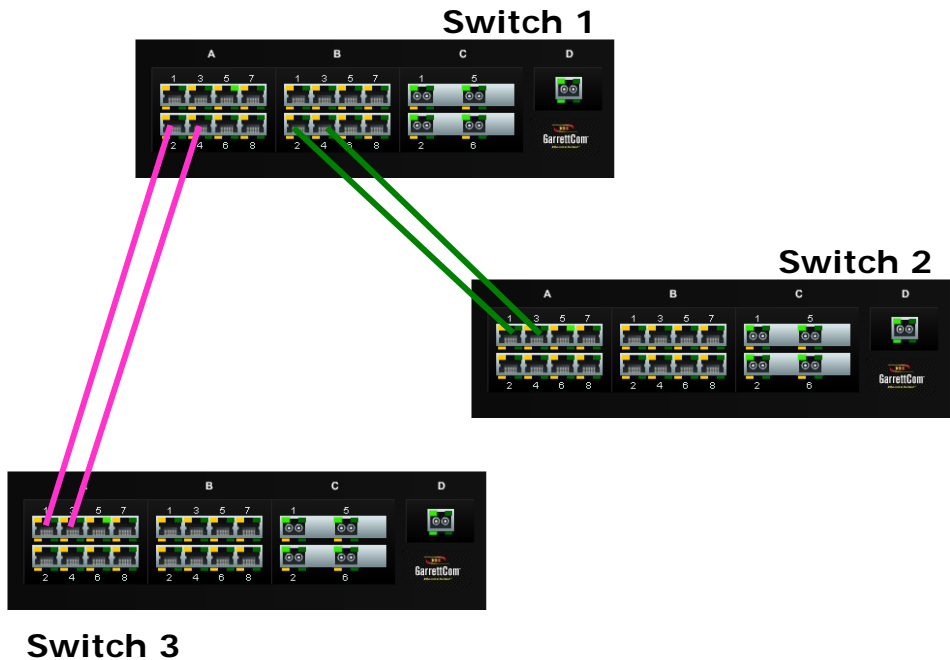


FIGURE 107 – The network for the ‘show lacp’ command listed below

In the figure shown above, Switch 1 has ports 11 and 15 forming the first trunk, connecting to Switch 3. Switch 1 also has ports 17 and 23 forming the second trunk on Switch 2. The ‘show lacp’ command was executed on Switch 1.

```

Magnum 6K(lacp)## show lacp
Trunk Id       : 1
Trunk Status   : Trunk Active
Primary Port   : 11
Trunk Partner  : 00:20:06:25:11:40

Member Ports:

Port Priority Trunk
=====
 11 32768 Primary Port
 15 32768 Member Port

Trunk Id       : 2
Trunk Status   : Trunk Active
Primary Port   : 17
    
```

*Unique ID of trunk*

*MAC address of Switch 3*

*Ports belonging to this trunk*

|               |                     |              |
|---------------|---------------------|--------------|
| Trunk Partner | : 00:20:06:25:72:90 |              |
| Member Ports: |                     |              |
| Port          | Priority            | Trunk        |
| =====         |                     |              |
| 17            | 32768               | Primary Port |
| 23            | 32768               | Member Port  |

**FIGURE 108** – LACP information over a network

## List of commands in this chapter

**Syntax lacp** - enable the LACP configuration module within CLI

**Syntax lacp <enable | disable>** - enable or disable LACP

**Syntax add port=<number | list | range> [priority=<0-65535>]** – add the specified list of ports to form the logical LACP trunk. Default value for priority is 32768. The lower the value assigned to priority, the higher the priority. The port with the highest priority is the primary port (over which certain types of traffic like IGMP is transmitted)

**Syntax del port=<number | list | range>** - delete specified ports from the LACP membership

**Syntax edit port=<number | list | range> [priority=<priority>]** - edit the membership of the ports specified. The priority can be from 0 – 65535

**Syntax show lacp** – displays the status and other relevant LACP information

## 15 – Quality of Service

*Prioritize traffic in a network*

**Q**uality of Service (QoS) refers to the capability of a network to provide different priorities to different types of traffic. Not all traffic in the network has the same priority. Being able to differentiate different types of traffic and allowing this traffic to accelerate through the network improves the overall performance of the network and provides the necessary quality of service demanded by different users and devices. The primary goal of QoS is to provide priority including dedicated bandwidth.



### QoS concepts

The Magnum 6K family of switches supports QoS as specified in the IEEE 802.1p and IEEE 802.1q standards.

QoS is important in network environments where there are time-critical applications, such as voice transmission or video conferencing, which can be adversely effected by packet transfer delays or other latency in a network.

Most switches today implement buffers to queue incoming packets as well as outgoing packets. In a queue mechanism, normally the packet which comes in first leaves first (FIFO) and all the packets are serviced accordingly. Imagine, if each packet had a priority assigned to it. If a packet with a higher priority than other packets were to arrive in a queue, the packet would be given a precedence and moved to the head of the queue and would go out as soon as possible. The packet is thus preempted from the queue and this method is called preemptive queuing.

Preemptive queuing makes sense if there are several levels of priorities, normally more than two. If there are too many levels, then the system has to spend a lot of time managing the preemptive nature of queuing. IEEE 802.1p defines and uses eight levels of priorities. The eight levels of priority are enumerated 0 to 7, with 0 the lowest priority and 7 the highest.

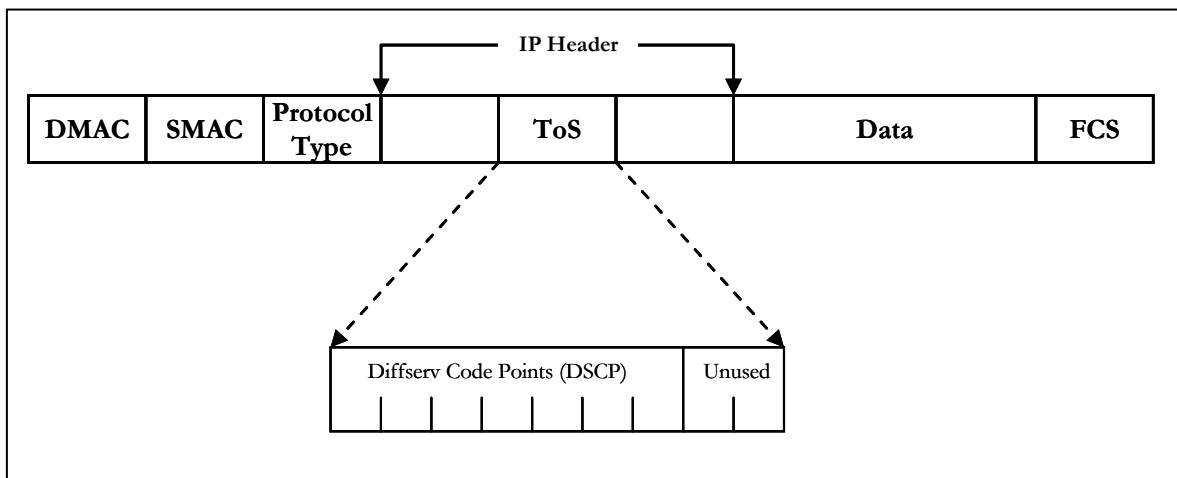
To make the preemptive queuing possible, most switches implement at least two queue buffers. The Magnum 6K family of switches has two priority queues, 1 (low) and 0 (high). When tagged packets enter a switch port, the switch responds by placing

the packet into one of the two queues, and depending on the precedence levels the queue could be rearranged to meet the QoS requirements.

QoS refers to the level of preferential treatment a packet receives when it is being sent through a network. QoS allows time sensitive packets such as voice and video, to be given priority over time insensitive packets such as data. Differentiated Services (DiffServ or DS) are a set of technologies defined by the IETF (Internet Engineering Task Force) to provide quality of service for traffic on IP networks.

## DiffServ and QoS

DiffServ is designed for use at the edge of an Enterprise where corporate traffic enters the service provider environment. DiffServ is a layer-3 protocol and requires no specific layer-2 capability, allowing it to be used in the LAN, MAN, and WAN. DiffServ works by tagging each packet (at the originating device or an intermediate switch) for the requested level of service it requires across the network.



**FIGURE 109** – *ToS and DSCP*

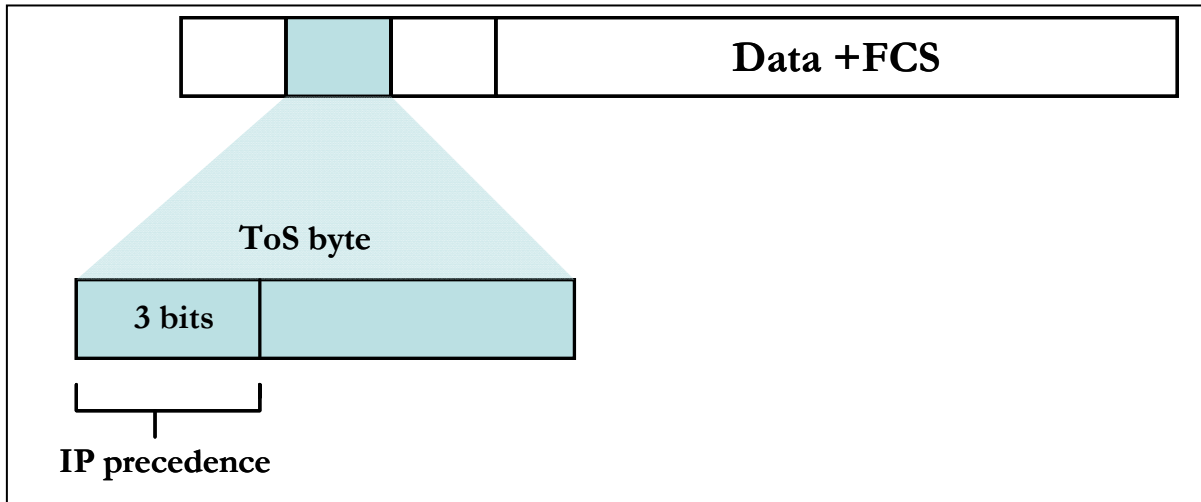
DiffServ inserts a 6-bit DiffServ code point (DSCP) in the Type of Service (ToS) field of the IP header, as shown in the picture above. Information in the DSCP allows nodes to determine the Per Hop Behavior (PHB), which is an observable forwarding behavior for each packet. PHBs are defined according to:

- Resources required (e.g., bandwidth, buffer size)
- Priority (based on application or business requirements)
- Traffic characteristics (e.g., delay, jitter, packet loss)

Nodes implement PHBs through buffer management and packet scheduling mechanisms. This hop-by-hop allocation of resources is the basis by which DiffServ provides quality of service for different types of communications traffic.

# IP Precedence

IP Precedence utilizes the three precedence bits in the IPv4 header's Type of Service (ToS) field to specify class of service for each packet. You can partition traffic in up to eight classes of service using IP precedence. The queuing technologies throughout the network can then use this signal to provide the appropriate expedited handling.



**FIGURE 110** - IP Precedence ToS Field in an IP Packet Header

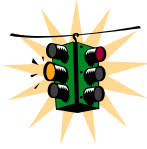
The 3 most significant bits (correlating to binary settings 32, 64, and 128) of the Type of Service (ToS) field in the IP header constitute the bits used for IP precedence. These bits are used to provide a priority from 0 to 7 for the IP packet.

Because only 3 bits of the ToS byte are used for IP precedence, you need to differentiate these bits from the rest of the ToS byte.

The Magnum 6K family of switches has the capability to provide QoS at Layer 2. At Layer 2, the frame uses Type of Service (ToS) as specified in IEEE 802.1p. ToS uses 3 bits, just like IP precedence, and maps well from Layer 2 to layer 3, and vice versa.

The switches have the capability to differentiate frames based on ToS settings. With two queues present - high or low priority queues or buffers in Magnum 6K family of switches, frames can be placed in either queue and serviced via the weight set on all ports. This placement of queues, added to the weight set plus the particular tag setting on a packet allows each queue to have different service levels.

Magnum QoS implementations provide mapping of ToS (or IP precedence) to Class of Service (CoS). A CoS setting in an Ethernet Frame is mapped to the ToS byte of the IP packet, and vice versa. A ToS level of 1 equals a CoS level of 1. This provides end-to-end priority for the traffic flow when Magnum 6K family of switches are deployed in the network.



Not all packets received on a port have high priority. IGMP and BPDU packets have high priority by default.

The Magnum 6K family of switches has the capability to set the priorities based on three different functions. They are

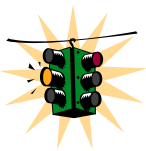
**Port QoS:** assigns a high priority to all packets received on a port, regardless of the type of packet.

**TAG QoS:** if a packet contains a tag, the port on which the packet was received then looks to see at which level that tag value is set. Regardless of the tag value, if there is a tag, that packet is automatically assigned high priority (sent to the high priority queue)

**ToS QoS:** (Layer 3) when a port is set to ToS QoS, the most significant 6-bits of the IPv4 packet (which has 64 bits) are used. If the 6 bits are set to ToS QoS for the specific port number the packet went to, that packet is assigned high priority by that port

## Configuring QoS

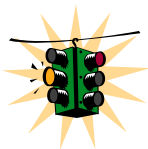
Magnum 6K family of switches support three types of QoS - Port based, Tag based and ToS based.



QoS is disabled by default on the switch. QoS needs to be enabled and configured.

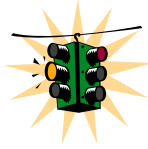
*Syntax* **qos** – enter the QoS configuration mode

*Syntax* **set qos type=<port | tag | tos | none> port=<port | list | range> [priority=<high | low>] [tos=<0-63 | list | range>][tag=<0-7 | list | range>]** - depending on the type of QoS, the corresponding field has to be set. For example, for QoS type tag, the tag levels have to be set, and for QoS type ToS, the ToS levels have to be set. If the priority field is not set, it then defaults to low priority. ToS has 64 levels and the valid values are 0-63 and a tagged packet has 8 levels and the valid values are 0-7.



Setting type to none will clear the QoS settings

*Syntax* **set-weight weight=<0-7>** - sets the port priority weight for All the ports. Once the weight is set, all the ports will be the same weight across the switch. The valid value for weight is 0-7.



A weight is a number calculated from the IP precedence setting for a packet. This weight is used in an algorithm to determine when the packet will be serviced

*Syntax* **show-portweight** - display the weight settings on a port

As mentioned previously, the switch is capable of detecting higher-priority packets marked with precedence by the IP forwarder and can schedule them faster, providing superior response time for this traffic. The IP Precedence field has values between 0 (the default) and 7. As the precedence value increases, the algorithm allocates more bandwidth to that traffic to make sure that it is served more quickly when congestion occurs. Magnum 6K family of switches can assign a weight to each flow, which determines the transmit order for queued packets. In this scheme, lower weights (set on all ports) are provided more service. IP precedence serves as a divisor to this weighting factor. For instance, traffic with an IP precedence field value of 7 gets a lower weight than traffic with an IP Precedence field value of 3, and thus has priority in the transmit order.

Once the port weight is set, the hardware will interpret the weight setting for all ports as outlined below (assuming the queues are sufficiently filled – if there are no packets, for example, in the high priority queue, packets are serviced on a first come first served - FCFS - basis from the low priority queue).

| Setting | Hardware traffic queue behavior  |
|---------|--|
| 0       | No priority – traffic is sent alternately from each queue and packets are queued alternately in each queue |
| 1       | Two packets are sent from the HIGH priority queue and one packet from LOW priority queue                   |
| 2       | Four packets are sent from the HIGH priority queue and one packet from LOW priority queue                  |
| 3       | Six packets are sent from the HIGH priority queue and one packet from LOW priority queue                   |
| 4       | Eight packets are sent from the HIGH priority queue and one packet from LOW priority queue                 |
| 5       | Ten packets are sent from the HIGH priority queue and one packet from LOW priority queue                   |
| 6       | Twelve packets are sent from the HIGH priority queue and one packet from LOW priority queue                |
| 7       | All packets are sent from the HIGH priority queue and none are sent from LOW priority queue                |

**FIGURE 111** - Port weight settings and the meaning of the setting

*Syntax* **show qos [type=<port|tag|tos>] [port=<port|list|range>]** – displays the QoS settings

Sometimes it is necessary to change the priority of the packets going out of a switch. For example, when a packet is received untagged and has to be transmitted with an addition of the 802.1p priority tag, the tag can be assigned depending on the untag value set. For example if the untag command is set to port=1 tag=2 priority=low, untagged packets received on that port will be tagged with a priority low upon transmit.

*Syntax* **set-untag port=<port|list|range> priority=<high|low> tag=<0-7>** - The 802.1p user priority assigned to untagged received packets to be transmitted as tagged from the priority queue

**Magnum6K25# show port**

Keys: E = Enable                      D = Disable  
 H = Half Duplex                    F = Full Duplex  
 M = Multiple VLAN's              NA = Not Applicable  
 LI = Listening                        LE = Learning  
 F = Forwarding                    B = Blocking

| Port | Name | Control | Dplx | Media | Link | Speed | Part | Auto | VlanID | GVRP | STP |
|------|------|---------|------|-------|------|-------|------|------|--------|------|-----|
| 9    | B1   | E       | H    | 10Tx  | UP   | 10    | No   | E    | 1      | -    | -   |
| 10   | B2   | E       | H    | 10Tx  | DOWN | 10    | No   | E    | 1      | -    | -   |
| 11   | B3   | E       | H    | 10Tx  | DOWN | 10    | No   | E    | 1      | -    | -   |
| 12   | B4   | E       | H    | 10Tx  | DOWN | 10    | No   | E    | 1      | -    | -   |
| 13   | B5   | E       | F    | 100Tx | UP   | 100   | No   | E    | 1      | -    | -   |
| 14   | B6   | E       | H    | 10Tx  | DOWN | 10    | No   | E    | M      | -    | -   |
| 15   | B7   | E       | H    | 10Tx  | DOWN | 10    | No   | E    | 1      | -    | -   |
| 16   | B8   | E       | H    | 10Tx  | DOWN | 10    | No   | E    | 1      | -    | -   |

*All traffic on port 10 is sent to the high priority queue*

**Magnum6K25#qos**

**Magnum6K25(qos)## setqos type=port port=10 priority=high**

Successfully set QOS.

**Magnum6K25(qos)## show qos**

```

=====
PORT | QOS | STATUS
=====
  9  | None | UP
 10  | Port | DOWN
 11  | None | DOWN
 12  | None | DOWN
 13  | None | UP
 14  | None | DOWN
 15  | None | DOWN
 16  | None | DOWN
=====
    
```

**Magnum6K25(qos)## show qos type=port**



| PORT | PRIORITY | STATUS |
|------|----------|--------|
| 9    | Low      | UP     |
| 10   | High     | DOWN   |
| 11   | Low      | DOWN   |
| 12   | Low      | DOWN   |
| 13   | Low      | UP     |
| 14   | Low      | DOWN   |
| 15   | Low      | DOWN   |
| 16   | Low      | DOWN   |

**Magnum6K25(qos)## setqos port=11 priority=high type=tag tag=6**

Successfully set QOS.

**Magnum6K25(qos)## show qos**

*All traffic on port 11 is sent to the high priority queue and the QoS tag is set to 6*

| PORT | QOS  | STATUS |
|------|------|--------|
| 9    | None | UP     |
| 10   | Port | DOWN   |
| 11   | Tag  | DOWN   |
| 12   | None | DOWN   |
| 13   | None | UP     |
| 14   | None | DOWN   |
| 15   | None | DOWN   |
| 16   | None | DOWN   |

**Magnum6K25(qos)## show qos type=tag**

| PORT | QOS | STATUS |
|------|-----|--------|
| 9    |     | UP     |
| 10   |     | DOWN   |
| 11   | 6   | DOWN   |
| 12   |     | DOWN   |
| 13   |     | UP     |
| 14   |     | DOWN   |
| 15   |     | DOWN   |
| 16   |     | DOWN   |

**Magnum6K25(qos)## setqos port=12 priority=high type=tag tag=5**

Successfully set QOS.

**Magnum6K25(qos)## show qos type=tag**

| PORT | QOS | STATUS |
|------|-----|--------|
|------|-----|--------|

|    |   |      |
|----|---|------|
| 9  |   | UP   |
| 10 |   | DOWN |
| 11 | 6 | DOWN |
| 12 | 5 | DOWN |
| 13 |   | UP   |
| 14 |   | DOWN |
| 15 |   | DOWN |
| 16 |   | DOWN |

**Magnum6K25(qos)## show-portweight**

Port priority Weight set to 1 High : 1 Low.

**Magnum6K25(qos)## set-weight weight=4**

**Magnum6K25(qos)## show-portweight**

Port priority Weight set to 8 High : 1 Low.

**Magnum6K25(qos)## show qos**

| PORT | QOS  | STATUS |
|------|------|--------|
| 9    | None | UP     |
| 10   | Port | DOWN   |
| 11   | Tag  | DOWN   |
| 12   | Tag  | DOWN   |
| 13   | None | UP     |
| 14   | None | DOWN   |
| 15   | None | DOWN   |
| 16   | None | DOWN   |

*The queue behavior is set so that for 8 high priority packets, 1 low priority packet is sent out*

FIGURE 112 – QoS configuration and setup

## List of commands in this chapter

*Syntax* **qos** – enter the QoS configuration mode

*Syntax* **setqos type=<port | tag | tos | none> port=<port | list | range> [priority=<high | low>] [tos=<0-63 | list | range>][tag=<0-7 | list | range>]** - depending on the type of QoS, the corresponding field has to be set. For example, for QoS type tag, the tag levels have to be set, and for QoS type ToS, the ToS levels have to be set. If the priority field is not set, it then defaults to low priority. ToS has 64 levels and the valid values are 0-63 and a tagged packet has 8 levels and the valid values are 0-7.

*Syntax* **set-weight weight=<0-7>** - sets the port priority weight for All the ports. Once the weight is set, all the ports will be the same weight across the switch. The valid value for weight is 0-7

*Syntax* **show-portweight** - display the weight settings on a port

*Syntax* **show qos [type=<port|tag|tos>] [port=<port|list|range>]** – *displays the QoS settings*

*Syntax* **set-untag port=<port|list|range> priority=<high|low> tag=<0-7>** - *The 802.1p user priority assigned to untagged received packets to be transmitted as tagged from the priority queue*

## 16 – IGMP

### *Multicast traffic on a network*

**I**nternet **G**roup **M**anagement **P**rotocol (IGMP) is defined in RFC 1112 as the standard for IP multicasting in the Internet. It is used to establish host memberships in particular multicast groups on a single network. The mechanisms of the protocol allows a host to inform its local router, using Host Membership Reports that it wants to receive messages addressed to a specific multicast group. All hosts conforming to level 2 of the IP multicasting specification require IGMP.



#### IGMP concepts<sup>8</sup>

The Magnum 6K family of switches supports IGMP L2 standards as defined by RFC 1112. IGMP is disabled by default and needs to be enabled on the Magnum 6K family of switches. IP multicasting is defined as the transmission of an IP datagram to a "host group", a set of zero or more hosts identified by a single IP destination address. A multicast datagram is delivered to all members of its destination host group with the same "best-efforts" reliability as regular unicast IP datagram, i.e. the datagram is not guaranteed to arrive at all members of the destination group or in the same order relative to other datagram.

The membership of a host group is dynamic; that is, hosts may join and leave groups at any time. There is no restriction on the location or number of members in a host group, but membership in a group may be restricted to only those hosts possessing a private access key. A host may be a member of more than one group at a time. A host need not be a member of a group to send datagram to it.

A host group may be permanent or transient. A permanent group has a well-known, administratively assigned IP address. It is the address and not the membership of the group that is permanent; at any time a permanent group may have any number of members, even zero. A transient group on the other hand is assigned an address dynamically when the group is created, at the request of a host. A transient group ceases to exist, and its address becomes eligible for reassignment, when its membership drops to zero.

---

<sup>8</sup> Most of the concepts are extracted from RFC 1112 and it is recommended that RFC 1112 be read and understood carefully if IGMP is used or planned for the network.

The creation of transient groups and the maintenance of group membership information is the responsibility of "multicast agents", entities that reside in internet gateways or other special-purpose hosts. There is at least one multicast agent directly attached to every IP network or sub-network that supports IP multicasting. A host requests the creation of new groups, and joins or leaves existing groups, by exchanging messages with a neighboring agent.

The Internet Group Management Protocol (IGMP) is an internal protocol of the Internet Protocol (IP) suite. IP manages multicast traffic by using switches, multicast routers, and hosts that support IGMP. A set of hosts, routers, and/or switches that send or receive multicast data streams to or from the same source(s) is termed a *multicast group*, and all devices in the group use the same multicast group address. The multicast group running version 2 of IGMP uses three fundamental types of messages to communicate:

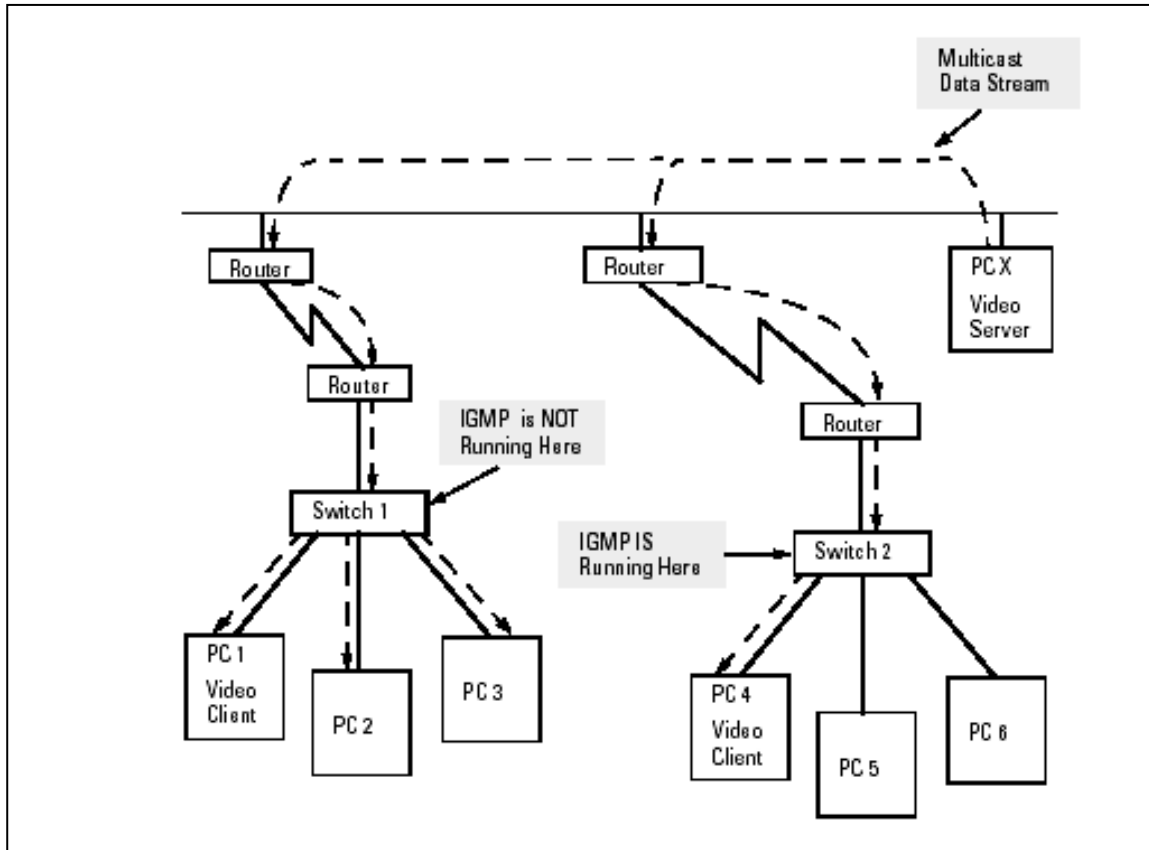
- **Query:** A message sent from the querier (multicast router or switch) asking for a response from each host belonging to the multicast group. If a multicast router supporting IGMP is not present, then the switch must assume this function in order to elicit group membership information from the hosts on the network. (If you need to disable the querier feature, you can do so through the CLI, using the IGMP configuration MIB. See "Changing the Querier Configuration Setting" on page "Configuring the Querier Function")
- **Report:** A message sent by a host to the querier to indicate that the host wants to be or is a member of a given group indicated in the report message.
- **Leave Group:** A message sent by a host to the querier to indicate that the host has ceased to be a member of a specific multicast group. Thus, IGMP identifies members of a multicast group (within a subnet) and allows IGMP-configured hosts (and routers) to join or leave multicast groups.

When IGMP is enabled on the Magnum 6K family of switches, it examines the IGMP packets it receives:

- To learn which of its ports are linked to IGMP hosts and multicast routers/queriers belonging to any multicast group.
- To become a querier if a multicast router/querier is not discovered on the network.

Once the switch learns the port location of the hosts belonging to any particular multicast group, it can direct group traffic to only those ports, resulting in bandwidth savings on ports where group members do not reside. The following example illustrates this operation.

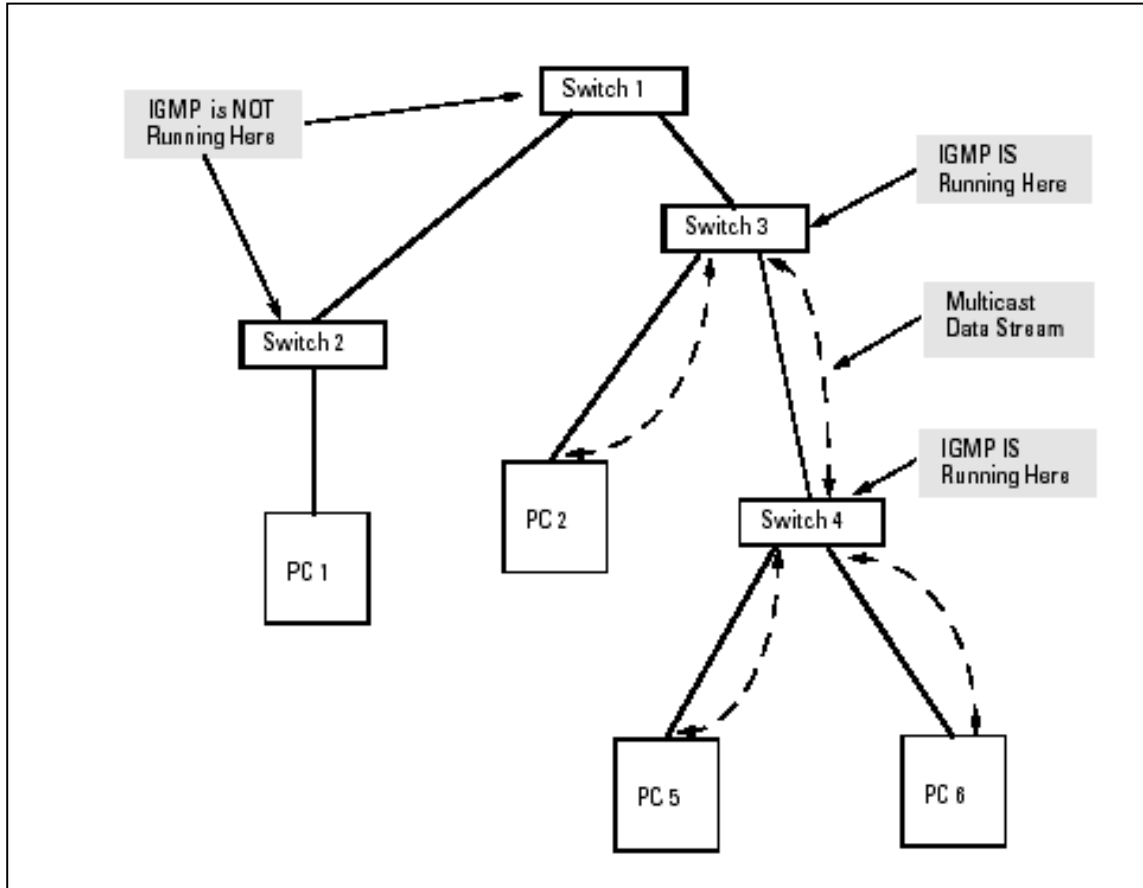
The figure below shows a network running IGMP.



**FIGURE 113** – IGMP concepts – advantages of using IGMP

- PCs 1 and 4, switch 2, and all of the routers are members of an IP multicast group. (The routers operate as queriers.)
- Switch 1 ignores IGMP traffic and does not distinguish between IP multicast group members and non-members. Thus, it is sending large amounts of unwanted multicast traffic out the ports to PCs 2 and 3.
- Switch 2 is recognizing IGMP traffic and learns that PC 4 is in the IP multicast group receiving multicast data from the video server (PC X). Switch 2 then sends the multicast data only to the port for PC 4, thus avoiding unwanted multicast traffic on the ports for PCs 5 and 6.

The next figure (below) shows a network running IP multicasting using IGMP without a multicast router. In this case, the IGMP-configured switch runs as a querier. PCs 2, 5, and 6 are members of the same IP multicast group. IGMP is configured on switches 3 and 4. Either of these switches can operate as querier because a multicast router is not present on the network. (If an IGMP switch does not detect a querier, it automatically assumes this role, assuming the querier feature is enabled—the default—within IGMP.)



**FIGURE 114** – IGMP concepts – Isolating multicast traffic in a network

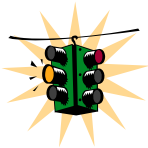
- In the above figure, the multicast group traffic does not go to switch 1 and beyond. This is because either the port on switch 3 that connects to switch 1 has been configured as blocked or there are no hosts connected to switch 1 or switch 2 that belong to the multicast group.
- For PC 1 to become a member of the same multicast group without flooding IP multicast traffic on all ports of switches 1 and 2, IGMP must be configured on both switches 1 and 2, and the port on switch 3 that connects to switch 1 must be unblocked.

**IP Multicast Filters** - IP multicast addresses occur in the range from 224.0.0.0 through 239.255.255.255 which corresponds to the Ethernet multicast address range of 01005e-000000 through 01005e-7fffff in hexadecimal.

**Reserved Addresses Excluded from IP Multicast (IGMP) Filtering** – Traffic to IP multicast

groups in the IP address range of 224.0.0.0 to 224.0.0.255 will always be flooded because addresses in this range are “well known” or “reserved” addresses. Thus, if IP Multicast is enabled and there is an IP multicast group within the reserved address range, traffic to that group will be flooded instead of filtered by the switch.

**IGMP Support** - Magnum 6K family of switches support IGMP version 1 and version 2. The switch can act either as a querier or a nonquerier. The querier router periodically sends general query messages to solicit group membership information. Hosts on the network that are members of a multicast group send report messages. When a host leaves a group, it sends a leave group message. The difference between Version 1 and Version 2 is that version 1 does not have a “Leave” mechanism for the host. Magnum 6K family of switches do pruning when there is a leave message or a time expires on a port, we prune the multicast group membership on that port.



1. The Magnum 6K family of switches can snoop up to 256 Multicast groups. It can be enabled within a port VLAN, tagged VLAN, or no VLAN.
2. IGMP is disabled as a default.

A switch, with IGMP snooping has the behavior similar to a regular switch (default IGMP behavior) i.e. it forwards the multicast stream (packets) to all the ports.

Now, if a device on any of the ports sends a join report or invokes the IGMP Pruning action, the behavior changes. A multicast group is formed in the switch, and the stream is sent only to those ports that actually want to join the stream.

The default behavior of multicasting streams to all ports could create problems when there are a number of multicast streams that enter the switch through a number of different ports. Each stream goes to ALL OTHER ports and creates congestion in the switch.

The mcast command (described below) controls this default behavior. The default setting is "enable". If it is set to "disable", the default behavior is modified so that the stream is not transmitted or multicast to any of the ports until a device joins the stream from that port.

## IGMP-L2

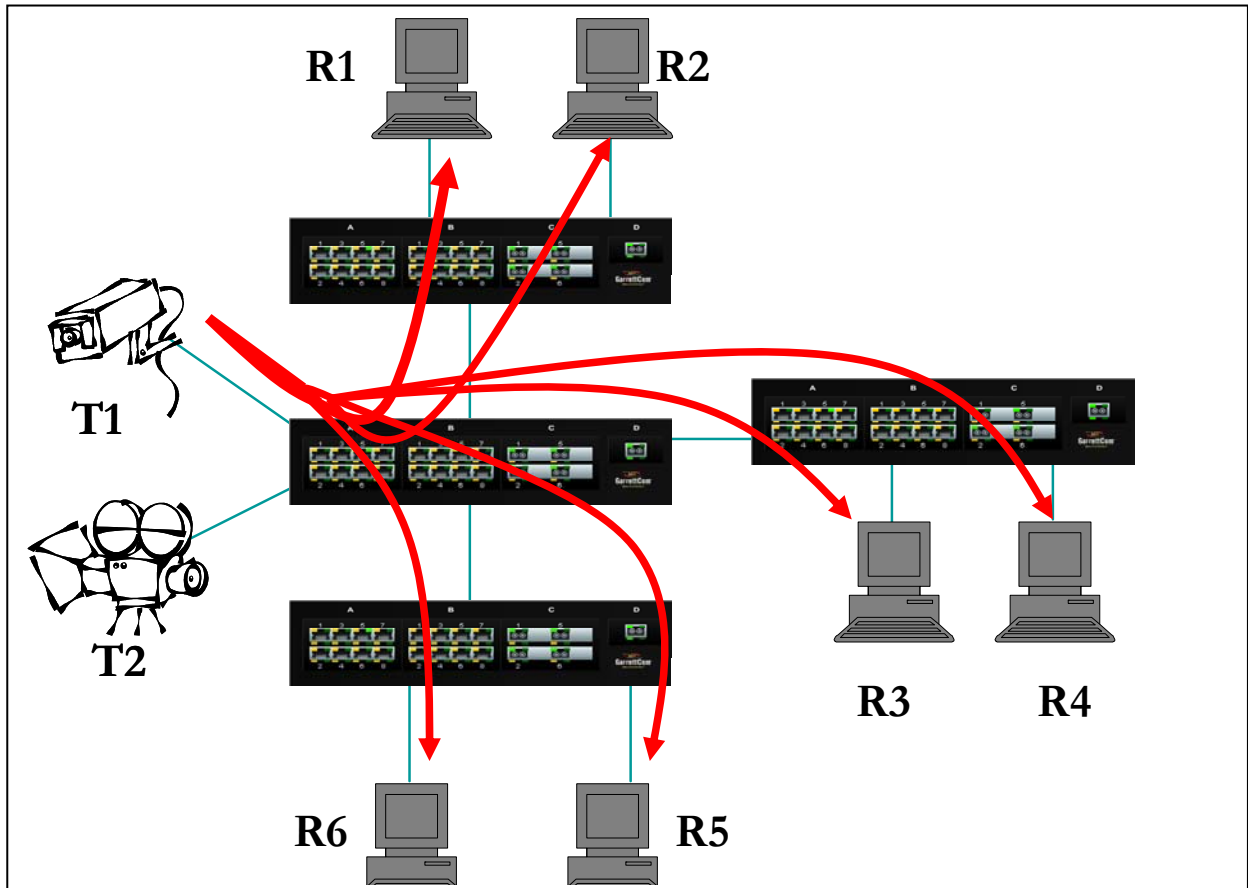
IGMP requires a Layer 3 device in the network. What happens if your network has only Layer 2 devices? Can the Layer 2 devices take advantage of the IGMP technology and reduce the overall traffic in the network, without requiring the presence of a Layer 3 device in the network? Using GarrettCom IGMP-L2 (patent pending technology), it is possible to do that.

The benefits of IGMP are clear. The traditional ways of building an IGMP network calls for the IGMP querier to reside on a Layer 3 network device - typically a router or a Layer 3 switch. The end devices (encoders or transmitters) reside on a Layer 2 device and the encoder sends a query/join request to join the specific multicast group. The Magnum 6K family of switches, with the IGMP-L2 enabled, can propagate the query request and also make sure that the multicast traffic only goes to the ports requesting the traffic. The Magnum 6K family of switches, using IGMP-L2, can perform the similar tasks a Layer 3 device performs for IGMP.



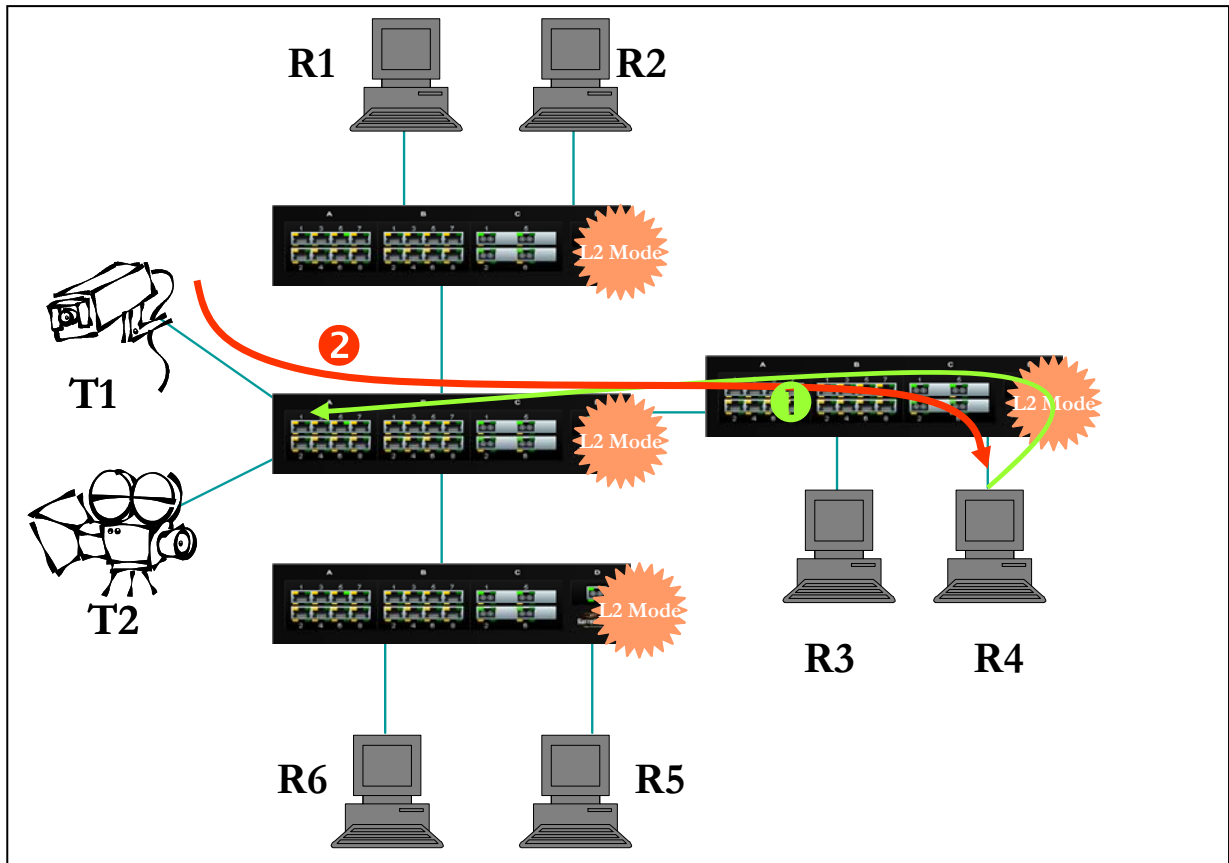
For a Layer 2 IGMP environment, all Magnum 6K family of switches have to be enabled in the IGMP-L2. This is done using the CLI command 'set igmp mode=l2' which will be described later.

In a Layer 2 network, without IGMP-L2, there is no querier nor is there any capability for the devices to use IGMP snooping to join a multicast group. Thus - the traffic picture from a multicast device would look as shown below.



**FIGURE 115** - In a Layer 2 network, an IGMP multicast traffic goes to all the nodes. In the figure, T1, a surveillance camera, using multicast, will send the traffic to all the nodes - R1 through R6 - irrespective of whether they want to view the surveillance traffic or not. The traffic is compounded when additional cameras are added to the network. End result is that users R1 through R6 see the network as heavily loaded and simple day to day operations may appear sluggish.

With IGMP-L2 enabled on all Magnum 6K family of switches, this situation as shown above is prevented. This is explained in the figure below.



**FIGURE 116** - Using IGMP-L2 on Magnum 6K family of switches, a Layer 2 network can minimize multicast traffic as shown above. Each switch has the IGMP L2 turned on. Each switch can exchange the IGMP query message and respond properly. R4 wants to view surveillance traffic from T1. As shown by (1), a join request is sent by R4. Once the join report information is exchanged, only R4 receives the video surveillance traffic, as shown by (2). No other device on the network gets the video surveillance traffic unless they issue a join request as well.

Since the query and the join information is exchanged between the neighboring switches, the topology does not matter. The design issue to consider is the timing difference between a topology recovery and IGMP refresh (recovery). GarrettCom Magnum 6K family of switches, connected in a S-Ring or RS-Ring topology recovers very rapidly (sub-second recovery). The IGMP requests for updates are sent out every few seconds (depending on the network and the devices on the network). The recovery of the network from a fault situation is much faster than the age out and join request from IGMP. Thus when the Magnum 6K switch network self heals, it is possible that the video may freeze till the (IGMP) device reissues a join request again.

A few additional facts about IGMP L2

- GarrettCom Magnum 6K family of switches configured for IGMP-L2 can perform the Join aggregation required by IGMP

- Multicast forwarding is done based on MAC addresses – so datagram to IP addresses 224.1.2.3 and 239.129.2.3 can be forwarded on the same port groups. It is not possible to do forwarding based on IP addresses as the Magnum 6K family of switches operate at Layer-2
- Magnum 6K family of switches, configured for IGMP L2 are aware of IP address range 224.0.0.x as well as MAC address range 01:00:5e:00:00:xx aware as required by RFC 4541
- The Magnum 6K family of switches, configured for IGMP L2 support forwarding to ports on which multicast routers are attached in addition to the ports where IGMP joins have been received. Thus IGMP L2 and IGMP L3 networks can co-exist
- The Magnum 6K family of switches, configured for IGMP L2 are aware of topology changes, so new queries can be sent or tables updated to ensure robustness

## Configuring IGMP

*Syntax* **igmp** – IGMP configuration mode

*Syntax* **igmp** <enable | disable> - enable or disable IGMP on the switch

*Syntax* **show igmp** – IGMP operation status

*Syntax* **mcast** <enable | disable> - enable or disable unknown multicast streams. The default is enabled

*Syntax* **set igmp mode=** <normal | l2> - set the IGMP mode. Normal is when a L3 device is in the network and is the IGMP root. The IGMP-L2 is used when there is no L3 device in the network

```
Magnum6K25# igmp
```

```
Magnum6K25(igmp)## igmp enable
```

```
IGMP is enabled
```

```
Magnum6K25(igmp)## show igmp
```

```
IGMP State           : Enabled
ImmediateLeave       : Disabled
Querier              : Enabled
Querier Interval    : 125
Querier Response Interval : 10
Multicasting unknown streams : Enabled
```

```
Magnum6K25(igmp)## mcast disable
```

```

MCAST is disabled

Magnum6K25(igmp)## show igmp

IGMP State           : Enabled
ImmediateLeave        : Disabled
Querier              : Enabled
Querier Interval     : 125
Querier Response Interval : 10
Multicasting unknown streams : Disabled

Magnum6K25(igmp)## igmp disable

IGMP is disabled

Magnum6K25(igmp)## show igmp

IGMP State           : Disabled
ImmediateLeave        : Disabled
Querier              : Disabled
Querier Interval     : 125
Querier Response Interval : 10
Multicasting unknown streams : Disabled

Magnum6K25(igmp)##

```

FIGURE 117 – Enabling IGMP and query the status of IGMP

The output of “show igmp” provide useful information. The following information is provided:

**IGMP State** shows if IGMP is turned on (Enable) or off (Disable).

**Immediate Leave** provides a mechanism for a particular host that wants to leave a multicast group. It disables the port (where the leave message is received) ability to transmit multicast traffic.

**Querier** shows where the switch is acting a querier or a non-querier. In the example above the switch is the querier.

**Querier Interval** shows the time period in seconds on which the switch sends general host-query messages.

**Querier Response Interval** specifies maximum amount of time in seconds that can elapse between when the querier sends a host-query message and when it receives a response from a host.

*Syntax* **show-group** – shows the multicast groups

| <b>Magnum6K25(igmp)## show-group</b> |        |       |              |
|--------------------------------------|--------|-------|--------------|
| GroupIp                              | PortNo | Timer | LeavePending |
| -----                                |        |       |              |
| 224.1.0.1                            | 9      | 155   | 0            |
| 224.0.1.40                           | 9      | 155   | 0            |
| <b>Magnum6K25(igmp)##</b>            |        |       |              |

**FIGURE 118** – *Displaying IGMP groups*

The output of the “show-group” command displays

**Group IP** column shows the multicast groups.

**Port No** shows the port where the multicast group is being detected.

**Timer** shows the amount of time left in seconds before the group port will be deleted (or will not be able to route multicast traffic) if the switch does not receive a membership report.

**Leave Pending** column shows the number of leave messages received from this port

Every port can be individually set to three different IGMP modes – Auto, Block and Forward.

- Auto – lets IGMP control whether the port should or should not participate sending multicast traffic
- Block – manually configures the port to always block multicast traffic
- Forward – manually configures the port to always forward multicast traffic

To set the port characteristics, use the set-port in the IGMP configuration command mode

*Syntax* **set-port port=< port | list | range> mode=<auto | forward | block>** - set the port characteristics. Block drops the unregistered multicasts. Forward forwards unregistered multicasts

*Syntax* **show-port** – display the port characteristics for IGMP

*Syntax* **show-router** – displays detected IGMP-enabled router ports

*Syntax* **set-leave <enable | disable>** - enables or disables the switch to immediately process a host sending a leave message rather than wait for the timer to expire

*Syntax* **set-querier <enable | disable>** - enables or disables a switch as IGMP querier

*Syntax* **set-qi interval=<value>** - The IGMP querier router periodically sends general host-query messages. These messages are sent to ask for group membership information. This is sent to the all-system multicast group address, 224.0.0.1. The default value is 125 seconds. The valid range can be from 60 to 127 seconds.

*Syntax* **set-qli interval=<value>** - The query response interval is the maximum amount of time that can elapse between when the querier router sends a host-query message and when it receives a response from a host. The Default value is 10 seconds. The Range can be from 2 to 270 seconds. Restrictions apply to the maximum value because of an internal calculation that is dependent on the value of the Query Interval.

**Magnum6K25# igmp**

**Magnum6K25(igmp)## set-port port=10-12 mode=forward**

Port mode is set.

**Magnum6K25(igmp)## set-port port=14-16 mode=block**

Port mode is set.

**Magnum6K25(igmp)## show-port**

| Port | Mode       |
|------|------------|
| 09   | Auto       |
| 10   | Forwarding |
| 11   | Forwarding |
| 12   | Forwarding |
| 13   | Auto       |
| 14   | Blocking   |
| 15   | Blocking   |
| 16   | Blocking   |

**Magnum6K25(igmp)## show-router**

| RouterIp    | PortNo | Timer |
|-------------|--------|-------|
| 10.21.1.250 | 9      | 25    |

**Magnum6K25(igmp)## set-leave enable**

IGMP immediate leave status is enabled

**Magnum6K25(igmp)## show igmp**

```
IGMP State           : Enabled
ImmediateLeave       : Enabled
Querier              : Enabled
```

```

Querier Interval          : 125
Querier Response Interval : 10

```

**Magnum6K25(igmp)## set-leave disable**

IGMP immediate leave status is disabled

**Magnum6K25(igmp)## show igmp**

```

IGMP State                : Enabled
ImmediateLeave             : Disabled
Querier                   : Enabled
Querier Interval          : 125
Querier Response Interval : 10

```

**Magnum6K25(igmp)## set-querier enable**

IGMP querier status is enabled

**Magnum6K25(igmp)## show igmp**

```

IGMP State                : Enabled
ImmediateLeave             : Disabled
Querier                   : Enabled
Querier Interval          : 125
Querier Response Interval : 10

```

**Magnum6K25(igmp)## set-querier disable**

IGMP querier status is disabled

**Magnum6K25(igmp)## show igmp**

```

IGMP State                : Enabled
ImmediateLeave             : Disabled
Querier                   : Disabled
Querier Interval          : 125
Querier Response Interval : 10

```

**Magnum6K25(igmp)## set-qi interval=127**

Query interval successfully set

**Magnum6K25(igmp)## show igmp**

```

IGMP State                : Enabled
ImmediateLeave             : Disabled
Querier                   : Disabled
Querier Interval          : 127
Querier Response Interval : 10

```

**Magnum6K25(igmp)## set-qri interval=11**

```

Query response interval successfully set

Magnum6K25(igmp)## show igmp

IGMP State           : Enabled
ImmediateLeave        : Disabled
Querier              : Disabled
Querier Interval     : 125
Querier Response Interval : 11

```

FIGURE 119 – Configuring IGMP

For setting IGMP L2 mode, make sure the set of commands listed below are executed on all the Magnum switches participating in the L2

```

Magnum 6K25# igmp

Magnum 6K25(igmp)## mode L2

IGMP set to L2 Mode.

Magnum 6K25(igmp)## show igmp
IGMP State           : Disabled
ImmediateLeave        : Disabled
Querier              : L2 Mode
Querier Interval     : 125
Querier Response Interval : 10
Multicasting unknown streams : Disabled

Magnum 6K25(igmp)## mode normal

IGMP set to Normal Mode.

Magnum 6K25(igmp)## exit
Magnum 6K25#

```

FIGURE 120 - Setting IGMP-L2

## List of commands in this chapter

*Syntax* **igmp** – IGMP configuration mode

*Syntax* **igmp** <enable/disable> - enable or disable IGMP on the switch

*Syntax* **show igmp** – IGMP operation status

*Syntax* **mcast** <enable | disable> - enable or disable unknown multicast streams. The default is enabled



*Syntax* **set igmp mode**=<normal | l2> - set the IGMP mode. Normal is when a L3 device is in the network and is the IGMP root. The IGMP-L2 is used when there is no L3 device in the network

*Syntax* **show-group** – shows the multicast groups

*Syntax* **set-port port**=< port | list | range> **mode**=<auto | forward | block> - set the port characteristics. Block drops the unregistered multicasts. Forward forwards unregistered multicasts

*Syntax* **show-port** – display the port characteristics for IGMP

*Syntax* **show-router** – displays detected IGMP-enabled router ports

*Syntax* **set-leave** <enable | disable> - enables or disables the switch to immediately process a host sending a leave message rather than wait for the timer to expire

*Syntax* **set-querier** <enable | disable> - enables or disables a switch as IGMP querier

*Syntax* **set-qi interval**=<value> - The IGMP querier router periodically sends general host-query messages. These messages are sent to ask for group membership information. This is sent to the all-system multicast group address, 224.0.0.1. The default value is 125 seconds. The valid range can be from 60 to 127 seconds.

*Syntax* **set-qri interval**=<value> - The query response interval is the maximum amount of time that can elapse between when the querier router sends a host-query message and when it receives a response from a host. The Default value is 10 seconds. The Range can be from 2 to 270 seconds. Restrictions apply to the maximum value because of an internal calculation that is dependent on the value of the Query Interval.

## 17 – GVRP

### *Generic Attribute Registration Protocol (GARP) VLAN Registration Protocol (GVRP)*

**G**eneric Attribute Registration Protocol (GARP) and VLAN registration over GARP is called GVRP. GVRP is defined in the IEEE 802.1q and GARP in the IEEE 802.1p standards. In order to utilize the capabilities of GVRP, GarrettCom Inc. strongly recommends that the user is familiar with the concepts and capabilities of IEEE 802.1q.

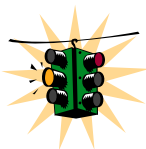


#### GVRP concepts

GVRP makes it easy to propagate VLAN information across multiple switches. Without GVRP, a network administrator has to go to each individual switch and enable the necessary VLAN information or block specific VLAN's so that the network integrity is maintained. With GVRP this process can be automated.

It is critical that all switches share a common VLAN. This VLAN typically is the default VLAN (VID=1) on most switches and other devices. GVRP uses “GVRP Bridge Protocol Data Units” (“GVRP BPDUs”) to “advertise” static VLANs. We refer to GVRP BPDUs as an “advertisement”.

GVRP enables the Magnum 6K family of switches to dynamically create 802.1q-compliant VLANs on links with other devices running GVRP. This enables the switch to automatically create VLAN links between GVRP-aware devices. A GVRP link can include intermediate devices that are not GVRP-aware. This operation reduces the chances for errors in VLAN configuration by automatically providing VLAN ID (VID) consistency across the network. GVRP can thus be used to propagate VLANs to other GVRP-aware devices instead of manually having to set up VLANs across the network. After the switch creates a dynamic VLAN, GVRP can also be used to dynamically enable port membership in static VLANs configured on a switch.

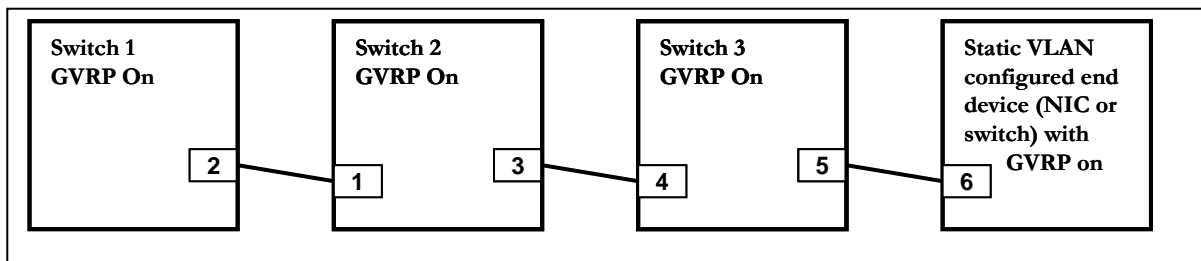


There must be one common VLAN (that is, one common VID) connecting all of the GVRP-aware devices in the network to carry GVRP packets. GarrettCom Inc. recommends the default VLAN (DEFAULT\_VLAN; VID = 1), which is automatically enabled and

configured as untagged on every port of the Magnum 6K family of switches. That is, on ports used as GVRP links, leave the default VLAN set to untagged and configure other static VLANs on the ports as either “Tagged or Forbid”. (*“Forbid” is discussed later in this chapter.*)

## GVRP Operations

A GVRP-enabled port with a Tagged or Untagged static VLAN sends advertisements (BPDUs, or Bridge Protocol Data Units) advertising the VLAN identification (VID). Another GVRP-aware port receiving the advertisements over a link can dynamically join the advertised VLAN. All dynamic VLANs operate as Tagged VLANs. Also, a GVRP-enabled port can forward an advertisement for a VLAN it learned about from other ports on the same switch. However, the forwarding port will not itself join that VLAN until an advertisement for that VLAN is received on that specific port.

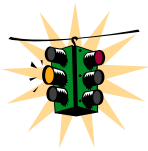


**FIGURE 121** – GVRP operation – see description below

Switch 1 with static VLANs (VID= 1, 2, & 3). Port 2 is a member of VIDs 1, 2, & 3.

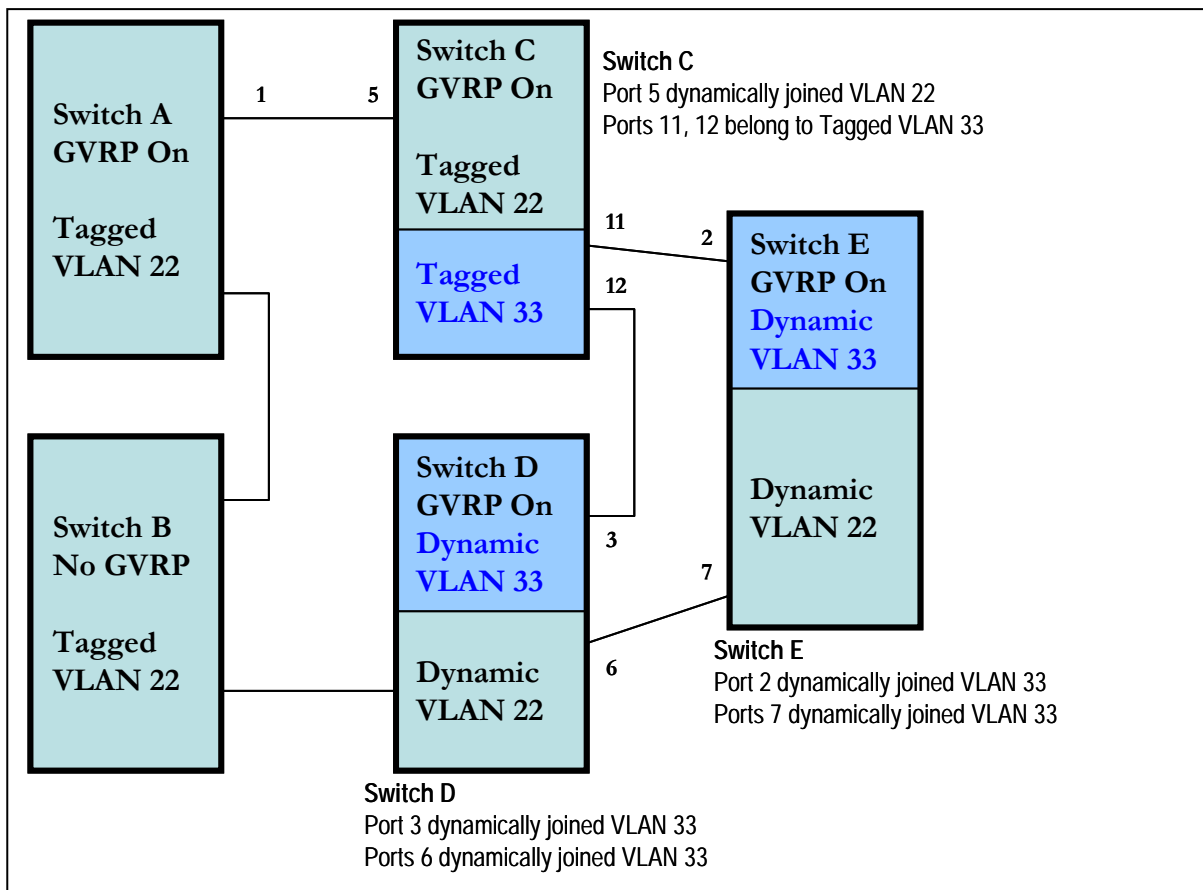
1. Port 2 advertises VIDs 1, 2, & 3
2. On Switch 2 - Port 1 receives advertisement of VIDs 1, 2, & 3 AND becomes a member of VIDs 1, 2, & 3
3. As discussed above, a GVRP enabled port can forward advertisement for a VLAN it learnt about. So port 3 advertises VIDs 1, 2, & 3, but port 3 is NOT a member of VIDs 1, 2, & 3 at this point, nor will it join the VLAN until an advertisement is received
4. On Switch 3, port 4 receives advertisement of VIDs 1, 2, & 3 and becomes a member of VIDs 1, 2, & 3
5. Port 5 advertises VIDs 1, 2, & 3, but port 5 is NOT a member of VIDs 1, 2, & 3 at this point
6. Port 6 on the end device is statically configured to be a member of VID 3. Port 6 advertises VID 3
7. Port 5 receives advertisement
8. Port 4 advertises VID 3
9. Port 3 receives advertisement of VID 3 AND becomes a member of VID 3. (Still not a member of VIDs 1 & 2 as it did not receive any advertisements for VID 1 or 2)
10. Port 1 advertises VID 3 AND becomes a member of VID 3. (Port 1 is still not a member of VIDs 1 & 2)

- Port 2 receives advertisement of VID 3. (Port 2 was already statically configured for VIDs 1, 2, 3)



If a static VLAN is configured on at least one port of a switch, and that port has established a link with another device, then all other ports of that switch will send advertisements for that VLAN.

In the figure below, tagged VLAN ports on switch “A” and switch “C” advertise VLANs 22 and 33 to ports on other GVRP-enabled switches that can dynamically join the VLANs. A port can learn of a dynamic VLAN through devices that are not aware of GVRP (Switch “B”).)

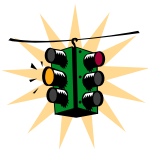


**FIGURE 122** – VLAN Assignment in GVRP enabled switches. Non GVRP enabled switches can impact VLAN settings on other GVRP enabled switches

An “unknown VLAN” is a VLAN that the switch learns of by GVRP. For example, suppose that port 1 on switch “A” is connected to port 5 on switch “C”. Because switch “A” has VLAN 22 statically configured, while switch “C” does not have this VLAN statically configured, VLAN 22 is handled as an “Unknown VLAN” on port 5 in switch “C”. Conversely, if VLAN 22 was statically configured on switch C, but port 5 was not a member, port 5 would become a member when advertisements for VLAN 22 were received from switch “A”. GVRP provides a per-port join-request option which can be configured.

VLANs must be disabled in GVRP-unaware devices to allow tagged packets to pass through. A GVRP-aware port receiving advertisements has these options:

- If there is no static VLAN with the advertised VID on the receiving port, then dynamically create a VLAN with the same VID as in the advertisement, and allow that VLAN's traffic
- If the switch already has a static VLAN with the same VID as in the advertisement, and the port is configured to learn for that VLAN, then the port will dynamically join the VLAN and allow that VLAN's traffic.
- Ignore the advertisement for that VID and drop all GVRP traffic with that VID
- Don't participate in that VLAN



A port belonging to a tagged or untagged static VLAN has these configurable options:

- Send VLAN advertisements, and also receive advertisements for VLANs on other ports and dynamically join those VLANs
- Send VLAN advertisements, but ignore advertisements received from other ports
- Avoid GVRP participation by not sending advertisements and dropping any advertisements received from other devices

| Unknown VLAN Mode | Operations   |
|-------------------|--|
| <b>Learn</b>      | Enables the port to dynamically join any VLAN for which it receives and advertisement, and allows the port to forward the advertisement it receives  |
| <b>Block</b>      | Prevents the port from dynamically joining a VLAN that is not statically configured on the switch. The port will still forward advertisements that were received by the switch on other ports. Block should typically be used on ports in insecure networks where there is exposure to attack – such as ports where intruders can connect to |
| <b>Disable</b>    | Causes the port to ignore and drop all the advertisements it receives from any source  |

**FIGURE 123** – *Port settings for GVRP operations*

The CLI command “**show-vlan**” shows a switch's current GVRP configuration, including the unknown VLANs.

```

Magnum6K25# gvrp

Magnum6K25(gvrp)## show-vlan

=====
VLAN ID | NAME          | VLAN   STATUS
=====
  1     | Default VLAN | Static Active
  2     | Blue         | Static Active
 10     | dyn10        | Dynamic Active
=====

Magnum6K25(gvrp)##

```

FIGURE 124 – Command to check for dynamically assigned VLANs

Note that port 10 must be enabled and configured to learn for it to be assigned to the dynamic VLAN. To send advertisements, one or more tagged or untagged static VLANs must be configured on one (or more) switches with GVRP enabled. MNS-6K allows a dynamic VLAN to be converted to a static VLAN. The command to use is

*Syntax* **static vlan=<VID>** - convert a dynamic VLAN to a static VLAN

Note “**show vlan type=tag**” will display VID in case the VID is not known.

```

Magnum6K25# gvrp

Magnum6K25(gvrp)## show-vlan

=====
VLAN ID | NAME          | VLAN   STATUS
=====
  1     | Default VLAN | Static Active
  2     | Blue         | Static Active
 10     | dyn10        | Dynamic Active
=====

Magnum6K25(gvrp)## static vlan=10

Magnum6K25(gvrp)## show-vlan

=====
VLAN ID | NAME          | VLAN   STATUS
=====
  1     | Default VLAN | Static Active
  2     | Blue         | Static Active
 10     | dyn10        | Static  Active
=====

```

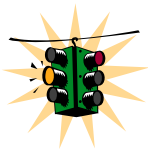
VLAN 10 is converted to a static VLAN

FIGURE 125 – Converting a dynamic VLAN to a static VLAN

| Per Port<br>“unknown<br>VLAN” (GVRP)<br>configuration | Per-Port Static VLAN Options  |  |   |
|---|---|--|---|
|   | Tagged or Untagged  | Auto   | Forbid  |
| <b>Learn</b>  | Generate advertisements.<br>Forward advertisements for other VLANs<br>Receive advertisements and dynamically join any advertised VLAN     | Receive advertisements and dynamically join any advertised VLAN that has the same VID as the static VLAN | Do not allow the port to become a member of this VLAN |
| <b>Block</b>  | Generate advertisements<br>Forward advertisements received from other ports to other VLANs<br>Do not dynamically join any advertised VLAN | Receive advertisements and dynamically join any advertised VLAN that has the same VID                    | Do not allow the VLAN on this port                    |
| <b>Disable</b>  | Ignore GVRP and drop all GVRP advertisements  | Ignore GVRP and drop all GVRP advertisements   | Do not allow the VLAN on this port                    |

**FIGURE 126** – *GVRP options*

As the above table indicates a port that has a tagged or untagged static VLAN has the option to both generate advertisements and dynamically join other VLANs.



The unknown VLAN parameters are configured on a per interface basis using the CLI. The tagged, untagged, Auto, and Forbid options are configured in the VLAN context. Since dynamic VLANs operate as tagged VLANs, and it is possible that a tagged port on one device may not communicate with an untagged port on another device, GarrettCom Inc. recommends that you use Tagged VLANs for the static VLANs.

A dynamic VLAN continues to exist on a port for as long as the port continues to receive advertisements of that VLAN from another device connected to that port or until you:

- Convert the VLAN to a static VLAN
- Reconfigure the port to Block or Disable
- Disable GVRP
- Reboot the switch

The time-to-live for dynamic VLANs is 10 seconds. That is, if a port has not received an advertisement for an existing dynamic VLAN during the last 10 seconds, the port removes itself from that dynamic VLAN.

# Configuring GVRP

The commands used for configuring GVRP are

*Syntax* **show gvrp** - shows whether GVRP is disabled, along with the current settings for the maximum number of VLANs and the current Primary VLAN

*Syntax* **gvrp <enable | disable>** - enable or disable GVRP

*Syntax* **show-vlan** – list all the VLANs (including dynamic VLANs) on the switch

*Syntax* **set-ports port=<port | list | range> state=<learn | block | disable>** - set the state of the port to learn, block or disable for GVRP. Note the default state is disable

*Syntax* **static vlan=<VID>** - convert a dynamic VLAN to a static VLAN

*Syntax* **set-forbid vlan=<tag vlanid> forbid=<port-number | list | range>** - sets the forbid GVRP capability on the ports specified

*Syntax* **show-forbid** – display the ports with GVRP forbid capabilities

```
Magnum6K25# gvrp
```

```
Magnum6K25(gvrp)#show gvrp
```

```
GVRP Status : Enabled
```

```
Magnum6K25(gvrp)##gvrp disable
```

```
GVRP is now disabled
```

```
Magnum6K25(gvrp)##gvrp enable
```

```
GVRP enabled
```

```
Magnum6K25(gvrp)## show-vlan
```

```
=====
```

| VLAN ID | NAME         | VLAN    | STATUS |
|---------|--------------|---------|--------|
| 1       | Default VLAN | Static  | Active |
| 2       | Blue         | Static  | Active |
| 10      | dyn10        | Dynamic | Active |

```
=====
```

```
Magnum6K25(gvrp)## static vlan=10
```

```
Magnum6K25(gvrp)## show-vlan
```



```

=====
VLAN ID   | NAME           | VLAN   | STATUS
=====
1         | Default VLAN  | Static | Active
2         | Blue          | Static | Active
10        | dyn10         | Static | Active
=====

Magnum6K25(gvrp)## set-forbid vlan=2 forbid=11-15

Magnum6K25(gvrp)## show-forbid

=====
VLAN ID   | FORBIDDEN PORTS
=====
1         | None
2         | 11, 12, 13, 14, 15
=====

```

FIGURE 127 – GVRP configuration example

## GVRP Operations Notes

A dynamic VLAN must be converted to a static VLAN before it can have an IP address.

After converting a dynamic VLAN to a static VLAN use the **“save”** command to save the changes made – on a reboot the changes can be lost without the save command.

Within the same broadcast domain, a dynamic VLAN can pass through a device that is not GVRP-aware. This is because a hub or a switch that is not GVRP-aware will flood the GVRP (multicast) advertisement packets out all ports.

GVRP assigns dynamic VLANs as tagged VLANs. To configure the VLAN as untagged, first convert the tagged VLAN to a static VLAN.

Rebooting a switch with a dynamic VLAN deletes that VLAN. However, the dynamic VLAN reappears after the reboot if GVRP is enabled and the switch again receives advertisements for that VLAN through a port configured to add dynamic VLANs.

By receiving advertisements from other devices running GVRP, the switch learns of static VLANs from those devices and dynamically (automatically) creates tagged VLANs on the links to the advertising devices. Similarly, the switch advertises its static VLANs to other GVRP-aware devices.

A GVRP-enabled switch does not advertise any GVRP-learned VLANs out of the port(s) on which it originally learned of those VLANs.

## List of commands in this chapter

*Syntax* **show gvrp** - shows whether GVRP is disabled, along with the current settings for the maximum number of VLANs and the current Primary VLAN

*Syntax* **gvrp <enable | disable>** - enable or disable GVRP

*Syntax* **show-vlan** – list all the VLANs (including dynamic VLANs) on the switch

*Syntax* **set-ports port=<port | list | range> state=<learn | block | disable>** - set the state of the port to learn, block or disable for GVRP. Note the default state is disable

*Syntax* **static vlan=<VID>** - convert a dynamic VLAN to a static VLAN

*Syntax* **set-forbid vlan=<tag vlanid> forbid=<port-number | list | range>** - sets the forbid GVRP capability on the ports specified

*Syntax* **show-forbid** – display the ports with GVRP forbid capabilities

## 18 – SNMP

### *Managing your network using SNMP*

**S**imple Network Management Protocol (SNMP) enables management of the network. There are many software packages which provide a graphical interface and a graphical view of the network and its devices. The graphical interface and view would not be possible without SNMP. SNMP is thus the building block for network management.



#### SNMP concepts

SNMP provides the protocol to extract the necessary information from a networked device and display the information. The information is defined and stored in a Management Information Base (MIB). MIB is the “database” of the network management information.

SNMP has evolved over the years (since 1988) using the RFC process. Several RFC’s today define the SNMP standards. The most common standards for SNMP are SNMP v1 (the original version of SNMP); SNMP v2 and more recently SNMP v3.

SNMP is a poll based mechanism. SNMP manager polls the managed device for information and display the information retrieved in text or graphical manner. Some definitions related to SNMP are

**Community string** – A text string used to authenticate messages between a management station and an SNMP v1/v2c engine

**Simple Network Management Protocol (SNMP)** – A network management protocol that provides a means to monitor and control network devices, and to manage configurations, statistics collection, performance, and security.

**Simple Network Management Protocol Version 2c (SNMPv2c)** – The second version of SNMP, it supports centralized and distributed network management strategies, and includes improvements in the Structure of Management Information (SMI), protocol operations, management architecture, and security

**Simple Network Management Protocol Version 3 (SNMPv3)** – The third version of SNMP, the enhancements made to secure access, different levels of access and security.

**SNMP engine** – A copy of SNMP that can either reside on the local or remote device

**SNMP group** – A collection of SNMP users that belong to a common SNMP list that defines an access policy, in which object identification numbers (OIDs) are both read-accessible and write-accessible. Users belonging to a particular SNMP group inherit all of these attributes defined by the group

**SNMP user** – A person for which an SNMP management operation is performed. The user is the person on a remote SNMP engine who receives the information

**SNMP view** – A mapping between SNMP objects and the access rights available for those objects. An object can have different access rights in each view. Access rights indicate whether the object is accessible by either a community string or a user

**Write view** – A view name (not to exceed 64 characters) for each group that defines the list of object identifiers (OIDs) that are able to be created or modified by users of the group

**Authentication** – The process of ensuring message integrity and protection against message replays. It includes both data integrity and data origin authentication

**Authoritative SNMP engine** – One of the SNMP copies involved in network communication designated to be the allowed SNMP engine which protects against message replay, delay, and redirection. The security keys used for authenticating and encrypting SNMPv3 packets are generated as a function of the authoritative SNMP engine's engine ID and user passwords. When an SNMP message expects a response (for example, get exact, get next, set request), the *receiver* of these messages is authoritative. When an SNMP message does not expect a response, the *sender* is authoritative

**Data integrity** – A condition or state of data in which a message packet has not been altered or destroyed in an unauthorized manner

**Data origin authentication** – The ability to verify the identity of a user on whose behalf the message is supposedly sent. This ability protects users against both message capture and replay by a different SNMP engine, and against packets received or sent to a particular user that use an incorrect password or security level

**Encryption** – A method of hiding data from an unauthorized user by scrambling the contents of an SNMP packet

**Group** – A set of users belonging to a particular security model. A group defines the access rights for all the users belonging to it. Access rights define what SNMP objects can be read, written to, or created. In addition, the group defines what notifications a user is allowed to receive

**Notification host** – An SNMP entity to which notifications (traps and informs) are to be sent

**Notify view** – A view name (not to exceed 64 characters) for each group that defines the list of notifications that can be sent to each user in the group

**Privacy** – An encrypted state of the contents of an SNMP packet where they are prevented from being disclosed on a network. Encryption is performed with an algorithm called CBC-DES (DES-56)

**Read view** – A view name (not to exceed 64 characters) for each group that defines the list of object identifiers (OIDs) that are accessible for reading by users belonging to the group

**Security level** – A type of security algorithm performed on each SNMP packet. The three levels are: noauth, auth, and priv. noauth authenticates a packet by a string match of the user name. auth authenticates a packet by using either the HMAC MD5 algorithms. priv authenticates a packet by using either the HMAC MD5 algorithms and encrypts the packet using the CBC-DES (DES-56) algorithm

**Security model** – The security strategy used by the SNMP agent. Currently, MNS-6K supports three security models: SNMPv1, SNMPv2c, and SNMPv3

## Traps

The traps supported by MNS-6K are as follows:

**SNMP Traps:** Warm Start, Cold Start, Link Up, Link Down, Authentication Failure.

**RMON Traps:** Rising Alarm, Falling Alarm for RMON groups 1, 2, 3, and 9 (Statistics, Events, Alarms, and History)

**Enterprise Traps:** Intruder, S-Ring and LLL

## Standards

There are several RFC's defining SNMP. MNS-6K supports the following RFC's and standards

SNMPv1 standards

- Security via configuration of SNMP communities
- Event reporting via SNMP
- Managing the switch with an SNMP network management tool Supported *Standard* MIBs include:
  - SNMP MIB-II (RFC 1213)
  - Bridge MIB (RFC 1493) (ifGeneralGroup, ifRcvAddressGroup, ifStackGroup)

- RMON MIB (RFC 1757)
- RMON: groups 1, 2, 3, and 9 (Statistics, Events, Alarms, and History)
- Version 1 traps (Warm Start, Cold Start, Link Up, Link Down, Authentication Failure, Rising Alarm, Falling Alarm)

#### RFC 1901-1908 – SNMPv2

- RFC 1901, Introduction to Community-Based SNMPv2. SNMPv2 Working Group
- RFC 1902, Structure of Management Information for Version 2 of the Simple Network Management Protocol (SNMPv2). SNMPv2 Working Group
- RFC 1903, Textual Conventions for Version 2 of the Simple Network Management Protocol (SNMPv2). SNMPv2 Working Group
- RFC 1904, Conformance Statements for Version 2 of the Simple Network Management Protocol (SNMPv2). SNMPv2 Working Group
- RFC 1905, Protocol Operations for Version 2 of the Simple Network Management Protocol (SNMPv2). SNMPv2 Working Group
- RFC 1906, Transport Mappings for Version 2 of the Simple Network Management Protocol (SNMPv2)
- RFC 1907, Management Information Base for Version 2 of the Simple Network Management Protocol (SNMPv2). SNMPv2 Working Group
- RFC 1908, Coexistence between Version 1 and Version 2 of the Internet-standard Network Management Framework. SNMPv2 Working Group

#### RFC 2271-2275 – SNMPv3

- RFC 2104, Keyed Hashing for Message Authentication
- RFC 2271, An Architecture for Describing SNMP Management Frameworks
- RFC 2272, Message Processing and Dispatching for the Simple Network Management Protocol (SNMP)
- RFC 2273, SNMPv3 Applications
- RFC 2274, User-Based Security Model (USM) for version 3 of the Simple Network Management Protocol (SNMPv3)
- RFC 2275, View-Based Access Control Model (VACM) for the Simple Network Management Protocol (SNMP)

## Configuring SNMP

There are several commands and variable which can be set for configuring SNMP. They are listed below. The basic SNMP v1 parameters can be set by referring to the section on [System Parameters](#). Most commands here refer to SNMP v3 commands and how the variables for SNMP v3 can be configured.

*Syntax* **snmp** – enter the SNMP Configuration mode

*Syntax* **set snmp type=<v1 | all>** - define the version of SNMP to use – the option all supports all versions (v1, v2 and v3) – v1 restricts SNMP to v1 only. By default – SNMP v1 only is enabled

*Syntax* **show active-snmp** – shows the version of SNMP currently in use

*Syntax* **community** [write=<write community>] [read=<read community>] [trap=<trap community>] – set the necessary community strings

*Syntax* **authtraps** <enable | disable> - enables or disables authentication traps generation

*Syntax* **traps** <add | delete> type=<Snmp | Rmon | Snmp,Rmon | Enterprise | Snmp,Enterprise | Rmon,Enterprise | All> ip=<ipaddress> - add v1 traps as well as define the trap receiver

*Syntax* **show snmp** – displays the SNMP configuration information

*Syntax* **mgrip** <add | delete> ip=<IPaddress> - adds or deletes a management station, specified by the IP address, which can query SNMP variables from the switch. This is done to protect the switch from being polled by unauthorized managers. Valid for SNMP v1. Maximum of 5 stations allowed

*Syntax* **setvar** [sysname | syscontact | syslocation]=<string> sets the system name, contact and location. All parameters are optional but a user must supply at least one parameter

*Syntax* **snmpv3** – enter the SNMP V3 configuration mode – note enable SNMP V3 by using the “**set snmp**” command which follows

*Syntax* **quickcfg** - quick setup for snmpv3 configuration. It automatically configures a default VACM (view-based access control model). This allows any manager station to access the Magnum 6K switch either via SNMP v1, v2c or v3. The community name is “public”. This command is only intended for first time users and values can be changed by administrators who want more strict access

*Syntax* **engineid** string=<string> - Every agent has to have an engineID (name) to be able to respond to SNMPv3 messages. The default engine ID value is “6K\_v3Engine”. This command allows the user to change the engine ID

*Syntax* **show-authtrap** - displays the current value of authentication trap status.

*Syntax* **deftrap** community=<string> - defines the default community string to be used when sending traps. When user does not specify the trap community name when setting a trap station using the “trap” command, the default trap community name is used

*Syntax* **show-deftrap** - displays the current value of default trap

*Syntax* **trap** <add | delete> id=<id> [type=<v1 | v2 | inform>] [host=<host-ip>] [community=<string>] [port=<1-65534>] - define the trap and inform manager stations. The station can receive v1, v2 traps and/or inform notifications. An inform notification is an acknowledgment that a trap has been received. A user can add up to 5 stations.

*Syntax* **show-trap** [id=<id#>]- shows the configured trap stations in tabular format - id is optional and is the number corresponding to the trap entry number in the table

*Syntax* **com2sec** <add | delete> id=<id> [secname=<name>] [source=<source>] [community=<community>] - a part of the View based Access control model (VACM) as defined in RFC 2275. This specifies the mapping from a source/community pair to a security name. On MNS-6K, up to 10 entries can be specified

*Syntax* **group** <add | delete> id=<id> [groupname=<name>] [model=<v1 | v2c | usm>] [com2secid=<com2sec-id>] - a part of the View based Access control model (VACM) as defined in RFC 2275. This command defines the mapping from sec model or a sec name to a group. A sec model is one of v1, v2c, or usm. On MNS-6K, up to 10 entries can be specified

*Syntax* **show-group** [id=<id>] - display all or specific group entries - id is optional and is the number corresponding to the group entry number in the table

*Syntax* **view** <add | delete> id=<id> [viewname=<name>] [type=<included | excluded>] [subtree=<oid>] [mask=<hex-string>] - a part of the View based Access control model (VACM) as defined in RFC 2275. This command defines a manager or group or manager stations what it can access inside the MIB object tree. On MNS-6K, up to 10 entries can be specified

*Syntax* **show-view** [id=<id>] - display all or specific view entries - id is optional and is the number corresponding to the view entry number in the table

*Syntax* **user** <add | delete> id=<id> [username=<name>] [usertype=<readonly | readwrite>] [authpass=<pass-phrase>] [privpass=<pass-phrase>] [level=<noauth | auth | priv>] [subtree=<oid>] for quickly adding or deleting v3 USM based security, this command adds user entries. MNS-6K allows up to 5 users to be added. Right now, the MNS-6K agent only support noauth and auth-md5 for v3 authentication and auth-des for priv authentication

*Syntax* **show-user** [id=<id>] - display all or specific view entries - id is optional and is the number corresponding to the view entry number in the table

```
Magnum6K25# set snmp type=v1
```

```
Magnum6K25# show active-snmp
```

6K SNMP Agent supports v1 only.

```
Magnum6K25# show snmp
```

#### SNMP CONFIGURATION INFORMATION

```
-----
SNMP Get Community Name      : public
SNMP Set Community Name     : private
SNMP Trap Community Name    : public
AuthenTrapsEnableFlag       : disabled
SNMP Access Status          : enabled
```



SNMP MANAGERS INFO  
-----

SNMP TRAP STATIONS INFO  
-----

**Magnum6K25# snmp**

**Magnum6K25(snm)## community write=private read=public**

SNMP Read community name successfully set

SNMP Write community name successfully set

**Magnum6K25(snm)## show snmp**

SNMP CONFIGURATION INFORMATION  
-----

SNMP Get Community Name : public  
 SNMP Set Community Name : private  
 SNMP Trap Community Name : public  
 AuthenTrapsEnableFlag : enabled  
 SNMP Access Status : enabled

SNMP MANAGERS INFO  
-----

SNMP TRAP STATIONS INFO  
-----

**Magnum6K25(snm)## mgrip add ip=192.168.1.111**

Manager IP Address added successfully

**Magnum6K25(snm)## mgrip add ip=192.168.1.222**

Manager IP Address added successfully

*Use this command for SNMP v1 managers. Without this command SNMP v1 managers will not be able to manage the switches. Not needed for SNMP v3. Note – maximum of 5 stations allowed.*

**Magnum6K25(snm)# show snmp**

SNMP CONFIGURATION INFORMATION  
-----

SNMP Get Community Name : public  
 SNMP Set Community Name : private  
 SNMP Trap Community Name : public  
 AuthenTrapsEnableFlag : disabled  
 SNMP Access Status : enabled

*Managers added are displayed under the SNMP information by using the “show snmp” command*

SNMP MANAGERS INFO  
-----

IP Address = 192.168.1.111  
 IP Address = 192.168.1.222

## SNMP TRAP STATIONS INFO

**Magnum6K25(snmp)## traps add type=Snmp,Rmon ip=192.168.1.2**

Successfully Added.

**Magnum6K25(snmp)## show snmp**

## SNMP CONFIGURATION INFORMATION

SNMP Get Community Name : public  
 SNMP Set Community Name : private  
 SNMP Trap Community Name : public  
 AuthenTrapsEnableFlag : enabled  
 SNMP Access Status : enabled

*Managers added are displayed under the  
 SNMP information by using the "show  
 snmp" command*

## SNMP MANAGERS INFO

IP Address = 192.168.1.111  
 IP Address = 192.168.1.222

## SNMP TRAP STATIONS INFO

IP Address = 192.168.1.2 Trap Type = SNMP,RMON

**Magnum6K25(snmp)# exit**

**Magnum6K25# show snmp**

## SNMP CONFIGURATION INFORMATION

SNMP Get Community Name : public  
 SNMP Set Community Name : private  
 SNMP Trap Community Name : public  
 AuthenTrapsEnableFlag : enabled  
 SNMP Access Status : enabled

## SNMP MANAGERS INFO

IP Address = 192.168.1.111  
 IP Address = 192.168.1.222

## SNMP TRAP STATIONS INFO

IP Address = 192.168.1.2 Trap Type = SNMP,Enterprise

**Magnum6K25# set snmp type=all**

SNMP version support is set to "v1, v2c and v3"

**Magnum6K25# show active-snmp**

6K SNMP Agent supports all (v1/v2c/v3) versions.

**Magnum6K25# show snmp**

SNMP v3 Configuration Information

=====

```
System Name           : Magnum6K25
System Location      : Fremont, CA
System Contact       : support@garrettcom.com
Authentication Trap  : Disabled
Default Trap Comm.   : public
V3 Engine ID        : 6K_v3Engine
```

**Magnum6K25# snmpv3**

*Switch over to SNMPv3 from this point forward*

**Magnum6K25(snmpv3)## setvar sysname=my\_m6k syscontact=admin syslocation=lab**

**Magnum6K25(snmpv3)# quickcfg**

This will enable default VACM.

Do you wish to proceed? [ 'Y' or 'N' ] **Y**

Quick configuration done, default VACM enabled

*Max limit of system variables is  
15 characters*

**Magnum6K25(snmpv3)## engineid string=Magnum6K**

Engine ID is set successfully

**Magnum6K25(snmpv3)## authtrap enable**

Authentication trap status is set successfully

**Magnum6K25(snmpv3)## show-authtrap**

Authentication Trap Status: Enabled

**Magnum6K25(snmpv3)## deftrap community=mysecret**

Default trap community is set successfully

**Magnum6K25(snmpv3)## show-deftrap**

Default Trap Community : public

**Magnum6K25(snmpv3)## trap add id=1 type=v1 host=10.21.1.100**

Entry is added successfully

**Magnum6K25(snmpv3)## show-trap**

| ID | Trap Type | Host IP     | Community | Port |
|----|-----------|-------------|-----------|------|
| 1  | v1        | 10.21.1.100 | --        | --   |
| 2  | --        | --          | --        | --   |
| 3  | --        | --          | --        | --   |
| 4  | --        | --          | --        | --   |
| 5  | --        | --          | --        | --   |

**Magnum6K25(snmpv3)## show-trap id=1**

```

Trap ID      : 1
Trap Type    : v1
Host IP      : 10.21.1.100
Community    : --
Auth. Type   : --

```

**Magnum6K25(snmpv3)## com2sec add id=1 secname=public source=default community=public**

Entry is added successfully

**Magnum6K25(snmpv3)## com2sec add id=2**

ERROR: "secname" parameter is required for "add" directive

**Magnum6K25(snmpv3)## com2sec add id=2 secname=BCM**

Entry is added successfully

**Magnum6K25(snmpv3)## show-com2sec**

| ID | Sec. Name | Source  | Community |
|----|-----------|---------|-----------|
| 1  | public    | default | public    |
| 2  | BCM       | default | public    |
| 3  | --        | --      | --        |
| 4  | --        | --      | --        |
| 5  | --        | --      | --        |
| 6  | --        | --      | --        |
| 7  | --        | --      | --        |
| 8  | --        | --      | --        |
| 9  | --        | --      | --        |
| 10 | --        | --      | --        |

**Magnum6K25(snmpv3)## show-com2sec id=2**

```

Com2Sec ID   : 2
Security Name : BCM
Source       : default
Community    : public

```

**Magnum6K25(snmpv3)## group add id=1 groupname=v1 model=v1 com2secid=1**

Entry is added successfully

**Magnum6K25(snmpv3)## show-group**

| ID | Group Name | Sec. Model | Com2Sec ID |
|----|------------|------------|------------|
| 1  | v1         | v1         | 1          |
| 2  | public     | v2c        | 1          |
| 3  | public     | usm        | 1          |
| 4  | --         | --         | --         |
| 5  | --         | --         | --         |
| 6  | --         | --         | --         |
| 7  | --         | --         | --         |
| 8  | --         | --         | --         |
| 9  | --         | --         | --         |
| 10 | --         | --         | --         |

**Magnum6K25(snmpv3)## show-group id=1**

Group ID : 1  
 Group Name : v1  
 Model : v1  
 Com2Sec ID : 1

**Magnum6K25(snmpv3)## view add id=1 viewname=all type=included subtree=.1**

Entry is added successfully

**Magnum6K25(snmpv3)## show-view**

| ID | View Name | Type     | Subtree | Mask |
|----|-----------|----------|---------|------|
| 1  | all       | included | .1      | ff   |
| 2  | --        | --       | --      | --   |
| 3  | --        | --       | --      | --   |
| 4  | --        | --       | --      | --   |
| 5  | --        | --       | --      | --   |
| 6  | --        | --       | --      | --   |
| 7  | --        | --       | --      | --   |
| 8  | --        | --       | --      | --   |
| 9  | --        | --       | --      | --   |
| 10 | --        | --       | --      | --   |

**Magnum6K25(snmpv3)## show-view id=1**

View ID : 1  
 View Name : all  
 Type : included  
 Subtree : .1  
 Mask : ff

**Magnum6K25(snmpv3)## access add id=1 accessname=v1 model=v1 level=noauth read=1 write=none notify=none**

Entry is added successfully

**Magnum6K25(snmpv3)## show-access**

| ID | View Name | Model | Level  | R/View | W/View | N/View | Context | Prefix |
|----|-----------|-------|--------|--------|--------|--------|---------|--------|
| 1  | v1        | v1    | noauth | 1      | none   | none   | ""      | exact  |
| 2  | --        | --    | --     | --     | --     | --     | --      | --     |
| 3  | --        | --    | --     | --     | --     | --     | --      | --     |
| 4  | --        | --    | --     | --     | --     | --     | --      | --     |
| 5  | --        | --    | --     | --     | --     | --     | --      | --     |
| 6  | --        | --    | --     | --     | --     | --     | --      | --     |
| 7  | --        | --    | --     | --     | --     | --     | --      | --     |
| 8  | --        | --    | --     | --     | --     | --     | --      | --     |
| 9  | --        | --    | --     | --     | --     | --     | --      | --     |
| 10 | --        | --    | --     | --     | --     | --     | --      | --     |

**Magnum6K25(snmpv3)## show-access id=1**

Access ID : 1  
 Access Name : v1  
 Sec. Model : v1  
 Sec. Level : noauth  
 Read View ID : 1  
 Write View ID : none  
 Notify View ID : none  
 Context : ""  
 Prefix : exact

**Magnum6K25(snmpv3)## user add id=1 username=jsmith usertype=readwrite authpass=something**

Entry is added successfully

**Magnum6K25(snmpv3)## show-user**

| ID | User Name | UType | AuthPass  | PrivPass | AType | Level | Subtree |
|----|-----------|-------|-----------|----------|-------|-------|---------|
| 1  | jsmith    | RW    | something |          | MD5   | auth  |         |
| 2  | --        | --    | --        | --       | --    | --    | --      |
| 3  | --        | --    | --        | --       | --    | --    | --      |
| 4  | --        | --    | --        | --       | --    | --    | --      |
| 5  | --        | --    | --        | --       | --    | --    | --      |

**Magnum6K25(snmpv3)## show-user id=2**

ERROR: Entry is not active

```

Magnum6K25(snmpv3)## show-user id=1

User ID      : 1
User Name    : jsmith
User Type    : read-write
Auth. Pass   something
Priv. Pass   :
Auth. Type   : MD5
Auth. Level  : auth
Subtree     :

Magnum6K25(snmpv3)## exit

Magnum6K25# show snmp

SNMPv3 Configuration Information
=====

System Name      : Magnum6K25
System Location  : Fremont, CA
System Contact   : support@garrettcom.com
Authentication Trap : Enabled
Default Trap Comm. : public
V3 Engine ID     : 6K_v3Engine

Magnum6K25#

```

FIGURE 128 – *Configuring SNMP – most of the command here are SNMP v3 commands*

## Configuring RMON

The switch supports RMON (Remote Monitoring) on all connected network segments. This allows for troubleshooting and optimizing your network. The Magnum 6K family of switches provides hardware-based RMON counters. The switch manager or a network management system can poll these counters periodically to collect the statistics in a format that complies with the RMON MIB definition.

The following RMON groups are supported:

- Ethernet Statistics Group - maintains utilization and error statistics for the switch port being monitored.
- History Group – gathers and stores periodic statistical samples from previous Statistics Group.
- Alarm Group – allows a network administrator to define alarm thresholds for any MIB variable.
- Log and Event Group – allows a network administrator to define actions based on alarms. SNMP Traps are generated when RMON Alarms are triggered.

The following RMON communities, when defined, enable the specific RMON group as show above.

*Syntax* **rmon** – enter the RMON configuration mode to setup RMON groups and communities

*Syntax* **history def-owner=<string> def-comm=<string>** - define the RMON history group and the community string associated with the group

*Syntax* **statistics def-owner=<string> def-comm=<string>**- define the RMON statistics group and the community string associated with the group

*Syntax* **alarm def-owner=<string> def-comm=<string>** - define the RMON alarm group and the community string associated with the group

*Syntax* **event def-owner=<string> def-comm=<string>** - define the RMON event group and the community string associated with the group

*Syntax* **show rmon <stats | hist | event | alarm>** - list the specific RMON data as defined by the group type

**Magnum6K25# rmon**

**Magnum6K25(rmon)## event def-owner=test def-comm=somestring**

RMON Event Default Owner is set  
RMON Event Default Community is set

**Magnum6K25(rmon)## show rmon event**

RMON Event Default Owner : test  
RMON Event Default Community : somestring

**Magnum6K25(rmon)## exit**

**Magnum6K25#**

FIGURE 129 – Configuring RMON groups

## List of commands in this chapter

*Syntax* **snmp** – enter the SNMP Configuration mode



*Syntax* **snmpv3** – enter the SNMP V3 configuration mode – note enable SNMP V3 by using the “**set snmp**” command which follows

*Syntax* **show active-snmp** – shows the version of SNMP currently in use

*Syntax* **community [write=<write community>] [read=<read community>] [trap=<trap community>]** – set the necessary community strings

*Syntax* **authtraps <enable | disable>** - enables or disables authentication traps generation

*Syntax* **traps <add | delete> type=<Snm | Rmon | Snmp,Rmon | Enterprise | Snmp,Enterprise | Rmon,Enterprise | All> ip=<ipaddress>** - add v1 traps as well as define the trap receiver

*Syntax* **mgrip <add | delete> ip=<IPaddress>** - adds or deletes a management station, specified by the IP address, which can query SNMP variables from the switch. This is done to protect the switch from being polled by unauthorized managers. Valid for SNMP v. Maximum of five stations allowed.

*Syntax* **set snmp type=<v1 | all>** - define the version of SNMP to use – the option all supports all versions (v1, v2 and v3) – v1 restricts SNMP to v1 only. By default – SNMP v1 only is enabled

*Syntax* **show snmp** – displays the SNMP configuration information

*Syntax* **setvar [sysname | syscontact | syslocation]=<string>** sets the system name, contact and location. All parameters are optional but a user must supply at least one parameter

*Syntax* **quickcfg** - quick setup for snmpv3 configuration. It automatically configures a default VACM (view-based access control model). This allows any manager station to access the Magnum 6K switch either via SNMP v1, v2c or v3. The community name is “public”. This command is only intended for first time users and values can be changed by administrators who want more strict access

*Syntax* **engineid string=<string>** - Every agent has to have an engineID (name) to be able to respond to SNMPv3 messages. The default engine ID value is “6K\_v3Engine”. This command allows the user to change the engine ID

*Syntax* **authtrap <enable | disable>** - enables or disables authentication traps generation

*Syntax* **show-authtrap** - displays the current value of authentication trap status.

*Syntax* **deftrap community=<string>** - defines the default community string to be used when sending traps. When user does not specify the trap community name when setting a trap station using the “trap” command, the default trap community name is used

*Syntax* **show-deftrap** - displays the current value of default trap

**Syntax** `trap <add | delete> id=<id> [type=<v1 | v2 | inform>] [host=<host-ip>] [community=<string>] [port=<1-65534>]` - define the trap and inform manager stations. The station can receive v1, v2 traps and/or inform notifications. An inform notification is an acknowledgment that a trap has been received. A user can add up to 5 stations.

**Syntax** `show-trap [id=<id#>]` - shows the configured trap stations in tabular format - id is optional and is the number corresponding to the trap entry number in the table

**Syntax** `com2sec <add | delete> id=<id> [secname=<name>] [source=<source>] [community=<community>]` - a part of the View based Access control model (VACM) as defined in RFC 2275. This specifies the mapping from a source/community pair to a security name. On MNS-6K, up to 10 entries can be specified

**Syntax** `group <add | delete> id=<id> [groupname=<name>] [model=<v1 | v2c | usm>] [com2secid=<com2sec-id>]` - a part of the View based Access control model (VACM) as defined in RFC 2275. This command defines the mapping from sec model or a sec name to a group. A sec model is one of v1, v2c, or usm. On MNS-6K, up to 10 entries can be specified

**Syntax** `show-group [id=<id>]` - display all or specific group entries - id is optional and is the number corresponding to the group entry number in the table

**Syntax** `view <add | delete> id=<id> [viewname=<name>] [type=<included | excluded>] [subtree=<oid>] [mask=<hex-string>]` - a part of the View based Access control model (VACM) as defined in RFC 2275. This command defines a manager or group or manager stations what it can access inside the MIB object tree. On MNS-6K, up to 10 entries can be specified

**Syntax** `show-view [id=<id>]` - display all or specific view entries - id is optional and is the number corresponding to the view entry number in the table

**Syntax** `user <add | delete> id=<id> [username=<name>] [usertype=<readonly | readwrite>] [authpass=<pass-phrase>] [privpass=<pass-phrase>] [level=<noauth | auth | priv>] [subtree=<oid>]` for quickly adding or deleting v3 USM based security, this command adds user entries. MNS-6K allows up to 5 users to be added. Right now, the MNS-6K agent only support noauth and auth-md5 for v3 authentication and auth-des for priv authentication

**Syntax** `show-user [id=<id>]` - display all or specific view entries - id is optional and is the number corresponding to the view entry number in the table

**Syntax** `rmon` – enter the RMON configuration mode to setup RMON groups and communities

**Syntax** `history def-owner=<string> def-comm=<string>` - define the RMON history group and the community string associated with the group

*Syntax* **statistics def-owner=<string> def-comm=<string>** - *define the RMON statistics group and the community string associated with the group*

*Syntax* **alarm def-owner=<string> def-comm=<string>** - *define the RMON alarm group and the community string associated with the group*

*Syntax* **event def-owner=<string> def-comm=<string>** - *define the RMON event group and the community string associated with the group*

*Syntax* **show rmon <stats | hist | event | alarm>** - *list the specific RMON data as defined by the group type*

## 19 – Miscellaneous Commands

### *Improving productivity and manageability*

**T**here are several features built into the Magnum 6K family of switches which help with the overall productivity and manageability of the switch. These items are examined individually in this chapter.

## Alarm Relays

In a wiring closet, it would be helpful if there was a visual indication for faults on components on the network. Normally, these would be performed by LED's. While the Magnum 6K family of switches has the necessary LED's to provide the information needed, it also has a provision for tripping or activating an external relay to electrically trigger any circuit desired. These could be an indicator light, a flashing strobe light, an audible alarm or any other such devices.

The Magnum 6K family of switches has a software (optional) controlled relay contact that can be used to report alarm conditions. The relay is held open (no connection) in normal circumstances and will go to close position during alarm conditions.

Two types of alarm signals are defined in the alarm system.

- SUSTAINED
- MOMENTARY

The SUSTAINED mode is used to report a continuing error condition. The MOMENTARY mode is used to report a single event.

The following pre-defined events are currently supported on the MNS-6K and the relay which can be triggered by software:

| Event ID | Event Description              | Signal Type |
|----------|--------------------------------|-------------|
| 1        | S-RING OPEN                    | SUSTAINED   |
| 2        | Cold Start                     | MOMENTARY   |
| 3        | Warm Start                     | MOMENTARY   |
| 4        | Link Up                        | MOMENTARY   |
| 5        | Link Down                      | MOMENTARY   |
| 6        | Authentication Failure         | MOMENTARY   |
| 7        | RMON Rising Alarm <sup>9</sup> | MOMENTARY   |
| 8        | RMON Falling Alarm             | MOMENTARY   |
| 9        | Intruder Alarm                 | MOMENTARY   |
| 10       | Link Loss Learn Triggered      | MOMENTARY   |
| 11       | Broadcast Storm Detected       | MOMENTARY   |
| 12       | STP/RSTP Reconfigured          | MOMENTARY   |

**FIGURE 130** – *Predefined conditions for the relay*

The S-RING open condition generates a sustained relay contact close. The relay will stay closed during the period which the S-RING is in OPEN condition. The relay will revert to closed position when the S-RING goes to CLOSED position. This information is covered in more details in [Chapter 11 on S-Ring and Link-Loss-Learn](#).

To customize these capabilities, the MNS-6K provides additional software capabilities and commands for configuring the behavior. They are

*Syntax* **alarm** – *enter the alarm configuration mode*

*Syntax* **add event**=<event-id | list | range | all> - *enables alarm action in response to the specified event ID*

---

<sup>9</sup> The RMON settings are when the RMON thresholds are crossed and hence indicated as RMON rising or falling – indicating the threshold has been crossed . While there is no specific command to view and change the specific RMON variables, the RMON discussion is in Chapter 16. Best way to set RMON values will be via using the web interface or a Management system such as Castle Rock's SNMPc™

*Syntax* **period time=<1..10>** - sets the duration of relay action for the momentary type signal. This may be needed to adjust to the behavior of the circuit or relay. Default is 3 seconds. Time is in seconds

*Syntax* **del event=<event-id | list | range | all>** - disables alarm action in response to the specified event ID

*Syntax* **alarm <enable | disable>** - globally enables or disables the alarm action

*Syntax* **show alarm** - displays the current status of Alarm system

**Magnum6K25# alarm**

**Magnum6K25(alarm)## add event=2**

Alarm Event(s) Added: 2

**Magnum6K25(alarm)## add event=1-5**

Event 2 is Already Enabled.

Alarm Event(s) Added: 1, 3, 4, 5

**Magnum6K25(alarm)## add event=6,8**

Alarm Event(s) Added: 6, 8

**Magnum6K25(alarm)## add event=all**

Event 1 is Already Enabled.

Event 2 is Already Enabled.

Event 3 is Already Enabled.

Event 4 is Already Enabled.

Event 5 is Already Enabled.

Event 6 is Already Enabled.

Event 8 is Already Enabled.

Alarm Event(s) Added: 7, 9, 10, 11, 12

**Magnum6K25(alarm)## del event=2**

Alarm Event(s) Deleted: 2

**Magnum6K25(alarm)## period time=5**

Relay closure Time Set.

**Magnum6K25(alarm)## show alarm**

Alarm Events Configuration

-----

Alarm Status: DISABLED

Relay Closure Time Period: 5 Seconds

| EventId | Description | Mode        |
|---------|-------------|-------------|
| 1       | S-RING OPEN | SUSTAINED   |
| 2       | Cold Start  | NOT ENABLED |
| 3       | Warm Start  | MOMENTARY   |
| 4       | Link Up     | MOMENTARY   |

|                              |           |
|------------------------------|-----------|
| 5 Link Down                  | MOMENTARY |
| 6 Authentication Failure     | MOMENTARY |
| 7 RMON Raising Alarm         | MOMENTARY |
| 8 RMON Falling Alarm         | MOMENTARY |
| 9 Intruder Alarm             | MOMENTARY |
| 10 Link Loss Learn Triggered | MOMENTARY |
| 11 Broadcast Storm Detected  | MOMENTARY |
| 12 STP/RSTP Reconfigured     | MOMENTARY |

**Magnum6K25(alarm)## add event=2**

Alarm Event(s) Added: 2

**Magnum6K25(alarm)## show alarm**

Alarm Events Configuration

-----

Alarm Status: DISABLED  
Relay Closure Time Period: 5 Seconds

| EventId | Description               | Mode      |
|---------|---------------------------|-----------|
| 1       | S-RING OPEN               | SUSTAINED |
| 2       | Cold Start                | MOMENTARY |
| 3       | Warm Start                | MOMENTARY |
| 4       | Link Up                   | MOMENTARY |
| 5       | Link Down                 | MOMENTARY |
| 6       | Authentication Failure    | MOMENTARY |
| 7       | RMON Raising Alarm        | MOMENTARY |
| 8       | RMON Falling Alarm        | MOMENTARY |
| 9       | Intruder Alarm            | MOMENTARY |
| 10      | Link Loss Learn Triggered | MOMENTARY |
| 11      | Broadcast Storm Detected  | MOMENTARY |
| 12      | STP/RSTP Reconfigured     | MOMENTARY |

**Magnum6K25(alarm)## alarm enable**

Alarm system Enabled

**Magnum6K25(alarm)## show alarm**

Alarm Events Configuration

-----

Alarm Status: ENABLED  
Relay Closure Time Period: 5 Seconds

| EventId | Description            | Mode      |
|---------|------------------------|-----------|
| 1       | S-RING OPEN            | SUSTAINED |
| 2       | Cold Start             | MOMENTARY |
| 3       | Warm Start             | MOMENTARY |
| 4       | Link Up                | MOMENTARY |
| 5       | Link Down              | MOMENTARY |
| 6       | Authentication Failure | MOMENTARY |
| 7       | RMON Raising Alarm     | MOMENTARY |

```

8 RMON Falling Alarm           MOMENTARY
9 Intruder Alarm              MOMENTARY
10 Link Loss Learn Triggered  MOMENTARY
11 Broadcast Storm Detected   MOMENTARY
12 STP/RSTP Reconfigured     MOMENTARY

Magnum6K25(alarm)## alarm disable
Alarm system Disabled

Magnum6K25(alarm)## del event=1,3,5,7
Alarm Event(s) Deleted: 1, 3, 5, 7

Magnum6K25(alarm)## show alarm
Alarm Events Configuration
-----

Alarm Status: DISABLED
Relay Closure Time Period: 5 Seconds

      EventId Description                Mode
-----
1 S-RING OPEN                          NOT ENABLED
2 Cold Start                            MOMENTARY
3 Warm Start                            NOT ENABLED
4 Link Up                               MOMENTARY
5 Link Down                             NOT ENABLED
6 Authentication Failure                MOMENTARY
7 RMON Raising Alarm                   NOT ENABLED
8 RMON Falling Alarm                   MOMENTARY
9 Intruder Alarm                       MOMENTARY
10 Link Loss Learn Triggered           MOMENTARY
11 Broadcast Storm Detected            MOMENTARY
12 STP/RSTP Reconfigured               MOMENTARY

Magnum6K25(alarm)## exit

Magnum6K25#

```

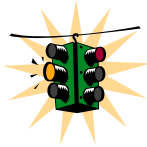
FIGURE 131 – Setting up the external electrical relay and alerts

## Email

SMTP (RFC 821) is a TCP/IP protocol used in sending email. However, since it is limited in its ability to queue messages at the receiving end, it's usually used with one of two other protocols, POP3 or Internet Message Access Protocol (IMAP) that lets the user save messages in a server mailbox and download them as needed from the server. In other words, users typically use a program that uses SMTP for sending emails (out going – e.g. replying to an email message) and



either POP3 or IMAP for receiving messages that have been arrived from the outside world. While SMTP (and its related protocols such as POP3, IMAP etc.) are useful transports for sending and receiving emails, it is extremely beneficial for a network administrator to receive emails in case of faults and alerts. The Magnum 6K family of switches can be setup to send an email alert when a trap is generated.



If this capability is used, please ensure that SPAM filters and other filters are not set to delete these emails.

GarrettCom Inc. recommends that a rule be setup on the mail server so that all emails indicating SNMP faults are automatically stored in a folder or redirected to the necessary administrators.

The SNMP alerts can be configured using MNS-6K for the following:

- Send email alert according to the configuration rules when a specific event category happens
- Send email alert according to the configuration rules when a specific trap SNMP trap category happens
- Provide configuration and customization commands for users to specify SMTP server to connect to, TCP ports, user recipients and filters

The SMTP alerts provide the following capabilities:

- SMTP alerts can be enabled or disabled globally
- User can define a global default SMTP server identified by its IP address, TCP port and retry count
- User can add up to five SMTP alert recipients. Each recipient is identified by an ID and email address. The email address needs to be a valid address and can be an alias setup for distribution to a larger audience
- Filters are provided for each recipient to allow only certain categories of traps and events be sent by email
- Each recipient can have its own SMTP server and TCP port number, if this is not defined on a certain recipient, the default SMTP server and TCP port number is used

*Syntax* **smtp** – *configure the SNMP alerts to be sent via email*

*Syntax* **show smtp <config|recipients>** - **config** – *displays the current SMTP global settings and recipients displays the currently configured recipients of email alerts*

*Syntax* **add id=<1-5> email=<email-addr> [traps=<all|none|S|R|E>]  
[events=<all|none|I|A|C|F|D>] [ip=<ip-addr>] [port=<1-65535>]**

**id** – [mandatory] the recipient ID - range from 1 to 5. MNS-6K allows a maximum of 5 recipients

**email** – [mandatory] email address of the recipient

**traps** – [optional] this is the trap filter. If value is “all”, all traps of any type will be sent to this recipient. If value is none, no traps are sent to this recipient. Value can also be a combination of ‘S’ (SNMP), ‘R’ (RMON) and ‘E’ (ENTERPRISE). For example, trap=SR means that SNMP and RMON traps will be sent via email to the recipient. If this option is not defined, the recipient will have a default value of “all”

**events** – [optional] this is the event filter. Value can be “all” - all event severity types will be sent to recipient, “none” - no event will be sent to recipient or a combination of ‘I’ (informational), ‘A’ (activity), ‘C’ (critical), ‘F’ (fatal) and ‘D’ (debug). With “**event=ACF**” implies that events of severity types activity, critical and fatal will be sent to recipients by email. If this option is not defined, a value of “all” is taken

**ip** – [optional] SMTP server IP address. This is the SMTP server to connect to for this particular user. If this option is not defined, the global/default SMTP server is used

**port** – [optional] TCP port of the SMTP server. If this is not defined, the global default TCP port is used

*Syntax* **delete id=<1-5>** - delete the specific id specified. The deleted id no longer receives the traps via email. The id is added using the “add” command

*Syntax* **sendmail server=<ip-addr> to=<email-addr> from=<email-addr> subject=<string> body=<string>** - customize (and also to send a test email to check SMTP settings) the email sent out by specifying the email subject field, server address, to field and the body of the text. See example for the body of the text message later in this chapter

**server** – [mandatory] SMTP server IP v4 address.

**to** – [mandatory] the recipient email address

**from** – [mandatory] the sender email address.

**subject** – [mandatory] email subject or title

**body** – [mandatory] email body

*Syntax* **server ip=<ip-addr> [port=<1-65535>] [retry=<0-3>]** – configure the global SMTP server settings

**ip** – [mandatory] SMTP server IP address

**port** – [mandatory] TCP port to be used for SMTP communications – default is 25

**retry** – [optional] specifies how many times to retry if an error occurs when sending email.  
 Range from 0 to 3. Default is 0.

*Syntax* **smtp** <enable | disable> - enables or disables SMTP to send SNMP alerts by email

```

Magnum6K25# smtp

Magnum6K25(smtp)## show smtp config

    SMTP Global Configuration
    =====
    Status                : Disabled
    SMTP Server IP        : 67.109.247.195
    SMTP Server Port      : 25
    Retry Count           : 3

Magnum6K25(smtp)## show smtp recipients

    ID      E-mail Address      SMTP Server      Port      Traps      Events
    =====
    1       rk@gci,sys@gci.com  67.109.247.195  25        All        All
    2       --                  --              --        --         --
    3       --                  --              --        --         --
    4       --                  --              --        --         --
    5       --                  --              --        --         --

Magnum6K25(smtp)## add id=2 email=jsmith@garrettcom.com traps=S events=CF

    Recipient successfully added

Magnum6K25(smtp)## show smtp recipients

    ID      E-mail Address      SMTP Server      Port      Traps      Events
    =====
    1       rk@gci,sys@gci.com  67.109.247.195  25        All        All
    2       jsmith@gci.com     67.109.247.195  25        S          CF
    3       --                  --              --        --         --
    4       --                  --              --        --         --
    5       --                  --              --        --         --

Magnum6K25(smtp)## delete id=2

    Recipient successfully deleted

Magnum6K25(smtp)## show smtp recipients

    ID      E-mail Address      SMTP Server      Port      Traps      Events
    =====
    1       rk@gci,sys@gci.com  67.109.247.195  25        All        All
    2       --                  --              --        --         --
    3       --                  --              --        --         --
    4       --                  --              --        --         --
    
```

*Note – there are two recipients – multiple recipients can be added – they have to be comma separated and there should be no spaces between each name.*

*Jsmith will only receive Critical or Fatal SNMP traps*

5 -- -- -- --

**Magnum6K25(smtp)## add id=2 email=jsmith@garrettcom.com traps=S events=CF ip=192.168.10.13**

Recipient successfully added

*Jsmith will receive Critical and Fatal SNMP traps on a different SMTP server than the other users. You may want to do that if you expect a higher traffic load and don't want to throttle a SMTP server*

**Magnum6K25(smtp)## show smtp recipients**

| ID | E-mail Address     | SMTP Server    | Port | Traps | Events |
|----|--------------------|----------------|------|-------|--------|
| 1  | rk@gci.sys@gci.com | 67.109.247.195 | 25   | All   | All    |
| 2  | jsmith@gci.com     | 192.168.10.13  | 25   | S     | CF     |
| 3  | --                 | --             | --   | --    | --     |
| 4  | --                 | --             | --   | --    | --     |
| 5  | --                 | --             | --   | --    | --     |

**Magnum6K25(smtp)## sendmail server=10.21.1.2 to=jack@garrettcom.com from=support@garrettcom.com subject=test body=hello**

**Magnum6K25(smtp)## smtp enable**

SMTP Alert is enabled.

*A test email is sent to Jack to test email connectivity. This email will not work as SMTP was disabled. The sendmail command after SMTP is enabled will work.*

**Magnum6K25(smtp)## sendmail server=10.21.1.2 to=jack@garrettcom.com from=support@garrettcom.com subject=test body=hello**

**Magnum6K25(smtp)## show smtp config**

SMTP Global Configuration

```
=====
Status           : Enabled
SMTP Server IP   : 67.109.247.195
SMTP Server Port : 25
Retry Count      : 3
```

**Magnum6K25(smtp)## smtp disable**

SMTP Alert is disabled.

**Magnum6K25(smtp)## show smtp config**

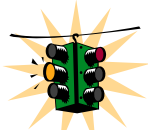
SMTP Global Configuration

```
=====
Status           : Disabled
SMTP Server IP   : 67.109.247.195
SMTP Server Port : 25
Retry Count      : 3
```

**Magnum6K25(smtp)## exit**

**Magnum6K25#**

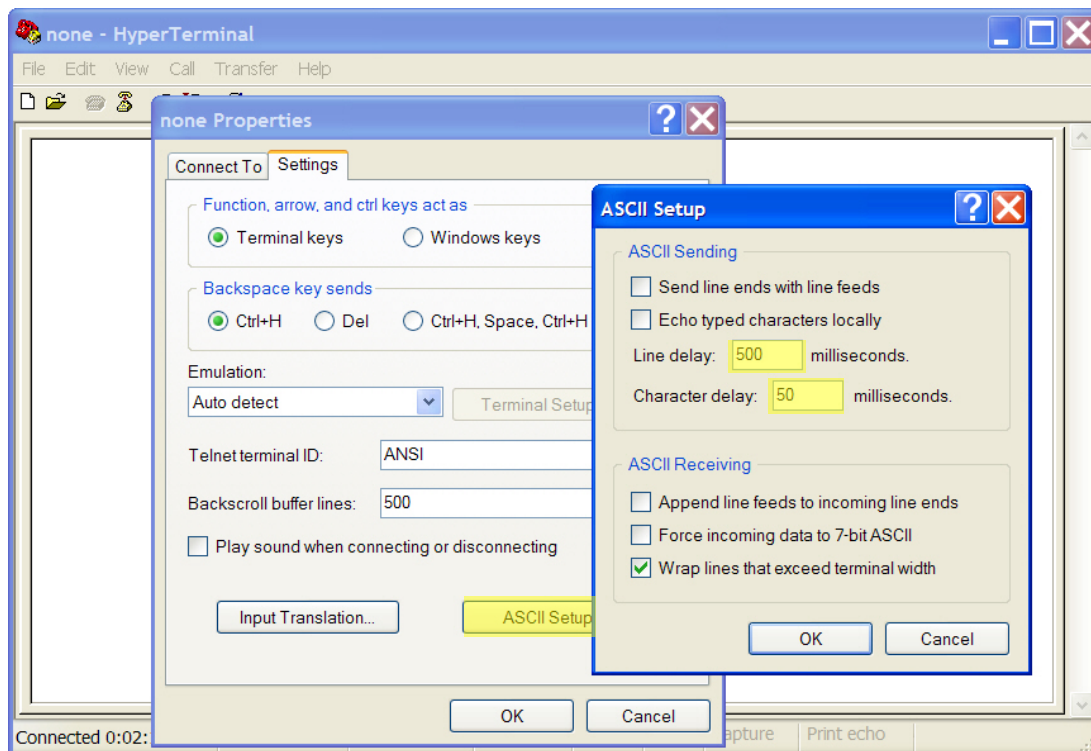
**FIGURE 132** – setting SMTP to receive SNMP trap information via email



Email alerts can be forwarded to be received by other devices such as Cell phones, pagers etc. Most interfaces to SMTP are already provided by the cell phone service provider or the paging service provider.

## Serial Connectivity

When using the serial connectivity with applications such as Hyper terminal etc. it may be necessary to optimize the character delays so that the FIFO buffer used in the GarrettCom Magnum 6K family of switches is not overrun. The important parameters to set for any serial connectivity software is to set the line delay to be 500 milliseconds and the character delay to be 50 milliseconds. For example, using Hyper Terminal this can be set under File → Properties and when the Properties sheet is open, click on the ASCII Setup button and in the Line Delay entry box enter in 500 and in the Character Delay entry box enter in 50 as shown below.



**FIGURE 133** – Optimizing serial connection (shown for Hyper Terminal on Windows XP). The highlighted fields are the ones to change as described

Note – this is needed if you plan to cut and paste between a serial window and another file. This allows the buffer management of the serial port on the Magnum 6K family of switches.

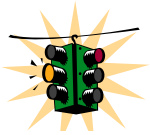
## Miscellaneous commands

Some of the commands listed below may be useful in repeating several commands over and over again. They are

*Syntax* **!!** – repeat the last command

*Syntax* **!**<n>**** - repeat the “n”th command (as indicated by a show history)

*Syntax* **show history** – show the last 25 commands executed – if less than 25 commands are executed, only those commands executed are shown



If the user logs out or if the switch times out – the history is erased. The history count restarts when the user logs in again

*Syntax* **<Up-arrow>** - every time the key is pressed, the last command is printed on the screen but not executed. This allows for editing errors made in typing

*Syntax* **<Down-arrow>** - opposite of Up-arrow key

*Syntax* **show version** – displays the version of MNS-6K being used

### Magnum6K25# **show version**

MNS-6K Ver: 3.6 Date:Oct 20 2006 Time:17:22:35 Build ID 1161390154

### Magnum6K25# **show setup**

```
Version           : Magnum 6K25 build 3.6 Oct 20 2006 17:22:35
MAC Address       : 00:20:06:25:ed:80
IP Address        : 67.109.247.197
Subnet Mask       : 255.255.255.224
Gateway Address   : 67.109.247.193
CLI Mode          : Manager
System Name       : pierpaolo
System Description : 25 Port Modular Ethernet Switch
System Contact    : support@garrettcom.com
System Location   : HQ, Fremont, CA
System Objectid   : 1.3.6.1.4.1.553.12.6
```

### Magnum6K25# **show serial**

```

Baud Rate : 38400
Data      : 8
Parity    : No Parity
Stop      : 1
Flow Control : None

Magnum6K25# show history

1 : show version
2 : show setup
3 : show serial
4 : show history

Magnum6K25# !1
show version
MNS-6K Ver: 3.6 Date:Oct 20 2006 Time:17:22:35 Build ID 1161390154

Magnum6K25#

```

FIGURE 134 – History commands

## Prompt

Setting a meaningful host prompt can be useful when a network administrator is managing multiple switches and has multiple telnet or console sessions open at the same time. To facilitate this, MNS-6K allows administrators to define custom prompts. The command to set a prompt is

*Syntax* **set prompt <prompt string>**

The length of the prompt is limited to 60 characters

There are predefined variables which can be used to set the prompt. These are

- \$n : System Name
- \$c : System Contact
- \$l : System Location
- \$i : System IP
- \$m : System MAC
- \$v : Version
- \$\$ : \$ Character
- \$r : New Line
- \$b : Space

A few examples on how the system prompt can be setup is shown below.

```

Magnum6K25# snmp
Magnum6K25(snmp)## setvar sysname=Core
System variable(s) set successfully
Magnum6K25(snmp)## exit
Magnum6K25# set prompt $n
Core# set prompt $n$b$i
Core 192.168.5.5# set prompt $n$b$i$b
Core 192.168.5.5 # snmp
Core 192.168.5.5 (snmp)## setvar sysname=Magnum6K25
System variable(s) set successfully
Core 192.168.5.5 (snmp)## exit
Core 192.168.5.5 # set prompt $b$b$i$b
192.168.5.5 # set prompt $n$b$i$b
Magnum6K25 192.168.5.5 #
Magnum6K25 192.168.5.5 #
Magnum6K25 192.168.5.5 #
Magnum6K25 192.168.5.5 # set prompt Some$bthing$i
Some thing192.168.5.5# set prompt Some$bthing$b$i
Some thing 192.168.5.5#

```

FIGURE 135 – Setting custom prompts

## Ping

Ping command can be used from MNS-6K to test connectivity to other devices as well as checking to see if the IP address is setup correctly. The command is

*Syntax* **ping** <ipaddress> [count=<1-999>] [timeout=<1-256>] – use the ping command to test connectivity

```

Magnum6K25# ping 67.109.247.202

67.109.247.202 is alive, count 1, time = 40ms

Magnum6K25# ping 67.109.247.202 count=3

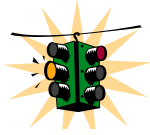
67.109.247.202 is alive, count 1, time = 20ms
67.109.247.202 is alive, count 2, time = 20ms
67.109.247.202 is alive, count 3, time = 40ms

Magnum6K25#

```

FIGURE 136 – Using the ping command





Many devices do not respond to ping or block ping commands. Make sure that the target device does respond or the network does allow the ping packets to propagate through.

## FTP modes

The file transfer protocol or ftp is supported on MNS-6K. MNS-6K supports normal ftp as well as passive ftp. Passive FTP is used by many companies today to work with firewall policies and other security policies set by companies. The commands for setting the type of ftp are:

*Syntax* **set ftp mode=<normal | passive>** - set the ftp mode of operation

*Syntax* **show ftp**- display the current ftp operation mode

FTP uses a set of separate ports for the data stream and command stream. This causes problems in security conscious companies who prefer that the client initiate the file transfer as well as the stream for the commands. To accommodate that, ftp added the capability called “passive ftp” in which the client initiating the connection initiates both the data and command connection request. Most companies prefer passive ftp and GarrettCom MNS-6K provides means to operate in those environments.

## System Events

The Event Log records operating events as single-line entries listed in chronological order, and therefore can be a useful tool for isolating problems. Each Event Log entry is composed of four fields as shown below:

| S  | Date  | Time  | Description |
|----|-------|-------|-------------|
| -- | ----- | ----- | -----       |

**S** or **Severity** is one of the following:

**I** (Information) indicates routine events

**A** (Activity) indicates the activity on Switch

**D** (Debug). reserved for Magnum MNS-6K internal diagnostic information

**C** (Critical) indicates that a severe Switch error has occurred

**F** (Fatal). indicates that a service has behaved unexpectedly

**Date** is the date in *mm/dd/yy* format (as per configured) that the entry was placed in the log.

**Time** is the time in *hh:mm:ss* format (as per configured) that the entry was placed in the log.

**Description** is a brief description of the event

The event log holds up to 1000 lines in chronological order, from the oldest to the newest. Each line consists of one complete event message. NOTE – since the event logs are written on the flash, once the flash memory is full, the logs stop writing. It is

important to erase the log periodically or use syslog capability to download the logs to a syslog server. The event log window contains 22 log entry lines.

```
Magnum6K25# show log
```

| S  | DATE       | TIME         | Log Description                                   |
|----|------------|--------------|---|
| -- | -----      | -----        | -----   |
| I  | 03-02-2005 | 5:14:43 P.M  | SYSMGR:System Subnet Mask changed                 |
| I  | 01-01-2001 | 12:00:00 A.M | SYSMGR:successfully registered with DB Manager    |
| I  | 01-01-2001 | 12:00:00 A.M | SYSMGR:successfully read from DB                  |
| A  | 01-01-2001 | 12:00:00 A.M | VLAN:Vlan type set to Port VLAN                   |
| I  | 01-01-2001 | 12:00:00 A.M | SYSMGR:system was reset by user using CLI command |
| I  | 01-01-2001 | 12:00:00 A.M | SNTP:Date/Time set to 01-01-2001 12:00AM          |
| I  | 01-01-2001 | 12:00:00 A.M | SNTP:Client started                               |
| I  | 03-03-2005 | 4:32:48 A.M  | SNTP:Date and Time updated from SNTP server       |
| I  | 03-03-2005 | 9:31:59 A.M  | TELNET:Telnet Session Started                     |
| I  | 03-03-2005 | 9:32:04 A.M  | CLI:manager console login                         |
| A  | 03-03-2005 | 9:32:11 A.M  | IGMP:IGMP Snooping is enabled                     |
| A  | 03-03-2005 | 9:35:40 A.M  | IGMP:IGMP Snooping is disabled                    |
| A  | 03-03-2005 | 9:41:46 A.M  | IGMP:IGMP Snooping is enabled                     |

```
Magnum6K25#
```

FIGURE 137 – Event log shown on the screen

Event logs can be exported to a ftp or a TFTP server on the network for further analysis or for other uses. To facilitate the export of the event log, the CLI command is exportlog as shown below

*Syntax* **exportlog mode=<serial|tftp|ftp> [<ipaddress>] [file=<name>] [doctype=<raw|html>]** – facilitates the export of the event log information as a text file or as an HTML file

Where

**mode=<serial|tftp|ftp>** - is the mode of transfer

**<ipaddress>** - is the IP address of the ftp or TFTP server

**file=<name>** - is the file name – please make sure the proper file extension is used e.g  
html for an html file

**doctype=<raw|html>** - indicates the log is saved as a text file (raw) or as an HTML file

```
Magnum6K25# exportlog
Usage
  exportlog mode=<serial|tftp|ftp> [<ipaddress>] [file=<name>] [doctype=<raw|html>]
Magnum6K25# exportlog mode=tftp 192.168.5.2 file=eventlog doctype=html
Do you wish to export the event logs? ['Y' or 'N'] Y
Successfully uploaded the event log file.
Magnum6K25# exportlog mode=tftp 192.168.5.2 file=eventlog.txt doctype=raw
Do you wish to export the event logs? ['Y' or 'N'] Y
Successfully uploaded the event log file.
Magnum6K25#
```

FIGURE 138 – *Using exportlog to export the event log information*

*Intentionally left blank*

For the alerts, the events per subsystem function are listed below. The table is sorted by the subsystem function first and then by the severity level.

| Subsystem | Description                                   | Severity |
|-----------|---|----------|
| BRIDGE    | Unable to delete MAC address from FDB         | D        |
| BRIDGE    | Unable to insert MAC address to FDB           | D        |
| BRIDGE    | Bridge init failed for ethx                   | F        |
| BRIDGE    | Bridge enable for ethx failed                 | F        |
| BRIDGE    | Bridge MIB init is done                       | I        |
| CLI       | Manager login at console                      | I        |
| CLI       | Operator login at console                     | I        |
| CLI       | Manager password changed                      | I        |
| CLI       | Operator password changed                     | I        |
| DEVICE    | Port x enabled                                | A        |
| DEVICE    | Port x disabled                               | A        |
| DEVICE    | Port X link down                              | A        |
| DEVICE    | Port X link up                                | A        |
| DEVICE    | Ethernet counters init failure                | C        |
| DEVICE    | Unable to access ethernet counters            | C        |
| DEVICE    | Failed to read saved system logs              | D        |
| DEVICE    | Ethernet DMA init failure                     | F        |
| DEVICE    | Ethernet hardware error                       | F        |
| DEVICE    | Ethernet interrupt init failure               | F        |
| DEVICE    | Unable to allocate ethernet memory            | F        |
| DEVICE    | System started                                | I        |
| DEVICE    | Network Stack not yet configured              | I        |
| DEVICE    | IP address a.b.c.d configured                 | I        |
| DEVICE    | subnetmask a.b.c.d configured                 | I        |
| DEVICE    | Default gateway a.b.c.d configured            | I        |
| DEVICE    | Switch rebooted by user                       | I        |
| DEVICE    | No saved system logs                          | I        |
| DEVICE    | Timezone set to x                             | I        |
| DEVICE    | Country set to x (no DST)                     | I        |
| DEVICE    | Country set to x (DST valid)                  | I        |
| DEVICE    | Time set to x : y : z (HH:MM:SS) tz = a       | I        |
| DEVICE    | Date set to x : y : z (HH:MM:YYYY)            | I        |
| PRTMR     | Enabled by user monitor = x , sniffer = y     | I        |
| PRTMR     | Disabled by user                              | I        |
| PS        | INTRUDER a:b:c:d:e:f @ port X , port disabled | A        |
| PS        | INTRUDER a:b:c:d:e:f @ port X , port disabled | A        |
| PS        | Port security enabled                         | A        |
| PS        | port security disabled                        | A        |
| PS        | Resetting MAC a:b:c:d:e:f at port X failed    | C        |
| PS        | Unable to delete learnt MACs in hardware      | D        |

| Subsystem | Description  | Severity |
|-----------|--|----------|
| RMON      | Alarm : internal error , unable to get memory                            | F        |
| RMON      | Alarm : internal error, unable to get memory for alarm entry             | F        |
| RMON      | History : internal error, unable to get memory for history control entry | F        |
| RMON      | History : internal error, unable to get memory for history data entry    | F        |
| RMON      | History : internal error, unable to get memory                           | F        |
| RMON      | Event : unable to get memory for event entry                             | F        |
| RMON      | Alarm : unable to get memory for RMON logs                               | F        |
| RMON      | rising alarm trap sent to a.b.c.d by alarm entry X                       | I        |
| RMON      | falling alarm trap sent to a.b.c.d by alarm entry X                      | I        |
| RMON      | RMON init is done  | I        |
| RMON      | history : control entry X is set to valid                                | I        |
| RMON      | history : control entry X is set to invalid                              | I        |
| RMON      | Event : entry X is set to valid  | I        |
| RMON      | Event : entry X is set to invalid  | I        |
| RMON      | Alarm : entry X is set to valid  | I        |
| RMON      | Alarm : entry X is set to invalid  | I        |
| SNMP      | Snmp.snmpEnableAuthenTraps is set to enabled                             | A        |
| SNMP      | Snmp.snmpEnableAuthenTraps is set to disabled                            | A        |
| SNMP      | System.sysName configured  | A        |
| SNMP      | System.sysLocation configured  | A        |
| SNMP      | System.sysContact configured   | A        |
| SNMP      | Port X link up trap sent to a.b.c.d                                      | A        |
| SNMP      | Port X Link down trap sent to a.b.c.d                                    | A        |
| SNMP      | Configuring IP address in trap receivers list failed                     | D        |
| SNMP      | read community string changed  | I        |
| SNMP      | write community string changed   | I        |
| SNMP      | trap community string changed  | I        |
| SNMP      | authentication failure trap sent to a.b.c.d                              | I        |
| SNMP      | Trap receiver a.b.c.d added  | I        |
| SNMP      | Trap receiver a.b.c.d deleted  | I        |
| SNMP      | Coldstart trap sent to a.b.c.d   | I        |
| SNMP      | Warmstart trap sent to a.b.c.d   | I        |
| SNTP      | client started   | I        |
| SNTP      | client stopped....disabled by user                                       | I        |
| SNTP      | client stopped....server not configured                                  | I        |
| SNTP      | Request timed out  | I        |
| SNTP      | Retrying..   | I        |
| SNTP      | Time synchronized through SNTP   | I        |

| Subsystem | Description  | Severity |
|-----------|--|----------|
| TCP/IP    | Duplicate IP a.b.c.d sent from MAC address XXXXXX    | C        |
| TCP/IP    | Unable to allocate memory for an ICMP packet         | C        |
| TCP/IP    | IP packet from a.b.c.d , with checksum error dropped | D        |
| TCP/IP    | Bad IP fragments from a.b.c.d dropped                | D        |
| TCP/IP    | UDP checksum error in the received packet a.b.c.d    | D        |
| TCP/IP    | TCP checksum error in the received packet a.b.c.d    | D        |
| TCP/IP    | ICMP checksum error in the received packet           | D        |
| TCP/IP    | Failed to initialize the interface x                 | F        |
| TCP/IP    | IP packet of version X is dropped                    | I        |
| VLAN      | Type set to port                                     | I        |
| VLAN      | Type set to mac                                      | I        |
| VLAN      | Type set to tag                                      | I        |
| VLAN      | Type set to none                                     | I        |
| VLAN      | Pvlan: port based vlan started                       | I        |
| VLAN      | Pvlan: default vlan is modified                      | I        |
| VLAN      | Tvlan: Tag based vlan started                        | I        |
| VLAN      | pvlan:vlan X enabled                                 | I        |
| VLAN      | pvlan:vlan X disabled                                | I        |
| VLAN      | pvlan:vlan X deleted                                 | I        |
| VLAN      | pvlan:port based VLAN started                        | I        |
| VLAN      | pvlan:port based VLAN stopped                        | I        |
| VLAN      | pvlan:default vlan is modified                       | I        |
| VLAN      | tvlan:vlan X deleted                                 | I        |
| VLAN      | tvlan:vlan X enabled                                 | I        |
| VLAN      | tvlan:vlan X disabled                                | I        |
| VLAN      | tvlan:tag based VLAN stopped                         | I        |
| VLAN      | tvlan:tag based VLAN started                         | I        |

**FIGURE 139** – Listing of severity - sorted by subsystem and severity

Please refer to the related chapters in this manual to find more information. For example, for the VLAN subsystem, refer to the chapter on [VLAN](#).

## MAC Address Table

*Syntax* **show address-table** – displays the MAC addresses associated with ports – shows the MAC addresses on the ports and displays to which port the packet with the specified MAC addresses will be switched to

Sometimes it is useful to see which port a specific packet will be switched to by examining the internal MAC address table. The **'show address-table'** command displays the internal switching table.

```
Magnum6K25# show address-table
```

| Sl# | MAC Address       | Port |
|-----|-------------------|------|
| 1   | 01:00:5e:00:00:fb | 0    |
| 2   | 00:0c:f1:b9:d1:dc | 3    |
| 3   | 33:33:00:00:00:02 | 0    |
| 4   | 01:00:0c:cc:cc:cc | 0    |
| 5   | 01:00:5e:00:00:16 | 0    |
| 6   | 00:07:50:ef:31:40 | 3    |
| 7   | 00:e0:81:52:85:96 | 3    |
| 8   | 01:40:96:ff:ff:ff | 0    |
| 9   | 01:40:96:ff:ff:00 | 0    |
| 10  | 00:40:96:33:51:81 | 3    |

```
Magnum6K25#
```

**FIGURE 140** – *Display of the internal switching decision table*

Where Sl# is the sequential listing form the memory and is just a sequence of the data as it appears in the memory. Port is the port number which the MAC address is assigned to. For example, if the packet with MAC address 00:0c:F1:B9:D1:DC (#2 above) appears with this MAC address in the DST field, the packet will be sent to port number 3. Also notice that there are other MAC addresses associated with port #3, indicating that the port has a hub or a switch connected to it.

## List of commands in this chapter

*Syntax* **alarm** – *enter the alarm configuration mode*

*Syntax* **add event=<event-id | list | range | all>** - *enables alarm action in response to the specified event ID*

*Syntax* **period time=<1..10>** - *sets the duration of relay action for the momentary type signal. This may be needed to adjust to the behavior of the circuit or relay. Default is 3 seconds. Time is in seconds*

*Syntax* **del event=<event-id | list | range | all>** - *disables alarm action in response to the specified event ID*

*Syntax* **alarm <enable | disable>** - *globally enables or disables the alarm action*

*Syntax* **show alarm** - *displays the current status of Alarm system*

*Syntax* **smtp** – *configure the SNMP alerts to be sent via email*

*Syntax* **show smtp <config|recipients>** - **config** – displays the current SMTP global settings and **recipients** displays the currently configured recipients of email alerts

*Syntax* **add id=<1-5> email=<email-addr> [traps=<all|none|S|R|E>]  
[events=<all|none|I|A|C|F|D>] [ip=<ip-addr>] [port=<1-65535>]**

**id** – [mandatory] the recipient ID - range from 1 to 5. MNS-6K allows a maximum of 5 recipients

**email** – [mandatory] email address of the recipient

**traps** – [optional] this is the trap filter. If value is “all”, all traps of any type will be sent to this recipient. If value is none, no traps are sent to this recipient. Value can also be a combination of ‘S’ (SNMP), ‘R’ (RMON) and ‘E’ (ENTERPRISE). For example, trap=SR means that SNMP and RMON traps will be sent via email to the recipient. If this option is not defined, the recipient will have a default value of “all”

**events** – [optional] this is the event filter. Value can be “all” - all event severity types will be sent to recipient, “none” - no event will be sent to recipient or a combination of ‘I’ (informational), ‘A’ (activity), ‘C’ (critical), ‘F’ (fatal) and ‘D’ (debug). With “**event=ACF**” implies that events of severity types activity, critical and fatal will be sent to recipients by email. If this option is not defined, a value of “all” is taken

**ip** – [optional] SMTP server IP address. This is the SMTP server to connect to for this particular user. If this option is not defined, the global/default SMTP server is used

**port** – [optional] TCP port of the SMTP server. If this is not defined, the global default TCP port is used

*Syntax* **delete id=<1-5>** - delete the specific id specified. The deleted id no longer receives the traps via email. The id is added using the “add” command

*Syntax* **sendmail server=<ip-addr> to=<email-addr> from=<email-addr>  
subject=<string> body=<string>** - customize (and also to send a test email to check SMTP settings) the email sent out by specifying the email subject field, server address, to field and the body of the text. See example for the body of the text message later in this chapter

**server** – [mandatory] SMTP server IP v4 address.

**to** – [mandatory] the recipient email address

**from** – [mandatory] the sender email address.

**subject** – [mandatory] email subject or title



**body** – [mandatory] email body

*Syntax* **server ip=<ip-addr> [port=<1-65535>] [retry=<0-3>]** – *configure the global SMTP server settings*

**ip** – [mandatory] SMTP server IP address

**port** – [mandatory] TCP port to be used for SMTP communications – default is 25

**retry** – [optional] specifies how many times to retry if an error occurs when sending email. Range from 0 to 3. Default is 0.

*Syntax* **smtp <enable | disable>** - *enables or disables SMTP to send SNMP alerts by email*

*Syntax* **exportlog mode=<serial|tftp|ftp> [<ipaddress>] [file=<name>] [doctype=<raw|html>]** – *facilitates the export of the event log information as a text file or as an HTML file*

*Syntax* **!!** – *repeat the last command*

*Syntax* **!<n>** - *repeat the “n”th command (as indicated by a show history)*

*Syntax* **show history** – *show the last 25 commands executed – if less than 25 commands are executed, only those commands executed are shown*

*Syntax* **<Up-arrow>** - *every time the key is pressed, the last command is printed on the screen but not executed. This allows for editing errors made in typing*

*Syntax* **<Down-arrow>** - *opposite of Up-arrow key*

*Syntax* **show version** – *displays the version of MNS-6K being used*

*Syntax* **set ftp mode=<normal | passive>** - *set the ftp mode of operation*

*Syntax* **show ftp-** *display the current ftp operation mode*

*Syntax* **ping <ipaddress> [count=<1-999>] [timeout=<1-256>]** – *use the ping command to test connectivity*

*Syntax* **set prompt <prompt string>** - *set the prompt for switch. The prompt has predefined variables. These are \$n : System Name; \$c : System Contact; \$l : System Location; \$i : System IP; \$m : System MAC; \$v : Version; \$\$ : \$ Character; \$r : New Line; \$b : Space*

## APPENDIX 1 - Command listing by Chapter

*A rich environment – this Appendix provides a reference to the commands by chapter*

### Chapter 2 – Getting Started

*Syntax* **ipconfig** [ip=<ip-address>] [mask=<subnet-mask>] [dgw=<gateway>] – to set IP address on the switch

*Syntax* **save** – save changes made to the configuration

*Syntax* **reboot** – restart the switch – same effect as physically turning off the power

*Syntax* **show setup** – show setup parameters

*Syntax* **show config** – show setup parameters configured

*Syntax* **enable** <user-name> - changing the privilege level

*Syntax* **add user**=<name> level=<number> - adding a user

*Syntax* **delete user**=<name> - deleting a user

*Syntax* **passwd user**=<name> - changing a password for a user

*Syntax* **chlevel user**=<name> level=<number> - changing the user privilege level

*Syntax* **useraccess user**=<name> service=<telnet|web> <enable|disable>

*Syntax* **help** <command string> - help for a specific command

*Syntax* **command** **<Enter>** - options for a command

*Syntax* **<TAB>** - listing all commands available at the privilege level

*Syntax* **<command string>** **<TAB>** - options for a command

*Syntax* **<first character of the command>** **<TAB>** - listing commands starting with the character

*Syntax* **logout** – logout from the CLI session

## Chapter 3 – IP Address and System Information

*Syntax* **set bootmode type=<dhcp | bootp | manual | auto> [booting=<enable | disable>] [bootcfg=<enable | disable>]** – assign the boot mode for the switch

Where

**<dhcp | bootp | manual | auto>** - where

**dhcp** – look only for DHCP servers on the network for the IP address. Disable bootp or other modes

**bootp** – look only for bootp servers on the network. Disable dhcp or other mode

**manual** – do not set the IP address automatically

**auto** - the switch will first look for a DHCP server. If a DHCP server is not found, it will then look for a BootP server. If that server is not found, the switch will check to see if the switch had a pre-configured IP address. If it did, the switch would be assigned that IP address. If the switch did not have a pre-configured IP address, it would inspect if the IP address 192.168.1.2 with a netmask of 255.255.255.0 is free. If the IP address is free, MNS-6K will assign the switch that IP address. If the address is not free, MNS-6K will poll the network for DHCP server then BootP server then check if the IP address 192.68.1.2 is freed up

**booting=<enable | disable>** - valid with type=bootp only. This option allows the switch to load the image file from the BootP server. This is useful when a new switch is put on a network and the IT policies are set to load only a specific MNS-6Kimage which is supported and tested by IT personnel.

**bootcfg=<enable | disable>** - valid with type=bootp only. This option allows the switch to load the configuration file from the BootP server. This is useful when a new switch is put on a network and the specific configurations are loaded from a centralized BootP server

*Syntax* **telnet <enable | disable>** - enables or disables telnet sessions

*Syntax* **telnet <ipaddress> [port=<port number>]** – telnet from the switch

*Syntax* **set serial** [baud=<rate>] [data=<5 | 6 | 7 | 8>] [parity=<none | odd | even>] [stop=<1 | 1.5 | 2>] [flowctrl=<none | xonxoff>] – sets serial port parameters

*Syntax* **snmp** – enter the snmp configuration mode

*Syntax* **setvar** [sysname | syscontact | syslocation]=<string> - sets the system name, contact and location information

*Syntax* **set timezone GMT**=[+ or -] hour=<0-14> min=<0-59> - sets the timezone

*Syntax* **set date** year=<2001-2035> month=<1-12> day=<1-31> [format=<mmddyyyy | ddmmyyyy | yyyyymmdd>] – sets the date and the format in which the date is displayed

*Syntax* **set time** hour=<0-23> min=<0-59> sec=<0-59> [zone=GMT[+/-]hh:mm] – sets the time (as well as the timezone)

*Syntax* **set timeformat** format=<12 | 24> - sets the display time in the 12/24 hour mode

*Syntax* **set daylight** country=< country name> - sets the daylight saving time

*Syntax* **setsntp** server = <ipaddress> timeout = <1-10> retry = <1-3> - setup the SNTP server

*Syntax* **sync** [hour=<0-24>] [min=<0-59>] – setup the frequency at which the SNTP server is queried

*Syntax* **sntp** [enable | disable] – enables or disables the SNTP services

*Syntax* **saveconf** mode=<serial | tftp | ftp> [<ipaddress>] [file=<name>] – saves the configuration on the network using tftp, ftp or serial protocols

*Syntax* **loadconf** mode=<serial | tftp | ftp> [<ipaddress>] [file=<name>] – loads the previously saved configuration from the network using tftp, ftp or serial protocols

*Syntax* **kill config** [save=module\_name] – resets the system configuration. The module\_name option does not reset the specific module parameters. The modules are system, event, port, bridge, stp, ps, mirror, sntp, vlan, gvrp and snmp

*Syntax* **show session** – display telnet sessions active on the switch

*Syntax* **kill session** id=<session> - kill a specific telnet session

*Syntax* **set ftp** mode=<normal | passive> - set the ftp mode of operation

*Syntax* **show ftp**- display the current ftp operation mode

*Syntax* **ftp** <get | put | list | del> [type=<app | config | oldconf | script | hosts | log>]  
 [host=<hostname>] [ip=<ipaddress>] [file=<filename>] [user=<user>]  
 [pass=<password>] – *upload and download information using ftp command*

Where

<get | put | list | del> - different ftp operations

[type=<app | config | oldconf | script | hosts | log>] – optional type field. This is useful to specify whether a log file or host file is uploaded or downloaded. This can also perform the task of exporting a configuration file or uploading a new image to the switch

[host=<hostname>] [ip=<ipaddress>] [file=<filename>] [user=<user>]  
 [pass=<password>] – parameters associated with ftp server for proper communications with the server

*Syntax* **tftp** <get | put> [type=<app | config | oldconf | script | hosts | log>]  
 [host=<hostname>] [ip=<ipaddress>] [file=<filename>] – *upload and download information using tftp command*

Where

<get | put> - different tftp operations – get a file from the server or put the information on the server

[type=<app | config | oldconf | script | hosts | log>] – optional type field. This is useful to specify whether a log file or host file is uploaded or downloaded. This can also perform the task of exporting a configuration file or uploading a new image to the switch

[host=<hostname>] [ip=<ipaddress>] [file=<filename>] – parameters associated with tftp server for proper communications with the server

*Syntax* **xmodem** <get | put> [type=<app | config | oldconf | script | hosts | log>] – *upload and download information using xmodem command and console connection*

Where

<get | put> - different xmodem file transfer operations – get a file from the server or put the information on the server

[type=<app | config | oldconf | script | hosts | log>] – optional type field. This is useful to specify whether a log file or host file is uploaded or downloaded. This can also perform the task of exporting a configuration file or uploading a new image to the switch

*Syntax* **host** <add|edit|del> name=<host-name> [ip=<ipaddress>] [user=<user>]  
 [pass=<password>] – *create a host entry for accessing host. This is equivalent to creating a host table on many systems. Maximum of 10 such entries are allowed*

*Syntax* **show host** – *displays the host table entries*

*Syntax* **climode** <script|console|show> - set the interactive CLI mode on (console) or off (script). To see the mode – use the show option

*Syntax* **more** <enable|disable|show> - enable or disable the scrolling of lines one page at a time

*Syntax* **configure access** – sets the access parameters (e.g. disable telnet session)

*Syntax* **show ipconfig** – shows IP parameters set

*Syntax* **show console** – reviews console settings

*Syntax* **show serial** – reviews serial settings

*Syntax* **show setup** – reviews system parameters

*Syntax* **show sysconfig** – reviews settable system parameters

*Syntax* **show time** – shows the system time

*Syntax* **show timezone** – shows the system timezone

*Syntax* **show date** – shows the system date

*Syntax* **show uptime** – shows the amount of time the switch has been operational

*Syntax* **show config [module=<module-name>]** – displays the configuration

*Syntax* **show setup** – display the setup, serial number, factory code information and more

## Chapter 4 – IPv6

*Syntax* **ipconfig [ip=<ip-address>] [mask=<subnet-mask>] [dgw=<gateway>] [add | del]** – configure and IPv6 address. The add/delete option can be used to add or delete IPv4/IPv6 addresses

*Syntax* **show ipconfig** – display the IP configuration information – including IPv6 address

*Syntax* **ping6 <IPv6 address>** - pings an IPv6 station

*Syntax* **show ipv6** - displays the IPv6 information

*Syntax* **ftp <IPv6 address>** - ftp to an IPv6 station

*Syntax* **telnet <IPv6 address>** - telnet to an IPv6 station

## Chapter 5 – Access Considerations

*Syntax* **set password** – set or change password

*Syntax* **configure port-security** – sets the port authorization based on MAC addresses

*Syntax* **port-security** – configure port security settings

*Syntax* **allow mac=<address | list | range> port=<num | list | range>** - specify a specific MAC address or MAC address list

*Syntax* **learn port=<number-list> <enable | disable>** - learn MAC addresses connected to the Magnum 6K switch

*Syntax* **show port-security** – display port security settings

*Syntax* **action port=<num | list | range> <none | disable | drop>** - action to perform in case of breach of port security

*Syntax* **signal port=<num | list | range> <none | log | trap | logandtrap>** - port to monitor and signal to send in case of breach of port security

*Syntax* **ps <enable | disable>** - enable or disable port security

*Syntax* **remove mac=<all | address | list | range> port=<num | list | range>** - remove a MAC address entry

*Syntax* **show log [fatal | alert | crit | error | warn | note | info | debug]** – display logs and specific types of logs

*Syntax* **clear log [fatal | alert | crit | error | warn | note | info | debug]** – clear logs or specific type of logs

*Syntax* **set logsize size=<1-1000>** - set the log buffer size

*Syntax* **access** – setup access configuration parameters

*Syntax* **allow ip=<ipaddress> mask=<netmask> service=<name | list>** - allow specific IP address or range of addresses as a trusted host(s)

*Syntax* **deny ip=<ipaddress> mask=<netmask> service=<name | list>** - deny specific IP address or range of IP addresses

*Syntax* **remove ip=<ipaddress> mask=<netmask>** - delete a specific IP address from the access or trusted host list

*Syntax* **removeall** – remove all IP addresses of trusted hosts

*Syntax* **show ip-access** – display all trusted hosts

*Syntax* **clear <history | log [1..5 | informational | activity | critical | fatal | debug] | terminal | arp | portstats | addr>** – clear command to clear various aspects of the MNS-6K information – most notably “clear addr” – clears the addresses learnt or “clear log” to clear the logs (and the type of logs)

## Chapter 6 – Access Using Radius

*Syntax* **auth** configuration mode to configure the 802.1x parameters

*Syntax* **show auth <config | ports>** show the 802.1x configuration or port status

*Syntax* **authserver [ip=<ip-addr>] [udp=<num>] [secret=<string>]** define the RADIUS server – use UDP socket number if the RADIUS authentication is on port other than 1812

*Syntax* **auth <enable | disable>** enables or disables the 802.1x authenticator function on MNS-6K switch

*Syntax* **setport port=<num | list | range> [status=<enable | disable>] [control=<auto | forceauth | forceunauth>] [initialize=<assert | deassert>]** setting the port characteristic for an 802.1x network

*Syntax* **backend port=<num | list | range> supptimeout=<1-240> [servertimeout=<1-240>] [maxreq=<1-10>]** configure parameters for EAP over RADIUS

**port** – [mandatory] – port(s) to be configured

**supptimeout** – [optional] This is the timeout in seconds the authenticator waits for the supplicant to respond back. Default value is 30 seconds. Values can range from 1 to 240 seconds.

**servertimeout** – [optional] This is the timeout in seconds the authenticator waits for the backend RADIUS server to respond back. The default value is 30 seconds. Values can range from 1 to 240 seconds.



**maxreq** – [optional] The maximum number of times the authenticator will retransmit an EAP Request packet to the Supplicant before it times out the authentication session. Its default value is 2. It can be set to any integer value from 1 to 10.

*Syntax* **portaccess port=<num | list | range> [quiet=<0-65535>] [maxreauth=<0-10>] [transmit=<1-65535>]** *set port access parameters for authenticating PCs or supplicants*

**port** – [mandatory] – ports to be configured

**quiet** – [optional] This is the quiet period, the amount of time, in seconds, the supplicant is held after an authentication failure before the authenticator retries the supplicant for connection. The default value is 60 seconds. Values can range from 0 to 65535 seconds.

**maxreauth** – [optional] The number of re-authentication attempts that are permitted before the port becomes unauthorized. Default value is 2. Values are integers and can range from 0 to 10.

**transmit** – [optional] This is the transmit period, this is the time in seconds the authenticator waits to transmit another request for identification from the supplicant. Default value is 30. Values can be from 1 to 65535 seconds

*Syntax* **reauth port=<num | list | range> [status=<enable | disable>] [period=<10-86400>]** *set values on how the authenticator (Magnum 6K switch) does the re-authentication with the supplicant or PC*

**port** – [mandatory] – ports to be configured

**status** – [optional] This enables/disables re-authentication

**period** – [optional] this is the re-authentication period in seconds. This is the time the authenticator waits before a re-authentication process will be done again to the supplicant. Default value is 3600 seconds (1 hour). Values can range from 10 to 86400 seconds.

*Syntax* **show-stats port=<num>** *displays 802.1x related statistics*

*Syntax* **trigger-reauth port=<num | list | range>** *manually initiate a re-authentication of supplicant*

## Chapter 7 – Access using TACACS+

*Syntax* **show tacplus <status | servers>** *show status of TACACS or servers configured as TACACS+ servers*

*Syntax* **tacplus <enable | disable> [ order=<tac,local | local,tac>]** *enable or disable TACACS authentication, specifying the order in which the server or local database is looked up where “tac,local” implies, first the TACAS+ server, then local logins on the device*

*Syntax* **tacserver** <add | delete> id=<num> [ip=<ip-addr>] [port=<tcp-port>] [encrypt=<enable | disable>] [key=<string>] [mgrlevel=<level>] [oprlevel=<level>] – adds a list of up to five TACACS+ servers where

<add | delete> – [mandatory] adds or delete a TACACS+ server.

id=<num> – [mandatory] the order in which the TACACS+ servers should be polled for authentication

[ip=<ip-addr>] – [mandatory for add] the IP address of the TACACS+ server

[port=<tcp-port>] – [optional for add] TCP port number on which the server is listening

[encrypt=<enable | disable>] – [optional for add] enable or disable packet encryption

[key=<string>] – [optional for add, mandatory with encrypt] when encryption is enabled, the secret shared key string must be supplied

[mgrlevel=<level>] and [oprlevel=<level>] – [optional] specifies the manager and operator level as defined on the TACACS+ server for the respective level of login

## Chapter 8 – Port mirroring and setup

*Syntax* **show port-mirror** – display port mirror settings

*Syntax* **port-mirror** <enter> - configure port mirror settings

*Syntax* **setport monitor**=<monitor port number> **sniffer**=<sniffer port number> - set port mirror settings

*Syntax* **prtmr** <enable | disable> - enable or disable port mirror settings

*Syntax* **device** – configure device and port specific settings

*Syntax* **setport port**=<port# | list | range> [name=<name>] [speed=<10 | 100>] [duplex=<half | full>] [auto=<enable | disable>] [flow=<enable | disable>] [bp=<enable | disable>] [status=<enable | disable>] – configure port settings

*Syntax* **show port**[=<Port number>] – display port settings

*Syntax* **flowcontrol xonlimit**=<value> **xofflimit**=<value> - configure flow control buffers

*Syntax* **show flowcontrol** – display flow control buffers

*Syntax* **backpressure rxthreshold**=<value> - configure backpressure buffers

*Syntax* **show backpressure** – display backpressure buffers

*Syntax* **broadcast-protect** <enable | disable> - protect switch from broadcast storms

*Syntax* **rate-threshold** port=<port | list | range> rate=<frames/sec> - change the allowed broadcast rate threshold

## Chapter 9 - VLAN

*Syntax* **set vlan** type=<port | tag | none> defines the VLAN type

*Syntax* **configure vlan** type=port enter the VLAN configuration commands

*Syntax* **vlan** type=port enter the VLAN configuration commands

*Syntax* **add id**=<vlan Id> [name=<vlan name>] port=<number | list | range> [forbid=<number | list | range>] [<mgt | nomgt>] - adding VLAN

*Syntax* **edit id**=<vlan id> [name=<vlan name>] port=<number | list | range> [<mgt | nomgt>] - edit existing VLAN name

*Syntax* **start vlan**=<name | number | list | range> activate the VLAN configuration

*Syntax* **save** save the configuration (including the VLAN configuration)

*Syntax* **show vlan** type=<port | tag> [<id=vlanid>] display specific VLAN information

*Syntax* **set-port** port=<number | list | range> default id=<number> sets the default VLAN id. For Magnum 6K family of switches, the default VLAN id is 1, unless changed using this command

*Syntax* **set-port** port=<number | list | range> filter status=<enable | disable> enables or disables the VLAN filtering function.

*Syntax* **set-port** port=<number | list | range> tagging id=<number> status=<tagged | untagged> defines whether the outgoing packets from a port will be tagged or untagged.

*Syntax* **set-port** port=<number | list | range> join id=<number> adds the specified port(s) to the specified VLAN id

*Syntax* **set-port** port=<number | list | range> leave id=<number> releases a specific port from a VLAN

*Syntax* **show-port** [port=<port | list | range>] shows all parameters related to tag vlan for the list of ports. If the port parameter is omitted, it will display all ports

## Chapter 10 – Spanning Tree Protocol (STP)

*Syntax* **show stp <config|ports >** - regardless of whether STP is enabled or disabled (default) this command lists the switch's full STP configuration, including general settings and port settings

*Syntax* **stp** – STP Configuration mode

*Syntax* **stp <enable | disable>** - Start (Enable) or stop (Disable) STP

*Syntax* **priority [port=<number | list | range>] value=<0-255 | 0-65535>** - specifies the port or switch level priority. When a port(s) are specified the priority is associated with ports and their value is 0-255. If no ports are specified, then the switch (bridge) priority is specified and its value is 0-65535

*Syntax* **cost port=<number | list | range> value=<0-65535>** - cost is specific to a port and the port(s) have to be specified

*Syntax* **port port=<number | list | range> status=<enable | disable>** - specific ports may not need to participate in STP process. These ports typically would be end-stations. If you are not sure – let MNS-6K software make the decisions

*Syntax* **timers forward-delay=<4-30> hello=<1-10> age=<6-40>** - change the STP Forward Delay, Hello timer and Aging timer values

## Chapter 11 – Rapid Spanning Tree Protocol

*Syntax* **set stp type=<stp | rstp>** - Set the switch to support RSTP or change it back to STP. Need to save and reboot the switch after this command

*Syntax* **rstp** – enter the RSTP configuration mode

*Syntax* **rstp <enable | disable>** - enable RSTP – by default, this is disabled and has to be manually activated

*Syntax* **port port=<number | list | range> [status=<enable | disable>] [migration=<enable>] [edge=<enable | disable>] [p2p=<on | off | auto>]** - set the port type for RSTP

*Example* **port port=<number | list | range> p2p= off** - Set the “point-to-point” value to off on all ports that are connected to **shared LAN segments** (i.e. connections to hubs). The default value is auto. P2P ports would typically be end stations or computers on the network

*Example* **port port=<number | list | range> edge=enable** – enable all ports connected to other hubs, bridges and switches as edge ports

*Example* **port port=<number | list | range> migration=enable** – set this for all ports connected to other devices such as hubs, bridges and switches known to support IEEE 802.1d STP services, but cannot support RSTP services

*Syntax* **show active-stp** – status whether STP or RSTP is running

*Syntax* **show stp <config | ports>** - display the RSTP or STP parameters

*Syntax* **forceversion <stp | rstp>** - set the STP or RSTP compatibility mode

*Syntax* **show-forceversion** - the current forced version

*Syntax* **show-timers** - show the values of the timers set for RSTP

*Syntax* **priority [port=<number | list | range>] value=<0-255 | 0-65535>** - specifies the port or switch level priority. When a port(s) are specified the priority is associated with ports and their value is 0-255. If no ports are specified, then the switch (bridge) priority is specified and its value is 0-65535

*Syntax* **cost port=<number | list | range> value=<0-65535>** - cost is specific to a port and the port(s) have to be specified

*Syntax* **port port=<number | list | range> status=<enable | disable>** - specific ports may not need to participate in STP process. These ports typically would be end-stations. If you are not sure – let MNS-6K software make the decisions

*Syntax* **timers forward-delay=<4-30> hello=<1-10> age=<6-40>** - change the STP Forward delay, Hello timer and Aging timer values

## Chapter 12 – RS-Ring, S-Ring and Link-Loss-Learn

*Syntax* **authorize <module> key=<security key>** - activate the S-Ring capabilities. Don't forget to use the “save” command to save the key

*Syntax* **stp** – STP Configuration mode

*Syntax* **stp <enable | disable>** - Start (Enable) or stop (Disable) STP

*Syntax* **set stp type=<stp | rstp>** - set the spanning tree protocol to be IEEE 802.1d or 802.1w (Spanning Tree Protocol or Rapid Spanning Tree Protocol)

*Syntax* **show active-stp** – Display which version of STP is currently active

*Syntax* **show s-ring** – show the status of S-ring status and configuration

*Syntax* **s-ring <enable | disable>** - enable or disable S-ring capabilities

*Syntax* **s-ring learn** – start the learning process to discover the ring and the ports which make up the S-ring

*Syntax* **s-ring add port=<port1,port2>** - define ports which make up the S-ring ports. Note as discussed earlier, you can create multiple s-rings on a switch

*Syntax* **s-ring del port=<port1,port2>** - remove the switch from S-ring topology by eliminating the end ports on the switch

*Syntax* **lll <enable | disable>** - enable or disable LLL on the switch

*Syntax* **lll add port=<port | list | range>** - enable LLL on the list of specified ports

*Syntax* **lll del port=<port | list | range>** - disable LLL on the list of specified ports

*Syntax* **show lll** – display the status of LLL

*Syntax* **rstp** – STP Configuration mode

*Syntax* **rstp <enable | disable>** - Start (Enable) or stop (Disable) STP

*Syntax* **set stp type=<stp | rstp>** - set the spanning tree protocol to be IEEE 802.1d or 802.1w (Rapid Spanning Tree Protocol)

*Syntax* **show active-stp** – Display which version of STP is currently active

*Syntax* **show rs-ring** – show the status of RS-ring status and configuration

*Syntax* **rs-ring <enable | disable>** - enable or disable RS-ring capabilities

*Syntax* **rs-ring add port=<port1,port2>** - define ports which make up the RS-ring ports. Note as discussed earlier, you can create multiple RS-rings on a switch

*Syntax* **rs-ring del port=<port1,port2>** - remove the switch from RS-ring topology by eliminating the end ports on the switch

## Chapter 13 – Dual-Homing

*Syntax* **dualhome** – enter the dual-homing configuration sub-system

*Syntax* **dualhome** <enable | disable> – enable or disable dual-homing

*Syntax* **dualhome add port1=<port#> port2=<port#>** – dual-homing setup similar to that of unmanaged switches such as ESD42

**OR**

*Syntax* **dualhome add primary=<port#> secondary=<port#>** – dual-homing setup as primary-secondary mode

*Syntax* **dualhome del** – Delete the dual-homing setup

*Syntax* **show dualhome** – Display dual-homing status

## Chapter 14 – Link Aggregation Control Protocol (LACP)

*Syntax* **lacp** - enable the LACP configuration module within CLI

*Syntax* **lacp** <enable | disable> - enable or disable LACP

*Syntax* **add port=<number | list | range> [priority=<0-65535>]** – add the specified list of ports to form the logical LACP trunk. Default value for priority is 32768. The lower the value assigned to priority, the higher the priority. The port with the highest priority is the primary port (over which certain types of traffic like IGMP is transmitted)

*Syntax* **del port=<number | list | range>** - delete specified ports from the LACP membership

*Syntax* **edit port=<number | list | range> [priority=<priority>]** - edit the membership of the ports specified. The priority can be from 0 – 65535

*Syntax* **show lacp** – displays the status and other relevant LACP information

## Chapter 15 – Quality of Service

*Syntax* **qos** – enter the QoS configuration mode

*Syntax* **setqos** type=<port | tag | tos | none> port=<port | list | range> [priority=<high | low>] [tos=<0-63 | list | range>][tag=<0-7 | list | range>] - depending on the type of QoS, the corresponding field has to be set. For example, for QoS type tag, the tag levels have to be set, and for QoS type ToS, the ToS levels have to be set. If the priority field is not set, it then defaults to low priority. ToS has 64 levels and the valid values are 0-63 and a tagged packet has 8 levels and the valid values are 0-7.

*Syntax* **set-weight** weight=<0-7> - sets the port priority weight for All the ports. Once the weight is set, all the ports will be the same weight across the switch. The valid value for weight is 0-7

*Syntax* **show-portweight** - display the weight settings on a port

*Syntax* **show qos** [type=<port | tag | tos>] [port=<port | list | range>] – displays the QoS settings

*Syntax* **set-untag** port=<port | list | range> priority=<high | low> tag=<0-7> - The 802.1p user priority assigned to untagged received packets to be transmitted as tagged from the priority queue

## Chapter 16 - IGMP

*Syntax* **igmp** – IGMP configuration mode

*Syntax* **igmp** <enable/disable> - enable or disable IGMP on the switch

*Syntax* **show igmp** – IGMP operation status

*Syntax* **mcast** <enable | disable> - enable or disable unknown multicast streams. The default is enabled

*Syntax* **set igmp mode**= <normal | l2> - set the IGMP mode. Normal is when a L3 device is in the network and is the IGMP root. The IGMP-L2 is used when there is no L3 device in the network

*Syntax* **show-group** – shows the multicast groups

*Syntax* **set-port** port=< port | list | range> mode=<auto | forward | block> - set the port characteristics. Block drops the unregistered multicasts. Forward forwards unregistered multicasts

*Syntax* **show-port** – display the port characteristics for IGMP

*Syntax* **show-router** – displays detected IGMP-enabled router ports

*Syntax* **set-leave** <enable | disable> - enables or disables the switch to immediately process a host sending a leave message rather than wait for the timer to expire

*Syntax* **set-querier** <enable | disable> - enables or disables a switch as IGMP querier



*Syntax* **set-qi interval=<value>** - The IGMP querier router periodically sends general host-query messages. These messages are sent to ask for group membership information. This is sent to the all-system multicast group address, 224.0.0.1. The default value is 125 seconds. The valid range can be from 60 to 127 seconds.

*Syntax* **set-qri interval=<value>** - The query response interval is the maximum amount of time that can elapse between when the querier router sends a host-query message and when it receives a response from a host. The Default value is 10 seconds. The Range can be from 2 to 270 seconds. Restrictions apply to the maximum value because of an internal calculation that is dependent on the value of the Query Interval

*Syntax* **mode=<l2|normal>** - Toggle the IGMP mode from L2 to normal or IGMP-L2

## Chapter 17 - GVRP

*Syntax* **show gvrp** - shows whether GVRP is disabled, along with the current settings for the maximum number of VLANs and the current Primary VLAN

*Syntax* **gvrp <enable|disable>** - enable or disable GVRP

*Syntax* **show-vlan** – list all the VLANs (including dynamic VLANs) on the switch

*Syntax* **set-ports port=<port|list|range> state=<learn|block|disable>** - set the state of the port to learn, block or disable for GVRP. Note the default state is disable

*Syntax* **static vlan=<VID>** - convert a dynamic VLAN to a static VLAN

*Syntax* **set-forbid vlan=<tag vlanid> forbid=<port-number|list|range>** - sets the forbid GVRP capability on the ports specified

*Syntax* **show-forbid** – display the ports with GVRP forbid capabilities

## Chapter 18 – SNMP

*Syntax* **snmp** – enter the SNMP Configuration mode

*Syntax* **snmpv3** – enter the SNMP V3 configuration mode – note enable SNMP V3 by using the “**set snmp**” command which follows

*Syntax* **set snmp type=<v1|all>** - define the version of SNMP to use – the option all supports all versions (v1, v2 and v3) – v1 restricts SNMP to v1 only. By default – SNMP v1 only is enabled

*Syntax* **show active-snmp** – shows the version of SNMP currently in use

*Syntax* **community** [write=<write community>] [read=<read community>] [trap=<trap community>] – set the necessary community strings

*Syntax* **authtraps** <enable | disable> - enables or disables authentication traps generation

*Syntax* **traps** <add | delete> type=<Snmp | Rmon | Snmp,Rmon | Enterprise | Snmp,Enterprise | Rmon,Enterprise | All> ip=<ipaddress> - add v1 traps as well as define the trap receiver

*Syntax* **show snmp** – displays the SNMP configuration information

*Syntax* **mgrip** <add | delete> ip=<IPaddress> - adds or deletes a management station, specified by the IP address, which can query SNMP variables from the switch. This is done to protect the switch from being polled by unauthorized managers. Maximum of five stations allowed.

*Syntax* **setvar** [sysname | syscontact | syslocation]=<string> sets the system name, contact and location. All parameters are optional but a user must supply at least one parameter

*Syntax* **quickcfg** - quick setup for snmpv3 configuration. It automatically configures a default VACM (view-based access control model). This allows any manager station to access the Magnum 6K switch either via SNMP v1, v2c or v3. The community name is “public”. This command is only intended for first time users and values can be changed by administrators who want more strict access

*Syntax* **engineid** string=<string> - Every agent has to have an engineID (name) to be able to respond to SNMPv3 messages. The default engine ID value is “6K\_v3Engine”. This command allows the user to change the engine ID

*Syntax* **authtrap** <enable | disable> - enables or disables authentication traps generation

*Syntax* **show-authtrap** - displays the current value of authentication trap status.

*Syntax* **deftrap** community=<string> - defines the default community string to be used when sending traps. When user does not specify the trap community name when setting a trap station using the “trap” command, the default trap community name is used

*Syntax* **show-deftrap** - displays the current value of default trap

*Syntax* **trap** <add | delete> id=<id> [type=<v1 | v2 | inform>] [host=<host-ip>] [community=<string>] [port=<1-65534>] - define the trap and inform manager stations. The station can receive v1, v2 traps and/or inform notifications. An inform notification is an acknowledgments that a trap has been received. A user can add up to 5 stations.

*Syntax* **show-trap** [id=<id#>]- shows the configured trap stations in tabular format - id is optional and is the number corresponding to the trap entry number in the table

*Syntax* **com2sec** <add | delete> id=<id> [secname=<name>] [source=<source>] [community=<community>] - a part of the View based Access control model (VACM) as defined in RFC 2275. This specifies the mapping from a source/community pair to a security name. On MNS-6K, up to 10 entries can be specified

*Syntax* **group** <add | delete> id=<id> [groupname=<name>] [model=<v1 | v2c | usm>] [com2secid=<com2sec-id>] - a part of the View based Access control model (VACM) as defined in RFC 2275. This command defines the mapping from sec model or a sec name to a group. A sec model is one of v1, v2c, or usm. On MNS-6K, up to 10 entries can be specified

*Syntax* **show-group** [id=<id>] - display all or specific group entries - id is optional and is the number corresponding to the group entry number in the table

*Syntax* **view** <add | delete> id=<id> [viewname=<name>] [type=<included | excluded>] [subtree=<oid>] [mask=<hex-string>] - a part of the View based Access control model (VACM) as defined in RFC 2275. This command defines a manager or group or manager stations what it can access inside the MIB object tree. On MNS-6K, up to 10 entries can be specified

*Syntax* **show-view** [id=<id>] - display all or specific view entries - id is optional and is the number corresponding to the view entry number in the table

*Syntax* **user** <add | delete> id=<id> [username=<name>] [usertype=<readonly | readwrite>] [authpass=<pass-phrase>] [privpass=<pass-phrase>] [level=<noauth | auth | priv>] [subtree=<oid>] for quickly adding or deleting v3 USM based security, this command adds user entries. MNS-6K allows up to 5 users to be added. Right now, the MNS-6K agent only support noauth and auth-md5 for v3 authentication and auth-des for priv authentication

*Syntax* **show-user** [id=<id>] - display all or specific view entries - id is optional and is the number corresponding to the view entry number in the table

*Syntax* **rmon** – enter the RMON configuration mode to setup RMON groups and communities

*Syntax* **history** def-owner=<string> def-comm=<string> - define the RMON history group and the community string associated with the group

*Syntax* **statistics** def-owner=<string> def-comm=<string>- define the RMON statistics group and the community string associated with the group

*Syntax* **alarm** def-owner=<string> def-comm=<string> - define the RMON alarm group and the community string associated with the group

*Syntax* **event** def-owner=<string> def-comm=<string> - define the RMON event group and the community string associated with the group

*Syntax* **show rmon** <stats|hist|event|alarm> - list the specific RMON data as defined by the group type

## Chapter 19 – Miscellaneous Commands

*Syntax* **alarm** – enter the alarm configuration mode

*Syntax* **add event**=<event-id|list|range|all> - enables alarm action in response to the specified event ID

*Syntax* **period time**=<1..10> - sets the duration of relay action for the momentary type signal. This may be needed to adjust to the behavior of the circuit or relay. Default is 3 seconds. Time is in seconds

*Syntax* **del event**=<event-id|list|range|all> - disables alarm action in response to the specified event ID

*Syntax* **alarm** <enable|disable> - globally enables or disables the alarm action

*Syntax* **show alarm** - displays the current status of Alarm system

*Syntax* **smtp** – configure the SNMP alerts to be sent via email

*Syntax* **show smtp** <config|recipients> - **config** – displays the current SMTP global settings and **recipients** displays the currently configured recipients of email alerts

*Syntax* **add id**=<1-5> **email**=<email-addr> [**traps**=<all|none|S|R|E>] [**events**=<all|none|I|A|C|F|D>] [**ip**=<ip-addr>] [**port**=<1-65535>]

**id** – [mandatory] the recipient ID - range from 1 to 5. MNS-6K allows a maximum of 5 recipients

**email** – [mandatory] email address of the recipient

**traps** – [optional] this is the trap filter. If value is “all”, all traps of any type will be sent to this recipient. If value is none, no traps are sent to this recipient. Value can also be a combination of ‘S’ (SNMP), ‘R’ (RMON) and ‘E’ (ENTERPRISE). For example, trap=SR means that SNMP and RMON traps will be sent via email to the recipient. If this option is not defined, the recipient will have a default value of “all”

**events** – [optional] this is the event filter. Value can be “all” - all event severity types will be sent to recipient, “none” - no event will be sent to recipient or a combination of ‘I’ (informational), ‘A’ (activity), ‘C’ (critical), ‘F’ (fatal) and ‘D’ (debug). With

“**event=ACF**” implies that events of severity types activity, critical and fatal will be sent to recipients by email. If this option is not defined, a value of “all” is taken

**ip** – [optional] SMTP server IP address. This is the SMTP server to connect to for this particular user. If this option is not defined, the global/default SMTP server is used

**port** – [optional] TCP port of the SMTP server. If this is not defined, the global default TCP port is used

*Syntax* **delete id=<1-5>** - delete the specific id specified. The deleted id no longer receives the traps via email. The id is added using the “add” command

*Syntax* **sendmail server=<ip-addr> to=<email-addr> from=<email-addr> subject=<string> body=<string>** - customize (and also to send a test email to check SMTP settings) the email sent out by specifying the email subject field, server address, to field and the body of the text. See example for the body of the text message later in this chapter

**server** – [mandatory] SMTP server IP v4 address.

**to** – [mandatory] the recipient email address

**from** – [mandatory] the sender email address.

**subject** – [mandatory] email subject or title

**body** – [mandatory] email body

*Syntax* **server ip=<ip-addr> [port=<1-65535>] [retry=<0-3>]** – configure the global SMTP server settings

**ip** – [mandatory] SMTP server IP address

**port** – [mandatory] TCP port to be used for SMTP communications – default is 25

**retry** – [optional] specifies how many times to retry if an error occurs when sending email. Range from 0 to 3. Default is 0.

*Syntax* **smtp <enable | disable>** - enables or disables SMTP to send SNMP alerts by email

*Syntax* **exportlog mode=<serial|tftp|ftp> [<ipaddress>] [file=<name>] [doctype=<raw|html>]** – facilitates the export of the event log information as a text file or as an HTML file

*Syntax* **!!** – repeat the last command

*Syntax* **!**<n>** - repeat the “n”th command (as indicated by a show history)**

*Syntax* **show history** – show the last 25 commands executed – if less than 25 commands are executed, only those commands executed are shown

*Syntax* **<Up-arrow>** - every time the key is pressed, the last command is printed on the screen but not executed. This allows for editing errors made in typing

*Syntax* **<Down-arrow>** - opposite of Up-arrow key

*Syntax* **set ftp mode=<normal | passive>** - set the ftp mode of operation

*Syntax* **show ftp**- display the current ftp operation mode

*Syntax* **show version** – displays the version of MNS-6K being used

*Syntax* **ping <ipaddress> [count=<1-999>] [timeout=<1-256>]** – use the ping command to test connectivity

*Syntax* **set prompt <prompt string>** - set the prompt for switch. The prompt has predefined variables. These are \$n : System Name; \$c : System Contact; \$l : System Location; \$i : System IP; \$m : System MAC; \$v : Version; \$\$ : \$ Character; \$r : New Line; \$b : Space

## APPENDIX 2 - Commands sorted alphabetically

| Command   | Description   |
|---|---|
| !!  | <i>repeat the last command</i>  |
| ! <b>&lt;n&gt;</b>  | <i>repeat the “n”th command (as indicated by a show history)</i>  |
| <b>&lt;command string&gt; &lt;TAB&gt;</b>   | <i>options for a command</i>  |
| <b>&lt;Down-arrow&gt;</b>   | <i>opposite of Up-arrow key</i>   |
| <b>&lt;first character of the command&gt;<br/>&lt;TAB&gt;</b>   | <i>listing commands starting with the character</i>   |
| <b>&lt;TAB&gt;</b>  | <i>listing all commands available at the privilege level</i>  |
| <b>&lt;Up-arrow&gt;</b>   | <i>every time the key is pressed, the last command is printed on the screen but not executed. This allows for editing errors made in typing</i> |
| <b>access</b>   | <i>setup access configuration parameters</i>  |
| <b>action port=&lt;num   list   range&gt;<br/>&lt;none   disable   drop&gt;</b>   | <i>action to perform in case of breach of port security</i>   |
| <b>add event=&lt;event-id   list   range   all&gt;</b>  | <i>enables alarm action in response to the specified event ID</i>   |
| <b>add id=&lt;1-5&gt; email=&lt;email-addr&gt;<br/>[traps=&lt;all   none   S   R   E&gt;]<br/>[events=&lt;all   none   I   A   C   F   D&gt;]<br/>[ip=&lt;ip-addr&gt;] [port=&lt;1-65535&gt;]</b> | <i>setup email id for receiving SNMP trap information by email</i>  |
| <b>add id=&lt;vlan Id&gt; [name=&lt;vlan name&gt;]<br/>port=&lt;number   list   range&gt;<br/>[forbid=&lt;number   list   range&gt;]<br/>[&lt;mgt   nomgt&gt;]</b>                                | <i>adding VLAN</i>  |
| <b>add user=&lt;name&gt; level=&lt;number&gt;</b>   | <i>adding a user</i>  |

| Command   | Description   |
|---|---|
| <b>add port=&lt;number   list   range&gt;<br/>[priority=&lt;0-65535&gt;]</b>  | <i>add the specified list of ports to form the logical LACP trunk. Default value for priority is 32768. The lower the value assigned to priority, the higher the priority. The port with the highest priority is the primary port (over which certain types of traffic like IGMP is transmitted). Requires the lacp command (module).</i> |
| <b>alarm</b>  | <i>enter the alarm configuration mode</i>   |
| <b>alarm &lt;enable   disable&gt;</b>   | <i>globally enables or disables the alarm action</i>  |
| <b>alarm def-owner=&lt;string&gt; def-comm=&lt;string&gt;</b>   | <i>define the RMON alarm group and the community string associated with the group</i>   |
| <b>allow ip=&lt;ipaddress&gt;<br/>mask=&lt;netmask&gt; service=&lt;name   list&gt;</b>  | <i>allow specific IP address or range of addresses as a trusted host(s)</i>   |
| <b>allow mac=&lt;address   list   range&gt;<br/>port=&lt;num   list   range&gt;</b>   | <i>specify a specific MAC address or MAC address list</i>   |
| <b>auth</b>   | <i>configuration mode to configure the 802.1x parameters</i>  |
| <b>auth &lt;enable   disable&gt;</b>  | <i>enables or disables the 802.1x authenticator function on MNS-6K switch</i>   |
| <b>authorize &lt;module&gt; key=&lt;security key&gt;</b>  | <i>activate the S-Ring capabilities. Don't forget to use the "save" command to save the key</i>   |
| <b>authserver [ip=&lt;ip-addr&gt;]<br/>[udp=&lt;num&gt;] [secret=&lt;string&gt;]</b>  | <i>define the RADIUS server</i>   |
| <b>authtraps &lt;enable   disable&gt;</b>   | <i>enables or disables authentication traps generation</i>  |
| <b>backend port=&lt;num   list   range&gt;<br/>supptimeout=&lt;1-240&gt;]<br/>[servertimeout=&lt;1-240&gt;] [maxreq=&lt;1-10&gt;]</b> | <i>configure parameters for EAP over RADIUS</i>   |
| <b>backpressure rxthreshold=&lt;value&gt;</b>   | <i>configure backpressure buffers</i>   |
| <b>broadcast-protect &lt;enable   disable&gt;</b>   | <i>protect switch from broadcast storms</i>   |
| <b>chlevel user=&lt;name&gt; level=&lt;number&gt;</b>   | <i>changing the user privilege level</i>  |



| Command   | Description   |
|---|---|
| <b>clear</b> <history   log [1..5   informational   activity   critical   fatal   debug]   terminal   arp   portstats   addr] | <i>clear command to clear various aspects of the MNS-6K information – most notably “clear addr” – clears the addresses learnt or “clear log” to clear the logs (and the type of logs)</i>                                   |
| <b>clear log</b><br>[fatal   alert   crit   error   warn   note   info   debug]   | <i>clear logs or specific type of logs</i>  |
| <b>climode</b> <script console show>  | <i>set the interactive CLI mode on (console) or off (script). To see the mode – use the show option</i>   |
| <b>com2sec</b> <add   delete> id=<id><br>[secname=<name>] [source=<source>]<br>[community=<community>]                        | <i>a part of the View based Access control model (VACM) as defined in RFC 2275. This specifies the mapping from a source/ community pair to a security name. On MNS-6K, up to 10 entries can be specified</i>               |
| <b>command</b> <Enter>  | <i>options for a command</i>  |
| <b>community</b> [write=<write community>]<br>[read=<read community>] [trap=<trap community>]                                 | <i>set the necessary community strings</i>  |
| <b>configure access</b>   | <i>sets the access parameters e.g. disable telnet session</i>   |
| <b>cost port</b> =<number   list   range><br>value=<0-65535>  | <i>cost is specific to a port and the port(s) have to be specified</i>  |
| <b>configure port-security</b>  | <i>sets the port authorization based on MAC addresses</i>   |
| <b>configure vlan type</b> =port  | <i>enter the VLAN configuration commands</i>  |
| <b>cost port</b> =<number   list   range><br>value=<0-65535>  | <i>cost is specific to a port and the port(s) have to be specified</i>  |
| <b>deftrap community</b> =<string>  | <i>defines the default community string to be used when sending traps. When user does not specify the trap community name when setting a trap station using the “trap” command, the default trap community name is used</i> |

| Command   | Description   |
|---|---|
| <b>del event=&lt;event-id   list   range   all&gt;</b>  | <i>disables alarm action in response to the specified event ID</i>  |
| <b>del port=&lt;number   list   range&gt;</b>   | <i>delete specified ports from the LACP membership. Requires the lacp module.</i>   |
| <b>delete id=&lt;1-5&gt;</b>  | <i>delete the specific id specified. The deleted id no longer receives the traps via email. The id is added using the “add” command</i> |
| <b>delete user=&lt;name&gt;</b>   | <i>deleting a user</i>  |
| <b>deny ip=&lt;ipaddress&gt;<br/>mask=&lt;netmask&gt; service=&lt;name   list&gt;</b>   | <i>deny specific IP address or range of IP addresses</i>  |
| <b>device</b>   | <i>configure device and port specific settings</i>  |
| <b>dualhome</b>   | <i>enter the dual-homing configuration sub-system</i>   |
| <b>dualhome &lt;enable   disable&gt;</b>  | <i>enable or disable dual-homing</i>  |
| <b>dualhome add port1=&lt;port#&gt;<br/>port2=&lt;port#&gt;<br/>OR<br/>dualhome add primary=&lt;port#&gt;<br/>secondary=&lt;port#&gt;</b> | <i>dual-homing setup similar to that of unmanaged switches such as ESD42<br/><br/>dual-homing setup as primary-secondary mode</i>       |
| <b>dualhome del</b>   | <i>Delete the dual-homing setup</i>   |
| <b>edit id=&lt;vlan id&gt; [name=&lt;vlan name&gt;]<br/>port=&lt;number   list   range&gt;<br/>[&lt;mgt   nomgt&gt;]</b>                  | <i>edit existing VLAN name</i>  |
| <b>edit port=&lt;number   list   range&gt;<br/>[priority=&lt;priority&gt;]</b>  | <i>edit the membership of the ports specified for LACP ports. The priority can be from 0 – 6553. Requires LACP module.</i>              |

| Command   | Description  |
|---|--|
| <b>enable &lt;user-name&gt;</b>   | <i>changing the privilege level</i>  |
| <b>engineid string=&lt;string&gt;</b>   | <i>Every agent has to have an engineID (name) to be able to respond to SNMPv3 messages. The default engine ID value is "6K_v3Engine". This command allows the user to change the engine ID</i> |
| <b>event def-owner=&lt;string&gt; def-comm=&lt;string&gt;</b>   | <i>define the RMON event group and the community string associated with the group</i>  |
| <b>exportlog mode=&lt;serial ftp ftp&gt; [ &lt;ipaddress&gt; ] [ file=&lt;name&gt; ] [ doctype=&lt;raw html&gt; ]</b>   | <i>facilitates the export of the event log information as a text file or as an HTML file</i>   |
| <b>flowcontrol xonlimit=&lt;value&gt; xofflimit=&lt;value&gt;</b>   | <i>configure flow control buffers</i>  |
| <b>forceversion &lt;stp   rstp&gt;</b>  | <i>set the STP or RSTP compatibility mode</i>  |
| <b>ftp &lt;get   put   list   del&gt; [ type=&lt;app   config   oldconf   script   hosts   log&gt; ] [ host=&lt;hostname&gt; ] [ ip=&lt;ipaddress&gt; ] [ file=&lt;filename&gt; ] [ user=&lt;user&gt; ] [ pass=&lt;password&gt; ] -</b><br><br><i>where</i><br><b>&lt;get   put   list   del&gt;</b> - different ftp operations<br><b>[ type=&lt;app   config   oldconf   script   hosts   log&gt; ]</b> - optional type field. This is useful to specify whether a log file or host file is uploaded or downloaded. This can also perform the task of exporting a configuration file or uploading a new image to the switch<br><b>[ host=&lt;hostname&gt; ] [ ip=&lt;ipaddress&gt; ] [ file=&lt;filename&gt; ] [ user=&lt;user&gt; ] [ pass=&lt;password&gt; ]</b> - parameters associated with ftp server for proper communications with the server | <i>upload and download information using ftp command. The IP address can be a IPv4 address or an IPv6 address</i>  |

| Command   | Description   |
|---|---|
| <b>group</b> <add   delete> id=<id><br>[groupname=<name>]<br>[model=<v1   v2c   usm>]<br>[com2secid=<com2sec-id>] | <i>a part of the View based Access control model (VACM) as defined in RFC 2275. This command defines the mapping from sec model or a sec name to a group. A sec model is one of v1, v2c, or usm. On MNS-6K, up to 10 entries can be specified</i> |
| <b>gvrp</b> <enable   disable>  | <i>enable or disable GVRP</i>   |
| <b>host</b> <add edit del> name=<host-name><br>[ip=<ipaddress>] [user=<user>]<br>[pass=<password>]                | <i>create a host entry for accessing host. This is equivalent to creating a host table on many systems. Maximum of 10 such entries are allowed</i>  |
| <b>help</b> <command string>  | <i>help for a specific command</i>  |
| <b>history</b> def-owner=<string> def-comm=<string>   | <i>define the RMON history group and the community string associated with the group</i>   |
| <b>igmp</b>   | <i>IGMP configuration mode</i>  |
| <b>igmp</b> <enable / disable>  | <i>enable or disable IGMP on the switch</i>   |
| <b>ipconfig</b> [ip=<ip-address>]<br>[mask=<subnet-mask>]<br>[dgw=<gateway>]                                      | <i>to set IP address on the switch</i>  |
| <b>kill config</b> [save=system]  | <i>resets the system configuration. The module_name option does not reset the specific module parameters. The modules are system, event, port, bridge, stp, ps, mirror, snmp, vlan, gvrp and snmp</i>   |
| <b>kill session</b> id=<session>  | <i>terminate a telnet session. See also "show session"</i>  |
| <b>lACP</b>   | <i>enable the LACP configuration module within CLI</i>  |
| <b>lACP</b> <enable   disable>  | <i>enable or disable LACP</i>   |
| <b>learn</b> port=<number-list><br><enable   disable>   | <i>learn MAC addresses connected to the Magnum 6K switch</i>  |

| Command   | Description  |
|---|--|
| <code>lll &lt;enable   disable&gt;</code>   | <i>enable or disable LLL on the switch</i>   |
| <code>lll add port=&lt;port   list   range&gt;</code>   | <i>enable LLL on the list of specified ports</i>   |
| <code>lll del port=&lt;port   list   range&gt;</code>   | <i>disable LLL on the list of specified ports</i>  |
| <code>loadconf mode=&lt;serial   tftp   ftp&gt;<br/>[&lt;ipaddress&gt;] [file=&lt;name&gt;]</code>  | <i>loading the previously saved configuration from the network using tftp, ftp or serial protocols</i>   |
| <code>logout</code>   | <i>logout from the CLI session</i>   |
| <code>mcast &lt;enable   disable&gt;</code>   | <i>enable or disable unknown multicast streams. The default is enabled</i>   |
| <code>mgrip &lt;add   delete&gt; ip=&lt;IPaddress&gt;</code>  | <i>adds or deletes a management station, specified by the IP address, which can query SNMP variables from the switch. This is done to protect the switch from being polled by unauthorized managers. Applicable for SNM v1 only. Maximum of five stations allowed.</i> |
| <code>mode &lt;l2   normal&gt;</code>   | <i>Set the IGMP mode to be IGMP-L2 mode or normal IGMP mode</i>  |
| <code>more &lt;enable disable show&gt;</code>   | <i>enable or disable the scrolling of lines one page at a time</i>   |
| <code>passwd user=&lt;name&gt;</code>   | <i>changing a password for a user</i>  |
| <code>period time=&lt;1..10&gt;</code>  | <i>sets the duration of relay action for the momentary type signal. This may be needed to adjust to the behavior of the circuit or relay. Default is 3 seconds. Time is in seconds</i>   |
| <code>ping &lt;ipaddress&gt; [count=&lt;1-999&gt;]<br/>[timeout=&lt;1-256&gt;]</code>   | <i>use the ping command to test connectivity</i>   |
| <code>ping6 &lt;ipv6-address&gt;</code>   | <i>ping an IPv6 station</i>  |
| <code>port port=&lt;number   list   range&gt;<br/>[status=&lt;enable   disable&gt;]<br/>[migration=&lt;enable&gt;]<br/>[edge=&lt;enable   disable&gt;]<br/>[p2p=&lt;on   off   auto&gt;]</code> | <i>set the port type for RSTP</i>  |
| <code>port port=&lt;number   list   range&gt;<br/>status=&lt;enable   disable&gt;</code>  | <i>specific ports may not need to participate in STP process. These ports typically would be end-stations. If you are not sure - let MNS-6K software make the decisions</i>  |
| <code>portaccess port=&lt;num   list   range&gt;<br/>[quiet=&lt;0-65535&gt;] [maxreauth=&lt;0-10&gt;]<br/>[transmit=&lt;1-65535&gt;]</code>   | <i>set port access parameters for authenticating PCs or supplicants</i>  |

| Command   | Description   |
|---|---|
| port-mirror <enter>   | <i>configure port mirror settings</i>   |
| port-security   | <i>configure port security settings</i>   |
| priority [port=<number   list   range>]<br>value=<0-255   0-65535>                  | <i>specifies the port or switch level priority. When a port(s) are specified the priority is associated with ports and their value is 0-255. If no ports are specified, then the switch (bridge) priority is specified and its value is 0-65535</i>   |
| priority [port=<number   list   range>]<br>value=<0-255   0-65535>                  | <i>specifies the port or switch level priority. When a port(s) are specified the priority is associated with ports and their value is 0-255. If no ports are specified, then the switch (bridge) priority is specified and its value is 0-65535</i>   |
| prtmr <enable   disable>  | <i>enable or disable port mirror settings</i>   |
| ps <enable   disable>   | <i>enable or disable port security</i>  |
| qos   | <i>enter the QoS configuration mode</i>   |
| quickcfg  | <i>quick setup for snmpv3 configuration. It automatically configures a default VACM (view-based access control model). This allows any manager station to access the Magnum 6K switch either via SNMP v1, v2c or v3. The community name is "public". This command is only intended for first time users and values can be changed by administrators who want more strict access</i> |
| rate-threshold port=<port   list   range><br>rate=<frames/sec>                      | <i>change the allowed broadcast rate threshold</i>  |
| reauth port=<num   list   range><br>[status=<enable   disable>] [period=<10-86400>] | <i>set values on how the authenticator (Magnum 6K switch) does the re-authentication with the supplicant or PC</i>  |
| reboot  | <i>restart the switch same effect as physically turning off the power</i>   |
| remove ip=<ipaddress><br>mask=<netmask>   | <i>delete a specific IP address from the access or trusted host list</i>  |
| remove mac=<all   address   list   range><br>port=<num   list   range>              | <i>remove a MAC address entry</i>   |
| removeall   | <i>remove all IP addresses of trusted hosts</i>   |

| Command  | Description  |
|--|--|
| <b>rmon</b>  | <i>enter the RMON configuration mode to setup RMON groups and communities</i>  |
| <b>rs-ring &lt;enable   disable&gt;</b>  | <i>enable or disable RS-Ring capabilities</i>  |
| <b>rs-ring add port=&lt;port1,port2&gt;</b>  | <i>define ports which make up the RS-Ring ports. Note as discussed earlier, you can create multiple RS-rings on a switch</i>   |
| <b>rs-ring del port=&lt;port1,port2&gt;</b>  | <i>remove the switch from RS-Ring topology by eliminating the end ports on the switch</i>  |
| <b>rstp</b>  | <i>enter the RSTP configuration mode</i>   |
| <b>rstp &lt;enable   disable&gt;</b>   | <i>enable RSTP – by default, this is disabled and has to be manually activated</i>   |
| <b>save</b>  | <i>save changes made to the configuration</i>  |
| <b>saveconf mode=&lt;serial   tftp   ftp&gt;<br/>[&lt;ipaddress&gt;] [file=&lt;name&gt;]</b>   | <i>saving the configuration on the network using tftp, ftp or serial protocols</i>   |
| <b>sendmail server=&lt;ip-addr&gt; to=&lt;email-addr&gt; from=&lt;email-addr&gt;<br/>subject=&lt;string&gt; body=&lt;string&gt;</b>              | <i>customize (and also to send a test email to check SMTP settings) the email sent out by specifying the email subject field, server address, to field and the body of the text. See example fo the body of the text message later in this chapter</i> |
| <b>server ip=&lt;ip-addr&gt; [port=&lt;1-65535&gt;]<br/>[retry=&lt;0-3&gt;]</b>  | <i>configure the global SMTP server settings</i>   |
| <b>set bootmode<br/>type=&lt;dhcp   bootp   manual   auto&gt;<br/>[booting=&lt;enable   disable&gt;]<br/>[bootcfg=[&lt;enable   disable&gt;]</b> | <i>assign the boot mode for the switch</i>   |
| <b>set date year=&lt;2001-2035&gt; month=&lt;1-12&gt; day=&lt;1-31&gt;<br/>[format=&lt;mmddyyyy   ddmmyyyy   yyyy mmdd&gt;]</b>                  | <i>sets the date and the format in which the date is displayed</i>   |
| <b>set daylight country=&lt; country name&gt;</b>  | <i>set the daylight saving time</i>  |

| Command  | Description   |
|--|---|
| <b>set ftp mode=&lt;normal   passive&gt;</b>   | set the ftp mode of operation   |
| <b>set igmp mode= &lt;normal   l2&gt;</b>  | <i>set the IGMP mode. Normal is when a L3 device is in the network and is the IGMP root. The IGMP-L2 is used when there is no L3 device in the network</i>  |
| <b>set logsize size=&lt;1-1000&gt;</b>   | <i>set the log buffer size</i>  |
| <b>set password</b>  | <i>set or change password</i>   |
| <b>set prompt &lt;prompt string&gt;</b>  | <i>set the prompt for switch. The prompt has predefined variables. These are \$n : System Name; \$c : System Contact; \$l : System Location; \$i : System IP; \$m : System MAC; \$v : Version; \$\$ : \$ Character; \$r : New Line; \$b : Space</i> |
| <b>set serial [baud=&lt;rate&gt;]<br/>[data=&lt;5   6   7   8&gt;]<br/>[parity=&lt;none   odd   even&gt;]<br/>[stop=&lt;1   1.5   2&gt;]<br/>[flowctrl=&lt;none   xonxoff&gt;]</b> | <i>set serial port parameters</i>   |
| <b>set snmp type=&lt;v1   all&gt;</b>  | <i>define the version of SNMP to use – the option all supports all versions (v1, v2 and v3) – v1 restricts SNMP to v1 only. By default – SNMP v1 only is enabled</i>  |
| <b>set stp type=&lt;stp   rstp&gt;</b>   | <i>Set the switch to support RSTP or change it back to STP. Need to save and reboot the switch after this command</i>   |
| <b>set time hour=&lt;0-23&gt; min=&lt;0-59&gt;<br/>sec=&lt;0-59&gt; [zone=GMT[+/-]hh:mm]</b>   | <i>sets the time (as well as the timezone)</i>  |
| <b>set timeformat format=&lt;12   24&gt;</b>   | <i>set the display time in the 12/24 hour mode</i>  |
| <b>set timezone GMT=[+ or -] hour=&lt;0-14&gt; min=&lt;0-59&gt;</b>  | <i>sets the timezone</i>  |



| Command  | Description  |
|--|--|
| <b>set vlan type=&lt;port   tag   none&gt;</b>   | <i>defines the VLAN type</i>   |
| <b>set-forbid       vlan=&lt;tag        vlanid&gt;</b><br><b>forbid=&lt;port-number   list   range&gt;</b>                               | <i>sets the forbid GVRP capability on the ports specified</i>  |
| <b>set-leave &lt;enable   disable&gt;</b>  | <i>enables or disables the switch to immediately process a host sending a leave message rather than wait for the timer to expire</i> |
| <b>setport monitor=&lt;monitor port number&gt;</b><br><b>sniffer=&lt;sniffer port number&gt;</b>   | <i>set port mirror settings</i>  |
| <b>set-port port=&lt; port   list   range&gt;</b><br><b>mode=&lt;auto   forward   block&gt;</b>  | <i>set the port characteristics for IGMP. Block drops the unregistered multicasts. Forward forwards unregistered multicasts</i>      |
| <b>set-port        port=&lt;number   list   range&gt;</b><br><b>default id=&lt;number&gt;</b>  | <i>sets the default VLAN id. For Magnum 6K family of switches, the default VLAN id is 1, unless changed using this command</i>       |
| <b>set-port        port=&lt;number   list   range&gt;</b><br><b>filter status=&lt;enable   disable&gt;</b>                               | <i>enables or disables the VLAN filtering function.</i>  |
| <b>set-port port=&lt;number   list   range&gt; join</b><br><b>id=&lt;number&gt;</b>  | <i>adds the specified port(s) to the specified VLAN id</i>   |
| <b>set-port        port=&lt;number   list   range&gt;</b><br><b>leave id=&lt;number&gt;</b>  | <i>releases a specific port from a VLAN</i>  |
| <b>set-port        port=&lt;number   list   range&gt;</b><br><b>tagging id=&lt;number&gt; status=&lt;tagged  </b><br><b>untagged&gt;</b> | <i>defines whether the outgoing packets from a port will be tagged or untagged.</i>  |

| Command  | Description   |
|--|---|
| <b>setport port=&lt;num   list   range&gt;</b><br><b>[status=&lt;enable   disable&gt;]</b><br><b>[control=&lt;auto   forceauth   forceunauth&gt;</b><br><b>] [initialize=&lt;assert   deassert&gt;]</b>  | <i>setting the port characteristic for an 802.1x network</i>  |
| <b>setport port=&lt;port#   list   range&gt;</b><br><b>[name=&lt;name&gt;] [speed=&lt;10   100&gt;]</b><br><b>[duplex=&lt;half   full&gt;]</b><br><b>[auto=&lt;enable   disable&gt;]</b><br><b>[flow=&lt;enable   disable&gt;]</b><br><b>[bp=&lt;enable   disable&gt;]</b><br><b>[status=&lt;enable   disable&gt;]</b>   | <i>configure port settings</i>  |
| <b>set-ports port=&lt;port   list   range&gt;</b><br><b>state=&lt;learn   block   disable&gt;</b>  | <i>set the state of the port to learn, block or disable for GVRP. Note the default state is disable</i> |
| <b>set prompt &lt;prompt string&gt;</b><br><br>The length of the prompt is limited to 60 characters. The predefined variables are<br><b>\$n</b> : System Name<br><b>\$c</b> : System Contact<br><b>\$l</b> : System Location<br><b>\$i</b> : System IP<br><b>\$m</b> : System MAC<br><b>\$v</b> : Version<br><b>\$\$</b> : \$ Character<br><b>\$r</b> : New Line<br><b>\$b</b> : Space | <i>Set the prompt string</i>  |

| Command   | Description  |
|---|--|
| set-qi interval=<value>   | <i>The IGMP querier router periodically sends general host-query messages. These messages are sent to ask for group membership information. This is sent to the all-system multicast group address, 224.0.0.1. The default value is 125 seconds. The valid range can be from 60 to 127 seconds.</i>  |
| set qos type=<port   tag   tos   none><br>port=<port   list   range><br>[priority=<high   low>] [tos=<0-63   list   range>][tag=<0-7   list   range>] | <i>depending on the type of QOS, the corresponding field has to be set. For example, for QOS type tag, the tag levels have to be set, and for QOS type ToS, the ToS levels have to be set. If the priority field is not set, it then defaults to low priority. ToS has 64 levels and the valid values are 0-63 and a tagged packet has 8 levels and the valid values are 0-7.</i>                  |
| set-qri interval=<value>  | <i>The query response interval is the maximum amount of time that can elapse between when the querier router sends a host-query message and when it receives a response from a host. The Default value is 10 seconds. The Range can be from 2 to 270 seconds. Restrictions apply to the maximum value because of an internal calculation that is dependent on the value of the Query Interval.</i> |
| set-querier <enable   disable>  | <i>enables or disables a switch as IGMP querier</i>  |
| setsntp server = <ipaddress> timeout = <1-10> retry = <1-3>   | <i>setup the SNTP server</i>   |

| Command  | Description   |
|--|---|
| <b>set-untag</b> port=<port   list   range><br><b>priority</b> =<high   low> <b>tag</b> =<0-7> | The 802.1p user priority assigned to untagged received packets to be transmitted as tagged from the priority queue  |
| <b>setvar</b><br>[sysname   syscontact   syslocation]=<string>                                 | set the system name, contact and location information   |
| <b>setvar</b><br>[sysname   syscontact   syslocation]=<string>                                 | sets the system name, contact and location. All parameters are optional but a user must supply at least one parameter   |
| <b>set-weight</b> weight=<0-7>   | sets the port priority weight for All the ports. Once the weight is set, all the ports will be the same weight across the switch. The valid value for weight is 0-7 |
| <b>show address-table</b>  | displays which mac address is associated with which port for packet switching   |
| <b>show active-stp</b>   | status whether STP or RSTP is running   |
| <b>Show active-snmp</b>  | display the version of SNMP currently in use  |
| <b>show alarm</b>  | displays the current status of Alarm system   |
| <b>show auth</b> <config   ports>  | show the 802.1x configuration or port status  |
| <b>show backpressure</b>   | display backpressure buffers  |
| <b>show config</b>   | show setup parameters configured  |
| <b>show console</b>  | displays the console settings   |
| <b>show date</b>   | displays the date   |
| <b>show dualhome</b>   | Display dual-homing status  |
| <b>show flowcontrol</b>  | display flow control buffers  |
| <b>show ftp</b>  | display the current ftp operation mode  |
| <b>show gvrp</b>   | shows whether GVRP is disabled, along with the current settings for the maximum number of VLANs and the current Primary VLAN  |
| <b>show history</b>  | show the last 25 commands executed – if less than 25 commands are executed, only those commands executed are shown  |

| Command   | Description   |
|---|---|
| show host   | <i>display the hosts table entries</i>  |
| show igmp   | <i>IGMP operation status</i>  |
| show ip-access  | <i>display all trusted hosts</i>  |
| show ipconfig   | <i>shows the IP parameters set in the switch</i>  |
| show lacp   | <i>displays the status and other relevant LACP information</i>  |
| show lll  | <i>display the status of LLL</i>  |
| show log<br>[fatal   alert   crit   error   warn   note   info   debug] | <i>display logs and specific types of logs</i>  |
| show port[=<Port number>]   | <i>display port settings</i>  |
| show port-mirror  | <i>display port mirror settings</i>   |
| show port-security  | <i>display port security settings</i>   |
| show qos [type=<port   tag   tos>]<br>[port=<port   list   range>]      | <i>displays the QoS settings</i>  |
| show rmon <stats   hist   event   alarm>                                | <i>list the specific RMON data as defined by the group type</i>   |
| show rs-ring  | <i>show the status of RS-Ring</i>   |
| show serial   | <i>displays the serial port settings</i>  |
| show session  | <i>Display the current telnet sessions. See also "kill session"</i>   |
| show setup  | <i>displays the system parameters setup on the system</i>   |
| show setup  | <i>show setup parameters</i>  |
| show smtp <config   recipients>   | <i>config – displays the current SMTP global settings and recipients displays the currently configured recipients of email alerts</i> |

| Command  | Description  |
|--|--|
| <b>show snmp</b>   | <i>displays the SNMP configuration information</i>   |
| <b>show s-ring</b>   | <i>show the status of S-Ring</i>   |
| <b>show stp &lt;config   ports &gt;</b>                        | <i>regardless of whether STP is enabled or disabled (default) this command lists the switch's full STP configuration, including general settings and port settings</i> |
| <b>show stp &lt;config   ports&gt;</b>                         | <i>display the RSTP or STP parameters</i>  |
| <b>show sysconfig</b>  | <i>displays the settable system parameters</i>   |
| <b>show tacplus &lt;status   servers&gt;</b>                   | <i>show status of TACACS or servers configured as TACACS+ servers</i>  |
| <b>show time</b>   | <i>displays the system time</i>  |
| <b>show timezone</b>   | <i>displays the timezone information</i>   |
| <b>show uptime</b>   | <i>displays the amount the time elapsed since the last reboot or power failure</i>   |
| <b>show version</b>  | <i>displays the version of MNS-6K being used</i>   |
| <b>show vlan type=&lt;port   tag&gt; [ &lt;id=vlanid&gt; ]</b> | <i>display specific VLAN information</i>   |
| <b>show-authtrap</b>   | <i>displays the current value of authentication trap status</i>  |
| <b>show-deftrap</b>  | <i>displays the current value of default trap</i>  |
| <b>show-forbid</b>   | <i>display the ports with GVRP forbid capabilities</i>   |
| <b>show-forceversion</b>                                       | <i>the current forced version</i>  |
| <b>show-group</b>  | <i>shows the multicast groups</i>  |
| <b>show-group [id=&lt;id&gt;]</b>                              | <i>display all or specific group entries - id is optional and is the number corresponding to the group entry number in the table</i>                                   |
| <b>show-port</b>   | <i>display the port characteristics for IGMP</i>   |
| <b>show-port [port=&lt;port   list   range&gt;]</b>            | <i>shows all parameters related to tag vlan for the list of ports. If the port parameter is omitted, it will display all ports</i>                                     |
| <b>show-portweight</b>   | <i>display the weight settings on a port</i>   |

| Command  | Description  |
|--|--|
| <b>show-router</b>   | <i>displays detected IGMP-enabled router ports</i>   |
| <b>show-stats port=&lt;num&gt;</b>   | <i>displays 802.1x related statistics</i>  |
| <b>show-timers</b>   | <i>show the values of the timers set for RSTP</i>  |
| <b>show-trap [id=&lt;id#&gt;]</b>  | <i>shows the configured trap stations in tabular format - id is optional and is the number corresponding to the trap entry number in the table</i> |
| <b>show-user [id=&lt;id&gt;]</b>   | <i>display all or specific view entries - id is optional and is the number corresponding to the view entry number in the table</i>                 |
| <b>show-view [id=&lt;id&gt;]</b>   | <i>display all or specific view entries - id is optional and is the number corresponding to the view entry number in the table</i>                 |
| <b>show-vlan</b>   | <i>list all the VLANs (including dynamic VLANs) on the switch</i>  |
| <b>signal port=&lt;num   list   range&gt;<br/>&lt;none   log   trap   logandtrap&gt;</b> | <i>port to monitor and signal to send in case of breach of port security</i>   |
| <b>smtp</b>  | <i>configure the SNMP alerts to be sent via email</i>  |
| <b>smtp &lt;enable   disable&gt;</b>   | <i>enables or disables SMTP to send SNMP alerts by email</i>   |
| <b>snmp</b>  | <i>enter the SNMP Configuration mode</i>   |
| <b>snmpv3</b>  | <i>enter the SNMP V3 configuration mode – note enable SNMP V3 by using the “set snmp” command which follows</i>                                    |
| <b>sntp [enable   disable]</b>   | <i>enable or disable the SNTP services</i>   |
| <b>s-ring &lt;enable/disable&gt;</b>   | <i>enable or disable S-ring capabilities</i>   |
| <b>s-ring add port=&lt;port1,port2&gt;</b>   | <i>define ports which make up the s-ring ports. Note as discussed earlier, you can create multiple s-rings on a switch</i>                         |
| <b>s-ring del port=&lt;port1,port2&gt;</b>   | <i>remove the switch from S-ring topology by eliminating the end ports on the switch</i>   |
| <b>s-ring learn</b>  | <i>start the learning process to discover the ring and the ports which make up the s-ring</i>  |

| Command   | Description   |
|---|---|
| <b>start vlan=&lt;name   number   list   range&gt;</b>  | <i>activate the VLAN configuration</i>  |
| <b>static vlan=&lt;VID&gt;</b>  | <i>convert a dynamic VLAN to a static VLAN</i>  |
| <b>statistics def-owner=&lt;string&gt; def-comm=&lt;string&gt;</b>  | <i>define the RMON statistics group and the community string associated with the group</i>  |
| <b>stp</b>  | <i>STP Configuration mode</i>   |
| <b>stp &lt;enable   disable&gt;</b>   | <i>Start (Enable) or stop (Disable) STP</i>   |
| <b>sync [hour=&lt;0-24&gt;] [min=&lt;0-59&gt;]</b>  | <i>setup the frequency at which the SNTP server is queried</i>  |
| <b>tacplus &lt;enable   disable&gt; [ order=&lt;tac,local   local,tac&gt;]</b>  | <i>enable or disable TACACS authentication, specifying the order in which the server or local database is looked up where "tac,local" implies, first the TACACS+ server, then local logins on the device</i>  |
| <b>tacserver &lt;add   delete&gt; id=&lt;num&gt; [ip=&lt;ip-addr&gt;] [port=&lt;tcp-port&gt;] [encrypt=&lt;enable   disable&gt;] [key=&lt;string&gt;] [mgrlevel=&lt;level&gt;] [oprlevel=&lt;level&gt;]</b> | <p><i>adds a list of up to five TACACS+ servers where</i></p> <p><b>&lt;add   delete&gt;</b> – [mandatory] adds or delete a TACACS+ server.</p> <p><b>id=&lt;num&gt;</b> – [mandatory] the order in which the TACACS+ servers should be polled for authentication</p> <p><b>[ip=&lt;ip-addr&gt;]</b> – [mandatory for add] the IP address of the TACACS+ server</p> <p><b>[port=&lt;tcp-port&gt;]</b> – [optional for add] TCP port number on which the server is listening</p> <p><b>[encrypt=&lt;enable   disable&gt;]</b> – [optional for add] enable or disable packet encryption</p> <p><b>[key=&lt;string&gt;]</b> – [optional for add, mandatory with encrypt] when encryption is enabled, the secret shared key string must be supplied</p> <p><b>[mgrlevel=&lt;level&gt;]</b> and <b>[oprlevel=&lt;level&gt;]</b> – [optional] specifies the manager and operator level as defined on the TACACS+ server for the respective level of login</p> |
| <b>telnet &lt;enable   disable&gt;</b>  | <i>enable or disable telnet sessions</i>  |
| <b>telnet &lt;ipaddress&gt; [port=&lt;port number&gt;]</b>  | <i>telnet from the switch. The IP address can be an IPv4 address or an IPv6 address</i>   |



| Command  | Description   |
|--|---|
| <b>timers forward-delay=&lt;4-30&gt; hello=&lt;1-10&gt; age=&lt;6-40&gt;</b>   | <i>change the STP Forward Delay, Hello timer and Aging timer values</i>   |
| <b>tftp &lt;get   put&gt;</b><br><b>[type=&lt;app   config   oldconf   script   hosts   log&gt;] [host=&lt;hostname&gt;]</b><br><b>[ip=&lt;ipaddress&gt;] [file=&lt;filename&gt;]</b><br><br><i>where</i><br><b>&lt;get   put&gt;</b> - different tftp operations – get a file from the server or put the information on the server<br><b>[type=&lt;app   config   oldconf   script   hosts   log&gt;]</b> – optional type field. This is useful to specify whether a log file or host file is uploaded or downloaded. This can also perform the task of exporting a configuration file or uploading a new image to the switch<br><b>[host=&lt;hostname&gt;] [ip=&lt;ipaddress&gt;]</b><br><b>[file=&lt;filename&gt;]</b> – parameters associated with tftp server for proper communications with the server | <i>upload and download information using tftp command</i>   |
| <b>traps &lt;add   delete&gt;</b><br><b>type=&lt;Snmp   Rmon   Snmp,Rmon   Enterprise   Snmp,Enterprise   Rmon,Enterprise   All&gt; ip=&lt;ipaddress&gt;</b>   | <i>add SNMP v1 traps as well as define the trap receiver</i>  |
| <b>trap &lt;add   delete&gt; id=&lt;id&gt;</b><br><b>[type=&lt;v1   v2   inform&gt;] [host=&lt;host-ip&gt;] [community=&lt;string&gt;] [port=&lt;1-65534&gt;]</b>  | <i>define the trap and inform manager stations. The station can receive v1, v2 traps and/or inform notifications. An inform notification is an acknowledgment that a trap has been received. A user can add up to 5 stations.</i> |
| <b>trigger-reauth port=&lt;num   list   range&gt;</b>  | <i>manually initiate a re-authentication of supplicant</i>  |

| Command   | Description   |
|---|---|
| <b>user</b> <add   delete> id=<id><br>[username=<name>]<br>[usertype=<readonly   readwrite>]<br>[authpass=<pass-phrase>]<br>[privpass=<pass-phrase>]<br>[level=<noauth   auth   priv>]<br>[subtree=<oid>]   | <i>for quickly adding or deleting v3 USM based security, this command adds user entries. MNS-6K allows up to 5 users to be added. Right now, the MNS-6K agent only support noauth and auth-md5 for v3 authentication and auth-des for priv authentication</i> |
| <b>useraccess</b> user=<name><br><b>service</b> =<telnet   web> <enable   disable><br><br><i>where</i><br><b>user</b> =<name> specifies the user id<br><b>service</b> =<telnet   web> specifies which service (telnet or web) the user has access to<br><enable   disable> specifies whether the services are allowed or not allowed  | <i>For assigning access capabilities to the user – for example to allow or not allow telnet access to the switch</i>  |
| <b>view</b> <add   delete> id=<id><br>[viewname=<name>]<br>[type=<included   excluded>]<br>[subtree=<oid>] [mask=<hex-string>]  | <i>a part of the View based Access control model (VACM) as defined in RFC 2275. This command defines a manager or group or manager stations what it can access inside the MIB object tree. On MNS-6K, up to 10 entries can be specified</i>                   |
| <b>xmodem</b> <get   put><br>[type=<app   config   oldconf   script   hosts   log>]<br><br><i>where</i><br><get   put> - different xmodem file transfer operations – get a file from the server or put the information on the server<br>[type=<app   config   oldconf   script   hosts   log>] – optional type field. This is useful to specify whether a log file or host file is uploaded or downloaded. This can also perform the task of exporting a configurat | <i>upload and download information using xmodem command and console connection</i>  |
| <b>vlan</b> type=port   | <i>enter the VLAN configuration commands</i>  |

*Intentionally left blank*

## APPENDIX 3 - Daylight Savings

*No time like the present...*

### Daylight Savings Time

Magnum6K Switches provide a way to automatically adjust the system clock for Daylight Savings Time (DST) changes. In addition to the value "none" (no time changes), there are fifteen pre-defined settings, a few examples are:

- Alaska
- Canada and Continental US
- Middle Europe and Portugal
- Southern Hemisphere
- Western Europe

The pre-defined settings follow these rules:

**Alaska**

- Begin DST at 2am the first Sunday on or after April 24<sup>th</sup>
- End DST at 2am the first Sunday on or after October 25<sup>th</sup>

**Canada and Continental US**

- Begin DST at 2am the first Sunday on or after April 1<sup>st</sup>
- End DST at 2am the first Sunday on or after October 25<sup>th</sup>

**Middle Europe and Portugal**

- Begin DST at 2am the first Sunday on or after March 25<sup>th</sup>
- End DST at 2am the first Sunday on or after September 24<sup>th</sup>

**Southern Hemisphere**

- Begin DST at 2am the first Sunday on or after October 25<sup>th</sup>
- End DST at 2am the first Sunday on or after March 1<sup>st</sup>

**Western Europe:**

- Begin DST at 2am the first Sunday on or after March 23<sup>rd</sup>
- End DST at 2am the first Sunday on or after October 23<sup>rd</sup>

Daylight saving time is defined for the following countries

Australia, Belgium, Canada, Chile, Cuba, Egypt, France, Finland, Germany, Greece, Iraq, Italy, London, Namibia, Portugal, Russia, Spain, Sweden, Switzerland, Syria, USA

Note – as of Release 3.7, the new daylight saving times dates enforced as of 2007, for the time zones and states in US, have been implemented in MNS-6K



## APPENDIX 4 – Updating MNS-6K Software

*Keep up to date....*

The steps required to update the MNS-6K software on your Magnum switch are listed.

*Intentionally left blank*



# 1. Getting Started

*Decide which version to use....*

This document describes how to upgrade the MNS-6K software on a Magnum 6K switch. The methods described for updating the MNS-6K software are either locally at the console port on the Magnum 6K switch or remotely over the network using FTP or TFTP. This step involves getting ready with the necessary software and hardware tools as well as deciding on which MNS-6K software version to update to.



Depending on the update process (update through the serial/console port or remotely through the network), it would be best if the necessary tools listed below are available, tested and working before you start.

For serial port updates directly through the serial/console port

- 7) A female-female null modem cable. This cable is available from GarrettCom, Inc. as well as from LANstore, Inc. (<http://www.lanstore.com>)
- 8) Serial port – if your PC does not have a serial port, you may want to invest in a USB to serial converter. This is again available from LANstore or from GarrettCom. Alternately a USB to serial cable can also be used. This cable is available also available from LAN store or GarrettCom Inc.
- 9) A PC (or a workstation/computer) with a terminal emulation program such as HyperTerminal (included with Windows) or Teraterm-pro or other equivalent software. Make sure that the software supports Xmodem protocol
- 10) Enough disk space to store and retrieve the configuration files as well as copy software files from GarrettCom. We recommend that at least 15MB of disk space is available for this purpose
- 11) Manager level account name and password of the switch being upgraded
- 12) Connection to the Internet. Make sure the connection does not block ftp file transfers

For remote updates over the network

- 1) A PC (or a workstation/computer) with a FTP as well as TFTP server software. This software is widely available as a free download on the Internet. If you need assistance in finding one, contact GarrettCom tech support at (510) 438-9071, email – [support@garrettcom.com](mailto:support@garrettcom.com)

- 2) Enough disk space to store and retrieve the configuration files as well as copy software files from GarrettCom. We recommend at least 15MB of disk space for this purpose
- 3) Connection to the Internet. Make sure the connection does not block FTP file transfers
- 4) IP address of the switch that is being upgraded. Along with that, the manager level account name and password is also needed
- 5) Connection to the GarrettCom Magnum 6K switch. Make sure the Intranet over which the software update will occur does not block FTP or TFTP traffic.

## Selecting the proper version

The first step is to ensure that you have the proper version of the MNS-6K software. To access the proper software, you will require access to the GarrettCom web site (and ftp site) through a network which does not block ftp file transfers. If your site blocks ftp file transfer traffic, please contact your system administrator to figure out how to access the GarrettCom site to download the necessary software.

First determine the version of the software on your switch. To do that, use the command 'show version' after connecting to the switch and logging in as manager, with the proper password. If the password is lost or forgotten, please contact GarrettCom Inc customer support at Phone (510) 438-9071, email – [support@garrettcom.com](mailto:support@garrettcom.com).

The table below lists the current MNS-6K version number and software version upgrade path for the MNS-6K.

Table A4-1 – *Software upgrade matrix*

| Existing software version  | Upgrade Path  | What to do  |
|----------------------------|---|---|
| Version 1.0 to Version 2.5 | Contact GarrettCom customer support to upgrade the software |   |
| Version 2.5.x or higher    | Latest Version of MNS-6K                                    | Download latest version of MNS-6K from <a href="ftp://ftp.garrettcom.com/">ftp://ftp.garrettcom.com/</a> following the steps listed below |

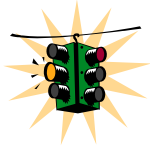
## Downloading the MNS-6K software

To download the MNS-6K software, follow these simple steps:

- 1) Access GarrettCom’s FTP site through any standard browser <ftp://ftp.garrettcom.com>
  - a) (Note: Make sure the browser has – “enable the ftp view” option checked. For Internet Explorer it can be enabled by using the menu Tools → Internet options → Advanced). If you are running a personal firewall or other firewall software, please ensure that ftp protocol is allowed on the computer or the network.



- b) If the site uses another socket number for ftp connections, use the socket number at the end of the URL. For example, if the network administrator has setup a firewall to use socket number 1684, the URL would be as follows:  
<ftp://ftp.garrettcom.com:1684>
- c) NOTE - You can use any other FTP program available on the Internet, including the 'ftp' command available on most operating systems instead of the browser for downloading the software.



Remember the file name and the directory where the MNS-6K software is stored. This will be needed later for the upgrade – irrespective of whether the MNS-6K software is updated via the serial port or over the network.

**NOTE** – the common error is to use <ftp://www.garrettcom.com> – this URL will not work. It will give you an error. Please use <ftp://ftp.garrettcom.com>

- 2) Once the connection is established, use the user login as **m6kuser** and the password as **m6kuser** – see Figure 1. If you have previously established a different login/password for the GarrettCom site, that login name and password can be used as well.

*Intentionally left blank for image continuity – image shown on next page*

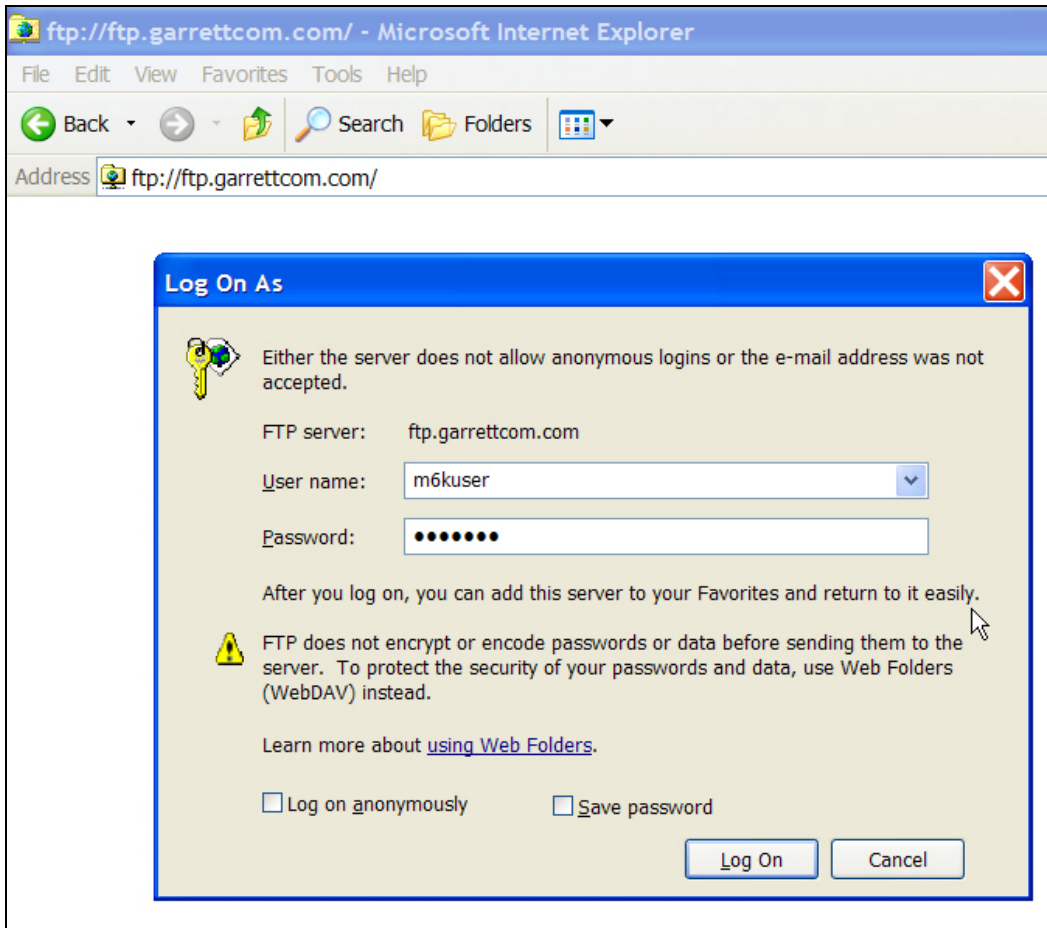


FIGURE 141 – Accessing the GarrettCom site for download.

**Note – if the browser does not support the login prompt, you can type in the user name and password on the URL as follows:**

<ftp://m6kuser:m6kuser@ftp.garrettcom.com>

- 3) After successful login, select the proper folder for downloading the proper MNS-6K software, as shown in Figure 2. Select the MNS-6K software version based on the information provided in [Table 1](#).

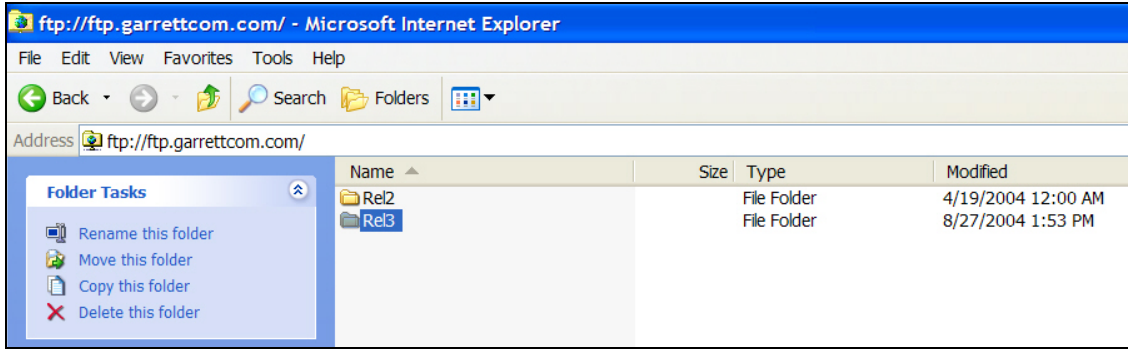


FIGURE 142 – Select the proper version to use after successful login

- 4) Navigate to the folder MNS-6K. See Figure 3. (There are other folders with additional software, MIBs as well as additional useful information for the Magnum-6K switches which you may want to use later.) From the MNS-6K folder download the latest 'Release Notes' as well as the file labeled Relx.x.bin (where x.x would be the release number. For example for release 3.0, the file will be Rel3.0.bin). The release numbers increase with new releases, so the higher the number, the recent the release is. The release notes provide additional information on the latest features and functionality plus any other additional information not covered in the manuals.

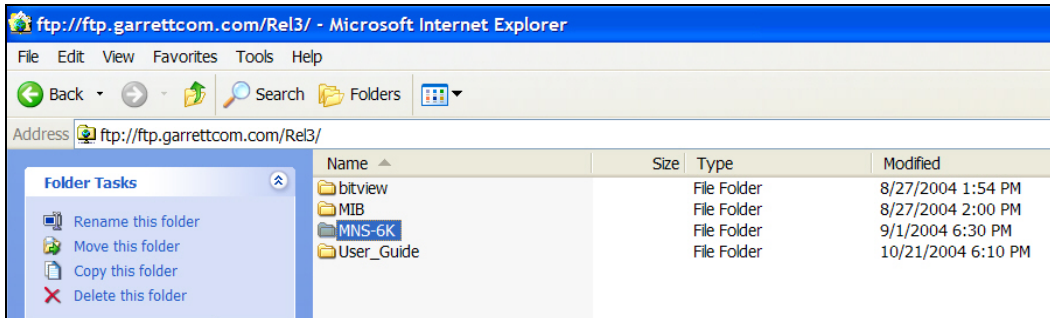


FIGURE 143 – Navigate to MNS-6K folder to download the latest MNS-6K software and the release notes

- 5) Copy the necessary files by using the copy command. This can be done by using the right click (or for left handed mouse – the left click) button and then selecting the copy command. See Figure 4. (Note - Linux or other operating system users – please use the appropriate copy command.)
  - a) If you are using another ftp program, use that programs copy command. Make sure to download the **Rel.x.x.bin** file in the binary mode (especially if you are using a command line ftp command), or the MNS-6K image may be corrupted.

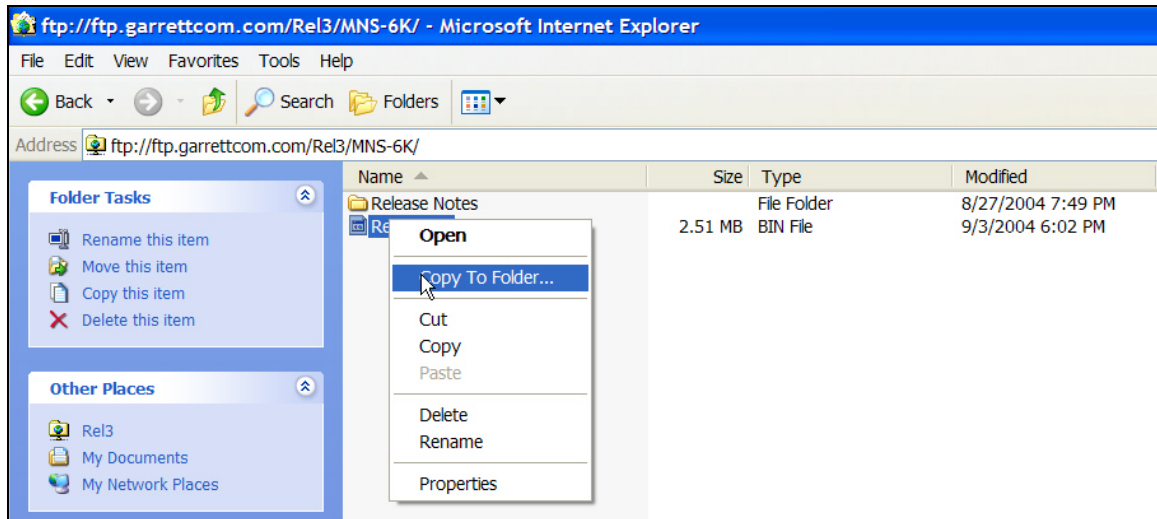


FIGURE 144 – Use the copy command to copy the files to the proper location

- 6) Make sure you remember where the files are stored as these files will be needed for the next step.

## Next steps

- 1) Access the GarrettCom Magnum 6K switch. The access can be over the console port using the null modem cable or through the network using telnet. This is described in step 2.
- 2) Save the existing configuration (either through the serial port or through the network – depending on the access method). This is also described in step 2.
- 3) Load the updated MNS-6K software and reboot the switch. This is described in step 3.
- 4) (Optional step) Reload the saved configuration. This is described in step 4.



## 2. Preparing to load the software

*Backup your existing configuration.....*

Once the MNS-6K software is downloaded from the GarrettCom site, it is strongly recommended that the existing configuration of the switch is preserved before the MNS-6K software upgrade is performed. This section will show you how to save the existing configuration and prepare you for loading the configuration.

### Accessing the switch

The MNS-6K User Guide explains how the switch can be accessed. For clarity, this section simplifies the details and describes some of the commands you can use for accessing the switch.

The Magnum 6K switch can be accessed via the serial port or through the network using telnet. For using telnet, make sure the switch is configured with the proper IP address, netmask and default gateway information. If needed, refer to Chapter 1 of the User Guide on how to set IP address and related parameters on the Magnum 6K switch.

Make sure the Manager level login name and password associated with that switch is also known. Without the proper access (login name and password) the switch cannot be upgraded.

### Serial Connection

Connect the serial port on the switch to the serial port on the computer using the serial cable listed in step 1. The settings for the HyperTerminal software emulating a VT100 are shown in Figure 5 below. Make sure the serial parameters are set as shown (or bps = 38400, data bits=8, parity=none, stop bits=1, flow control=none).

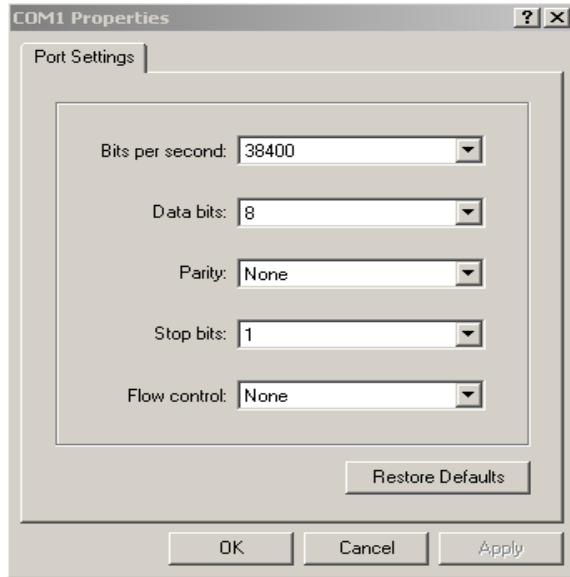


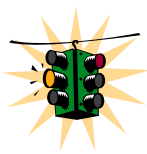
FIGURE 145 - HyperTerminal screen showing the serial settings

## Network Access

Prerequisites - a PC (or workstation/computer) with telnet software and the IP address of the Magnum 6K switch (or DNS name associated with the switch) to be upgraded. Access the Magnum 6K switch by using the telnet command. For example, if the switch has the IP address 192.168.10.11 the command is as shown in Figure 6 below.

```
C:> telnet 192.168.10.11
Trying ..... connected...
```

FIGURE 146 – Using telnet command to connect to a Magnum 6K switch with IP address 192.168.10.11



If the telnet command does not work – check for network connectivity (using the ‘ping’ command). Please ensure that a personal firewall or other firewall settings are not affecting ping or telnet commands. If telnet services fail<sup>10</sup> then the alternative is to locate the Magnum 6K switch and update the MNS-6K software through the serial port following the serial update

process described in this document.

## Saving the Configuration

Before saving the configuration, please ensure that one of the three capabilities listed below are available

<sup>10</sup> telnet services can fail due to a number of reasons. Please check with your system and/or network administrator for additional help.

- 1) Serial file transfer capability such as X-modem or equivalent
- 2) TFTP server
- 3) FTP server

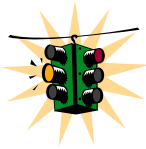
As a good practice, GarrettCom recommends that you should have all these capabilities available on your local computer if you plan to upgrade additional switches as well as switches in the future.

The command used for saving the existing configuration of the Magnum 6K switch is **'saveconf'**

*Syntax* **saveconf mode=<serial | tftp | ftp> [<ipaddress>] [file=<name>]**

Where the [ipaddress] is the IP Address of the server running the TFTP services or the FTP services. The field is needed if either the TFTP or FTP is the mode chosen.

File=<name> is needed for saving the configuration



If mode=<tftp | ftp> is used, be aware that most FTP and TFTP services, as a default, do not over-write files. If the file transfer fails, check to see if the file name already exists or use a different file name with the **'saveconf'** command. Also make sure the ftp or TFTP/FTP services are running before the **'saveconf'** command is used on the switch.

## Serial Connection

To save the configuration using the serial connection, use the **'saveconf'** command as shown below. In this example, we will show the **'saveconf'** interaction using the HyperTerminal software available on most Windows® systems.

```
Magnum6K25# saveconf mode=serial file=6kconfig-10.11
```

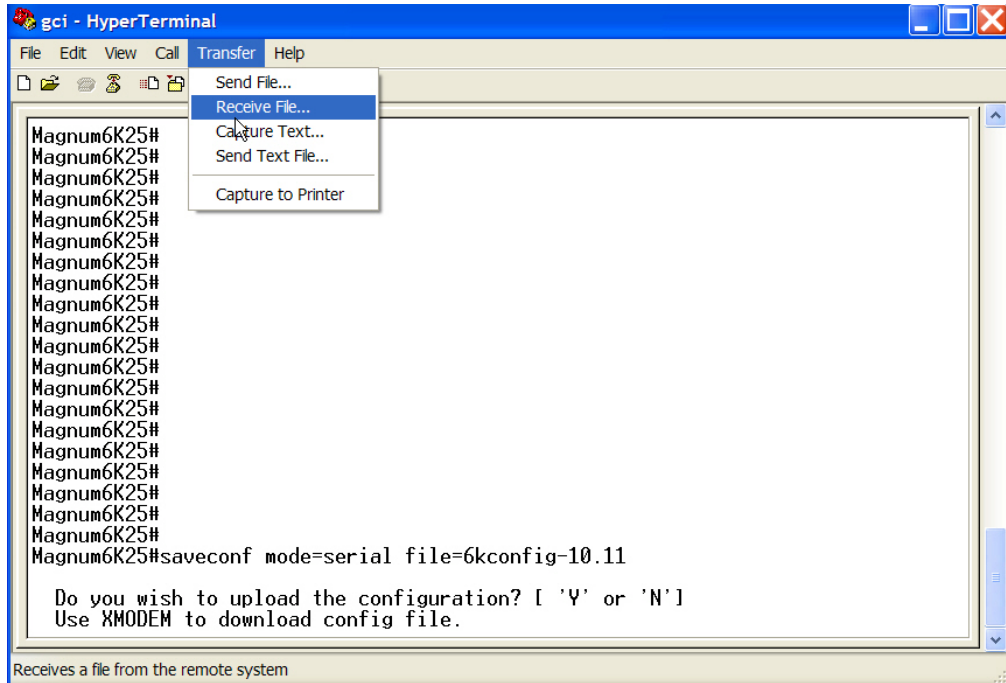
```
Do you wish to upload the configuration? ['Y' or 'N'] Y
```

```
(Use XMODEM to download configuration file)
```

**FIGURE 147** – Example of saveconf command using serial interface

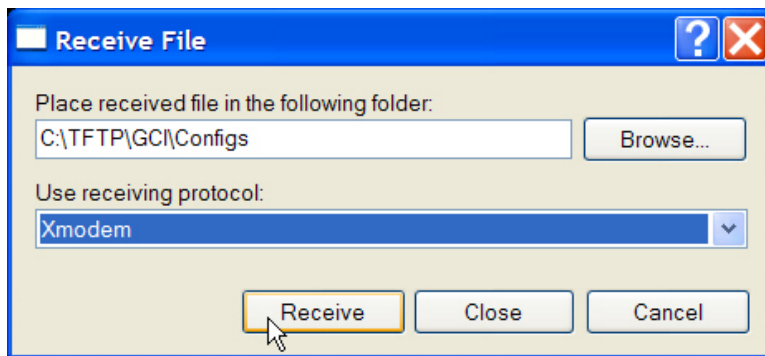
At this point, switch to the VT100 emulation software (e.g. HyperTerminal on Windows platform) and invoke the Xmodem file receive. Figure 8 shows the Xmodem process for HyperTerminal application.

*Intentionally left blank for image continuity – image shown on next page*



**FIGURE 148** – Invoke the “Receive File” to start the Xmodem transfer program. In the figure above the Windows XP based HyperTerminal screen is shown

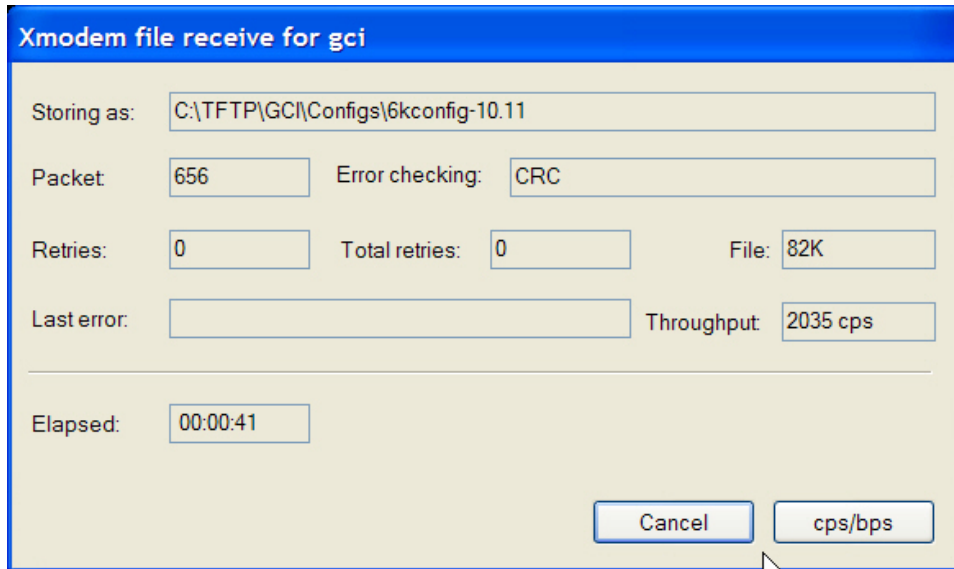
Once the “Receive File” is invoked (as shown in Figure 8) follow the dialog to save the file in the proper directory with the proper name as shown in Figure 9.



**FIGURE 149** – Make sure to select the Xmodem protocol and the proper directory where the configuration is saved. Click on Receive. This starts the file transfer.

Once the file transfer is started, the Xmodem status window is shown in Figure 10.





**FIGURE 150** – Status window for Xmodem (using HyperTerminal under Windows XP)

When the file transfer is completed, the window shown in Figure 10 exits and the completion message is displayed as shown in Figure 11.



**FIGURE 151** – Message which shows the completion of the file transfer (from 'saveconf' command)

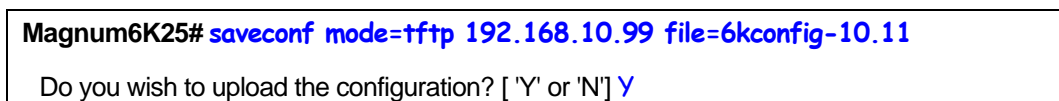
## Network Access

Prerequisites – PC (or workstation/computer) with telnet software and a PC (or workstation/computer) with FTP or TFTP server software. For simplicity, the two PC's (or workstations/computers) can be one and the same.

To save using TFTP or FTP first ensure that you have the FTP or TFTP server set up and the switch can 'ping' the TFTP or the FTP server. For ftp services, make sure the server can support anonymous login or make sure the login password information is available.

For saving the configuration, use the same saveconf command listed above. In the example below, assume the IP address of the TFTP or FTP server is 192.168.10.99 and is connected to the switch with proper network connectivity (i.e. the switch can ping the TFTP or FTP server as well.)

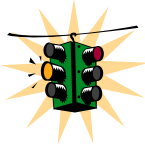
Example using TFTP



**FIGURE 152** – Example of saveconf command for tftp

This will save the file 6kconfig-10.11 to the specified IP address (192.168.10.99) in the default TFTP folder.

Using FTP would be the same as Figure 12, except replace **'mode=tftp'** with **'mode=ftp'**



In some situations (e.g. routed networks), TFTP or FTP services may be blocked. Check for network connectivity (using the 'ping' command). If the connectivity is OK, please contact your system or network administrator to unblock FTP or TFTP packets. If that is not possible, the alternative then is to locate the Magnum 6K switch and update the MNS-6K software through the serial port as described in this document.

## Next steps

- 1) Upload the updated MNS-6K software and reboot the switch. This is described in step 3.
- 2) (Optional step) Reload the saved configuration. This is described in step 4.



## 3. Loading the MNS-6K software

*Load the new version of the MNS-6K image.....*

**A**T this stage, the Magnum MNS-6K software has been downloaded from the GarrettCom site, and the configuration saved. The Magnum-6K switch is now ready to upload the new MNS-6K software image.

### Before loading the MNS-6K software

It will be necessary for the Magnum 6K switch to be reset or re-booted after the new MNS-6K software is loaded. Since this may cause a network outage, software upgrades should be performed when it is tolerable for the outage and the appropriate users are informed of this outage.

Alternately, if the S-Ring technology is used, the outage will not be noticeable and the switch will be re-inserted in the S-Ring after the upgrade is performed. It is however a good practice to inform the affected people of a possible outage.

### Accessing the switch

Continue to use the access method defined in steps 1 and 2.

The command used for upgrade is

*Syntax* **upgrade mode=<serial | ftp | tftp> [<ipaddress>] [file=<name>]**

Where

**mode** is the mode by which the software will be accessed for upload – serial, ftp or tftp

**ipaddress** is the IP address of the ftp or tftp server (only used when mode = ftp or tftp)

**file=name** is the name of the MNS-6K software file to be used for upgrade. This file was downloaded from the GarrettCom site (as described in steps 1 and 2).

## Serial Connection

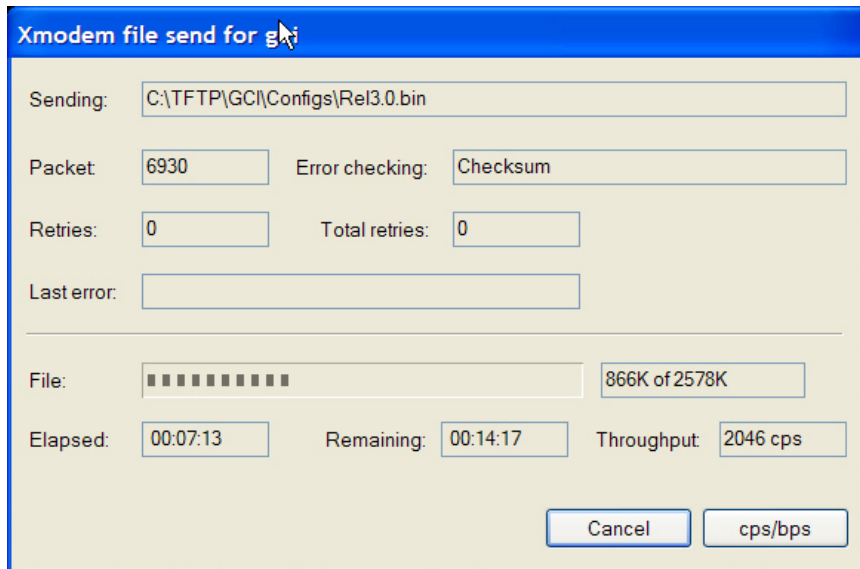
Prerequisites - make sure the directory and the file name of the MNS-6K software image downloaded in steps 1 and 2 is known. To use the serial connection to update the MNS-6K image, the command dialog is shown below:

```

Magnum6K25# show version
Version 2.6.0, Build Date: Jan 29 2004, Time: 12:02:32
Magnum6K25# upgrade mode=serial
Do you wish to upgrade the image? ['Y' or 'N'] Y
    
```

**FIGURE 153** – Upgrade using serial connection

Once the upgrade process is started, the VT100 emulation software (e.g. HyperTerminal) will ask for the file location. Once the file location is indicated, the file transfer begins. Make sure the Xmodem protocol is also selected in this file location dialog window. Once selected, the file transfer begins. The file transfer status window is shown in Figure 14.



**FIGURE 154** – File upload status window under Xmodem (using HyperTerminal under Windows XP)

Once the transfer is complete, the dialog is shown in Figure 15.

Upgrade is Successful. Please reboot Magnum 6Kxx to start the application

**Magnum6K25# reboot**

Proceed on rebooting the switch? [ 'Y' or 'N' ] **Y**

Do you wish to save current configuration? [ 'Y' or 'N' ] **Y**

*(The switch will now reboot. After the reboot, the Magnum 6K switch may prompt you should the boot code need an update. If prompted, say "Y" to update the boot code. After the reboot and login verify the MNS-6K software was upgraded.)*

**Magnum6K25# show version**

MNS-6K Ver: 3.4 Date:Mar 31 2006 Time:17:06:23 Build ID 1143853580

**FIGURE 155** – upgrading the switch using the serial interface

## Network Access

Prerequisites - make sure the directory and the file name of the MNS-6K software image downloaded in steps 1 and 2 is known. To upgrade using TFTP or FTP, ensure that the FTP or TFTP server is set up and the switch can 'ping' the TFTP or the FTP server and vice-versa. Ensure that the server has access to the MNS-6K software image downloaded in step 2. Make sure the MNS-6K software image file is copied to the default folder specified by the FTP or TFTP server. If using FTP services, make sure the FTP access information (login name and password) is also known.

In the example below, let us assume that the IP address of the TFTP server is 192.168.10.99; that the server can ping the switch and the switch can ping the server.

*Intentionally left blank for image continuity – image shown on next page*

```

Magnum6K25# show version
Version 2.6.0, Build Date: Jan 29 2004, Time: 12:02:32
Magnum6K25# upgrade mode=tftp 192.168.10.99 file=Rel3.0.bin
Do you wish to upgrade the image? [ 'Y' or 'N' ] Y
Upgrade is Successful. Please reboot Magnum 6Kxx to start the application
Magnum6K25# reboot
Proceed on rebooting the switch? [ 'Y' or 'N' ] Y
Do you wish to save current configuration? [ 'Y' or 'N' ] Y
(The switch will now reboot. Reconnect and login. Verify the MNS-6K software was upgraded.
Note – as discussed in step 1, the switch may need a boot code update. After a reboot, the switch
awaits a “Y” or “N” on whether the boot code should be updated. If no answer is given, the default
is not to update the boot code (or a “N”). Since this connection is over the network the question will
not be visible and the boot code will not be automatically updated. See step 4 – updating boot code
over the network on how to update the boot code manually.)
Magnum6K25# show version
MNS-6K Ver: 3.4 Date:Mar 31 2006 Time:17:06:23 Build ID 1143853580
    
```

**FIGURE 156** – Dialog for upgrading the image using tftp

This will load the Rel3.0.bin file from the TFTP server with the IP address (192.168.10.99) on the switch.

A similar example using ftp would be similar to what is shown in Figure 16, except the command **'mode=tftp'** will be replaced by **'mode=ftp'**. Make sure the username and password for the ftp user is known. If not known, use the user name anonymous with any password. Enter the username and password when prompted by the ftp server. Note – if you are using MNS-6K version 3.0 or lower, it is best to use the FTP server without a password – i.e. use the anonymous login.

## Next steps

(Optional step) Reload the saved configuration. Update the boot code if needed. This is described in step 4.



## 4. (Optional Step) Restoring the configuration

*Optionally, restore back the original configuration and update the boot code.....*

**A**t this optional step, the original configuration has been saved, MNS-6K image copied from the [www.garrettcom.com](http://www.garrettcom.com) site and then onto the Magnum 6K switch and finally, if required, the configuration can be restored using the instructions in this step. If the Magnum 6K switch is updated over the network, it maybe necessary to update the boot code.

### Accessing the switch

Continue to use the access method defined in steps 1, 2 and 3.

### Reloading the configuration

The command used for restoring the original configuration is

*Syntax* `loadconf mode=<serial|tftp|ftp> [<ipaddress>] [file=<name>]`

Where

**mode** is the mode by which the configuration file will be accessed for upload – serial, ftp or tftp

**ipaddress** is the IP address of the ftp or tftp server (only used when mode = ftp or tftp)

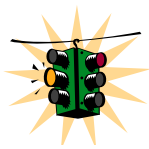
**file=name** is the name of the configuration file

At this stage, follow the same process for uploading the files as described in step 3. The file that needs to be uploaded is the configuration file which was saved in step 2 (as shown in [Figure 7](#) or [Figure 12](#).)

# Updating boot code over the network

As discussed in [step 1 – selecting the proper version](#), with either upgrade path (to Version 2.7.1B or to Version 3.0), the boot code will be updated. At boot up time, the Magnum 6K switch identifies that there is a new version of the boot code and asks if the new boot code should be loaded<sup>11</sup>. The new boot code is not loaded unless the user responds affirmatively to the question from the **console port** (or serial connection)<sup>12</sup>. If the Magnum 6K switch is upgraded over the network or remotely, the boot code can be manually updated by using the **'upgrade'** command discussed below. This allows the boot code to be updated without requiring access to serial port.

*Syntax* **upgrade mode=bl**



**mode=bl** is a hidden option and is not visible using the help capabilities in MNS-6K. This command can be executed by accessing the switch through the console port (serial connection) or through the network (telnet to the switch.)

Continue to use the network access method defined in steps 1, 2 and 3. Use the upgrade command as shown in Figure 17 and reboot the switch.

**Magnum6K25# upgrade mode=bl**

The BOOT Flash image will be replaced by the version embedded in this application.

Do you wish to upgrade the image? [ 'Y' or 'N' ] **Y**  
 Uncompressing image and programming flash memory.  
 This will take up to a minute to complete...

Boot loader upgrade is successful...

**Magnum6K25# reboot**

Proceed on rebooting the switch? [ 'Y' or 'N' ] **Y**

Do you wish to save current configuration? [ 'Y' or 'N' ] **Y**

**FIGURE 157** – *Updating the boot code over the network using the upgrade command. Make sure to reboot the switch after the boot loader upgrade is completed*

<sup>11</sup> This question is asked on the console port (serial connection) only.

<sup>12</sup> Note – If the response is not given, the switch will not load the new boot code.



Make sure there is no power failure during the boot loader update. If the boot code does not load properly, please contact GarrettCom Inc technical support at (510) 438-9071, email – [support@garrettcom.com](mailto:support@garrettcom.com)

*Intentionally left blank*

# Index

- !!, 276
- !<n>, 277
- 802.1d, 123, 127, 135, 136, 138, 141, 148, 268
- 802.1q, 209
- 802.1Q, 103, 106, 123
- 802.1w, 135, 136, 141, 150, 151
- 802.1x, 77, 78, 79, 80, 85, 263
- access, 50, 73, 74, 75, 229, 262
- action, 66, 67, 70, 75, 262
- action port, 66
- add, 29, 33, 69, 108, 109, 114, 122, 181, 183, 185, 236, 237, 238, 240, 242, 243, 254, 255, 257, 266, 270, 275, 278, 279
- add id, 109
- add mac, 69
- add port, 181, 182, 183, 185, 270, 279
- add user, 29
- advertisement, 209
- alarm, 231, 234, 236, 237, 238, 254, 274, 275
- alarm disable, 239
- Alarm Group, 230
- allow, 66, 67, 68, 73, 74, 75, 262, 263
- allow mac, 66, 67, 75, 262
- anycast address, 60
- app, 46, 47, 260, 282, 297
- auth, 32, 80, 81, 82, 83, 84, 85, 263
- Authentication, 219
- Authentication Server, 77
- authenticator, 77, 79, 80, 81, 85, 86, 263, 264
- Authenticator, 77
- Authoritative SNMP engine, 219
- authorize, 159, 164, 165, 166, 268, 279
- authserver, 80, 85, 263
- authtrap, 222, 226, 232, 273
- auto, 37, 55, 258
- backend, 85, 263
- backpressure, 97, 98, 102, 265
- bootcfg, 37, 55, 258
- bootimg, 37, 55, 258
- bootp, 36, 37, 55, 258
- BPDU, 80, 150, 154, 155, 157, 158, 161, 163, 179
- broadcast storms, 99
- broadcast-protect, 100, 102, 266
- chlevel, 30, 34, 257
- chlevel user, 30
- clear, 67, 72, 75, 262
- clear log, 72, 75, 262
- CLI, 23, 24
- climode, 57
- com2sec, 223, 227, 233, 274
- community, 222, 232, 273, 280
- community string, 218

- config, 46, 47, 260, 282, 297
- configure, 57, 75, 107, 108, 122, 261, 262, 266
- configure access, 38, 57, 261
- configure vlan, 108, 122, 266
- CoS, 188
- cost, 126, 128, 131, 134, 142, 146, 148, 267, 268
- default user name, 25
- DEFAULT-VLAN, 104, 107
- deftrap, 222, 226, 232, 273
- del, 46, 181, 182, 185, 237, 239, 254, 260, 270, 275, 281, 282
- del port, 181, 182, 185, 270, 281
- delete, 29, 33, 241, 242, 255, 257
- delete user, 29
- deny, 73, 75, 263
- device, 94, 95, 98, 100, 101, 265
- dhcp, 37, 55, 258
- DHCP, 36
- Differentiated Services. *See* Diffserv
- DiffServ, 187
- disable mode, 65
- drop mode, 65
- DS. *See* Diffserv
- DSCP, 187
- dualhome, 171, 172, 173, 270, 281
- Dual-Homing, 168
- EAP, 78
- EAPOL, 78
- edit, 108, 114, 122, 181, 185, 266, 270, 281
- edit port, 181, 185, 270, 281
- enable, 28, 33, 257
- enable ps, 69
- engineid, 222, 226, 232, 273
- Ethernet segments, 103
- Ethernet Statistics Group. *See* event, 231, 234, 274
- exit, 42, 45, 74, 95, 99, 113, 147, 183, 207, 239, 244, 247
- exportlog, 249, 250, 256, 276
- FIFO, 186
- file transfer protocol. *See* ftp
- flowcontrol, 96, 98, 101, 265
- forceversion, 142, 144, 148, 268
- FTA, 137
- ftp, 46, 56, 62, 63, 248, 260, 261, 282
- FTP modes, 248
- GARP, 209
- get, 46, 47, 260, 282, 297
- group, 223, 233, 274
- group add, 228
- gvrp, 215, 272
- GVRP, 209, 211
- GVRP BPDUs, 209
- help, 31, 34, 257
- history, 231, 233, 274
- History Group, 230
- host, 50, 57
- hosts, 46, 47, 260, 282, 297
- IEEE, 78, 80, 95, 103, 123, 127, 135, 136, 138, 141, 148, 150, 151, 160, 161, 165, 166, 167, 174, 186, 188, 209, 268, 269
- IEEE 802.1p, 186, 209

- IEEE 802.1q, 186, 209
- IEEE 802.3ad, 174
- IETF, 187
- igmp, 202, 203, 205, 207, 271
- IGMP, 20, 189, 195, 196, 197, 198, 199, 202, 203, 204, 205, 206, 207, 208, 209, 218, 235, 257, 271, 272, 299, 301
- IGMP-L2, 199, 200, 201, 202, 207, 208, 271, 272, 284, 287
- IMAP, 239
- ipconfig, 26, 33, 62, 257, 261
- IPv4, 59, 60, 61, 188, 189, 282, 295
- IPv6, 59, 60, 61, 62, 63, 261, 262, 282, 295
- ISP, 77
- kill, 39, 56, 259, 283
- kill config, 53, 54
- kill session, 39, 40, 56, 259, 283
- lACP, 181, 182, 185, 270, 283
- LACP, 20, 174, 175, 176, 177, 178, 179, 180, 181, 182, 183, 184, 185, 270, 279, 281, 283, 292
- LACPDU, 175, 177, 179
- learn, 66, 68, 69, 70, 75, 262
- learn port, 66, 75, 262
- Link-Loss-Learn, 149, 150, *See* LLL
- list, 46, 260, 282
- lll, 161, 162, 167, 269
- LLL, 149, 150, 158, 161, 162, 167, 269
- lll add, 161, 167, 269
- lll del, 161, 162, 167, 269
- loadconf, 45, 56, 259
- log, 46, 47, 260, 282, 297
- Log and Event Group, 230
- logout, 33, 34, 258
- Management Information Base. *See* MIB
- Manager, 28
- manual, 37, 55, 258
- mcast, 202, 207, 271
- MD5, 80, 89
- mgrip, 222, 232, 273
- MIB, 80, 196, 218, 223, 230, 233, 274
- mode L2, 207
- mode normal, 207
- modes of operation, 25
- MOMENTARY, 235, 236, 237, 238, 239
- more, 57
- NAS, 87
- oldconf, 46, 47, 260, 282, 297
- OPEN, 161
- Operator, 28
- passwd, 29, 34, 257
- passwd user, 29
- period, 237, 254, 275
- PHB, 187
- ping, 247, 256, 277
- ping6, 61, 63, 261
- PoE, 169
- POP3, 239
- port, 126, 128, 132, 134, 138, 142, 146, 148, 267, 268
- port security, 65, *See* ps
- port VLAN, 105
- port VLANs, 107

- portaccess, 83, 85, 264
- port-mirror, 93, 101, 265
- port-security, 65, 69, 70, 75, 262
- priority, 126, 128, 131, 134, 142, 145, 148, 186, 267, 268
- Private VLAN, 106
- privilege level, 28
- prtmr, 93, 101, 265
- ps, 66, 67, 75, 262
- put, 46, 47, 260, 282, 297
- qos, 189, 193, 270
- QoS, 20, 97, 186, 187, 188, 189, 191, 193, 194, 270, 271
- quickcfg, 222, 226, 232, 273
- RADIUS, 77, 78, 79, 80, 85, 263
- rate-threshold, 100, 101, 102, 266
- reauth, 83, 86, 264
- reboot, 27, 33, 257, 316, 317, 319
- remove, 66, 69, 73, 74, 75, 262, 263
- remove mac, 66, 75, 262
- removeall, 74, 263
- RFC, 77, 195
- RFC 1112, 195
- RFC 1752, 59
- RFC 1901, 221
- RFC 1902, 221
- RFC 1903, 221
- RFC 1904, 221
- RFC 1905, 221
- RFC 1906, 221
- RFC 1907, 221
- RFC 1908, 221
- RFC 2104, 221
- RFC 2271, 221
- RFC 2272, 221
- RFC 2273, 221
- RFC 2274, 221
- RFC 2275, 221
- RFC 3164, 71
- RFC 4541, 202
- RFC 821, 239
- RING\_CLOSED, 155, 157, 163
- RING\_OPEN, 156
- rmon, 231, 233, 274
- RMON, 230, 231, 233, 234, 236, 241, 274, 275
- rs-ring, 165, 166, 286
- RS-Ring, 20, 137, 149, 150, 151, 152, 154, 157, 158, 159, 162, 163, 164, 165, 167, 268, 286
- rs-ring add, 165, 286
- rs-ring del, 165, 166, 286
- rs-ring disable, 166
- rstp, 137, 143, 147, 165, 267
- RSTP, 20, 51, 53, 125, 127, 128, 129, 130, 131, 133, 134, 135, 136, 137, 138, 139, 140, 141, 142, 143, 144, 145, 146, 147, 148, 149, 150, 151, 152, 153, 154, 155, 156, 157, 158, 159, 162, 163, 164, 165, 178, 179, 236, 238, 239, 267, 268, 282, 284, 286, 287, 291, 293, 294
- rstp enable, 137
- RSTP Path cost, 141
- RTSP, 135
- save, 26, 27, 33, 46, 53, 69, 70, 122, 164, 216, 257, 266

- saveconf, 45, 53, 56, 259
- saveconf mode, 56, 259
- script, 46, 47, 260, 282, 297
- sendmail, 241, 243, 255, 276
- serial number, 54
- server, 241, 256, 276
- service, 74
- set, 24, 25, 28, 31, 32, 33, 35, 37, 40, 42, 43, 44, 46, 48, 55, 56, 57, 58, 64, 67, 69, 70, 72, 73, 75, 93, 94, 95, 96, 107, 109, 113, 122, 127, 137, 147, 160, 165, 166, 167, 200, 221, 223, 232, 246, 247, 248, 256, 257, 258, 259, 261, 262, 266, 267, 269, 272, 277, 286, 287, 289
- set bootmode, 37
- set date, 43, 55, 259
- set daylight, 43, 56, 259
- set ftp mode, 46, 48, 56, 248, 256, 277, 287
- set igmp, 200
- set logsize, 72, 73, 75, 262
- set password, 61, 62, 63, 64, 262
- set prompt, 246, 247, 256, 277, 289
- set serial, 40, 55, 259
- set snmp, 221, 223, 232, 272
- set stp, 127, 137, 147, 160, 165, 166, 167, 267, 269
- set time, 43, 56, 259
- set timeformat, 43, 56, 259
- set timezone, 43, 55, 259
- set vlan, 107, 109, 113, 122, 266
- set-egress, 111
- set-forbid, 215, 216, 272
- set-ingress, 111
- set-leave, 205, 206, 208, 271
- setport, 80, 81, 85, 93, 94, 95, 99, 101, 263, 265
- set-port, 111, 112, 115, 117, 122, 204, 205, 266, 271
- setport monitor, 93, 101, 265
- setport port, 94, 101, 265
- set-ports, 215, 272
- set-qi, 205, 206, 208, 272
- setqos, 189, 191, 192, 193, 271
- set-qri, 205, 207, 208, 272
- set-querier, 204, 206
- setsntp, 44, 45, 56, 259
- setsntp server, 56, 259
- set-untag, 194, 271
- setvar, 42, 55, 222, 226, 232, 247, 259, 273
- set-weight, 190, 193, 271
- show, 19, 27, 31, 32, 36, 38, 39, 41, 42, 43, 46, 48, 54, 56, 57, 58, 61, 62, 63, 66, 67, 68, 69, 70, 71, 72, 74, 75, 80, 81, 82, 85, 90, 93, 94, 95, 97, 98, 99, 100, 101, 102, 108, 109, 110, 112, 113, 114, 116, 117, 122, 124, 127, 128, 129, 130, 131, 132, 133, 134, 138, 139, 140, 141, 143, 144, 145, 146, 147, 148, 160, 161, 162, 165, 166, 167, 181, 184, 185, 191, 192, 193, 194, 202, 203, 205, 206, 207, 213, 215, 221, 222, 223, 226, 228, 231, 232, 234, 237, 239, 240, 242, 243, 245, 246, 248, 249, 254, 256, 259, 261, 262, 263, 265, 266, 267,

- 268, 269, 270, 271, 272,  
273, 275, 277, 291
- show ip-access, 74
- show ipconfig, 62, 261
- show active-snmp, 221, 223, 225,  
232, 272
- show active-stp, 127, 138, 143,  
148, 160, 165, 166, 167,  
268, 269
- show active-vlan, 113
- show address-table, 253, 254
- show alarm, 237, 238, 239, 275
- show auth config, 81
- show auth ports, 82
- show backpressure, 97, 98, 102,  
265
- show broadcast-protect, 100, 101
- show config, 33, 50, 51, 52, 57,  
257, 261
- show console, 38, 39, 58, 261
- show date, 43, 58, 261
- show daylight, 43
- show dualhome, 171, 172, 173,  
270, 291
- show flowcontrol, 97, 98, 102, 265
- show ftp, 46, 48, 56, 248, 256,  
277, 291
- show gvrp, 215, 272
- show history, 245, 256, 277
- show host, 57
- show igmp, 202, 203, 205, 206,  
207, 271
- show ip-access, 74
- show ipconfig, 36, 39, 58, 261
- show ipv6, 61, 63, 261
- show lacp, 181, 182, 183, 184,  
185, 270
- show ll, 161, 167, 269
- show log, 71, 72, 75, 249, 262
- show port, 95, 98, 101, 191, 265
- show port-mirror, 93, 101, 265
- show port-security, 66, 67, 68, 69,  
70, 75, 262
- show qos, 191, 192, 193, 194, 271
- show rmon, 231
- show rs-ring, 165, 166
- show serial, 41, 58, 245, 261
- show session, 39, 40, 56, 259
- show setup, 27, 33, 41, 54, 58,  
245, 257, 261
- show smtp, 240, 242, 243, 255,  
275
- show snmp, 222, 226, 232, 273
- show s-ring, 160, 165, 166, 167,  
269
- show stp, 124, 126, 127, 128, 129,  
130, 131, 132, 133, 134,  
138, 139, 140, 141, 143,  
144, 145, 146, 147, 148,  
267, 268
- show sysconfig*, 27, 42, 58, 261
- show tacplus, 90, 91, 264
- show time, 43, 58, 261
- show timezone, 43, 58, 261
- show uptime, 58, 261
- show version, 245, 256, 277
- show vlan, 108, 110, 112, 113,  
114, 116, 117, 122, 213,  
266
- show-access, 229
- show-authtrap, 222, 226, 232, 273
- show-com2sec, 227
- show-deftrap, 222, 226, 232, 273
- show-forbid, 215, 216, 272

- show-forceversion, 142, 144, 148, 268
- show-group, 204, 208, 223, 228, 233, 271, 274
- show-port, 83, 84, 112, 122, 204, 205, 208, 266, 271
- show-portweight, 190, 193, 194, 271
- show-router, 204, 205, 208, 271
- show-stats, 84, 86, 264
- show-timers, 142, 145, 148, 268
- show-trap, 222, 227, 233, 273
- show-user, 223, 229, 230, 233, 274
- show-view, 223, 228, 233, 274
- show-vlan, 215, 272
- signal, 66, 69, 70, 75, 262
- signal port, 66, 75, 262
- smtp, 240, 242, 243, 254, 256, 275, 276
- SMTP, 239, 240, 241, 242, 243, 244, 255, 256, 275, 276, 286, 292, 294
- snmp, 42, 55, 231, 247, 259, 272
- SNMP, 21, 23, 35, 39, 42, 66, 74, 80, 218, 219, 220, 221, 222, 223, 224, 226, 230, 231, 232, 240, 241, 242, 244, 252, 254, 255, 256, 272, 273, 275, 276, 278, 285, 287, 293, 294
- SNMP engine, 219
- SNMP group, 219
- SNMP user, 219
- SNMPv2c, 218, 219
- snmpv3, 222, 226, 232, 272
- sntp, 44, 45, 56
- sntp enable, 45
- s-ring, 160, 165, 166, 167, 269, 286
- S-Ring, ii, 20, 149, 150, 151, 152, 154, 156, 157, 158, 159, 160, 161, 162, 163, 164, 166, 186, 268, 279
- s-ring add, 160, 161, 166, 167, 269
- s-ring del, 160, 167, 269
- s-ring enable, 160
- s-ring learn, 160, 166, 269
- start, 108, 110, 115, 122, 266
- start vlan, 110
- static, 213, 215, 272
- statistics, 231, 234, 274
- stop, 113
- stp, 127, 130, 134, 160, 164, 165, 166, 167, 267, 268, 269
- STP, 20, 51, 53, 80, 95, 98, 99, 123, 124, 125, 126, 127, 128, 129, 130, 131, 132, 133, 134, 135, 136, 137, 138, 139, 140, 141, 142, 143, 144, 145, 146, 147, 148, 149, 150, 151, 152, 153, 154, 155, 156, 157, 158, 159, 160, 161, 163, 164, 165, 166, 167, 179, 191, 236, 238, 239, 267, 268, 269, 282, 284, 287, 291, 293, 295, 296
- stp enable, 127, 130
- STP Path cost, 141
- supplicant, 77, 79, 80, 81, 85, 86, 263, 264
- Supplicant, 77
- SUSTAINED, 235, 236, 237, 238
- sync, 44, 45, 56
- sysname, 247
- TAB, 32, 34, 258



- TACACS+, 87, 88, 89, 90, 91, 264, 265, 295
- TACACSD, 87
- tacplus, 90, 91, 264, 295
- tacserver, 90, 91, 265, 295
- tag VLAN, 106
- TCP, 25, 87, 90, 92, 265, 295
- telnet, 38, 39, 55, 62, 63, 258, 262
- telnet enable, 38
- tftp, 46, 48, 57, 250, 260, 296
- timers, 126, 128, 133, 134, 142, 147, 148, 267, 268
- ToS, 187, 188, 189, 193, 271
- trap, 222, 226, 233, 273
- trigger-reauth, 84, 86, 264
- UDP, 80, 81, 82, 85, 87, 263
- UNKNOWN, 161
- user, 40, 223, 229, 233, 274
- useraccess, 30, 34, 40, 257
- USM, 221, 223, 233, 274
- VACM, 221, 222, 223, 226, 232, 233, 273, 274
- VID, 105, 106, 107, 209, 210, 211, 212, 213, 214, 215, 217, 272
- view, 223, 228, 233, 274
- virtual LAN. *See* VLAN
- vlan, 108, 109, 112, 114, 122, 266
- VLAN, 22, 23, 94, 95, 98, 99, 103, 104, 105, 106, 107, 108, 109, 110, 111, 123, 209
- VLAN identifier, 106
- Write view, 219
- xmodem, 47, 57, 260, 297
- XTACACS, 87

## Free Manuals Download Website

<http://myh66.com>

<http://usermanuals.us>

<http://www.somanuals.com>

<http://www.4manuals.cc>

<http://www.manual-lib.com>

<http://www.404manual.com>

<http://www.luxmanual.com>

<http://aubethermostatmanual.com>

Golf course search by state

<http://golfingnear.com>

Email search by domain

<http://emailbydomain.com>

Auto manuals search

<http://auto.somanuals.com>

TV manuals search

<http://tv.somanuals.com>