



Magnum 3000 Stackable Hubs



Installation and User Guide

Magnum™ 3000

Stackable Hubs

Installation and User Guide

Part #: 84-00060 (Rev. 04/02)

Trademarks

Ethernet is a trademark of Xerox Corporation

NEBS is a trademark of Telcordia Technologies

UL is a registered trademark of Underwriters Laboratories

GarrettCom, Magnum and **Personal Switch** are trademarks and **Personal Hub** is a registered trademark of GarrettCom, Inc.

Important: The Magnum 3000 Stackable Hubs family contains no user serviceable parts. Attempted service by unauthorized personnel shall render all warranties null and void. If problems are experienced with Magnum 3000 Stackable products, consult Section 6, Troubleshooting, of this User Guide.

Copyright © 2006 GarrettCom, Inc. All rights reserved. No part of this publication may be reproduced without prior written permission from GarrettCom, Inc.

Printed in the United States of America.

Contacting GarrettCom, Inc

Please use the mailing address, phone and fax numbers and email address listed below:

GarrettCom, Inc.
47823 Westinghouse Dr.
Fremont, CA 94539-7437
Phone (510) 438-9071
Fax (510) 438-9072
Website: <http://www.GarrettCom.com>

email support@garrettcom.com

Federal Communications Commission Radio Frequency Interference Statement

This equipment generates, uses and can radiate frequency energy and if not installed and used properly, that is in strict accordance with the manufacturer's instructions, may cause interference to radio communication. It has been tested and found to comply with the limits for a Class A computing device in accordance with the specifications in Subpart J of Part 15 of FCC rules, which are designed to provide reasonable protection against such interference when operated in a commercial environment. Operation of this equipment in a residential area is likely to cause interference, in which case the user at his own expense will be required to take whatever measures may be required to correct the interference.

PREFACE

This user guide is divided into six main sections:

SECTION 1 covers the product specifications for Magnum 3000 Stackable Hubs family, and also provides ordering information.

SECTION 2 covers the Magnum 3024 and 3012 Stackable Hubs.

SECTION 3 describes Magnum Repeater Port Modules (RPMs) and Bridge Port Modules (BPMs) including features, installation and operation.

SECTION 4 describes management options for the Magnum 3000 family; the SNMP agents, how they are installed and used.

SECTION 5 discusses troubleshooting and warranty procedures for all of the Magnum 3000 Stackable Hubs .

REVISIONS

R07/06: Updated Rack-mounting and Appendix B & C with 24VDC and 125VDC Power Supply Option as per UL instructions.

R05/02: Updated Rack-mounting and Appendix B & C with 24VDC and 125VDC Power Supply Option

R01/02: Updated Operating Environment Specifications

R07/01: -48VDC (OPTIONAL) and Fuse info. added in Specifications

R03/01 : Change the company's name to GarrettCom, Inc.(formerly it was Garrett Communications). There are no changes made to the content material at this time.

R3/99 : This revision revises the appendices covering 48V power options.

R10/98: This revision separates the Magnum 3000 hubs manual from the 3000X Concentrator manual, and revises the appendices covering 48V power options.

R9/97: This revision includes a safety precaution at the beginning of both Installation sections for the 3012 / 3024, and the RPM-FSC

R3/97: This revision includes a new Appendix A: the 48VDC power option; the previous Appendix A: Warranty Information is now labeled as Appendix B.

R1/96:The following revisions have been made to the Magnum 3000 product line and Users' Guide since the (02/95) release: An IRB Segmenting Cable has been developed (see Section 2.3.2) which allows 3000s to be physically stacked together and controlled by a single SNMP agent, while remaining isolated from each other; The distance jumpers on the Magnum RPM-FST and RPM-FSM have been documented (see Sections 3.2.4 and 3.2.5); Installation of PMs for the 3012 and 3024 Bonus Ports is now documented (see Section 2.5).

Table of Contents**Page**

1.0	SPECIFICATIONS - MAGNUM 3024, MAGNUM 3012.....	1
1.1	Specifications - Repeater Port Modules (RPMs); Bonus Ports.....	3
1.2	Specifications - Bridge Port Modules (BPMs); Bonus Ports	3
1.3	Ordering Information	4
2.0	INTRO - MAGNUM 3012 AND 3024 STACKABLE HUBS.....	5
2.1	Inspecting the Package and Product	5
2.2	Product Description - Magnum 3000 Stackable Hubs	6
2.3	Magnum 3024 Hub - 24 RJ-45 Ports, One PM bonus port slot	7
2.3.1	Stacking Magnum 3000s.....	7
2.3.2	Segmenting a Magnum 3000 Stack with a Special Cable.....	8
2.3.3	Group # Address Switch Settings, for Managed Units and Stacks.....	10
2.4	Magnum 3012 Hub - 12 RJ-45 Ports, One PM bonus port slot	11
2.5	Rear Bonus Slot, Port Modules (PMs).....	12
2.6	Features and Benefits, Magnum 3024 and 3012 Hubs	15
2.7	Applications	16
3.0	INSTALLATION AND OPERATION	17
3.1	Connecting Ethernet Media	17
3.1.1	Connecting Twisted Pair (RJ-45, Unshielded or Shielded)	17
3.1.2	Connecting ThickNet 10BASE5 (AUI)	18
3.1.3	Connecting ThinNet 10BASE2 (BNC).....	18
3.1.4	Connecting Drop Cable 10BASE5 (DTE).....	18
3.1.5	Connecting Fiber Optic 10BASE-FL and FOIRL	18
3.1.6	Connecting Fiber Optic (SC-type, "Snap-On").....	19
3.1.7	Connecting Single-Mode Fiber Optic (SMF)	19
3.1.8	Power Budget Calc for Magnum 3000s RPM's with Fiber Media.....	19
3.1.9	Rack-mounting	20
4.0	INTRODUCTION - MAGNUM PORT MODULES.....	22
4.1	Inspecting the Package and Product	22
4.2	Product Description, Port Modules.....	22
4.2.1	RPM-BNC.....	23
4.2.2	RPM-AUI.....	23
4.2.3	RPM-DTE.....	25
4.2.4	RPM-FST (Fiber ST, Twist-lock Connector)	26
4.2.5	RPM-FSC (Fiber SC, Snap-in Connector).....	27
4.2.6	RPM-SMF (Single-mode Fiber)	27
4.2.7	RPM-TP (Twisted Pair)	28
4.2.8	BPM-BNC.....	29
4.2.9	BPM-AUI.....	30
4.2.10	BPM-FST.....	30
4.2.11	BPM-TP	31

5.0	INTRO SIMPLE NTWRK MGMT PROTOCOL (SNMP) AGENTS	32
5.1	SNMP Agents Description.....	32
5.1.1	Embedded SNMP Agent, Model 3000-MB	32
5.1.2	Separate Agent Box, Model 3000-AGT	33
5.1.3	Standard Repeater MIB and Extensions	33
5.2	Installation, General Information.....	36
5.3	Installing the Embedded Agent Board, "MB"	36
5.4	Agent Configuration, Embedded Agent and Agent Box Versions ...	39
5.4.1	Automatic Agent IP Address Configuration.....	40
5.4.2	Manual IP Address Configuration.	40
5.4.3	Other Convenience Commands.....	43
6.0	TROUBLESHOOTING	44
6.1	Before Calling for Assistance	44
6.2	When Calling for Assistance	45
6.3	Return Material Authorization (RMA) Procedure	45
6.4	Shipping and Packaging Information.....	46
APPENDIX A: WARRANTY INFORMATION		46
APPENDIX B : INTERNAL DC POWER SUPPLY OPTION		47
APPENDIX C : INTERNAL DC DUAL-SOURCE POWER OPTION		49

The Magnum Line

ETHERNET CONNECTIVITY PRODUCTS

"DESIGNED AND MANUFACTURED IN THE USA"

OVERVIEW

GarrettCom, Inc. offers the premium-quality Magnum™ line of Ethernet LAN connectivity products with industry-standard functionality and built-in fiber configurability. Magnum products are designed for use in demanding Carrier Class, Industrial Grade and OEM applications where reliability is a primary consideration.

4K-Series Switches, 100 & 10Mbps, copper ports with optional fiber port, with auto-negotiating full switching performance

Quad-Series Fiber Switches, 100 & 10Mbps, fiber and copper ports, mixed-speed and mixed-media types, full switching performance

“Outdoor” Ethernet Switch, for temperature uncontrolled locations

6 10/100 and 2 100Mb fiber ports, can be connected in strings

Mixed-Media Fiber Hub, 16-port Stackable, 10/100 auto-sensing

Dual Speed 8-port and 16-port Stackables, 10/100 auto-sensing

Stackable Hubs, SNMP Optional

10Mb series and 100Mb series, both w/ optional port modules

Personal Switches, 10/100Mb

8 port dual speed, Auto-negotiable with fiber option

Personal Hubs, 100Mb or 10/100Mb

8-port, with two switched ports (1 fiber built in)

Personal Hubs, 10Mb series

8-port + AUI, stackable to 5 high, + optional BNC of fiber port

8 or 9-port and 4 or 5-Port Personal Hubs, w/ man. up-link sw.

Media Converters, 10Mb and 100Mb series

All media combinations, incl. fiber ST, SC, mm., single mode

The “X-line” of configurable MiXed Media products:

Stackable Concentrators, SNMP optional, 13-Ports

Mini-Concentrators, 7 Ports, Repeaters, 2-Ports

Repeater Port Modules (RPMs), 6 types for Ethernet media

Bridge Port Modules (BPMs), 4 types, for segment isolation

Fan-Outs, 10Mb series

2, 4 and 8 Port Models

Transceivers, 10Mb and 100Mb series 10Mb Mini-Transceivers and Coax Models, All Types -

July, 06

1.0 Specifications - Magnum 3024, Magnum 3012

Performance

Data Rate:	10 Mbps
RPM Partitioning:	Enforced after 32 consecutive collisions
RPM Reconnect:	Occurs after 512 bits error-free reception
BPM Auto-Learning Address List:	256 nodes capacity
BPM Filtering and Forwarding Rate:	14,880 pps max.

Maximum Ethernet Segment Lengths

DTE (AUI Drop Cable)	- 50 m (164 ft)
10BASE-T (twisted pair)	- 100 m (328 ft)
Shielded twisted pair	- 150m (492 ft)
10BASE2 ThinNet (BNC)	- 185 m (607 ft)
10BASE5 ThickNet	- 500 m (1,640 ft)
FOIRL multi-mode Fiber optic	- 1 km (3,281 ft)
10BASE-FL multi-mode Fiber optic	- 2 km (6,562 ft)
Single-mode Fiber optic	- 10 km (32,810 ft)

Network Standards

Ethernet V1.0/2.0 IEEE 802.3: 10BASE-T, 10BASE5,
10BASE2, 10BASE-FL & FOIRL, and DTE

Operating Environment

Ambient Temperature:	25°F to 120°F (-5°C to 50°C)
Storage Temperature:	-40°F to 185°F (-40°C to 85°C)
Ambient Relative Humidity:	5% to 95% (non-condensing)
Altitude:	-200 to 13,000 Ft. (-60 to 4000 m)
Conformal coating option:	Request quote

Port Connector Types

RJ-45:	Shielded, 8-Pin Female (Note: <i>Shielded 10BASE-T connectors accept either unshielded or shielded wiring plugs for standard twisted pair media wiring.</i>)
Fiber Optic:	ST (Twist-Lock Connector, for single and multi-mode)
Fiber Optic:	SC (Snap-in Connector, for multi-mode fiber cables only)
ThinNet:	BNC
AUI:	D-Sub 15-Pin Female (with slide lock)
DTE:	D-Sub 15-Pin Male (with lock posts)

Power Supply (Internal)

AC Power Connector:	IEC-type, male recessed, rear of chassis
Input Voltage:	100 - 240 vac (auto-ranging)
Input Frequency:	47 - 63 Hz (auto-ranging)
Power Consumption:	Model 3024 : 18 watts typical; 30 watts max, Model 3012 : 10 watts typical; 20 watts max, 3000-AGT : 9 watts typical; 20 watts max,

DC Power Supply (Options)

-48VDC Power Input Voltage : 36 to 72 VDC

24VDC Power Input Voltage : 20 to 36VDC

125VDC Power Input Voltage : 120 to 300VDC

Std. Terminal Block : “ -, GND, + ”

Power Consumption: same as for AC models, see above

For Dual Source and Redundant DC for -48VDC, 24VDC Power & 125VDC supply options (Optional), see Appendices.

Packaging

Enclosures: High strength sheet metal, suitable for wiring closet shelf, rack or table-top mounting.

Dimensions: Models 3024, 3012, 3000-AGT: 9.0 in x 17.0 in x 1.75 in (22.9 cm x 43.2 cm x 4.45 cm)

Weight: Model 3024: 5.0 lbs (2.3 Kg), Model 3012 and 3000-AGT: 4.0 lbs (1.8 Kg)

Cooling method: Models 3024, 3012, 3000-AGT: Convection except 3012 and 3024 w/ embedded agent: Fan cooled, internal @ 7cfm

LED Indicators on Chassis Front

PWR - Power, Green LED, steady on when AC power is applied.

LINK - (Models 3024 & 3012) Per RJ-45 port, Steady On when twisted pair link is operational, flashing if the port is partitioned by hardware

RX - (Models 3024 and 3012) Per RJ-45 port, Receive, Green LED, blinks to indicate activity of data being received on the port.

Agency Approvals

UL Listed (UL 1950), cUL, CE

Emissions: meets FCC Part 15 Class A

Optional: ETSI and NEBS L3 Certified

Warranty

Three years, return to factory

Made in USA

1.1 Specifications - Repeater Port Modules (RPMs); Bonus Ports

RPM Type :	BNC	AUI	DTE	Fiber-mm	Fiber-sgl.m	TP*
Front Access	yes	yes	yes	yes	yes	yes
Connector Type	BNC-f	DB-15 f	DB-15 m	Fiber-ST	Fiber-ST	RJ-45
Partition (PART)LED	yes	yes	yes	yes	yes	yes
Receive (RX) LED	yes	yes	yes	yes	yes	yes
LINK LED	n.a.	n.a.	n.a.	yes	yes	yes
Switch on Face Plate	yes**	n.a.	n.a.	n.a.	n.a.	yes***

"Fiber-mm" is multi-mode cable, normally used for 10BASE-FL installations, up to 2.0Km.

"Fiber-sgl.m" is single-mode cable, used for distant installations, up to 10.0Km.

* The RJ-45 connector is shielded; it accepts RJ-45 eight-pin plugs for unshielded and shielded twisted pair wiring.

** Internal termination switch for BNC, no "T" connector is required.

*** MDI-X (Media Dependent Interface - Crossover) switch for RJ-45 uplink, no crossover cable is required.

1.2 Specifications - Bridge Port Modules (BPMs); Bonus Ports

BPM Type :	BNC	AUI	Fiber	TP*
Connector Type	BNC(f)	DB-15(f)	ST	RJ-45
Switch on FP	yes**	n.a.	n.a.	yes***
FWD-I LED	yes	yes	yes	yes
FWD-X LED	yes	yes	yes	yes
LINK LED	n.a.	n.a.	yes	yes

* The RJ-45 connector is shielded; it accepts RJ-45 eight-pin plugs for unshielded and shielded twisted pair wiring.

** Internal termination switch for BNC, no "T" connector is required.

*** MDI-X (Media Dependent Interface - Crossover) switch for RJ-45 uplink, no crossover cable is required.

1.3 Ordering Information

Magnum 3000 Stackable Hubs and Concentrators

Magnum 3024	Base Chassis with 24 RJ-45 ports, shielded connectors
Magnum 3012	Base Chassis with 12 RJ-45 ports, shielded connectors

ETSI and NEBS-certified models, -48VDC powered

Magnum 3012-NEBS	NEBS Level 3 tested and certified with -48VDC power supply Base Chassis with 12 RJ-45 ports
Magnum 3024-NEBS	NEBS Level 3 tested and certified with -48VDC power supply Base Chassis with 24 RJ-45 ports

Note: for Dual-Source DC and other special options, RFQ to sales@garrettcom.com

Network Management Options:

Magnum 3000-MB	SNMP option, Embedded Agent Board
Magnum 3000-AGT	SNMP option, Embedded Agent Box as a separate stack unit
Magnum 3000-NMS	"SNMPc" PC / Windows-based Network Management Software product from Castle Rock Computing.

Port Modules (PMs)**:

Magnum RPM-BNC	Module with 1 BNC connector, internal termination switch
Magnum RPM-TP	Module w/ 1 shielded female RJ-45 connector + up-link switch
Magnum RPM-AUI	Module with 1 AUI (DB-15 female) connector, with slide lock
Magnum RPM-DTE	Module with 1 DTE (DB-15 male) connector, with lock posts
Magnum RPM-FST	Module w/ mm* Fiber ST "twist" 10BASE-FL dual connector
Magnum RPM-SMF	Module w/ single-mode Fiber connector
Magnum BPM-BNC	Local Bridge Module with 1 BNC connector
Magnum BPM-AUI	Local Bridge Module with 1 AUI connector
Magnum BPM-FST	Local Bridge Module with mm* Fiber ST connector
Magnum BPM-TP	Local Bridge Module with 1 RJ-45 connector + uplink switch
Magnum PM-FP	Face Plate - cover for unused front slots

* mm = multi-mode.

** These items must be included to convey configuration information to the factory. For example, to order a Model 3024 Hub with a BNC-type RPM option factory installed in the rear bonus port slot, you must include Model "3024-PM" and Model RPM-BNC as separate line items on the same order, in order to specify that the RPM-BNC is to be factory-configured in the rear bonus port.

GARRETTCOM, INC. reserves the right to change specifications, performance characteristics and/or model offerings without notice.

2.0 Introduction - Magnum 3012 and 3024 Stackable Hubs

This section describes the features and capabilities of the Magnum 3012 and 3024 Stackable Hubs, including bonus ports, applications, installation, and operation.

2.1 Inspecting the Package and Product

Examine the shipping container for obvious damage prior to installing this product; notify the carrier of any damage which you believe occurred during shipment or delivery. Inspect the contents of this package for any signs of damage and ensure that the items listed below are included.

This package should contain:

- 1 - Magnum 3012 or Magnum 3024 Base Unit
- 1 - AC Power Cord (U.S. and other 115 vac only)
- 1 - Set of metal "Ears" for optional rack mounting
- 1 - Inter-Repeater Bus (IRB) ribbon cable with connectors
- 1 - Installation and User Guide
- 1 - Product Registration Card

Remove the items from the shipping container. Be sure to keep the shipping container should the unit need to be re-shipped at a later date. To validate the product warranty, please complete and return the enclosed Product Registration Card to GarrettCom as soon as possible.

In the event there are items missing or damaged, contact the party from whom you purchased the product. If the unit needs to be returned, please use the original shipping container if possible. Refer to Section 6, Troubleshooting, for specific return procedures.

Caution: Be sure to see Section 2.3.2 about switch settings before installing with 3000 units in a managed Magnum 3000 stack.

2.2 Product Description - Magnum 3000 Stackable Hubs

Magnum 3000 Stackable Hubs are suitable for small- to medium-size enterprises needing an Ethernet local area network, either managed or unmanaged. They will operate, individually or combined in a stack, as self-sufficient devices to provide 10BASE-T Ethernet connectivity for all local users and devices. Small independent networks built using Magnum 3000 Stackable Hubs are easily expanded by adding units in a modular (stacking) manner, interconnected via the Inter-Repeater Bus.

Magnum 3000 Stackable Hubs are available in two building-block models: the 3024, with 24 ports for low cost per port and high port density, and the 3012, with 12 ports for low entry-level or add-on cost. Both units have an internal power supply, a metal enclosure for stand-alone or rack mounting, and convenient front access status-indicator LEDs and RJ-45 port connectors.

Magnum 3000 Stackable Hubs are equipped with shielded RJ-45 connectors, and support full length segments of Ethernet twisted pair media. An additional rear-mounted bonus port may be configured for any media type using a Magnum Port Module (PM), for applications such as connecting to a backbone up-link and segment isolation. Only 1.75 (4.45 cm) high, the compact Magnum 3000 Hubs economize on rack and wiring closet space.

Status-indicator LEDs consist of Power On (PWR) for the unit, and Link/Partition (LINK) and Receive (RX) for each individual port. The LEDs for each port are located immediately above the port connector for clear coordination of status data with the associated port. Each LINK LED is steady ON when that twisted pair link is operational, and flashing when that port is partitioned by hardware. Each RX LED blinks when packets are received on the port.

The internal power supply is auto-ranging to handle any AC power type worldwide, and each unit is normally convection-cooled for silent operation. Magnum 3000 Stackable Hubs operate in compliance with the IEEE 802.3 specification for repeater functionality to perform signal amplification, re-timing, and regeneration of preamble bits for each packet received. Consistent with IEEE 802.3 specifications, Magnum 3000 Stackable Hubs will detect collisions, generate jam signals, extend collision fragments, and automatically partition and re-connect individual ports.

2.3 Magnum 3024 Hub - 24 RJ-45 Ports, One PM bonus port slot

The Magnum 3024 Hub provides 24 RJ-45 ports on the front of the unit plus a Bonus Port slot on the rear which may be configured with any Magnum Port Module (PM). User-segment wiring connections are made on the front of the unit, and status-indicator LEDs are located immediately above each of the 24 ports.

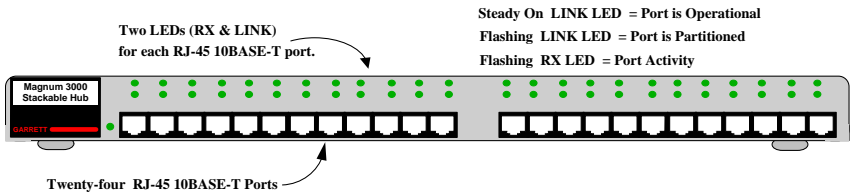

Figure 2.3a, Magnum 3024 Hub, Front View

The shielded RJ-45 port connectors on the front are electrically connected to the metal case of the unit, and are helpful in reducing electromagnetic noise radiation from the unit. (Note that the 10BASE-T wiring cable to the user may be unshielded or shielded, Category 3 or 4 or 5. The choice of wiring type is left to the installer based on preferences, standard practices and local or national wiring codes.)

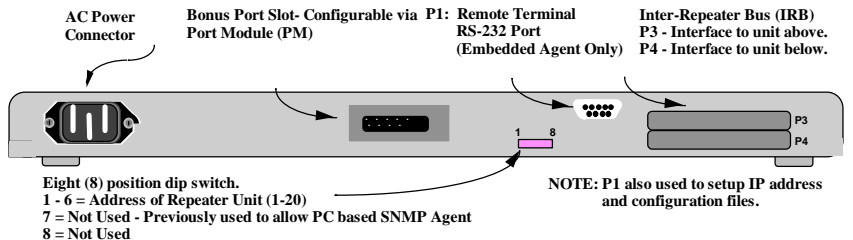

Figure 2.3b, Magnum 3024 (and 3012), Rear View

2.3.1 Stacking Magnum 3000s

The rear of the Magnum 3000 Stackable Hubs have an Inter-Repeater Bus (IRB) connector on the right side. The IRB interconnects stacked units with a shielded ribbon cable, enabling all stacked Magnum 3000 units to operate as a single repeater.

There are two 34-pin IRB connectors on each unit: the bottom IRB connector which is used to daisy chain the IRB to the stacked Magnum 3000 unit below (unused on bottom unit in a Magnum 3000 stack); and the top IRB connector which is used to daisy chain the IRB to the stacked Magnum 3000 unit above (unused on top unit in a Magnum 3000 stack). The IRB connectors for a non-stacked unit are unused.

The IRB ribbon cables supplied with each Magnum 3000 base unit are slightly longer than the base unit height. Thus, an IRB cable segment has a small arc shape when it is properly installed. It is possible to have some long IRB ribbon cable segments, up to a few meters in length, for service loops and such. The operation of the stack will not be impaired by longer IRB ribbon cables. Stacks with total IRB lengths of as much as ten meters can be implemented. However, non-standard IRB cable lengths must be specially made.

The IRB ribbon cables may be installed and/or removed while a Magnum 3000 unit is powered without causing damage to the electronic circuits in that unit or any others in a Magnum 3000 stack. This is convenient for expanding a stack without shutting down the network, and for performing diagnostics and service on potentially faulty units operating in a stack. **CAUTION:** disconnecting an IRB ribbon cable can cause operational upsets by breaking the interconnection among the stacked units previously operating as a single repeater and/or with one SNMP agent.

2.3.2 Segmenting a Magnum 3000 Stack with a Special Segmenting Cable

Magnum 3000 Stackable Hubs are typically stacked as described in Section 2.3.1. However, it may be desirable to stack the 3000s so that they operate as separate repeater units. This will normally be done to manage several separate hubs (or small stacks) with a single 3000 AGT SNMP Agent box. In this situation, single units or several small stacks of units may be connected using SRC Segmenting Cables (part numbers SRC-2 and SRC-4, available as a spare part from GCI). Hubs connected via an IRB Segmenting Cable do not transmit or receive normal Ethernet traffic through the IRB.

GCI supports this non-standard configuration, making special stacking cable available (see Models SRC-2 and SRC-4 in the Spare Parts Price List) to provide the flexibility to break apart managed stacks into multiple collision domains for higher performance, while still maintaining the advantages of one SNMP agent.

Consider the case where it is desired to divide a managed stack into two segments and insert a local bridge to increase performance (see Figure 2.3.2a). Normally, it would be necessary to add another SNMP agent to maintain full management. However, using the special Segmenting cable option, it is possible to remove one standard IRB cable and replace it with an SRC cable. This divides the stack

into two logical repeaters with separate collision domains, while still passing SNMP management data through the SRC so that the agent can manage both repeaters. Then, a local bridge can be installed between the two repeaters using a port from each (for example, using a bonus port from each repeater) to

provide traffic service between the repeaters while maintaining full 10Mbps bandwidth for the users on each repeater stack.

Figure 2.3.2a:

Stack segmentation using an SRC cable

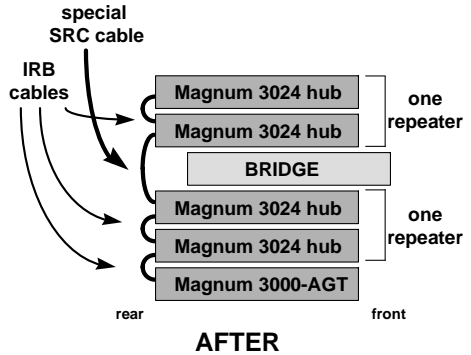
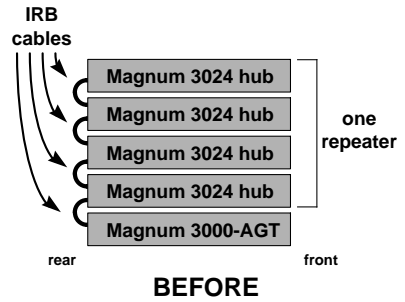

The same result could also be achieved by installing a Magnum Bridge Port Module (BPM) into the Bonus Port of one of the repeaters and connecting it to a port on the other repeater.

In another example, eight 3024 hubs in a managed stack are individually segmented and a switching hub is used as the traffic center.

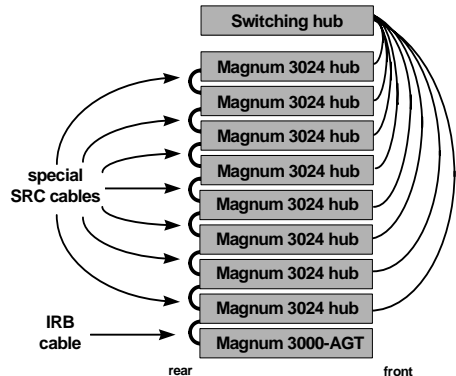

Figure 2.3.2b: SRC cables segment a managed stack for connection to switching hub ports.

This special configuration provides high bandwidth for the users on each 3024 hub, but also provides the efficiency of a single SNMP agent for all of the 3024s. Note also that Magnum 3012 units can be used with the special SRC segmenting cable, mixing with the 3024 models in configurations as desired.

NOTE: To differentiate the SRC cable from the IRB cable, GCI uses colored ribbon cable for the SRC. The standard IRB cables are gray in color.

2.3.3 Group # Address Switch Settings, for Managed Units and Stacks

The eight-position DIP switch on the rear panel is used to give each unit in a Magnum 3000 managed stack a unique Group # or "stack address". This Group # follows the SNMP definition. (Group # addresses and the associated switch settings do not matter if the units are unmanaged or "dumb"). See the illustration in Figure 2.3.3a.

Switches one through six are set at the time of installation to form a binary number from 1 to 20. The switch positions may be moved using an instrument such as a small screw driver, a pencil eraser or a fingernail. See Section 5.3 for a table of switch settings vs. Group # address numbers.

The units in a managed stack should have Group # addresses beginning at 1 and proceeding up to the number of stacked units configured as one logical repeater at the particular installation. The factory default address switch setting is usually "1", i.e., switch 1 ON and switches 2 through 6 OFF.

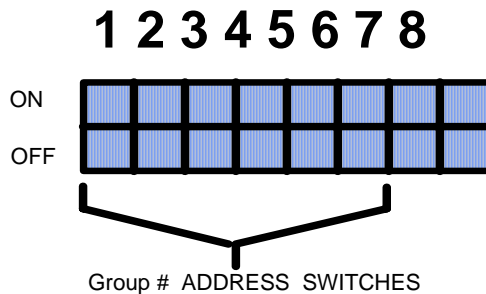

Figure 2.3.3a, Group # Address Switches, Enlarged Illustration

The Group # switch settings must not be the same for any two Magnum 3000 units operating in one managed stack. Factory default switch settings cannot be relied upon, and the user must check and/or change the Group # address switch settings for each managed Magnum 3000 unit installed.

If a network management software package is in use, the Group # addresses set for each Magnum 3000 physical unit will be reflected in the NMS displays, statistics and controls that correspond to that unit's Group # address. (While non-sequential Group # addresses will not prevent the units in a stack from working properly in the network, such numbering tends to create problems for network administration and are therefore discouraged accordingly.)

A Magnum 3000 stack may have from 2 to 20 active units (not including an optional 3000-AGT unit, which could be the 21st box in a large stack). The stacked units may be any combination of Magnum 3024s, 3012s, 3000X and they may be arranged in any order, physically and logically, for Group numbering purposes. Switch settings for Group # addresses of zero and from 21 to 31 are not recognized by the NMS software in a managed system, and the use of such Group # addresses is discouraged.

Switch 7 of the eight-position DIP switch is no longer used. In previous versions of the product line it allowed the use of a PC-based SNMP AGENT. Switch 8 of the eight-position DIP switch is also unused.

The "P1" DB-9 connector on the upper part of the rear panel is used for a serial port into the optional embedded SNMP agent board. If there is no embedded agent board in a unit, "P1" is not present. See Section 5.1 for operational information on the optional SNMP embedded agent board.

2.4 Magnum 3012 Hub - 12 RJ-45 Ports, One PM bonus port slot

The Magnum 3012 Hub provides 12 shielded RJ-45 ports on the front of the unit, and is otherwise like the Model 3024 described above. Refer to the descriptive material in Section 2.3 above.

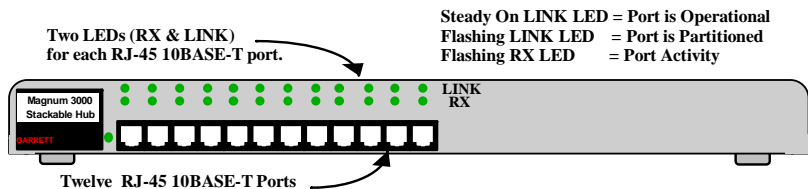

Figure 2.4a, Magnum 3012 Hub, Front View

There is no upgrade from a Model 3012 to a Model 3024 since it would not provide an economical method of adding ports. Note that the high degree of stacking of Magnum 3000s - up to 20 units! - provides essentially unlimited expansion of the number of users by adding more units to the stack.

2.5 Rear Bonus Slot, Port Modules (PMs)

The Magnum 3012s and 3024s are each equipped with a bonus slot on the rear of the unit. This slot may be optionally configured at the time of order with any one of six Repeater Port Modules (RPMs) or four Bridge Port Modules (BPMs) to implement an extra port. The optional bonus port may be used for any purpose, such as an Ethernet coax backbone connection, or as a micro-bridge segment isolation unit. The RPMs support any of six different media types: BNC (ThinNet), AUI (ThickNet), DTE (male AUI), ST & SC (multi-mode Fiber), SMF (single-mode Fiber), and RJ-45 (UTP and STP). The BPMs support any of four media types: BNC, AUI, ST, and RJ-45 (UTP and STP). Normally, a maximum of one BPM should be used in a stack.

Each PM is equipped with its own media connector type. (For additional information and specifications of individual PMs, see Section 4 of this manual.) The assortment of standard network connector types for each RPM is shown in Figure 2.5a.

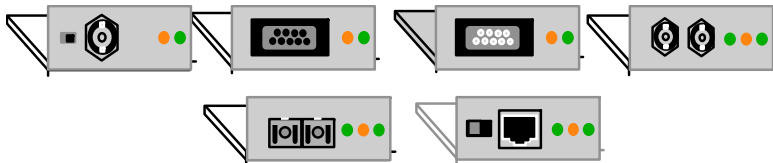

Figure 2.5a: Magnum RPM Modules for Bonus Ports

**Left to right above: RPM-BNC, RPM-AUI (female),
RPM-DTE (male), RPM-FST, RPM-FSC, RPM-TP**

The family of standard connector types for BPMs is shown in Figure 2.5b.

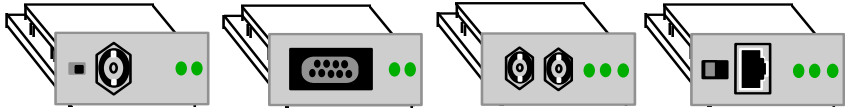

Figure 2.5b: Magnum BPM Modules for Bonus Ports
(left to right above) **BPM-BNC, BPM-AUI, BPM-FST, BPM-TP**

(Note: When an RPM-AUI type is configured as a bonus port, it is typically implemented at the factory as an AUI connector with a ribbon cable to header pins on the main board. The functionality is the same as the RPM-AUI card.)

For application flexibility, any of the Magnum PMs may be specified for factory configuration at the time of order. It is also possible for the Bonus Port slot to be configured in the field by a trained technician.

NOTE: When adding a Port Module to the Bonus Port slot in the field, it is necessary to have a Port Module connector cable (part number PM-CBL available as a spare part from GCI) in addition to the desired PM. See Figure 2.5a and 2.5b.

Figures 2.5a and 2.5b show the internal layout of the Magnum 3012 and 3024, respectively. When installing a PM into the Bonus Port slot of the Magnum 3012, the 16-pin header labeled **J1/B (also labeled RPM)** should be used. The red stripe of the PM connector cable should connect to pin 1 of header J1/B.

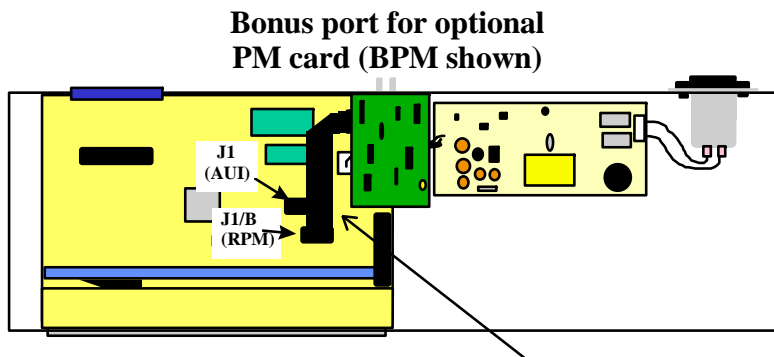

NOTE:

Use J1 (AUI) and for Basic AUI ports
Use J1/B (RPM) for PMs

(Included only when PM is factory installed
May be ordered separately as part #CBL-PM)

Figure 2.5c: Magnum 3012 internal layout with configured Bonus Port

When installing a PM into the Bonus Port slot of the Magnum 3024, use the 16-pin header labeled **P1 (also labeled RPM)** on the circuit board corresponding to ports 13-24. The red stripe of the connector cable should connect to pin 1 of header P1.

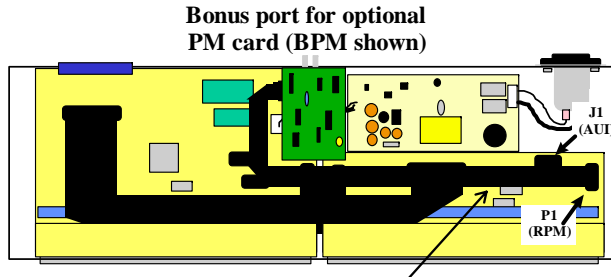
**NOTE:**

Use J1 (AUI) and for Basic AUI ports
Use P1 (RPM) for PMs

PM Ribbon cable with 16 pin connector.
(Included only when PM is factory
May be ordered separately as part # CBL-PM)

NOTE: The PM will still function if connected to header J1/B of the circuit board corresponding to ports 1-12. However, this is not advised, as the port will not be recognized by an SNMP Agent (if one is present).

Figure 2.5d: Magnum 3024 internal layout with configured Bonus Port

CBL-AUI

When the RPM-AUI is factory configured as a bonus port, it is implemented with CBL-AUI, an AUI connector with a ribbon cable, to the 16-pin header J1 (AUI) on the main board (Shown in both figure 2.5a and 2.5b). Since the AUI functionality is built onto the main board, using CBL-AUI is identical to the RPM-AUI. GCI recommends that RPM-AUI units should not get installed in the bonus port of both 3012's and 3024's.

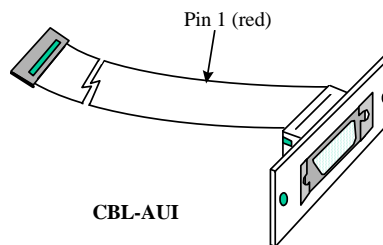

2.6 Features and Benefits, Magnum 3024 and 3012 Hubs

■ 24 Port and 12 Port "Building Block" Hub Models

The 24 port units provide high density and low cost-per-port. The 12 port units provide minimum add-on and entry-level system cost. The two units may be combined and mixed in one stack.

■ Optional SNMP Management

Magnum 3000 Stackable Hubs may optionally be configured with an SNMP agent. The SNMP agent is available as an embedded daughter board mounted inside of a 3024 or 3012, or as a separate unit which is the same physical size as a 3024 or 3012 unit and which supports a 3000 Stack. One SNMP agent serves all the Magnum 3000 units in one stack.

■ Stackable and Scaleable Configurations

Up to twenty Magnum 3000 units may be stacked, thus supporting up to 500 Ethernet segments operating as a single repeater. Both Hubs and an SNMP Agent Box may easily be added to the stack for expansion of the system. This provides for low initial cost and for graceful growth of network systems.

■ Bonus Ports for any Ethernet Media Type

An optional rear-mounted bonus port may be configured with an RPM of any media type, providing flexible connectivity to backbones or other devices and nodes.

■ Optional Bridge Port Modules

The Magnum 3000 Stackable Hubs can be optionally configured with a BPM as the bonus port. BPMs contain a miniature, self-learning local bridge module capable of filtering and forwarding packets at full Ethernet wire speed. A BPM may be used to bridge-isolate a local segment (such as all of the nodes connected to a stack) having significant local inter-node traffic, thus boosting overall network performance.

■ Rack-mount or Table-top, Front-access Connectors and Status LEDs

Match the installation requirements of any environment with stacking flexibility. Magnum 3000 Hubs may be mounted in a standard RETMA rack or stacked on a shelf or table-top. The 10BASE-T ports and the associated LEDs are adjacent to each other on the front of the units for convenient status monitoring.

■ Small, compact units, 1 U

At only 1.75 inches (4.45 cm) high, Magnum 3024 and 3012 Hubs save rack space and provide high port density in the wiring closet.

■ Proven reliability

Thousands of Magnum 3012 and 3024 Stackable Hubs have been installed in critical applications world-wide for multiple years, and have demonstrated exceptionally low failure rates. Calculated MTBF is up to 140,000 hours, depending on specific configuration and methodology.

2.7 Applications

The Magnum 3000 Stackable Hubs provide a flexible and cost-effective solution to a variety of Ethernet networking applications. The combination of Stackable Hubs and Stackable Mixed-Media Concentrators with optional SNMP is unique and powerful.

Figure 2.7, taken from an installation in a small educational institution building, illustrates some of the capabilities. The task was to economically network two workgroups of PCs in Wing A and Wing C, and to consolidate them with an existing group of UNIX workstation users in Wing B.

Here, a Magnum 3024 hub for 18 UNIX users in Wing B is being used to add to and to support a ThinNet (10BASE2) segment. The BNC port is implemented via an RPM-BNC in the rear bonus port. This hub is connected to a stack of two Magnum 3024's and one Magnum 3012 for 56 PC users in Wing A. A second segment of Fiber (10BASE-FL) cable provides a link from the Wing A Magnum stack to an additional 22 users in Wing C. The optional future SNMP-based network manager can be connected to any unit of the Magnum stack in Wing A. (A single SNMP agent may be added to the Wing A stack as a future enhancement, for use with network management software. Also note that BPMs in the bonus ports at Wings B and C can bridge-isolate this network into 3 segments, each with essentially full bandwidth for high performance).

Because the high quality Magnum 3000s adhere to industry standards for physical layer connectivity and for network management, they are popular choices for small-to-medium-sized Ethernet networks where reliability and economy are required.

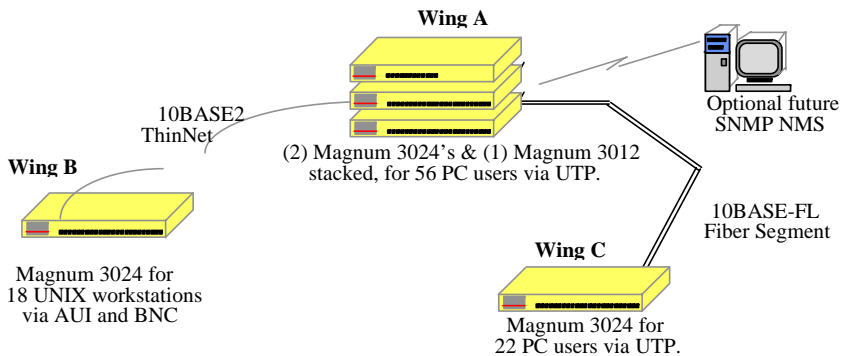

Figure 2.7: Magnum 3000s Consolidate an Educational Network System

3.0 Installation and Operation

Before installing the equipment, it is necessary to take the following precautions:

- 1) If the equipment is mounted in an enclosed or multiple rack assembly, the environmental temperature around the equipment must be less than or equal to 50°C.
- 2) If the equipment is mounted in an enclosed or multiple rack assembly, adequate air flow must be maintained for proper and safe operation.
- 3) If the equipment is mounted in an enclosed or multiple rack system placement of the equipment must not overload or load unevenly the rack system.
- 4) If the equipment is mounted in an enclosed or multiple rack assembly, verify the equipment's power requirements to prevent overloading of the building/s electrical circuits.
- 5) If the equipment is mounted in an enclosed or multiple rack assembly verify that the equipment has a reliable and uncompromised earthing path.
- 6) If the intra-building wiring (cabling) is involved with this product (NEBS), then it is recommended to have shielded cable and the shield is grounded at both ends.
- 7) This equipment is for installation only in a Restricted Access Location (dedicated equipment room service closet and the like) in accordance with the National Electrical Code.

3.1 Connecting Ethernet Media

The Magnum 3000 Hubs are specifically designed to support all Ethernet media types via the Bonus Port options. There is a family of Port Modules (PMs). The procedures for connecting each media and connector type are as follows:

3.1.1 Connecting Twisted Pair (RJ-45, Unshielded or Shielded)

The following procedure describes how to connect a 10BASE-T twisted pair segment to the RJ-45 port on the front panel of the 3000 hub or to the RPM-TP or BPM-TP of the 3000X or bonus port. The procedure is the same for both unshielded and shielded twisted pair segments.

1. Using standard 10BASE-T media, insert either end of the cable with an RJ-45 plug into the RJ-45 connector. Note that, even though the TP connector is shielded, either unshielded or shielded 10BASE-T cables and wiring may be used.
2. Connect the other end of the cable to the corresponding device.
3. When proper connection and power have been established, the port's LINK LED will illuminate GREEN.

NOTE: The Magnum **RPM-TP** and **BPM-TP** are equipped with a cross-over slide switch to accommodate repeater-to-repeater connections without special cross-over connectors. Set the slide switch to the "down" position for normal twisted pair cable segments from the hub port to a user device. Set the slide switch to the "up" position for cascaded or up-link segment connections to another repeater or hub in the network. Verify proper switch position by noting that the port's LINK LED will illuminate when proper link is established.

3.1.2 Connecting ThickNet 10BASE5 (AUI)

Using the steps below as a guide, attach a new or existing 10BASE5 ThickNet drop-cable directly to the AUI connector on the RPM-AUI or BPM-AUI port.

1. Plug the cable's male end into the female AUI connector on the PM-AUI card.
2. Engage the AUI connector slide lock to insure maximum connectivity.
3. Connect the opposite end of the cable into a network AUI port. (This could be a network backbone transceiver, a hub or fan-out with an AUI port, or an AUI Port Module in a concentrator.)

The AUI port may also be used for connecting to other Ethernet devices using standard AUI cabling. In this type of situation, it is important to consider the AUI segment length to the attached device, including any cascading. See "Product Description, RPM-AUI" for additional details.

3.1.3 Connecting ThinNet 10BASE2 (BNC)

Connect the ThinNet coax cable to the BNC connector on the Magnum RPM-BNC or BPM-BNC card in the same manner as is done for any standard BNC connection. The PM-BNC port is specially equipped with an internal termination switch on the front of the card (see Section 4.1 for a description of this switch). This eliminates the need to use a "tee" connector when the BNC cable is ending at the connection to this PM. Some applications may require a "tee" connector, used as a tap, to allow the 10BASE2 coax segment to continue on past the PM-BNC connection.

3.1.4 Connecting Drop Cable 10BASE5 (DTE)

Using the steps below as a guide, attach the 10BASE5 drop-cable directly to the DTE connector on the RPM-DTE port.

1. Plug the cable's female end into the male DTE connector on the RPM-DTE card.
2. Engage AUI connector slide lock (on the cable) to insure maximum connectivity.
3. Connect the opposite end of the cable into a network AUI port. (This could be a server, router, bridge, hub, or UNIX workstation.)

3.1.5 Connecting Fiber Optic 10BASE-FL and FOIRL (ST-type, "Twist-Lock")

The following procedure applies to FOIRL and 10BASE-FL applications using an RPM-ST or BPM-ST card with ST-type fiber connectors. (The primary difference between FOIRL and 10BASE-FL for users is the maximum distance allowed. 10BASE-FL is used for a fiber segment length of up to 2000m, while FOIRL is used for fiber segments of up to 1000m in length.)

1. Before connecting the fiber optic cable, remove the protective dust caps from the tips of the connectors on the PM-ST. Save these dust caps for future use.
2. Wipe clean the ends of the dual connectors with a soft cloth or lint-free lens tissue dampened in alcohol. Make certain the connectors are clean before connecting.

Note: **One strand of the duplex fiber optic cable is coded using color bands at regular intervals; you must use the color-coded strand on the associated ports at each end of the fiber optic segment.**

3. Connect the Transmit (TX) port (light colored post) on the Magnum PM-FST to the Receive (RX) port of the remote device. Begin with the color-coded strand of the cable for this first TX-to-RX connection.
4. Connect the Receive (RX) port (dark colored post) on the PM-FST to the (TX) Transmit port of the remote device. Use the non-color coded fiber strand for this.
5. The LINK LED on the front of the PM-FST will illuminate when a proper connection has been established at both ends (and when power is ON in the unit). If LINK is not lit after cable connection, the normal cause is improper cable polarity. Swap the fiber cables at the Port Module connector to remedy this situation.

3.1.6 Connecting Fiber Optic (SC-type, "Snap-On")

The same five-step procedure as for fiber ST-type applies to FOIRL and 10BASE-FL applications using an RPM-SC card used with SC-type fiber connectors. Follow the five steps as described in the Section 3.3.5 above.

When connecting fiber media to SC connectors, simply snap on the square male connector into the SC female jack of the device until it clicks and secures.

3.1.7 Connecting Single-Mode Fiber Optic (SMF)

When using the RPM-SMF, be sure to use single-mode (small diameter) fiber cable. The same five-step procedure as for multi-mode ST-type applies to single-mode.

3.1.8 Power Budget Calculations for Magnum 3000s RPM's with Fiber Media

Receiver Sensitivity and Transmitter Power are the parameters necessary to compute the power budget. To calculate the power budget of different fiber media installations using Magnum products, the following equations should be used:

$$\text{OPB (Optical Power Budget)} = P_T(\text{min}) - P_R(\text{min})$$

where P_T = Transmitter Output Power, and P_R = Receiver Sensitivity

$$\text{Worst case OPB} = \text{OPB} - 1\text{dB}(\text{for LED aging}) - 1\text{dB}(\text{for insertion loss})$$

$$\text{Worst case distance} = \{\text{Worst case OPB, in dB}\} / [\text{Cable Loss, in dB/Km}]$$

where the "Cable Loss" for 62.5/125 and 50/125 μm (M.m) is 2.8 dB/km,

and the “Cable Loss” for 100/140 (Multi-mode) is 3.3 dB/km,

and the “Cable Loss” for 9/125 (Single-mode) is 0.5 dB/km

The following data has been collected from component manufacturer’s (HP’s and Siemens’) web sites and catalogs to provide guidance to network designers and installers.

Fiber Port Module	Speed, Std.	Mode	Std. km fdx (hdx)	Wave - length nm	Cable Size μm	X'mitr Output P _T , dB	R'cvr Sens. P _R , dB	Worst OPB, dB	Worst* distance Km, fdx	typical OPB, dB	typical* distance Km, fdx
RPM-FST, FSC	10 Mb FL	Multi-mode	2 (2)	850	62.5/125	-15.0	-31	14	5	17	6
					100/140	-9.5	-31	19.5	5.9	23.5	7
					50/125	-19.5	-31	9.5	3.4	13.5	4.8
RPM-SMF(ST)	10 Mb FL	Single-mode	10 (5)	1300	9/125	-30	-39	7	14	13	26

* **Note:** The use of either multi-mode or single-mode fiber to operate at 100Mbps speed over long distances (i.e., in excess of approx. 400 meters) can be achieved **only** if the following factors are both applied:

- The 100Mb fiber segment must operate in full-duplex (FDX) mode, i.e. the full-duplex (factory default) setting for 100Mbps fiber ports must be used, and
- The worst-case OPB of the fiber link must be greater than the fiber cable’s passive Attenuation.

(Attenuation = Cable loss + LED aging loss + Insertion loss + safety factor)

3.1.9 Rack-mounting

Installation of a Magnum 3000s Hub in a 19” rack is a simple procedure. The units are 1U (1.70”) high. When properly installed, the front-mounted LED status indicators should be in plain view and easy to read. Rack-mount installation requires special 19” rack-mounted

brackets and screws

(included with each 3000s

unit). The brackets attach to

the front sides of the Hub,

which is then fastened into a standard 19” RETMA rack.



The 23” brackets and ETSI brackets are also available (optional) for Rack-mounting of Magnum 3000 units. The 23” brackets are more popular in the Telco industry where they are a standard for Central Office Rack-mounting purposes. The 23” brackets are mainly used for larger equipment assemblies in rack mounting frames, and are frequently accessed in operation from both sides.

The ETSI (European Telephone Standard) brackets are similar to the 19" brackets but use metric dimensions.

The optional 23" brackets and the ETSI brackets come as a pair in a package along with the necessary screws for attaching the brackets to the sides of the Magnum Hub unit.

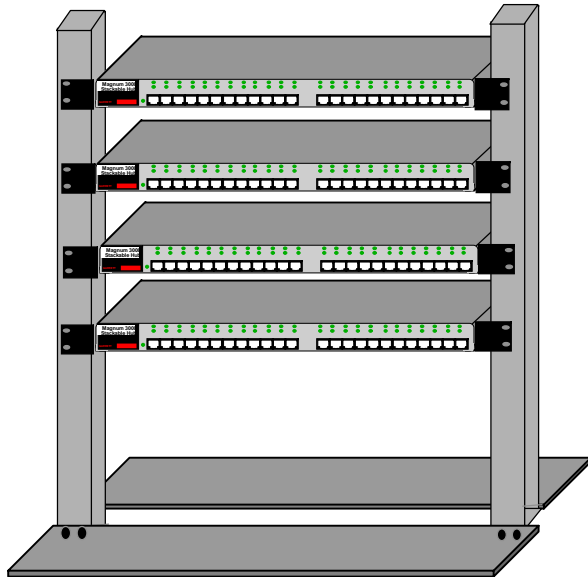

Fig 3.1 Multiple Magnum 3000 units rack-mounted in a 23" Rack-mount frame

The following instructions need to be follow up before installations-

- A) Elevated Operating Ambient - If installed in a closed or multi-unit rack assembly, the operating ambient temperature of the rack environment may be greater than room ambient. Therefore, consideration should be given to installing the equipment in an environment compatible with the maximum ambient temperature (T_{ma}) specified by the manufacturer.
- B) Reduced Air Flow - Installation of the equipment in a rack should be such that the amount of air flow required for safe operation of the equipment is not compromised.
- C) Mechanical Loading - Mounting of the equipment in the rack should be such that a hazardous condition is not achieved due to uneven mechanical loading.
- D) Circuit Overloading - Consideration should be given to the connection of the equipment to the supply circuit and the effect that overloading of the circuits might have on overcurrent protection and supply wiring. Appropriate consideration of equipment nameplate ratings should be used when addressing this concern.
- E) Reliable Earthing - Reliable earthing of rack-mounted equipment should be maintained. Particular attention should be given to supply connections other than direct connections to the branch circuit (e.g. use of power strips)."

4.0 Introduction - Magnum Port Modules

This chapter describes each Port Module (PM), including appearance, functionality, and status displays.

4.1 Inspecting the Package and Product

This section applies only to PMs shipped as separate items, i.e., only to **PMs not factory installed** in a Magnum 3000 Stackable Hubs bonus port slot.

Examine the shipping container for obvious damage prior to installing a PM; notify the carrier of any damage which you believe occurred during shipment or delivery. Inspect the contents of this package for any signs of damage and ensure that the items listed below are included.

This package should contain:

One or more PMs.

Remove the PM(s) from the shipping container. Be sure to keep the shipping container should you need to ship any of the PMs separately at a later date.

In the event there are items missing or damaged contact your supplier. If you need to return the unit, use the original shipping container if possible. Refer to Chapter 5 for specific return procedures.

4.2 Product Description, Port Modules

An important feature of the Magnum 3000 Stackable Hubs is the use of individual Port Modules (PMs) for flexible mixed-media connectivity. The Magnum PMs are compact interface cards designed to support every standard Ethernet media type. Each PM provides one port for connecting one Ethernet segment with its individual connector type and media. There are a total of six Repeater Port Module (RPM) cards, plus a face plate. They are:

RPM-BNC, RPM-AUI, RPM-DTE RPM-FST (or FSC), RPM-SMF, RPM-TP

There are also four different Bridge Port Module (BPM) cards. They are:

BPM-BNC BPM-AUI BPM-TP BPM-FST

Each PM is individually described as follows.

4.2.1 RPM-BNC

The Magnum RPM-BNC repeater module is equipped with a standard 10BASE2 coax connector. This RPM performs full IEEE 802.3 repeater functionality and is used for 10BASE2 ThinNet (commonly referred to as BNC) connections.

The RPM-BNC module is designed with a special switch-selectable internal termination function that eliminates the need for a "tee" connector and a 50 ohm terminator. To take advantage of internal termination, the slide switch should be in the "DOWN" (or right-side) position. In this configuration, the 10BASE2 segment is directly

Magnum RPM-BNC attached to the BNC port where it is internally terminated. When the switch is in the "UP" (or left-side) position, the BNC port requires a "tee" connector (not supplied) and a 50 ohm terminator for proper termination. Certain applications may require a "tee" connector, used as a tap, to allow the 10BASE2 coax segment to continue on past the RPM-BNC connection.

The RPM-BNC module includes one partition (PART) and one receive (RX) LED, which are visible beside the connector. The PART LED illuminates AMBER to indicate that the segment has been automatically partitioned. As soon as normal reception resumes, the segment will be automatically re-established. The RX LED illuminates GREEN intermittently to indicate data is being received.

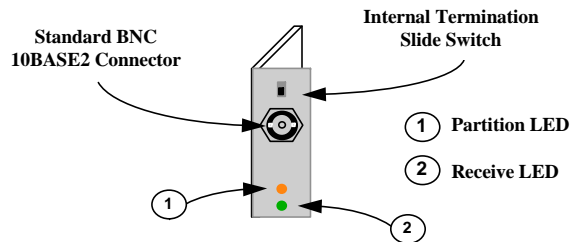

Important Note: for the RPM-BNC Termination Switch - DOWN (or right) = Internally Terminated, UP (or left) = "T" Connector required.

4.2.2 RPM-AUI

The RPM-AUI is equipped with a 15 pin female AUI connector and a slide-lock, and performs full IEEE 802.3 repeater functionality. It is used to provide connectivity with a 10BASE5

(ThickNet) backbone or to any AUI segments. A transceiver is required when connecting to a ThickNet segment and the RPM-AUI supports this convention. The RPM-AUI is also a "universal" Ethernet media interface as it may be used with a variety of different mini-transceivers

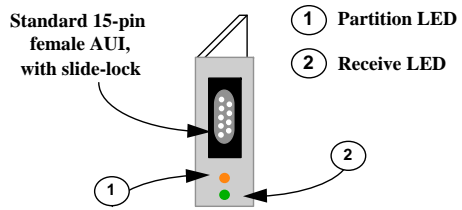

Magnum RPM-AUI

to provide connectivity to any media type. The Magnum RPM-AUI card is also used for connecting Ethernet devices using standard AUI cabling. In this situation, it is important to consider the AUI segment length or distance to the attached device (see details below). RPM-AUI cards are equipped with Partition (PART) and Receive (RX) LEDs which function the same as the identical LEDs on the RPM-BNC (see above).

NOTE: When the RPM-AUI is factory configured as a bonus port, it is implemented as an AUI connector with a ribbon cable to special pins on the main board. The functionality of this is identical to the RPM-AUI.

The maximum transmission distance between a backbone transceiver equipped with an AUI connector and an RPM-AUI port will vary. When an AUI cable is used to connect the Magnum RPM-AUI directly to a backbone transceiver, the maximum AUI segment length is allowed. If the RPM-AUI is connected to a transceiver that has been cascaded from another transceiver, the maximum AUI segment length is reduced.

According to Ethernet standards, the maximum distance from the transceiver AUI connector and the attached device (Magnum RPM-AUI) is 50m (165 ft.). The AUI segment maximum length is reduced in cascaded configurations. See the following note.

Important Note: The maximum transmission distance is decreased by 6m (20 ft.) for every additional level of network transceiver device "dropped" or "cascaded" from the original backbone transceiver tap.

The RPM-AUI connector supports standard IEEE signals, as follows:

Table 3.2.2: AUI Pin Assignments

Pin	Function	Pin	Function
1	Control In Circuit Shield	10	Data Out Circuit B
2	Control In Circuit A	11	Data Out Circuit Shield
3	Data Out Circuit A	12	Data In Circuit B
4	Data In Circuit Shield	13	Voltage Plus (+)
5	Data In Circuit A	14	Voltage Shield
6	Voltage Common	15	Control Out Circuit B
7	Control Out Circuit A	SHELL	Protective Ground
8	Control Out Circuit Shield (conductive shell)		
9	Control In Circuit B		

NOTES:

- 1) Voltage Plus (pin #13) and Voltage Common (pin # 6) use a single twisted pair in the AUI cable.
- 2) Pins 4, 8, 11 and 14 may be connected to pin #1.

4.2.3 RPM-DTE

The Magnum RPM-DTE is a module equipped with a 15-pin male DTE connector with lock posts. (The RPM-DTE is a mating connector for the RPM- AUI which has a 15-pin female connector and slide locks. The pin assignments of

the two are the same). The RPM-DTE card is designed to support direct

connections (no transceiver required) using AUI drop cables to

any device that is equipped with an AUI port. Examples of such devices include servers, router, bridges, hubs, and UNIX workstations.

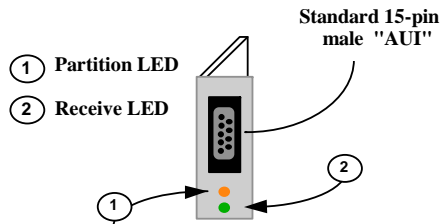

Magnum RPM-DTE

4.2.4 RPM-FST (Fiber ST, Twist-lock Connector)

The Magnum RPM-FST is a multi-mode fiber optic module equipped with a dual ST-type connector. It functions as an IEEE 802.3 full repeater to support 10BASE-FL and FOIRL network segments. When used for 10BASE-FL segments, this module supports fiber optic transmission distances up to 2000m. For FOIRL applications, it supports fiber segments of up to 1000m in length. The RPM-FST includes full transceiver

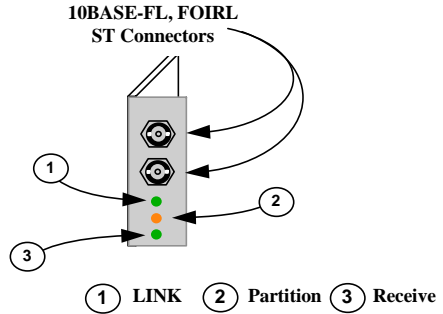

Magnum RPM-FST

functionality and does not require an external transceiver device. In addition to Partition (PART) and Receive (RX) LEDs, a LINK LED indicates proper connectivity with the remote device.

NOTE: The RPM-FST/FSC circuit board contains a six pin jumper which controls the intensity of the transmitted signal. By default, the jumper is placed across pins 1 and 2. The jumper may be set as follows to accommodate distances of up to 4 km:

JUMPER ACROSS DISTANCES SUPPORTED

1 - 2	0 - 2 km
3 - 4	0.5 - 3 km*
5 - 6	1.5 - 4 km*

When distances of less than 2 km are needed, the jumper should be placed across pins 1 and 2.

*When fiber cable distances of more than 2 km are selected, the minimum cable length must also be increased, as shown in the table above.

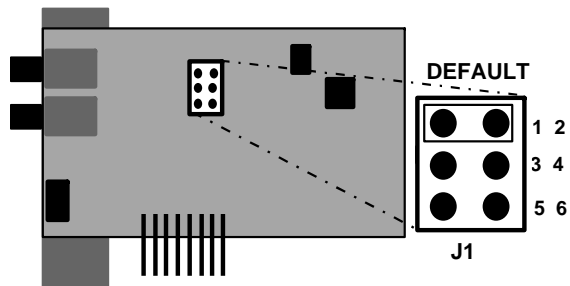

4.2.5 RPM-FSC (Fiber SC, Snap-in Connector)

The Magnum RPM-FSC is also a multi-mode fiber optic repeater module, similar to the RPM-FST. It has the same LEDs indicating port partitioned (PART), receive activity (RX), and link operational (LINK). It has the same jumper settings for extra distance in certain circumstances.

While the functionality of these two modules is the same, the RPM-FSC is equipped with an SC-type "snap-in" connector instead of an ST-type "twist-lock" connector. Please refer to Section 3.2.4. for details.

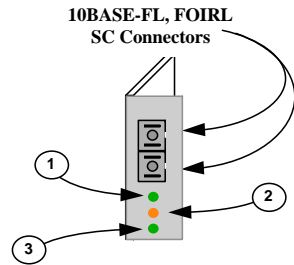

Magnum RPM-FSC

4.2.6 RPM-SMF (Single-mode Fiber)

The Magnum RPM-SMF is a single-mode fiber optic module equipped with a dual ST-type connector. It functions as a full repeater to support single-mode fiber networks. The RPM-SMF supports fiber optic transmission distances of up to 10 Km. The RPM-SMF includes full transceiver functionality and does not require an external transceiver device.

This module is equipped with PART, RX, and LINK LEDs identical to those of the RPM-FST. To distinguish the single-mode RPM-SMF from the multi-mode

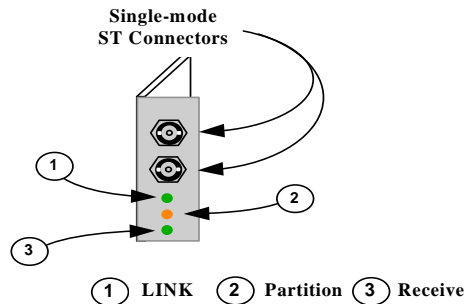

Magnum RPM-SMF

RPM-FST, the label "Sgl. M." is at the top of the faceplate of the RPM-SMF. As an additional indicator, a multi-mode TX port emits light (red in color) that is in the visible spectrum and which can be seen by looking into the port with the power on and with no cable connected. The single-mode TX port emits light outside of the visible spectrum and will always look dark to the human eye.

Note: Be sure to use single-mode fiber optic cable with this module. Single-mode fiber cable has a smaller diameter than multi-mode fiber cable (2/15 - 8/60 microns for single-mode, 50/125 or 62.5/125 microns for multi-mode, where xx/xx are the diameters of the core and the core plus the cladding respectively).

NOTE: The RPM-SMF circuit board contains a six pin 3-position jumper, but the jumper is only to be placed across pins 5 & 6. The others are not used.

**JUMPER ACROSS DISTANCES
SUPPORTED**

1 - 2	not used
3 - 4	not used
5 - 6	0 - 10 Km

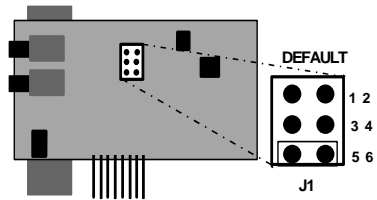

4.2.7 RPM-TP (Twisted Pair)

The Magnum RPM-TP card supports Ethernet twisted pair segments of any standard length. It is equipped with a single RJ-45 connector. The RJ-45 connector is shielded to minimize emissions and will allow both unshielded twisted pair (UTP) and shielded twisted pair (STP) segment connections.

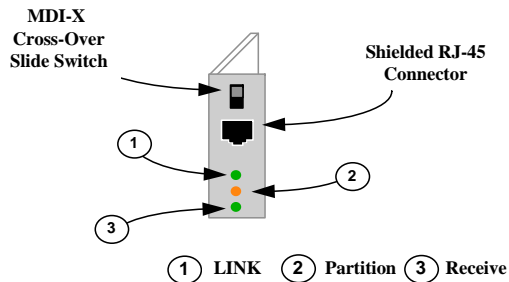

Magnum RPM-TP

The RPM-TP module is also equipped with a Media Dependent Interface-Crossover (MDI-X) slide switch to allow for cascaded connections. This feature eliminates the need for a special twisted pair crossover cable.

With the switch in the UP position, the RPM-TP port is used for cascaded and up-link connections (i.e.: a connection to another repeater or hub or concentrator typically.) When used for segments going to workstations and other user device connections, the MDI-X switch should be in the DOWN position.

The RPM-TP will support 10BASE-T unshielded twisted pair wiring (UTP) environments with maximum segment distances up to 100m (325 ft.), or shielded twisted pair wiring (STP) of 150m (500 ft.). This module is designed with internal transceiver functionality. The RPM-FST has LINK, PART, and RX LEDs.

Important Note: For the RPM-TP MDI-X Crossover Switch -
DOWN(or Right) for workstations and user connections.
UP (or Left) for Up-Link connections to other hubs, etc.

(To help recall the right TP switch position, remember "up for up-link" !)

The RJ-45 pins normally (TP crossover switch DOWN) are per the standard for hubs-to-users twisted pair wiring: 1 = receive+, 2 = receive-, 3 = transmit+, 6 = transmit-, other pins not used. When the TP crossover switch is UP, the pins of the RJ-45 port are per the standard for up-links using twisted pair wiring, i.e., the transmit and the receive pairs are exchanged: 1 = transmit+, 2 = transmit-, 3 = receive+, 6 = receive-, other pins not used.

4.2.8 BPM-BNC

The Magnum BPM-BNC bridge module is equipped with a standard 10BASE2 coax BNC connector. This BPM is self-learning and filters and forwards packets at full Ethernet wire speed. This module is used for 10BASE2 connections and is designed to isolate the local segment (i.e., the local nodes connected to the Magnum unit housing the BPM internally) from the connecting network (i.e., the nodes of external users and devices connected through the BPM's media connector).

The BPM-BNC module is designed with a special switch -selectable internal termination function that eliminates the need for a "tee" connector and a 50 ohm terminator. For switch details, refer to the RPM-BNC section, 3.2.1

The BPM-BNC module includes an FWD-I LED and an FWD-X LED, which are visible from the front. The FWD-I LED blinks GREEN to indicate that packets are being forwarded INTO the local Magnum hub or stack.. The FWD-X LED blinks GREEN to indicate that packets are being forwarded OUT of the local Magnum hub or stack.

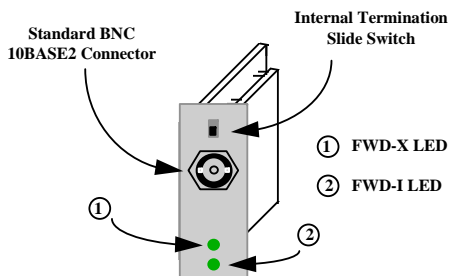

Magnum BPM-BNC

4.2.9 BPM-AUI

This local-bridge module is equipped with a 15 pin female AUI connector and a slide-lock. It is self-learning and filters and forwards packets at full Ethernet wire speed. It is used to provide segment isolation from a 10BASE5 (ThickNet) backbone or any AUI segments. A transceiver is required when connecting to a ThickNet segment and the BPM-AUI supports this convention.

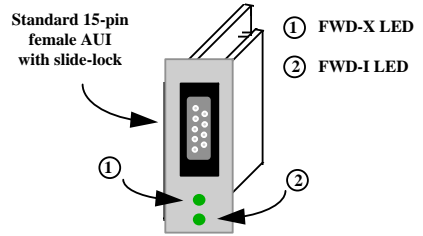

Magnum BPM-AUI

The BPM-AUI card is equipped with one FWD-I LED and one

FWD-X LED, which are identical to those of the BPM-BNC (Section 2.2.7).

The RPM-AUI connector supports standard IEEE signals, which are summarized in Table 3.2.2 of Section 3.2.2.

4.2.10 BPM-FST

The Magnum BPM-FST is a multi-mode fiber optic local-bridge module equipped with a dual ST-type connector. It is self-learning and filters and forwards packets at full Ethernet wire speed. When used for 10BASE-FL segments, this module supports fiber optic transmission distances up to 2000m. For FOIRL applications, it supports fiber segments of up to 1000m in length. The BPM-FST includes full transceiver functionality and does not require an external

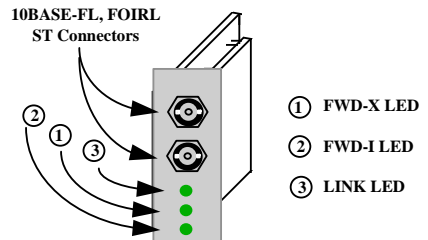

Magnum BPM-FST

transceiver device. The BPM-FST has three status LEDs. FWD-I and FWD-X are identical to those of the BPM-BNC (Section 2.2.7). In addition, this module has a GREEN LINK LED, that is always on when the attached fiber link is operational.

4.2.11 BPM-TP

The Magnum BPM-TP card is equipped with a single RJ-45 connector and supports Ethernet twisted pair segments of any standard length. The RJ-45 connector is shielded to minimize emissions and will allow both unshielded twisted pair (UTP) and shielded twisted pair (STP) segment connections.

The BPM-TP module is also equipped with a Media Dependent Interface-Crossover (MDI-X) slide switch to allow for cascaded connections. This feature eliminates the need for a special twisted-pair crossover cable. For MDI-X switch details, refer to the RPM-TP section, 3.2.7.

The BPM-TP will support 10BASE-T unshielded twisted pair wiring (UTP) environments with maximum segment distances up to 100m (325 ft.), or shielded twisted pair wiring (STP) of 150m (500 ft.). This module is designed with internal transceiver functionality. The LINK, FWD-I, and FWD-X LEDs of this BPM are the same as those of the BPM-FST (Section 3.2.10).

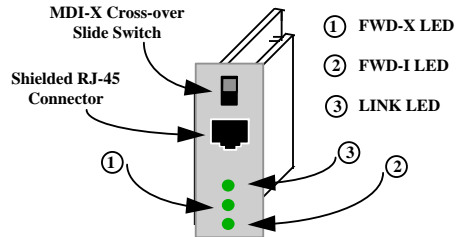

Magnum BPM-TP

5.0 Introduction - Simple Network Management Protocol (SNMP) Agents

This chapter describes the Magnum 3000 SNMP agent products.

5.1 SNMP Agents Description

There are two configuration options (versions) of the Magnum SNMP hardware agent. Both versions follow standard MIB I and MIB II protocol conventions.

In one version, the Magnum SNMP agent is offered as an embedded board (Model 3000-MB) which resides directly within the Magnum 3024 or 3012 box. In the alternate version, the Magnum SNMP agent board is available in a separate box (Model 3000-AGT) that is the same size as a 3024 or 3012 unit, and has its own internal power supply and Inter Repeater Bus (IRB) connections to fit it into a Magnum 3000 stack. The "MB" version is ideal for agents that are part of the initial configuration, and for the smaller stacks and single-unit systems. The "AGT" version is convenient for field additions of the SNMP agent option and for large stacks.

Magnum SNMP agents support all standard basic SNMP commands (GetRequest, GetNextRequest, GetResponse, SetRequest and Trap), and allow monitoring and changing of the target device's configuration and parameters as well as reporting the device alarms from a network management station.

5.1.1 Embedded SNMP Agent, Model 3000-MB

The embedded Magnum SNMP agent is a daughter board that is directly attached to the master printed circuit board inside each Magnum 3012 or 3024 unit. The embedded agent essentially consists of an embedded computer configuration built around a 386 CPU, and is designed with an interface to the Inter-Repeater-Bus (IRB). This allows all units within a Magnum stack to be managed from a single SNMP agent via the IRB that interconnects the stack.

The embedded agent board is equipped with an externally accessible 9-pin RS-232 serial connector, referred to as "P1". This connector may be used to set the IP address and configuration files of the Magnum agent if necessary.

EPROMs on the agent board contain fixed data and program firmware. The Standard Repeater MIB (MIB I & MIB II) and the Monitor and Address Tracking MIB

extensions data are in this firmware. The firmware in the EPROMs performs the data collection and execution functions, and operates as the local controller and interface to the network manager.

5.1.2 Separate Agent Box, Model 3000-AGT

The Magnum 3000 SNMP Agent Box operates the same as the embedded board agent. It is packaged as a separate unit, enclosed in a box that is the same dimensions as a 3024 or 3012 so that it fits neatly into a Magnum 3000 stack. It is a complete modular unit with its own internal auto-ranging power supply.



Figure 5.1a: Magnum 3000 Agent Box, Model 3000-AGT, Front View

The Magnum 3000-AGT agent box is connected into a stack by the Inter-Repeater Bus (IRB). There are two IRB connectors at the right-rear, permitting the agent box unit to be installed at the bottom or top of a stack using one IRB connector, or to be inserted into the middle of a stack using two IRB connectors. The IRB cable connectors are made with "notches / keys" to insure a proper connection.

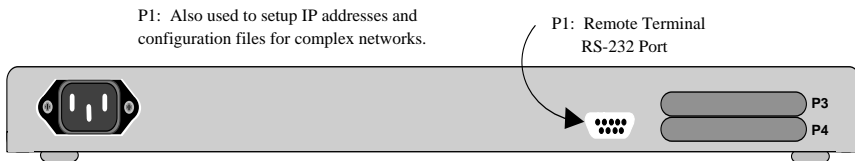

Figure 5.1b: Magnum 3000 Agent Box, Model 3000-AGT, Rear View

The agent logically resides on the IRB and will not be visible to network management software packages as a separate port or user. For network integrity, the agent is designed so that it cannot be disconnected by network managers accidentally or purposefully. Similarly, the agent operates in the stack attached to the IRB and does not need to use a port in any attached Magnum 3000 unit to be connected.

5.1.3 Standard Repeater MIB and Extensions

Both the Magnum 3000-MB and 3000-AGT SNMP Agents are in compliance with MIB1, MIB2, and the RFC 1368 Standard Repeater MIB, and fully support all Repeater MIB functionality as defined by IEEE 802.3 specifications. In addition to the basic Standard Repeater MIB, the Magnum 3000 SNMP Agents include the Port Monitor and Port Address Tracking MIB extensions. Magnum SNMP Agents also comply with RFC 1155-SMI, RFC 1212, RFC 1213-MIB, and RFC 1215.

The completeness of the Magnum SNMP Agents allows for in depth network statistics generation and monitoring by LAN manager software products. While the basic Standard Repeater MIB only provides repeater statistics, the MIB Monitor extensions allow for individual port statistics, including readable frames and octets, FCS errors, alignment errors, runts, collisions, as well as other performance-related port conditions. These MIB Monitor extensions can prove helpful as diagnostics in many ways, such as understanding why a port is not receiving packets.

The Magnum SNMP Agents' Address Tacking MIB extensions allow the LAN manager to poll for the source address of the most recent packet received on an individual port, as well as the number of times the source of the port's packets has changed. This feature is useful in the compilation of network traffic statistics, since the LAN manager is able to see not only how many frames were received, but also where they came from. (This may be very helpful in determining the need for local segment isolation by means of a local bridge or BPM.)

Most SNMP network management software packages (including Castle Rock's "SNMPc" product) allow both the standard repeater and enhanced port statistics to be viewed as a graph, chart or table.

In addition to statistics compilation, Magnum SNMP Agents also allow the LAN manager software to remotely disable ports if necessary. For example, it may be necessary to temporarily remove ports from the network, such as during network testing. With the Magnum SNMP Agents Standard Repeater MIB commands, this can easily be accomplished through the LAN manager software.

A list of specific commands supported by the Magnum SNMP agent appears in Table 5.1.3.

Table 5.1.3: Magnum SNMP Agent Commands

<u>Variable</u>	<u>Type</u>
Repeater ID	ATTRIBUTE GET
Repeater Group Capacity	ATTRIBUTE GET
Group Map	ATTRIBUTE GET
Repeater Health State	ATTRIBUTE GET
Repeater Health Text	ATTRIBUTE GET
Repeater Health Data	ATTRIBUTE GET
Transmit Collisions	ATTRIBUTE GET
Reset Repeater	ACTION
Execute Non disruptive self Test	ACTION
Repeater Health	NOTIFICATION
Repeater Reset	NOTIFICATION
Group Map Change	NOTIFICATION
Resource Type ID Name	ATTRIBUTE GET
Resource Info.	ATTRIBUTE GET
Group ID	ATTRIBUTE GET
Group Port Capacity	ATTRIBUTE GET
Port Map	ATTRIBUTE GET
Port Map Change	NOTIFICATION
Port ID	ATTRIBUTE GET
Port Admin. State	ATTRIBUTE GET
Auto Partition State	ATTRIBUTE GET
Collisions	ATTRIBUTE GET
Readable Frames	ATTRIBUTE GET +
Readable Octets	ATTRIBUTE GET +
Frame Check Sequence Error	ATTRIBUTE GET +
Alignment Error	ATTRIBUTE GET +
Frame Too Long	ATTRIBUTE GET +
Short Events	ATTRIBUTE GET +
Runts	ATTRIBUTE GET +
Late Events	ATTRIBUTE GET +
Very Long Events	ATTRIBUTE GET +
Data Rate Mismatches	ATTRIBUTE GET +
Last Source Address	ATTRIBUTE GET +
Source Address Changes	ATTRIBUTE GET +
Auto Partitions	ATTRIBUTE GET
Port Admin. Control	ACTION

note: “+” indicates a statistic added via MIB extension

5.2 Installation, General Information

The Magnum SNMP agent is an option with the Magnum 3000 Stackable Hubs and Concentrators. The SNMP embedded agent, Model 3000-MB, will be configured and tested as part of a Magnum 3000 stack or single unit at the factory when specified at the time of order. In order to satisfy network growth and changing network requirements, Magnum 3000 Stackable Hubs may also be upgraded in the field with the addition of a Magnum SNMP agent box such as Model 3000-AGT.

With either of the two agent implementations, the agent's operation and performance is the same. The selection of the desired version is entirely a function of user preference. For one Magnum 3000 stack (which may be from one to twenty units, and may be any combination of 3024 and 3012 units), only one SNMP agent is required, and only one SNMP agent may be in use at any given time.

5.3 Installing the Embedded Agent Board, "MB"

The embedded agent board, Model 3000-MB, is normally factory installed.

The procedure for installing the Magnum 3000-MB in the field is a moderately complex process. (To avoid complex field installation and test procedures, it is recommended that a Magnum 3000-AGT agent box unit be chosen and added to the existing stack when a field upgrade from non-managed to embedded-agent-managed is desired).

The following step-by-step procedure should be followed to properly install the Magnum SNMP embedded agent board.

STOP!!!

**Be sure the power cord is unplugged
from the chassis before attempting to remove
and/or replace an RPM card.
Failure to do so may result in damage to the unit
and will void the warranty.**

Step 1. Remove Chassis Cover of the hub

The chassis cover is made in one piece, forming the top and the front of the unit. There are 7 screws located on top and 3 on the front of the unit as shown below. Remove these screws. Once these are removed, the chassis cover/front is easily lifted forward and off of the chassis base. (See Figure 5.3a).

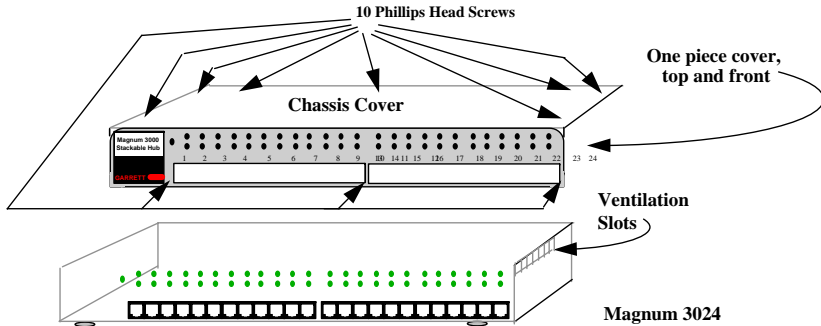

Figure 5.3a: Removing Magnum 3024 / 3012 Chassis Cover

Step 2. Insert the Agent Board (Magnum 3024 and 3012 Hubs)

Looking down into the Magnum 3024 or 3012 hub as shown in the illustration Figure 4.3c below, the Embedded Agent Board mounts on top of the other printed circuit boards in the left-rear area of the unit. Three screws with stand-offs hold it firmly in place in the correct position.

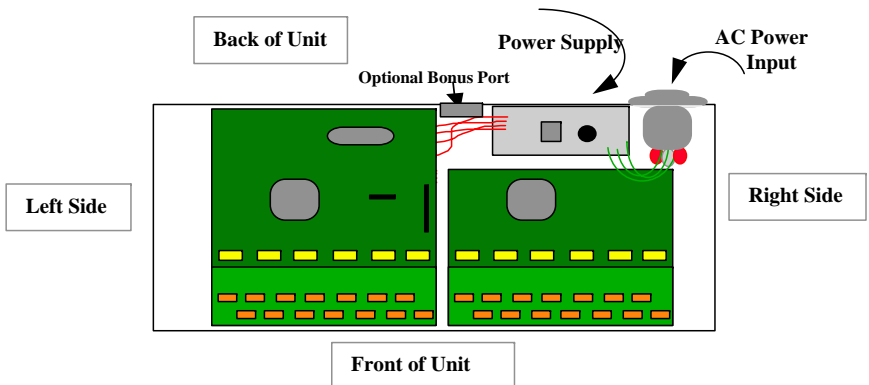

Figure 5.3b: Magnum 3024, Top View with Cover Off

The Magnum SNMP embedded agent daughter board, Figure 4.3d, connects into the DB-9 connector "P1" on the back of the Magnum 3000 unit with a cable, and

plugs into the main board and into the power supply with other assorted cables. The exact type and number of cables and connectors for this installation varies depending upon the vintage of the hub unit being upgraded. Kits may sometimes be available from GCI's Spare Parts List with parts and instructions to suit the different unit revs. Consult with GCI Tech Support for additional information.

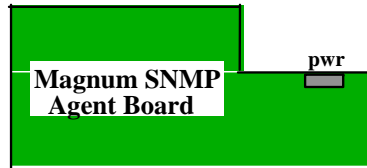

Figure 5.3c: Embedded Agent Board

If in doubt about the vintage of your 3012 upgrade candidate, use the "AGT" box model for the upgrade.

Step 3. Set Group # (Stack) Address - Magnum 3024/3012

On the back of Magnum 3000 Stackable hubs is an eight position DIP switch. The first six positions are used to identify each unit in binary code as a Group # address. Switches 7 and 8 are not used.



Figure 5.3d, Magnum 3024 and 3012, Rear View

For managed stacks, the unit configured with the embedded SNMP agent in it should be set to the # 1 Group address. The "AGT" agent box unit, if used in a stack, has no Group # address itself. See also Table 4.3 and Section 2.3.2, "Group # Address Switch Settings".

From the perspective of the network manager, the Magnum SNMP agent board or box is not visible as a separate user or port. It cannot be disabled either accidentally or purposefully. This prevents the agent itself from being disconnected, causing an irreversible loss of control of the entire stack from the network manager.

Table 5.3: Eight-Position DIP Switch Configuration Table

address\switch	1	2	3	4	5	6
1	on					
2		on				
3	on	on				
4			on			
5	on		on			
6		on	on			
7	on	on	on			
8				on		
9	on			on		
10		on		on		
11	on	on		on		
12			on	on		
13	on		on	on		
14		on	on	on		
15	on	on	on	on		
16						on
17	on					on
18		on				on
19	on	on				on
20			on		on	

- **The Group # Address is used by the network manager** to distinguish among the physical units that are combined (or grouped) in the stack to operate as one repeater managed by one SNMP agent. The NMS display will show the stack units arranged in sequence according to the Group #. (The SNMP standard defines the term "Group #" for data collection and control operations.)

It is desirable to use Group Address # 1 for the Magnum 3024 or 3012 unit which houses the embedded agent.

- **Switch # 7 and Switch # 8 are not used.**

See also Section 2.3.3, Address Switch Settings, for further information on this topic.

5.4 Agent Configuration, Embedded Agent and Agent Box Versions

The SNMP Agent software resides in ROM chips on the hardware agent board. After power up, the software begins a number of tests that check the system for normal

operations: CPU test, EPROM CRC test, DRAM test, Network Interface Controller test and NVRAM test.

During the configuration process, an ANSI compatible terminal or a PC running ANSI terminal emulation software should be connected (through a null modem cable) to the serial port "P1" located on the rear panel of the Magnum 3000 unit. The terminal characteristics should be set to: 9600 Baud, 8 bit data, no parity, 1 stop bit.

If the agent board (either embedded in a unit, or in a box by itself) is operating properly, the following (example) message will appear on the terminal screen:

Performing Self Diagnostics . . .	(pause for 30 to 60 seconds typically)
Garrett Communications Embedded Agent Version 02.05	(example)
Processor 3003 Controller 14 Ethernet Controller 30003003	(example)
Ethernet address 00 00 1A 18 0E 18 IP address 45.9.0.5	(example)

5.4.1 Automatic Agent IP Address Configuration.

At power up, the agent software program will search for an IP address in NVRAM. A legitimate IP address is set into the NVRAM at the factory, permitting the unit or stack when new to automatically go into operation as a stand-alone network.

For more complex networks where the IP address is to be set from a server on an existing network, set the NVRAM IP address to a blank using the procedure in "Function Listing, Address" below. Then, at power up when the agent software program does not find an IP address, it will try to get configuration information from a boot server by using the BOOTP protocol. If this attempt fails, it will try RARP protocol. This process may require up to one minute.

Next, the agent automatically determines the configuration of the Magnum 3000 stack by reading the group # addresses of all of the units in the stack. The stacked units, from one to twenty in number which operate as one repeater, will have one repeater agent and its IP address. (Note that a group # address should be set for each unit by using switches on the back of each unit. See Section 4.3, Table 4.3.

5.4.2 Manual IP Address Configuration.

If the network does not support BOOTP or RARP, or if you need to manually change the agent's IP address to a user-specified address, it can be done from a terminal (see 4.4 above) connected to the serial port P1 on the back of the Magnum 3000 unit containing the embedded agent, or to P1 on the agent box.

From the top menu prompt > , type: **C {Cr}**.

On the terminal, the prompt will appear: **CFG>**

The agent configuration menu consists of the following commands:

ADDRESS
BOOTP
COMMUNITY
DISPLAY
GATEWAY
MANAGER
NAMESERVER
SUBNETMASK
EXIT

To see a command selection menu, type: **help {Cr}**. On the terminal screen, a menu with command lines and the meaning of each command will appear:

A[DDRESS] [IP/ NAME]	IP address
B[OOTP] [IP/NAME]	Bootp Server
C[OMMUNITY] [# [NAME[S] [MANAGER....]]]	Communities access:
	S - Allow Set operations
	Managers - list of IP addresses and/or names
D[ISPLAY]	Display whole configuration
E[XIT]	Exit configuration
G[ATEWAY] [# [IP [SUBNETIP [MASKIP]]]]	Gateways
M[ANAGER] [# [IP/NAME [PORT] COMMUNITY]]	Managers
N[AMESERVER] [# [IP/NAME]]	Name Servers
S[UBNETMASK] [IP]	Subnet mask

(end of "terminal screen" illustration)

Command or Function Listing

1. ADDRESS:

A[DDRESS] [IP/ NAME]

The "Address" command is used to define and/or display an agent's IP address.

To set an IP address, type: **A [address value] {Cr}**
 (Example: **>A 45.9.0.38 {Cr}**)

To display the current IP address, type: **A{Cr}**

2. BOOTP

B[OOTP] [IP/NAME]

Used to define or display the IP address and/or name of your BOOTP server.

To set, type: **B [address value/name] {Cr}**
 (Example: **>B 45.9.0.171**)

3. COMMUNITY**C[COMMUNITY] [# [NAME [S] [MANAGER....]]]**

Used to set the community string for GET and SET operations.

-- number of community. (Up to 10 different communities may be set)

S -- allow SET operations. (If you do not "S" this command, this community will allow only GET operations)

MANAGER -- the network manager IP addresses list, up to 10. (If the manager IP addresses list is not present in a command line, any network manager can communicate with this agent using this community string)

Example of two managers: **>C 3 MAGNUM S 45.9.0.122 45.9.1.3{Cr}**

To display community, type: **C{Cr}**

To delete community, type: **C [#] {Cr}**

3. DISPLAY

To display the whole configuration file, type: **D{Cr}**

Example: **>D{Cr}** (All configuration information will appear)

4. EXIT

To exit from the configuration menu, type **E{Cr}**

Example: **>E{Cr}**

5. GATEWAY**G[ATEWAY] [# [IP [SUBNETIP [MASKIP]]]]{Cr}**

Used to set the gateway IP address and mask. Up to 10 gateways may be set.

Example: **>G 3 45.9.0.112 255.255.255.0 255.0.0.0{Cr}**

6. MANAGER**M[ANAGER] [# [IP/NAME [PORT] COMMUNITY]]]**

Used to set the number of network manager IP addresses, and the community to which

TRAPS should be sent. Up to 10 managers may be set. If "PORT" is absent, then

TRAPS are sent to port 162, as specified in RFC 1157. If "COMMUNITY" is absent, the community string "public" is used by default.

Example: **M 2 45.9.1.125 Magnum{Cr}**

7. SUBNETMASK**S[UBNETMASK] [IP]{Cr}**

To set IP mask, type: **S [mask value] {Cr}**

Example: **>S 255.255.255.0 {Cr}**

NOTE: After entering information using the commands above, to make the new configuration operative, exit from the configuration menu by typing: E {Cr}. If the agent's IP address has been changed, reset the agent (via a unit power down) to install the change.

After new subnet configuration information is set in operation, it will reside in NVRAM. Powering down the Magnum 3000 will not destroy it, and at power up the agent will read the configuration information from NVRAM and start operations with it.

5.4.3 Other Convenience Commands

From the top menu, one can also set the time and date. The time and date do NOT reside in NVRAM and will be lost at power down. **From the prompt, type:**
T [mm/dd/yy] [hh:mm] {Cr}

Example: **>T 11/12/93 11:45 {Cr}** sets the date and (military) time.

To display the version and Ethernet physical address, from the prompt, type: **V {Cr}**
On the terminal, a message with version number and information about the processor, system controller, Ethernet controller, and physical Ethernet address will appear in response.

Example: **>V{Cr}**
Garrett Communication Embedded Agent Version 01.01
Processor 3003 Controller 13
Ethernet Controller 30003003 Ethernet address 00 00 1A 18 0E 05
>

6.0 TROUBLESHOOTING

All Magnum Ethernet products are designed to provide reliability and consistently high performance in all network environments. The installation of Magnum 3000 Stackable Hubs is a straightforward procedure (see **INSTALLATION**, Section 2.6); the operation is also straightforward and is discussed in Section 4.

Should problems develop during installation or operation, this section is intended to help locate, identify and correct these types of problems. Please follow the suggestions listed below prior to contacting your supplier. However, if you are unsure of the procedures described in this section or if the Magnum 3000 product (3024 or 3012) is not performing as expected, do not attempt to repair the unit; instead contact your supplier for assistance or contact GarrettCom Customer Support.

6.1 Before Calling for Assistance

1. If difficulty is encountered when installing or operating the unit, refer back to the Installation Section of the applicable chapter of this manual. Also check to make sure that the various components of the network are interoperable.
2. Check the cables and connectors to ensure that they have been properly connected and the cables/wires have not been crimped or in some way impaired during installation. (About 90% of network downtime can be attributed to wiring and connector problems.)
3. Make sure that an AC power cord is properly attached to each Magnum 3000 unit. Be certain that each AC power cord is plugged into a functioning electrical outlet. Use the PWR LEDs to verify each unit is receiving power.
4. If the problem is isolated to a network device other than the Magnum 3000 product, it is recommended that the problem device is replaced with a known good device. Verify whether or not the problem is corrected. If not, go to Step 5 below. If the problem is corrected, the Magnum 3000 and its associated cables are functioning properly.
5. If the problem continues after completing Step 4 above, contact your supplier of the Magnum 3000 unit or if unknown, contact GarrettCom, Inc. by fax, phone or email (support@garrettcom.com) for assistance.

6.2 When Calling for Assistance

Please be prepared to provide the following information.

1. A complete description of the problem, including the following points:
 - a. The nature and duration of the problem;
 - b. Situations when the problem occurs;
 - c. The components involved in the problem;
 - d. Any particular application that, when used, appears to create the problem;
2. An accurate list of GarrettCom product model(s)involved, with serial number(s). Include the date(s) that you purchased the products from your supplier.
3. It is useful to include other network equipment models and related hardware, including personal computers, workstations, terminals and printers; plus, the various network media types being used.
4. A record of changes that have been made to your network configuration prior to the occurrence of the problem. Any changes to system administration procedures should all be noted in this record.

6.3 Return Material Authorization (RMA) Procedure

All returns for repair must be accompanied by a Return Material Authorization (RMA) number. To obtain an RMA number, please use this URL - https://rma.garrettcom.com/rma/rma_request_noaccount.php to fill out the form. Please have the following information readily available:

Name and phone number of your contact person.
Name of your company / institution
Your shipping address
Product name
Serial Number (or Invoice Number)
Packing List Number (or Sales Order Number)
Date of installation
Failure symptoms, including a full description of the problem.

GarrettCom will carefully test and evaluate all returned products, will repair products that are under warranty at no charge, and will return the warranty-repaired units to the sender with shipping charges prepaid (see Warranty Information, Appendix A, for complete details). However, if the problem or condition causing the return cannot be duplicated by GarrettCom, the unit will be returned as:

No Problem Found.

GarrettCom reserves the right to charge for the testing of non-defective units under warranty. Testing and repair of product that is not under warranty will result in a customer (user) charge.

6.4 Shipping and Packaging Information

Should you need to ship the unit back to GarrettCom, please follow these instructions:

1. Package the unit carefully. It is recommended that you use the original container if available. Units should be wrapped in a "bubble-wrap" plastic sheet or bag for shipping protection. (You may retain all connectors and this Installation Guide.)

CAUTION: Do not pack the unit in Styrofoam "popcorn" type packing material. This material may cause electro-static shock damage to the unit.

2. Clearly mark the Return Material Authorization (RMA) number on the outside of the shipping container.
3. GarrettCom is not responsible for your return shipping charges.
4. Ship the package to:

GarrettCom, Inc.
47823 Westinghouse Dr.
Fremont, CA 94539-7437
Attn.: Customer Service

APPENDIX A: WARRANTY INFORMATION

GarrettCom, Inc. warrants its products to be free from defects in materials and workmanship for a period of three (3) years from the date of shipment by GarrettCom.

During this warranty period, GarrettCom will repair or, at its option, replace components in the products that prove to be defective at no charge other than shipping and handling, provided that the product is returned pre-paid to GarrettCom.

This warranty will not be effective if, in the opinion of GarrettCom, the product has been damaged by misuse, misapplication, or as a result of service or modification other than by GarrettCom.

GarrettCom reserves the right to make a charge for handling and inspecting any product returned for warranty repair which turns out not to be faulty.

Please complete the warranty card as this acts as a product registration, and mail it to GarrettCom within two weeks of your purchase.

APPENDIX B : Internal DC Power Supply Option

B1.0 SPECIFICATIONS - FOR MAGNUM 3000S

Power Supply (Internal -48VDC Option)

DC Power Connector: 3 terminals: “-“, “GND”, “+”

Input Voltage: 36 - 70 VDC

Power Consumption: Model **3024 NEBS**: 18 watt typical, 30 watts max.

Power Consumption: Model **3012 NEBS**: 10 watt typical, 20 watts max.

Power Supply (Internal 24 VDC Option) Industrial Application

DC Power Connector: 3 terminals: “-“, “GND”, “+”

Input Voltage: 20 - 36 VDC

Power Consumption: Model **3024 NEBS**: 18 watt typical, 30 watts max.

Power Consumption: Model **3012 NEBS**: 10 watt typical, 20 watts max..

Power Supply (Internal 125 VDC Option) Industrial Application

DC Power Connector: 3 terminals: “-“, “GND”, “+”

Input Voltage: 120 - 160 VDC

Power Consumption: Model **3024 NEBS**: 18 watt typical, 30 watts max.

Power Consumption: Model **3012 NEBS**: 10 watt typical, 20 watts max.

With the exception of the power supply, all specifications and functions of Magnum 3000s-48VDC, 24VDC and 125VDC models are identical to those listed in the main manual.

B2.0 -48VDC, 24VDC & 125VDC POWER OPTION, THEORY OF OPERATION

The -48VDC, 24VDC & 125VDC power options are designed using diodes inside on each DC power input line behind the two external power connection terminals,

so that the power from an external source can only flow into the hub.

This allows the 3000s to operate only whenever DC power is correctly applied to the two inputs. It protects

the 3000s from incorrect DC input connections. An incorrect polarity connection, for example, will neither affect the 3000s, its internal power supply, nor will it blow the fuse in the internal power supply.

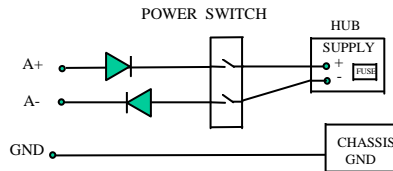

The manual power “On-Off” Switch (optional) is used for powering the unit on and off when it is placed into or taken out of service.

B3.0 APPLICATIONS FOR DC POWERED HUBS

Magnum 3000's are easily installed in a variety of applications where -48VDC, 24VDC & 125VDC power is used as the primary power source. The- 48VDC, 24VDC & 125VDC power configuration provides an Ethernet networking solution utilizing a special power supply in hubs with a proven track record.

The -48VDC solution is particularly useful in the telecommunication industry, where it is common for facilities to operate on -48VDC power. Such companies include regular and wireless telephone service providers, Internet Service Providers (ISPs) and other communication companies. In addition, many high availability equipment services, such as broadcasters, publishers, newspaper operations, brokerage firms and other facilities often use a battery backup system to maintain operations in the event of a power failure. It is also frequently used for computer system backup, management and operations monitoring equipment.

The 24VDC & 125VDC solution are particularly useful in the Industrial environment, where it is common for facilities to operate on 24VDC or 125VDC power. The 125VDC solution is mainly used in power utilities, such as electrical substations, electrical generating plants, etc. The 24VDC applications are mainly in the Industrial environment, such as factory floor, HVAC equipment, military equipment, etc.

B4.0 INSTALLATION

This section describes the installation of the -48 VDC, 24VDC & 125VDC power source leads to the -48 VDC, 24VDC & 125VDC power terminal block on the Magnum 3000 hubs. (see figure at right).

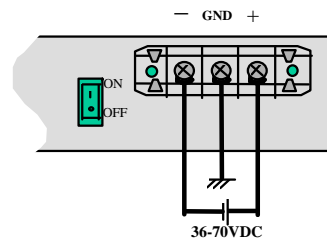

Figure B4.1: -48VDC Terminal Block on Magnum 3000 hubs

In this picture, the -48VDC terminal block on the Magnum 3000s is located on the rear of the unit and is equipped with three (3) screw-down lead posts. It is similar for 24VDC and 125VDC options on the Magnum 3000s. The leads are identified as negative (-), positive (+), and chassis ground (GND).

The actual connection procedure is very straightforward. Simply connect the leads to the Magnum unit, beginning with ground. Ensure that each lead is securely tightened.

Note: The GND should be hooked up first. The 3000s unit has a floating ground, so the user may elect to Ground either + or = terminal to suit the customer's use.

Before connecting hot lines to the Terminal Block of -48VDC, 24VDC or 125VDC, always use a digital voltmeter to measure the output voltage of the power supply and determine the lead which is more "+ve potential". The more "+ve" voltage lead from 48V or -48V supply must be connected to the post labeled "+".

An ON-OFF manual switch is optional for DC power. This can be used in to cut off power connections and as a RESET for the Hub and / or SNMP Management Agent.

B4.1 UL Requirements

1. *Minimum 14 AWG cable for connection to a Centralized DC power source.*
2. *Fastening torque of the lugs on the terminal block: 9 inch pound max.*
3. *Centralized DC Power Source cable securement, use at least four cable ties to secure the cable to the rack at least 4 inches apart with the first one located within 6 inches of the terminal block.*
4. *Disconnect Device Statement - Statement indicating that a readily accessible disconnect device shall be incorporated in the building installation wiring. (Instruction).*
5. *This product shall be provided with a Listed fuse or circuit breaker, rated 5 A, in the supply circuit when connected to a 48 V centralized dc source.*

B5.0 OPERATION

Operation of the Magnum 3000s with the optional -48VDC, 24VDC & 125VDC power supply is identical to that of the AC-powered models.

B6.0 ORDERING INFORMATION

To order the optional -48VDC power supply factory installed, add a suffix of “-48VDC” after the products standard model # Example: **Magnum 3012-48VDC**.

Similarly, to order the optional 24VDC or 125VDC industrial specific power supply factory installed, add a suffix of “-24VDC” or “-125VDC” after the product’s standard model #. Example: **Magnum 3024-24VDC**, or **3012-125VDC**.

B7.0 TROUBLESHOOTING Please refer to Section 6.0**APPENDIX C : Internal DC Dual-Source Power Option****C1.0 SPECIFICATIONS - FOR MAGNUM 3000S HUBS****Power Supply (Internal, -48VDC Dual-Source, model # Dual-Src-48V)**

DC Power Connector: First Source: “A+”, “A-“, 2nd Source “B-“, “B+”
 GND: Terminal for “earth” or ground wire connection to the hub chassis
 Input: Two separate sources, each at 36 - 70 VDC
 Power Consumption: Model **3024 NEBS**: 18 watt typical, 30 watts max.
 Power Consumption: Model **3012 NEBS**: 10 watt typical, 20 watts max..

Power Supply (Internal, 24VDC Dual-Source, model # Dual-Src-24V)

DC Power Connector: First Source: “A+”, “A-“, 2nd Source “B-“, “B+”
 GND: Terminal for “earth” or ground wire connection to the hub chassis
 Input: Two separate sources, each at 20 - 36 VDC
 Power Consumption: Model **3024 NEBS**: 18 watt typical, 30 watts max.
 Power Consumption: Model **3012 NEBS**: 10 watt typical, 20 watts max..

Power Supply (Internal, 125VDC Dual-Source, model # Dual-Src-125V)

DC Power Connector: First Source: “A+”, “A-“, 2nd Source “B-“, “B+”

- GND: Terminal for “earth” or ground wire connection to the hub chassis
 Input: Two separate sources, each at 120 - 160 VDC
 Power Consumption: Model **3024 NEBS**: 18 watt typical, 30 watts max.
 Power Consumption: Model **3012 NEBS**: 10 watt typical, 20 watts max..

With the exception of the dual DC input power connections and the power supply, all specifications and configuration options for the Magnum 3000s -48VDC with this Dual-Source option are identical to those listed in the *Magnum 3000's Installation and User Guide*, including Appendix B “Internal DC Power Supply Option”

C2.0 Magnum 3000 hubs with -48VDC, 24VDC & 125VDC Dual-Source option

The 3000s Hub with the internal -48VDC, 24VDC & 125VDC Dual-Source power supply are designed for installations where a battery plant is the power source, and where two separate power sources are utilized in order to increase operational uptime and to simplify maintenance.

The functionality of the Magnum 3000s unit with the -48VDC, 24VDC & 125VDC Dual-Source Option is identical to the standard AC-powered model. Refer to the main sections of this *Installation and User Guide* for a detailed description of the Magnum 3000s units and Configuration options.

C3.0 DUAL-SOURCE OPTION, THEORY OF OPERATION

The Dual-Source DC power option is designed using diodes inside of the chassis on each DC power input line. A diode is placed in each of the four input lines (behind the four external power connection terminals) so that power from an external source can only flow into the unit. This allows the unit to operate whenever DC power is correctly applied to either or both of the two inputs

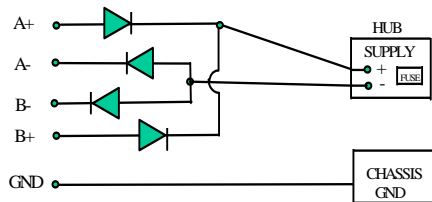

C4.0 FEATURES AND BENEFITS OF THE DUAL-SOURCE DESIGN

- The 3000s unit can receive power from either input, “A” or “B”. The hub will normally draw its power from the DC source with the highest voltage at a given time.
- The 3000s unit will not allow power to flow from a higher voltage input to a lower voltage input, i.e. the two DC power sources are not mixed together by the hub.
- When one correct DC input is present, the 3000s will receive power if the other DC input is absent, or even if it is connected with reverse polarity or shorted or grounded.
- Reverse polarity connections, if they should accidentally occur on either input, will not damage the 3000s or power supply internally (nor will it blow the fuse in the internal power supply) because of the blocking action of the diodes. This is true even if one input connection is reversed while the 3000s is operating from the other source.
- The 3000s will not receive power (and will not work) when both inputs are simultaneously absent or are both incorrectly connected.

C5.0 INSTALLATION

This section describes the proper connection of the -48VDC, 24VDC & 125VDC dual source leads to the -48 VDC, 24VDC and 125VDC power terminal block on the Magnum 3000s (shown in Figure C5.0)

The -48VDC terminal block on the Magnum 3000s, as shown in Fig C5.0 is located on the left rear of the unit and is equipped with five (5) screw-down lead posts. The primary terminals are identified as positive (A+), negative (A-), and the secondary power terminals as negative (B-), positive (B+). The chassis “earth” or ground (GND), is a threaded post with a #6 nut. The Dual source terminal blocks for 24VDC and 125VDC are similar.

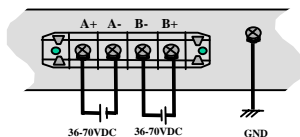

Figure C5.0: -48VDC Dual-Source, wiring connections to the External Terminal Block on a Magnum -48VDC with Dual-Source option

Note: *The GND should be hooked up first. The 3000s unit has a floating ground, so the user may elect to Ground either + or = terminal to suit the customer’s use.*

Before connecting hot lines to the Terminal Block of -48VDC, 24VDC or 125VDC, always use a digital voltmeter to measure the output voltage of the power supply and determine the lead which is more “+ve Potential”. The more “+ve” voltage lead from 48V or -48V Power supply must be connected to the post labeled “+”.

The connection procedure is straightforward. Simply connect the DC leads to the 3000’s power terminals, positive (+) and negative (-) screws. The use of Ground (GND) is optional; it connects to the 3000s chassis. Ensure that each lead is securely tightened.

The 24VDC & 125VDC terminal block on Magnum 3000s is similar to that described in the -48VDC info above.

C5.1 UL Requirements

The following must be adhered to in order to conform to UL requirements:

1. *Minimum 14 AWG cable for connection to a Centralized DC power source.*
2. *Fastening torque of the lugs on the terminal block: 9 inch pound max.*
3. *Centralized DC Power Source cable securement, use at least four cable ties to secure the cable to the rack at least 4 inches apart with the first one located within 6 inches of the terminal block.*

C6.0 ORDERING INFORMATION

To order the optional Dual-Source -48VDC power supply factory installed, order "Dual-Src48V" as a separate line item following the product model.

Example: **Magnum 3012-48VDC**

Dual-Src-48V for the regular dual-source model

or **Dual-Src48V-SWITCH** for the model with the ON-OFF switch.

Similarly to order "Dual-Src24V" or "Dual-Src125V", add it as a suffix following the product model. Also order for Regular or Manual Switch as mentioned above.

Example: **Magnum 3024-24VDC or Magnum 3012-125VDC**

Dual Src24V for regular model with no ON-OFF switch

or **Dual Src125V-SWITCH** for the model with the ON-OFF switch.

C7.0 OPERATION

Operation of the Magnum 3000s units with -48VDC, 24VDC & 125VDC Dual Source options is identical to that of the standard models.

Free Manuals Download Website

<http://myh66.com>

<http://usermanuals.us>

<http://www.somanuals.com>

<http://www.4manuals.cc>

<http://www.manual-lib.com>

<http://www.404manual.com>

<http://www.luxmanual.com>

<http://aubethermostatmanual.com>

Golf course search by state

<http://golfingnear.com>

Email search by domain

<http://emailbydomain.com>

Auto manuals search

<http://auto.somanuals.com>

TV manuals search

<http://tv.somanuals.com>