

Gateway Lite D2B Installation Guide

v1.0



GWL-9211-1

1 Introduction

Gateway Lite emulates a CD changer and uses CD changer controls to access offboard audio sources like iPod and USB devices.

2 Connections

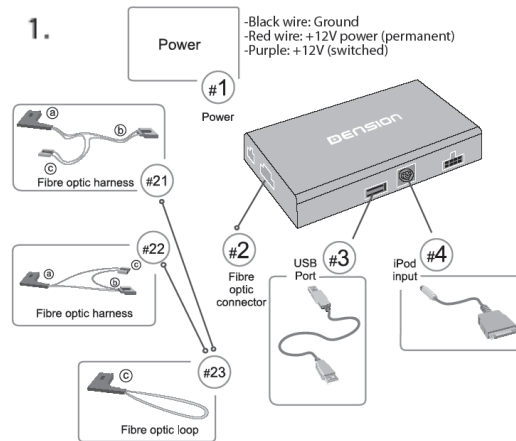

3 Installation

The best place to install the Gateway Lite D2B maybe somewhere behind the dashboard/head unit. Remove the car's head unit from the dashboard according to car manufacturer instructions. If you do not have a CD changer in your car, please make sure that the head unit can control a CD changer (e.g. products light at optical output socket of the head unit.) If not, please refer to an official Mercedes service, where they can easily reprogram the head unit to enable the optical network for Gateway Lite D2B. If you finished this step or you made sure that the car's D2B network can accept a CD changer or a CD Changer exists in your car please do the following.

4 Electrical Installation

(2.) Join the power harness of the Gateway Lite to the radio.

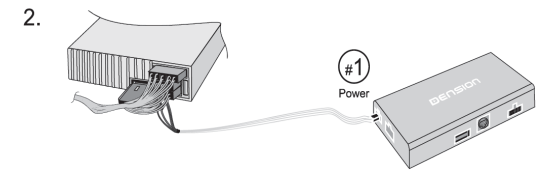

Plug the power cable lead to the Gateway Lite D2B.

The allocation of the #1 cable is the following:
Red: + 12V battery
Black: GND
Purple: wakeup

See the pinout of the Mercedes power harness of different head units.

Audio 10/30

Wakeup (purple)

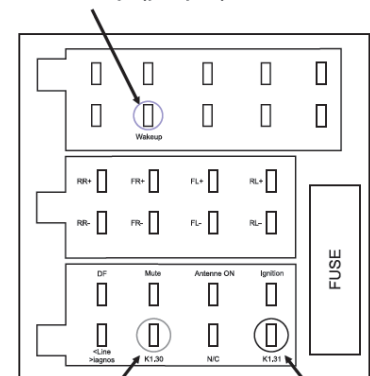

Batt (+12V)
(red)

GND
(black)

5 Electrical Installation

If you have a Comand head unit the socket of the radio is different from the other head units.

Comand 2.0/2.5

Wakeup (purple)

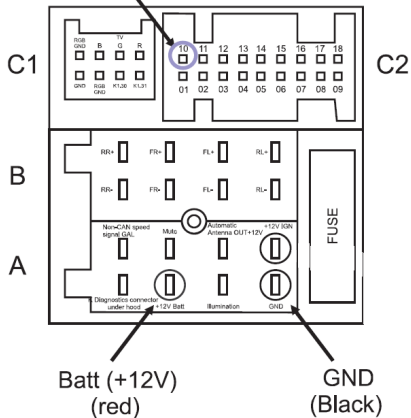

6 Optical Installation

Mercedes cars can have two different layouts of optical network. That is why the D2B optical kit contains two different optical harnesses (labels on them will help). The #22 belongs to the cars with Comand (made by Bosch) head units and #21 to the others.(3. and 4.) Unplug the connector of the optical harness from the head unit and connect it to the #21/22 socket of the optical harness of the Ice>Link Gateway 500. If there is no factory fitted optical cable connected to the Head Unit, you should connect the given #23 optical loop to the spare female connector of the #22 optical cable.

7 Optical Installation

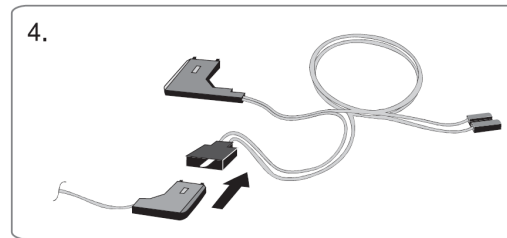
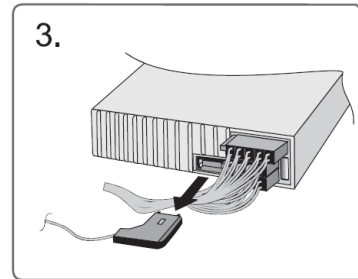

(5.) Connect the #21/22 A connector to the back of head unit.

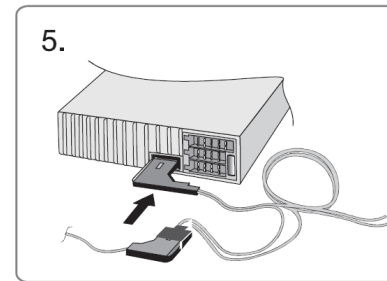

(6.) Plug the last flying connector of your optical harness to the Gateway Lite D2B interface, with this step you are connected to the D2B optical ring.

8 Optical Installation

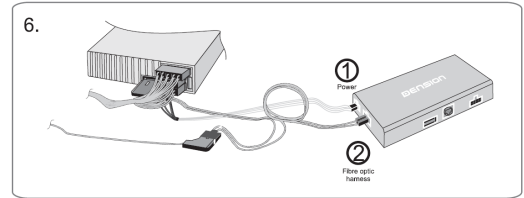

Finally connect each cable according to the numbers in the first picture. Lead away the cables where the devices will be placed. (E.g the glove compartment or the center console).

9 Test and refit

Test the Gateway Lite with your car audio, making sure all connections are correct and that you have full functionality.

Note: If during testing you notice any changes or inconsistencies in the way the car's electrical system operates, disconnect the Gateway product immediately and consult your dealer.

Take care not to trap any wires and cables or the Dension product. Refit is the reversal of the removal process for your specific vehicle, as per your manufacturer's instructions.

All photos/illustrations are for representation purposes only and may differ visually from the equipment in your vehicle. Information correct at time of going to print E. & O. E. Dension Audio Systems Ltd. and it's registered partners cannot be held liable for any damages caused by the incorrect installation of any Dension product.

Need more help?

Please visit: www.dension.com/support

Free Manuals Download Website

<http://myh66.com>

<http://usermanuals.us>

<http://www.somanuals.com>

<http://www.4manuals.cc>

<http://www.manual-lib.com>

<http://www.404manual.com>

<http://www.luxmanual.com>

<http://aubethermostatmanual.com>

Golf course search by state

<http://golfingnear.com>

Email search by domain

<http://emailbydomain.com>

Auto manuals search

<http://auto.somanuals.com>

TV manuals search

<http://tv.somanuals.com>