

2-9975



# Two-Line Answering System User's Guide

2-9975



## FCC REGISTRATION INFORMATION

Your GE telephone equipment is registered with the Federal Communications Commission and is in compliance with parts 15 and 68, FCC Rules and Regulations.

### 1 Notification to the Local Telephone Company

On the bottom of this equipment is a label indicating, among other information, the FCC Registration number and Ringer Equivalence Number (REN) for the equipment. You must, upon request, provide this information to your telephone company.

The REN is useful in determining the number of devices you may connect to your telephone line and still have all of these devices ring when your telephone number is called. In most (but not all) areas, the sum of the RENs of all devices connected to one line should not exceed 5. To be certain of the number of devices you may connect to your line as determined by the REN, you should contact your local telephone company.

#### Notes

- This equipment may not be used on coin service provided by the telephone company.
- Party lines are subject to state tariffs, and therefore, you may not be able to use your own telephone equipment if you are on a party line. Check with your local telephone company.
- Notice must be given to the telephone company upon permanent disconnection of your telephone from your line.

### 2 Rights of the Telephone Company

Should your equipment cause trouble on your line which may harm the telephone network, the telephone company shall, where practicable, notify you that temporary discontinuance of service may be required. Where prior notice is not practicable and the circumstances warrant such action, the telephone company may temporarily discontinue service immediately. In case of such temporary discontinuance, the telephone company must: (1) promptly notify you of such temporary discontinuance; (2) afford you the opportunity to correct the situation; and (3) inform you of your right to bring a complaint to the Commission pursuant to procedures set forth in Subpart E of Part 68, FCC Rules and Regulations.

The telephone company may make changes in its communications facilities, equipment, operations or procedures where such action is required in the operation of its business and not inconsistent with FCC Rules and Regulations. If these changes are expected to affect the use or performance of your telephone equipment, the telephone company must give you adequate notice, in writing, to allow you to maintain uninterrupted service.

## INTERFERENCE INFORMATION

This device complies with Part 15 of the FCC Rules. Operation is subject to the following two conditions: (1) This device may not cause harmful interference; and (2) This device must accept any interference received, including interference that may cause undesired operation.

This equipment has been tested and found to comply with the limits for a Class B digital device, pursuant to Part 15 of the FCC Rules. These limits are designed to provide reasonable protection against harmful interference in a residential installation.

This equipment generates, uses, and can radiate radio frequency energy and, if not installed and used in accordance with the instructions, may cause harmful interference to radio communications. However, there is no guarantee that interference will not occur in a particular installation.

If this equipment does cause harmful interference to radio or television reception, which can be determined by turning the equipment off and on, the user is encouraged to try to correct the interference by one or more of the following measures:

- Reorient or relocate the receiving antenna (that is, the antenna for radio or television that is "receiving" the interference).
- Reorient or relocate and increase the separation between the telecommunications equipment and receiving antenna.
- Connect the telecommunications equipment into an outlet on a circuit different from that to which the receiving antenna is connected.
- Consult the dealer or an experienced radio/TV technician for help.

If these measures do not eliminate the interference, please consult your dealer or an experienced radio/television technician for additional suggestions. Also, the Federal Communications Commission has prepared a helpful booklet, "How To Identify and Resolve Radio/TV Interference Problems." This booklet is available from the U.S. Government Printing Office, Washington, D.C. 20402. Please specify stock number 004-000-00345-4 when ordering copies.

## HEARING AID COMPATIBILITY

This telephone system meets FCC standards for Hearing Aid Compatibility.

FCC NUMBER IS LOCATED ON THE CABINET BOTTOM  
REN NUMBER IS LOCATED ON THE CABINET BOTTOM

# INTRODUCTION

Your GE two-line answering system is designed to give you flexibility in use and high quality performance. We suggest that you take a few minutes right now to read through this User's Guide.

## TABLE OF CONTENTS

<b>GETTING STARTED</b> .....	<b>2</b>
INSTALLATION OPTIONS .....	3
DESKTOP INSTALLATION .....	4
WALL MOUNT INSTALLATION .....	5
SETUP .....	7
SETTING THE VOICE TIME/DAY STAMP .....	8
RECORDING THE OUTGOING ANNOUNCEMENT .....	8
REVIEWING AN OUTGOING ANNOUNCEMENT .....	9
<b>TELEPHONE OPERATION</b> .....	<b>10</b>
PLACING AND RECEIVING CALLS .....	10
REDIAL .....	11
BUSY REDIAL .....	12
HOLD .....	12
CONFERENCE CALLS .....	12
USING THE FLASH BUTTON .....	13
TEMPORARY TONE .....	13
<b>MEMORY DIALING</b> .....	<b>14</b>
STORING A NUMBER IN MEMORY .....	14
REVIEWING AND CHANGING A STORED NUMBER .....	15
DIALING A STORED NUMBER .....	16
<b>ANSWERER OPERATION</b> .....	<b>17</b>
TURNING THE ANSWERER ON AND OFF .....	17
MESSAGE PLAYBACK .....	17
RESETTING THE TAPE (ERASING MESSAGES) .....	18
MESSAGE FORWARDING .....	19
<b>REMOTE ACCESS</b> .....	<b>21</b>
<b>TROUBLESHOOTING TIPS</b> .....	<b>23</b>
<b>SERVICE</b> .....	<b>26</b>
<b>INDEX</b> .....	<b>29</b>
<b>LIMITED WARRANTY</b> .....	<b>30</b>

**WARNING: TO PREVENT FIRE OR ELECTRICAL SHOCK HAZARD, DO NOT EXPOSE THIS PRODUCT TO RAIN OR MOISTURE.**

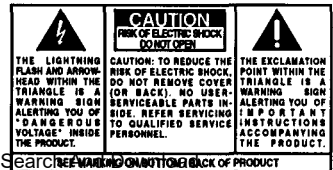

# GETTING STARTED

---

Make sure your package contains the following items:

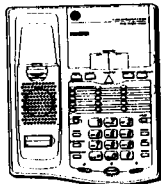

Base unit



Handset

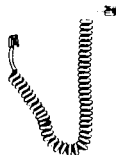

Handset cord

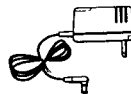

AC power supply  
5-2380



Black telephone line cord



Gray telephone line cord

## BEFORE YOU BEGIN

### REQUIREMENTS

A modular jack USOC: RJ11C or a RJ14C is required.

Installation of this telephone in locations with hard-wired outlets requires additional converters (not included). The dealer from whom you purchased the system, or a telephone supply store, can advise you regarding the proper converter.

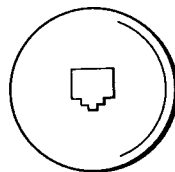

### REMOVING THE LITHIUM BATTERY TAB

Pull out and discard the plastic tab from the lithium battery compartment on the bottom of the base unit.

## INSTALLATION OPTIONS

Although you can use your GE 2-line answerer with a single phone line, you must have two lines (separate phone numbers) to use a two-line system. The following diagrams show two possible systems:

### 2 Lines on a Single Modular Jack

One type of two-line phone system uses a single RJ14 modular jack which contains both phone lines. Connect the gray phone cord to the L1+2 jack located on the back of the phone.

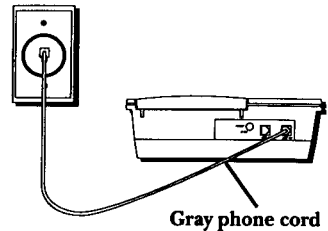

### Each Line on a Separate Modular Jack

If you have two separate phone jacks, each with its own line, connect the black phone cord to the L2 jack, and connect the gray phone cord to the L1+2 phone jack located on the back of the phone.

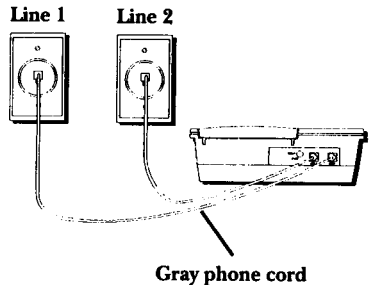

**NOTE:** Connect the Gray phone cord to the outlet that you want to be line one.

## INSERTING A TAPE

Open the tape compartment and gently insert a tape with the top of the cassette to the the right (make sure that Side A is showing).

Don't force the tape into position—it could damage the unit.

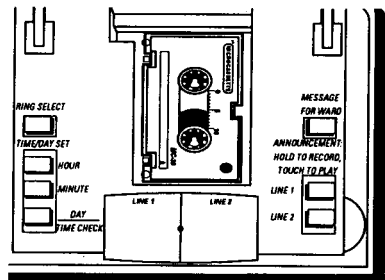

## DESKTOP INSTALLATION

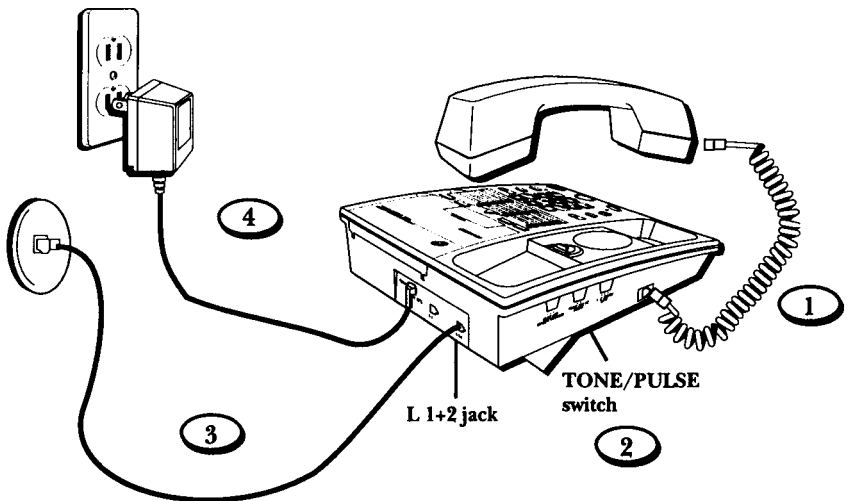

1. Connect the handset cord into the handset, and into the handset jack on the left side of the base unit.
2. Set the TONE/PULSE switch to TONE if you have touch-tone service, or to PULSE if you have rotary dial service.
3. Plug one end of the gray telephone line cord into the jack marked L1+2, and plug the other end into an RJ14 type modular wall jack.

If you have a separate wall jack for each phone line, you also need to plug the black phone cord into the L2 jack on the back of the unit and into the wall jack.

4. Connect the power supply adapter to the POWER 11V AC jack on the back of the unit, and plug it into an AC outlet.

**NOTE:** Use only the Thomson 5-2380 power supply that came with this unit. Using other adapters may damage the unit.

# WALL MOUNT INSTALLATION

1. Remove the base plate by pressing down on the snap tab.
2. Attach the gray phone cord to the L1+2 jack.
3. Connect the power supply adapter to the POWER 11V AC jack on the back of the unit.
4. Reverse the direction of the base plate and run both cords through the slot at the top right of the reversed base plate.
5. Run the gray line cord through the hole in the middle of the base plate.
6. Run the power cord along the right side of the back of the unit and then thread through the slot at the bottom right of base plate.

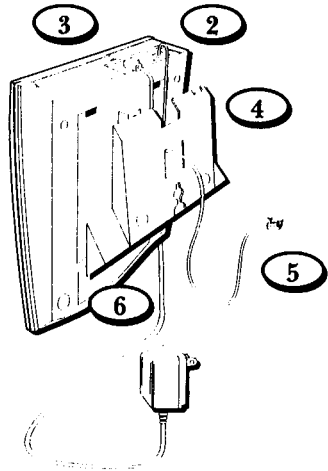
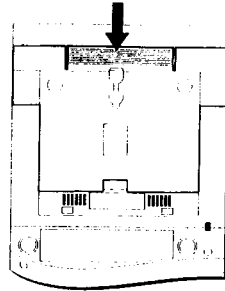

*Continues on next page*

7. Snap the base plate into place.
8. Feed the extra phone cord back into the base plate.
9. Slip the mounting holes over the wall plate posts and slide the unit down firmly into place.  
(Wall plate not included.)

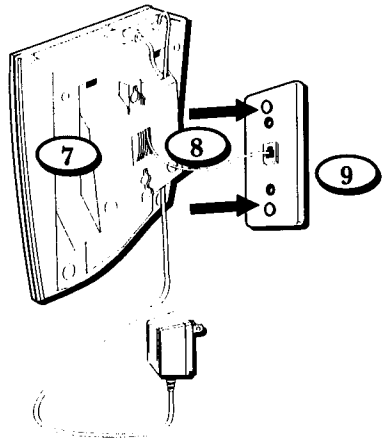

10. Rotate the handset hook one-half turn (180°).
11. Plug the handset cord into the handset and into the unit, and then hang the handset.
12. Set the TONE/PULSE switch (located on the left side of the unit) to TONE if you have touch-tone service, or to PULSE if you have rotary dial service.
13. Plug power supply adapter into an AC outlet.

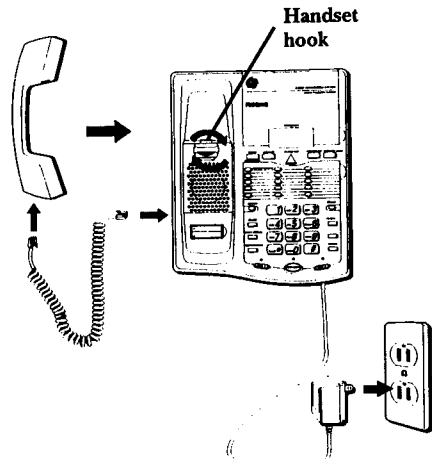

**NOTE:** Use only the Thomson 5-2380 power supply that came with this unit. Using other adapters may damage the unit.



## SETUP

### SETTING THE SPEAKER VOLUME

Slide the VOLUME control to adjust speaker volume to a comfortable level.

### SETTING THE RINGER VOLUME

There are three settings for RINGER VOLUME: HI, LO, or OFF.

### SETTING THE PULSE/TONE

Set the TONE/PULSE switch to TONE if you have touch-tone service, or to PULSE if you have rotary dial service.

### CHOOSING WHICH LINES YOU WANT THE SYSTEM TO ANSWER

Use the LINE switch to choose which lines you want the system to answer: line 1, line 2, or BOTH lines.

### SETTING THE RING SELECT

Hold the RING SELECT button to set the number of times the phone rings before the unit answers a call.

- The choices for number of rings appear in the display.
- You can choose the toll saver option by setting the number of rings to "2-5."

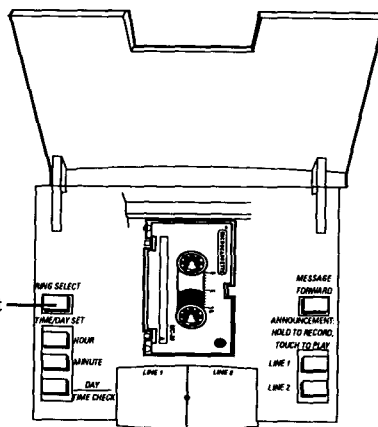
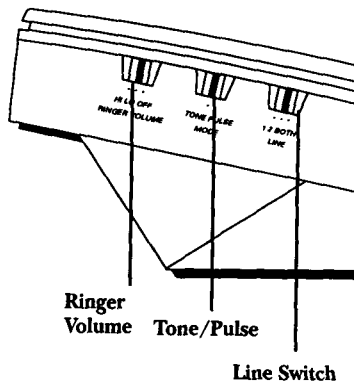
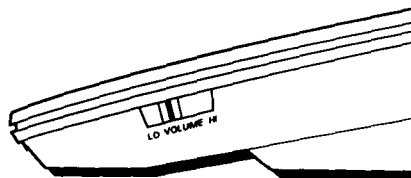

## USING THE TOLL SAVER OPTION

Toll Saver can save you the cost of a call when you access your messages from a remote location:

- If you have messages, the unit answers on the 2nd ring.
- If you have no messages, the unit answers after the 5th ring.

When calling from a remote location, you can hang up when you hear the 3rd ring and save any charges that you might normally incur.

## SETTING THE VOICE TIME/DAY STAMP

The Time/Day Stamp records the time and day each message is received.

1. Press and hold the DAY button to set the day of the week.
2. Press the HOUR button to set the hour.
3. Press the MINUTE button to set the minute (holding the MINUTE button advances the time in 5 minute increments).
4. Press and release the DAY button to check the Time/Day setting.

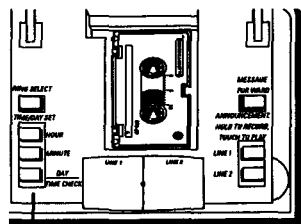

Time/Day setting buttons

## RECORDING THE OUTGOING ANNOUNCEMENT

You need to record a separate outgoing announcement for each line. For best results when recording, your face should be 6 inches from the microphone (located on the front of the unit), and eliminate as much background noise as possible.

### PREPARING THE OUTGOING ANNOUNCEMENT

Before you record the outgoing announcement, you should decide what you want to say. The following is a sample outgoing announcement:

*Hello, we can't come to the phone right now. Please leave your name, telephone number and a brief message after the tone. Thank you.*

1. Press and hold the LINE 1 or LINE 2 ANNOUNCEMENT button. (You need to hold the button until you finish the announcement.)
2. Begin talking after you hear the tone. You have 15 seconds to complete the announcement.
3. Release the button when you finish the announcement.

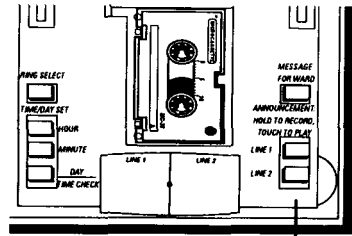

Announcement buttons  
(LINE 1 and LINE 2)

### DEFAULT OUTGOING ANNOUNCEMENT

If you do not want to create your own outgoing announcement, you can use the default announcement, *Please leave message after tone*. To use the default announcement:

1. Press and hold the ANNOUNCEMENT LINE 1 or LINE 2 button.
2. Release the button when you hear the tone.

**NOTE:** The display will blink if you do not record an outgoing announcement or choose the default announcement for each line. It stops blinking once announcements are recorded for each line.

### REVIEWING AN OUTGOING ANNOUNCEMENT

You can review an outgoing announcement by pressing and quickly releasing the LINE 1 or LINE 2 ANNOUNCEMENT button.

### TAPE BACKUP

When you record the outgoing announcement, the tape also records your announcement. In the event of a power failure, the unit automatically re-records the announcement from the tape when power is restored.

**TIP:** For best sound quality of the outgoing announcement, re-record the announcement if power is lost.

# TELEPHONE OPERATION

You can use the telephone by speaking and listening through the handset, or by using the speakerphone feature.

## PLACING CALLS

The telephone automatically selects the last line you used, so to place a call you can just pick up the handset or press **SPEAKER**; or you can press the **LINE 1** or **LINE 2** button to select a line.

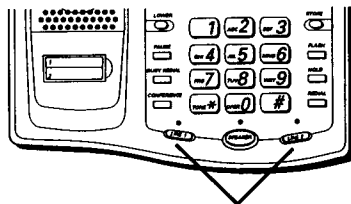

Line buttons and indicator lights

## RECEIVING CALLS

The telephone automatically selects the line of the incoming call when you pick up the handset or press **SPEAKER**.

## SWITCHING BETWEEN SPEAKER AND HANDSET

You can switch between speakerphone and handset after dialing a number, or anytime during a conversation.

- **Speaker to Handset** — Pick up the handset.
- **Handset to Speaker** — Press **SPEAKER**; then hang up the handset.

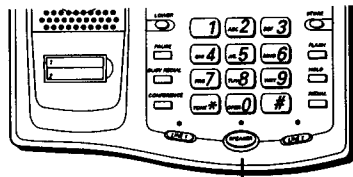

Speaker button and indicator light

## PLACING A CALL WHILE TALKING ON ANOTHER LINE

To place a call without hanging up on the first caller:

1. Press the HOLD button to put the first caller on hold.
2. Pick up the handset or press SPEAKER to access the line not on hold.
3. Dial the phone number you want to call.

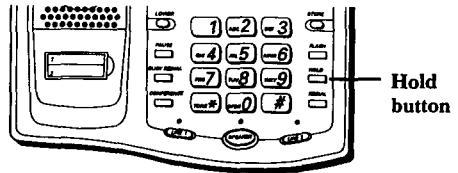

## RECEIVING A CALL WHILE TALKING ON ANOTHER LINE

To answer an incoming call without hanging up on the first caller:

1. Press the HOLD button to put the first caller on hold.
2. Press the line number button of the incoming call, or pick up the handset to answer the incoming call.

**NOTE:** You always need to put the first caller on hold before answering a second call, or you will hang up on the first caller.

## REDIAL

Redial the last number you dialed by pressing the REDIAL button after you get a dial tone.

## **BUSY REDIAL**

When you get a busy signal, use the **BUSY REDIAL** button to automatically redial the number up to 10 times while you do something else.

1. Press **SPEAKER**.
2. Press **BUSY REDIAL**.

When the phone redials and does not get a busy signal, the phone beeps to let you know that your call has gone through. Then, you can pick up the handset or press **SPEAKER** to talk when other party answers.

## **ADJUSTING THE TIME BETWEEN BUSY REDIAL ATTEMPTS**

The default setting for the time between redial attempts is 30 seconds, but you can adjust the delay time between redials to be from 10 to 90 seconds (in 10 second increments).

1. Press **STORE**.
2. Press a number key (1-9) to choose the number of seconds (10-90 ).
3. Press **BUSY REDIAL**.

## **HOLD**

Use the **HOLD** button to interrupt a phone conversation without hanging up; then resume the conversation on the same phone or an extension.

1. Press **HOLD** to place a line on hold (the line indicator flashes).
2. Press the line button or pick up an extension phone to resume the conversation.

## **CONFERENCE CALLS**

You can use the conference call feature when you have callers on both lines, and want to have a three-way conversation.

## CONDUCTING A CONFERENCE CALL

1. Place one party on hold.
2. While speaking to the second party, press the CONFERENCE button.

## ENDING A CONFERENCE CALL

- To disconnect both parties—Hang up.
- To put both parties on hold—Press HOLD.
- To speak to one party individually—Press HOLD; then press the line number of the party to whom you want to speak (the second party remains on hold).

## USING THE FLASH BUTTON

Press the FLASH button to activate custom calling services such as call waiting or call transfer, which are provided by your local phone company. Do not press the hook switch or you might disconnect the line.

## TEMPORARY TONE

If you have pulse (rotary) service, and want to access customer calling services that require Tone dialing (such as getting information from a local bank), you can use this feature.

1. Press TONE () after you have connected to the customer calling service to enable touch-tone dialing.
2. When you hang up, the phone automatically resumes pulse dialing starting with the next call that you make.

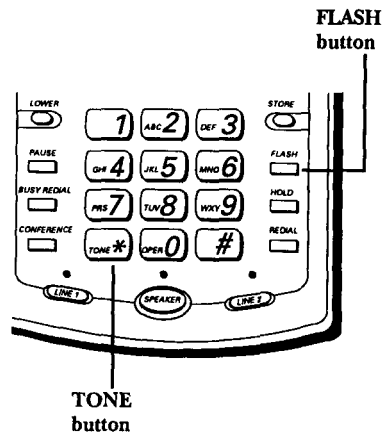

# MEMORY DIALING

Each of the 15 memory location buttons on the phone contains an upper and lower memory location.

**NOTE:** The first memory location button is used to store the number for the Message Forwarding feature.

## STORING A NUMBER IN UPPER MEMORY

1. Press the STORE button.
2. Dial the number to be stored.
3. Press a memory location button to store the number.
4. Remove the memory directory from the front of the unit and write down the name of the person whose phone number you stored.

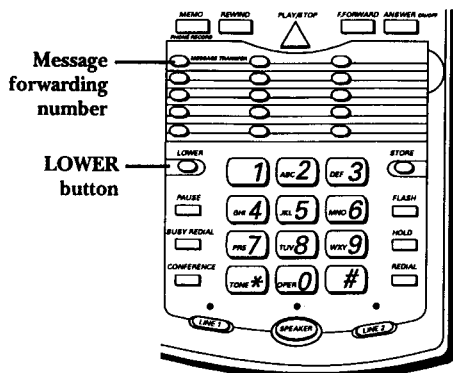

## STORING A NUMBER IN LOWER MEMORY

You can store an additional 15 numbers in lower memory:

1. Press the STORE button.
2. Dial the number to be stored .
3. Press the LOWER button followed by a memory location button to store the number in that button's lower memory.
4. Remove the memory directory from the front of the unit and write down the name of the person whose phone number you stored.



## **INSERTING A PAUSE IN THE DIALING SEQUENCE**

Use the PAUSE button when you need to insert a delay in the dialing sequence of a stored telephone number (for example, when a pause is needed to wait for a dial tone after you dial 9 for an outside line, or to wait for a computer access tone).

## **STORING THE LAST NUMBER DIALED**

You can store the last number you dialed by pressing REDIAL instead of entering a phone number during the memory storage procedure.

## **REVIEWING A STORED NUMBER**

To review the number in a memory location:

1. Make sure that the phone is "on-hook" (no dial tone).
2. Press and release a memory location button to hear the phone number stored in that location.

## **CHANGING A STORED NUMBER**

To change a stored number, replace it with a different number by using the same procedure as you do when storing a number in memory (see preceding page).

Make sure that you update your memory directory whenever you make changes to memory location numbers.

## DIALING A STORED NUMBER

You can dial numbers stored in memory by using the handset or speakerphone.

**CAUTION:** If you make test calls to emergency numbers, remain on the line and explain the reason for the call to the dispatcher. Also, make these calls in off-peak hours, such as early morning or late evening.

### DIALING A NUMBER IN UPPER MEMORY

1. Pick up handset, press the SPEAKER button, or press one of the line buttons.
2. Press the memory location button to dial the number.

### DIALING A NUMBER IN LOWER MEMORY

1. Pick up handset, press the SPEAKER button, or press one of the line buttons.
2. Press the LOWER button.
3. Press the memory location button to dial the number.

## DIALING LONGER NUMBERS FROM MEMORY

With 30 memory locations available, you might want to store frequently used calling card numbers, or access codes for frequently used voice-menu services such as a bank's information line.

To do this, you need to store the service's phone number and any access codes in separate memory locations; then you can access the service's information by pressing each memory location button in sequence, instead of having to input all of the numbers one digit at a time.

# ANSWERER OPERATION

## TURNING THE ANSWERER ON AND OFF

Use the ANSWER ON/OFF button to turn on the answerer (so that it answers phone calls), and to turn the answerer off.

## THE MESSAGES INDICATOR

The number of messages for each line appears in the MESSAGES indicator on the front of the unit.

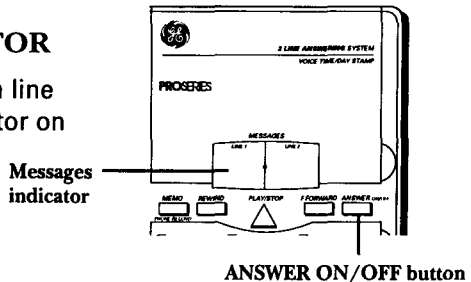

## MESSAGE PLAYBACK

Press the PLAY/STOP button and the answerer automatically plays all messages starting with LINE 1. Press PLAY/STOP, then LINE 1 or LINE 2 to hear the messages for only that line.

When all messages have been played, the answerer stops and then readies itself for more incoming calls. New messages are added to existing messages.

**NOTE:** If you press PLAY/STOP to stop message playback, you should either listen to the remaining messages or fast forward to end of the tape. Otherwise, new messages will be recording over the existing messages beginning at the point in which you stopped the tape.

## REWIND AND F. FORWARD BUTTONS

- Use the F. FORWARD button to advance the tape during playback, or to skip to the end of the tape when messages are not playing.
- Use the REWIND button to go back through previous messages during playback, or to reset the tape when messages are not playing.

## **RESETTING THE TAPE (ERASING MESSAGES)**

You don't actually erase messages from the tape, but instead you just record new messages over the existing ones by resetting the tape to its beginning. Normally, when you finish listening to messages, the unit sets the tape to begin recording after the last message received.

To reset the tape to the beginning and record over existing messages:

1. Press the **REWIND** button.
2. Choose which line's messages you want to clear by pressing the **LINE 1** or **LINE 2** button.
3. Repeat the process for the other line if desired.

## **TAPE FULL**

When the tape is full, the unit does not answer until the 10th ring; then it beeps. After the beep enter your security code (located on the bottom of the unit). If the correct code is not entered, the unit hangs up. This enables you to access your answerer from a remote location, listen to messages, and reset the tape for new messages (see "Remote Access" for more information).

## **RESTORING MESSAGES**

After you reset the tape, you can restore any messages on the tape, but you must restore before new ones are recorded—otherwise they are lost. Use any of the following methods to restore messages:

- Press **PLAY/STOP** and then select a line number to listen to that line's messages. If no line is selected, the unit plays all messages.
- Press **F. FORWARD** and then select a line number to restore that line's messages without listening to the messages. If no line is selected, the messages for both lines are restored.

Whenever you restore messages, the unit automatically sets up to record after the last message on the tape (just as if you never reset the tape).

# MESSAGE FORWARDING

The answerer can forward messages to another phone number.

## SETTING UP MESSAGE FORWARDING

1. Press the STORE button.
2. Dial the number to which you want to forward messages.
3. Press the first memory location button (marked FORWARDING).
4. Press the MESSAGE FORWARD button.  
(To turn on forwarding feature)
  - **Fon** ("forwarding on") appears in the display.
  - The number you are forwarding messages to is stored in the first memory location.

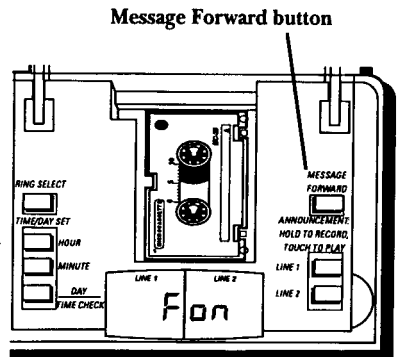

Press MESSAGE FORWARD to turn off message forwarding.

## RECEIVING FORWARDED MESSAGES

When the answerer records a message, it disconnects and dials the forwarding number. The person answering the call is asked by the voice prompt to enter the security code (located on the bottom of the unit) to hear the message:

- If the correct security code is entered, the answerer goes into remote mode, and you can listen to messages.
- If no code is entered within 45 seconds, the unit hangs up and tries again 10 minutes later (for a maximum of 10 attempts).
- After two incorrect attempts to enter the code, the system hangs up and does not call again.
- The person answering the call can press \* to turn off message forward. When message forward is turned off remotely, **Fon** flashes, indicating to you that it has been shut off. Make sure the forwarding phone number is correct, because you may have input a wrong number.

## CALL SCREENING

You can screen incoming calls by listening as the answerer begins recording the caller's message, and then picking up the handset, pressing the line number button, or picking up an extension phone to talk to that person.

## MEMO (PHONE RECORD) BUTTON

The MEMO (PHONE RECORD) button serves two purposes:

- Enables you to leave a message on the answering machine.
- Enables you to record a telephone conversation.

### LEAVING A MEMO

1. Press and hold down the MEMO (PHONE RECORD) button.
2. When you hear a beep, continue holding MEMO (PHONE RECORD) and leave your message.
3. Release MEMO (PHONE RECORD) when you finish your message.

The memo is recorded to LINE 1, and appears in the message count for line 1.

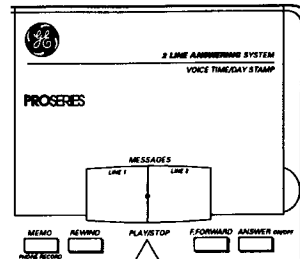

Memo (Phone Record) button

### RECORDING A CONVERSATION

The MEMO (PHONE RECORD) button also can be used to record a phone conversation, for example, when someone is giving you directions.

1. Press MEMO (PHONE RECORD) at any time during a phone conversation to begin recording.
2. Press MEMO (PHONE RECORD) again to stop recording.

## **REMOTE ACCESS**

---

You can access your answering machine from any touch-tone phone by entering a factory-set, three-digit security code (located on the bottom of the unit) after you hear the outgoing announcement.

1. Dial the phone number for line 1 or 2.
2. After the beep following the outgoing announcement, enter the three-digit security code (located on the bottom of the unit). Entering the correct security code automatically turns on the answerer (even if it was off).
3. Follow the voice-menu instructions to access your messages and perform other functions. See the remote access card attached to the cover for detailed information regarding the remote functions.

## **BYPASSING THE OUTGOING ANNOUNCEMENT**

You can bypass the outgoing announcement by pressing a number key while the announcement is playing.

## **REMOTE ACCESS VOICE MENU**

This system has a voice menu system to guide you through the available options when you access your answerer from a remote location.

This User's Guide also includes two wallet-size remote access reference cards that you can remove and take with you.

## **REMOTE ROOM MONITOR**

One of the available remote functions is the room monitor feature which activates the answerer's microphone so that you can hear what is going on within the microphone's range.

- Press 2 to turn on room monitor (the microphone comes on for one minute).
- Press 2 again to turn off the room monitor before the minute expires.

## SYSTEM ANSWERS ON 10TH RING

When the tape is full, or if the answerer is turned off, the unit answers on the 10th ring and asks for the security code. When you enter the security code, the unit automatically comes on and indicates whether or not you have messages or if the tape is full.

**TIP:** When the tape is full, it is a good idea to clear messages and reset the tape so that you are able to receive more messages. See table below for instructions on resetting the tape from a remote location.

## REMOTE ACCESS OPTIONS

This table includes the available remote access options.

<i>To activate this function</i>	<i>Press this key</i>
Bypass the outgoing announcement	Any key during announcement
Playback all messages	3
Playback line 1 messages	3, 1
Playback line 2 messages	3, 2
Stop playback	8
Rewind tape during playback	7 (hold to rewind)
Advance (F. Forward) tape during playback	9 (hold to advance)
Reset the tape (only when messages are not playing)	7, 1 (for line 1) 7, 2 (for line 2)
Change the outgoing announcement	4, 1 (for line 1) 4, 2 (for line 2) Press 4 to stop recording
Leave a memo	5 (to start and stop)
Turn room monitor on or off	2
To access message forwarding functions	0



# **TROUBLESHOOTING TIPS**

---

## **TELEPHONE OPERATION SOLUTIONS**

---

<i>Problem</i>	<i>Solution</i>
No dial tone. Won't dial out	<ul style="list-style-type: none"><li>• Make sure speakerphone indicator comes on (if using speakerphone.)</li><li>• Make sure phone is plugged in.</li><li>• Check hook switch to make sure it pops up.</li><li>• Make sure TONE/PULSE is set to the correct position (pp. 4, 6).</li><li>• Unplug the phone, wait 30 seconds, and plug the phone back in.</li></ul>
Phone doesn't ring	<ul style="list-style-type: none"><li>• Check RINGER VOLUME (p. 7).</li><li>• Could have too many phones on one line. (See FCC registration information regarding REN.)</li></ul>
Low handset or speaker volume	<ul style="list-style-type: none"><li>• Check the volume settings (see p. 7).</li></ul>
Light and tone feedback flutter when dialing in PULSE mode.	<ul style="list-style-type: none"><li>• This is normal as power is fluctuating with phone outpulsing.</li></ul>
Can't be heard by other party	<ul style="list-style-type: none"><li>• Make sure phone cord is plugged in securely (p. 4- 6).</li></ul>
Memory dialing	<ul style="list-style-type: none"><li>• Make sure you entered numbers correctly. (See "Memory Dialing" p. 14.)</li></ul>
Busy Redial not working	<ul style="list-style-type: none"><li>• Make sure that the ringer volume is on (p. 7)</li></ul>

## ANSWERER OPERATION SOLUTIONS

<i>Problem</i>	<i>Solution</i>
Can't hear messages, beep, etc.	<ul style="list-style-type: none"><li>• Adjust speaker volume (p. 7).</li></ul>
Time/Day Stamp is stuck at 12 a.m. Monday	<ul style="list-style-type: none"><li>• Set the Time/Day stamp (p. 8).</li></ul>
Doesn't answer, or answers on 10th ring	<ul style="list-style-type: none"><li>• Make sure answerer is turned on (p. 17).</li><li>• Tape is full, reset messages (p. 18)</li><li>• Check AC power and phone line connections.</li></ul>
Incoming messages are incomplete	<ul style="list-style-type: none"><li>• Extension was picked up?</li><li>• Tape is full (p. 18).</li><li>• Accidentally pressed STOP button during playback and stopped message.</li><li>• You may get some voice at the end, from a message that was not completely recorded over.</li></ul>
Won't respond to remote commands	<ul style="list-style-type: none"><li>• Must use touch-tone phone.</li><li>• Did the unit hang up? If you take no action for a period of time, it automatically hangs up.</li></ul>
Outgoing Announcement is unclear	<ul style="list-style-type: none"><li>• Re-record the announcement (p. 9).<ul style="list-style-type: none"><li>– Make sure you are about 6 inches from the microphone (located on the front of the unit).</li><li>– Eliminate background noise.</li></ul></li></ul>
Answerer won't respond	<ul style="list-style-type: none"><li>• Unplug power cord from the back of the unit and plug it back in to reset the answerer.</li><li>• Make sure answerer is on.</li><li>• Make sure line selected switch is set correctly (p. 7)</li></ul>
"Fon" is flashing in the display	<ul style="list-style-type: none"><li>• Message forward was stopped. Need to turn it back on (p. 19).</li></ul>

## CARE AND MAINTENANCE

---

To keep your GE telephone working and looking good, follow these few simple guidelines:

- Avoid putting the unit near heating appliances and devices that generate electrical noise. (i.e., motors, fluorescent lamps.)
- The unit should not be exposed to direct sunlight or moisture.
- Avoid dropping and other rough treatment of the unit.
- Clean with a soft cloth. (Remember to first unplug the unit from the wall outlet.)
- Never use a strong cleaning agent or abrasive powder, as this can damage the finish.
- Retain the original packaging for future use.

## CLEANING THE TAPE MECHANISM

Because the head and capstan assemblies are in contact with the tape, dirt and residue from the tape can easily adhere to these parts, causing distortion.

These parts should therefore be cleaned periodically (at least twice a year) in the following manner.

1. Remove cassette from unit.
2. Clean the head surface, pressure rollers and capstans with a cotton swab. If these surfaces are extremely dirty, dampen the cotton swab with alcohol or use a tape head cleaning kit (follow the manufacturer's directions regarding use).

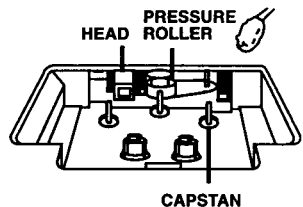

## **SERVICE**

---

FCC requires this product be serviced only by the manufacturer or its authorized service agents. In accordance with FCC requirements, changes or modifications not expressly approved by Thomson Consumer Electronics could void the user's authority to operate this product. For instructions on how to obtain service, refer to the warranty included in this guide or call customer service, telephone number: 800-448-0329.

Attach your sales receipt to the booklet for future reference or jot down the date this product was purchased or received as a gift. This information will be valuable if service should be required during the warranty period.

Purchase date \_\_\_\_\_

Name of store \_\_\_\_\_

CUSTOMER: CUT ALONG DOTTED LINE. ✂

# ACCESSORY ORDER FORM

DESCRIPTION	CATALOG NUMBER	PRICE*	QUANTITY	TOTAL
AC power supply adapter	5-2380	\$9.95		

**For credit card purchases**

Your complete charge card number, its expiration date and your signature are necessary to process all charge card orders.

Copy your complete account number from your VISA card.

<input type="text"/>	<input type="text"/>	<input type="text"/>	<input type="text"/>	<input type="text"/>	<input type="text"/>	<input type="text"/>	<input type="text"/>	<input type="text"/>	<input type="text"/>	<input type="text"/>	<input type="text"/>
----------------------	----------------------	----------------------	----------------------	----------------------	----------------------	----------------------	----------------------	----------------------	----------------------	----------------------	----------------------

My card expires:

<input type="text"/>	<input type="text"/>	<input type="text"/>	<input type="text"/>
----------------------	----------------------	----------------------	----------------------

Copy your complete account number from your MasterCard.

<input type="text"/>	<input type="text"/>	<input type="text"/>	<input type="text"/>	<input type="text"/>	<input type="text"/>	<input type="text"/>	<input type="text"/>	<input type="text"/>	<input type="text"/>	<input type="text"/>	<input type="text"/>
----------------------	----------------------	----------------------	----------------------	----------------------	----------------------	----------------------	----------------------	----------------------	----------------------	----------------------	----------------------

Copy the number above your name on the MasterCard

<input type="text"/>	<input type="text"/>	<input type="text"/>	<input type="text"/>
----------------------	----------------------	----------------------	----------------------

My card expires:

<input type="text"/>	<input type="text"/>	<input type="text"/>	<input type="text"/>
----------------------	----------------------	----------------------	----------------------

\*Prices are subject to change without notice.

Total Merchandise.....\$ \_\_\_\_\_

We are required by law to collect the appropriate sales tax for each individual state, county, and locality to which the merchandise is being sent.

Sales Tax..... \$ \_\_\_\_\_

Use VISA or MasterCard preferably .Money order or check must be in U.S. currency only. No COD or Cash.

All accessories are subject to availability. Where applicable, we will ship a superseding model.

Shipping, Handling, and Insurance.....\$ **55.00**

Total Amount Enclosed.....\$ \_\_\_\_\_

Mail order form and money order or check (in U.S. currency) made payable to Thomson Consumer Electronics, Inc. to:

Consumer Electronics

Mail Order Department

P.O. Box 8419

Ronks, PA 17573-8419

This is your return label. Please print clearly. To:

Name \_\_\_\_\_

Address \_\_\_\_\_ Apt. \_\_\_\_\_

City \_\_\_\_\_ State \_\_\_\_\_ ZIP \_\_\_\_\_

Authorized Signature

Please make sure that this form has been filled out completely.

## ACCESSORY ORDER FORM

*To fulfill your communicating needs and enhance your life-style, a wide range of GE extension phones, main phones, cordless phones and answering systems is available.*

*Just stop by your nearest retailer and ask to see the wide range of GE telephone products.*

*All are carefully engineered to offer you high quality and dependability, modern easy-to-use features, and elegant styling at an affordable price.*

*Should you wish to purchase, insist on the GE brand for all your communicating needs.*



# INDEX

---

## A

ANNOUNCEMENT  
  buttons 9  
ANSWER ON/OFF  
  button 17

## B

BUSY REDIAL button 12

## C

Call screening 20  
Cleaning the tape  
  mechanism 25  
Clearing (resetting)  
  messages 18  
CONFERENCE button 13  
Conference Call feature  
  12-13

## D

DAY button 8  
DAY/time check button 8  
Desktop installation 4

## F

F. FORWARD button 18  
FLASH button 13  
Fon indicator 19  
Full tape 18

## H

HOLD button 11, 12  
HOUR button 8

## I

Inserting a tape 3  
Installation 3-6

## L

LINE switch 7  
Lithium battery tab 2  
LOWER button 14

## M

MEMO (PHONE RECORD)  
  recording a  
    conversation 20  
  leaving a message  
    20  
Memory dialing 14  
Memory locations, upper  
  and lower 14  
Message forwarding 19  
MESSAGE FORWARD  
  button 19  
MINUTE button 8

## O

Outgoing announcement  
  Recording 8, 9  
  Reviewing 8, 9

## P

PAUSE button 15  
Plastic battery tab 2  
PLAY/STOP button 17, 18  
Power supply adapter 4  
Programming busy redial  
  delay 12

## R

REDIAL button 11  
Remote access 21  
Resetting the tape 18  
Restoring messages 18

Reviewing an outgoing  
  announcement 9  
REWIND button 17, 18  
RING SELECT button 7  
Ringer Volume 7  
Room monitor 22

## S

Security code 21  
Speaker volume 7  
STORE button 14  
Stored numbers,  
  changing 15  
  dialing 16  
Switching between the  
  speaker and the  
  handset 10

## T

Tape Full 18  
Time/Day Stamp 8  
  setting up 8  
Toll saver 8  
TONE/PULSE switch 4, 6  
Troubleshooting tips 22  
Turning the answerer on  
  and off 17

## V

Voice Time/Day Stamp 8  
VOLUME control 7

# LIMITED WARRANTY

---

## What does your warranty cover?

- Any defect in material or workmanship.

## For how long after the original purchase?

- One year.
- The warranty for rental units begins with the first rental.

## What will we do?

- Provide you with a new, or at our option, a refurbished unit.
- The exchange unit is warranted for the remainder of your product's original warranty period.

## How do you make a warranty claim?

- Properly pack your unit. Include any cables, etc., which were originally provided with the product. We recommend using the original carton and packing materials.
- Include in the package a copy of the sales receipt or other evidence of date of original purchase. If the unit was a gift, provide a statement specifying the date received. Also print your name and address and a description of the defect. Send standard UPS or its equivalent to:

**Thomson Consumer Electronics, Inc.**

**Product Exchange Center**

**32 Spur Drive**

**El Paso, Texas 79906**

- Pay any charges billed to you by the Exchange Center for service not covered by the warranty.
- A new or refurbished unit will be shipped to you prepaid freight.

## What does your warranty not cover?

- Customer instruction. Your Owner's Manual provides information regarding operating instructions and user controls. For additional information, ask your dealer.
- Installation and set-up service adjustments.
- Batteries.
- Damage from misuse or neglect.
- Products which have been modified or incorporated into other products.
- Product purchased or serviced outside the USA.
- Acts of God such as but not limited to lightning damage.

## How does state law relate to this warranty?

- This warranty gives you specific legal rights, and you may also have other rights which vary from state to state.

## What if you purchased your product outside the United States?

- This warranty does not apply. See your dealer for details.

Model 2-9975  
347A7986-0001 (Rev. 0 E/S)  
95-35  
Printed in China

 **THOMSON CONSUMER ELECTRONICS**

P.O. Box 1976, Indianapolis, IN 46206  
© 1995 Thomson Consumer Electronics, Inc.  
Trademark(s) ® Registered  
Marca(s) Registrada(s)



## Free Manuals Download Website

<http://myh66.com>

<http://usermanuals.us>

<http://www.somanuals.com>

<http://www.4manuals.cc>

<http://www.manual-lib.com>

<http://www.404manual.com>

<http://www.luxmanual.com>

<http://aubethermostatmanual.com>

Golf course search by state

<http://golfingnear.com>

Email search by domain

<http://emailbydomain.com>

Auto manuals search

<http://auto.somanuals.com>

TV manuals search

<http://tv.somanuals.com>