



Use and Care Guide

Built-in Electric Convection Oven



Safety Instructions 3, 4



Operating Instructions, Tips

Aluminum Foil 4, 19, 23, 28

Baking 17–19

Broiling/Broiling Guide 27–29

Control Panel 6–9

Convection Cooking 11–17

 Convection Baking 12–14

 Convection Roasting 15–17

 Convection Roasting with the Probe 16

 Multi-Shelf Baking 12

 Special Roasting Rack 15

 Timed Convection Baking 13, 14

Features 5

Oven Control, Clock and Timer 6–9

Preheating 18, 27–29

Probe 16, 24, 25

Roasting/Roasting Guide 23, 26

Roasting with the Probe 24, 25

Self-Cleaning Instructions 30–33

Shelves 4, 10, 12, 15, 16, 18, 29, 30, 34

Special Features of Your Control 8, 9

Timed Baking 20, 21



Problem Solver 37, 38

Thermostat Adjustment—
Do It Yourself 22

More questions?...call
GE Answer Center® 800.626.2000



Care and Cleaning 34–36

Broiler Pan and Grid 34

Oven Door 35

Oven Light Bulb 36

Oven Shelves 34

Probe 36

Self-Cleaning Instructions 30–33



Consumer Services 39

Appliance Registration 2

Important Phone Numbers 39

Model and Serial Number Location 2

Removal of Packaging Tape 2

Warranty Back Cover



HELP US HELP YOU...

Before using your oven, read this guide carefully.

It is intended to help you operate and maintain your new oven properly.

Keep it handy for answers to your questions.

If you don't understand something or need more help, call:

GE Answer Center®

800.626.2000

24 hours a day, 7 days a week

How to Remove Packaging Tape

To assure no damage is done to the finish of the product, the safest way to remove adhesive left from packaging tape on new appliances is an application of a household liquid dishwashing detergent, mineral oil or cooking oil. Apply with a soft cloth and allow to soak. Wipe dry and then apply an appliance polish to thoroughly clean and protect the surface.

NOTE: The plastic tape must be removed from the chrome trim on oven parts. It cannot be removed if it is baked on.

Write down the model and serial numbers.

You'll find them on a label on the front of the lower oven behind the oven door.

These numbers are also on the Consumer Product Ownership Registration Card that came with your oven. Before sending in this card, please write these numbers here:

Model Number

Serial Number

Use these numbers in any correspondence or service calls concerning your oven.

If you received a damaged oven...

Immediately contact the dealer (or builder) that sold you the oven.

Save time and money. Before you request service...

Check the Problem Solver in the back of this guide. It lists causes of minor operating problems that you can correct yourself.

IF YOU NEED SERVICE...

To obtain service, see the Consumer Services page in the back of this guide.

We're proud of our service and want you to be pleased. If for some reason you are not happy with the service you receive, here are three steps to follow for further help.

FIRST, contact the people who serviced your appliance. Explain why you are not pleased. In most cases, this will solve the problem.

NEXT, if you are still not pleased, write all the details—including your phone number—to:

Manager, Consumer Relations
GE Appliances
Appliance Park
Louisville, KY 40225

FINALLY, if your problem is still not resolved, write:

Major Appliance Consumer Action Program
20 North Wacker Drive
Chicago, IL 60606

IMPORTANT SAFETY INSTRUCTIONS

Read all instructions before using this appliance.



IMPORTANT SAFETY NOTICE

- **The California Safe Drinking Water and Toxic Enforcement Act** requires the Governor of California to publish a list of substances known to the state to cause birth defects or other reproductive harm, and requires businesses to warn customers of potential exposure to such substances.
- **The fiberglass insulation in self-cleaning ovens gives off a very small amount of carbon monoxide during the cleaning cycle.** Exposure can be minimized by venting with an open window or using a ventilation fan or hood.

When using electrical appliances, basic safety precautions should be followed, including the following:

- **Use this appliance only for its intended use** as described in this guide.
- **Have the installer show you the location of the circuit breaker or fuse.** Mark it for easy reference.
- **Be sure your appliance is properly installed and grounded** by a qualified technician in accordance with the provided Installation Instructions.
- **Do not attempt to repair or replace any part of your oven unless it is specifically recommended in this guide.** All other servicing should be referred to a qualified technician.
- **Before performing any service, DISCONNECT THE OVEN POWER SUPPLY AT THE HOUSEHOLD DISTRIBUTION PANEL BY REMOVING THE FUSE OR SWITCHING OFF THE CIRCUIT BREAKER.**
- **Do not leave children alone**—Children should not be left alone or unattended in an area where appliance is in use. They should never be allowed to sit or stand on any part of the appliance.
- **Do not allow anyone to climb, stand or hang on the door.** They could damage the oven or cause severe personal injury.
- **CAUTION: ITEMS OF INTEREST TO CHILDREN SHOULD NOT BE STORED IN CABINETS ABOVE AN OVEN. CHILDREN CLIMBING ON THE OVEN TO REACH ITEMS COULD BE SERIOUSLY INJURED.**

- **Teach children not to play with the controls** or any other part of the oven.
- **Never leave the oven door open** when you are not watching the oven.
- **Always keep combustible wall coverings, curtains or drapes a safe distance from your oven.**
- **Never wear loose-fitting or hanging garments while using the appliance.** Be careful when reaching for items stored in cabinets over the oven. Flammable material could be ignited if brought in contact with hot heating elements and may cause severe burns.
- **DO NOT STORE OR USE COMBUSTIBLE MATERIALS, GASOLINE OR OTHER FLAMMABLE VAPORS AND LIQUIDS IN THE VICINITY OF THIS OR ANY OTHER APPLIANCE.**



- **Use only dry pot holders**—Moist or damp pot holders on hot surfaces may result in burns from steam. Do not let pot holders touch hot heating elements. Do not use a towel or other bulky cloth. Such cloths can catch fire on a hot heating element.
- **Always keep dish towels, dish cloths, pot holders and other linens a safe distance from your oven.**
- **Always keep wooden and plastic utensils and canned food a safe distance away from your oven.**
- **For your safety, never use your appliance for warming or heating the room.**
- **Do not store flammable materials in the oven.**
- **Do not let cooking grease or other flammable materials accumulate in or near the oven.**
- **Be sure the oven is securely installed in a cabinet that is firmly attached to the house structure.** Never allow anyone to climb, sit or stand on the oven door.



(continued next page)



IMPORTANT SAFETY INSTRUCTIONS

(continued)



- **Do not use water on grease fires.** Smother fire or flame or use a multi-purpose dry chemical or foam-type fire extinguisher.

Flame in the oven can be smothered completely by closing the oven door and turning the oven off or by using a multi-purpose dry chemical or foam-type fire extinguisher.

- **Do not touch the heating elements or the interior surface of the oven.** These surfaces may be hot enough to burn even though they are dark in color. During and after use, do not touch, or let clothing or other flammable materials contact, any interior area of the oven; allow sufficient time for cooling first.

Potentially hot surfaces include the oven vent openings and surfaces near the openings, crevices around the oven door, the edges of the door window and metal trim parts above the door.

Remember: The inside surface of the oven may be hot when the door is opened.

- **When cooking pork,** follow the directions exactly and always cook the meat to an internal temperature of at least 170°F. This assures that, in the remote possibility that trichina may be present in the meat, it will be killed and the meat will be safe to eat.

Oven

- **Stand away from the oven when opening the oven door.** The hot air or steam which escapes can burn hands, face and/or eyes.
- **Do not heat unopened food containers.** Pressure could build up and the container could burst, causing an injury.
- **Keep the oven vent duct unobstructed.**
- **Keep the oven free from grease buildup.**
- **Place the oven shelf in the desired position while the oven is cool.** If the shelves must be handled when hot, do not let the pot holder contact the heating elements.
- **Pulling out the shelf to the stop-lock is a convenience in lifting heavy foods.** It is also a precaution against burns from touching the hot surfaces of the door or the oven walls.

- **When using cooking or roasting bags in the oven,** follow the manufacturer's directions.
- **Do not use your oven to dry newspapers.** If overheated, they can catch fire.
- **Do not leave paper products, cooking utensils or food in the oven when not in use.**
- **After broiling, always take the broiler pan out of the oven and clean it.** Leftover grease in the broiler pan can catch on fire the next time you use the pan.
- **Never leave jars or cans of fat drippings in or near your oven.**
- **Do not use the oven for a storage area.** Items stored in an oven can ignite.
- **Clean only parts listed in this Use and Care Guide.**
- **Do not use aluminum foil to line oven bottoms, except as suggested in this guide.** Improper installation of aluminum foil may result in a risk of electric shock or fire.

Self-Cleaning Oven

- **Do not clean the oven door gasket.** The door gasket is essential for a good seal. Care should be taken not to rub, damage or move the gasket.
- **Do not use oven cleaners.** No commercial oven cleaner or oven liner protective coating of any kind should be used in or around any part of the oven. Residue from oven cleaners will damage the inside of the oven when the self-clean cycle is used.
- **Before self-cleaning the oven,** remove the broiler pan, grid and other cookware.
- **Be sure to wipe up excess spillage before starting the self-cleaning operation.**
- **If the self-cleaning mode malfunctions, turn the oven off and disconnect the power supply.** Have it serviced by a qualified technician.

SAVE THESE INSTRUCTIONS

FEATURES OF YOUR OVENS

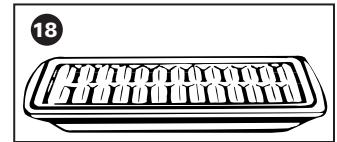
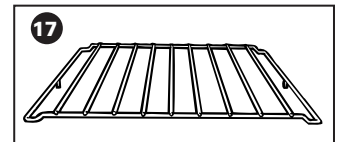
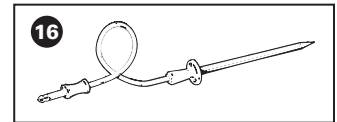
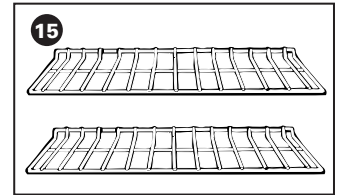
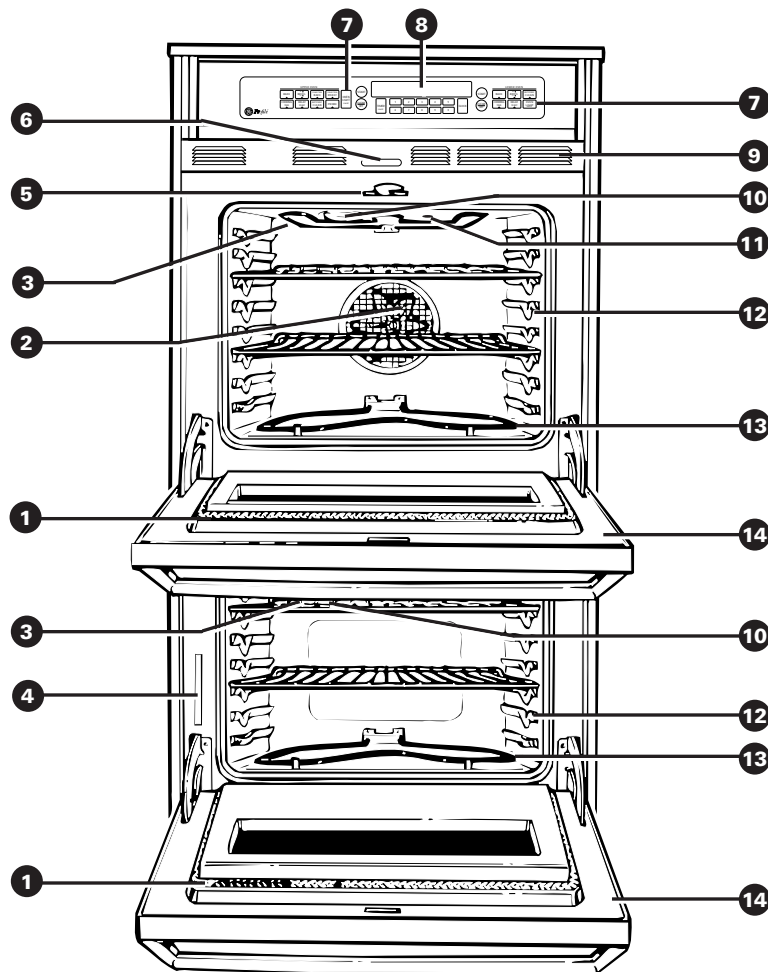

Important Safety Instructions

Feature Index	Explained on page
1 Oven Door Gasket	4, 30, 35
2 Convection Fan and Heating Element Operates during convection cooking.	11
3 Oven Broil Element	3, 4, 27, 36
4 Model and Serial Number Location	2
5 Automatic Oven Door Latch	30–32
6 Oven Vent	4
7 Oven Light Pads Lets you turn interior oven lights on and off.	—
8 Oven Control, Clock & Timer	6–9
9 Oven Vent Grille	30
10 Oven Interior Light	36

Feature Index	Explained on page
11 Probe Outlet	16, 24, 25
12 Oven Shelf Supports Shelf positions for cooking are suggested in the Convection Cooking, Baking, Roasting and Broiling sections.	4, 10, 12, 15, 16, 18, 29, 30, 34
13 Bake Element May be lifted gently for wiping the oven floor.	3, 4, 36
14 Lift-Off Oven Door with Window	3, 27, 30, 35
15 Oven Shelves with Stop-Locks	4, 10, 12, 15, 16, 18, 29, 30, 34
16 Probe	16, 24, 25, 36
17 Roasting Rack	15, 34
18 Broiler Pan and Grid	4, 15, 23, 24, 27–30, 34

Features of Your Ovens



FEATURES OF YOUR OVEN CONTROL

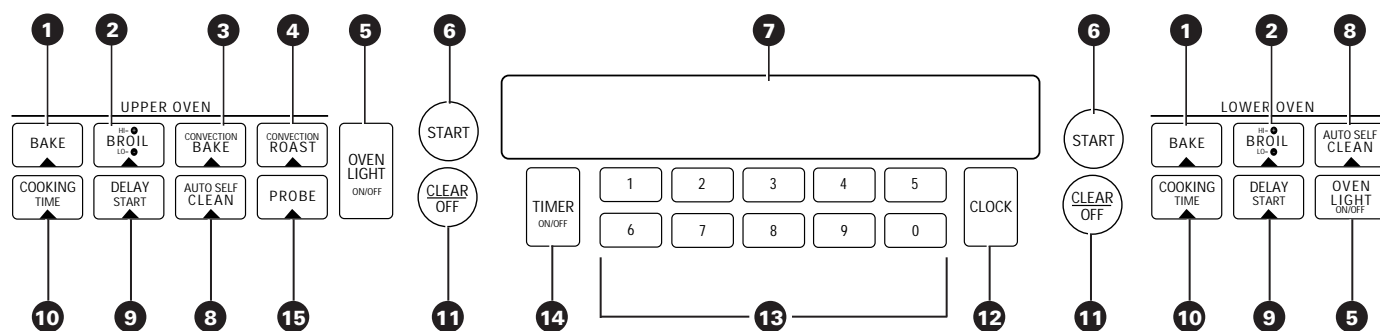

- 1. BAKE.** Press to select the bake function.
- 2. BROIL HI/LO.** Press to select the broil function.
- 3. CONVECTION BAKE.** Press to select baking with convection.
- 4. CONVECTION ROAST.** Press to select roasting with convection.
- 5. OVEN LIGHT ON/OFF.** Press to turn the oven lights on or off.
- 6. START.** Must be pressed to start any cooking or cleaning function.
- 7. DISPLAY.** Shows the operations you have selected, the time of day and the cooking or cleaning status.
- 8. AUTO SELF CLEAN.** Press to select the self-cleaning function. See the Operating the Self-Cleaning Oven section.
- 9. DELAY START.** Use along with COOKING TIME or AUTO SELF CLEAN to set the oven to start and stop automatically at a time you select.
- 10. COOKING TIME.** Use for Timed Bake, Timed Convection Bake and Timed Convection Roast operations.
- 11. CLEAR/OFF.** Press to cancel any timed oven operation except the clock and timer.
- 12. CLOCK.** Press to enter the time of day.
- 13. NUMBER PADS.** Use to set any function requiring numbers—for example, the time of day on the clock, the timer, the oven temperature, the internal food temperature, the starting and length of cooking time for Timed Bake and the starting and length of cleaning time for Self-Clean.
- 14. TIMER ON/OFF.** Press to select the timer function. The timer does not control oven operations. The timer can time up to 9 hours and 59 minutes.
- 15. PROBE.** Press when using the probe to cook food (upper oven only).

If “F—and a number or letter” flash in the display and the oven control signals, this indicates function error code. Press CLEAR/OFF. Allow oven to cool for one hour. Put the oven back into operation. If function error code repeats, disconnect power to the oven and call for service.

OVEN CONTROL, CLOCK AND TIMER



Clock

The clock must be set for the automatic oven timing functions to work properly.

The time of day clock **cannot** be changed during Delay Start. (It can be changed during a regular bake or broil operation.)

To Set the Clock



1. Press CLOCK.

2. Press the number pads the same way you read them. **For example**, to set 12:34, press the number pads 1, 2, 3 and 4 in that order.

If number pads are not pressed within one minute after you press CLOCK, the display reverts to the original setting. If this happens, press CLOCK and reenter the time of day.



3. Press START. This enters the time and starts the clock.

To check the time of day when the display is showing other information, simply press CLOCK. The time of day shows until another pad is pressed.

Timer

You may program the timer to time cooking or other household activities for up to 9 hours and 59 minutes.

The timer counts down in minutes, 1 minute at a time, until the last 60 seconds are reached, then the control will beep one time. The seconds will not be displayed until the last minute is reached.

When the timer reaches “:00,” the control will beep 3 times followed by one beep every 6 seconds until TIMER ON/OFF is pressed.

The 6 second tone can be canceled by following the steps in the Special Features of Your Oven Control section under Tones at the End of a Timed Cycle.

How to Set the Timer



1. Press TIMER ON/OFF.

2. Press the number pads to set the time. **For example**, to enter 2 hours and 45 minutes, touch 2, 4 and 5 in that order.

If you make a mistake, press TIMER ON/OFF and begin again.



3. Press START.

After pressing START, “SET” disappears; this tells you the time is counting down, although the display does not change until one minute has passed.

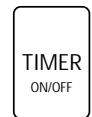

4. When time is up, the oven control signals until you press TIMER ON/OFF. Display then shows the time of day.

NOTE: The minute timer is independent of all the other functions and it does not control the oven. The CLEAR/OFF pad does not affect the timer.

Power Failure

If a flashing time of day is in the display, you have experienced a power failure. Reset the clock. **To reset the clock**, press CLOCK. Enter the correct time of day by pressing the appropriate number pads. Press START.

(continued next page)



OVEN CONTROL, CLOCK AND TIMER

(continued)

The control has a series of tones that will sound at different times. These tones may sound while you set the control for an oven function or at the end of the oven function. They will also alert you when an incorrect time or temperature has been entered or if there is a problem with the oven.

Tones While Setting the Control

When you press a touch pad you will hear a beep. This beep will let you know you have placed enough pressure on the pad to activate it.

Preheat Notification Tone

When you set an oven temperature the oven automatically starts to heat. When the temperature inside the oven reaches your set temperature a tone will sound to let you know to place the food in the oven.

Attention Tone

This tone will sound if you set an invalid function or try to set an additional function. The tone can be quickly identified by watching the display messages.

SPECIAL FEATURES OF YOUR OVEN CONTROL

Your new touch pad control has additional features that you may choose to use. The following are the features and how you may activate them. The special feature modes can only be activated while the display is showing the time of day clock.

They remain in the control's memory until the steps are repeated. When the display shows your choice press START. The special features will remain in memory after a power failure.

Tones at the End of a Timed Cycle

At the end of a timed cycle, 3 short beeps will sound followed by one beep every 6 seconds, until CLEAR/OFF is pressed. This continuous 6 second beep may be canceled.

To cancel the 6 second beep:



1. Press the upper oven BAKE and BROIL HI/LO at the same time for 2 seconds until the display shows "SF."



2. Press TIMER ON/OFF. The display shows "CON BEEP" (continuous beep). Press TIMER ON/OFF again. The display shows "BEEP." (This cancels the one beep every 6 seconds.)



3. Press START.

NOTE: This cancels the end of cycle tone for both ovens.

Fahrenheit or Centigrade Temperature Selection

Your oven control is set to use the Fahrenheit temperature selections but you may change this to use the Centigrade selections.



1. Press the upper oven BAKE and BROIL HI/LO at the same time for 2 seconds until the display shows "SF."



2. Press BROIL HI/LO. The display will show "F" (Fahrenheit).

3. Press BROIL HI/LO again. The display will show "C" (Centigrade).



4. Press START. The new setting will be displayed for both ovens.



12 Hour Shut-Off

With this feature, should you forget and leave the oven on, the control will automatically turn off the oven after 12 hours during baking functions or after 3 hours during a broil function. If you wish to turn off this feature, follow the steps below.



1. Press the upper oven BAKE and BROIL HI/LO at the same time for 2 seconds until the display shows "SF."



2. Press DELAY START. The display will show "12 shdn" (12 hour shut-off). Press DELAY START again and the display will show "no shdn" (no shut-off).



3. Press START to activate the no shut-off and leave the control set in this special features mode.

NOTE: This activates this special feature in both ovens.

Cook and Hold

Your new control has a cook and hold feature that keeps cooked foods warm for up to 3 hours after the cooking function is finished. To activate this feature, follow the steps below.



1. Press the upper oven BAKE and BROIL HI/LO at the same time for 2 seconds until the display shows "SF."

NOTE: Cook and hold in the upper and lower ovens will need to be set separately. Once you have completed step 1 follow the steps below pressing the upper or lower oven pads depending on which oven you want to use cook and hold in.



2. Press COOKING TIME. The display will show "Hld OFF."
—Press COOKING TIME again to activate the feature. The display will show "Hld ON."



3. Press START to activate the cook and hold feature and leave the control set in this special features mode.

12 Hour, 24 Hour or Clock Black-Out

Your control is set to use a 12 hour clock. If you would prefer to have a 24 hour military time clock or black-out the clock display, follow the steps below.



1. Press the upper oven BAKE and BROIL HI/LO at the same time for 2 seconds until the display shows "SF."



2. Press CLOCK once. The display will show "12 hr."
—Press CLOCK again to change to the 24 hour military time clock. The display will show "24 hr."
—Press CLOCK again to black-out the clock display. The display will show "OFF."



3. Press START to activate your choice and leave the control set in this special features mode.

NOTE: If the clock is in the black-out mode you will not be able to use the Delay Start function.

Control Lockout

Your control will allow you to lock down the touch pads so they cannot be activated when pressed.



1. Press the upper oven BAKE and BROIL HI/LO at the same time for 2 seconds until the display shows "SF."



2. Press AUTO SELF CLEAN. The display will show "LOC OFF."

—Press AUTO SELF CLEAN again. The display will show "LOC."



3. Press START to activate the control lockout feature and leave the control set in this special features mode.

When this feature is on and the touch pads are pressed the control will beep and the display will show "LOC."

NOTE:

- This activates this special feature in both ovens.
- The control lockout mode will not affect the clock, timer and oven light touch pads.



USING YOUR OVEN

Before Using Your Oven

1. Look at the controls. Be sure you understand how to set them properly. Read over the directions for the Oven Controls so you understand how to use them.
2. Check the inside of the oven. Look at the shelves. Take a practice run at removing and replacing them properly to give sure, sturdy support.
3. Read over the information and tips that follow.
4. Keep this guide handy so you can refer to it, especially during the first weeks of using your new oven.

NOTE:

- You may notice a “burning” or “oily” smell the first few times you turn your oven on. This is normal in a new oven and will disappear in a short time. To speed the process, set a self-clean cycle for 4 hours. See the Self-Cleaning Oven section.
- A cooling fan may automatically turn on and off to cool internal parts. This is normal, and the fan may continue to run even after the oven is turned off.
- You will hear a convection fan while cooking with the convection feature. The fan will stop when the door is opened, but the heat will not turn off.

Oven Shelves

The shelves are designed with stop-locks so that, when placed correctly on the shelf supports, they will stop before coming completely out of the oven, and will not tilt when you are removing food from them or placing food on them.

When placing cookware on a shelf, pull the shelf out to the bump on the shelf support. Place the cookware on the shelf, then slide the shelf back into the oven. This will eliminate reaching into the hot oven.

To remove a shelf from the oven, pull it toward you, tilt the front end upward and pull the shelf out. Be sure the shelf is cool before touching it.

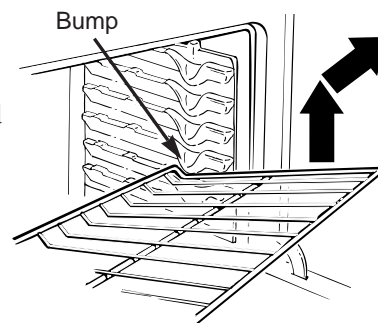

To replace, place the shelf on the shelf support with the stop-locks (curved extension of shelf) facing up and toward the rear of the oven. Tilt up the front and push the shelf toward the back of the oven until it goes past the bump on the shelf support. Then lower the front of the shelf and push it all the way back.

NOTE: The shelves for the convection oven are 2 inches shorter than the regular oven shelves.

Shelf Positions

The oven has seven shelf supports identified in this illustration as A (bottom), B, C, D, E, F and G (top).

Shelf positions for cooking are suggested in the Convection Cooking, Baking, Roasting and Broiling sections.

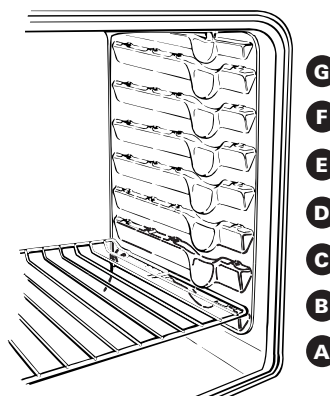

CONVECTION COOKING



What is Convection?

In a convection oven, a fan circulates hot air over, under and around the food. This circulating hot air is evenly distributed throughout the oven cavity. As a result, foods are evenly cooked and browned—often in less time with convection heat.

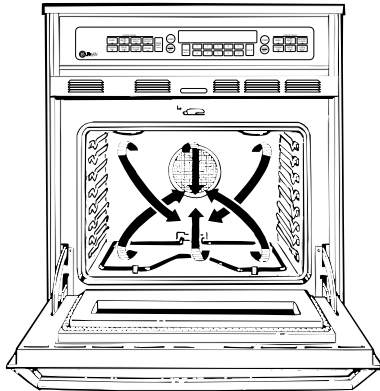

Because food is heated faster in a convection oven when using the convection modes, many types of food can be cooked at lower temperatures than those suggested for regular ovens. Do remember that recipe books often give times and temperatures for cooking in regular ovens. Convection ovens make it possible to reduce the temperature by 25°F.

CAUTION: The convection oven fan shuts off when the oven door is opened. **DO NOT** leave the door open for long periods of time while using convection cooking or you may shorten the life of the convection heating element.

When Should You Use Convection Bake or Convection Roast?

To help you understand the difference between convection bake and roast and traditional bake and roast, here are some general guidelines.

In convection bake, heat comes from the heating element in the rear of the oven. The convection fan circulates the heated air evenly, over and around the food. Preheating is not necessary with foods having a bake time of over 15 minutes.

In regular baking, the bottom oven element heats the air in the oven which then cooks the food.

Convection Bake

- Ideal for baked foods cooked on 3 or more shelves. (Additional shelves may be ordered. Pub No. 3-A014.)
- Good for large quantities of baked foods.
- Good results with cookies, biscuits, brownies, cream puffs, sweet rolls, angel food cake and bread.

Regular Bake

- Foods such as layer cakes have a more level top crust when not baked with convection heat.

In convection roast, heat comes from the top oven element. The convection fan circulates the heated air evenly over and around the food. Meat and poultry are browned on all sides as if they were cooked on a rotisserie. Using the roasting rack provided, heated air will be circulated over, under and around the food being roasted. The heated air seals in juices quickly for a moist and tender product while, at the same time, creating a rich golden brown exterior.

Convection Roast

- Large tender cuts of meat, uncovered.
- Roasting pans with low sides to allow air movement around food.

Regular Roast

- Less tender cuts of meat because these need to cook a long time in liquid to become tender.
- Cooking bag
- Foil tent
- Covered dish

Cookware for Convection Cooking

Before using your convection oven, check to see if your cookware leaves room for air circulation in the oven. If you are baking with several pans, leave space between them. Also, be sure the pans do not touch each other or the walls of the oven.

Metal and Glass

Any type of cookware will work in your convection oven. However, metal pans heat the fastest and are recommended for convection baking.

- Darkened or matte-finished pans will bake faster than shiny pans.
- Glass or ceramic pans cook more slowly.

Paper and Plastic

Heat-resistant paper and plastic containers that are recommended for use in regular ovens can be used in convection ovens. Plastic cookware that is heat-resistant to temperatures of 400°F. can also be used.

When baking cookies, you will get the best results if you use a flat cookie sheet instead of a pan with low sides.

For recipes like oven-baked chicken, you should use a pan with low sides. Hot air cannot circulate well around food in a pan with high sides.



CONVECTION BAKING

(upper oven only)

As a general rule, reduce the temperature by 25°F. for convection baking.

Preheating is not necessary with foods having a bake time of over 15 minutes.

Check foods for doneness at the minimum suggested cooking time.

Use pan size recommended in the recipe.

Multi-Shelf Baking

Because heated air is circulated evenly throughout the oven, foods can be baked with excellent results on two, three or more shelves at a time. Multi-shelf baking may increase cook times slightly for some foods but the overall result is time saved. Multi-shelf baking provides very good results with cookies, biscuits and other quickbreads.

When baking on three shelves, place one shelf in the bottom (A) position, one on the third (C) position and one in the fifth (E) position.



NOTE: When convection baking with only one shelf, follow the shelf positions recommended in Oven Shelves in the Baking section.

CAUTION: Be very careful not to burn your hand on the door when using a shelf in the lowest position (A).

How to Set Your Oven for Convection Baking

To avoid possible burns, place the shelves in the correct position before you turn the oven on.



1. Press CONVECTION BAKE.



2. Press the number pads to set the temperature.

3. Press START. When the oven starts to heat the changing temperature will be in the display. (The display starts changing once the temperature reaches 100°F.)



4. Press CLEAR/OFF when baking is finished.

NOTE:

- You will hear a convection fan while cooking with this feature. The fan will stop when the door is opened, but the heat will not turn off.
- A cooling fan may turn on and off to cool internal parts. This is normal, and the fan may continue to run even after the oven is turned off.

To change the oven temperature during the Convection Bake cycle, press CONVECTION BAKE and set the new temperature.

TIMED CONVECTION BAKING

(upper oven only)



How to Convection Time Bake

The oven control allows you to turn the oven on or off automatically at specific times that you set. Examples of Immediate Start (oven turns on now and you set it to turn off automatically at the end of cooking time) and Delay Start and Stop (setting the oven to turn on automatically at a later time and turn off after a preset cooking time) will be described.

NOTE: Before beginning, make sure the oven clock shows the correct time of day.

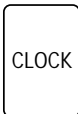

To set the clock, first press **CLOCK**. Press the number pads to set the time of day. Press **START**.

- You can use Timed Bake in one oven while using Self-Clean in the other.
- You can use Timed Bake in both ovens at the same time.

NOTE: An attention tone will sound if you are using Timed Baking and do not press **START** after entering the baking temperature.

How to Set Immediate Start and Automatic Stop Convection Bake

To avoid possible burns, place the oven shelves in the correct position before you turn the oven on.

The oven will turn on immediately and cook for a specific length of time. At the end of cooking time, the oven will turn off automatically.



1. Press **CONVECTION BAKE**.

2. Press the number pads to set the temperature.



3. Press **COOKING TIME**.

NOTE: If your recipe requires preheating, you may need to add additional time to the length of the cooking time.

4. Press the number pads to set the length of baking time.

The oven temperature that you set and the cooking time that you entered will be in the display.



5. Press **START**.

The display shows the changing oven temperature and cooking time countdown. (The display starts changing once the temperature reaches 100°F.)



6. Press **CLEAR/OFF** to clear the end of cycle tone if necessary.

NOTE:

- The low temperature zone of this oven (between 170°F. and 200°F.) is available to keep hot cooked foods warm. Food kept in the oven longer than two hours at these low temperatures may spoil.
- Foods that spoil easily, such as milk, eggs, fish, stuffings, poultry and pork, should not be allowed to sit for more than one hour before or after cooking. Room temperature promotes the growth of harmful bacteria. Be sure the oven light is off because heat from the bulb will speed harmful bacteria growth.

(continued next page)



TIMED CONVECTION BAKING

(upper oven only—continued)

How to Set Delay Start and Automatic Stop Convection Bake

Easy Steps:

1. Press CONVECTION BAKE.
2. Press the number pads to set the oven temperature.
3. Press COOKING TIME.
4. Press the number pads to set the length of baking time.
5. Press DELAY START.
6. Press the number pads to set the desired start time.
7. Press START.

To avoid possible burns, place the shelves in the correct position before you program the oven.

You can set the control to delay the start of cooking, cook for a specific length of time and turn off automatically.



1. Press CONVECTION BAKE.

2. Press the number pads to set baking temperature.



3. Press COOKING TIME.

NOTE: If your recipe requires preheating, you may need to add additional time to the length of the cooking time.

4. Press the number pads to set baking time.



5. Press DELAY START.

6. Press the number pads to set the time of day you want the oven to turn on and start cooking.



7. Press START.



If you would like to check the times you have set, press DELAY START to check the start time you have set or press COOKING TIME to check the length of cooking time you have set.

When the oven turns on at the time of day you have set, the display will show the changing temperature (starting at 100°F.) and the cooking time countdown.

At the end of cooking time the oven will turn off and the end of cycle tone will sound.



8. Press CLEAR/OFF to clear the end of cycle tone if necessary.

NOTE:

- The low temperature zone of this oven (between 170°F. and 200°F.) is available to keep hot cooked foods warm. Food kept in the oven longer than two hours at these low temperatures may spoil.
- Foods that spoil easily, such as milk, eggs, fish, stuffings, poultry and pork, should not be allowed to sit for more than one hour before or after cooking. Room temperature promotes the growth of harmful bacteria. Be sure the oven light is off because heat from the bulb will speed harmful bacteria growth.

Using Convection Conversion

By using the Convection Conversion feature you can automatically convert the oven temperature from regular baking to Convection Bake temperatures.

To convert the oven temperature for convection baking:



1. Press and hold CONVECTION BAKE for 4 to 5 seconds.

2. Using the number pads enter the temperature recommended in the recipe.



3. Press START.

The display shows the converted (reduced) temperature.

For example: If you entered a recipe temperature of 350°F., the display will show 325°F. when it is converted.



4. Press CLEAR/OFF when baking is finished.

NOTE: Conversion must be set each time you want to use it. It is not held in memory.

CONVECTION ROASTING

(upper oven only)



Meats cooked in a convection oven are dark brown on the outside and tender and juicy on the inside. In most cases, cooking time will be less when using the Convection Roast feature. Sometimes cooking time is reduced by 10 minutes per hour.

To make sure the meat is cooked the way you want it, we recommend using the temperature probe provided with the oven. Your double oven has a probe in the upper oven only.

The special roasting rack allows heated air to circulate over and under the meat. This allows the meat to brown on all sides.

NOTE:

- Use the temperature recommended in the Convection Roasting Guide.
- Preheating is not necessary.
- Check foods for doneness at the minimum suggested time.
- Use the special roasting rack with the broiler pan and grid.

Convection Roasting Rack

Roasts or poultry should be cooked on the lowest shelf position (A).

When you are convection roasting you will use the broiler pan and grid and the special roasting rack.

The pan is used to catch grease spills and the grid is used to prevent grease splatters. The rack holds the meat.

1. Place the shelf in the lowest shelf position (A).
2. Place the grid on the broiler pan and put the roasting rack over them making sure the posts on the roasting rack fit into the holes in the broiler pan.

3. Place the meat on the special roasting rack.

See the Roasting with the Probe section to insert the probe correctly.

NOTE: It is important that the broiler pan and grid be used with the roasting rack for best convection roasting results.

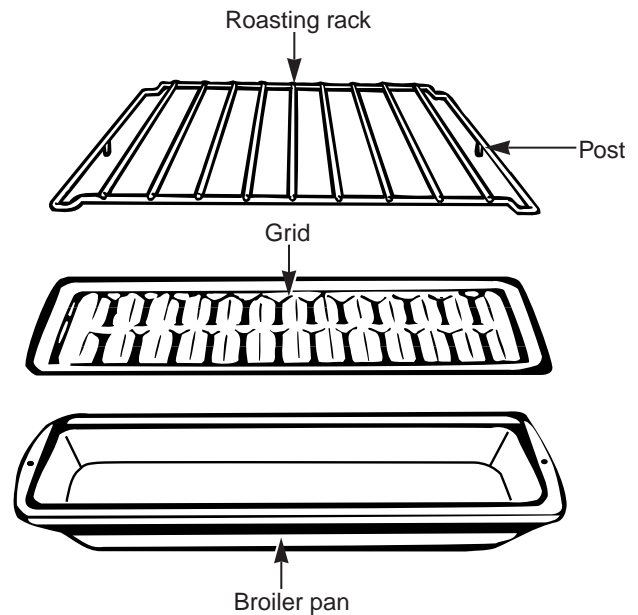

(continued next page)



CONVECTION ROASTING

(upper oven only—continued)

How to Set Your Oven for Convection Roasting When Using the Temperature Probe

NOTE: For best results when roasting large turkeys and roasts, we recommend using the probe included in the convection oven. For the correct placement of the probe, see the description in the Roasting section.

The display will flash if the probe is inserted into the outlet and you have not set a probe temperature and pressed START.

1. Place the shelf in the lowest position (A). Insert the probe into the meat.

2. Plug the probe into the outlet in the oven. Make sure it is pushed all the way in. Close the oven door.

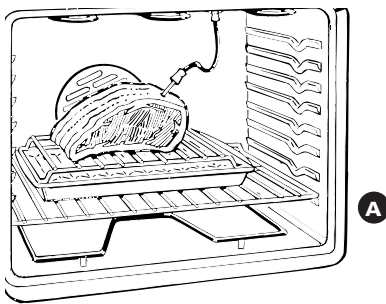

3. Press CONVECTION ROAST.



4. Press the number pads to set the oven temperature.

5. Press PROBE.



6. Press the number pads to set the internal meat temperature.

7. Press START.



The word “LO” will be in the display. After the internal temperature of the meat reaches 100°F., the changing internal temperature will be shown in the display.



8. When the internal temperature of the meat reaches the temperature you have set, the probe and the oven turn off and the oven control signals. To stop the signal, press CLEAR/OFF. Use hot pads to remove the probe from the food. Do not use tongs to pull on it—they might damage it.

CAUTION: To prevent possible burns, do not unplug the probe from the oven outlet until the oven has cooled. Do not store the probe in the oven.

NOTE:

- You cannot use a timed oven operation when using the probe. You can use the TIMER ON/OFF for timing the cooking time.
- You will not be able to use the probe in the upper oven during timed oven operations. This is because with the probe you are cooking by temperature rather than time.

To change the oven temperature during the Convection Roast cycle, press CONVECTION ROAST and set the new temperature.

CONVECTION ROASTING GUIDE



Meats		Minutes/Lb.	Oven Temperature (°F.)	Internal Temperature (°F.)		
Beef	Rib, Boneless Rib,	Rare	20–24	325°	140°†	
	Top Sirloin (3 to 5 lbs.)	Medium	24–28	325°	160°	
		Well	28–32	325°	170°	
	Beef Tenderloin	Rare	10–14	325°	140°†	
		Medium	14–18	325°	160°	
	Pot Roast (2½ to 3 lbs.)	Chuck, Rump	35–45	300°	170°	
Pork	Bone-in, Boneless (3 to 5 lbs.)		23–27	325°	170°	
	Chops	2 chops	30–35 total	325°	170°	
	(1/2 to 1-inch thick)	4 chops	35–40 total	325°	170°	
		6 chops	40–45 total	325°	170°	
Ham	Canned, Butt, Shank (3 to 5 lbs. fully cooked)		14–18	325°	140°	
Lamb	Bone-in, Boneless		17–20	325°	160°	
	(3 to 5 lbs.)	Medium Well	20–24	325°	170°	
Seafood	Fish, whole (3 to 5 lbs.)		30–40 total	400°		
	Lobster Tails (6 to 8 oz. each)		20–25 total	350°		
Poultry	Whole Chicken		24–26	350°	180°–185°	
	(2½ to 3½ lbs.)					
	Cornish Hens	Unstuffed (1 to 1½ lbs.)		50–55 total	350°	180°–185°
		Stuffed (1 to 1½ lbs.)		55–60 total	350°	180°–185°
	Duckling (4 to 5 lbs.)			24–26	325°	180°–185°
	Turkey, whole*	Unstuffed (10 to 16 lbs.)		8–11	325°	180°–185°
Unstuffed (18 to 24 lbs.)		7–10	325°	180°–185°		
	Turkey Breast (4 to 6 lbs.)		16–19	325°	170°	

*Stuffed birds generally require 30–45 minutes additional roasting time. Shield legs and breast with foil to prevent over-browning and drying of skin.

†The U. S. Department of Agriculture says “Rare beef is popular, but you should know that cooking it to only 140°F. means some food poisoning organisms may survive.” (Source: *Safe Food Book. Your Kitchen Guide.* USDA Rev. June 1985.)

BAKING

Your oven temperature is controlled very accurately using an oven control system. It is recommended that you operate the oven for a number of weeks to become familiar with your new oven’s performance.

If you think an adjustment is necessary, see the Adjust the Oven Thermostat section. It lists easy *Do It Yourself* instructions on how to adjust the thermostat.

How to Set Your Oven for Baking

To avoid possible burns, place shelves in the correct position before you turn the oven on.



1. Press **BAKE**.

2. Press the number pads to set the oven temperature.



3. Press **START**. When the oven starts to heat the changing temperature will be in the display. (The display starts changing once the temperature reaches 100°F.)



4. Press **CLEAR/OFF** when baking is finished.

NOTE:

- A cooling fan may automatically turn on and off to cool internal parts. This is normal, and the fan may continue to run even after the oven is turned off.

To change the oven temperature during the Bake cycle, press BAKE and set the new temperature.

(continued next page)



BAKING

(continued)

Oven Shelves

Arrange the oven shelf or shelves in the desired locations while the oven is cool. The correct shelf position depends on the kind of food and the browning desired. As a general rule, place most foods in the middle of the oven, on either shelf position C or D. See the chart for suggested shelf positions.

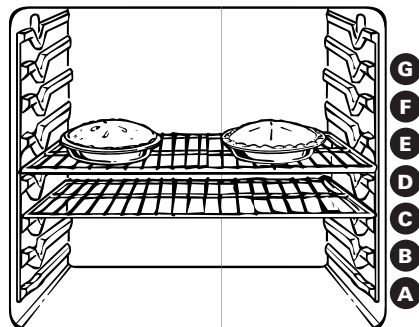

NOTE: To bake 4 layers of cake at one time, position 2 layers on shelf B and 2 layers on shelf D with the pans staggered so that one is not directly above the other.

Type of Food	Shelf Position
Angel food cake	B
Biscuits or muffins	C or D
Cookies or cupcakes	C or D
Brownies	C or D
Layer cakes	C or D
Bundt or pound cakes	B
Pies or pie shells	C or D
Frozen pies	B
Casseroles	C or D
Roasting	A or B

Preheating

Preheat the oven if the recipe calls for it. Preheat means bringing the oven up to the specified temperature before putting the food in the oven. To preheat, set the oven at the correct temperature—selecting a higher temperature does not shorten preheat time.

Preheating is necessary for good results when baking cakes, cookies, pastry and breads. For most casseroles and roasts, preheating is not necessary. For ovens without a preheat indicator light or tone, preheat 10 minutes. After the oven is preheated, place the food in the oven as quickly as possible to prevent heat from escaping.

Baking Pans

Use the proper baking pan. The type of finish on the pan determines the amount of browning that will occur.

- Dark, rough or dull pans absorb heat resulting in a browner, crisper crust. Use this type for pies.
- Shiny, bright and smooth pans reflect heat, resulting in a lighter, more delicate browning. Cakes and cookies require this type of pan.
- Glass baking dishes also absorb heat. When baking in glass baking dishes, reduce the temperature by 25°F.
- If you are using dark non-stick pans, you may find that you need to reduce the oven temperature 25°F. to prevent over-browning.

Pan Placement

For even cooking and proper browning, there must be enough room for air circulation in the oven. Baking results will be better if baking pans are centered as much as possible rather than being placed to the front or to the back of the oven.

Pans should not touch each other or the walls of the oven. Allow 1- to 1½-inch space between pans as well as from the back of the oven, the door and the sides. If you need to use two shelves, stagger the pans so one is not directly above the other.



Cookies

When baking cookies, flat cookie sheets (without sides) produce better-looking cookies. Cookies baked in a jelly roll pan (short sides all around) may have darker edges and pale or light browning may occur.

Do not use a cookie sheet so large that it touches the walls or the door of the oven. Never entirely cover a shelf with a large cookie sheet.

For best results during baking, use only one cookie sheet in the oven at a time.

Also see the Multi-Shelf Baking section.

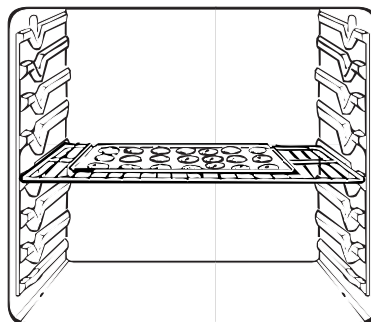

Pies

For best results, bake pies in dark, rough or dull pans to produce a browner, crisper crust. Frozen pies in foil pans should be placed on an aluminum cookie sheet for baking since the shiny foil pan reflects heat away from the pie crust; the cookie sheet helps retain it.

Cakes

When baking cakes, warped or bent pans will cause uneven baking results and poorly shaped products. A cake baked in a pan larger than the recipe recommends will usually be crisper, thinner and drier than it should be. If baked in a pan smaller than recommended, it may be undercooked and batter may overflow. Check the recipe to make sure the pan size used is the one recommended.

Aluminum Foil

Never entirely cover a shelf with aluminum foil. This will disturb the heat circulation and result in poor baking. A smaller sheet of foil may be used to catch a spillover by placing it on a lower shelf several inches below the food.

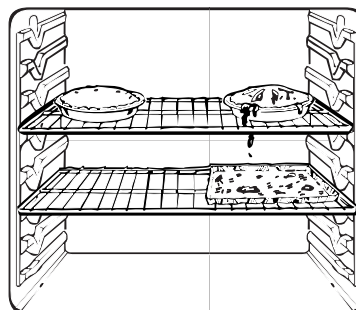

Don't Peek

Set the timer for the estimated cooking time and do not open the door to look at your food. Most recipes provide minimum and maximum baking times such as "bake 30-40 minutes."

DO NOT open the door to check until the minimum time. Opening the oven door frequently during cooking allows heat to escape and makes baking times longer. Your baking results may also be affected.



TIMED BAKING

How to Set Your Oven for Time Bake

The oven control allows you to turn the oven on or off automatically at specific times that you set. Examples of Immediate Start (oven turns on now and you set it to turn off automatically at the end of cooking time) and Delay Start and Stop (setting the oven to turn on automatically at a later time and turn off after a preset cooking time) will be described.

NOTE: Before beginning make sure the clock shows the correct time of day.

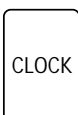

To set the clock, first press **CLOCK**. Press the number pads to set the time of day. Press **START**.

- You can use Timed Bake in one oven while using Self-Clean in the other.
- You can use Timed Bake in both ovens at the same time.

NOTE: An attention tone will sound if you are using Timed Baking and do not press **START** after entering the baking temperature.

How to Set Immediate Start and Automatic Stop

To avoid possible burns, place the shelves in the correct position before you turn the oven on.

The oven will turn on immediately and cook for a selected length of time. At the end of cooking time, the oven will turn off automatically.



1. Press **BAKE**.

2. Press the number pads to set the oven temperature.



3. Press **COOKING TIME**.

NOTE: If your recipe requires preheating, you may need to add additional time to the length of the cooking time.

4. Press the number pads to set the baking time.

The oven temperature and the cooking time that you entered will be displayed.



5. Press **START**. The display shows the oven temperature that you set and the cooking time countdown. (The display starts changing once the temperature reaches 100°F.)

The oven will continue to cook for the programmed amount of time, then shut off automatically.



6. Press **CLEAR/OFF** to clear the end of cycle tone if necessary.

NOTE:

- The low temperature zone of this oven (between 170°F. and 200°F.) is available to keep hot cooked foods warm. Food kept in the oven longer than two hours at these low temperatures may spoil.
- Foods that spoil easily, such as milk, eggs, fish, stuffings, poultry and pork, should not be allowed to sit for more than one hour before or after cooking. Room temperature promotes the growth of harmful bacteria. Be sure the oven light is off because heat from the bulb will speed harmful bacteria growth.



How to Set Delay Start and Automatic Stop

Easy Steps:

1. Press **BAKE**.
2. Press the number pads to select oven temperature.
3. Press **COOKING TIME**.
4. Press the number pads to set the length of baking time.
5. Press **DELAY START**.
6. Press the number pads to set the desired start time.
7. Press **START**.

To avoid possible burns, place the shelves in the correct position before you turn the oven on.

You can set the control to delay the start of cooking, cook for a specific length of time and then turn off automatically.



1. Press **BAKE**.

2. Press the number pads to set the temperature.



3. Press **COOKING TIME**.

NOTE: If your recipe requires preheating, you may need to add additional time to the cooking time.

4. Press the number pads to set the baking time.



5. Press **DELAY START**.

6. Press the number pads to set the time of day you want the oven to turn on and start cooking.



7. Press **START**.



If you would like to check the times you have set, press **DELAY START** to check the start time you have set or press **COOKING TIME** to check the length of cooking time you have set.

When the oven turns on at the time of day you have set, the display will show the changing temperature (starting at 100°F.) and the cooking time countdown.

At the end of cooking time the oven will turn off and the end of cycle tone will sound.



8. Press **CLEAR/OFF** to clear the end of cycle tone if necessary.

NOTE:

- The low temperature zone of this oven (between 170°F. and 200°F.) is available to keep hot cooked foods warm. Food kept in the oven longer than two hours at these low temperatures may spoil.
- Foods that spoil easily, such as milk, eggs, fish, stuffings, poultry and pork, should not be allowed to sit for more than one hour before or after cooking. Room temperature promotes the growth of harmful bacteria. Be sure the oven light is off because heat from the bulb will speed harmful bacteria growth.



ADJUST THE OVEN THERMOSTAT— *DO IT YOURSELF!*

You may find that your new oven cooks differently than the one it replaced. We recommend that you use your new oven for a few weeks to become more familiar with it, following the times given in your recipes as a guide.

If you think your new oven is too hot or too cool, you can adjust the thermostat yourself. If you think it is too hot, adjust the thermostat to make it cooler. If you think it is too cool, adjust the thermostat to make it hotter.

We do not recommend the use of inexpensive thermometers, such as those found in grocery stores, to check the temperature setting of your new oven. These thermometers may vary 20–40 degrees.

The thermostat adjustment for Baking also affects Convection Baking and Convection Roasting.

To Adjust the Thermostat:



1. Press the upper oven BAKE and BROIL HI/LO at the same time for 2 seconds until the display shows “SF.”

NOTE: The thermostats in the upper and lower ovens need to be adjusted separately. Once you have completed step 1 follow the steps below pressing the upper or lower oven pads depending on which oven thermostat you want to adjust.



2. Press BAKE. A two digit number shows in the display. Press BAKE once to increase (+) the oven temperature, or twice to decrease (-).

3. The oven temperature can be adjusted up to (+) 35°F. hotter or (-) 35°F. cooler. Press the number pads the same way you read them. **For example,** to increase the oven temperature 15°F., press 1 and 5.



4. When you have made the adjustment, press START to go back to the time of day display. Use your oven as you would normally.

NOTE: This adjustment will not affect the broiling or self-cleaning temperatures. It will be retained in memory after a power failure.

ROASTING

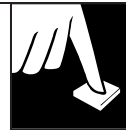

Roasting is cooking by dry heat. Tender meat or poultry can be roasted uncovered in your oven. Roasting temperatures, which should be low and steady, keep spattering to a minimum.

Roasting is really a baking procedure used for meats. Therefore, the oven controls are set for Baking or Timed Baking. (You may hear a slight clicking sound, indicating the oven is working properly.) Timed Baking will turn the oven on and off automatically.

Most meats continue to cook slightly after being removed from the oven. The internal temperature will rise about 5° to 10°F. during the recommended standing time of 10 to 20 minutes. This allows roasts to firm up and makes them easier to carve. To compensate for this rise in temperature, you may want to remove the roast sooner (at 5° to 10°F. less than the temperature in the Roasting Guide).

Remember that food will continue to cook in the hot oven and therefore should be removed when the desired internal temperature has been reached.

How to Set Your Oven for Roasting

1. Place the shelf in A or B position. No preheating is necessary.

2. Check the weight of the meat. Place the meat fat side up, or poultry breast side up, on roasting grid in a shallow pan. The melting fat will baste the meat. Select a pan as close to the size of the meat as possible.

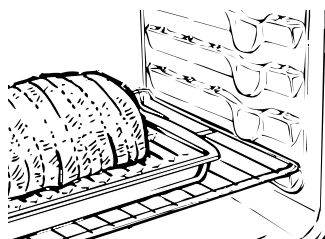

(The broiler pan with grid is a good pan for this.)



3. Press BAKE.



4. Press the number pads to set the temperature.

5. Press START.



6. Press CLEAR/OFF when roasting is finished.

To change the oven temperature during the roasting cycle, press BAKE and set the new temperature.

Use of Aluminum Foil

You can use aluminum foil to line the broiler pan. This makes clean-up easier when using the pan for marinating, cooking with fruits, cooking heavily cured meats or basting food during cooking. Press the foil tightly around the inside of the pan.

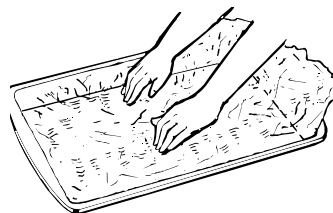

(continued next page)



ROASTING WITH THE PROBE

See the Roasting Guide (upper oven only)

Correct Placement of the Temperature Probe

Your double oven has a probe in the upper oven only.

A temperature probe has been provided for use in your new oven. This probe is designed to withstand high temperatures. Temperature probes provided with other products, such as those used for microwave ovens, may not be designed to withstand high temperatures. Use of probes other than the one provided with this product may result in damage to the probe.

Never leave your probe inside the oven during a self-cleaning cycle.

For many foods, especially roasts and poultry, internal food temperature is the best test for doneness. The temperature probe takes the guesswork out of roasting by cooking foods to the exact doneness you want. When the internal temperature of the food reaches the temperature you set, the oven automatically shuts off.

The temperature probe has a skewer-like probe at one end and a plug at the other end that goes into the outlet in the oven.

Use the handles of the probe and plug when inserting and removing them from the meat and the outlet in the oven. Do not use tongs to pull on the cable when removing the probe—they might damage it. **TO AVOID BREAKING THE PROBE, MAKE SURE FOOD IS COMPLETELY DEFROSTED BEFORE INSERTING.**

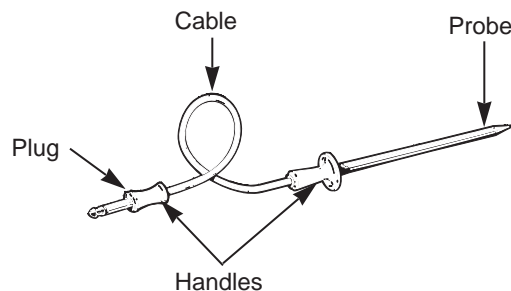

(appearance may vary)

After preparing the meat and placing it on a trivet or the broiler pan grid, follow these steps for proper probe placement.

1. Lay the probe on the outside of the meat along the top or side and mark with your finger where the edge of the meat comes to on the probe. Point should rest in the center of the thickest meaty part of the roast.

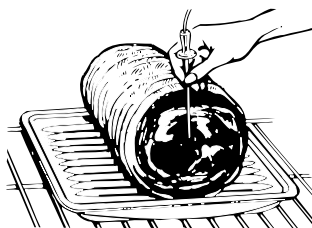

2. Insert the probe into the meat up to the point marked off with your finger. It should not touch bone, fat or gristle. *No more than 2 inches of the probe, not counting the handle, should be left exposed outside the meat.*

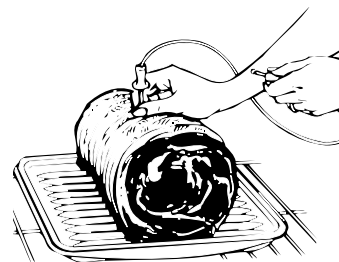

Ham or Lamb

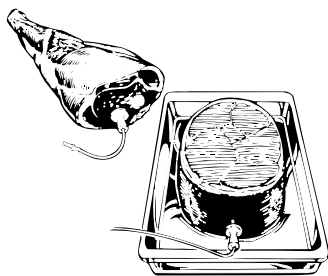

Insert the probe into the cut end, the meatiest part of ham or lamb without a bone. For bone-in ham or lamb, insert the probe into the center of the lowest large muscle or joint.

Casseroles or Fish

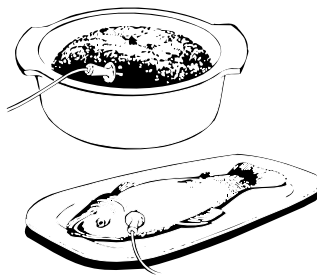

Insert the probe into the center of dishes such as meat loaf or casseroles. When cooking fish, insert the probe from just above the gill into meatiest area, parallel to the backbone.

Poultry

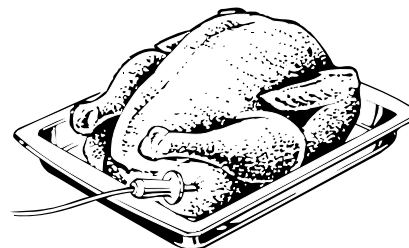

Insert the probe into the meatiest part of the inner thigh from below and parallel to the leg of a whole turkey.

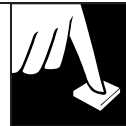

How to Set the Oven When Using the Temperature Probe

The display will flash if the probe is inserted into the outlet and you have not set a probe temperature and pressed START.

1. Insert the probe into the meat.
2. Plug the probe into the outlet in the oven. Make sure it's pushed all the way in. Close the oven door.

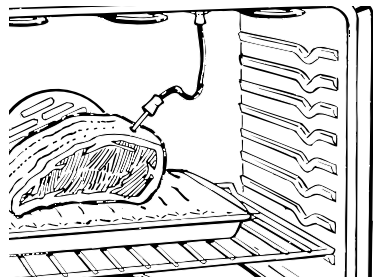

3. Press PROBE.

4. Press the number pads to set the internal meat temperature.



5. Press BAKE.

6. Press the number pads to set the oven temperature.



7. Press START.

The word "LO" will be in the display. After the internal temperature of the meat reaches 100°F., the changing internal temperature will be shown in the display.



8. When the internal temperature of the meat reaches the temperature you have set, the probe and the oven turn off and the oven control signals. To stop the signal, press CLEAR/OFF. Use hot pads to remove the probe from the food. Do not use tongs to pull on it—they might damage it.

CAUTION: To prevent possible burns, do not unplug the probe from the outlet until the oven has cooled. Do not store the probe in the oven.

NOTE: You can use the timer even though you cannot use timed oven operations.

To change the oven temperature during the roasting cycle, press BAKE and set the new temperature.



ROASTING

(continued)

Questions and Answers

Q. Is it necessary to check for doneness with a meat thermometer?

A. Checking the finished internal temperature at the completion of cooking time is recommended if you did not use the probe while cooking. Temperatures are shown in the Roasting Guide. For roasts over 8 lbs., check with thermometer at half-hour intervals after half the cooking time has passed.

Q. Why is my roast crumbling when I try to carve it?

A. Roasts are easier to slice if allowed to cool 10 to 20 minutes after removing them from the oven. Be sure to cut across the grain of the meat.

Q. Do I need to preheat my oven each time I cook a roast or poultry?

A. It is not necessary to preheat your oven.

Q. When buying a roast, are there any special tips that would help me cook it more evenly?

A. Yes. Buy a roast as even in thickness as possible, or buy rolled roasts.

Q. Can I seal the sides of my foil "tent" when roasting a turkey?

A. Sealing the foil will steam the meat. Leaving it unsealed allows the air to circulate and brown the meat.

ROASTING GUIDE

Frozen Roasts

Frozen roasts of beef, pork, lamb, etc., can be started without thawing, but allow 10 to 25 minutes per pound additional time (10 minutes per pound for roasts under 5 pounds, more time for larger roasts).

Make sure poultry is thawed before roasting. Unthawed poultry often does not cook evenly. Some commercial frozen poultry can be cooked successfully without thawing. Follow the directions given on the package label.

Type	Oven Temperature	Doneness	Approximate Roasting Time in Minutes per Pound		Internal Temperature °F.
Meat			3 to 5 lbs.	6 to 8 lbs.	
Tender cuts; rib, high quality sirloin tip, rump or top round†	325°	Rare: Medium: Well Done:	24–33 35–39 40–45	18–22 22–29 30–35	140°–150°* 150°–160° 170°–185°
Lamb leg or bone-in shoulder†	325°	Rare: Medium: Well Done:	21–25 25–30 30–35	20–23 24–28 28–33	140°–150°* 150°–160° 170°–185°
Veal shoulder, leg or loin†	325°	Well Done:	35–45	30–40	170°–180°
Pork loin, rib or shoulder†	325°	Well Done:	35–45	30–40	170°–180°
Ham, precooked	325°	To Warm:	17–20 minutes per pound (any weight)		115°–125°
Poultry			3 to 5 lbs.	Over 5 lbs.	
Chicken or Duck	325°	Well Done:	35–40	30–35	185°–190°
Chicken pieces	350°	Well Done:	35–40		185°–190°
Turkey	325°	Well Done:	10 to 15 lbs. 18–25	Over 15 lbs. 15–20	In thigh: 185°–190°

†For boneless rolled roasts over 6 inches thick, add 5 to 10 minutes per pound to times given above.

*The U.S. Department of Agriculture says "Rare beef is popular, but you should know that cooking it to only 140°F. means some food poisoning organisms may survive." (Source: *Safe Food Book. Your Kitchen Guide*. USDA Rev. June 1985.)

BROILING



Broiling is cooking food by intense radiant heat from the upper broil element in the oven. Most fish and tender cuts of meat can be broiled. Follow these directions to keep spattering and smoking to a minimum.

If the meat has fat or gristle around the edge, cut vertical slashes through both about 2 inches apart. If desired, the fat may be trimmed, leaving a layer about 1/8 inch thick.

Place the meat on the broiler grid in the broiler pan. Always use the grid so the fat drips into the broiler pan; otherwise the juices may become hot enough to catch on fire.

Position a shelf on recommended shelf position as suggested in the Broiling Guide. Most broiling is done on E position, **but if your oven is connected to 208 volts, you may wish to use a higher position.**

Leave the door open to the broil stop position. The door stays open by itself, yet the proper temperature is maintained in the oven.

Turn the food using tongs only once during broiling. Time the foods for the first side according to the Broiling Guide.

Turn the food, then use the times given for the second side as a guide to the preferred doneness.

NOTE: Broil will not work if the temperature probe is plugged in.

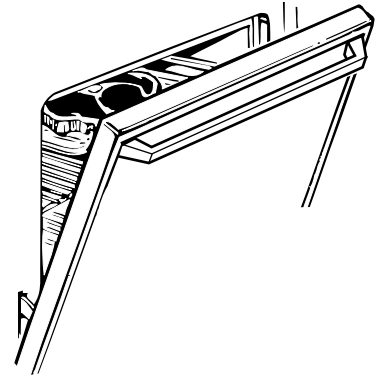

How to Set Your Oven for Broiling



1. Press BROIL HI/LO.

2. Press BROIL HI/LO again (alternates between LO Broil and HI Broil).

3. Press START.

4. Press CLEAR/OFF when broiling is finished.



(continued next page)



BROILING

(continued)

Use of Aluminum Foil

You can use aluminum foil to line your broiler pan and broiler grid. However, you must mold the foil tightly to the grid and cut slits in it just like the grid.

Without the slits, the foil will prevent fat and meat juices from draining into the broiler pan. The juices could become hot enough to catch on fire. If you do not cut the slits, you are frying, not broiling.

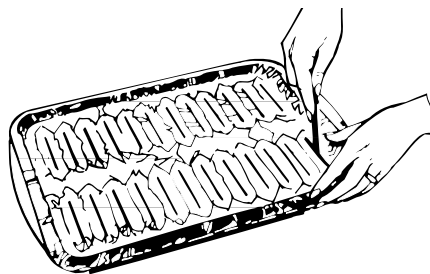

Questions and Answers

Q. When broiling, is it necessary to always use a grid in the pan?

A. Yes. Using the grid suspends the meat over the pan. As the meat cooks, the juices fall into the pan, thus keeping meat drier. Juices are protected by the grid and stay cooler, thus preventing excessive spatter and smoking.

Q. Should I salt the meat before broiling?

A. No. Salt draws out the juices and allows them to evaporate. Always salt after cooking. Piercing the meat with a fork allows juices to escape. Turn the meat with tongs instead of a fork.

Q. Why are my meats not turning out as brown as they should?

A. In some areas, the power (voltage) to the oven may be low. In these cases, preheat the broil element for 10 minutes before placing the broiler pan with food in the oven. Check to see if you are using the recommended shelf position. Broil for the longest period of time indicated in the Broiling Guide. Turn the food only once during broiling. You may need to move the food to a higher shelf position.

BROILING GUIDE

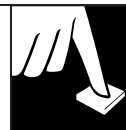

- Always use the broiler pan and grid that comes with your oven. It is designed to minimize smoking and spattering by trapping juices in the shielded lower part of the pan.
- **The oven door should be open to the broil stop position.**
- For steaks and chops, slash fat evenly around the outside edges of the meat. To slash, cut crosswise through the outer fat surface just to the edge of the meat. Use tongs to turn meat over to prevent piercing the meat and losing juices.
- If desired, marinate meats or chicken before broiling, or brush with barbecue sauce last 5 to 10 minutes only.
- When arranging food on the pan, do not let fatty edges hang over the sides because the dripping fat will soil the oven.
- The broiler does not need to be preheated. However, for very thin foods, or to increase browning, preheat if desired.
- Frozen steaks can be broiled by positioning the oven shelf at next lowest shelf position and increasing cooking time given in this guide 1½ times per side.
- Use LO Broil to cook foods such as poultry or thick pork chops thoroughly without over-browning them.
- **If your oven is connected to 208 volts**, rare steaks may be broiled by preheating the broiler and positioning the oven shelf one position higher.

Food	Quantity and/or Thickness	Shelf Position	First Side Time, Minutes	Second Side Time, Minutes	Comments
Ground Beef Well Done	1 lb. (4 patties)	E	10	7	Space evenly.
	1/2 to 3/4 inch thick 4 lbs. (16 patties)	E	10	9	
Beef Steaks	3/4 to 1 inch thick (1 to 1½ lbs.)	Rare	8	6	Steaks less than 3/4 inch thick are difficult to cook rare.
		Medium	10	8	
		Well Done	12	10	
	1½ inches thick (2 to 2½ lbs.)	Rare	10	8	Slash fat.
		Medium	15	14-16	
		Well Done	25	20-25	
Chicken	1 whole (2 to 2½ lbs.), split lengthwise	C	25	10	Brush each side with melted butter. Broil skin-side-down first.
	Breast	C	25	15	
Bakery Products Bread (Toast) or English Muffins	2 to 4 slices	F	3	1	Space evenly. Place English muffins cut-side-up and brush with butter, if desired.
	2 (split)	F	3-4		
Lobster Tails	2-4 (6 to 8 oz. each)	C	13-16	Do not turn over.	Cut through back of shell. Spread open. Brush with melted butter before broiling and after half of broiling time.
Fish	1-lb. fillets 1/4 to 1/2 inch thick	E	5	5	Handle and turn very carefully. Brush with lemon butter before and during cooking, if desired.
Ham Slices (precooked)	1/2 inch thick	D	6	6	
	1 inch thick	D	8	8	
Pork Chops Well Done	2 (1/2 inch thick)	E	10	10	Slash fat.
	2 (1 inch thick), about 1 lb.	D	15	15	
Lamb Chops	2 (1 inch thick), about 10 to 12 oz.	Medium	10	9	Slash fat.
		Well Done	12	10	
	2 (1½ inches thick), about 1 lb.	Medium	14	12	
		Well Done	17	12-14	



OPERATING THE SELF-CLEANING OVEN

(Normal Cleaning Time: 4 hours)

Before a Clean Cycle

1. Remove the broiler pan, broiler grid, all cookware and any aluminum foil from the oven—they can't withstand the high cleaning temperatures.

NOTE: The oven shelves and the convection roasting rack may be cleaned in the self-cleaning oven. However, they will darken, lose their luster and become hard to slide. Wipe the shelf supports with cooking oil after self-cleaning to make shelves slide more easily.

2. Wipe up heavy soil on the oven bottom. If you use soap, rinse thoroughly before self-cleaning to prevent staining.

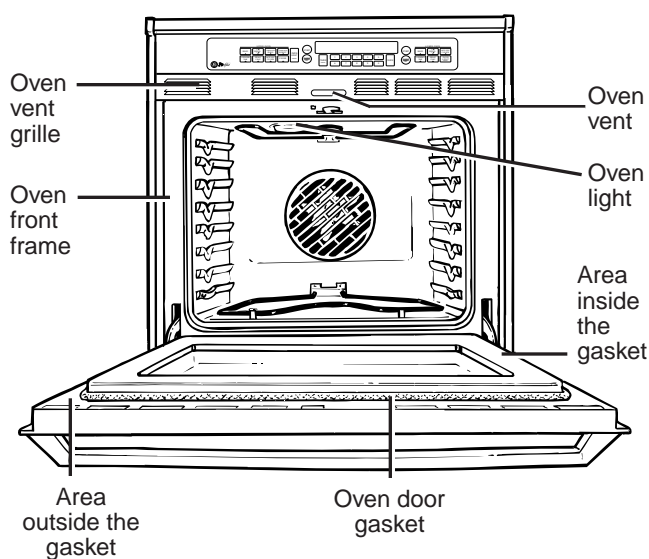

3. Clean spatters or soil on the oven front frame and the oven door **outside the gasket** with a dampened cloth. The oven front frame and the oven door outside the gasket do not get cleaned by the self-clean cycle. On these areas, use detergent and hot water or a soap-filled steel wool pad. Rinse well with a vinegar and water solution. This will help prevent a brown residue from forming when the oven is heated. Buff these areas with a dry cloth. Do not clean the gasket.

Clean the outside front of the oven door with soap and water. Also use soap and water to clean under the oven vent grille. **Do not use abrasives or oven cleaners.**

Make sure the oven light bulb cover is in place.

Do not rub or clean the door gasket—the fiberglass material of the gasket has an extremely low resistance to abrasion. An intact and well-fitting oven door gasket is essential for energy-efficient oven operation and good baking results. If you notice the gasket becoming worn, frayed or damaged in any way or if it has become displaced on the door, you should have it replaced.

Do not let water run down through openings in the top of the door. To help prevent water from getting in these slots when cleaning, open the door as far as it will go.

4. Close the oven door and make sure the oven light is off. If the oven light is not turned off, the life of the bulb will be shortened or it may burn out immediately. The door latches automatically after the clean cycle is set.

Do not use commercial oven cleaners or oven protectors in or near the self-cleaning oven.

A combination of any of these products plus the high clean-cycle temperature may damage the porcelain finish of the oven.

Important:

The oven door must be closed and all controls must be set correctly for the cycle to work properly.

- You can set a clean cycle in both ovens at the same time. The last oven set will automatically delay its start until the end of the first oven's clean cycle.
- You can use Timed Bake in one oven and Self-Clean in the other at the same time.

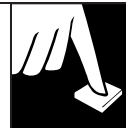

How to Set Oven for Cleaning

Easy Steps:

1. Press AUTO SELF CLEAN.
2. Press the number pads to set the clean time.
3. Press START.

1. Follow the steps in the Before a Clean Cycle section.



2. Press AUTO SELF CLEAN.

3. Press the number pads to set the clean time, if a time other than 4 hours is needed.

Clean time is normally 4 hours. You can change the clean time to any time between 3 to 5 hours, depending on the amount of soil in your oven.



4. Press START.

The door locks automatically. The display will show the clean time remaining. It will not be possible to open the oven door until the temperature drops below the lock temperature and the LOCKED DOOR light goes off.

5. When the LOCKED DOOR light is off, open the door.

NOTE:



- You can find out when the clean cycle will start by pressing DELAY START.
- The display will flash and the control will beep if you set the clean cycle and forget to close the oven door.

To Stop a Clean Cycle



1. Press CLEAR/OFF.

2. When the oven has cooled below the locking temperature and the LOCKED DOOR light goes off, open the door.

(continued next page)



OPERATING THE SELF-CLEANING OVEN

(continued)

How to Set Delay Start of Cleaning

Easy Steps:

1. Press AUTO SELF CLEAN.
2. Press the number pads to set the clean time.
3. Press DELAY START.
4. Press the number pads to set the start time.
5. Press START.

Delay Start is setting the oven to start the clean cycle automatically at a later time than the present time of day.

NOTE: Before beginning, make sure the oven clock shows the correct time of day.

1. Follow the steps in the Before a Clean Cycle section.



2. Press AUTO SELF CLEAN.

3. Press the number pads to set the clean time.



4. Press DELAY START.

5. Press the number pads to set the time of day you want the clean cycle to start.



6. Press START.

The door locks automatically. The display will show the start time. It will not be possible to open the oven door until the temperature drops below the lock temperature and the LOCKED DOOR light goes off.

7. When the LOCKED DOOR light is off, open the door.

NOTE: You can set a delay clean in both ovens at the same time. The second oven set will automatically delay the start of cleaning until the end of the first oven's clean cycle.

After Self-Cleaning

You may notice some white ash in the oven. Just wipe it up with a damp cloth after the oven cools.

If white spots remain, remove them with a soap-filled steel wool pad. Be sure to rinse thoroughly with a vinegar and water mixture. These deposits are usually a salt residue that cannot be removed by the clean cycle.

If the oven is not clean after one clean cycle, repeat the cycle.

NOTE:

- No functions can be programmed before the door automatically unlocks.
- If the shelves have become hard to slide, wipe the shelf supports with cooking oil.

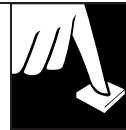

Questions and Answers

Q. If my oven clock is not set to the correct time of day, can I still self-clean my oven?

A. If the clock is not set to the correct time of day you will not be able to set a delay clean to end at a specific time.

Q. Can I use commercial oven cleaners on any part of my self-cleaning oven?

A. No cleaners or coatings should be used around any part of this oven. If you do use them and do not thoroughly rinse the oven with water, wiping it absolutely clean afterwards, the residue can scar the oven surface and damage metal parts the next time the oven is automatically cleaned.

Q. Can I clean both ovens at the same time?

A. No. There is too much heat. The control only allows one oven to clean at a time.

Q. What should I do if excessive smoking occurs during cleaning?

A. This is caused by excessive soil. Turn the oven off. Open the windows to rid the room of smoke. Wait until the oven has cooled and the words "LOCKED DOOR" are off in the display. Wipe up the excess soil and reset the clean cycle.

Q. Is the "crackling" or "popping" sound I hear during cleaning normal?

A. Yes. This is the sound of the metal heating and cooling during both the cooking and cleaning functions.

Q. Should there be an odor during the cleaning?

A. Yes, there will be an odor during the first few cleanings. Failure to wipe out excessive soil might also cause a strong odor when cleaning.

Q. What causes the hair-like lines on the enameled surface of my oven?

A. This is a normal condition, resulting from heating and cooling during cleaning. These lines do not affect how your oven performs.

Q. Why do I have ash left in my oven after cleaning?

A. Some types of soil will leave a deposit which is ash. It can be removed with a damp sponge or cloth.

Q. My oven shelves do not slide easily. What is the matter?

A. After many cleanings, oven shelves will lose their luster and become hard to slide. To make the shelves slide more easily, wipe the shelf supports with cooking oil.

Q. My oven shelves have become gray after the self-clean cycle. Is this normal?

A. Yes. After the self-clean cycle, the shelves will lose some luster and discolor to a deep gray color.



CARE AND CLEANING

Proper care and cleaning are important so your oven will give you efficient and satisfactory service. Follow these directions carefully in caring for your oven to assure safe and proper maintenance.

BE SURE ELECTRICAL POWER IS OFF AND ALL SURFACES ARE COOL BEFORE CLEANING ANY PART OF THE OVEN.

Broiler Pan and Grid

After broiling, remove the broiler pan and grid from the oven. Remove the grid from the pan. Carefully pour out grease from the pan into a proper container. Wash and rinse the broiler pan and grid in hot water with a soap-filled or plastic scouring pad.

If food has burned on, sprinkle the grid with detergent while hot and cover with wet paper towels or a dishcloth. Soaking the pan will remove burned-on foods.

The broiler pan and grid may be cleaned with a commercial oven cleaner.

Both the broiler pan and grid can also be cleaned in the dishwasher.

Do not store a soiled broiler pan and grid anywhere in the oven.

Do not clean the broiler pan and grid in the self-cleaning oven.

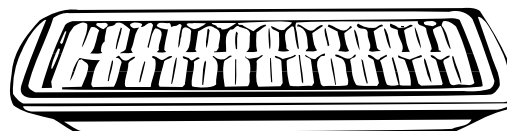

Oven Shelves and Convection Roasting Rack

Clean the oven shelves and the convection roasting rack with a mild abrasive cleanser or steel wool.

After cleaning, rinse the shelves and rack with clean water and dry with a clean cloth.

NOTE: The oven shelves and convection roasting rack may be cleaned in the self-cleaning oven.

However, they will darken in color, lose their luster and become hard to slide.

Wipe the shelf supports with cooking oil after self-cleaning to make the shelves slide more easily.



Oven shelves



Convection roasting rack



Lift-Off Oven Door

The oven door is **removable**, but it is heavy. You may need help removing and replacing the door. Do not lift the door by the handle. This can cause the glass to break or can cause damage to the door.

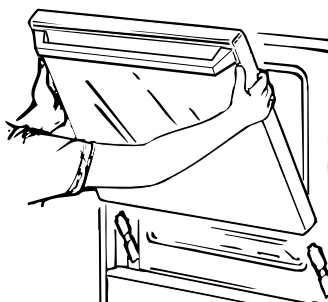

To remove the door, open it a few inches to the special stop position that will hold the door open. Grasp firmly on each side and lift the door straight up and off the hinges.

NOTE:

- Be careful not to place hands between the hinge and the oven door frame as the hinge could snap back and pinch fingers.
- While working in the oven area, cover the hinges with towels or empty paper towel rolls to prevent pinched fingers and chipping the porcelain enamel on the frame.

To replace the door, make sure the hinges are in the special stop position. Position the slots in the bottom of the door squarely over the hinges. Then lower the door slowly and evenly over both hinges at the same time. If hinges snap back against the oven frame, pull them back out.

TO CLEAN THE DOOR:

Inside of the door:

- Because the area inside the gasket is cleaned during the self-clean cycle, you do not need to clean this by hand. Any soap left on the liner causes additional stains when the oven is heated.
- The area outside the gasket can be cleaned with a soap-filled scouring pad.
- Do not rub or clean the door gasket—the fiberglass material of the gasket has an extremely low resistance to abrasion. An intact and well-fitting oven door gasket is essential for energy-efficient oven operation and good baking results. If you notice the gasket becoming worn, frayed or damaged in any way or if it has become displaced on the door, you should have it replaced.

NOTE: The gasket is designed with a gap at the bottom to allow for proper air circulation.

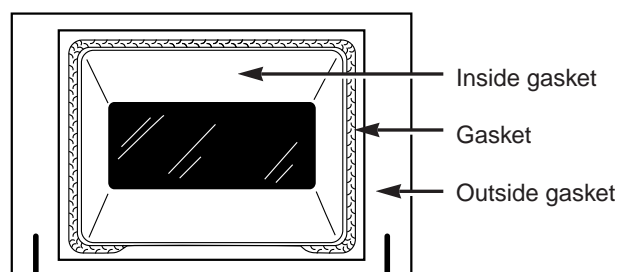

Outside of the door:

- Use soap and water to thoroughly clean the top, sides and front of the oven door. **DO NOT** let water run down through openings in the top of the door. Rinse well. You may also use a glass cleaner to clean the glass on the outside of the door.
- Spillage of marinades, fruit juices, tomato sauces and basting materials containing acids may cause discoloration and should be wiped up immediately. When surface is cool, clean and rinse.
- Do not use oven cleaners, cleansing powders or harsh abrasives on the outside of the door.

(continued next page)



CARE AND CLEANING

(continued)

Probe

The temperature probe may be cleaned with soap and water or a soap-filled scouring pad. Cool the temperature probe before cleaning. Scour stubborn spots with a soap-filled scouring pad, rinse and dry.

Do not immerse the temperature probe in water.
Do not store the temperature probe in the oven.

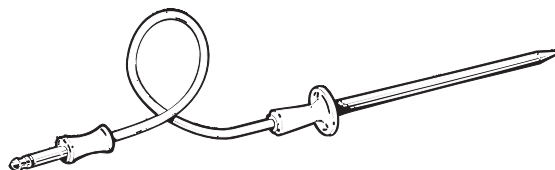

Oven Light Bulb

NOTE: The glass cover should be removed only when cold. Wearing latex gloves may offer a better grip.

The light bulb is located on the top of the oven. Before replacing the bulb, disconnect electrical power to the oven at the main fuse or circuit breaker panel. Let the bulb cool completely before removing it. For your safety, do not touch a hot bulb with a damp cloth. If you do, the bulb will break.

To remove: Turn to remove the cover, then remove the bulb.

To replace: Put in a new 40-watt appliance bulb.

NOTE:

- A 40-watt appliance bulb is smaller than a standard 40-watt household bulb.
- Install and tighten the cover.
- Reconnect electrical power to the oven.

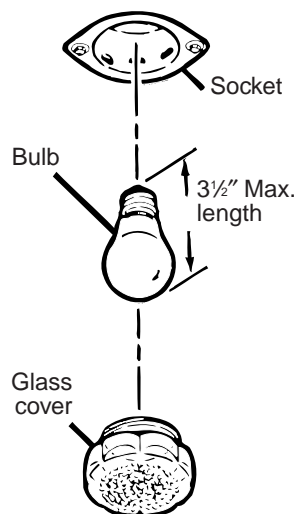

Oven Heating Elements

Do not clean the bake element or the broil element. Any soil will burn off when the elements are heated.

The bake element can be lifted gently to clean the oven floor. If spillovers, residue or ash accumulate around the bake element gently wipe around the element with warm water.

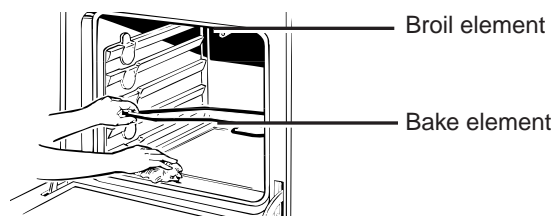

Control Panel

It's a good idea to wipe the control panel after each use. Clean with mild soap and water or vinegar and water, rinse with clean water and polish dry with a soft cloth.

Do not use abrasive cleansers, strong liquid cleaners, plastic scouring pads or oven cleansers on the control panel—they will damage the finish. A 50/50 solution of vinegar and hot water works well.

QUESTIONS? USE THIS PROBLEM SOLVER



PROBLEM	POSSIBLE CAUSE
“F-AND A NUMBER OR LETTER” FLASH IN THE DISPLAY	<ul style="list-style-type: none"> • This is a function error code. Press CLEAR/OFF. Allow the oven to cool one hour. Place the oven back into operation. • Disconnect all power to the oven for 5 minutes and then reconnect power. If the failure code repeats, call for service.
CONTROL SIGNALS AFTER ENTERING COOKING TIME OR DELAY START TIME	<ul style="list-style-type: none"> • This is reminding you to press BAKE or CONVECTION BAKE and then enter a bake temperature. • This is reminding you to enter a bake temperature after having pressed BAKE or CONVECTION BAKE.
DISPLAY GOES BLANK	<ul style="list-style-type: none"> • The circuit breaker in your house has been tripped, or a fuse has been blown.
DISPLAY FLASHES	<ul style="list-style-type: none"> • Power failure. Reset the clock.
UNABLE TO GET THE DISPLAY TO SHOW “SF”	<ul style="list-style-type: none"> • BAKE and BROIL HI/LO must be pressed at the same time and held for 2 seconds.
“PROBE” APPEARS IN THE DISPLAY	<ul style="list-style-type: none"> • The probe is not inserted properly into the oven receptacle or food. • This is reminding you to enter a probe temperature after plugging in the probe.
“LOCK DOOR” FLASHES	<ul style="list-style-type: none"> • Oven door not closed after self-clean cycle is selected.
“LOCKED DOOR” FLASHES	<ul style="list-style-type: none"> • Door is still locked and you are trying to enter an oven cooking operation.
OVEN LIGHT DOES NOT WORK	<ul style="list-style-type: none"> • The light bulb is loose or defective. Tighten or replace. • The pad operating the oven light is broken. Call for service.
OVEN WILL NOT SET A SELF-CLEAN CYCLE	<ul style="list-style-type: none"> • Oven temperature is too high to set self-clean operation. Allow the oven to cool to room temperature and reset the controls. • The probe is plugged into the outlet in the oven. Remove the probe from the oven.
OVEN NOT CLEAN AFTER CLEAN CYCLE	<ul style="list-style-type: none"> • Oven controls not set properly. See the Operating the Self-Cleaning Oven section. • Heavily soiled ovens require 4 to 5 hours of clean time. • Heavy spillovers should be cleaned up before starting clean cycle.
DOOR WILL NOT OPEN AFTER SELF-CLEAN CYCLE	<ul style="list-style-type: none"> • When the temperature has fallen below the locking temperature door can be opened.

(continued next page)



PROBLEM SOLVER

(continued)

PROBLEM	POSSIBLE CAUSE
OVEN WILL NOT WORK	<ul style="list-style-type: none">• The circuit breaker in your house has been tripped, or a fuse has been blown.• The oven controls are not properly set.
FOOD DOES NOT BROIL PROPERLY	<ul style="list-style-type: none">• Oven controls not set properly. See the Broiling section.• Door not left open to the broil stop position as recommended.• Improper shelf position being used. See the Broiling Guide.• Food is being cooked on a hot pan or on cookware not suitable for broiling.• Low voltage. See the Broiling section.• Aluminum foil used on the broiler pan and grid has not been fitted properly and slit as recommended.
FOOD DOES NOT ROAST OR BAKE PROPERLY	<ul style="list-style-type: none">• Oven controls not set properly. See the Baking or Roasting section.• Shelf position is incorrect. See the Baking or Roasting section.• Incorrect cookware or cookware of improper size is being used.• Oven thermostat needs adjustment. See the Adjust the Oven Thermostat—<i>Do It Yourself</i> section.
STEAM FROM THE VENT	<ul style="list-style-type: none">• When using Convection Bake or Convection Roast, it is normal to see steam coming out of the oven vent. As the number of shelves or amount of food being cooked increases, the amount of visible steam will increase.
OVEN TEMPERATURE TOO HOT OR TOO COLD	<ul style="list-style-type: none">• Oven thermostat needs adjustment. See the Adjust the Oven Thermostat—<i>Do It Yourself</i> section.
“BURNING” OR “OILY” ODOR EMITTING FROM OVEN WHEN TURNED ON	<ul style="list-style-type: none">• This is normal in a new oven and will disappear in time. To speed the process, set a self-clean cycle for a minimum of 3 hours. See the Operating the Self-Cleaning Oven section.
STRONG ODOR	<ul style="list-style-type: none">• An odor from the insulation around the inside of the oven is normal for the first few times the oven is used. This is temporary.
FAN NOISE	<ul style="list-style-type: none">• A cooling fan or a convection fan (depending on the function you are using) may automatically turn on and off to cool internal parts. This is normal and the fan may continue to run even after the oven is off.

If you need more help...call, toll free:

GE Answer Center®

800.626.2000

consumer information service

We'll Be There

With the purchase of your new GE appliance, receive the assurance that if you ever need information or assistance from GE, we'll be there. All you have to do is call—toll-free!

GE Answer Center[®] **800.626.2000**

Whatever your question about any GE major appliance, GE Answer Center[®] information service is available to help. Your call—and your question—will be answered promptly and courteously. And you can call any time. GE Answer Center[®] service is open 24 hours a day, 7 days a week.

In-Home Repair Service **800-GE-CARES (800-432-2737)**

A GE consumer service professional will provide expert repair service, scheduled at a time that's convenient for you. Many GE Consumer Service company-operated locations offer you service today or tomorrow, or at your convenience (7:00 a.m. to 7:00 p.m. weekdays, 9:00 a.m. to 2:00 p.m. Saturdays). Our factory-trained technicians know your appliance inside and out—so most repairs can be handled in just one visit.

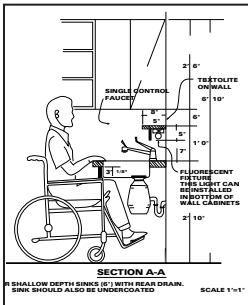

For Customers With Special Needs... **800.626.2000**

Upon request, GE will provide Braille controls for a variety of GE appliances, and a brochure to assist in planning a barrier-free kitchen for persons with limited mobility. To obtain these items, free of charge, call 800.626.2000.

Consumers with impaired hearing or speech who have access to a TDD or a conventional teletypewriter may call 800-TDD-GEAC (800-833-4322) to request information or service.

Service Contracts **800-626-2224**

You can have the secure feeling that GE Consumer Service will still be there after your warranty expires. Purchase a GE contract while your warranty is still in effect and you'll receive a substantial discount. With a multiple-year contract, you're assured of future service at today's prices.

Parts and Accessories **800-626-2002**

Individuals qualified to service their own appliances can have parts or accessories sent directly to their home. The GE parts system provides access to over 47,000 parts...and all GE Genuine Renewal Parts are fully warranted. VISA, MasterCard and Discover cards are accepted.

User maintenance instructions contained in this guide cover procedures intended to be performed by any user. Other servicing generally should be referred to qualified service personnel. Caution must be exercised, since improper servicing may cause unsafe operation.

YOUR GE BUILT-IN OVEN WARRANTY

Staple sales slip or cancelled check here. Proof of original purchase date is needed to obtain service under warranty.

WHAT IS COVERED

FULL ONE-YEAR WARRANTY

For one year from date of original purchase, we will provide, free of charge, parts and service labor in your home to repair or replace **any part of the oven** that fails because of a manufacturing defect.

This warranty is extended to the original purchaser and any succeeding owner for products purchased for ordinary home use in the 48 mainland states, Hawaii and Washington, D.C. In Alaska the warranty is the same except that it is LIMITED because you must pay to ship the product to the service shop or for the service technician's travel costs to your home. All warranty service will be provided by our Factory Service Centers or by our authorized Customer Care® servicers during normal working hours. Should your appliance need service, during warranty period or beyond, call 800-GE-CARES (800-432-2737).

WHAT IS NOT COVERED

- Service trips to your home to teach you how to use the product.
Read your Use and Care material. If you then have any questions about operating the product please contact your dealer or our Consumer Affairs office at the address below, or call, toll free:
GE Answer Center®
800.626.2000
consumer information service
- Improper installation.
If you have an installation problem, contact your dealer or installer.

You are responsible for providing adequate electrical, gas, exhausting and other connecting facilities as described in the Installation Instructions provided with the product.

- Replacement of house fuses or resetting of circuit breakers.
- Failure of the product if it is used for other than its intended purpose or used commercially.
- Damage to product caused by accident, fire, floods or acts of God.

WARRANTOR IS NOT RESPONSIBLE FOR CONSEQUENTIAL DAMAGES.

Some states do not allow the exclusion or limitation of incidental or consequential damages, so the above limitation or exclusion may not apply to you. This warranty gives you specific legal rights, and you may also have other rights which vary from state to state. To know what your legal rights are in your state, consult your local or state consumer affairs office or your state's Attorney General.

Warrantor: General Electric Company

**If further help is needed concerning this warranty, write:
Manager—Consumer Affairs, GE Appliances, Louisville, KY 40225**



Recycled Paper

Part No. 164D2966P205-1

Pub No. 49-8689

11-96 CG

JTP56

Printed in LaFayette, GA

Free Manuals Download Website

<http://myh66.com>

<http://usermanuals.us>

<http://www.somanuals.com>

<http://www.4manuals.cc>

<http://www.manual-lib.com>

<http://www.404manual.com>

<http://www.luxmanual.com>

<http://aubethermostatmanual.com>

Golf course search by state

<http://golfingnear.com>

Email search by domain

<http://emailbydomain.com>

Auto manuals search

<http://auto.somanuals.com>

TV manuals search

<http://tv.somanuals.com>