

Owner's Manual

27" and 30" Convection Wall Oven

ZEK938 – 27" Single Wall Oven
ZEK958 – 27" Double Wall Oven
ZET938 – 30" Single Wall Oven
ZET958 – 30" Double Wall Oven



Monogram®

Introduction

Your new Monogram wall oven makes an eloquent statement of style, convenience and kitchen planning flexibility. Whether you chose it for its purity of design, assiduous attention to detail—or for both of these reasons—you'll find that your Monogram wall oven's superior blend of form and function will delight you for years to come.

Your Monogram wall oven was designed to provide the flexibility to blend in with your kitchen cabinetry. Its sleek design can be beautifully integrated into the kitchen.

The information on the following pages will help you operate and maintain your wall oven properly.

Contents

Care and Cleaning	Oven
Broiler Pan and Grid 37	Aluminum Foil 4, 17, 35
Control Panel 39	Baking or Roasting 16, 17
Heating Elements 39	Broiling/Broiling Guide 18–20
Lift-Off Oven Door 38	Controls 7
Light Bulb 40	Clock and Timer 8, 9
Oven Door 39	Convection 26–31
Probe 40	Features 6
Racks 37	Probe 23–25
Removable Oven Floor 39	Proofing 33
Stainless Steel and Metal Parts 37	Sabbath Feature 13–15
Consumer Services	Self-Cleaning Oven 35, 36
Before You Call For Service 41, 42	Special Features 10–12
Important Phone Numbers 47	Thermostat 34
Model and Serial Numbers 3	Timed Baking & Roasting 21, 22
Product Registration 3, 45, 46	Warming 32
Safety Instructions 4, 5	
Warranty Back Cover	

How to remove protective shipping film and packaging tape

Carefully grasp a corner of the protective shipping film with your fingers and slowly peel it from the appliance surface. Do not use any sharp items to remove the film. Remove all of the film before using the appliance for the first time.

To assure no damage is done to the finish of the product, the safest way to remove the adhesive from packaging tape on new appliances is an application of a household liquid dishwashing detergent. Apply with a soft cloth and allow to soak.

NOTE: *The adhesive must be removed from all parts. It cannot be removed if it is baked on.*

*Before
using your
wall oven*

Read this manual carefully. It is intended to help you operate and maintain your new wall oven properly.

Keep it handy for answers to your questions.

If you don't understand something or need more help, there is a list of toll-free consumer service numbers included in the back section of this manual.

OR

Visit our Website at: ge.com

*Write
down the
model &
serial
numbers*

You'll find them on a label on the side trim or on the front of the (lower) oven behind the oven door.

Fill out and return the Consumer Product Registration Card that is packed with this product. If you cannot find it, please send in the duplicate card printed in the back of this manual.

Before sending in this card, please write these numbers here:

Model Number

Serial Number

Use these numbers in any correspondence or service calls concerning your wall oven.

*If you
received a
damaged
wall oven*

Immediately contact the dealer (or builder) that sold you the wall oven.

*Save time
& money*

Before you request service, check the Problem Solver in the back of this manual.

It lists causes of minor operating problems that you can correct yourself.

*If you
need
service*

To obtain service, see the Consumer Services page in the back of this manual.

We're proud of our service and want you to be pleased. If for some reason you are not happy with the service you receive, here are the steps to follow for further help.

FIRST, contact the people who serviced your appliance. Explain why you are not pleased. In most cases, this will solve the problem.

NEXT, if you are still not pleased, write all the details—including your phone number—to:

Manager, Customer Relations
GE Appliances
Appliance Park
Louisville, KY 40225

IMPORTANT SAFETY INSTRUCTIONS

WARNING!

For your safety, the information in this manual must be followed to minimize the risk of fire or explosion, electric shock, or to prevent property damage, personal injury or loss of life.

IMPORTANT SAFETY NOTICE

- **The California Safe Drinking Water and Toxic Enforcement Act** requires the Governor of California to publish a list of substances known to the state to cause cancer, birth defects or other reproductive harm, and requires businesses to warn customers of potential exposure to such substances.
 - **The fiberglass insulation in self-cleaning ovens gives off a very small amount of carbon monoxide during the cleaning cycle.** Exposure can be minimized by venting with an open window or using a ventilation fan or hood.
 - **IMPORTANT:** The health of some birds is extremely sensitive to the fumes given off during the self-cleaning cycle of any oven. Move birds to another well-ventilated room.
-

SAFETY PRECAUTIONS

When using your appliance, follow basic safety precautions, including the following:

- Use this appliance only for its intended use as described in this manual.
- Be sure your appliance is properly installed and grounded by a qualified technician in accordance with the provided installation instructions.
- Be sure the oven is securely installed in a cabinet that is firmly attached to the house structure. Never allow anyone to climb, sit, stand or hang on the oven door.
- Have the installer show you the location of the circuit breaker or fuse. Mark it for easy reference.
- Do not attempt to repair or replace any part of your wall oven unless it is specifically recommended in this manual. All other servicing should be referred to a qualified technician.
- Teach children not to play with the controls or any other part of the oven.
- Never leave the oven door open when you are not watching the oven.
- Always keep dish towels, dish cloths, pot holders and other linens a safe distance from your oven.
- For your safety, never use your appliance for warming or heating the room.
- Always keep wooden and plastic utensils and canned food a safe distance away from your oven.
- Keep the oven free from grease buildup.
- Always keep combustible wall coverings, curtains or drapes a safe distance from your oven.
- **DO NOT STORE OR USE COMBUSTIBLE MATERIALS, GASOLINE OR OTHER FLAMMABLE VAPORS AND LIQUIDS IN THE VICINITY OF THIS OR ANY OTHER APPLIANCE.**
- Do not let cooking grease or other flammable materials accumulate in or near the wall oven.
- Do not use water on grease fires. Smother fire or flame or use a multi-purpose dry chemical or foam-type fire extinguisher.
Flame in the oven can be smothered completely by closing the oven door and turning the oven off or by using a multi-purpose dry chemical or foam-type fire extinguisher.
- Do not use aluminum foil to line oven bottoms, except as suggested in this manual. Improper installation of aluminum foil may result in a risk of electric shock or fire.
- Cook meat and poultry thoroughly—meat to at least an INTERNAL temperature of 160°F and poultry to at least an INTERNAL temperature of 180°F. Cooking to these temperatures usually protects against foodborne illness.
- Before performing any service, **DISCONNECT THE OVEN POWER SUPPLY AT THE HOUSEHOLD DISTRIBUTION PANEL BY REMOVING THE FUSE OR SWITCHING OFF THE CIRCUIT BREAKER.**
- Do not store flammable materials in the oven.

SAFETY PRECAUTIONS

- **Do not leave children alone**—children should not be left alone or unattended in an area where an appliance is in use. They should never be allowed to sit or stand on any part of the appliance.
- **Do not touch the heating elements or the interior surface of the oven.** These surfaces may be hot enough to burn even though they are dark in color. During and after use, do not touch, or let clothing or other flammable materials contact, any interior area of the oven; allow sufficient time for cooling first.

Potentially hot surfaces include the oven vent openings and surfaces near the openings, crevices around the oven door, the edges of the door window and metal trim parts above the door.

Remember: The inside surface of the oven may be hot when the door is opened.
- **CAUTION: ITEMS OF INTEREST TO CHILDREN SHOULD NOT BE STORED IN CABINETS ABOVE A WALL OVEN—CHILDREN CLIMBING ON THE OVEN TO REACH ITEMS COULD BE SERIOUSLY INJURED.**
- **Never wear loose-fitting or hanging garments while using the appliance.** Be careful when reaching for items stored over the oven. Flammable material could be ignited if brought in contact with oven heating elements and may cause severe burns.
- **Do not heat unopened food containers.** Pressure could build up and the container could burst, causing an injury.
- **Keep the oven vent unobstructed.**
- **Place the oven rack in the desired position while the oven is cool.** If racks must be handled when hot, do not let pot holder contact the heating elements.
- **Never leave jars or cans of fat drippings in or near your oven.**
- **Pulling out the rack to the rack stop is a convenience in lifting heavy foods.** It is also a precaution against burns from touching hot surfaces of the door or oven walls.
- **When using cooking or roasting bags in the oven,** follow the manufacturer's directions.
- **Do not use your oven to dry newspapers.** If overheated, they can catch on fire.
- **Do not use oven for a storage area.** Items stored in an oven can ignite.
- **Do not leave paper products, cooking utensils or food in the oven when not in use.**
- **Do not allow anyone to climb, stand or hang on the door.** They could damage the oven or cause severe personal injury.
- **Use only dry pot holders**—moist or damp pot holders on hot surfaces may result in burns from steam. Do not let pot holders touch oven heating elements. Do not use a towel or other bulky cloth.
- **After broiling, always take the broiler pan out of the oven and clean it.** Leftover grease in the broiler pan can catch fire the next time you use the pan.
- **Stand away from the oven when opening the oven door.** Hot air or steam which escapes can cause burns to hands, face and/or eyes.
- **Large scratches or impacts to glass doors can lead to broken or shattered glass.**

SELF-CLEANING OVEN

- **Do not clean the door gasket.** The door gasket is essential for a good seal. Care should be taken not to rub, damage or move the gasket.
- **Do not use oven cleaners.** No commercial oven cleaner or oven liner protective coating of any kind should be used in or around any part of the oven. Residue from oven cleaners will damage the inside of the oven when the self-clean cycle is used.
- **Clean only parts listed in this Owner's Manual.**
- **Before self-cleaning the oven,** remove the broiler pan, grid and other cookware.
- **Be sure to wipe up excess spillage before starting the self-cleaning operation.**
- **If the self-cleaning mode malfunctions,** turn the oven off and disconnect the power supply. Have it serviced by a qualified technician.

SAVE THESE INSTRUCTIONS

Features of Your Wall Oven

Wall Oven

Design information

(Not all features are on all models. Appearance may vary.)

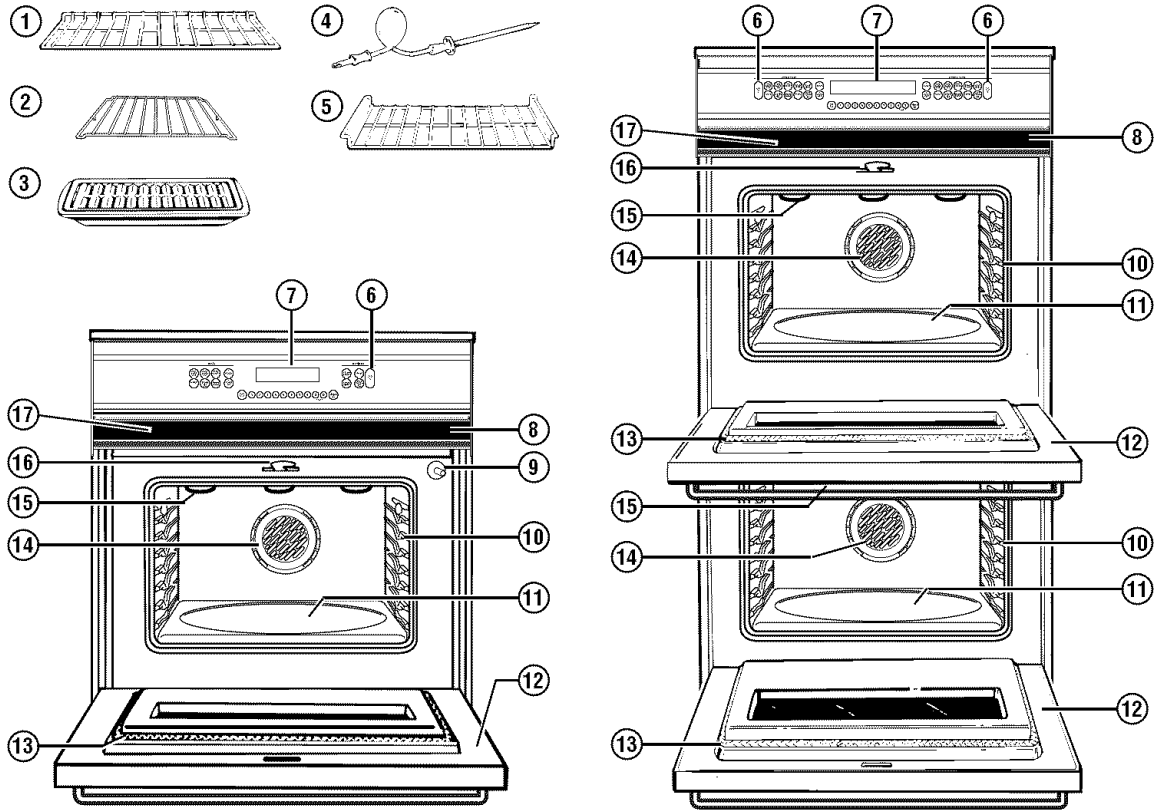

Feature Index	Page
1 Oven Racks with Stop-Locks <i>Two additional racks may be ordered. Pub No. 3-A014</i>	5, 16, 19, 20, 26, 27, 35, 37
2 Roasting Rack	27, 35, 37
3 Broiler Pan and Grid	5, 17, 18, 24, 27, 35, 37
4 Probe <i>Depending on your oven, the probe outlet will be located in the oven wall or ceiling.</i>	23, 24, 25, 29, 35, 40
5 Offset Rack <i>(on some models)</i>	26, 27, 29, 37
6 Oven Light Pad(s) <i>Lets you turn the oven light on and off. Depending on your oven, the oven light will be located in the oven wall or ceiling.</i>	13, 40
7 Oven Control, Clock and Timer	7-12
8 Oven Vent Grille	5
9 Automatic Oven Light Switch <i>(on some models)</i>	—
10 Oven Rack Supports <i>Rack positions are suggested in the Convection Cooking, Baking or Roasting and Broiling sections.</i>	16-20, 26, 27, 37
11 Removable Oven Floor	39
12 Lift-Off Oven Door with Broil Stop Position	18, 38
13 Oven Door Gasket	5, 38
14 Convection Fan and Heating Element <i>Operates during convection cooking.</i>	26-31
15 Oven Broil Element	18, 39
16 Automatic Oven Door Latch	35, 36
17 Oven Vent	5

Oven Control, Clock & Timer

Wall Oven

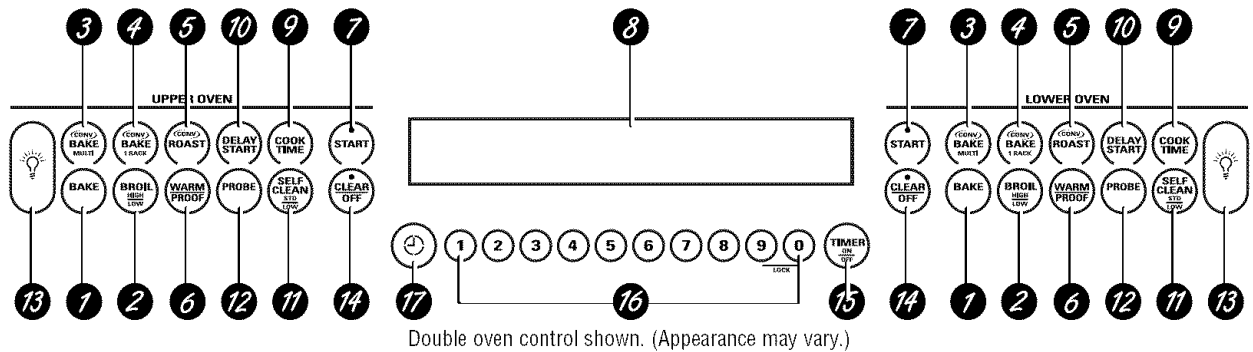

Features of your oven control, clock and timer

- 1 BAKE.** Press to select the bake function.
- 2 BROIL HIGH/LOW.** Press to select the broil function.
- 3 CONV BAKE/MULTI.** Press to select baking with convection on multiple racks.
- 4 CONV BAKE/1 RACK.** Press to select baking with convection on one rack.
- 5 CONV ROAST.** Press to select roasting with convection.
- 6 WARM/PROOF.** Press once for warming or twice for proofing. See the How to Set the Oven for Warming section and the How to Set the Oven for Proofing section.
- 7 START.** Must be pressed to start any cooking or cleaning function.
- 8 DISPLAY.** Shows the operations you have selected, the time of day and the cooking or cleaning status.
- 9 COOK TIME.** Use for Timed Bake, Timed Convection Bake and Timed Convection Roast operations.
- 10 DELAY START.** Use along with the **COOK TIME** or **SELF CLEAN STD/LOW** pads to set the oven to start and stop automatically at a time you select.
- 11 SELF CLEAN STD/LOW.** Press to select the self-cleaning function. See the Using the Self-Cleaning Oven section.
- 12 PROBE.** Press when using the probe to cook food.
- 13 OVEN LIGHT ON/OFF.** Press to turn the oven lights on or off.
- 14 CLEAR/OFF.** Press to cancel any oven operation except the clock and timer.
- 15 TIMER ON/OFF.** Press to select the timer function. The timer does not control oven operations. The timer can time up to 9 hours and 59 minutes.
- 16 NUMBER PADS.** Use to set any function requiring numbers—for example, the time of day on the clock, the timer, the oven temperature, the internal food temperature, the starting and length of cooking time for Timed Bake and the starting and length of cleaning time for Self-Clean.
- 17 CLOCK.** Press to enter the time of day.

If "F – and a number or letter" flash in the display and the oven control signals, this indicates function error code. Press the **CLEAR/OFF** pad. Allow oven to cool for one hour. Put the oven back into operation. If function error code repeats, disconnect power to the oven and call for service.

Tones

The control has a series of tones that will sound at different times. These tones may sound while you set the control for an oven function or at the end of the oven function. They will also alert you when an incorrect time or temperature has been entered or if there is a problem with the oven.

When you press a touch pad, you will hear a beep. This beep will let you know you have placed enough pressure on the pad to activate it.

When you set an oven temperature, the oven automatically starts to heat. When the temperature inside the oven reaches your set temperature, a tone will sound to let you know to place the food in the oven.

An attention tone will sound if you set an invalid function or try to set an additional function. The tone can be quickly identified by watching the display messages.

Clock

The clock must be set for the automatic oven timing functions to work properly.

The time of day clock **cannot** be changed during Delay Start. (It can be changed during a regular bake or broil operation.)

To set the clock

- 1 Press the **CLOCK** pad.
- 2 Press the number pads the same way you read them. For example, to set 12:34, press the number pads 1, 2, 3 and 4 in that order.

If number pads are not pressed within one minute after you press the **CLOCK** pad, the display reverts to the original setting. If this happens, press the **CLOCK** pad and reenter the time of day.

- 3 Press the **START** pad. This enters the time and starts the clock.

To check the time of day when the display is showing other information, simply press the **CLOCK** pad. The time of day shows until another pad is pressed.

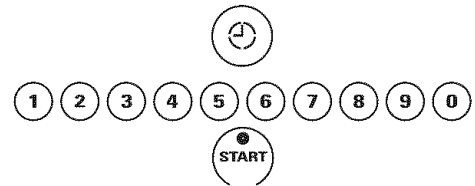

Power failure

If a flashing time of day is in the display, you have experienced a power failure. Reset the clock.

To reset the clock, press the **CLOCK** pad. Enter the correct time of day by pressing the appropriate number pads. Press the **START** pad.

Timer

NOTE: *The timer is independent of all the other functions and it does not control the oven. The **CLEAR/OFF** pad does not affect the timer.*

You may program the timer to time cooking or other household activities for up to 9 hours and 59 minutes.

The timer counts down in minutes, 1 minute at a time, until the last 60 seconds are reached. Then the control will beep one time. The seconds will not be displayed until the last minute is reached.

When the timer reaches “:00,” the control will beep 3 times followed by one beep every 6 seconds until the **TIMER ON/OFF** pad is pressed.

The 6-second tone can be canceled by following the steps in the Special Features of Your Control under Tones at the End of a Timed Cycle.

Using the timer

- 1 Press the **TIMER ON/OFF** pad.
- 2 Press the number pads to set the time. For example, to enter 2 hours and 45 minutes, touch 2, 4 and 5 in that order.

If you make a mistake, press the **TIMER ON/OFF** pad and begin again.

- 3 Press the **START** pad.

After pressing the **START** pad, "SET" disappears; this tells you the time is counting down, although the display does not change until one minute has passed. Seconds will not be shown in the display until the last minute is counting down.

- 4 When time is up, the oven control signals until you press the **TIMER ON/OFF** pad. Display then shows the time of day.

NOTE: The minute timer is independent of all the other functions and it does not control the oven. The **CLEAR/OFF** pad does not affect the timer.

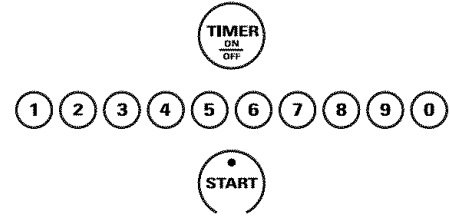

To reset the timer:

If the display is still showing the time remaining, you may change it by pressing the **TIMER ON/OFF** pad, then press the number pads until the time you want appears in the display.

If the remaining time is not in the display (clock, delay start or cooking time are in the display), recall the remaining time by pressing the **TIMER ON/OFF** pad and then pressing the number pads to enter the new time you want.

To cancel the timer:

Press the **TIMER ON/OFF** pad twice.

Control lockout

Your control will allow you to lock out the touch pads so they cannot be activated when pressed.

NOTE: On double oven models, this activates this feature for both ovens.

To lock/unlock the controls:

- 1 Press the **9** and **0** pads at the same time for 3 seconds, until the display shows "LOC ON."
- 2 To unlock the control, press the **9** and **0** pads (on double oven models, use the **upper** oven controls) at the same time for 3 seconds, until the display shows "LOC OFF."

When this feature is on and the touch pads are pressed, the control will beep and the display will show "LOC ON."

NOTES:

- The control lockout mode affects all touch pads. No touch pads will work when this feature is activated.
- The adjustment will be retained in memory after a power failure.

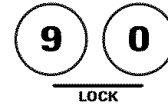

Special Features

Wall Oven

Special features of your oven control

Your new touch pad control has additional features that you may choose to use.

They remain in the control's memory until the steps are repeated. When the display shows your choice, press the **START** pad. The special features will remain in memory after a power

failure, except for the Sabbath feature, which will have to be reset.

The special feature modes can only be activated while the display is showing the time of day clock.

The following are the features and how you may activate them.

Tones at the end of a timed cycle

At the end of a timed cycle, 3 short beeps will sound followed by one beep every 6 seconds until the **CLEAR/OFF** pad is pressed. This continuous 6-second beep may be canceled. To cancel the 6-second beep:

- 1 Press the **BAKE** and **BROIL HIGH/LOW** pads (on double oven models, use the **upper** oven controls) at the same time for 3 seconds until the display shows "SF."
- 2 Press the **TIMER ON/OFF** pad. The display shows "CON BEEP" (continuous beep). Press the **TIMER ON/OFF** pad again. The display shows "BEEP." (This cancels the one beep every 6 seconds.)
- 3 Press the **START** pad.

NOTE: On double oven models, this cancels the end-of-cycle tone for both ovens.

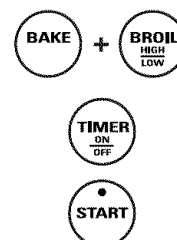

Tone volume

This feature allows you to adjust the tone volumes to a more acceptable volume. There are three possible volume levels.

- 1 Press the **BAKE** and **BROIL HIGH/LOW** pads (on double oven models, use the **upper** oven controls) at the same time for 3 seconds, until the display shows "SF."
- 2 Press the **oven light on/off** pad. The display will show "2 BEEP." This is the middle volume level.

Press the **oven light on/off** pad again. The display will show "3 BEEP." This is the loudest volume level.

Press the **oven light on/off** pad again. The display will show "1 BEEP." This is the quietest volume level.

For each time the level is changed, a tone will sound to provide an indication of the volume level.

- 3 Press the **START** pad to activate the level shown.

NOTE: On double oven models, this activates this special feature for both ovens.

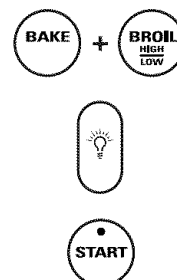

12-hour, 24-hour or clock blackout

Your control is set to use a 12-hour clock. If you would prefer to have a 24-hour military time clock or black out the clock display, follow the steps below.

- 1 Press the **BAKE** and **BROIL HIGH/LOW** pads (on double oven models, use the **upper** oven controls) at the same time for 3 seconds until the display shows "SF."
- 2 Press the **CLOCK** pad once. The display will show "12 hr." If this is the choice you want, press the **START** pad.

Press the **CLOCK** pad again to change to the 24-hour military time clock. The display will show "24 hr." If this is the choice you want, press the **START** pad.

Press the **CLOCK** pad again to black out the clock display. The display will show "OFF." If this is the choice you want, press the **START** pad.

NOTE: If the clock is in the black-out mode, you will not be able to use the Delay Start function.

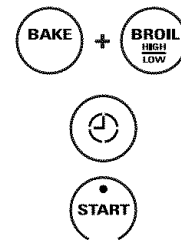

12-hour shut off

With this feature, should you forget and leave the oven on, the control will automatically turn off the oven after 12 hours during baking functions or after 3 hours during a broil function. If you wish to turn off this feature, follow the steps below.

- 1 Press the **BAKE** and **BROIL HIGH/LOW** pads (on double oven models, use the **upper** oven controls) at the same time for 3 seconds until the display shows "SF."
- 2 Press the **DELAY START** pad until "no shdn" (no shut-off) appears in the display.
- 3 Press the **START** pad to activate the no shut-off and leave the control set in this special features mode.

NOTE: On double oven models, this activates this special feature in both ovens.

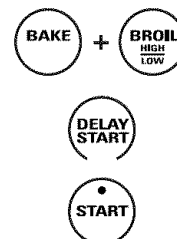

Fahrenheit or Celsius temperature selection

Your oven control is set to use the Fahrenheit temperature selections, but you may change this to use the Celsius selections.

- 1 Press the **BAKE** and **BROIL HIGH/LOW** pads (on double oven models, use the **upper** oven controls) at the same time for 3 seconds until the display shows “SF.”
- 2 Press the **BROIL HIGH/LOW** and **COOK TIME** pads at the same time. The display will show “F” (Fahrenheit).

Press the **BROIL HIGH/LOW** and **COOK TIME** pads again at the same time. This will show “C” (Celsius).

- 3 Press the **START** pad. The new setting will be displayed for both ovens.

NOTE: On double oven models, the new setting will be displayed for both ovens.

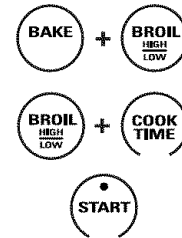

Auto Recipe™ conversion

When using convection bake, the Auto Recipe™ Conversion feature will automatically convert entered regular baking temperatures to convection baking temperatures.

Once the feature is activated, the display will show the actual converted (reduced) temperature. For example, if you enter a regular recipe temperature of 350°F and press the **START** pad, the display will show “CON” and the converted temperature of “325°F.”

NOTE: This feature does not convert convection bake cooking times, only regular baking temperatures.

To Activate the Feature:

- 1 Press the **BAKE** and **BROIL HIGH/LOW** pads (on double oven models, use the **upper** oven controls) at the same time for 3 seconds, until the display shows “SF.”
- 2 Press the **CONV BAKE/1 RACK** pad. The display will show “CON OFF.” Press the **CONV BAKE/1 RACK** pad again. The display will show “CON ON.”
- 3 Press the **START** pad.

To deactivate the feature, repeat steps 1–3 above but press the **START** pad when “CON OFF” is in the display.

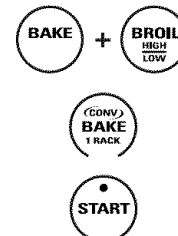

Designed for use on the Jewish Sabbath and Holidays.

The Sabbath feature can be used for baking/roasting only. It cannot be used for convection, broiling, self-cleaning or Delay Start cooking.

NOTE: *The oven light comes on automatically (on some models) when the door is opened and goes off when the door is closed. The bulb may be removed. See the Oven Light Replacement section. On models with a light switch on the control panel, the oven light may be turned on and left on.*

Sabbath Feature: How to set for regular baking or roasting

Make sure the clock shows the correct time of day and the oven is OFF.

- 1 Press and hold **both** the **BAKE** and **BROIL HIGH/LOW** pads, **at the same time**, until the display shows "SF."

*NOTE: If bake or broil appears in the display, the **BAKE** and **BROIL HIGH/LOW** pads were not touched at the same time. Touch the **CLEAR/OFF** pad and begin again.*

- 2 Tap the **DELAY START** pad until "SAB bAtH" appears in the display.
- 3 Touch the **START** pad and \supset will appear in the display.
- 4 Touch the **BAKE** pad. No signal will be given.
- 5 Using the number pads, enter the desired temperature between 170° and 550°. No signal or temperature will be given.
- 6 Touch the **START** pad.
- 7 After a random delay period of approximately 30 seconds to 1 minute, \supset \subset will appear in the display indicating that the oven is baking/roasting. If \supset \subset doesn't appear in the display, start again at Step 4.

To adjust the oven temperature, touch the **BAKE** pad, enter the new temperature using the number pads, and touch the **START** pad.

NOTE: *The **CLEAR/OFF** and **COOK TIME** pads are active during the Sabbath feature.*

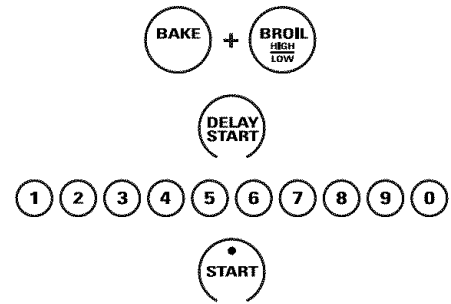

When the display shows \supset the oven is set in Sabbath. When the display shows \supset \subset the oven is baking/roasting.

Sabbath Feature:

How to set for timed baking or roasting – immediate start and automatic stop

Make sure the clock shows the correct time of day and the oven is OFF.

- 1 Press and hold **both** the **BAKE** and **BROIL HIGH/LOW** pads, **at the same time**, until the display shows “SF.”

*NOTE: If bake or broil appears in the display, the **BAKE** and **BROIL HIGH/LOW** pads were not touched at the same time. Touch the **CLEAR/OFF** pad and begin again.*
- 2 Tap the **DELAY START** pad until “SAb bAtH” appears in the display.
- 3 Touch the **START** pad and \supset will appear in the display.
- 4 Touch the **COOK TIME** pad.
- 5 Touch the number pads to set the desired length of cooking time between 1 minute and 9 hours and 99 minutes. The cooking time that you entered will be displayed.
- 6 Touch the **START** pad.
- 7 Touch the **BAKE** pad. No signal will be given.
- 8 Using the number pads, enter the desired temperature. No signal or temperature will be given.
- 9 Touch the **START** pad.
- 10 After a random delay period of approximately 30 seconds to 1 minute, \supset will appear in the display indicating that the oven is baking/roasting. If \supset doesn't appear in the display, start again at Step 7.

To adjust the oven temperature, touch the **BAKE** pad, enter the new temperature using the number pads, and touch the **START** pad.

When cooking is finished, the display will change from \supset to \supset and “0:00” will appear, indicating that the oven has turned **OFF** but is still set in Sabbath. Remove the cooked food.

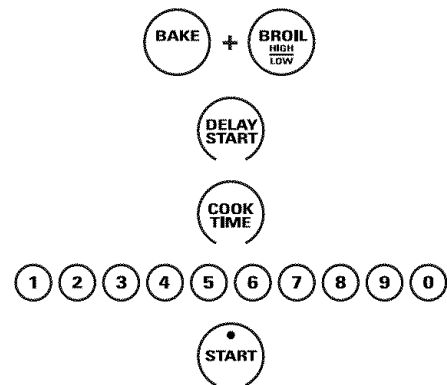

When the display shows \supset the oven is set in Sabbath. When the display shows \supset \subset the oven is baking/roasting.

*How to exit
the Sabbath
feature*

- 1 Touch the **CLEAR/OFF** pad.
- 2 If the oven is cooking, wait for a random delay period of approximately 30 seconds to 1 minute, until only \supset is in the display.
- 3 Press and hold **both** the **BAKE** and **BROIL HIGH/LOW** pads, **at the same time**, until the display shows "SF."
- 4 Tap the **DELAY START** pad until "12 shdn" or "no shdn" appears in the display. "12 shdn" indicates that the oven will automatically turn off after 12 hours. "no shdn" indicates that the oven will not automatically turn off.
- 5 Touch the **START** pad.

***NOTE:** If a power outage occurred while the oven was in Sabbath, the oven will automatically turn off and stay off even when the power returns. The oven control must be reset.*

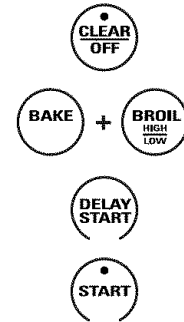

Baking or Roasting

Wall Oven

Before you begin...

To avoid possible burns, place the racks in the desired position before you turn the oven on.

The racks have stop-locks, so that when placed correctly on the supports, they will stop before coming completely out, and will not tilt.

When placing and removing cookware, pull the rack out to the bump on the rack support.

To remove a rack, pull it toward you, tilt the front end up and pull it out.

To replace, place the end of the rack (stop-locks) on the support, tilt up the front and push the rack in.

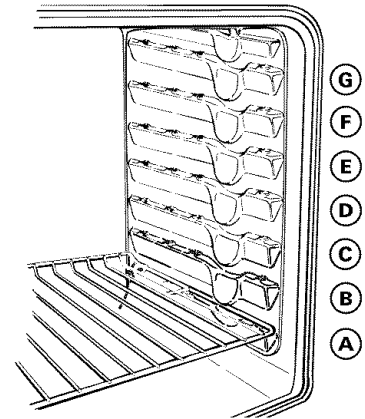

30" ovens (shown) have 7 rack positions.
27" ovens have 4 rack positions.

How to set the oven for baking or roasting

- 1 Press the **BAKE** pad.
- 2 Press the number pads to set the desired temperature.
- 3 Press the **START** pad.
- 4 Check food for doneness at minimum time on recipe. Cook longer if necessary.
- 5 Press the **CLEAR/OFF** pad when cooking is complete.

NOTE: A cooling fan may automatically turn on and off to cool internal parts. This is normal, and the fan may continue to run even after the oven is turned off.

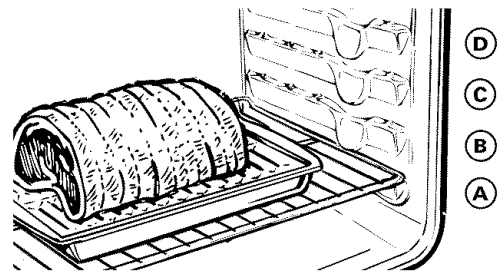

Type of Food	Rack Position	
	27" Oven	30" Oven
Frozen pies (on cookie sheet)	B or C	C or D
Angel food cake	A	B
Bundt or pound cakes	B	B
Biscuits, muffins, brownies, cookies, cupcakes, layer cakes, pies	B or C	C or D
Casseroles	B or C	C or D

Preheating and pan placement

Preheat the oven if the recipe calls for it. To preheat, set the oven at the correct temperature. Preheating is necessary for good results when baking cakes, cookies, pastry and breads.

For ovens without a preheat indicator light or tone, preheat 10 minutes.

Baking results will be better if baking pans are centered in the oven as much as possible. Pans should not touch each other or the walls of the oven. If you need to use two racks, stagger the pans so one is not directly above the other, and leave approximately 1½" between pans, from the front, back and sides of the wall.

Aluminum foil

You can use aluminum foil to line the broiler pan and broiler grid. However, you must mold the foil tightly to the grid and cut slits in it just like the grid.

Aluminum foil may also be used to catch a spillover.

Never entirely cover a rack with aluminum foil. This will disturb the heat circulation and result in poor baking.

A smaller sheet of foil may be used to catch a spillover by placing it on a lower rack several inches below the food.

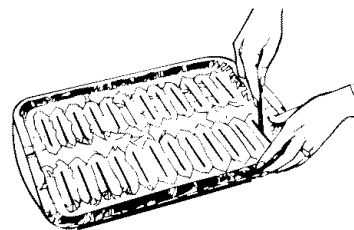

Cut slits in the foil just like the grid.

How to set the oven for broiling

- 1 Place the meat or fish on the broiler grid in the broiler pan.
- 2 Follow suggested rack positions in the Broiling Guide.

If your oven is connected to 208 volts, rare steaks may be broiled by preheating the broiler and positioning the oven rack one position higher.

- 3 Press the **BROIL HIGH/LOW** pad once for **HI Broil**.

To change to **LO Broil**, press the **BROIL HIGH/LOW** pad again.

- 4 Press the **START** pad.
- 5 When broiling is finished, press the **CLEAR/OFF** pad.

NOTE: Broil will not work if the temperature probe is plugged in.

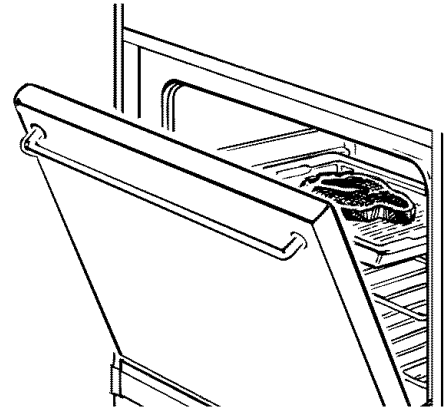

Leave the door open to the broil stop position. The door stays open by itself, yet the proper temperature is maintained in the oven.

NOTE: Food can be broiled with the door closed, but it may not brown as well because the oven heating element will cycle on and off.

*Broiling guide
for 27" ovens
(on some
models)*

*The size, weight, thickness,
starting temperature and
your preference for doneness
will affect broiling times.
This guide is based on meats
at refrigerator temperature.*

**The U.S. Department of
Agriculture says "Rare beef is
popular, but you should
know that cooking it to only
140°F means some food
poisoning organisms may
survive." (Source: Safe Food
Book. Your Kitchen Guide.
USDA Rev. June 1985.)*

Food	Quantity and/ or Thickness	Rack Position	First Side Time (min.)	Second Side Time (min.)	Comments
Ground Beef Well Done	1 lb. (4 patties) 1/2 to 3/4" thick	C	10	7	Space evenly. Up to 8 patties take about the same time.
Beef Steaks					
Rare†	1" thick	C	6	5	Steaks less than 1" thick cook through before browning. Pan frying is recommended.
Medium	1 to 1½ lbs.	C	8	6	
Well Done		C	12	11	
Rare†	1½" thick	C	10	7-8	Slash fat.
Medium	2 to 2½ lbs.	C	15	14-16	
Well Done		C	25	20-25	
Chicken	1 whole 2 to 2½ lbs., split lengthwise	A	35	10-15	Reduce time about 5 to 10 minutes per side for cut-up chicken. Brush each side with melted butter. Broil skin-side-down first.
Lobster Tails	2-4 6 to 8 oz. each	B	13-16	Do not turn over.	Cut through back of shell. Spread open. Brush with melted butter before broiling and after half of broiling time.
Fish Fillets	1/4 to 1/2" thick	C	5	5	Handle and turn very carefully. Brush with lemon butter before and during cooking, if desired. Preheat broiler to increase browning.
Ham Slices (precooked)	1" thick	B	8	8	Increase time 5 to 10 minutes per side for 1½" thick or home-cured ham.
Pork Chops					
Well Done	2 (1/2" thick)	C	10	10	Slash fat.
	2 (1" thick) about 1 lb.	B	13	13	
Lamb Chops					
Medium	2 (1" thick)	C	10	9	Slash fat.
Well Done	about 10 to 12 oz.	C	12	10	
Medium	2 (1½" thick)	C	14	12	
Well Done	about 1 lb.	B	17	12-14	

Broiling

Wall Oven

Broiling guide for 30" ovens (on some models)

The size, weight, thickness, starting temperature and your preference for doneness will affect broiling times. This guide is based on meats at refrigerator temperature.

**The U.S. Department of Agriculture says "Rare beef is popular, but you should know that cooking it to only 140°F means some food poisoning organisms may survive." (Source: Safe Food Book, Your Kitchen Guide, USDA Rev. June 1985.)*

Food	Quantity and/ or Thickness	Rack Position	First Side Time (min.)	Second Side Time (min.)	Comments
Ground Beef	1 lb. (4 patties)	E	10	7	Space evenly. Up to 8 patties take about the same time.
Well Done	1/2 to 3/4" thick	E	10	9	
Beef Steaks					Steaks less than 1" thick cook through before browning. Pan frying is recommended. Slash fat.
Rare†	1" thick	E	8	6	
Medium	1 to 1½ lbs.	E	10	8	
Well Done		E	12	10	
Rare†	1½" thick	E	10	8	
Medium	2 to 2½ lbs.	E	15	14-16	
Well Done		E	25	20-25	
Chicken	1 whole 2 to 2½ lbs., split lengthwise	C	25	10	Reduce time about 5 to 10 minutes per side for cut-up chicken. Brush each side with melted butter. Broil skin-side-down first.
Lobster Tails	2-4 6 to 8 oz. each	C	13-16	Do not turn over:	Cut through back of shell. Spread open. Brush with melted butter before broiling and after half of broiling time.
Fish Fillets	1/4 to 1/2" thick	E	5	5	Handle and turn very carefully. Brush with lemon butter before and during cooking, if desired. Preheat broiler to increase browning.
Ham Slices (precooked)	1" thick	D	8	8	Increase time 5 to 10 minutes per side for 1½" thick or home-cured ham.
Pork Chops	2 (1/2" thick)	E	10	10	Slash fat.
Well Done	2 (1" thick) about 1 lb.	D	15	15	
Lamb Chops					Slash fat.
Medium	2 (1" thick)	E	10	9	
Well Done	about 10 to 12 oz.	E	12	10	
Medium	2 (1½" thick)	E	14	12	
Well Done	about 1 lb.	E	17	12-14	

Using the timed baking and roasting features

NOTE: Foods that spoil easily, such as milk, eggs, fish, stuffings, poultry and pork, should not be allowed to sit for more than 1 hour before or after cooking. Room temperature promotes the growth of harmful bacteria. Be sure that the oven light is off because heat from the bulb will speed harmful bacteria growth.

On double oven models, you can use timed baking in one oven while using self-clean in the other; you can also use timed baking in both ovens at the same time.

How to set an immediate start and automatic stop

The oven will turn on immediately and cook for a selected length of time. At the end of the cooking time the oven will turn off automatically.

Make sure the oven clock shows the correct time of day.

- 1 Press the **BAKE** pad.
- 2 Using the number pads, enter the desired temperature.
- 3 Press the **COOK TIME** pad.

NOTE: If your recipe requires preheating, you may need to add additional time to the length of the cooking time.

- 4 Using the number pads, enter the desired baking time. The oven temperature and the cooking time that you entered will be displayed.

- 5 Press the **START** pad.

The display shows the oven temperature that you set and the cooking time countdown. (The display starts changing once the temperature reaches 100°F.)

NOTE: On double oven models, when using both ovens at the same time, the times showing in the display will be for the last oven set. To display the time set for the first oven set, press the **COOK TIME** pad for that oven.

The oven will continue to cook for the programmed amount of time, then shut off automatically, unless the **WARM** feature was set. See the *How to set the oven for warming* section.

- 6 Press the **CLEAR/OFF** pad to clear the display.

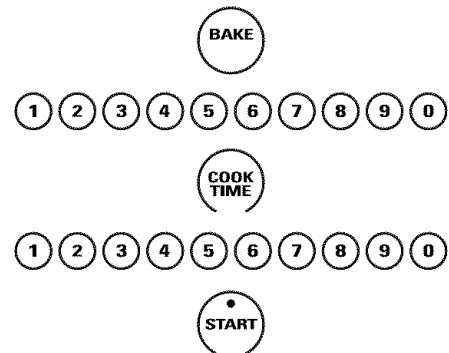

How to set a delayed start and automatic stop

You can set the oven control to delay-start the oven, cook for a specific length of time and then turn off automatically.

Make sure the oven clock shows the correct time of day.

- 1 Press the **BAKE** pad.
- 2 Using the number pads, enter the desired temperature.
- 3 Press the **COOK TIME** pad.

NOTE: If your recipe requires preheating, you may need to add additional time to the length of the cooking time.

- 4 Using the number pads, enter the desired baking time.
- 5 Press the **DELAY START** pad.
- 6 Using the number pads, enter the time of day you want the oven to turn on and start cooking.
- 7 Press the **START** pad.

*NOTE: An attention tone will sound if you are using timed baking and do not press the **START** pad after entering the baking temperature.*

If you would like to check the times you have set, press the **DELAY START** pad to check the start time you have set or press the **COOK TIME** pad to check the length of cooking time you have set.

When the oven turns on at the time of day you have set, the display will show the changing temperature (starting at 100°F) and the cooking time countdown.

*NOTE: On double oven models, when using both ovens at the same time, the times showing in the display will be for the last oven set. To display the time set for the first oven set, press the **DELAY START** pad to check the start time you have set or press the **COOK TIME** pad to check the length of cooking time you have set.*

The oven will continue to cook for the programmed amount of time, then shut off automatically, unless the **WARM** feature was set. See the *How to set the oven for warming* section.

- 8 Press the **CLEAR/OFF** pad to clear the display.

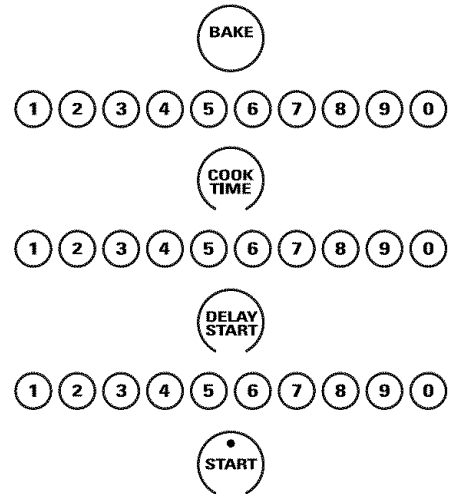

Temperature probe

For many foods, especially roasts and poultry, internal food temperature is the best test for doneness. The temperature probe takes the guesswork out of roasting by cooking foods to the exact doneness you want.

Use of probes other than the one provided with this product may result in damage to the probe.

Use the handles of the probe and plug when inserting and removing them from the meat and outlet.

- To avoid damaging your probe, do not use tools to pull on the cable when removing it.
- To avoid breaking the probe, make sure food is completely defrosted before inserting.
- To prevent possible burns, do not unplug the probe from the outlet until the oven has cooled.
- Never leave your probe inside the oven during a self-cleaning cycle.
- Do not store the probe in the oven.

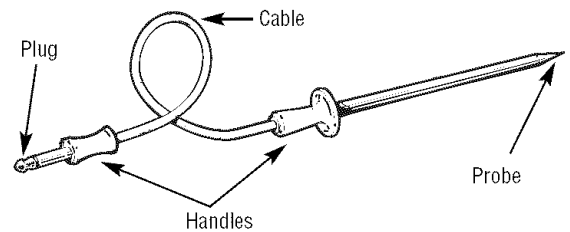

The temperature probe has a skewer-like probe at one end and a plug at the other end that goes into the outlet in the oven.

Proper placement of the probe

After preparing the meat and placing it on a trivet or on the broiler pan grid, follow these directions for proper probe placement.

- 1 Lay the probe on the outside of the meat along the top or side and mark with your finger where the edge of the meat comes to on the probe. The point should rest in the center of the thickest meaty part of the roast.
- 2 Insert the probe completely into the meat, up to the handle. It should not touch the bone, fat or gristle.

For roasts with no bone, insert the probe into the meatiest part of the roast. For bone-in ham or lamb, insert the probe into the center of the lowest large muscle or joint.

Insert the probe into the center of dishes such as meat loaf or casseroles. When cooking fish, insert the probe from just above the gill into the meatiest area, parallel to the backbone.

Insert the probe into the meatiest part of the inner thigh from below and parallel to the leg of a whole turkey.

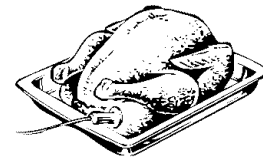
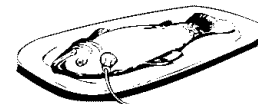
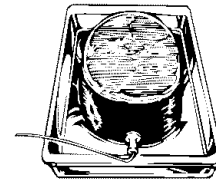

*How to set
the oven for
roasting
when using
the probe*

- 1 Insert the probe into the meat.
- 2 Plug the probe into the outlet in the oven.
Make sure it is pushed all the way in.
Close the oven door.
- 3 Press the **PROBE** pad.
- 4 Press the number pads to set the desired internal food or meat temperature. The maximum internal temperature for the food that you can set is 200°F.
- 5 Press the **BAKE** pad.
- 6 Press the number pads to set the desired oven temperature.
- 7 Press the **START** pad.

*The display will flash if the probe is inserted into the outlet and you have not set a probe temperature and pressed the **START** pad.*

When the oven starts to heat, the word "LO" will be in the display.

After the internal temperature of the meat reaches 100°F, the changing internal temperature will be shown in the display.

- 8 When the internal temperature of the meat reaches the number you have set, the probe and the oven turn off and the oven control signals. To stop the signal, press the **CLEAR/OFF** pad. Use hot pads to remove the probe from the food. Do not use tongs to pull on it—they might damage it.

To change the oven temperature during the Roast cycle, press the **BAKE** pad and then the number pads to set the new temperature.

- If the probe is removed from the food before the final temperature is reached, a tone will sound and the display will flash until the probe is removed from the oven.
- You can use the timer even though you cannot use timed oven operations.

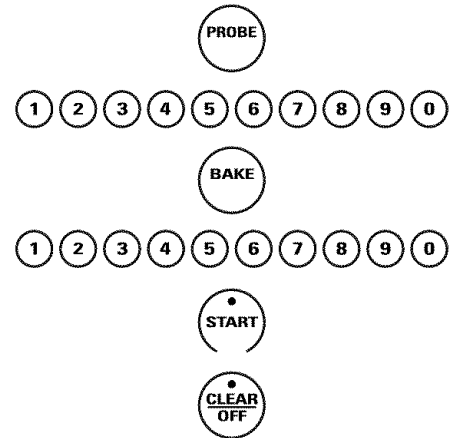
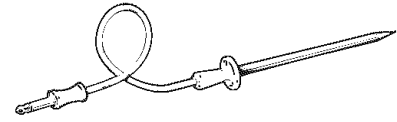

Convection fan

In a convection oven, a fan circulates hot air over, under and around the food.

This circulating hot air is evenly distributed throughout the oven cavity. As a result, foods are evenly cooked and browned—often in less time with convection heat.

NOTE: The convection fan will cycle on and off while cooking to best distribute hot air in the oven.

The convection fan shuts off when the oven door is opened. **DO NOT** leave the door open for long periods of time while using convection cooking or you may shorten the life of the convection heating element.

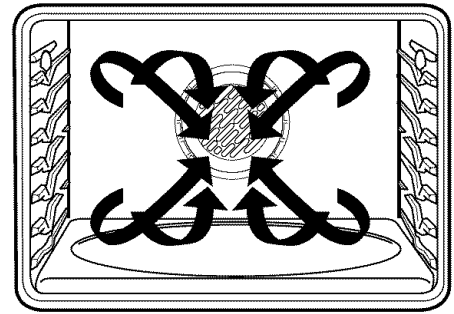

1-Rack convection baking

The convection fan circulates the heated air evenly over and around the food using the bake and broil elements.

When convection baking with only 1 rack, use CONVECTION BAKE 1 RACK and for best results place the rack on shelf C or D at the center of the

oven. Cook times may decrease, so food should be checked earlier than package directions to make sure that it does not overcook.

Ideal for cooking large casseroles and lasagna with good results.

Multi-rack convection baking

CAUTION:

When you are using the offset rack (on 27" models) in the lowest position (A), you will need to use caution when pulling the rack out. We recommend that you pull the rack out several inches and then, using two pot holders, pull the rack out by holding the sides of it. The offset rack is low and you could be burned if you place your hand in the middle of the rack and pull all the way out. Be very careful not to burn your hand on the door when using a rack in the lowest position (A).

Because heated air is circulated evenly throughout the oven, foods can be baked with excellent results using multiple racks.

The amount of time required for multi-rack baking may increase slightly for some foods, but overall time is saved because two to three times as much food is cooked at once. Cookies, muffins, biscuits, and other quick breads give good results with multi-rack baking.

27" Ovens

When baking on 3 racks, divide the oven into thirds by placing the offset rack in the third (C) rack position and the straight racks in first (A) and fourth (D) rack positions.

For two-rack baking, place the offset rack in the bottom (A) rack position. Place the straight rack in the third (C) rack position.

30" Ovens

When baking on 3 racks, place one rack in the second (B) position, one in the fourth (D) position and one in the 6th (F) position. For cookies, place one rack in the third (C) position, one in the 5th (E) position and one in the 6th (F) position.

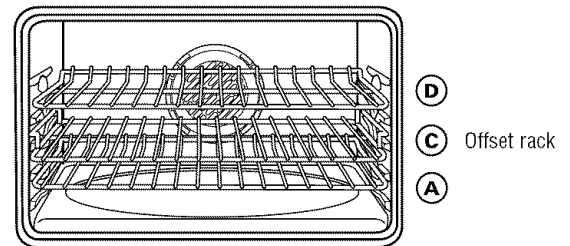

Multi-rack position 27" oven

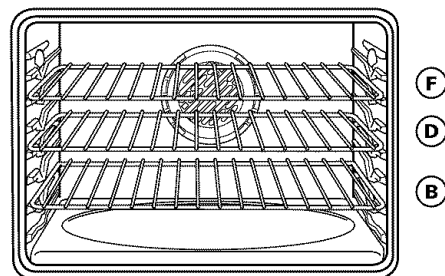

Multi-rack position 30" oven

Adapting recipes

You can use your favorite recipes in the convection oven.

When convection baking, reduce baking temperature by 25°F or activate the Auto Recipe™ Conversion feature. See the *Special Features* section.

Use pan size recommended.

Some package instructions for frozen casseroles or main dishes have been developed using commercial convection ovens. For best results in this oven, preheat the oven and use the temperature on the package.

Cookware for convection cooking

Before using your convection oven, check to see if your cookware leaves room for air circulation in the oven. If you are baking with several pans, leave space between them. Also, be sure the pans do not touch each other or the walls of the oven.

Paper and Plastic

Heat-resistant paper and plastic containers that are recommended for use in regular ovens can be used in convection ovens. Plastic cookware that is heat-resistant to temperatures of 400°F can also be used.

Metal and Glass

Any type of cookware will work in your convection oven. However, metal pans heat the fastest and are recommended for convection baking.

Darkened or matte-finished pans will bake faster than shiny pans.

Glass or ceramic pans cook more slowly.

When baking cookies, you will get the best results if you use a flat cookie sheet instead of a pan with low sides.

For recipes like oven-baked chicken, use a pan with low sides. Hot air cannot circulate well around food in a pan with high sides.

Convection roasting

- Good for large tender cuts of meat, uncovered.

The convection fan circulates the heated air evenly over and around the food. Meat and poultry are browned on all sides as if they were cooked on a rotisserie. Using the roasting rack provided, heated air will be circulated over, under and around the food being roasted. The heated air seals in juices quickly for a moist and tender product while, at the same time, creating a rich golden brown exterior.

When you are convection roasting, it is important that you use the broiler pan and grid and the special roasting rack for best convection roasting results. The pan is used to catch grease spills and the grid is used to prevent grease splatters, while the roasting rack allows the heated air to circulate under the meat and increase browning on the underside of the meat or poultry.

- Place the rack (on 27" models use the offset rack) in the lowest rack position (A).
- Place the grid on the broiler pan and put the roasting rack over them, making sure the posts on the roasting rack fit into the holes in the broiler pan.
- Place meat on the special roasting rack.

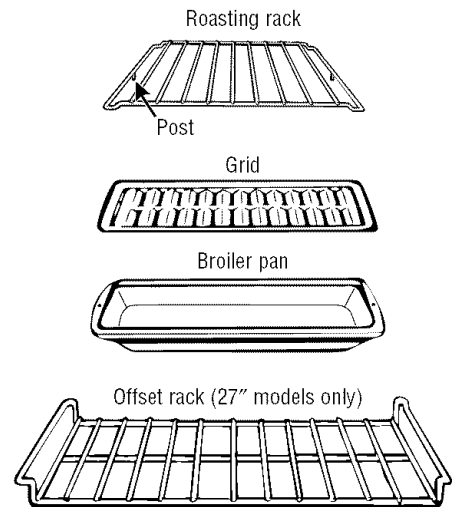

CAUTION:

When you are using the offset rack (on 27" models) in the lowest position (A), you will need to use caution when pulling the rack out. We recommend that you pull the rack out several inches and then, using two pot holders, pull the rack out by holding the sides of it. The offset rack is low and you could be burned if you place your hand in the middle of the rack and pull all the way out. Be very careful not to burn your hand on the door when using a rack in the lowest position (A).

Using the Convection Oven

Wall Oven

How to set the oven for convection baking or roasting

To avoid possible burns, place the racks in the correct position before you turn on the oven.

1 Press the **CONV BAKE/1 RACK** pad (Convection Bake 1-Rack mode) for 1-rack convection baking. This mode is used for cooking food items on only 1 rack in convection bake.

Press the **CONV BAKE/MULTI** pad (Convection Bake Multi mode) for multi-rack convection baking. This mode is used for cooking food items on more than one rack (i.e. 2, 3 or more racks) at the same time in Convection Bake. See the *Multi-rack convection baking* section for more information.

Press the **CONV ROAST** pad for convection roasting.

2 Press the number pads to set the desired oven temperature.

3 Press the **START** pad.

To change the oven temperature, press the **CONV BAKE/MULTI**, **CONV BAKE/1 RACK** or **CONV ROAST** pad and then the number pads to set the new temperature.

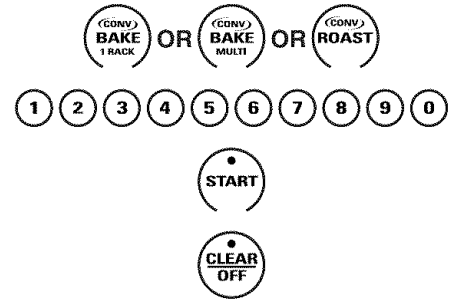

When the oven starts to heat, the changing temperature, starting at 100°F, will be displayed. When the oven reaches the temperature you set, 3 beeps will sound.

4 Press the **CLEAR/OFF** pad when finished.

NOTE:

- You will hear a fan while cooking with convection. The fan will stop when the door is opened but the heat will not turn off.
- You may hear the oven clicking during baking. This is normal.
- The convection fan will cycle on and off while cooking to best distribute the hot air in the oven.

Convection roasting guide

Meats		Minutes/Lb.	Oven Temp.	Internal Temp.	
Beef	Rib, Boneless Rib, Top Sirloin (3 to 5 lbs.)	Rare 20–24 Medium 24–28 Well 28–32	325°F 325°F 325°F	140°F† 160°F 170°F	
	Beef Tenderloin	Rare 10–14 Medium 14–18	325°F 325°F	140°F† 160°F	
Pork	Bone-in, Boneless (3 to 5 lbs.)		325°F	170°F	
	Chops (1/2 to 1" thick)	2 chops	30–35 total	325°F	170°F
		4 chops	35–40 total	325°F	170°F
6 chops		40–45 total	325°F	170°F	
Ham	Canned, Butt, Shank (3 to 5 lbs.) (fully cooked)		325°F	140°F	
Lamb	Bone-in, Boneless (3 to 5 lbs.)	Medium	17–20	325°F	160°F
		Well	20–24	325°F	170°F
Seafood	Fish, whole (3 to 5 lbs.)		30–40 total	400°F	
	Lobster Tails (6 to 8 oz. each)		20–25 total	350°F	
Poultry	Whole Chicken (2½ to 3½ lbs.)		24–26	350°F	180°–185°F
	Cornish Hens Unstuffed (1 to 1½ lbs.) Stuffed (1 to 1½ lbs.)		50–55 total	350°F	180°–185°F
			55–60 total	350°F	180°–185°F
	Duckling (4 to 5 lbs.)		24–26	325°F	180°–185°F
	Turkey, whole* Unstuffed (10 to 16 lbs.) Unstuffed (18 to 24 lbs.)		8–11	325°F	180°–185°F
		7–10	325°F	180°–185°F	
	Turkey Breast (4 to 6 lbs.)		16–19	325°F	170°F

* Stuffed birds generally require 30–45 minutes additional roasting time. Shield legs and breast with foil to prevent over-browning and drying of skin.

† The U.S. Department of Agriculture says "Rare beef is popular, but you should know that cooking it to only 140°F means some food poisoning organisms may survive." (Source: Safe Food Book. Your Kitchen Guide. USDA Rev. June 1985.)

How to set the oven for convection roasting when using the probe

CAUTION: To prevent possible burns, do not unplug the probe from the oven outlet until the oven has cooled. Do not store the probe in the oven.

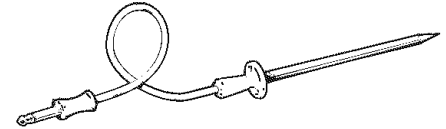

For best results when roasting large turkeys and roasts, we recommend using the probe included in the convection oven.

- 1 Place the rack (on 27" models use the offset rack) in the lowest rack position (A). Insert the probe into the meat.
- 2 Plug the probe into the outlet in the oven. Make sure it is pushed all the way in. Close the oven door.
- 3 Press the **CONV ROAST** pad.
- 4 Press the number pads to set the desired oven temperature.

To change the oven temperature during the Convection Roast cycle, press the **CONV ROAST** pad and then press the number pads to set the new desired temperature.

- 5 Press the **PROBE** pad.
- 6 Press the number pads to set the desired internal meat temperature.
- 7 Press the **START** pad.

*The display will flash "PROBE" and the oven control will signal if the probe is inserted into the outlet, and you have not set a probe temperature and pressed the **START** pad.*

When the oven starts to heat, the word "LO" will be in the display.

After the internal temperature of the meat reaches 100°F, the changing internal temperature will be shown in the display.

- 8 When the internal temperature of the meat reaches the number you have set, the probe and the oven turn off and the oven control signals. To stop the signal, press the **CLEAR/OFF** pad. Use hot pads to remove the probe from the food. Do not use tongs to pull on it—they might damage it.

If the probe is removed from the food before the final temperature is reached, a tone will sound and the display will flash until the probe is removed from the oven.

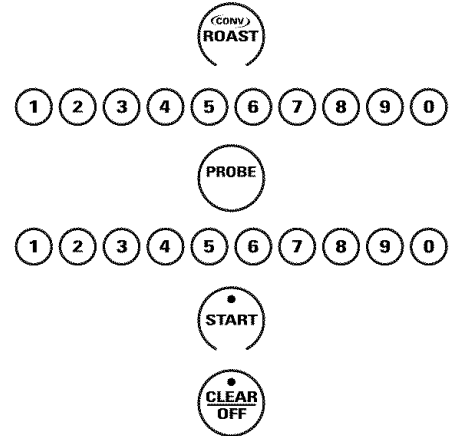

NOTES:

- You will hear a fan while cooking with these features. The fan will stop when the door is opened but the heat will not turn off.
- You can use the timer even though you cannot use timed oven operations.
- On double oven models, you will not be able to use the probe in the upper oven during timed oven operations. This is because with the probe you are cooking by temperature rather than time.

Timed Convection Baking

Wall Oven

Using the timed features for convection cooking

NOTE: Foods that spoil easily, such as milk, eggs, fish, stuffings, poultry and pork, should not be allowed to sit for more than 1 hour before or after cooking. Room temperature promotes the growth of harmful bacteria. Be sure that the oven light is off because heat from the bulb will speed harmful bacteria growth.

On double oven models, you can use timed baking or roasting in one oven while using self-clean in the other; you can also use timed baking or roasting in both ovens at the same time.

How to set an immediate start and automatic stop

The oven will turn on immediately and cook for a selected length of time. At the end of the cooking time, the oven will turn off automatically.

Make sure the oven clock shows the correct time of day.

- 1 Press the **CONV BAKE/1 RACK** pad (Convection Bake 1-Rack mode) for 1-rack convection baking. This mode is used for cooking food items on only 1 rack in convection bake.

Press the **CONV BAKE/MULTI** pad (Convection Bake Multi mode) for multi-rack convection baking. This mode is used for cooking food items on more than one rack (i.e. 2, 3 or more racks) at the same time in Convection Bake. See the *Multi-rack convection baking* section for more information.

Press the **CONV ROAST** pad for convection roasting.

- 2 Press the number pads to set the desired oven temperature.
- 3 Press the **COOK TIME** pad.

NOTE: If your recipe requires preheating, you may need to add additional time to the length of the cooking time.

- 4 Press the number pads to set the desired length of cooking time. The minimum cooking time you can set is 1 minute.

The oven temperature that you set and the cooking time that you entered will be in the display.

- 5 Press the **START** pad.

The display shows the oven temperature that you set and the cooking time countdown. (The display starts changing once the temperature reaches 100°F.)

NOTE: On double oven models, when using both ovens at the same time, the times showing in the display will be for the last oven set. To display the time set for the first oven set, press the **COOK TIME** pad for that oven.

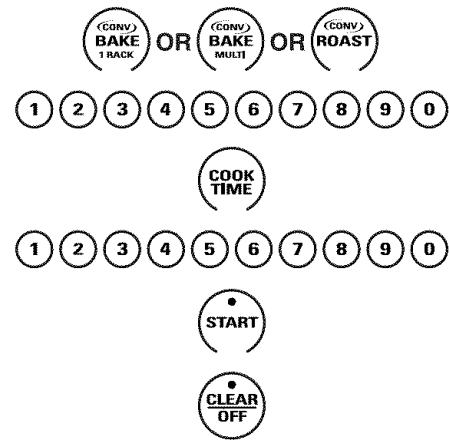

The oven will continue to cook for the programmed amount of time, then shut off automatically, unless the WARM feature was set. See the *How to set the oven for warming* section.

- 6 Press the **CLEAR/OFF** pad to clear the display if necessary. Remove the food from the oven. Remember, even though the oven shuts off automatically, food left in the oven will continue cooking after the oven turns off.

NOTE: You will hear a fan while cooking with this feature. The fan will cycle on and off while cooking to best distribute the hot air, and will stop when the door is opened but the heat will not turn off.

How to set a delayed start and automatic stop

You can set the oven control to delay-start the oven, cook for a specific length of time and then turn off automatically.

Make sure the oven clock shows the correct time of day.

- 1 Press the **CONV BAKE/1 RACK** pad (Convection Bake 1-Rack mode) for 1-rack convection baking. This mode is used for cooking food items on only 1 rack in convection bake.

Press the **CONV BAKE/MULTI** pad (Convection Bake Multi mode) for multi-rack convection baking. This mode is used for cooking food items on more than one rack (i.e. 2, 3 or more racks) at the same time in Convection Bake. See the *Multi-rack convection baking* section for more information.

Press the **CONV ROAST** pad for convection roasting.

- 2 Press the number pads to set the desired oven temperature.
 - 3 Press the **COOK TIME** pad.
- NOTE: If your recipe requires preheating, you may need to add additional time to the length of the cooking time.*
- 4 Press the number pads to set the desired cooking time.
 - 5 Press the **DELAY START** pad.
 - 6 Press the number pads to set the time of day you want the oven to turn on and start cooking.

If you would like to check the times you have set, press the **DELAY START** pad to check the start time you have set or press the **COOK TIME** pad to check the length of cooking time you have set.

- 7 Press the **START** pad.

*NOTE: An attention tone will sound if you are using timed baking or roasting and do not press the **START** pad after entering the baking or roasting temperature.*

When the oven turns on at the time of day you have set, the display will show the changing temperature (starting at 100°F) and the cooking time countdown. (The display starts changing once the temperature reaches 100°F.)

*NOTE: On double oven models, when using both ovens at the same time, the times showing in the display will be for the last oven set. To display the time set for the first oven set, press the **DELAY START** pad to check the start time you have set or press the **COOK TIME** pad to check the length of cooking time you have set.*

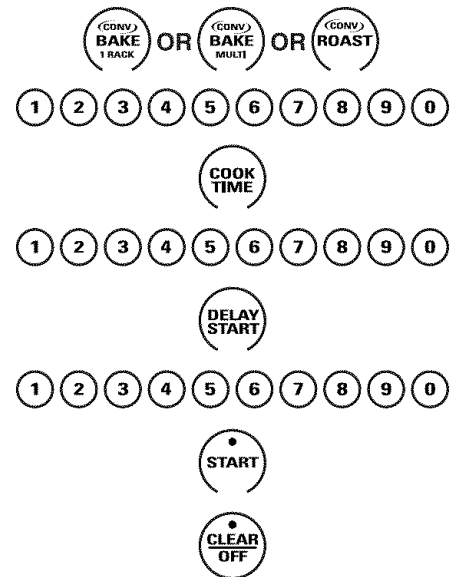

The oven will continue to cook for the programmed amount of time, then shut off automatically, unless the WARM feature was set. See the *How to set the oven for warming* section.

- 8 Press the **CLEAR/OFF** pad to clear the display if necessary. Remove the food from the oven. Remember, even though the oven shuts off automatically, food left in the oven will continue cooking after the oven turns off.

NOTE: You will hear a fan while cooking with this feature. The fan will cycle on and off while cooking to best distribute the hot air, and will stop when the door is opened but the heat will not turn off.

How to set the oven for warming

Warm keeps cooked foods warm for up to 3 hours after the cooking function is finished, or it can be activated independently to keep already cooked foods warm.

This feature is not designed to reheat cold food.

To use this feature independently, press the **WARM/PROOF** pad once and then the **START** pad.

To activate this feature for use after Timed Baking or Roasting, press the **WARM/PROOF** pad once while programming the oven and before pressing **START**.

To Crisp Stale Items

- Place food in low-sided dishes or pans.
- For best results, place the food items in a single layer; do not stack.
- Leave them uncovered.
- Check crispness after 20–30 minutes. Add time as needed.

IMPORTANT NOTES:

- *Food should be kept hot in its cooking container or transferred to a heat-safe serving dish.*
- *For moist foods, cover them with an oven-safe lid or aluminum foil.*
- *Fried or crisp foods do not need to be covered but can become too dry if warmed for too long.*
- *Repeated opening of the door allows the hot air to escape and the food to cool.*
- *Allow extra time for the temperature inside the oven to stabilize after adding items.*
- *With large loads it may be necessary to cover some of the cooked food items.*
- *Remove serving spoons, etc., before placing containers in the oven.*
- *Do not use plastic containers, lids or plastic wrap.*

CAUTION: *Plastic containers, lids or plastic wrap will melt if placed in the oven. Melted plastic may not be removable and is not covered under your warranty.*



How to set the oven for proofing

The proofing feature maintains a warm environment useful for rising yeast-leavened products.

- 1 Place the covered dough in a dish in the oven on rack B or C.

NOTE: For best results, cover the dough with a cloth or with greased plastic wrap (the plastic may need to be anchored underneath the container so the oven fan will not blow it off).

- 2 Press the **WARM/PROOF** pad twice and then the **START** pad.

The display will read “PrF” (proof).

The oven interior light turns on and remains on during proofing.

The proofing feature automatically provides the desired temperature for proofing and therefore does not have a temperature adjustment.

- 3 Set the **TIMER ON/OFF** for a maximum of 1 hour. Depending upon the recipe, bread may complete proofing in less than 1 hour. Check bread as needed for progress.

- 4 After 1 hour of proofing, press the **CLEAR/OFF** pad. If proofing is not complete, leave the bread in the closed oven until it reaches the desired height.

- To avoid lowering the oven temperature and lengthening proofing time, do not open the oven door unnecessarily.
- Check bread products early to avoid over-proofing.

NOTES:

- Do not use the proofing mode for warming food or keeping food hot. The proofing oven temperature is not hot enough to hold foods at safe temperatures. Use the **WARM** feature to keep food warm.
- Proofing feature on upper oven only.
- Proofing will not operate when oven is above 125°F. “HOT” will show in the display.



NOTE:

Set the oven to **PROOF** for a maximum of 1 hour, then leave the bread in the closed oven until it reaches the desired height. Using **PROOF** in excess of 1 hour may kill the yeast.

Adjust the Oven Thermostat

Wall Oven

Do it yourself!

You may find that your new oven cooks differently than the one it replaced. Use your new oven for a few weeks to become more familiar with it. If you still think your new oven is too hot or too cold, you can adjust the thermostat yourself.

Do not use thermometers, such as those found in grocery stores, to check the temperature setting of your oven. These thermometers may vary 20–40 degrees.

NOTE: This adjustment will only affect baking temperatures; it does not affect broiling, convection or self-cleaning temperatures. The adjustment will be retained in memory after a power failure.

To adjust the oven thermostat

- 1 Press the **BAKE** and **BROIL HIGH/LOW** pads at the same time for 3 seconds until the display shows “SF.”
- 2 Press the **BAKE** pad of the oven on which you want to adjust the oven thermostat. A two-digit number shows in the display. Press **BAKE** once to decrease (-) the oven temperature, or twice to increase (+).
- 3 The oven temperature can be adjusted up to (+) 35°F hotter or (-) 35°F cooler. Press the number pads the same way you read them. For example, to change the oven temperature 15°F, press 1 and 5.
- 4 When you have made the adjustment, press the **START** pad to go back to the time of day display. Use your oven as you would normally.

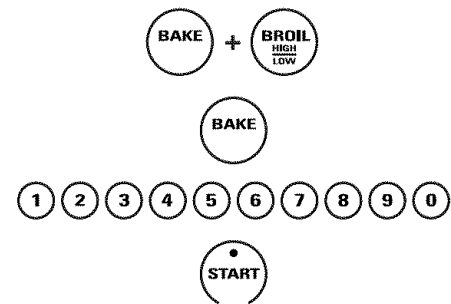

The type of margarine will affect baking performance!

Most recipes for baking have been developed using high-fat products such as butter or margarine (80% fat). If you decrease the fat, the recipe may not give the same results as with a higher-fat product.

Recipe failure can result if cakes, pies, pastries, cookies or candies are made with low-fat spreads. The lower the fat content of a spread product, the more noticeable these differences become.

Federal standards require products labeled “margarine” to contain at least 80% fat by weight. Low-fat spreads, on the other hand, contain less fat and more water. The high moisture content of these spreads affect the texture and flavor of baked goods. For best results with your old favorite recipes, use margarine, butter or stick spreads containing at least 70% vegetable oil.

Using the Self-Cleaning Oven

Wall Oven

Before a clean cycle

The oven door must be closed and all controls must be set correctly for the cycle to work properly.

We recommend venting your kitchen with an open window or using a ventilation fan or hood during the first self-clean cycle.

Remove the broiler pan, broiler grid, probe, all cookware and any aluminum foil from the oven.

Gray porcelain-coated oven racks (including the offset rack) may remain in the oven during the self-cleaning cycle without being damaged. The convection roasting rack and nickel-plated oven racks (including the offset rack) may remain in the oven during the self-cleaning cycle, but they will darken and become hard to slide.

Do not use abrasives or oven cleaners. Clean the top, sides and outside of the oven door with soap and water.

Make sure the oven light bulb cover (on some models) is in place and the oven light is off.

IMPORTANT: The health of some birds is extremely sensitive to the fumes given off during the self-cleaning cycle of any oven. Move birds to another well-ventilated room.

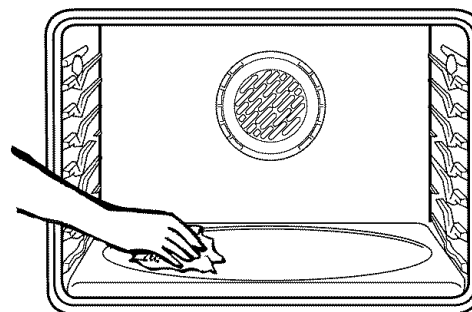

Wipe up heavy soil on the oven bottom.
(Appearance may vary.)

On double oven models, you can set a clean cycle in both ovens at the same time. The last oven set will automatically delay its start until the end of the first oven's clean cycle.

On double oven models, you can use timed baking in one oven and self-clean the other at the same time.

How to set the oven for cleaning

- 1 Press the **SELF CLEAN STD/LOW** pad once for a 4-hour clean time or twice for a 3-hour clean time.

A 3-hour self-clean time is recommended for use when cleaning small, contained spills. A self-clean time of 4 hours or longer is recommended for a dirtier oven.

- 2 If a time other than 4 hours or 3 hours is needed, use the number pads and enter the desired clean time.

You can change the clean time to any time between 3 hours and 5 hours, depending on how dirty your oven is.

- 3 Press the **START** pad.

The door locks automatically. The display will show the clean time remaining. It will not be possible to open the oven door until the temperature drops below the lock temperature and the LOCKED light goes off.

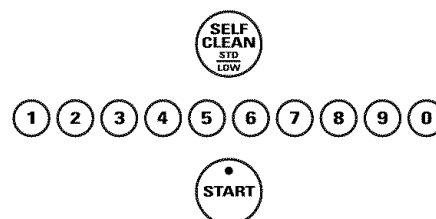

When the LOCKED light goes off, you will be able to open the door.

- The word "LOCK" will flash and the oven control will signal if you set the clean cycle and forget to close the oven door.
- To stop a clean cycle, press the **CLEAR/OFF** pad. When the LOCKED light goes off indicating the oven has cooled below the locking temperature, you will be able to open the door.

How to delay the start of cleaning

- 1 Press the **SELF CLEAN STD/LOW** pad once for a 4-hour clean time or twice for a 3-hour clean time.

A 3-hour self-clean time is recommended for use when cleaning small, contained spills. A self-clean time of 4 hours or longer is recommended for a dirtier oven.

- 2 If a time other than 4 hours or 3 hours is needed, use the number pads and enter the desired clean time.

You can change the clean time to any time between 3 hours and 5 hours, depending on how dirty your oven is.

- 3 Press the **DELAY START** pad.
- 4 Using the number pads, enter the time of day you want the clean cycle to start.
- 5 Press the **START** pad.

The door locks automatically. The display will show the start time. It will not be possible to open the oven door until the temperature drops below the lock temperature and the **LOCKED** light goes off.

When the **LOCKED** light goes off, you will be able to open the door.

NOTE: On double oven models, you can set a delay clean in both ovens at the same time. The second oven set will automatically delay the start of cleaning until the end of the first oven's clean cycle.

To recall the start time of the second oven set, press the **DELAY START** pad on the controls for the second oven.

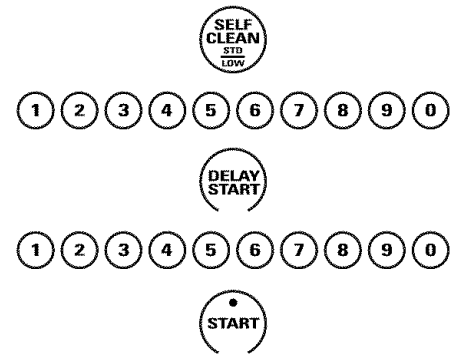

After a clean cycle

You may notice some white ash in the oven. Wipe it up with a damp cloth after the oven cools.

If white spots remain, remove them with a soap-filled steel wool pad and rinse thoroughly with a vinegar and water mixture.

These deposits are usually a salt residue that cannot be removed by the clean cycle.

If the oven is not clean after one clean cycle, repeat the cycle.

- You cannot set the oven for cooking until the oven is cool enough for the door to unlock.
- While the oven is self-cleaning, you can press the **CLOCK** pad to display the time of day. To return to the clean countdown, press the **SELF CLEAN STD/LOW** pad.
- If the racks become hard to slide, wipe the rack supports with cooking oil.

Care and Cleaning

Wall Oven

BE SURE ELECTRICAL POWER IS OFF AND ALL SURFACES ARE COOL BEFORE CLEANING ANY PART OF THE OVEN.

How to remove protective shipping film and packaging tape

Carefully grasp a corner of the protective shipping film with your fingers and slowly peel it from the appliance surface. Do not use any sharp items to remove the film. Remove all of the film before using the appliance for the first time. To assure no damage is done to the finish of the product, the

safest way to remove the adhesive from packaging tape on new appliances is an application of a household liquid dishwashing detergent. Apply with a soft cloth and allow to soak.

NOTE: The adhesive must be removed from all parts. It cannot be removed if it is baked on.

Oven racks and convection roasting rack

All oven racks and the convection roasting rack may be cleaned by hand with an abrasive cleaner or steel wool. After cleaning, rinse the racks with clean water and dry with a clean cloth. Gray porcelain-coated oven racks (including the offset rack) may remain in the oven during the self-cleaning cycle without being damaged. The convection roasting rack and nickel-plated oven racks (including the offset rack) may remain in the oven during the self-cleaning cycle, but they will lose their luster and become hard to slide. It will be necessary to grease all oven rack side edges with a light coating of vegetable oil after cleaning them by hand or in the oven. This will help maintain the ease of sliding the racks in and out of the oven.

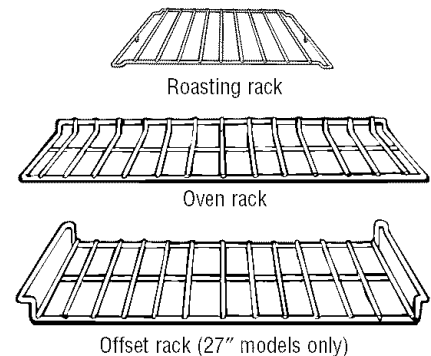

Stainless steel (If Included) & metal parts

Do not use a steel-wool pad; it will scratch the surface.

To clean the stainless steel surface, use warm sudsy water or a stainless steel cleaner or polish. Always wipe the surface in the direction of the grain. Follow the cleaner instructions for cleaning the stainless steel surface.

To inquire about purchasing stainless steel appliance cleaner or polish, or to find the location of a dealer nearest you, please call our toll-free number:

National Parts Center
ge.com

800.626.2002

Broiler pan and grid

After broiling, remove the broiler pan from the oven. Remove the grid from the pan. Carefully pour out the grease from the pan into a proper container.

Wash and rinse the broiler pan and grid in hot water with a soap-filled or plastic scouring pad.

If food has burned on, sprinkle the grid with detergent while hot and cover with wet paper towels or a dish cloth. Soaking the pan will remove burned-on foods.

Both the broiler pan and grid may be cleaned with a commercial oven cleaner.

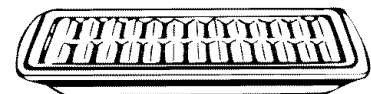

Both the broiler pan and grid can also be cleaned in a dishwasher.

Do not clean the broiler pan or grid in a self-cleaning oven.

Do not store a soiled broiler pan and grid anywhere in the oven.

Lift-off oven door— removal

The door is very heavy. Be careful when removing and lifting the door.

Do not lift the door by the handle.

To remove the door:

- 1 Fully open the door.
- 2 Pull the hinge locks down toward the door frame, to the unlocked position. A tool, such as a small flat-blade screwdriver, may be required.
- 3 Firmly grasp both sides of the door **at the top**.
- 4 Close door to the door removal position, which is halfway between the broil stop position and fully closed.
- 5 Lift door up and out until the hinge arm is clear of the slot.

To replace the door:

- 1 Firmly grasp both sides of the door **at the top**.
- 2 With the door at the same angle as the removal position, seat the indentation of the hinge arm into the bottom edge of the hinge slot. The notch in the hinge arm must be fully seated into the bottom of the slot.
- 3 Fully open the door. If the door will not fully open, the indentation is not seated correctly in the bottom edge of the slot.
- 4 Push the hinge locks up against the front frame of the oven cavity, to the locked position.
- 5 Close the oven door.

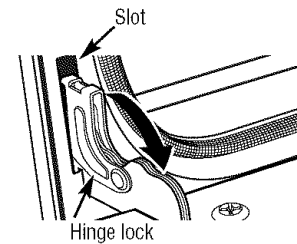

Pull hinge locks down to unlock

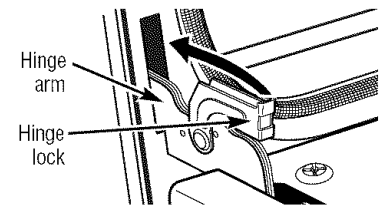
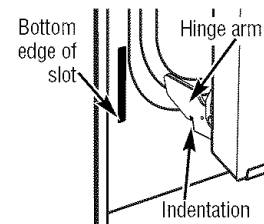
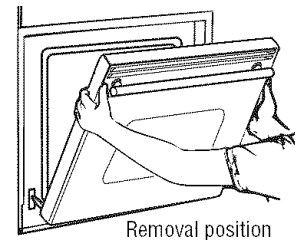

Push hinge locks up to lock

Oven door

To clean the inside of the door:

- Because the area inside the gasket is cleaned during the self-clean cycle, you do not need to clean this by hand.
- The area outside the gasket and the door liner can be cleaned with a soap-filled or plastic scouring pad, hot water and detergent. Rinse well with a vinegar and water solution.

To clean the outside of the door:

- Use soap and water to thoroughly clean the top, sides and front of the oven door. Rinse well. You may also use a glass cleaner to clean the glass on the outside of the door. Do not let water drip into the vent openings.
- If any stain on the door vent trim is persistent, use a soft abrasive cleaner and a sponge-scrubber for best results.
- Spillage of marinades, fruit juices, tomato sauces and basting materials containing acids may cause discoloration and should be wiped up immediately. When surface is cool, clean and rinse.
- Do not use oven cleaners, cleaning powders or harsh abrasives on the outside of the door.



Do not rub or clean the door gasket—it has an extremely low resistance to abrasion.

If you notice the gasket becoming worn, frayed or damaged in any way or if it has become displaced on the door, you should have it replaced.

Removable oven floor

To remove the oven floor:

- 1 Remove the oven door using the instructions in the Lift-Off Oven Door section of this manual.
- 2 Press down and pull out the removable oven floor.

3 Clean the oven floor with warm soapy water.

4 When re-installing the oven floor be sure to slide it all the way to the back of the oven.

CAUTION: Always replace the removable floor before the next use.

Oven heating elements

Do not clean the broil element. Any soil will burn off when the element is heated.

The bake element is not exposed and is under the removable oven floor. If spillovers, residue or ash accumulate on the removable oven floor, wipe up before self-cleaning.

To clean the bake element area, take out the removable floor (see the *Removable Oven Floor* section) and gently lift the bake element. Clean with warm soapy water. Always replace the removable floor before next use.

Control panel

It's a good idea to wipe the control panel after each use. Clean with mild soap and water or vinegar and water, rinse with clean water and polish dry with a soft cloth.

Do not use abrasive cleansers, strong liquid cleaners, plastic scouring pads or oven cleaners on the control panel—they will damage the finish. A 50/50 solution of vinegar and hot water works well.

Oven light bulbs

NOTE: The glass cover should be removed only when cold. Wearing latex gloves may offer a better grip.

CAUTION: Before replacing the bulb, disconnect electrical power to the oven at the main fuse or circuit breaker panel.

Be sure to let the light cover and bulb cool completely.

For your safety, do not touch a hot bulb with bare hands or a damp cloth.

To remove:

- 1 Turn the glass cover counterclockwise 1/4 turn until the tabs of the glass cover clear the grooves of the socket.
- 2 Using gloves or a dry cloth, remove the bulb by pulling it straight out.

To replace:

- 1 Use a new 130-volt Halogen bulb, not to exceed 50 watts.
- 2 Using gloves or a dry cloth, remove the bulb from its packaging. Do not touch the bulb with bare fingers.
- 3 Push the bulb straight into the receptacle all the way.
- 4 Place the tabs of the glass cover into the grooves of the socket. Turn the glass cover clockwise 1/4 turn.

For improved lighting inside the oven, clean the glass cover frequently using a wet cloth. This should be done when the oven is completely cool.

- 5 Reconnect electrical power to the oven.

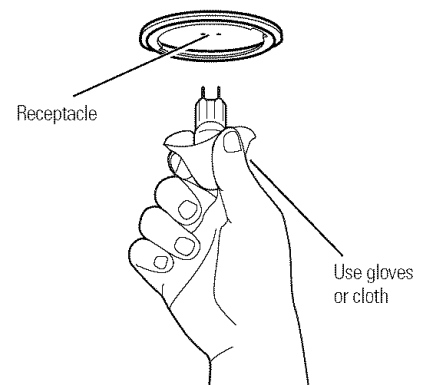
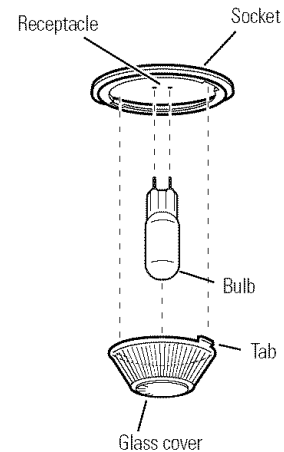

Probe

The temperature probe may be cleaned with soap and water or a soap-filled scouring pad. Cool the temperature probe before cleaning. Scour stubborn spots with a soap-filled scouring pad, rinse and dry.

Do not immerse the temperature probe in water.

Do not store the temperature probe in the oven.

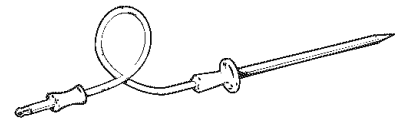

*Save time
& money!*

Review the troubleshooting tips on the following pages first and you may not need to call for service.

PROBLEM	POSSIBLE CAUSE
CLOCK AND TIMER DO NOT WORK	<ul style="list-style-type: none"> • A fuse in your home may be blown or the circuit breaker tripped. Replace the fuse or reset the circuit breaker. • Oven controls improperly set. See the <i>Oven Control, Clock and Timer</i> section.
OVEN LIGHT DOES NOT WORK	<ul style="list-style-type: none"> • Light bulb is loose or defective. Tighten or replace the bulb. • Pad operating light is broken. Call for service.
OVEN TEMPERATURE TOO HOT OR TOO COLD	<ul style="list-style-type: none"> • Oven thermostat needs adjustment. See the <i>Adjust the Oven Thermostat Do it yourself!</i> section.
OVEN WILL NOT WORK	<ul style="list-style-type: none"> • A fuse in your home may be blown or the circuit breaker tripped. Replace the fuse or reset the circuit breaker. • Oven controls improperly set.
FOOD DOES NOT BAKE OR ROAST PROPERLY	<ul style="list-style-type: none"> • Oven controls improperly set. See the <i>Baking or Roasting</i> section. • Rack position is incorrect or the rack is not level. • Incorrect cookware or cookware of improper size being used. • Oven thermostat needs adjustment. See the <i>Adjust the Oven Thermostat Do it yourself!</i> section.
FOOD DOES NOT BROIL PROPERLY	<ul style="list-style-type: none"> • Oven controls improperly set. Make sure you press the BROIL HIGH/LOW pad. • Improper rack position being used. See the <i>Broiling guide</i>. • Food being cooked in a hot pan. Use the broiling pan and grid that came with your oven. Make sure that it is cool. • Cookware not suited for broiling. Use the broiling pan and grid that came with your oven. • The probe is plugged into the outlet in the oven. Remove the probe from the oven. • Aluminum foil used on the broiling pan and grid has not been fitted properly and slit as recommended. • In some areas the power (voltage) may be low. Preheat the broil element for 10 minutes. Broil for the longest period of time recommended in the <i>Broiling guide</i>.
OVEN WILL NOT SELF CLEAN	<ul style="list-style-type: none"> • The oven temperature is too high to set a self-clean operation. Allow the oven to cool and reset the controls. • Oven controls improperly set. See the <i>Using the Self-Cleaning Oven</i> section. • The probe is plugged into the outlet in the oven. Remove the probe from the oven.
“CRACKING” OR “POPPING” SOUND	<ul style="list-style-type: none"> • This is normal. It is the sound of the metal heating and cooling during both cooking and cleaning functions.
EXCESSIVE SMOKING DURING CLEAN CYCLE	<ul style="list-style-type: none"> • Excessive soil. Press the CLEAR/OFF pad. Open the windows to rid the room of smoke. Wait until the LOCKED light goes off. Wipe up the excess soil and reset the clean cycle.

Troubleshooting tips

PROBLEM	POSSIBLE CAUSE
OVEN DOOR WILL NOT OPEN AFTER A CLEAN CYCLE	<ul style="list-style-type: none"> The oven is too hot. Allow the oven to cool below locking temperature.
OVEN NOT CLEAN AFTER A CLEAN	<ul style="list-style-type: none"> Oven controls improperly set. See the <i>Using the Self-Cleaning Oven</i> section. Oven was heavily soiled. Clean up heavy spillovers before starting the clean cycle. Heavily soiled ovens may need to self-clean again or for a longer period of time.
“LOCK” FLASHES IN THE DISPLAY	<ul style="list-style-type: none"> The self-clean cycle has been selected but the door is not closed. Close the oven door.
LOCKED LIGHT IS ON WHEN YOU WANT TO COOK	<ul style="list-style-type: none"> The oven door is locked because the temperature inside the oven has not dropped below the locking temperature. Press the CLEAR/OFF pad. Allow the oven to cool.
CONTROL SIGNALS AFTER ENTERING COOKING TIME OR DELAY START	<ul style="list-style-type: none"> You forgot to enter a bake temperature or cleaning time. Press the BAKE pad and desired temperature or the SELF CLEAN STD/LOW pad and desired clean time.
“F— AND A NUMBER OR LETTER” FLASH IN THE DISPLAY	<ul style="list-style-type: none"> You have a function error code. Press the CLEAR/OFF pad. Allow the oven to cool for one hour. Put the oven back into operation. Disconnect all power to the oven for 30 seconds and then reconnect power. If the function error code repeats, call for service.
DISPLAY GOES BLANK	<ul style="list-style-type: none"> A fuse in your home may be blown or the circuit breaker tripped. Replace the fuse or reset the circuit breaker. The clock is in the black-out mode. See the <i>Oven Control, Clock and Timer</i> section.
DISPLAY FLASHES	<ul style="list-style-type: none"> Power failure. Reset the clock.
UNABLE TO GET THE DISPLAY TO SHOW “SF”	<ul style="list-style-type: none"> Oven control pads were not pressed properly. The BAKE and the BROIL HIGH/LOW pads must be pressed at the same time and held for 3 seconds.
“PROBE” APPEARS IN THE DISPLAY	<ul style="list-style-type: none"> This is reminding you to enter a probe temperature after plugging in the probe. Enter a probe temperature.
POWER OUTAGE, CLOCK FLASHES	<ul style="list-style-type: none"> Power outage or surge. Reset the the clock. If the oven was in use, you must reset it by pressing the CLEAR/OFF pad, setting the clock and resetting any cooking function.
STEAM FROM THE VENT	<ul style="list-style-type: none"> When using the convection feature, it is normal to see steam coming out of the oven vent. As the number of racks or amount of food being cooked increases, the amount of visible steam will increase.
“BURNING” OR “OILY” ODOR EMITTING FROM THE VENT	<ul style="list-style-type: none"> This is normal in a new oven and will disappear in time. To speed the process, set a self-clean cycle for a minimum of 3 hours. See the <i>Using the Self-Cleaning Oven</i> section.
STRONG ODOR	<ul style="list-style-type: none"> This is temporary. An odor from the insulation around the inside of the oven is normal for the first few times the oven is used.
FAN NOISE	<ul style="list-style-type: none"> A cooling fan or a convection fan (depending on the function you are using) may automatically turn on. This is normal. The cooling fan will turn on to cool internal parts. It may run for up to 1-1/2 hours in 30” models and up to 2 hours in 27” models after the oven is turned off. The convection fan will cycle on and off until the function is over or the door is opened.

GE Service Protection Plus™

GE, a name recognized worldwide for quality and dependability, offers you Service Protection Plus™—comprehensive protection on all your appliances—**No Matter What Brand!**

Benefits Include:

- Backed by GE
- All brands covered
- Unlimited service calls
- All parts and labor costs included
- No out-of-pocket expenses
- No hidden deductibles
- One 800 number to call

***We'll Cover Any Appliance.
Anywhere. Anytime.****

You will be completely satisfied with our service protection or you may request your money back on the remaining value of your contract. No questions asked. It's that simple.

Protect your refrigerator, dishwasher, washer and dryer, range, TV, VCR and much more—**any brand!** Plus there's no extra charge for emergency service and low monthly financing is available. Even icemaker coverage and food spoilage protection is offered. You can rest easy, knowing that all your valuable household products are protected against expensive repairs.

Place your confidence in GE and call us in the U.S. toll-free at **800.626.2224** for more information.

*All brands covered, up to 20 years old, in the continental U.S.

 Cut here

Please place in envelope and mail to:

General Electric Company
Warranty Registration Department
P.O. Box 32150
Louisville, KY 40232-2150

Consumer Product Ownership Registration

Dear Customer:

Thank you for purchasing our product and thank you for placing your confidence in us.

We are proud to have you as a customer!

Follow these three steps to protect your new appliance investment:

1

Complete and mail your Consumer Product Ownership Registration today. Have the peace of mind of knowing we can contact you in the unlikely event of a safety modification.

2

After mailing the registration below, store this document in a safe place. It contains information you will need should you require service. Our service number is 800 GE CARES (800.432.2737).

3

Read your Owner's Manual carefully. It will help you operate your new appliance properly.

Model Number

Serial Number

Important: If you did not get a registration card with your product, detach and return the form below to ensure that your product is registered, or register online at ge.com.

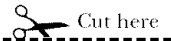

Consumer Product Ownership Registration



Model Number

Serial Number

Mr. Ms. Mrs. Miss

First Name

Last Name

Street Address

Apt. #

E-mail Address*

City

State

Zip Code

Date Placed In Use
Month

Day

Year

Phone Number --



GE Consumer & Industrial
Appliances
General Electric Company
Louisville, KY 40225
ge.com

* Please provide your e-mail address to receive, via e-mail, discounts, special offers and other important communications from GE Appliances (GEA).

Check here if you do not want to receive communications from GEA's carefully selected partners.

FAILURE TO COMPLETE AND RETURN THIS CARD DOES NOT DIMINISH YOUR WARRANTY RIGHTS.

For more information about GEA's privacy and data usage policy, go to ge.com and click on "Privacy Policy" or call 800.626.2924

With the purchase of your new Monogram appliance, receive the assurance that if you ever need information or assistance from GE, we'll be there. All you have to do is call—toll-free!

GE Answer Center®

800.626.2000

Whatever your question about any Monogram major appliance, GE Answer Center® information service is available to help. Your call—and your question—will be answered promptly and courteously. And you can call any time. GE Answer Center® service is open 24 hours a day, 7 days a week.

OR

Visit our Website at: ge.com

In-Home Repair Service

In the U.S.A.:
800.444.1845

In Canada:
888.880.3030

A GE consumer service professional will provide expert repair service, scheduled at a time that's convenient for you. Many GE Consumer Service company-operated locations offer you service today or tomorrow, or at your convenience (7:00 a.m. to 7:00 p.m. weekdays, 9:00 a.m. to 2:00 p.m. Saturdays). Our factory-trained technicians know your appliance inside and out—so most repairs can be handled in just one visit.

For Customers With Special Needs...

800.626.2000

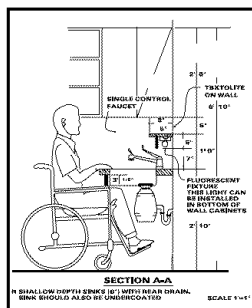

GE offers, free of charge, a brochure to assist in planning a barrier-free kitchen for persons with limited mobility.

Consumers with impaired hearing or speech who have access to a TDD or a conventional teletypewriter may call 800.TDD.GEAC (800.833.4322) to request information or service.

Service Contracts

800.626.2224

You can have the secure feeling that GE Consumer Service will still be there after your warranty expires. Purchase a GE contract while your warranty is still in effect and you'll receive a substantial discount. With a multiple-year contract, you're assured of future service at today's prices.

Parts and Accessories

800.626.2002

Individuals qualified to service their own appliances can have parts or accessories sent directly to their home. The GE parts system provides access to over 47,000 parts...and all GE Genuine Renewal Parts are fully warranted. VISA, MasterCard and Discover cards are accepted.

User maintenance instructions contained in this manual cover procedures intended to be performed by any user. Other servicing generally should be referred to qualified service personnel. Caution must be exercised, since improper servicing may cause unsafe operation.

YOUR MONOGRAM WALL OVEN WARRANTY

Staple sales slip or cancelled check here. Proof of original purchase date is needed to obtain service under warranty.

WHAT IS COVERED

From the Date of the Original Purchase

LIMITED ONE-YEAR WARRANTY

For one year from date of original purchase, we will provide, free of charge, parts and service labor in your home to repair or replace **any part of the oven** that fails because of a manufacturing defect.

.....
This warranty is extended to the original purchaser and any succeeding owner for products purchased for ordinary home use in the 48 mainland states, Hawaii, Washington, D.C. or Canada. If the product is located in an area where service by a GE Authorized Servicer is not available, you may be responsible for a trip charge or you may be required to bring the product to an Authorized GE Service location for service. In Alaska the warranty is the same except that it is LIMITED because you must pay to ship the product to the service shop or for the service technician's travel costs to your home.

All warranty service will be provided by our Factory Service Centers or by our authorized Customer Care® servicers during normal working hours.

Should your appliance need service, during warranty period or beyond, in the USA call 800.444.1845. In Canada: 888.880.3030. Please have your serial number and model number available when calling for service.

WHAT IS NOT COVERED

- Service trips to your home to teach you how to use the product.
- Replacement of house fuses or resetting of circuit breakers.
- Damage to the product caused by accident, fire, floods or acts of God.
- Failure of the product if it is used for other than its intended purpose or used commercially.
- Improper installation, delivery or maintenance.
- Incidental or consequential damage caused by possible defects with this appliance.
- Damage caused after delivery.
- Product not accessible to provide required service.

EXCLUSION OF IMPLIED WARRANTIES—Your sole and exclusive remedy is product repair as provided in this Limited Warranty. Any implied warranties, including the implied warranties of merchantability or fitness for a particular purpose, are limited to one year or the shortest period allowed by law.

Some states/provinces do not allow the exclusion or limitation of incidental or consequential damages, so the above limitation or exclusion may not apply to you. This warranty gives you specific legal rights, and you may also have other rights which vary from state to state/province to province. To know what your legal rights are in your state/province, consult your local or state/provincial consumer affairs office or your state's Attorney General.

**Warrantor in USA: General Electric Company,
Louisville, KY 40225**

Warrantor in Canada: Camco Inc.

164D4290P093-2
49-80336

11-05 JR

Printed in the United States



GE Consumer & Industrial Appliances
General Electric Company
Louisville, KY 40225
ge.com

Free Manuals Download Website

<http://myh66.com>

<http://usermanuals.us>

<http://www.somanuals.com>

<http://www.4manuals.cc>

<http://www.manual-lib.com>

<http://www.404manual.com>

<http://www.luxmanual.com>

<http://aubethermostatmanual.com>

Golf course search by state

<http://golfingnear.com>

Email search by domain

<http://emailbydomain.com>

Auto manuals search

<http://auto.somanuals.com>

TV manuals search

<http://tv.somanuals.com>