

## Gas Cooktop

### Contents

Appliance Registration	2
Automatic Ignition	4
Care and Cleaning	6
Cleaning Guide	7
Controls	4, 5
Cookware	5
Model and Serial Numbers	2
Problem Solver	7
Repair Service	7
Safety Instructions	2, 3
Using Your Cooktop	4, 5
Warranty	Back Cover
<b>GE Answer Center®</b> <b>800.626.2000</b>	

Models JGP600EH  
JGP600AEH

**GE Quality Product**

49-4994

## Help us help you...

### Read this book carefully.

It is intended to help you operate and maintain your new cooktop properly.

Keep it handy for answers to your questions.

If you don't understand something or need more help, write (include your phone number):

Consumer Affairs  
GE Appliances  
Appliance Park  
Louisville, KY 40225

### Write down the model and serial numbers.

You'll find them on a label located in the burner box under the cooktop.

These numbers are also on the Consumer Product Ownership Registration Card that came with your cooktop. Before sending in this card, please write these numbers here:

Model Number \_\_\_\_\_

Serial Number \_\_\_\_\_

Use these numbers in any correspondence or service calls concerning your cooktop.

### If you received a damaged cooktop...

Immediately contact the dealer (or builder) that sold you the cooktop.

### Save time and money. Before you request service...

Check the Problem Solver on page 7. It lists causes of minor operating problems that you can correct yourself.

### FOR YOUR SAFETY

If you smell gas:

1. Open windows.
2. Don't touch electrical switches.\*
3. Extinguish any open flame.
4. Immediately call your gas supplier.

\*Don't turn electric switches on or off because sparks may ignite the gas.

### FOR YOUR SAFETY

Do not store or use gasoline or other flammable vapors and liquids in the vicinity of this or any other appliance.

## IMPORTANT SAFETY INSTRUCTIONS

Read all instructions before using this appliance.

### IMPORTANT SAFETY NOTICE

The California Safe Drinking Water and Toxic Enforcement Act requires the Governor of California to publish a list of substances known to the state to cause cancer and requires businesses to warn customers of potential exposure to such substances.

Gas appliances can cause minor exposure to three of these substances, namely benzene, formaldehyde and soot, caused primarily by the incomplete combustion of natural gas or LP fuels. Properly adjusted burners, indicated by a bluish rather than a yellow flame, will minimize incomplete combustion. Exposure to these substances can be minimized further by venting with an open window or using a ventilation fan or hood.

When you get your cooktop, have the installer show you the location of the gas cut-off valve and how to shut it off if necessary.

- Have your cooktop installed and properly grounded by a qualified installer, in accordance with the Installation Instructions. Any adjustment and service should be performed only by qualified gas range installers or service technicians.

- **Plug your cooktop into a 120-volt grounded outlet only.** Do not remove the round grounding prong from the plug. If in doubt about the grounding of the home electrical system, it is your personal responsibility and obligation to have an ungrounded outlet replaced with a properly-grounded three-prong outlet in accordance with the National Electrical Code. Do not use an extension cord with this appliance.
- **Be sure all packing materials are removed from the cooktop** before operating it, to prevent fire or smoke damage should the packing material ignite.
- **Be sure your cooktop is correctly adjusted by a qualified service technician or installer for the type of gas (Natural or LP) on which it is to be used.** Cooktop can be converted for either type of gas. See Installation Instructions.

### Using Your Cooktop

- **Don't leave children alone or unattended where a cooktop is hot or in operation.** They could be seriously burned.
- **CAUTION: ITEMS OF INTEREST TO CHILDREN SHOULD NOT BE STORED IN CABINETS ABOVE THE COOKTOP—CHILDREN CLIMBING ON THE COOKTOP TO REACH ITEMS COULD BE SERIOUSLY INJURED.**
- **Let burner grates and other surfaces cool before touching them or leaving them where children can reach them.**
- **Never wear loose fitting or hanging garments while using the appliance.** Flammable material could be ignited if brought in contact with flame or hot surfaces and may cause severe burns.
- **Never use your appliance for warming or heating the room.** Prolonged use of the cooktop without adequate ventilation can be hazardous.
- **Do not use water on grease fires. Never pick up a flaming pan.** Turn off burner, then smother flaming pan by covering pan completely with well fitting lid, cookie sheet or flat tray. Flaming grease outside a pan can be put out by covering with baking soda or, if available, a multi-purpose dry chemical or foam-type extinguisher.
- **Do not store flammable materials near the cooktop.**
- **Do not let cooking grease or other flammable materials accumulate in or near the cooktop.**
- **Always use the LITE position when igniting top burners and make sure the burners have ignited.**
- **Never leave surface burners unattended at HIGH flame settings.** Boilover causes smoking and greasy spillovers that may catch on fire.
- **Adjust top burner flame size so it does not extend beyond the edge of the cooking utensil.** Excessive flame is hazardous.
- **Use only dry pot holders—**moist or damp pot holders on hot surfaces may result in burns from steam. Do not let pot holders come near open flames when lifting utensils. Do not use a towel or other bulky cloth in place of a pot holder.
- **To minimize burns, ignition of flammable materials, and spillage,** turn the handle of a container toward the side or back of the cooktop without extending over adjacent burner.
- **Always turn surface burner to OFF before removing utensil.**
- **Watch foods being fried at HIGH flame setting.**
- **When cooking pork,** follow the directions exactly and always cook the meat to at least 170°F. This assures that, in the remote possibility that trichina may be present in the meat, it will be killed and meat will be safe to eat.
- **Do not use a wok on the cooking surface if the wok has a round metal ring which is placed over the burner grate to support the wok.** This ring acts as a heat trap which may damage the burner grate and burner head. Also, it may cause the burner to work improperly. This may cause a carbon monoxide level above current standards, resulting in a health hazard.
- **Clean only parts listed in this Use and Care Book.**

### If You Need Service

- **Read "The Problem Solver" on page 7 of this book.**
- **Don't attempt to repair or replace any part of your cooktop unless it is specifically recommended in this book.** All other servicing should be referred to a qualified technician.

## SAVE THESE INSTRUCTIONS

# Using Your Cooktop

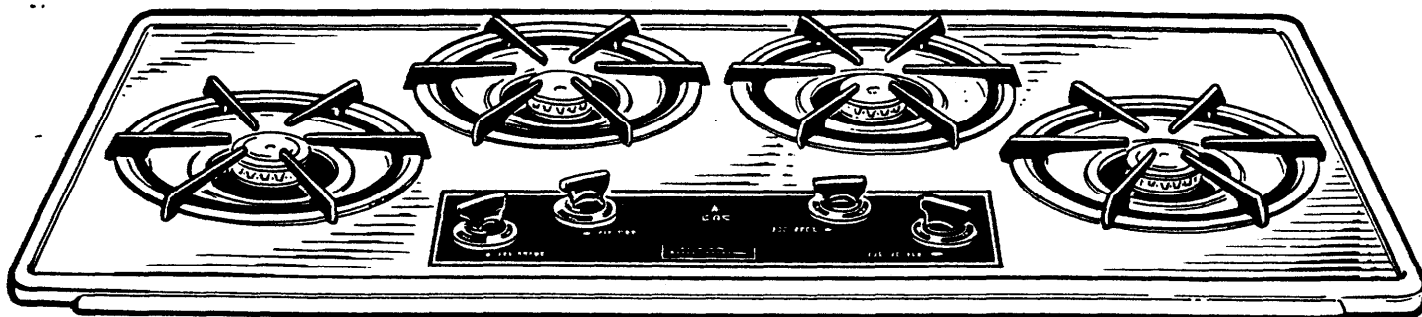

Model JGP600EH with Brushed Chrome Finish  
Model JGP600AEH (not shown) with Porcelain Enamel Finish

## Automatic Pilotless Ignition

Your surface burners are lighted by electric ignition, eliminating the need for pilot lights.

**In case of a power outage**, you can light the surface burners on your range with a match. Hold a lighted match to the burner, then turn the knob to the LITE position. Use extreme caution when lighting burners this way.

## To Light a Burner

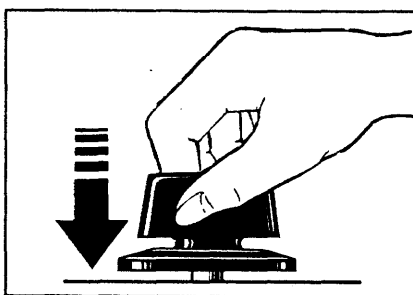

Push the control knob in and turn it to LITE. You will hear a little clicking noise—the sound of the burner lighting.

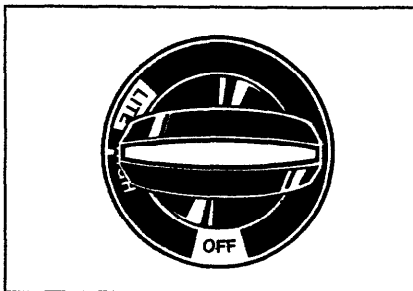

After the burner ignites, turn the knob to adjust the flame size.

- Always have a cooking utensil on the grate before turning on a burner. The finish on the grate may chip without a utensil to absorb the heat.
- Check to be sure the burner you turned on is the one you want to use.
- Be sure the burners and grates are cool before you place your hand, a potholder, cleaning cloths or other materials on them.

## How to Select Flame Size

The flame size on a gas burner should match the cookware you are using.

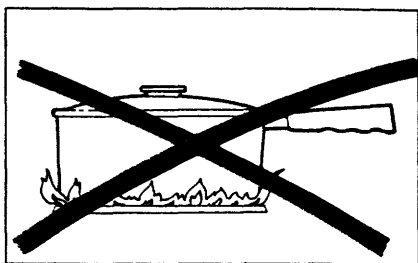

**NEVER LET THE FLAME EXTEND UP THE SIDES OF THE COOKWARE.** Any flame larger than the bottom of the cookware is wasted heat and only serves to heat the handles.

**When using aluminum or aluminum-clad stainless steel pots and pans,** adjust the flame so the circle it makes is about 1/2 inch smaller than the bottom of the cookware.

**When boiling,** use this same flame size—1/2 inch smaller than the bottom of the cookware—no matter what the cookware is made of. Foods cook just as quickly at a gentle boil as they do at a furious rolling boil. A high boil only creates steam and cooks away moisture, flavor and nutrition. Avoid it except for the few cooking processes which need a vigorous boil.

**When frying or warming foods in stainless steel, cast iron or enamelware,** keep the flame down lower—to about 1/2 the diameter of the pan.

**When frying in glass or ceramic cookware,** lower the flame even more.

## Air Adjustment

An air adjustment shutter for each surface burner regulates the flow of air to the flame.

**When the right amount of air flows into the burner,** the flame will be steady, relatively quiet and have approximately 3/4 inch sharp blue cones. This usually results when the shutter is about halfway open.

**With too much air,** the flame will be unsteady, possibly won't burn all the way around, and will be noisy, sounding like a blowtorch.

**With not enough air,** you won't see any sharp blue cones in the flame, you may see yellow tips, and soot may accumulate on cookware.

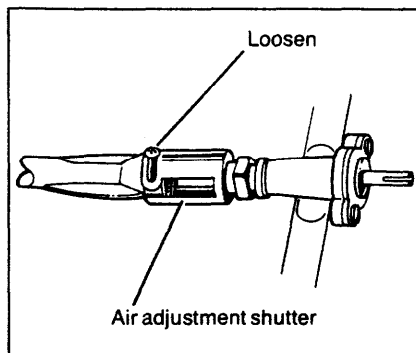

**To adjust the flow of air to the burners,** loosen the Phillips head screws and rotate the shutters to allow more or less air into the burner tubes as needed.

## Cookware

**Aluminum:** Medium-weight cookware is recommended because it heats quickly and evenly. Most foods brown evenly in an aluminum skillet. Minerals in food and water will stain but will not harm aluminum. A quick scour with a soap-filled wool pad after each use keeps aluminum cookware looking shiny new. Use saucepans with tight-fitting lids for cooking with minimum amounts of water.

**Cast Iron:** If heated slowly, most skillets will give satisfactory results.

**Enamelware:** Under some conditions, the enamel of some cookware may melt. Follow cookware manufacturer's recommendations for cooking methods.

**Glass:** There are two types of glass utensils—those for oven use only and those for top-of-range cooking (saucepans, coffee and teapots). Glass conducts heat very slowly.

**Heatproof Glass Ceramic:** Can be used for either surface or oven cooking. It conducts heat very slowly and cools very slowly. Check cookware manufacturer's directions to be sure it can be used on gas ranges.

**Stainless Steel:** This metal alone has poor heating properties, and is usually combined with copper, aluminum or other metals for improved heat distribution. Combination metal skillets generally work satisfactorily if used at medium heat as the manufacturer recommends.

# Care and Cleaning

Proper care and cleaning are important so your cooktop will give you efficient and satisfactory service. Follow these directions carefully in caring for it to help assure safe and proper maintenance.

## **BE SURE ELECTRIC POWER IS OFF BEFORE CLEANING ANY PART OF YOUR COOKTOP.**

When the cooktop is cool, wash the outer finish with warm, soapy water, rinse the surface with clean water, and dry it with a soft cloth. You can use any liquid household detergent.

## **Brushed Chrome Finish**

(Model JGP600EH)

To remove stubborn soil, use a paste of baking soda and water. Never use steel wool, scouring powder, oven cleaners or other abrasive cleaners. To restore luster, spread a thin film of baby oil on the surface, let it stand for about five minutes, and wipe away any excess oil with a damp cloth.

## **Outer Enamel Finish**

(Model JGP600AEH)

Occasionally apply a thin coat of mild cleaning wax, if you wish, to help protect the enamel finish. If you spill foods with a lot of acid (tomatoes, sauerkraut, fruit juices, etc.) or foods with high sugar content, clean them up as soon as possible. If allowed to set, these foods could cause a dull spot.

## **Control Panel**

It's a good idea to wipe the control panel clean after each use of the cooktop. For a more thorough cleaning, the knobs can be removed by pulling them off the knob stems. Clean with mild soap and water, rinse with clean water and polish dry with a soft cloth.

Do not use abrasive cleansers, strong liquid cleaners or oven cleaners on the control panel—they will damage the finish.

## **Burner Grates**

Grates should be washed regularly and, of course, after spillovers. Wash them in hot, soapy water and rinse with clean water. To get rid of burned-on food, soak the grates in a slightly diluted liquid cleanser. Dry the grates with a cloth—don't put them back on the cooktop wet. When replacing the grates, be sure they're locked into position over the burners.

Although they're durable, the grates will gradually lose their shine, regardless of the care you take of them. This is due to their exposure to high temperatures.

To preserve the grates' porcelain finish as long as possible, have a pan on the grate before you turn on the burner, and lower the flame when food reaches the desired temperature.

## **Drip Pans**

Remove the grates and lift out the chrome drip pans. Wash them in hot, soapy water. Rinse them with clean hot water and polish them dry with a cloth. Never use abrasive cleaner or steel wool—they'll scratch the surface. Instead, soak the drip pans for about 20 minutes in slightly diluted liquid cleanser or mild solution of ammonia and water (1/2 cup of ammonia to one gallon of water). After soaking, wash them in hot, soapy water. Rinse with clean water and polish with a cloth. Do not clean in self-cleaning oven.

## **Lift-up Top**

Clean the area under the cooktop often. Built-up soil, especially grease, may catch fire.

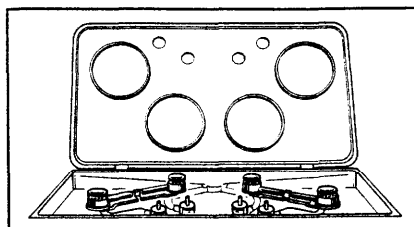

To make cleaning easier, the entire cooktop may be lifted up.

**Be sure all burners are turned off before raising the cooktop.** Then remove grates, drip pans and knobs, grasp front of cooktop and lift.

After cleaning under the top with hot, mild soapy water and a clean cloth, put the top back in place. Be careful not to pinch your fingers. Replace drip pans, grates and knobs.

## **Burners**

The holes in the burners of your cooktop must be kept clean at all times for proper ignition and an even, unhampered flame.

Clean the burners routinely and especially after bad spillovers which could clog these holes. Burners lift right out for cleaning.

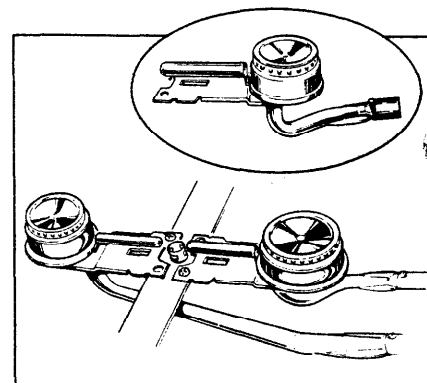

**Note:** A screw holds each of the burners in place to keep them from wobbling around during shipment. Tags indicate their location. Remove the screw, lift the burner, tilt it to one side at the end closest to the ignitor and move it toward the back of the range. This disengages it from the gas valves at the front of the range, and it lifts out easily.

To remove burned-on food, soak the burner in a solution of a product used for cleaning the inside of coffee makers. Soak the burner for 20 to 30 minutes. If the food doesn't rinse off completely, scrub it with soap and water or a mild abrasive cleanser and a damp cloth.

Before putting the burner back, dry it thoroughly by setting it in a warm oven for 30 minutes. Then place it back in the range, making sure it is properly seated and level.

# Cleaning Guide

Note: Let cooktop parts cool before cleaning.

PART	MATERIALS TO USE	GENERAL DIRECTIONS
Control Knobs	<ul style="list-style-type: none"> <li>Mild Soap and Water</li> </ul>	Pull off knobs. Wash gently but do not soak. Dry and return controls to cooktop, making sure to match flat area on the knob and shaft.
Brushed Chrome Finish	<ul style="list-style-type: none"> <li>Soap and Water</li> <li>Paste of Baking Soda and Water</li> </ul>	When cooktop is cool, wash with warm, soapy water. Polish dry with a soft cloth. To remove stubborn soil, use a paste of baking soda and water. NEVER USE STEEL WOOL, OVEN CLEANER, SCOURING POWDER OR OTHER ABRASIVE CLEANERS. To restore luster, spread a thin film of baby oil on the surface and let it stand five minutes. Remove excess oil with a clean cloth.
Porcelain Enamel Finish	<ul style="list-style-type: none"> <li>Paper Towel</li> <li>Dry Cloth</li> <li>Soap and Water</li> </ul>	Avoid cleaning powders or harsh abrasives which may scratch the enamel. If acids should spill on the cooktop while it is hot, use a dry paper towel or cloth to wipe up right away. When the surface has cooled, wash and rinse. For other spills, such as fat splatterings, etc., wash with soap and water when cooled and then rinse. Polish with dry cloth.
Grates	<ul style="list-style-type: none"> <li>Soap and Water</li> <li>Soap-Filled Scouring Pad (Non-metallic)</li> </ul>	Lift out when cool. Soak 5 to 10 minutes if desired in warm solution of dishwasher detergent. Scour with materials mentioned here to remove burned-on food particles. <b>DO NOT CLEAN IN SELF-CLEANING OVEN.</b>
Chrome-Plated Drip Pans	<ul style="list-style-type: none"> <li>Soap and Water</li> <li>Stiff Bristled Brush</li> <li>Soap-Filled Scouring Pad (Non-metallic)</li> </ul>	Wash after each cooking so unnoticed spatter will not burn on next time you cook. To remove burned-on spatters, use any or all cleaning materials mentioned. Rub <i>lightly</i> with scouring pad to prevent scratching of the surface. <b>DO NOT CLEAN IN SELF-CLEANING OVEN.</b>
Burners	<ul style="list-style-type: none"> <li>Solution for Cleaning Inside of Coffee Makers</li> <li>Soap and Water</li> <li>Mild Abrasive Cleanser</li> <li>Damp Cloth</li> </ul>	Wipe off burner heads. If heavy spillover occurs, remove burners from range (see page 6) and soak them for 20 to 30 minutes in solution of hot water and product for cleaning inside of coffee makers, such as Dip-It brand. If soil does not rinse off completely, scrub burners with soap and water or a mild abrasive cleanser and a damp cloth. Dry burners in a warm oven for 30 minutes before returning them to the range.



## Questions? Use This Problem Solver

PROBLEM	POSSIBLE CAUSE AND REMEDY
BURNERS DO NOT LIGHT	<ul style="list-style-type: none"> <li>Make sure electrical plug is plugged into a live power outlet.</li> <li>Burner holes on side of burner may be clogged. Remove and clean them.</li> <li>Burners may not be fitted correctly onto the gas valves. Remove and reinstall them properly.</li> </ul>

If you need more help... call, toll free:  
**The GE Answer Center®**  
**800.626.2000**  
 consumer information service

## If You Need Service

To obtain service, see your warranty on the back page of this book.

We're proud of our service and want you to be pleased. If for some reason you are not happy with the service you receive, here are three steps to follow for further help.

**FIRST**, contact the people who serviced your appliance. Explain why you are not pleased. In most cases, this will solve the problem.

**NEXT**, if you are still not pleased, write all the details—including your phone number—to:

Manager, Consumer Relations  
 General Electric  
 Appliance Park  
 Louisville, Kentucky 40225

**FINALLY**, if your problem is still not resolved, write:

Major Appliance  
 Consumer Action Panel  
 20 North Wacker Drive  
 Chicago, Illinois 60606

# YOUR BUILT-IN COOKTOP WARRANTY

Save proof of original purchase date such as your sales slip or cancelled check to establish warranty period.

## WHAT IS COVERED

### FULL ONE-YEAR WARRANTY

For one year from date of original purchase, we will provide, free of charge, parts and service labor in your home to repair or replace **any part of the cooktop** that fails because of a manufacturing defect.

This warranty is extended to the original purchaser and any succeeding owner for products purchased for ordinary home use in the 48 mainland states, Hawaii and Washington, D.C. In Alaska the warranty is the same except that it is LIMITED because you must pay to ship the product to the service shop or for the service technician's travel costs to your home.

All warranty service will be provided by our Factory Service Centers or by our authorized Customer Care® servicers during normal working hours.

Look in the White or Yellow Pages of your telephone directory for GENERAL ELECTRIC COMPANY, GENERAL ELECTRIC FACTORY SERVICE, GENERAL ELECTRIC-HOTPOINT FACTORY SERVICE or GENERAL ELECTRIC CUSTOMER CARE® SERVICE.

## WHAT IS NOT COVERED

- Service trips to your home to teach you how to use the product.

**Read your Use and Care material.** If you then have any questions about operating the product, please contact your dealer or our Consumer Affairs office at the address below, or call, toll free: GE Answer Center®  
800.626.2000  
consumer information service

- Improper installation.

If you have an installation problem, contact your dealer or installer. You are responsible for providing adequate electrical, gas, exhausting and other connecting facilities.

- Replacement of house fuses or resetting of circuit breakers.

- Failure of the product if it is used for other than its intended purpose or used commercially.

- Damage to product caused by accident, fire, floods or acts of God.

**WARRANTOR IS NOT RESPONSIBLE FOR CONSEQUENTIAL DAMAGES.**

Some states do not allow the exclusion or limitation of incidental or consequential damages, so the above limitation or exclusion may not apply to you. This warranty gives you specific legal rights, and you may also have other rights which vary from state to state. To know what your legal rights are in your state, consult your local or state consumer affairs office or your state's Attorney General.

**Warrantor: General Electric Company**

**If further help is needed concerning this warranty, write:  
Manager—Consumer Affairs, GE Appliances, Louisville, KY 40225**

Part No. 164D1352P226

Pub. No. 49-4994

P/N 560S118P14

JGP600EH  
JGP600AEH



## Free Manuals Download Website

<http://myh66.com>

<http://usermanuals.us>

<http://www.somanuals.com>

<http://www.4manuals.cc>

<http://www.manual-lib.com>

<http://www.404manual.com>

<http://www.luxmanual.com>

<http://aubethermostatmanual.com>

Golf course search by state

<http://golfingnear.com>

Email search by domain

<http://emailbydomain.com>

Auto manuals search

<http://auto.somanuals.com>

TV manuals search

<http://tv.somanuals.com>