





Use and Care Guide

Built-in Gas Cooktop

	Safety instructions3-5
-----------------------------------------------------------------------------------	------------------------------

	Operating Instructions, Tips
	Appliance Registration2
	Automatic Ignition7
	Controls10
	Cookware.....8,9
	Using Your Cooktop7-9

	Care and Cleaning.....10-11
------------------------------------------------------------------------------------	-----------------------------

	Problem Solver 12
	More questions?...call
	GE Answer Center™ 800.626.2000

	Consumer Services 15
	Model and Serial Numbers2
	WarrantyBack Cover

Models: *JGP630ER JGP631ER*



HELP US HELP YOU...

Read this book carefully.

It is intended to help you operate and maintain your new cooktop properly.

Keep it handy for answers to your questions.

If you don't understand something or need more help, write (include your phone number):

Consumer Affairs
GE Appliances
Appliance Park
Louisville, KY 40225

Write down the model and serial numbers.

You'll find them on a label located on the underside of the cooktop.

These numbers are also on the Consumer Product Ownership Registration Card that came with your cooktop. Before sending in this card, please write these numbers here:

Model Number

Serial Number

Use these numbers in any correspondence or service calls concerning your cooktop.

If you received a damaged cooktop...

Immediately contact the dealer (or builder) that sold you the cooktop.

Save time and money. Before you request service...

Check the Problem Solver in the back of this guide. It lists causes of minor operating problems that you can correct yourself.

IF YOU NEED SERVICE

To obtain service, see the Consumer Services page in the back of this guide.

We're proud of our service and want you to be pleased. If for some reason you are not happy with the service you receive, here are three steps to follow for further help.

FIRST, contact the people who serviced your appliance. Explain why you are not pleased. In most cases, this will solve the problem.

NEXT, if you are still not pleased, write all the details—including you phone number—to:

Manager, Consumer Relations
GE Appliances
Appliance Park
Louisville, KY 40225

FINALLY, if your problem is still not resolved, write:

Major Appliance Consumer Action Panel
20 North Wacker Drive
Chicago, IL 60606

WARNING: If the information in this manual is not followed exactly, a fire or explosion may result causing property damage, personal injury or death.

—Do not store or use gasoline or other flammable vapors and liquids in the vicinity of this or any other appliance.

—WHAT TO DO IF YOU SMELL GAS

- Do not try to light any appliance.
- Do not touch any electrical switch; do not use any phone in your building.

•Immediately call your gas supplier from a neighbor's phone. Follow the gas supplier's instructions.

•If you cannot reach your gas supplier, call the fire department.

—Installation and service must be performed by a qualified installer, service agency or the gas supplier.

IMPORTANT SAFETY INSTRUCTIONS

Read all instructions before using this appliance.



IMPORTANT SAFETY NOTICE

The California Safe Drinking Water and Toxic Enforcement Act requires the Governor of California to publish a list of substances known to the state to cause cancer, birth defects or other reproductive harm and requires businesses to warn customers of potential exposure to such substances.

Gas appliances can cause minor exposure to four of these substances, namely benzene, carbon monoxide, formaldehyde and soot, caused primarily by the incomplete combustion of natural gas or LP fuels. Properly adjusted burners, indicated by a bluish rather than a yellow flame, will minimize incomplete combustion. Exposure to these substances can be minimized further by venting with an open window or using a ventilation fan or hood.

When You Get Your Cooktop

When you get your cooktop, have the installer show you the location of the gas cut-off valve and how to shut it off if necessary.

Have your cooktop installed and properly grounded by a qualified installer, in accordance with the Installation Instructions. Any adjustment and service should be performed only by qualified gas range installers or service technicians.

- **Do not attempt to repair or replace any part of your cooktop unless it is specifically recommended in this guide.** All other servicing should be referred to a qualified technician.
- **Plug your cooktop into a 120-volt grounded outlet only.** Do not remove the round grounding prong from the plug. If in doubt about the grounding of the home electrical system, it is your personal responsibility and obligation to have an ungrounded outlet replaced with a properly grounded three-prong outlet in accordance with the National Electrical Code. Do not use an extension cord with this appliance.
- **Be sure all packing materials are removed from the cooktop** before operating it, to prevent fire or smoke damage should the packing material ignite.
- **Be sure your cooktop is correctly adjusted by a qualified service technician or installer.** This counter unit, as shipped from the factory, can only be operated with natural gas. Do not try to operate it with LP (bottled) gas unless you follow the Installation Instructions packed with your cooktop. See LP Gas Adjustments.

- **Don't attempt to repair or replace any part of your cooktop unless it is specifically recommended in this guide.** All other servicing should be referred to a qualified technician.

Using Your Cooktop

- **Don't leave children alone or unattended where a cooktop is hot or in operation.** They could be seriously burned.
- **CAUTION: ITEMS OF INTEREST TO CHILDREN SHOULD NOT BE STORED IN CABINETS ABOVE A COOKTOP—CHILDREN CLIMBING ON THE COOKTOP TO REACH ITEMS COULD BE SERIOUSLY INJURED.**
- **Do not operate or clean your cooktop if the glass is broken or cracked.** Cleaning solutions and spillovers could penetrate the broken cooktop and create a risk of electric shock. Call for service immediately if the cooktop glass breaks or cracks.
- **Do not operate the burner without all burner parts in place.**
- **Do not clean the cooktop with flammable or volatile cleaning fluids.**
- **Do not clean the cooktop when the appliance is in use.**
- **Avoid scratching the cooktop** with sharp implements, or with rings and other jewelry.
- **Never use the cooktop as a cutting board.**
- **Let burner grates and other surfaces cool before touching them or leaving them where children can reach them.**
- ***Never wear loose-fitting or hanging garments while using the appliance.** Be careful when reaching for items stored in cabinets over the cooktop. Flammable material could be ignited if brought in contact with flame or hot surfaces and may cause severe burns.
- **Never use your appliance for warming or heating the room.** Prolonged use of the cooktop in this way can be hazardous.
- Always keep combustible wall coverings, curtains or drapes a safe distance from your cooktop.

(continued next page)



IMPORTANT SAFETY INSTRUCTIONS

(continued)



- **Do not use water on grease fires.** Never pick up a flaming pan. Turn off burner, then smother flaming pan by covering pan completely with well-fitting lid, cookie sheet or flat tray, or if available, use a dry chemical or foam-type extinguisher.

Flaming grease outside a pan can be put out by covering with baking soda or if available a multi-purpose dry chemical or foam-type extinguisher.

- **When using glass cookware make sure it is designed for top-of-range cooking.**
- **Do not store flammable materials near the cooktop.** Do not store or use gasoline or other flammable vapors and liquids in the vicinity of this or any other appliance.



- **Do not let cooking grease or other flammable materials accumulate in or near the cooktop.**
- **Always use the LITE position when igniting top burners and make sure the burners have ignited.**
- **Never leave surface burners unattended at high flame settings.** Boilover causes smoking and greasy spillovers that may catch on fire.



- **Adjust surface burner flame size so it does not extend beyond the edge of the cookware.** Excessive flame is hazardous.
- **Use only dry pot holders—moist or damp pot holders on hot surfaces may result in burns from steam.** Do not let potholders come near open flames when lifting cookware. Do not use a towel or other bulky cloth in place of a pot holder.
- **To minimize the possibility of burns, ignition of flammable materials and spillage,** turn cookware handles toward the side or center of the cooktop without extending over adjacent burner.
- **Always turn surface burner to OFF before removing cookware.**
- **Teach children not to play with the controls or any other part of the ranges.**
- **Never leave the oven door open when you are not watching the range.**

- **Watch foods being fried at HI flame setting.**
- **Foods for frying should be as dry as possible.** Fresh, moist foods can bubble, fat top and over sides of pan.
- **USE least possible amount of fat for effective shallow or deep-fat frying.** Filling the pan too full of fat can cause spillovers when food is added.
- **If a combination of oils or fats will be used in frying,** stir together before heating, or as fats melt slowly.
- **Always heat fat slowly, and watch as it heats.**
- **Use a thermometer whenever possible to prevent overheating fat beyond the smoking point.**
- **Use proper pan size—**Avoid pans that are unstable or easily tipped. Select cookware having flat bottoms, properly large contain food and avoid boilovers and spillovers, and large enough to cover burner grate. This will both save cleaning time and prevent hazardous accumulations of soot, grease or spillovers left on cooktop can ignite. Use pans with handles that can be easily grasped and remain cool.
- **Do not place hot cookware on the glass cooktop.** This could cause glass to break.
- **When using glass cookware,** make sure it is designed for top-of range cooking.
- **Keep all plastics away from top burners.**
- **Never leave jars or cans of pickles on or near your cooktop.**
- **Always keep dish towels, dish cloths, pot holders and other linens a safe distance from your cooktop.**
- **Always keep wooden and plastic utensils and canned food a safe distance away from your cooktop.**



- **To avoid the possibility of a burn, always be certain that the controls for all burners are at OFF position and all grates are cool before attempting to remove a grate.**
- **If cooktop is located near a window, do not use long curtains which could blow over the top burners and create a fire hazard.**
- **If you smell gas, turn off the gas to the cooktop and call a qualified service technician. Never use an open flame to locate a leak.**
- **Don't use aluminum foil to line burner bowls.** Misuse could result in a fire hazard or damage to the cooktop,
- **Do not cover or block the area around the cooktop knobs. This area must be kept clear for proper ventilation and burner performance.**
- **When cooking pork, follow the directions exactly and always cook the meat to an internal temperature of at least 170°F. This assures that, in the remote possibility that trichina may be present in the meat, it will be killed and the meat will be safe to eat.**
- **Do not use a wok on the cooking surface if the wok has a round metal ring which is placed over the burner grate to support the wok.** This ring acts as a heat trap which may damage the burner grate and burner head. Also, it may cause the burner to work improperly. This may cause a carbon monoxide level above that allowed by current standards, resulting in a health hazard.
- **Clean only parts listed in this Use and Care Book.**

LP Conversion

Your cooktop is shipped from the factory set to operate only with Natural Gas.

If you wish to use your cooktop with Liquefied Petroleum Gas, you must follow the Installation Instructions packed with your cooktop. See LP Gas Adjustments,

WARNING: These adjustments must be made by a qualified service technician in accordance with the manufacturer's instructions and all codes and requirements of the authority having jurisdiction. Failure to follow these instructions could result in serious injury or property damage. The qualified agency performing the work assumes responsibility for the conversion.

SAVE THESE INSTRUCTIONS



FEATURES OF YOUR COOKTOP

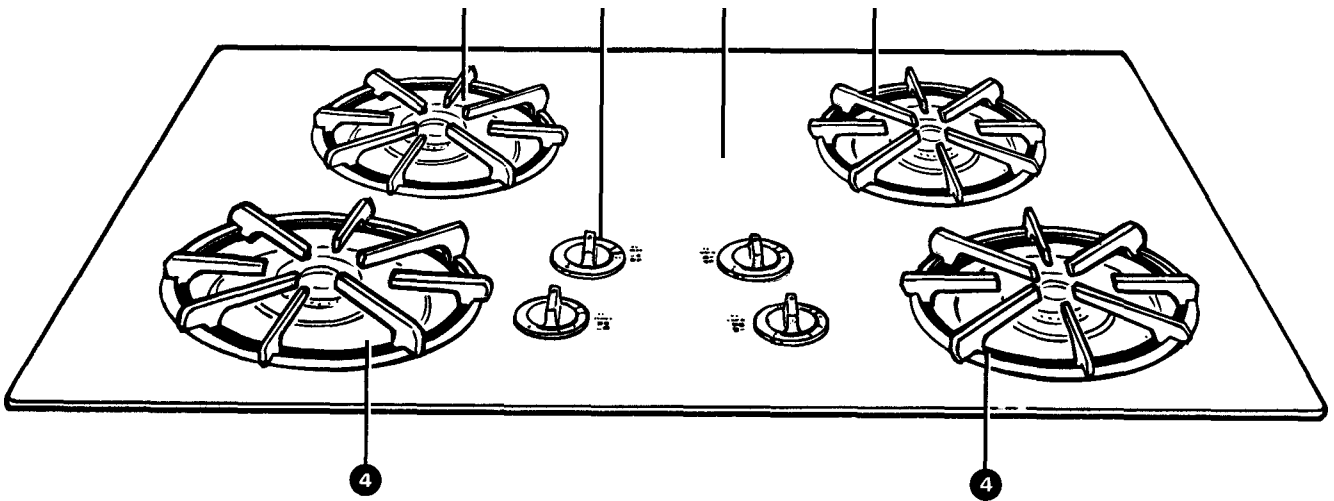

Models **JGP630ER**
JGP631ER

1. Spill-proof Burners
2. Surface Unit Controls
3. Glass Cooktop Surface
4. High Power Spill-proof Burners

USING YOUR COOKTOP



Automatic Ignition

Your surface burners are lighted by electric ignition, eliminating the need for standing pilot lights with constantly burning flames.

In case of a power outage, you can light the burners with a match. Hold a lighted match to the burner, then turn the knob to the LITE position. To avoid burning your hand, **use extreme caution when lighting burners this way.**

Surface burners in use when an electrical power failure occurs will continue to operate normally.

To Light a Burner

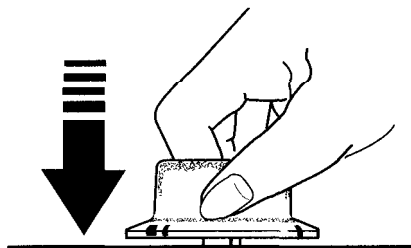

Push the control knob in and turn it counterclockwise to LITE.

After the burner ignites, turn the knob to adjust the flame size.

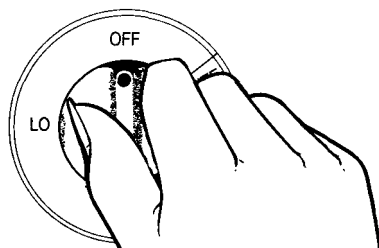

To turn a burner off, turn the knob clockwise, as far as it will go, to the OFF position.

- The left front and right rear burners are best for smaller pans and cooking operations requiring carefully controlled simmering conditions. The right front and rear left burners are the high power burners for larger pans and fast boiling operations.
-  Do not operate the burner for an extended period of time without cookware on the grate. The finish on the grate may chip without cookware to absorb the heat.
- Check to be sure the burner you turn on is the one you want to use.
- Be sure the burners and grates are cool before you place your hand, a pot holder, cleaning cloths or other materials on them.

(continued next page)

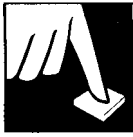

USING YOUR COOKTOP

(continued)

How to Select Flame Size

Watch the flame, not the knob, as you reduce heat. The flame size on a gas burner should match the cookware you are using.



FOR SAFE HANDLING OF COOKWARE, NEVER LET THE FLAME EXTEND UP THE SIDES OF THE COOKWARE. Any flame larger than the bottom of the cookware is wasted heat and only serves to heat the handle.

Cookware

Aluminum: Medium-weight cookware is recommended because it heats quickly and evenly. Most foods brown evenly in an aluminum skillet. Use saucepans with tight-fitting lids when cooking with minimum amounts of water.

Cast Iron: If heated slowly, most skillets will give satisfactory results.

Enamelware: Under some conditions, the enamel of some cookware may melt. Follow cookware manufacturer's recommendations for cooking methods.

Glass: There are two types of glass cookware-those for oven use only and those for surface cooking (saucepans, coffee and teapots). Glass conducts heat very slowly.

Heatproof Glass Ceramic: Can be used for either surface or oven cooking. It conducts heat very slowly and cools very slowly. Check cookware manufacturer's directions to be sure it can be used on gas cooktops.

Stainless Steel: This metal alone has poor heating properties, and is usually combined with copper, aluminum or other metals for improved heat distribution. Combination metal skillets generally work satisfactorily if used at medium heat as the manufacturer recommends.

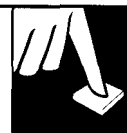

Wok Cooking

We recommend that you use only a flat-bottomed wok. They are available at your local retail store.



Do not use woks that have support rings. Use of these types of woks, with or without the ring in place, can be dangerous.

Placing the ring over the burner grate may cause the burner to work improperly resulting in carbon monoxide levels above allowable current standards. This could be dangerous to your health. Do not try to use such woks without the ring. You could be seriously injured if the wok tipped over.

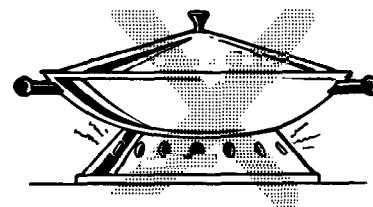

Stove Top Grills

Do not use stove top grills on your sealed gas burners. If you use the stove top grill on the sealed gas burner it will cause incomplete combustion and can result in exposure to carbon monoxide levels above allowable current standards. This can be hazardous to your health.

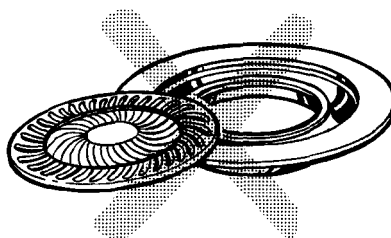

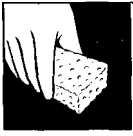

CARE AND CLEANING

Proper care and cleaning are important so your cooktop will give you efficient and satisfactory service. Follow these directions carefully in caring for it.

Before cleaning any part of your cooktop, be sure all burners are off and **DISCONNECT ELECTRIC POWER TO THE COOKTOP** at the fuse box or circuit breaker panel, or pull the cooktop power plug, located beneath the cooktop and inside the cabinets.

Cooktop Glass

To keep the cooktop looking its best, wipe up any spills as they occur. This will keep them from burning on and becoming more difficult to remove.

It's a good idea to wipe the control area clean after each use of the cooktop. For a more thorough cleaning, the knobs can be removed by pulling them off the knob stems.

As soon as the cooktop is cool, wash the glass surface with a cloth moistened with warm, soapy water; rinse with clean water, and dry with a soft cloth. You can use any liquid household detergent. Do not use abrasive materials such as metal pads, cleansing powder and soap-filled pads—they may scratch the surface. Do not use harsh chemicals such as bleach or chemical oven cleaners.

CAUTION: DO NOT COOK ON OR CLEAN A BROKEN OR CRACKED COOKTOP.

Cleaning solutions and spillovers penetrating the cooktop can create a risk of electric shock. Call for service technician immediately.

Control Knobs

The control knobs may be removed for cleaning.

To remove knob, pull it straight off the stem. If knob is difficult to remove, place a thin cloth (like a handkerchief) or a piece of string under and around the knob edge and pull up.

Wash knobs in soap and water but do not soak.

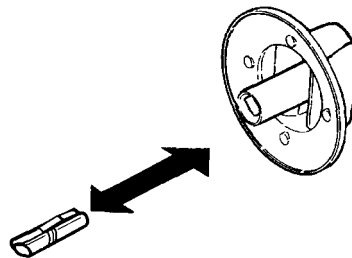

To replace knob, match the "D" shaft on the knob to the "D" shaft on the stem. Do not force the knob.

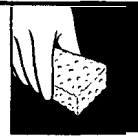

Burner Assembly

The burner assemblies should be washed regularly and, of course, after spills.

Turn all controls off before removing burner parts and drip pans.

CAUTION: DO NOT OPERATE THE BURNER WITHOUT ALL BURNER PARTS IN PLACE.

The electrode of the spark igniter is exposed beyond the top of the burner. When cleaning the burner bowl, be careful not to snag the electrode of the spark igniter with your cleaning cloth. Damage to the igniter could occur. Be careful not to push in any cooktop controls while cleaning the burner bowls. A slight electrical shock might result which could cause you to knock over hot cookware.

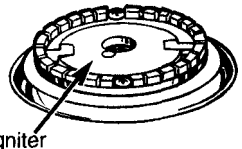

Spark Igniter

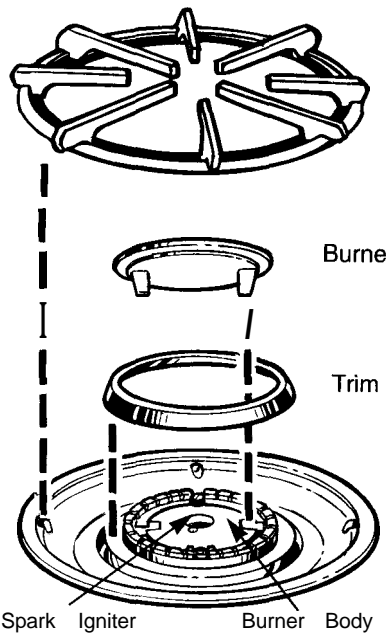

Burner Grate

Burner Top

Trim Ring

Burner Bowl

Spark Igniter

Burner Body

The burner grates, burner tops and trim rings can be lifted off, making them easy to clean. Removing them gives you access to the burner bodies and burner bowls. (To avoid snagging cloth on spark igniters, leave burner tops in place when cleaning burner bowls.) There are two locating pins that fit into indentations at the bottom of the bowls. The pins allow the grate to sit level in one direction only. Do not remove the pins. Do not remove burner bowls from glass top units.

Wash burner parts with all-purpose non-abrasive cleaner and warm water. Soak stubborn soil. Dry them with a cloth—don't reassemble them wet.

DO NOT clean in a self-cleaning oven or dishwasher.

To reassemble: Place the trim ring onto the burner body first. Before replacing the burner top, first examine the two tabs on its underside. The tabs are to fit into receiving slots in the burner body. When replacing burner grate, make sure the bottoms of the four larger burner grate fingers fit into the corresponding indentations in the burner bowl.

Care and Cleaning

Burner Grates

Porcelain enamel burner grates should be washed often. Wash them in hot, soapy water and rinse with clean water. Dry the grates with a cloth—don't put them back on the cooktop wet. When replacing the grates, be sure they're positioned securely over the burners.

To get rid of burned-on food, place the grates in a covered container or plastic bag. Add 1/4 cup ammonia and let them soak for 30 minutes.

Wash, rinse well, and dry.

Although they're durable, the grates will gradually lose their shine, regardless of the best care you can give them. This is due to their continual exposure to high temperatures.

Do not operate a burner for an extended period of time without cookware on the grate. The finish on the grate may chip without cookware to absorb the heat.

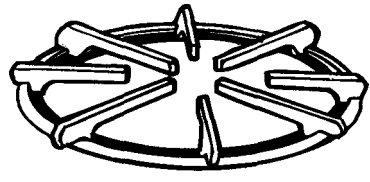

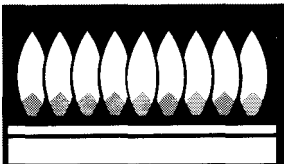
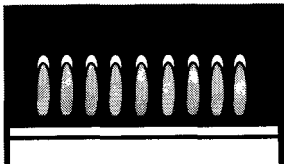
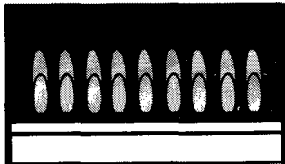

QUESTIONS? USE THIS PROBLEM SOLVER

PROBLEM	POSSIBLE CAUSE
CONTROL KNOB WILL NOT TURN	<ul style="list-style-type: none"> • When the knob is at the OFF position, it must be pushed in before it can be turned, and must be turned in a counterclockwise direction. When the knob is at any other position, it can be turned in either direction without being pushed in.
TICKING SOUND OF SPARK IGNITER PERSISTS AFTER BURNER LIGHTS	<ul style="list-style-type: none"> • Turn burner off and relight. If ticking is still present, call for service.
TICKING SOUND PERSISTS AFTER BURNER IS TURNED OFF	<ul style="list-style-type: none"> • Be sure knob is in the OFF position. Remove knob by pulling it straight off the stem and check bottom of knob for any build-up of soil.
BURNERS DO NOT LIGHT	<ul style="list-style-type: none"> • Make sure electrical plug is plugged into a live power outlet. • Gas supply not connected or not turned on. • Igniter opening in burner body may be clogged (see Burner Assembly in the Care and Cleaning section). Remove the obstruction. • Burner parts not replaced correctly (see Care and Cleaning section). • Counter unit not properly grounded or polarized. This can affect spark ignition. • Soil clogging holes in burner top. Remove and clean. • Cooktop burner top not replaced correctly. • Knob not reinstalled correctly. Push knob down on the stem.
BURNERS HAVE YELLOW OR YELLOW-TIPPED FLAMES	<div style="display: flex; justify-content: space-around; align-items: center;"> <div style="text-align: center;">  <p>(A) Yellow flames</p> </div> <div style="text-align: center;">  <p>(B) Yellow-tipped flames</p> </div> <div style="text-align: center;">  <p>(C) Normal soft blue flames</p> </div> </div> <ul style="list-style-type: none"> • If burner flames look like (A) or (B), call for service. Normal burner flames should look like (C), burning with a soft blue flame.

If you need more help...call, toll free:
GE Answer Center™
800.626.2000
consumer information service

NOTES

NOTES

We'll Be There

With the purchase of your new GE appliance, receive the assurance that if you ever need information or assistance from GE, we'll be there. All you have to do is call—toll-free!

In-Home Repair Service 800-GE-CARES (800-432-2737)

A GE consumer service professional will provide expert repair service, scheduled at a time that's convenient for you. Many GE Consumer Service company-operated locations offer you service today or tomorrow, or at your convenience (7:00 a.m. to 7:00 p.m. weekdays, 9:00 a.m. to 2:00 p.m. Saturdays). Our factory-trained technicians know your appliance inside and out—so most repairs can be handled in just one visit.

GE Answer Center® 80116262000

Whatever your question about any GE major appliance, GE Answer Center® information service is available to help. Your call—and your question—will be answered promptly and courteously. And you can call any time. GE Answer Center® service is open 24 hours a day, 7 days a week.

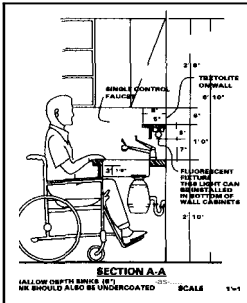

For Customers With Special Needs... 800.626.2000

Upon request, GE will provide Braille controls for a variety of GE appliances, and a brochure to assist in planning a barrier-free kitchen for persons with limited mobility. To obtain these items, free of charge, call 800.626.2000.

Consumers with impaired hearing or speech who have access to a TDD or a conventional teletypewriter may call 800-TDD-GEAC (800-833-4322) to request information or service.

Service Contracts 800-626-2224

You can have the secure feeling that GE Consumer Service will still be there after your warranty expires. Purchase a GE contract while your warranty is still in effect and you'll receive a substantial discount. With a multiple-year contract, you're assured of future service at today's prices.

Parts and Accessories 800-626-2002

Individuals qualified to service their own appliances can have needed parts or accessories sent directly to their home. The GE parts system provides access to over 47,000 parts... and all GE Genuine Renewal Parts are fully warranted. VISA, MasterCard and Discover cards are accepted.

User maintenance instructions contained in this booklet cover procedures intended to be performed by any user. Other servicing generally should be referred to qualified service personnel. Caution must be exercised, since improper servicing may cause unsafe operation.

YOUR BUILT-IN COOKTOP WARRANTY

Save proof of original purchase date such as your sales slip or cancelled check to establish warranty period.

WHAT IS COVERED

FULL ONE-YEAR WARRANTY

For one year from date of original purchase, we will provide, free of charge, parts and service labor in your home to repair or replace **any part of the cooktop** that fails because of a manufacturing defect.

This warranty is extended to the original purchaser and any succeeding owner for products purchased for ordinary home use in the **48** mainland states, Hawaii and Washington, D.C. In Alaska the warranty is the same except that it is **LIMITED** because you must pay to ship the product to the service shop or for the service technician's travel costs to your home.

All warranty service will be provided by our Factory Service Centers or by our authorized Customer Care[®] servicers during normal working hours.

Should your appliance need service during warrant period or beyond, call 800-GE-CARES (800-432-2737).

WHAT IS NOT COVERED

- Service trips to your home to teach you how to use the product.

Read your Use and Care material.

If you then have any questions about operating the product, please contact your dealer or our Consumer Affairs office at the address below, or call, toll free:

GE Answer Center[®]
800.626.2000
consumer information service

- . Improper installation.

If you have an installation problem, contact your dealer or installer. You are responsible for providing adequate electrical, gas, exhausting and other connecting facilities as

described in the Installation Instructions provided with the product.

- . Replacement of house fuses or resetting of circuit breakers.
- Failure of the product if it is used for other than its intended purpose or used commercially.
- Damage to product caused by accident, fire, floods or acts of God.

WARRANTOR IS NOT RESPONSIBLE FOR CONSEQUENTIAL DAMAGES.

Some states do not allow the exclusion or limitation of incidental or consequential damages, so the above limitation or exclusion may not apply to you. This warranty gives you specific legal rights, and you may also have other rights which vary from state to state. To know what your legal rights are in your state, consult your local or state consumer affairs office or your state's Attorney General.

Warrantor: General Electric Company

**If further help is needed concerning this warranty, write:
Manager—Consumer Affairs, GE Appliances, Louisville, KY 40225**

Part No. 164D2588P133

Pub. No. 49-8333

MNU116 Rev. 1

JGP630E1

JGP631 EF

Printed in LaFayette, GA

Free Manuals Download Website

<http://myh66.com>

<http://usermanuals.us>

<http://www.somanuals.com>

<http://www.4manuals.cc>

<http://www.manual-lib.com>

<http://www.404manual.com>

<http://www.luxmanual.com>

<http://aubethermostatmanual.com>

Golf course search by state

<http://golfingnear.com>

Email search by domain

<http://emailbydomain.com>

Auto manuals search

<http://auto.somanuals.com>

TV manuals search

<http://tv.somanuals.com>