

How to get the best from Your Grill Griddle Cooktop

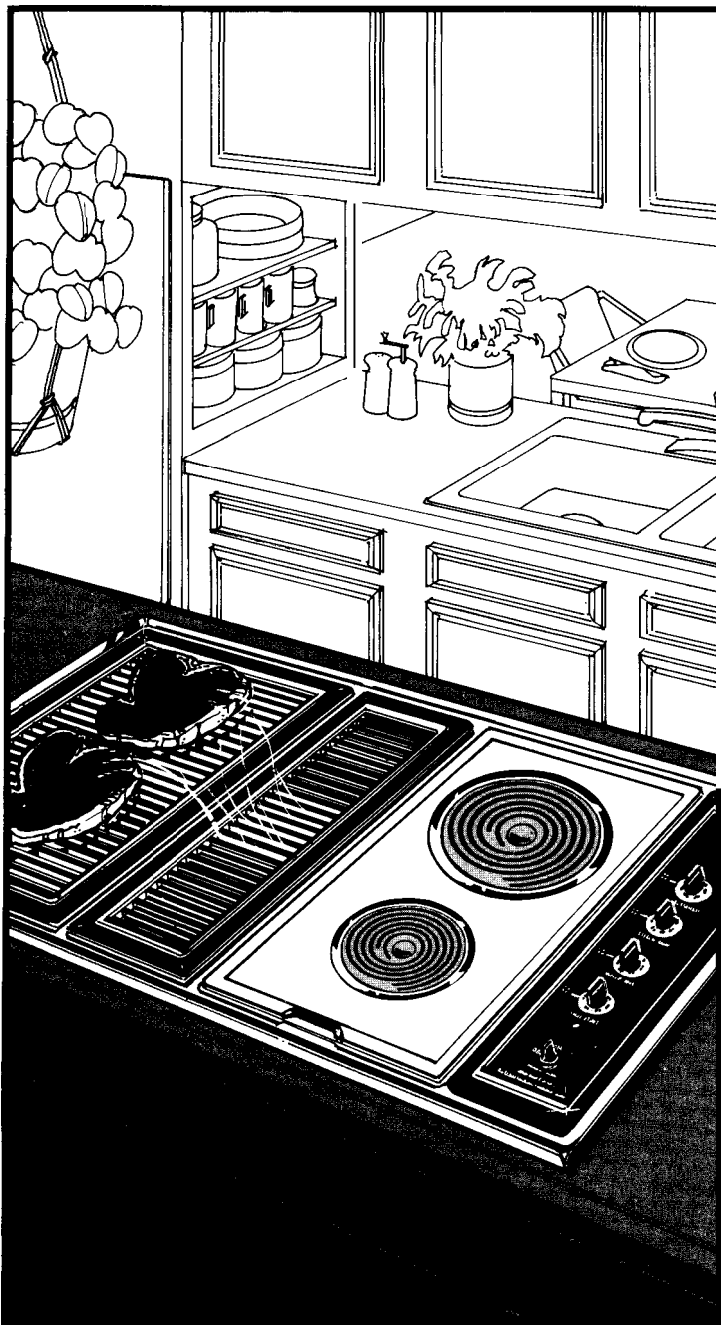

Use and Care of
model
JP676J

Energy-saving tips p4

Features p5

Surface Cooking p6

The Grill p10

The Griddle p13

Cooktop vent system p16

Questions?
Use the Problem Solver p18



Your Direct Line to General Electric
The GE Answer Center 800.626.2000

Contents

Before Using Your Cooktop	2
Safety Instructions	3,4
Energy-Saving Tips	4
Features	5
Surface Cooking	6
Home Canning.	7
Surface Cooking Guide	8,9
Grill	10
Grill Tips	11
Grill Cooking Guide.	12
Griddle	13
Griddle Tips	14
Griddle Cooking Guide	15
Cooktop Vent System	16
Accessory	16
Cleaning Guide.	17
The Problem Solver	18
If You Need Service	19
Warranty	Back Cover

Help us help you...

Before using your Cooktop, read this book carefully.

It is intended to help you operate and maintain your new cooktop properly.

Keep it handy for answers to your questions.

If you don't understand something or need more help, write (include your phone number):

Consumer Affairs
General Electric Company
Appliance Park
Louisville, KY 40225

Write down the model and serial numbers.

You'll find them on a nameplate on the back wall under the module on right side of the cooktop.

These model and serial numbers are also on the Consumer Product Ownership Registration Card that came with your cooktop. Before sending in this card, please write these numbers here:

Model Number

Serial Number

Use these numbers in any correspondence or service calls concerning your cooktop.

If you received a damaged cooktop . . .

Immediately contact the dealer (or builder) that sold you the cooktop.

Save time and money. Before you request service . . .

Check the Problem Solver on page 18. It lists causes of minor operating problems that you can correct yourself.

Optional Accessories

To add versatility to your cooktop, the following accessories are available at extra cost from your dealer.

JX36—Surface Unit Module

JXG3—Grill Module

JX56—Glass Ceramic Module

JXR5—Rotisserie Module

03-6022—Griddle

IMPORTANT SAFETY INSTRUCTIONS

Read all instructions before using this appliance.

When using electrical appliances, basic safety precautions should be followed, including the following:

- **Use this appliance only for its intended use** as described in this manual.

- **Be sure your appliance is properly installed and grounded** by a qualified technician in accordance with the provided installation instructions.

- **Don't assume that you know how to operate all parts of the cooktop.** Some features may work differently from those on your previous cooktop.

- **Don't attempt to repair or replace any part of your cooktop unless it is specifically recommended in this book.** All other servicing should be referred to a qualified technician.

- **Have the installer show you the location of the circuit breaker or fuse.** Mark it for easy reference.

- **Before performing any service, DISCONNECT THE COOKTOP POWER SUPPLY AT THE HOUSEHOLD DISTRIBUTION PANEL BY REMOVING THE FUSE OR SWITCHING OFF THE CIRCUIT BREAKER.**

- **Do not leave children alone**—children should not be left alone or unattended in an area where an appliance is in use. They should never be allowed to sit or stand on any part of the appliance.

- **Don't allow anyone to climb, stand or hang on the cooktop.**

- **CAUTION: ITEMS OF INTEREST TO CHILDREN SHOULD NOT BE STORED IN CABINETS ABOVE A COOKTOP—CHILDREN CLIMBING ON THE COOKTOP TO REACH ITEMS COULD BE SERIOUSLY INJURED.**

- **Never wear loose-fitting or hanging garments while using the appliance.** Flammable material could be ignited if brought in contact with hot heating elements and may cause severe burns.

- **Use only dry potholders**—moist or damp potholders on hot surfaces may result in burns from steam. Do not let potholders touch hot heating elements. Do not use a towel or other bulky cloth in place of a potholder.

- **Never use your appliance for warming or heating the room.**

- **Do not store flammable materials near the cooktop.**

- **Keep vent grill and grease filters clean** to maintain good venting and to avoid grease fires.

- **Do not let cooking grease or other flammable materials accumulate on the cooktop.**

- **Do not use water on grease fires. Never pick up a flaming pan. Smother flaming pan on surface unit by covering pan completely with well-fitting lid, cookie sheet or flat tray. Flaming grease outside a pan can be put out by covering with baking soda or, if available, a multi-purpose dry chemical or foam type extinguisher.**

- **Do not touch heating elements.** These surfaces may be hot enough to burn even though they are dark in color. During and after use, do not touch, or let clothing or other flammable materials contact surface units or areas nearby surface units; allow sufficient time for cooling, first. Potentially hot surfaces include the cooktop and areas facing the cooktop.

- **When cooking pork,** follow our directions exactly and always cook the meat to at least 170°F. This assures that, in the remote possibility that trichina may be present in the meat, it will be killed and the meat will be safe to eat.

- **Use proper pan size**—This appliance is equipped with two surface units of different size. Select utensils having flat bottoms large enough to cover the surface unit heating element. The use of undersized utensils will expose a portion of the heating element to direct contact and may result in ignition of clothing. Proper relationship of utensil to burner will also improve efficiency.

- **Never leave surface units unattended at high heat settings.** Boilover causes smoking and greasy spillovers that may catch on fire.

- **Be sure drip pans are not covered and are in place.** Their absence during cooking could damage range parts and wiring.

(continued next page)

IMPORTANT

(continued)

- **Don't use aluminum foil to line reflector pans, grill or griddle.** Misuse could result in a shock, fire hazard or damage to the cooktop.
- **Only certain types of glass, glass/ceramic, earthenware or other glazed containers are suitable for cooktop service;** others may break because of the sudden change in temperature.
- **To minimize the likelihood of burns,** ignition of flammable materials, and spillage, the cookware handles should be turned toward the center of the cooktop without extending over nearby surface units.
- **Keep grill pan, grill spatter shield and grease collector clean.** Be sure the drain hole in the grill pan is open. If it is clogged, a fire can occur.
- **Don't immerse or soak removable surface units or other modules. Don't put them in a dishwasher.**
- **Always turn heating unit to OFF before removing cookware.**
- **Keep an eye on foods being fried at HIGH or medium high heats.**
- **To avoid the possibility of a burn or electric shock, always be certain that the controls for all heating units are at OFF position and all units are cool before attempting to lift or remove them.**

INSTRUCTIONS

- **Foods for frying should be as dry as possible.** Frost on frozen foods or moisture on fresh foods can cause hot fat to bubble up and over sides of pan.
- **Use little fat for effective shallow or deep-fat frying.** Filling the pan too full of fat can cause spillovers when food is added.
- **If a combination of oils or fats will be used in frying,** stir together before heating, or as fats melt slowly.
- **Always heat fat slowly,** and watch as it heats.
- **Use deep fat thermometer whenever possible** to prevent overheating fat beyond the smoking point.

SAVE THESE INSTRUCTIONS

Energy-Saving Tips

- Use cookware of medium weight aluminum, with tight-fitting covers, and flat bottoms which completely cover the heated portion of the surface unit.
- Cook fresh vegetables with a minimum amount of water in a covered pan.
 - . Watch foods when bringing them quickly to cooking temperatures at HIGH heat. When food reaches cooking temperature, reduce heat immediately to lowest setting that will keep it cooking.
 - . Use residual heat whenever possible. For example, when cooking eggs in the shell, bring water to boil, then turn to OFF position to complete the cooking.
 - . Always turn surface unit OFF before removing cookware.
- Use correct heat for cooking task:
 - HIGH—to start cooking (if time allows, do not use HIGH heat to start).
 - 7-8—quick browning.
 - 5-6—slow frying.
 - 3-4—finish cooking most quantities.
 - WARM—double boiler heat, finish cooking, and special for small quantities.
 - . When boiling water for tea or coffee, heat only amount needed. It is not economical to boil a container full of water for one or two cups.
- Preheat griddle only when necessary. Foods high in natural fat, such as bacon or sausage, can be started on a cold griddle.

Features of Your Cooktop

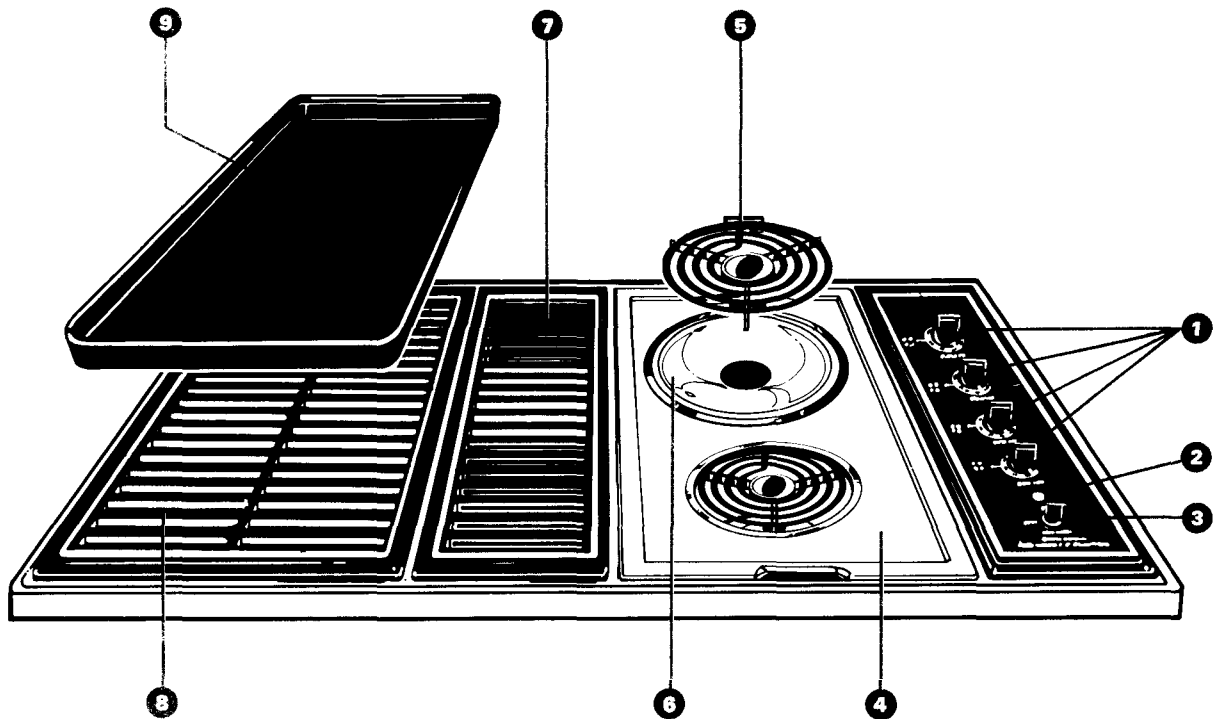

1. Surface Unit Controls. Push in to set Surface Units from WARM to HIGH, grill or griddle. Left and Right Front Controls operate Grill and Griddle.

2. Indicator Light. Lights when any unit of the cooktop is turned on.

3. Exhaust Fan Switch. The exhaust fan will automatically turn on when the grill, griddle, or rotisserie modules are used. Manual operation is required when other modules are in use.

4. Surface Unit Module. The entire module plugs into the cooktop and can be easily removed for cleaning.

5. Plug-In Surface Unit. Units may be easily removed to clean reflector pans beneath each coil. Do not submerge plug-in units in water.

6. Chrome-Plated Reflector Pan. Used to catch spillovers. Remove for cleaning.

7. Vent System. Blower vents smoke down and out of kitchen and house. Vent filters (located under vent grill) should be cleaned often. See page 16 for further explanation.

8. Grill Module. Entire module removes easily. For assembly and explanation of each part of grill, see page 10.

9. Griddle. Remove two grill grates and place over heating element. For further explanation of griddle cooking, see page 13.

Surface Cooking

See Surface Cooking Guide on pages 8 and 9.

Surface Cooking with Infinite Heat Controls

Your surface units and controls are designed to give you an infinite choice of heat settings for surface unit cooking.

At both OFF and HIGH positions, there is a slight niche so control "clicks" at those positions; "click" on HIGH marks the highest setting; the lowest setting is between the words WM and OFF. In a quiet kitchen, you may hear slight "clicking" sounds during cooking, indicating heat settings selected are being maintained.

Switching heats to higher settings always shows a quicker change than switching to lower settings.

How to Set the Controls

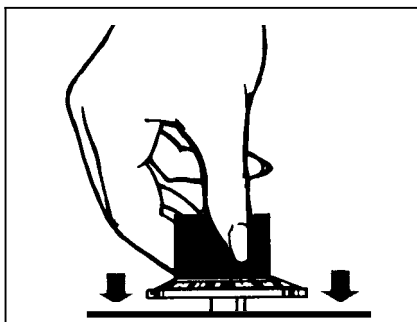

Step 1: Grasp control knob and push in.

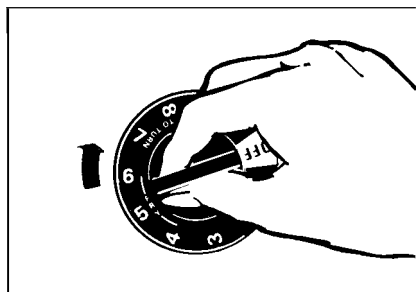

Step 2: Turn either clockwise or counterclockwise to desired heat setting.

Control must be pushed in to set only from OFF position. When control is in any position other than OFF, it may be rotated without pushing in.

Be sure you turn control to OFF when you finish cooking. An indicator light will glow when ANY heat on any surface unit is on.

Cooking Guide for Using Heats

- HI** Quick start for cooking; bring water to boil.
- 7-8** Fast fry, pan broil; maintain fast boil on large amount of food.
- 5-6** Saute and brown; maintain slow boil on large amount of food.
- 3-4** Cook after starting at HIGH; cook with little water in covered pan.
- WM** Steam rice, cereal; maintain serving temperature of most foods.

How to Assemble Module

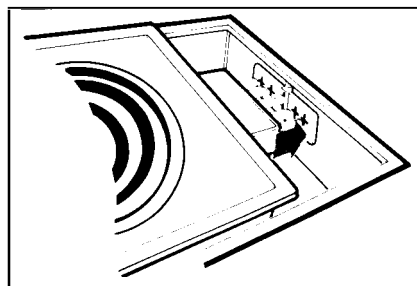

Step 1: Be sure controls are turned to OFF. To install module, position plug to rear.

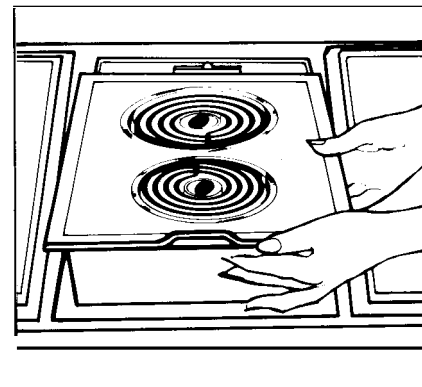

Step 2: Slide module toward receptacle in rear of cooktop until plug is engaged completely in receptacle.

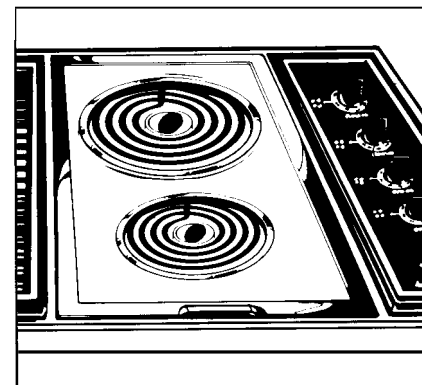

Step 3: Lower the front end of module into cooktop until it is flush with cooking surface.

How to Disassemble Module

Step 1: Be sure surface units are cool before attempting to remove module.

Step 2: Lift up tab at front of module until base clears the opening at the front of cooktop.

Step 3: To unplug, hold module by the side edges and slide toward front of cooktop. Lift out when unplugged.

Step 4: If you are storing modules, do not stack them or store other materials on top of them. This could damage or mar surface of modules.

Questions Answers

Q. May I can foods and preserves on my surface unit coils?

A. Yes, but only use cookware designed for canning purposes. Check the manufacturer's instructions and recipes for preserving foods. Be sure canner is flat-bottomed and fits over the center of your surface unit coil. Since canning generates large amounts of steam, be careful to avoid burns from steam or heat. Canning should only be done on surface units.

Q. Can I cover my drip pans with foil?

A. No. Clean as recommended in Cleaning Guide.

Q. Can I use special cooking equipment, like an oriental wok, on any surface units?

A. Utensils without flat surfaces are not recommended. The life of your surface unit can be shortened and the range top can be damaged from the high heat needed for this type of cooking.

Q. Why am I not getting the heat I need from my units even though I have the knobs on the right setting?

A. After turning surface unit off and making sure it is cool, check to make sure that your plug-in units are securely fastened into the surface connection.

Q. Why do my utensils tilt when I place them on the surface unit?

A. Because the surface unit is not flat. Make sure that the "feet" on your surface units are sitting tightly in the indentation and the reflector ring is flat on the cooktop surface.

Q. Why is the porcelain finish on my cookware coming off?

A. If you set your surface unit coil higher than required for the cookware material, and leave it, the finish may smoke, crack, pop, or burn depending on the pot or pan. Also, a too high heat for long periods, and small amounts of dry food, may damage the finish.

Home Canning Tips

Canning should be done on surface unit coils only.

In surface cooking of foods other than canning, the use of large-diameter utensils (extending more than 1-inch beyond edge of trim ring) is not recommended. However, when canning with water-bath or pressure canner, large-diameter utensils may be used. This is because boiling water temperatures (even under pressure) are not harmful to cooktop surfaces surrounding heating unit.

HOWEVER, DO NOT USE LARGE DIAMETER CANNERS OR OTHER LARGE DIAMETER UTENSILS FOR FRYING OR BOILING FOODS OTHER THAN WATER. Most syrup or sauce mixtures—and all types of frying—cook at temperatures much higher than boiling water. Such temperatures could eventually harm cooktop surfaces surrounding heating units.

Observe Following Points in Canning

1. Bring water to boil on HIGH heat, then after boiling has begun, adjust heat to lowest setting to maintain boil (saves energy and best uses surface unit.)
2. Be sure canner fits over center of surface unit. If your range does not allow canner to be centered on surface unit, use smaller-diameter containers for good canning results.
3. Flat-bottomed canners give best canning results. Be sure bottom of canner is flat or slight indentation fits snugly over surface unit. Canners with flanged or rippled bottoms (often found in enamelware) are not recommended.



4. When canning, use recipes from reputable sources. Reliable recipes are available from the manufacturer of your canner; manufacturers of glass jars for canning, such as Ball and Kerr; and the United States Department of Agriculture Extension Service.

5. Remember, in following the recipes, that canning is a process that generates large amounts of steam. Be careful while canning to prevent burns from steam or heat.

NOTE: If your cooktop is being operated on low power (voltage), canning may take longer than expected, even though directions have been carefully followed. The process may be improved by: (1) using a pressure canner, and (2) for fastest heating of large water quantities, begin with HOT tap water.

Surface Cooking Guide

Cookware Tips

1. Use medium-or heavy-weight cookware. Aluminum cookware conducts heat faster than other metals. Cast iron and coated cast iron cookware is slow to absorb heat, but generally cooks evenly at LOW or MEDIUM settings. Steel pans may cook unevenly if not combined with other metals.

Flat ground Pyroceram® saucepans or skillets coated on the bottom with aluminum generally cook evenly. When cooking on surface unit coils, use glass saucepans with heat-spreading trivets available for that purpose.

2. To conserve the most cooking energy, pans should be flat on the bottom, have straight sides and tight

fitting lids. Match the size of the saucepan to the size of the surface unit. A pan that extends more than an inch beyond the edge of the trim ring traps heat which causes discoloration ranging from blue to dark gray on chrome trim rings and module surfaces.

Food	Cookware	Directions and Setting to Start Cooking	Setting to Complete Cooking	Comments	
Cereal Cornmeal, grits, oatmeal	Covered Saucepan	HI. In covered pan, bring water to boil before adding cereal.	3, then add cereal. Finish timing according to package directions.	Cereals bubble and expand as they cook; use large enough saucepan to prevent boilover.	
Cocoa	Uncovered Saucepan	HI. Stir together water or milk, cocoa ingredients. Bring just to a boil.	4, to cook 1 or 2 minutes to completely blend ingredients	Milk boils over rapidly. Watch as boiling point approaches.	
Coffee	Percolator	HI. At first perk, switch heat to 3.	3, to maintain gentle but steady perk.	Percolate 8 to 10 minutes for 8 cups, less for fewer cups.	
Eggs Cooked in shell	Covered Saucepan	HI. Cover eggs with cool water. Cover pan, cook until steaming.	3. Cook only 3 to 4 minutes for soft cooked; 15 minutes for hard cooked.	If you do not cover skillet, baste eggs with fat to cook tops evenly.	
Fried sunny-side-up	Covered Skillet	5. Melt butter, add eggs and cover skillet.	Continue cooking at 5 until whites are just set, about 3 to 5 more minutes.		
Fried over easy	Uncovered Skillet	HI. Melt butter.	3, then add eggs. When bottoms of eggs have just set, carefully turn over to cook other side.		
Poached	Covered Skillet	HI. In covered pan, bring water to a boil.	3. Carefully add eggs. Cook uncovered about 5 minutes at 5.		Remove cooked eggs with slotted spoon or pancake turner.
Scrambled or omelets	Uncovered Skillet	HI. Heat butter until light golden in color.	4. Add egg mixture. Cook, stirring to desired doneness.		Eggs continue to set slightly after cooking. For omelet, do not stir last few minutes. When set, fold in half.
Fruits	Covered Saucepan	HI. In covered pan, bring fruit and water to boil.	3. Stir occasionally and check for sticking.	Fresh fruit: Use 1/4 to 1/2 cup water per pound of fruit. Dried fruit: Use water as package directs. Time depends on whether fruit has been presoaked. If not, allow more cooking time.	
Meats, Poultry Braised: Pot roasts of beef, lamb or veal; pork steaks and chops	Covered Skillet	HI. Melt fat, then add meat. Switch to 8 to brown meat. Add water or other liquid.	3. Simmer until fork tender.	Meat can be seasoned and floured before it is browned, if desired. Liquid variations for flavor could be wine, fruit or tomato juice or meat broth. Timing: Steaks 1 to 2-inches: 1 to 2 hours. Beef Stew: 2 to 3 hours. Pot Roast: 2 1/2 to 4 hours.	
Parr-fried: Tender chops; thin steaks up to 3/4-inch; minute steaks; hamburgers; franks and sausage; thin fish fillets	Uncovered Skillet	HI. Preheat skillet, then grease lightly.	6. Brown and cook to desired doneness, turning over as needed.	Pan frying is best for thin steaks and chops. If rare is desired, preheat skillet before adding meat	

3. Deep Fat Frying. Do not overfill kettle with fat that may spill over when adding food. Frosty foods bubble vigorously. Watch foods frying at HIGH temperatures and keep cooktop, vent grill and filters clean from accumulated grease.

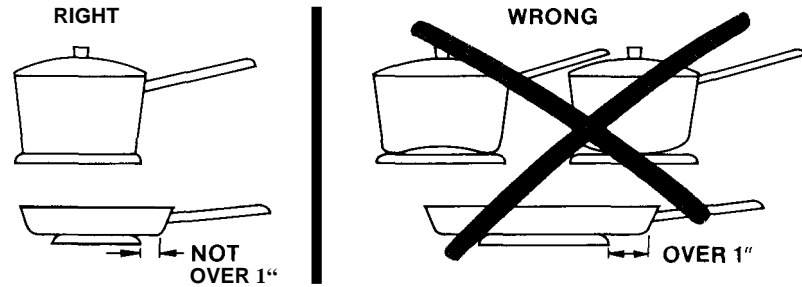

Food	Cookware	Directions and Setting to Start Cooking	Setting to Complete Cooking	Comments
Fried Chicken	Covered Skillet	HI. Melt fat. Switch to 8 to brown chicken.	3. Cover skillet and cook until tender. Uncover last few minutes.	For crisp dry chicken, cover only after switching to 3 for 10 minutes. Uncover and cook, turning occasionally 10 to 20 minutes.
Pan broiled bacon	Uncovered Skillet	HI. In cold skillet, arrange bacon slices. Cook just until starting to sizzle,	7. Cook, turning over as needed.	A more attention-free method is to start and cook at 4.
Sauteed: Less tender thin steaks (chuck, round, etc.); liver; thick or whole fish	Covered Skillet	HI. Melt fat. Switch to 4 to brown slowly.	3. Cover and cook until tender.	Meat may be breaded or marinated in sauce before frying.
Simmered or stewed meat; chicken; corned beef; smoked pork; stewing beef; tongue; etc.	Covered Dutch Oven, Kettle or Large Saucepan	HI. Cover meat with water and cover pan or kettle. Cook until steaming.	3. Cook until fork tender. (Water should slowly boil). For very large loads, medium heat may be needed.	Add salt or other seasoning before cooking if meat has not been smoked or otherwise cured.
Melting chocolate, butter, marshmallows	Small Covered Saucepan. Use small surface unit	WM. Allow 10 to 15 minutes to melt through. Stir to smooth.		When melting marshmallows, add milk or water.
Pancakes or French toast	Skillet or Griddle	7. Heat skillet 8 to 10 minutes. Grease lightly.	Cook 2 to 3 minutes per side.	Thick batter takes slightly longer time. Turn over pancakes when bubbles rise to surface.
<i>Pasta</i> Noodles or spaghetti	Covered Large kettle or Pot	HI. In covered kettle, bring salted water to a boil, uncover and add pasta slowly so boiling does not stop.	7. Cook uncovered until tender. For large amounts, HI maybe needed to keep water at rolling boil throughout entire cooking time.	Use large enough kettle to prevent boilover. Pasta doubles in size when cooked.
Pressure Cooking	Pressure Cooker or Canner	HI. Heat until first jiggle is heard.	7. For foods cooking 10 minutes or less. 4 for foods over 10 minutes.	Cooker should jiggle 2 to 3 times per minute.
Pnddings, Sauces, Candies, Frostings	Uncovered Saucepan	HI. Bring just to boil.	3. To finish cooking	Stir frequently to prevent sticking.
Vegetables Fresh	Covered Saucepan	HI. Measure 1/2 to 1 inch water in saucepan, Add salt and prepared vegetable In covered saucepan bring to boil.	4. Cook 1 pound 10 to 30 or more minutes, depending on tenderness of vegetable.	Uncovered pan requires more water and longer time.
Frozen	Covered Saucepan	HI. Measure water and salt as above. Add frozen block of vegetable. In covered saucepan bring to boil.	3. Cook according to time on package.	Break up or stir as needed while cooking.
Sauteed: Onions; green peppers; mushrooms; celery; etc.	Uncovered Skillet	HI. In skillet melt fat.	4. Add vegetable. Cook until desired tenderness is reached	Turn over or stir vegetable as necessary for even browning.
Rice and Grits	Covered Saucepan	HI. Bring salted water to a boil.	WM. Cover and cook according to time.	Triple in volume after cooking. Time at WM. <i>Rice:</i> 1 cup rice and 2 cups water—25 minutes. <i>Grits:</i> 1 cup grits and 4 cups water—40 minutes.

Grill

See Grill Cooking Guide on page 12.

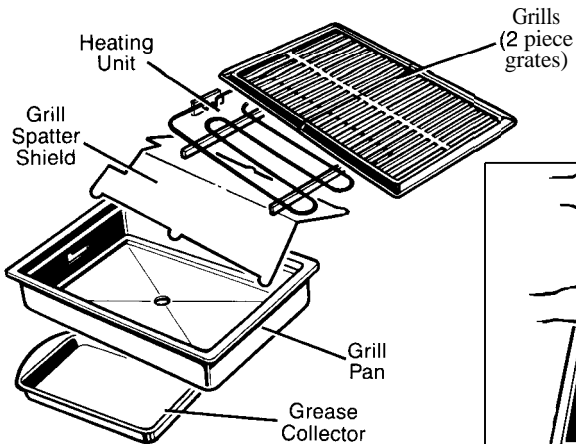

You can enjoy delicious grilled food year 'round, prepared in the convenience of your own kitchen.

How to Assemble the Grill

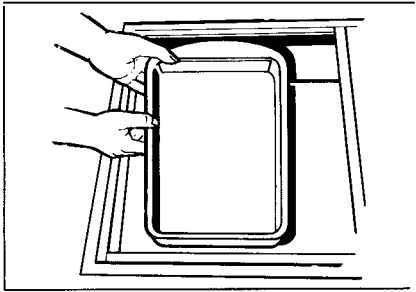

Step 1: Position the Grease Collector in the cooktop burner box space provided. Remove grease from Grease Collector after each use.

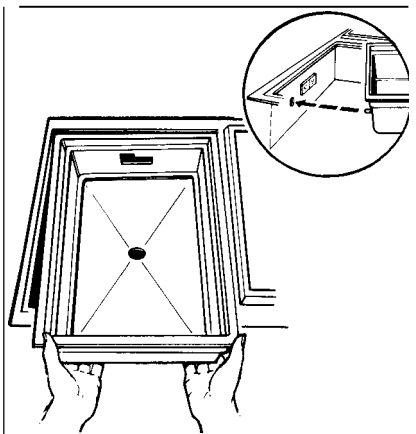

Step 2: Fit Grill Pan in cooktop over Grease Collector. The hole in center of Grill Pan permits grease to drain into collector. Keep hole open at all times.

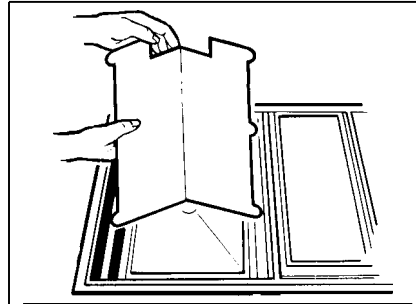

Step 3: Place Grill Spatter Shield in bottom of Grill Pan. This shield prevents spattering and flash fires during grilling.

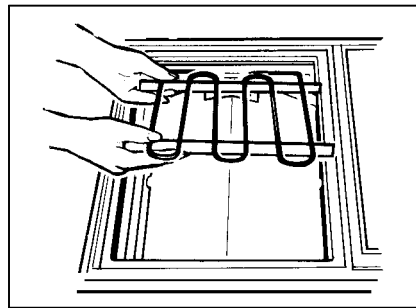

Step 4: Make sure all controls are turned to OFF. Hold Heating Unit with terminals facing rear of the Cooktop and level with the surface. Insert terminals into Cooktop receptacle as far as they will go. (Do not force). Heating Unit should rest on ledge of the Grill Pan.

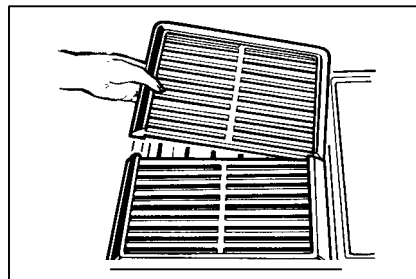

Step 5: Place the 2 Grill Grates on the Grill Pan over the Heating Unit. Grates should be seated properly on Grill Pan or grease will leak between Grill Pan lip and main top and build up in burner box area.

Removing Grill Element

When removing the parts of the Grill module to clean, be sure all switches are in the OFF position and unit is cool. Remove the 2 Grill Grates and then slide the Heating Unit to the front until unplugged. Remove Grill Spatter Shield, Grill Pan and Grease Collector.

How to Set Grill Controls

The control knob must be pushed in to start; this prevents heating unit from being turned on accidentally. Push the knob in only when it is in the OFF position. When the knob is in in any other position, it can be turned without pushing it in.

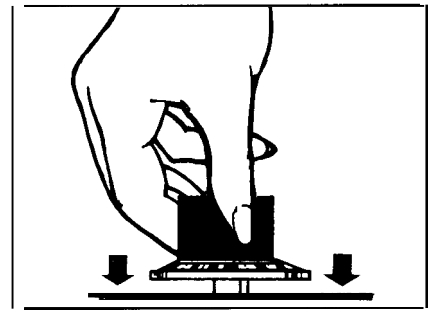

Push in control knob depending on which side of cooktop Grill Module is used. The **right front** control knob controls the grill when module is on the right side and **left front** control knob operates grill when Grill Module is on left side of cooktop.

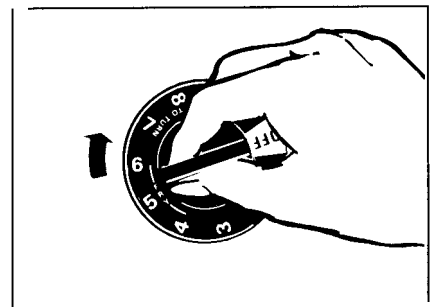

Turn knobs to the heat setting you want.

Grill Tips

• **Do not leave grill unattended while in use.**

• Be sure to preheat according to cooking guide.

• Occasionally rearrange foods on the grill, to prevent sticking and provide better browning.

• Remove accumulated grease from Grease Collector after each use, to lessen smoking and odors. Grease buildup can also become a fire hazard.

. Trim fat from meats before placing on grill. This will reduce smoking and lessen grease buildup in the collector pan. The trimmings may be rubbed on the hot grates to help prevent sticking.

• Grates should be oiled or sprayed with a nonstick vegetable oil before cooking to prevent sticking.

• Make sure Grease Collector, Grill Pan and Grill Spatter Shield are clean before using grill.

• Season meats after cooking rather than before—salt can draw out juices and dry out meat. Use tongs to turn and rearrange meats on the grill; forks will pierce the meat and release juices.

. When cooking foods of various sizes and thicknesses, start larger or thicker pieces first, add quicker-cooking small pieces later. Press meat lightly to lie flat on grill: slash the fat on edges of steaks and chops to prevent curling; break the joints of split chickens so they will lie flat.

• Your interchangeable cooktop modules can be used on either the right or left side of the cooktop. When inserting or removing a module, take care not to force the connection or exert undue pressure which could damage the electrical contacts. Additional modules can be purchased from your dealer, to double your grill/griddle capacity or to add two more surface units.

. If your cooktop is being operated on low power (voltage) foods may be lighter brown than expected. A longer preheating and grill time may be necessary to achieve the desired results.

Questions and Answers

Q. I follow the cooking times suggested, but my foods don't get done properly. Is there something wrong with my grill?

A. Probably not. Suggested cooking times should be used only as a general guide. Variables in food can change cooking times required.

Q. How can I keep barbecued meats from developing an unattractive burned look and taste?

A. Sauces containing sugar will often burn if used during the entire cooking time. If your favorite sauce contains sugar, try adding it only during the last 15 to 20 minutes of cooking time for best results.

Q. When cooking small loads with only half the heating elements, foods are not browning as much as I like. What could cause this?

A. To get optimum cooking performance with small loads, use the rear heating element. Longer preheating time may be required to get the desired results.

Grill Cooking Guide

Do not leave cooktop unattended during “preheat” (switches turned to “HI”) or anytime the switches are turned to” “HI” with food on the Grill or Griddle.

1. Preheat 5 minutes on HI before cooking (except for rare steaks and hamburgers preheat 10 minutes). Turn to setting on guide for your particular food.

2. Before cooking steaks, slash fat around edges to prevent curling of meat.

3. Suggested cooking times should be used only as a guide, since variables in-food can change cooking times.

4. If your cooktop is being operated on low power (voltage), foods may be lighter brown than expected. A longer preheating and grill time may be necessary for your particular food type.

Food	Suggested Setting	Cook Time	Comments
Steak ¾“-1 ½” thick	Rare: HI Medium: Well:	5-7 minutes per side 6-8 minutes per side 8-10 minutes per side	Preheat grill 10 minutes for rare
Steak 1 ¼“-2” thick	Rare: HI-8 Medium: Well:	9-11 minutes per side 13-15 minutes per side 20-23 minutes per side	Preheat grill 10 minutes for rare. Reduce to 8 for well done.
Ground Steak or Hamburgers ¾” thick	Rare: 8 Medium: Well:	6-8 minutes per side 8-10 minutes per side 11-12 minutes per side	Preheat grill 10 minutes for rare
Chicken	Cut-Up Pieces: 8 Quarters: 8 Halves: 8	45-60 minutes (total) 1 hr. to 1 hr. 10 minutes (total) 1 hr. to 1 hr. 25 minutes (total)	Turn over frequently and if desired baste with sauce last 10 to 15 minutes. Break joint bones. Place skin side down. Turn over every 15 minutes and baste frequently as desired. Wing-breast quarters take longer than thigh-leg quarters. Break joint bones. Place skin side down on preheated grill. Turn over and baste frequently as desired.
Ham Slices (Precooked) 1” thick	8	10 minutes per side	
Hot Dogs	HI	8-9 minutes (total)	Turn frequently.
Pork Chops	8	15-18 minutes per side	
Spareribs	8	40-50 minutes (total)	Parboil 5 minutes before grilling. Rearrange and turn over frequently. Baste with sauce last 10 minutes as desired. Very meaty ribs may take about 10 minutes longer.
Lamb Chops	8	20-22 minutes per side	
Lobster Tails	7	15-20 minutes per side	With a sharp knife or scissors, cut lengthwise the undershell into the meat almost through to outer shell. Spread tail apart to expose meat while grilling. Loosen meat but leave in shell. Spray grates with nonstick coating before preheating.
Salmon Steaks 1” thick	8	8-10 minutes per side	Brush with melted butter.
Large Sausage Links	7	10-12 minutes per side	Use bratwurst, kielbasa or smoked Polish sausage.

Griddle

See Griddle Cooking Guide on page 15.

Your nonstick coated griddle provides an extra-large cooking surface for meats, pancakes, or other food usually prepared in a frying pan or electric skillet.

You can also use the griddle as a warming tray, with a low-heat setting.

Note: Griddle is designed for use only on the grill heating unit. Do not use over the surface units.

How to Assemble Griddle

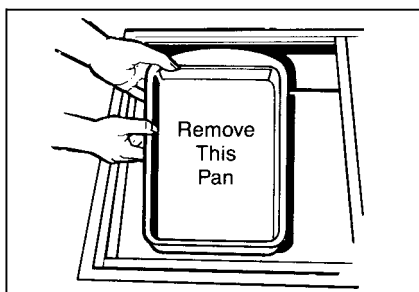

Step 1: Remove Grease Collector before using Griddle.

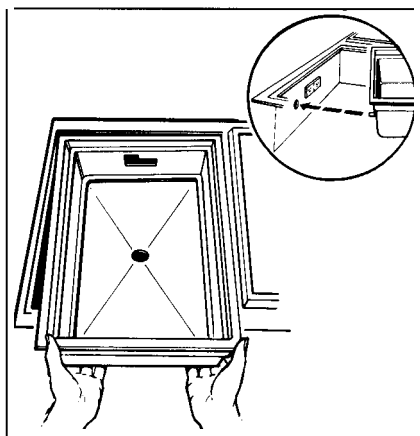

Step 2: Position the Grill pan in the cooktop space provided. Insert with opening to the rear.

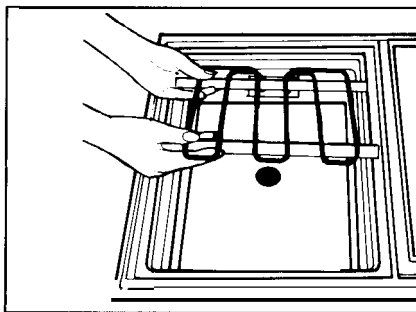

Step 3: Make sure all controls are turned to OFF. Hold Heating Unit with terminals facing rear of the Cooktop and level with the surface. Insert terminals into Cooktop receptacle as far as they will go. (Do not force.) Heating Unit should rest on ledge of the Grill Pan.

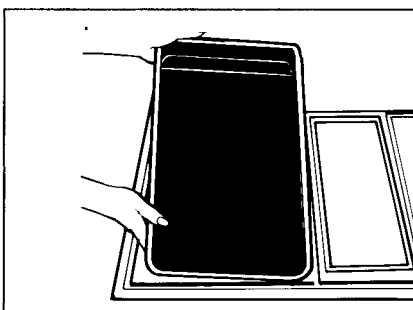

Step 4: Place the nonstick coated Griddle over the Heating Unit.
NOTE: Before its first use, condition or "season" your griddle. Apply a thin layer of cooking oil to the top surface and heat on HI setting for 10 minutes. Griddle is ready to use.

Before every use, be sure griddle components are clean.

How to Set Griddle Control

The control knob must be pushed in to start; this prevents heating unit from being turned on accidentally. Push the knob in only when it is in the OFF position. When the knob is in any other position, it can be turned without pushing it in.

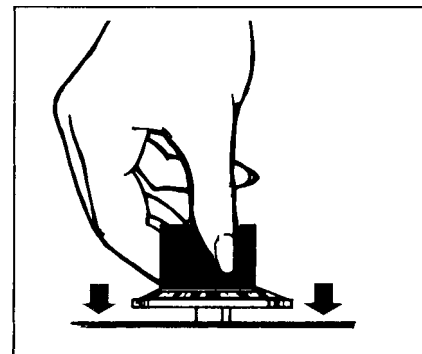

Push in control knob. The **right front** control knob controls the griddle when it is on the right side. The **left front** knob controls the griddle when it is on the left side.

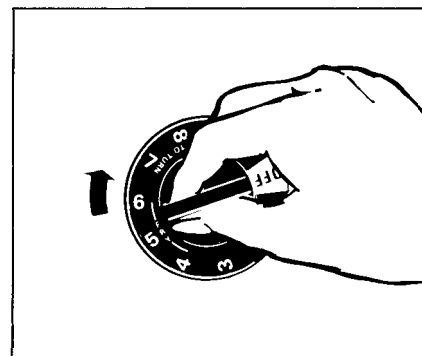

Turn knob to the heat setting you want.

Griddle Tips

- Most griddled foods require cooking on a preheated surface, which may be greased lightly before adding food. Preheat griddle 5 to 10 minutes at HIGH setting unless otherwise indicated on the Griddle Cooking Guide (see page 17), then switch to recommended cook setting.

. Foods which are high in natural fat, such as bacon or sausage, may be started on a cold griddle.

. Foods to be warmed may be placed directly on the griddle; a high domed metal cover such as an inverted kettle, placed over them will help store the heat. Foods in covered dishes or pans may also be warmed on the griddle. Use heat-resistant dishes only.

. Condition or “season” griddle before first-time use.

- Make sure Grill Pan is clean before using griddle.

- To avoid marring the nonstick finish, store griddle upright on edge, if possible. If it is necessary to store it flat, avoid placing other pans or utensils on top.

- To help maintain good food quality and prevent spoilage, do not keep foods warm on griddle for more than two hours. Delicate foods, such as eggs, should not be kept more than 15 to 30 minutes; entrees and casseroles may be warmed for 30 to 60 minutes. Hors d’oeuvres will stay hot for serving up to 1 or 1 ½ hours. Rearrange or stir foods occasionally, if possible.

- If your cooktop is being operated on low power (voltage) foods may be lighter brown than expected. A longer preheating and griddle time may be necessary to achieve the desired results.

- Avoid using metal utensils with sharp points or rough or sharp edges which might damage the nonstick coated griddle surface. Do not cut foods on the griddle. Use only heat-resistant dishes when foods in containers are to be warmed on the griddle. For further information on caring for your griddle’s surface, see the cleaning instructions on page 17.

Questions and Answers

Q. Can my griddle be switched to the other side of the cooktop where it would be more convenient for me?

A. Your interchangeable cooktop modules can be used on either the right or left side of the cooktop. When inserting or removing a module, take care not to force the connection or exert undue pressure which could damage the electrical contacts.

Additional grill modules can be purchased from your dealer, to double your grill/griddle capacity.

Q. Can prolonged periods of high heat damage my griddle’s surface?

A. A brief preheating period is often necessary for best results with many foods, but leaving the griddle on HIGH heat setting for more than 10 minutes without food can damage the nonstick coating. Always be sure to turn control knobs to OFF when cooking is completed.

Griddle Cooking Guide

Do not leave cooktop unattended during “preheat” (switches turned to “HI”) or anytime the switches are turned to” ”HI” with food on the Grill or Griddle.

1. Suggested cooking times should be used only as a guide since variables in food may change cooking time.

2. If your cooktop is being operated on low power (voltage), foods may be lighter brown than expected. A longer preheating and griddle time may be necessary for your particular food.

3. Avoid using metal utensils with sharp points or rough or sharp edges which might damage the nonstick coated griddle surface. Do not cut foods on the griddle. Use only heat-resistant dishes when foods in containers are to be warmed on the griddle.

Food	Suggested Setting	Preheat Time	Cook Time	Comments
Bacon	HI-8	Preheat not necessary	Brown each side.	Start cooking on HI. Switch to 8 after 8 minutes.
Chops	7	At HI if desired 5 minutes	Brown each side.	Start cooking on HI. Switch to 7 after 10 minutes.
Cube & Rib Eye Steaks	7	10 minutes at HI	Brown each side. Doneness as desired.	Grease lightly if desired.
Eggs, Fried	4	5 minutes at HI	2½ minutes, first side. 2 minutes, second side.	Grease lightly if desired.
Fish Steaks	8	5 minutes at HI	15 minutes each side.	Grease lightly if desired.
Franks	8	10 minutes at HI	Turn to brown.	Grease lightly if desired.
French Toast	7	6minutes at HI	2-3 minutes each side.	Grease lightly if desired.
Ham Slices	7	10 minutes at HI if desired	7 minutes each side	Grease lightly if desired. Switch to 8 after 8 minutes.
Hamburgers	7	5 minutes at HI	8-9 minutes each side.	
Pancakes	7	10 minutes at HI	1½ minutes, first side. 1 minute, second side.	Grease lightly if desired.
Sweet Rolls	8	5 minutes at HI	Brown each side.	
Sandwiches	7	5 minutes at HI	5 minutes each side.	Grease lightly if desired.
Sausage Patties	HI-8	Preheat not necessary	Turn to brown.	Start cooking on HI. Switch to 8 after 10 minutes.
Keep Warm Setting and Warming Tray Setting	WM-2		Delicate Foods: 15-30 minutes. Entrees and Casseroles: up to 60 minutes. Hors d'oeuvres: 1 to 1½ hours.	To keep griddled foods warm, use WM setting. To retain moisture, cover food with aluminum foil or an inverted metal pot or bowl. To use as a warming tray, set covered heat resistant serving containers or casseroles on griddles at 2 setting. Keep foods warm no more than 2 hours to preserve food quality and safety. Occasionally rearrange or stir foods.

Cooktop Vent System

The fan will automatically come on when the grill/griddle is used.

The built-in vent system helps remove cooking vapors, odors and smoke from foods prepared on the cooktop, grill and grill accessories.

How to Operate Vent System



To operate the vent system manually turn the exhaust fan switch on the control panel

clockwise until a click is heard, at this time the exhaust fan will come on.

Continuous use of the vent system helps keep the kitchen comfortable and less humid, reducing cooking odors and soiling moisture that normally creates a frequent need for cleaning.

How to Clean Vent System

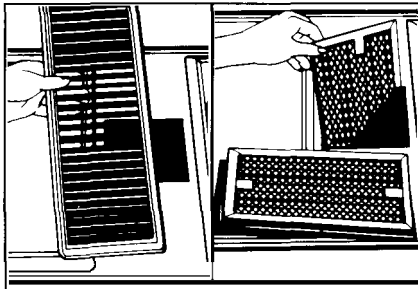

Before cleaning the vent grill, be sure exhaust fan is shut off. To clean the vent grill, remove it from the cooktop by lifting it up. Wipe with a damp cloth. If necessary the vent grill can be washed in the sink. Use mild household liquid detergents for cleaning.

The filters are a permanent type and should be cleaned when soiled. Warm water and liquid dishwashing detergent are all that is required to clean the filters. The vent box may be sponged out in the event of spills.

Accessory

Glass-Ceramic Surface Unit

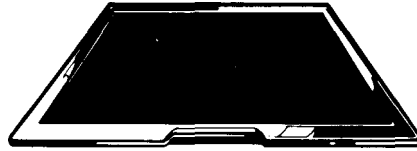

(Available at extra cost from your GE dealer.)

The glass-ceramic cooktop module combines the versatility of surface unit cooking and wipes clean.

This module is installed and removed as explained for surface units. (See page 6.) It is essential that you use flat-bottom pans on this module.

NOTE: Canning or pressure cooking should not be done on the glass-ceramic cooktop module.

Care and Cleaning of the Ceramic Module

If not properly cared for, your ceramic cooktop module can become stained or scratched. Since soil buildup can cause discoloration, spatters and spills must be cleaned up properly. Heavy buildup can cause a dull film even when the cooktop is cool. However, the film is on the surface only and can be removed.

To keep the ceramic cooktop looking like new, follow these steps.

Do not cook foods packaged in their aluminum foil trays or wrapped in aluminum foil on glass ceramic. Foil can melt and fuse to the unit causing permanent damage.

Keep bottom of cookware and cooking surface clean and dry. In dusty or sandy areas, wipe the cookware and cooking surface to prevent scratching the ceramic finish.

Avoid scratching the cooktop with rings, jewelry or other sharp items.

At least once a week, clean the cooktop with Bon Ami brand cleanser, or a similar product, which is especially formulated for cleaning glass-ceramic appliance tops and cookware.

To use, apply Bon Ami to damp paper towel and rub into stain until it is removed. Be sure cooking surface is cooled. (For stubborn stains, apply a paste of Bon Ami and water, cover with a wet paper towel, and let stand for about 45 minutes.) After using Bon Ami, always rinse and dry thoroughly.

NOTE: Bon Ami brand cleanser can be purchased from your dealer or Service Center. It is also sold in many grocery, hardware, and department stores.

Rotisserie

With your rotisserie you add even more flexibility to cooking on the grill/griddle cooktop. The rotisserie fits directly over the grill Heating Unit.

Many foods such as large whole meats, spareribs and skewered foods rotiss well. As the food rotates over the intense heat of the grill, it sears on the outside while inside juices self-baste the meat giving an especially attractive look to the food.

NOTE: Let cooktop parts cool before touching or handling.

Part	Materials to Use	General Directions
Grill Pan and Spatter Shield	<ul style="list-style-type: none"> ● Soap and Water ● Soap-Filled Scouring Pad ● Plastic Scouring Pad 	<p>Let grill cool. Remove grill heating unit and lift out Grill Pan. Grill Pan may be cleaned using one of the methods at left. Keep hole in center of Grill Pan open.</p> <p>Can be cleaned in dishwasher.</p>
Grease Collector (Clean after each use.)	<ul style="list-style-type: none"> ● Chrome Polish ● Warm Soapy Water ● Plastic Scouring Ball 	<p>Never use steel wool or abrasive cleaners. Do not clean in self-cleaning oven.</p> <p>Can be cleaned in dishwasher.</p>
Grill Grates	<ul style="list-style-type: none"> ● Warm Soapy Water ● Plastic Scouring Ball 	<p>Do not clean in self-cleaning oven.</p> <p>Can be cleaned in dishwasher.</p>
Griddle	<ul style="list-style-type: none"> ● Warm Soapy Water ● Soft Cloth ● Plastic Scouring Ball 	<p>Do not use abrasive cleaners.</p> <p>Can be cleaned in dishwasher.</p>
Control Knobs	<ul style="list-style-type: none"> ● Mild Soap and Water 	<p>Pull off knobs. Wash gently but do not soak. Dry and return controls to cooktop making sure to match flat area on the knob and shaft.</p>
Control Panel Glass (may be removed for cleaning)	<ul style="list-style-type: none"> ● Soap and Water 	<p>Wash all glass with cloth dampened in soapy water. Rinse and polish with a dry cloth. If knobs on the control panel are removed, do not allow water to run down inside the surface of glass while cleaning.</p>
Cooktop Surface	<ul style="list-style-type: none"> ● Soap and Water 	<p>Wash, rinse, and then polish with a dry cloth. DO NOT USE steel wool, abrasives, ammonia, acids, or commercial oven cleaners which may damage the finish.</p>
Chrome-Plated Surface Unit Drip Pans	<ul style="list-style-type: none"> ● Soap and Water ● Stiff-Bristled Brush ● Soap-Filled Scouring Pad 	<p>Clean as described below or in the dishwasher.</p> <p>Wipe all rings after each cooking so spatter will not “burn on” next time you cook. To remove “burned-on” spatters, use any or all cleaning materials mentioned. Rub <i>lightly</i> with scouring pad to prevent scratching of the surface. Do not clean in self-cleaning oven.</p>
Surface Unit Coils and Grill Heating Unit		<p>Spatters and spills burn away when the coils are heated. At the end of a meal, remove all utensils from the surface units and heat the soiled units at HI. Let the soil burn off about a minute and switch the units to OFF. Avoid getting cleaning materials on the coils. Wipe off any cleaning materials with a damp paper towel <i>before</i> heating the surface unit.</p> <p>DO NOT handle the unit before completely cooled.</p> <p>DO NOT self-clean plug-in units.</p> <p>DO NOT immerse plug-in units in any kind of liquid or clean in dishwasher.</p>
Filters	<ul style="list-style-type: none"> ● Warm Soapy Water 	<p>DO NOT wash in dishwasher.</p>



Questions? Use This Problem Solver

PROBLEM	POSSIBLE CAUSE AND REMEDY
SURFACE UNITS ARE NOT FUNCTIONING PROPERLY	<ul style="list-style-type: none">• A fuse in your home may be blown or the circuit breaker tripped. Replace fuse or reset circuit breaker.• Surface units are not plugged in solidly.• Reflector pans are not set securely in the range top.• Surface unit controls are not properly set or wrong surface unit control set for unit you are using.• Entire surface unit module is not plugged in properly.• If either surface unit or glass-ceramic module fails to heat—switch the module to the other side of cooktop. If it operates on that side, then surface unit switch maybe at fault. If it does not heat, indications are that there is a malfunctioning component in the module.
GRILL/GRIDDLE UNITS ARE NOT FUNCTIONING PROPERLY	<ul style="list-style-type: none">• Grill/Griddle Heating Unit is not plugged in solidly.• Grill unit control is not properly set or wrong control used.
FOODS STICK 111 GRILL OR GRIDDLE	<ul style="list-style-type: none">• Griddle was not pre-seasoned before first use. Surface of grill or griddle was not greased before cooking.. Food is being cooked with too high of a heat setting.• Nonstick coating of griddle has been damaged by use of sharp instruments or abrasive cleaners.
EXCESSIVE SMOKE FROM GRILLED MEATS	<ul style="list-style-type: none">• Accumulated grease in drip pan or food soils on grate are causing excess smoke.• Fats not trimmed from meats prior to cooking.

**If you need more help... call, toll free:
The GE Answer Center® ‘
800.626.2000
consumer information service**

If You Need Service

To obtain service, see your warranty on the back page of this book.

We're proud of our service and want you to be pleased. If for some reason you are not happy with the service you receive, here are three steps to follow for further help.

FIRST, contact the people who serviced your appliance. Explain why you are not pleased. In most cases, this will solve the problem.

NEXT, if you are still not pleased, write all the details—including your phone number—to:

Manager, Consumer Relations
General Electric
Appliance Park
Louisville, Kentucky 40225

FINALLY, if your problem is still not resolved, write:

Major Appliance
Consumer Action Panel
20 North Wacker Drive
Chicago, Illinois 60606

YOUR BUILT-IN COOKTOP WARRANTY

Save proof of original purchase date such as your sales slip or cancelled check to establish warranty period

WHAT IS COVERED

FULL ONE-YEAR WARRANTY

For one year from date of original purchase, we will provide, free of charge, parts and service labor in your home to repair or replace **any part of the cooktop** that fails because of a manufacturing defect.

This warranty is extended to the original purchaser and any succeeding owner for products purchased for ordinary home use in the 48 mainland states, Hawaii and Washington, D.C. In Alaska the warranty is the same except that it is LIMITED because you must pay to ship the product to the service shop or for the service technician's travel costs to your home.

All warranty service will be provided by our Factory Service Centers or by our authorized Customer Care® servicers during normal working hours.

Look in the White or Yellow Pages of your telephone directory for GENERAL ELECTRIC COMPANY, GENERAL ELECTRIC FACTORY SERVICE, GENERAL ELECTRIC-HOTPOINT FACTORY SERVICE or GENERAL ELECTRIC CUSTOMER CARE@ SERVICE.

IS NOT COVERED

- Service trips to your home to teach you how to use the product.
Read your Use and Care material. If you then have any questions about operating the product, please contact your dealer or our Consumer Affairs office at the address below, or call, toll free:
The GE Answer Center®
800.626.2000
consumer information service

- Improper installation.

If you have an installation problem, contact your dealer or installer. You are responsible for providing adequate electrical, gas, exhausting and other connecting facilities.

• Replacement of house fuses or resetting of circuit breakers.

• Failure of the product if it is used for other than its intended purpose or used commercially.

• Damage to product caused by accident, fire, floods or acts of God.

WARRANTOR IS **NOT** RESPONSIBLE FOR CONSEQUENTIAL DAMAGES.

Some states do not allow the exclusion or limitation of incidental or consequential damages, so the above limitation or exclusion may not apply to you. This warranty gives you specific legal rights, and you may also have other rights which vary from state to state. To know what your legal rights are in your state, consult your local or state consumer affairs office or your state's Attorney General.

Warrantor: General Electric Company

**If further help is needed concerning this warranty, contact:
Manager—Consumer Affairs, General Electric Company, Appliance Park, Louisville, KY 40225**



Free Manuals Download Website

<http://myh66.com>

<http://usermanuals.us>

<http://www.somanuals.com>

<http://www.4manuals.cc>

<http://www.manual-lib.com>

<http://www.404manual.com>

<http://www.luxmanual.com>

<http://aubethermostatmanual.com>

Golf course search by state

<http://golfingnear.com>

Email search by domain

<http://emailbydomain.com>

Auto manuals search

<http://auto.somanuals.com>

TV manuals search

<http://tv.somanuals.com>