

2-931SST

**Digital Spread Spectrum 900MHz  
Cordless Telephone  
With Caller ID  
User's Guide**

## FCC REGISTRATION INFORMATION

Your telephone equipment is registered with the Federal Communications Commission and is in compliance with parts 15 and 68, FCC Rules and Regulations.

### 1 Notification to the Local Telephone Company

On the bottom of this equipment is a label indicating, among other information, the FCC Registration number and Ringer Equivalence Number (REN) for the equipment. You must, upon request, provide this information to your telephone company.

The REN is useful in determining the number of devices you may connect to your telephone line and still have all of these devices ring when your telephone number is called. In most (but not all) areas, the sum of the RENs of all devices connected to one line should not exceed 5. To be certain of the number of devices you may connect to your line as determined by the REN, you should contact your local telephone company.

#### Notes

- This equipment may not be used on coin service provided by the telephone company.
- Party lines are subject to state tariffs, and therefore, you may not be able to use your own telephone equipment if you are on a party line. Check with your local telephone company.
- Notice must be given to the telephone company upon permanent disconnection of your telephone from your line.

### 2 Rights of the Telephone Company

Should your equipment cause trouble on your line which may harm the telephone network, the telephone company shall, where practicable, notify you that temporary discontinuance of service may be required. Where prior notice is not practicable and the circumstances warrant such action, the telephone company may temporarily discontinue service immediately. In case of such temporary discontinuance, the telephone company must: (1) promptly notify you of such temporary discontinuance; (2) afford you the opportunity to correct the situation; and (3) inform you of your right to bring a complaint to the Commission pursuant to procedures set forth in Subpart E of Part 68, FCC Rules and Regulations.

The telephone company may make changes in its communications facilities, equipment, operations or procedures where such action is required in the operation of its business and not inconsistent with FCC Rules and Regulations. If these changes are expected to affect the use or performance of your telephone equipment, the telephone company must give you adequate notice, in writing, to allow you to maintain uninterrupted service.

## INTERFERENCE INFORMATION

This device complies with Part 15 of the FCC Rules. Operation is subject to the following two conditions: (1) This device may not cause harmful interference; and (2) This device must accept any interference received, including interference that may cause undesired operation.

This equipment has been tested and found to comply with the limits for a Class B digital device, pursuant to Part 15 of the FCC Rules. These limits are designed to provide reasonable protection against harmful interference in a residential installation.

This equipment generates, uses, and can radiate radio frequency energy and, if not installed and used in accordance with the instructions, may cause harmful interference to radio communications. However, there is no guarantee that interference will not occur in a particular installation.

If this equipment does cause harmful interference to radio or television reception, which can be determined by turning the equipment off and on, the user is encouraged to try to correct the interference by one or more of the following measures:

- Reorient or relocate the receiving antenna (that is, the antenna for radio or television that is "receiving" the interference).
  - Reorient or relocate and increase the separation between the telecommunications equipment and receiving antenna.
  - Connect the telecommunications equipment into an outlet on a circuit different from that to which the receiving antenna is connected.
  - Consult the dealer or an experienced radio/TV technician for help.
- If these measures do not eliminate the interference, please consult your dealer or an experienced radio/television technician for additional suggestions. Also, the Federal Communications Commission has prepared a helpful booklet, "How To Identify and Resolve Radio/TV Interference Problems." This booklet is available from the U.S. Government Printing Office, Washington, D.C. 20402. Please specify stock number 004-000-00345-4 when ordering copies.

## HEARING AID COMPATIBILITY

This telephone system meets FCC standards for Hearing Aid Compatibility.

# TABLE OF CONTENTS

<b>INTRODUCTION</b> .....	<b>4</b>	<b>HANDSET SOUND SIGNALS</b> .....	<b>16</b>
CORDLESS PHONE INFORMATION .....	4	<b>CALLER ID FEATURES &amp; FUNCTIONS</b> .....	<b>17</b>
CALLER ID INFORMATION .....	4	CALLER ID DISPLAY FEATURES .....	17
MODULAR JACK REQUIREMENTS .....	5	REVIEWING CALL RECORDS .....	18
<b>GETTING STARTED</b> .....	<b>5</b>	DIALING A CALLER ID RECORD .....	18
HANDSET SETUP .....	6	STORING A CALLER ID RECORD	
DESKTOP INSTALLATION .....	7	IN MEMORY .....	18
WALL MOUNT INSTALLATION .....	8	DELETING RECORDS .....	19
<b>CORDLESS PHONE BASICS</b> .....	<b>9</b>	DELETING AN INDIVIDUAL RECORD ..	19
MAKING A CALL .....	9	DELETING ALL RECORDS .....	19
IN USE INDICATORS .....	9	VIP RECORDS .....	19
REDIAL .....	9	STORING A VIP RECORD .....	19
RECEIVING A CALL .....	9	REVIEWING VIP RECORDS .....	20
FLASH BUTTON .....	10	DIALING A VIP RECORD .....	20
ADJUSTING THE VOLUME .....	10	DELETING A VIP RECORD .....	20
HANDSET EARPIECE VOLUME .....	10	DELETING ALL VIP RECORDS .....	20
RINGER VOLUME .....	10	CALLER ID MESSAGES .....	21
SELECTING A RING TONE .....	10	CALL WAITING DISPLAY .....	22
TEMPORARY TONE .....	11	FORMATTING LONG DISTANCE	
PAGING THE HANDSET .....	11	NUMBERS .....	23
THE MEMORY FEATURE .....	12	ENTERING LOCAL AREA CODE .....	23
STORING A NUMBER IN MEMORY ...	12	<b>CHANGING THE BATTERY</b> .....	<b>24</b>
ADDING A PAUSE WHEN YOU STORE		<b>GENERAL PRODUCT CARE</b> .....	<b>25</b>
A NUMBER IN MEMORY .....	13	CAUSES OF POOR RECEPTION .....	25
STORING A TEMPORARY TONE		SERVICE .....	25
NUMBER .....	14	<b>TROUBLESHOOTING GUIDE</b> .....	<b>26</b>
STORING A CALLER ID RECORD .....	14	<b>INDEX</b> .....	<b>28</b>
DELETING A STORED NUMBER .....	14	<b>LIMITED WARRANTY</b> .....	<b>29</b>
DELETING ALL STORED NUMBERS			
AT ONCE .....	15		
DIALING A STORED NUMBER .....	15		
DIALING FROM THE DISPLAY .....	15		
DIALING WITH DIRECT DIGIT ENTRY	15		
CHAIN DIALING FROM MEMORY .....	16		

**WARNING: TO PREVENT FIRE OR ELECTRICAL SHOCK HAZARD, DO NOT EXPOSE THIS PRODUCT TO RAIN OR MOISTURE.**



# INTRODUCTION

---

Your cordless telephone is designed to give you flexibility in use and high quality performance. To get the most from your new cordless telephone, we suggest that you take a few minutes right now to read through this instruction manual.

## CORDLESS PHONE INFORMATION

- **Digital Security System**

When you place the Handset in the base, the unit verifies it's security code which prevents false ringing from other cordless telephones. After a power outage or battery replacement, you should place the Handset in the base for about 20 seconds to reset the code.

- **IMPORTANT: This Should Not Be The Only Phone in Your Home**

Because cordless phones operate on electricity, you should have at least one phone in your home that is not cordless, in case the power in your home goes out.

## CALLER ID INFORMATION

This device allows you to take advantage of the Caller Identification Delivery with Call Waiting service that may be available from your local telephone company. If you do not have this service already installed, you must contact your local telephone company to arrange to have this service installed on your line. There is an extra charge to your monthly telephone bill for this service.

# GETTING STARTED

---

Make sure your package includes the items shown below.

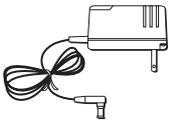

AC power adapter

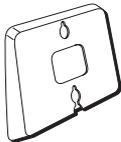

Wall mount bracket



Telephone line cord



Short telephone  
line cord



Battery (5-2419)

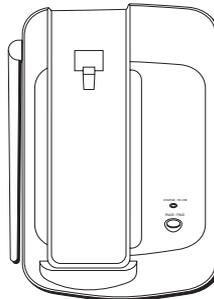

Base



Handset

## MODULAR JACK REQUIREMENTS

You need an RJ11C, type modular jack, which is the most common type of phone jack and might look like the one pictured here. If you don't have a modular jack, call your local phone company to find out how to get one installed.

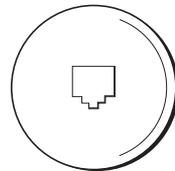

**INSTALLATION NOTE:** Some cordless telephones operate at frequencies that may cause interference to nearby TVs and VCRs. To minimize or prevent such interference, the base of the cordless telephone should not be placed near or on top of a TV or VCR. If interference continues, moving the cordless telephone farther away from the TV or VCR will often reduce or eliminate the interference.

## HANDSET SETUP

1. Remove the battery compartment door.
2. Insert the battery into the compartment.
3. Install the battery compartment door.
4. Plug the power supply cord into the 9V DC jack on the base and into an AC outlet.
5. Place the handset in the base (facing either up or down) to charge for 12 hours.
  - a) Base Unit on Desk – Charging of handset can be done with handset facing either Up or Down.
  - b) Base Unit at Wall Mount – Charging of handset can be done ONLY in face-up position.

**IMPORTANT:** If you do not charge the handset battery properly (for 12 hours) when you first set up the phone, the battery's long-term performance will be compromised.

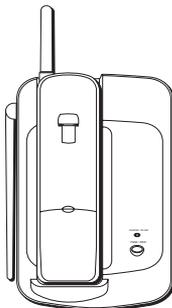
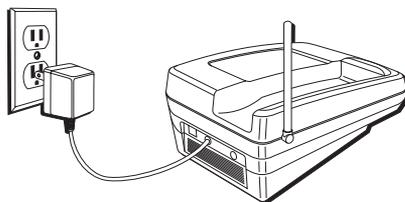
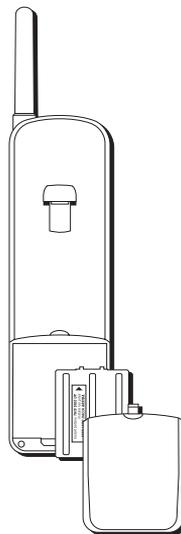

**IMPORTANT:** Return the handset to the base unit for at least 3 minutes once a week to reestablish the phone's communication link. This procedure is also useful if you find it difficult getting the phone to go off hook.

## DESKTOP INSTALLATION

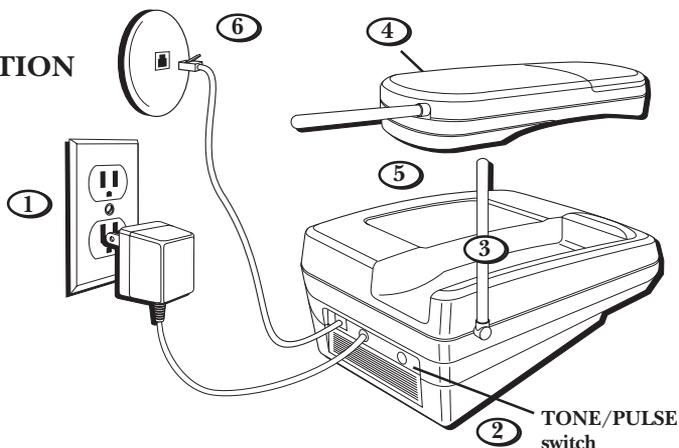

1. Plug the power supply cord into the 9V DC jack on the base and into an AC outlet.
2. Set the TONE/PULSE switch to TONE for touch-tone service, or PULSE for rotary service. If you don't know which type of service you have, check with the phone company.
3. Raise the base antenna.
4. Select RINGER ON or OFF (on the side of handset). When you select OFF, the handset doesn't ring.
5. **Place handset in the base to charge for 12 hours.** The CHARGE/IN USE light comes on to indicate that the battery is charging.  
**If you don't charge the handset battery properly (for 12 hours) when you first set up the phone, the battery's long-term performance will be compromised.**
6. Plug the telephone line cord into the PHONE LINE jack on the back of the base and into a modular jack.

**NOTE:** Use only the AC power adapter (5-4083) that came with this unit. Using other adapters may damage the unit.

# WALL MOUNT INSTALLATION

1. Plug the short telephone line cord into the PHONE LINE jack on the back of the base and connect the other end to a wall jack.
2. Plug the power supply cord into the 9V DC jack on the base and plug the power supply into an AC outlet.
3. Feed the short line cord through the notch at the top of the wall mount bracket so that it comes through the square opening on the bracket. Then feed the power supply cord through both the top and bottom notches on the bracket.
4. Attach the wall mount bracket by putting the tabs into the slots on the top of the unit and then snap the tabs at the bottom of the wall mount bracket into place.
5. Slip the mounting holes over the wall plate posts and slide the unit down firmly into place. (Wall plate not included.)
6. Raise the base antenna.
7. Set the TONE/PULSE switch to TONE for touch-tone service, or PULSE for rotary service. If you don't know which type of service you have, check with the phone company.
8. Select RINGER ON or OFF (on the side of handset). When you select OFF, the handset doesn't ring.
9. Place handset in the base to charge for 12 hours. The CHARGE/IN USE light comes on indicating that the battery is charging.

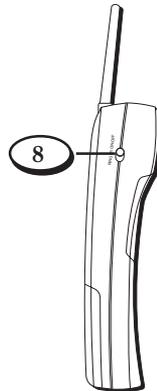
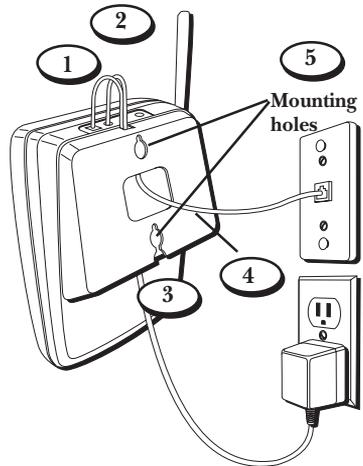

**If you don't charge the battery properly (for 12 hours) when you first set up the phone, the battery's long-term performance will be compromised.**



# CORDLESS PHONE BASICS

## MAKING A CALL

After initial set up, the handset battery should be charged for at least 12 hours.

The only two things you need to know to make a call are:

- Press the TALK button before you dial. If you try to make a call when you're too far away from the base, the handset beeps.
- Press TALK or place the handset in the base to hang up.

## IN USE INDICATORS

- The TALK button on the handset lights.
- The CHARGE/IN USE light on the base blinks.
- The Phone Symbol appears in the display.

## REDIAL

Press the TALK button, then press the REDIAL button to redial the last number (up to 32 digits) you called.

## RECEIVING A CALL

1. Check the display for Caller ID information.
2. Press TALK to answer a call.

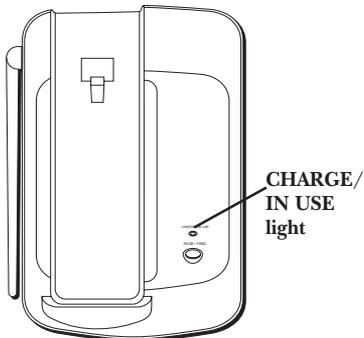
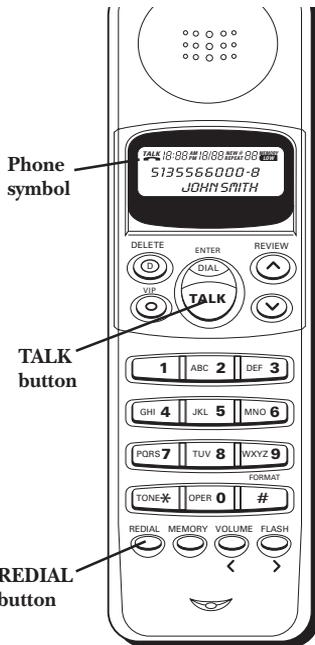

## FLASH BUTTON

Use the FLASH button to activate custom calling services such as call waiting or call transfer, which are available through your local phone company.

**IMPORTANT:** Don't use the TALK button to activate custom calling services such as call waiting, or you'll hang up the phone.

## ADJUSTING THE VOLUME

The VOLUME button on the handset to control the volume of the handset's earpiece and the ringer volume.

### HANDSET EARPIECE VOLUME

To change the volume of the handset's earpiece, press VOLUME while the phone is in use.

### RINGER VOLUME

To adjust the ringer volume, press the VOLUME button when the phone is on-hook (phone is inactive, TALK light is off).

## SELECTING A RING TONE

There are 3 ring tones built into your phone. To choose a ring tone, press FLASH followed by either 1, 2, or 3 when the phone is on-hook (phone is inactive, TALK light is off).



VOLUME  
button

FLASH  
button

## TEMPORARY TONE

This feature enables people who have pulse (rotary) service to access touch-tone services offered by banks, credit card companies, etc., by pressing the tone button to temporarily make the phone touch-tone compatible. To get information about your bank account, for example, you would:

1. Press the TALK button.
2. Call the bank's information line.
3. Press the TONE button after your call is answered.
4. Follow the bank's voice instructions to complete your transaction.
5. Hang up when finished. The phone returns to pulse (rotary) service.

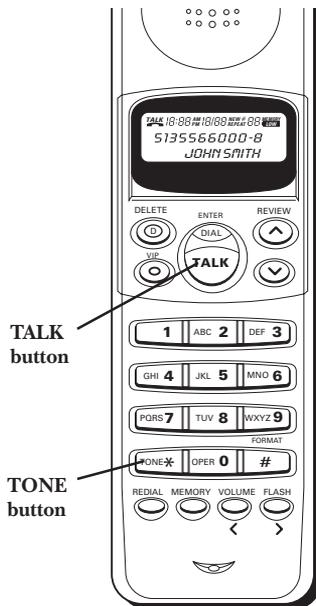

## PAGING THE HANDSET

Press the PAGE button on the base to get the attention of somebody who is using the handset or to locate a misplaced handset.

When you press PAGE on the base, the handset beeps (the CHARGE/IN USE light on the base blinks).

Press the TALK button when you locate the handset to stop the PAGE feature. Remember that the RINGER switch on the side of the handset must be ON in order for the handset to beep.

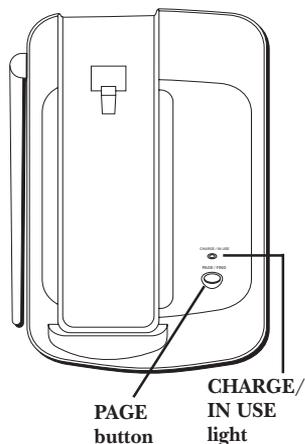

## THE MEMORY FEATURE

Store up to 20 numbers in memory for quick dialing.

### STORING A NUMBER IN MEMORY

1. Make sure that the phone is OFF.
2. Press the MEMORY button (*SEL MEM ENTRY?* appears in the display).
3. Use the REVIEW buttons ( $\wedge \vee$ ) to select an empty memory location, and then press the < and > buttons (VOLUME and FLASH) to put the phone in memory edit mode

or

Use the digits for direct memory location entry (01-20), and then press MEMORY put the phone into memory edit mode.

- The phone goes into memory edit mode and *ENTER NUMBER* appears in the display.
4. Use the digits to enter a telephone number (up to 16 digits).
    - Use the < and > buttons (VOLUME and FLASH) to move across the screen.
    - Use DELETE to delete a number.
  5. Press MEMORY after you have entered the number.
    - *ENTER NAME* appears in the display.

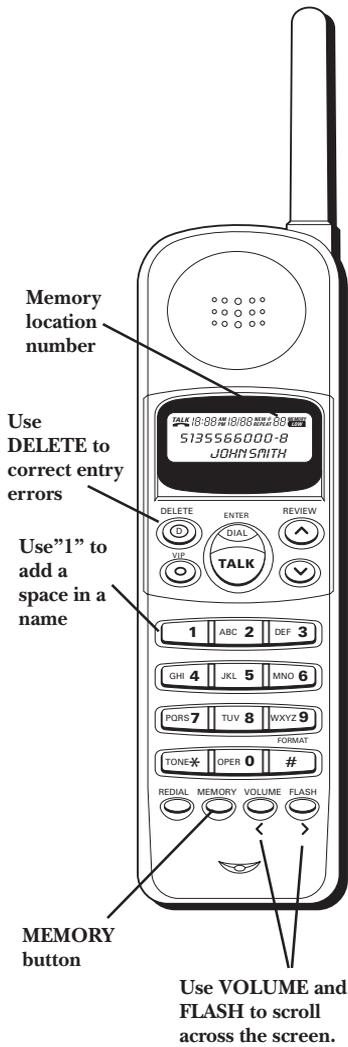

6. Use the digits (2-9) and the < > buttons to enter a name.
  - a. Each number on the keypad has corresponding letters. Each time you press the digit, it scrolls to the next letter for that digit. (For example to enter the letter "C", you would press the digit "2" three times).
  - b. Press > (FLASH button) or a new digit to move to the next letter in the name.
  - c. Use the number 1 to insert a space, and use DELETE to correct errors.
7. When the name is complete, press MEMORY to store the name and number.
  - Two beeps indicates successful operation.

### **ADDING A PAUSE WHEN YOU STORE A NUMBER IN MEMORY**

Use the REDIAL button to insert a pause in the dialing sequence when you store a number (for example, when you must dial 9 to get an outside line or enter codes to access your bank's information line).

## STORING A TEMPORARY TONE NUMBER

1. Press the MEMORY button.
2. Press any (2 digit) number (01-20) to store the dialed number in that memory location.
3. Press MEMORY again.
4. Dial the number.
5. Press the TONE button to switch to tone dialing. (The TONE counts as one digit.)
6. Enter authorization code/access numbers.
7. Press MEMORY.

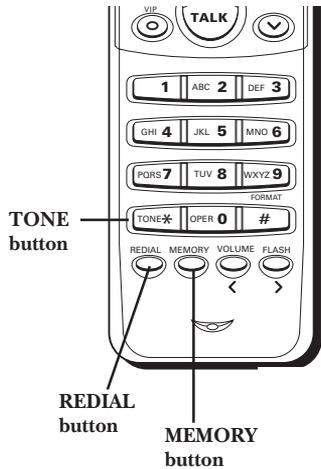

## STORING A CALLER ID RECORD

You can store a caller ID record in memory. See the "Caller ID Features & Functions" section for details.

## DELETING A STORED NUMBER

1. Press the MEMORY button.
2. Use the REVIEW buttons (▲ ▼) to select the desired memory location, or use the digits for direct entry (01-20).
3. Press the DELETE button. (*DELETE ENTRY?* appears in the display.)
4. Press DELETE again to confirm.

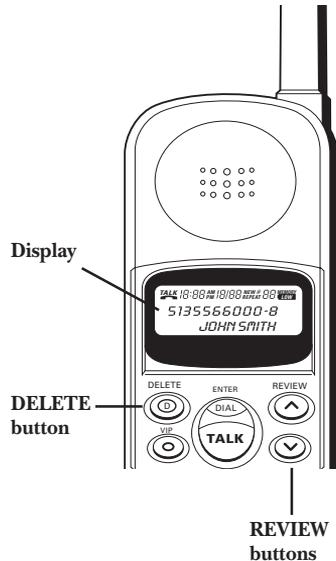

## **DELETING ALL STORED NUMBERS AT ONCE**

1. Press the MEMORY button.
2. Use the REVIEW buttons (▲ ▼) to select the desired memory location, or use the digits for direct entry (01-20).
3. Press and hold the DELETE button. (*DELETEALL???* appears in the display.)
4. Press DELETE again to confirm.

## **DIALING A STORED NUMBER**

You can dial a stored number by selecting it from the display, or through direct digit entry.

### **DIALING FROM THE DISPLAY**

1. Make sure the phone is off.
2. Press MEMORY.
3. Use the REVIEW buttons (▲ ▼) to select the desired memory location.
4. Press the DIAL button.

### **DIALING WITH DIRECT DIGIT ENTRY**

1. Press the TALK button to get a dial tone.
2. Press MEMORY.
3. Press any 2-digit memory location number (01-20).

## CHAIN DIALING FROM MEMORY

Use this feature to make calls which require a sequence of numbers, for instance if you use a calling card for a frequently called long distance number. Basically, you dial each part of the sequence from memory. The following example shows how you can use chain dialing to make a call through a long distance service:

<i>The Number For</i>	<i>Memory Location</i>
Long distance access number	07
Authorization code	08
Frequently called long distance number	09

1. Press the TALK button to get a dial tone.
2. Press the MEMORY button and then press 07.
3. When you hear the access tone, press MEMORY and then press 08.
4. At the next access tone, press MEMORY and then 09.

## HANDSET SOUND SIGNALS

<i>Signal</i>	<i>Meaning</i>
Two beeps - continuous (phone off)	Page signal
Soft double-beeps in the earpiece (phone on)	Page Signal
A long warbling tone (with ringer on)	Incoming call signal
Intermittent short beep	Battery low



# CALLER ID FEATURES & FUNCTIONS

The Caller ID feature lets you screen calls as they come in and also stores records of calls that are received. Here are some of the features available:

- Callback – Dial a Caller ID record's number.
- VIP Numbers – Store up to 5 VIP numbers so you can quickly see if those people have called you.
- VIP Ring – A distinctive ring tone occurs when you receive a call from a VIP caller.
- Memory Storage – Store in memory a Caller ID record's number.
- Long Distance Formatting – Format a Caller ID record for long distance callback.
- Call Waiting – Accept call waiting calls (if the service is available).
- CID Records – Store up to 40 Caller ID records.

## CALLER ID DISPLAY FEATURES

### HANDSET

- Caller's telephone number
- Caller's name (if available)
- Caller ID Error Messages
- Date and Time of the call
- Whether the call is new or a repeat call

### BASE

- CHARGE/IN USE light flashes rapidly when you have new or unread messages

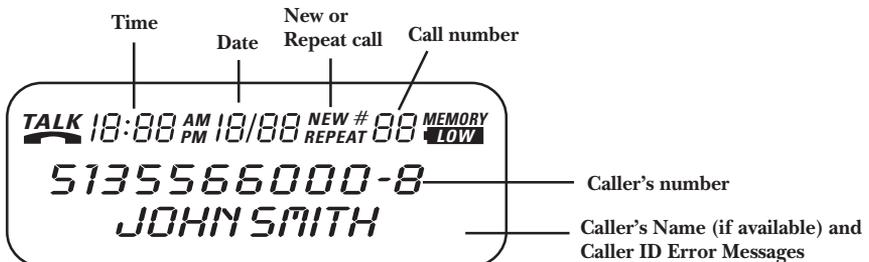

## REVIEWING CALL RECORDS

Each time someone calls, their call is stored in the Caller ID memory (up to 40 calls).

- Press REVIEW  $\wedge$  to review the caller list from the oldest record to the newest
- Press REVIEW  $\vee$  to review the caller list from the newest record to the oldest.

## DIALING A CALLER ID RECORD

To dial the number in a record:

1. Use the REVIEW buttons ( $\wedge$   $\vee$ ) to select the record you want to dial.
2. Press the DIAL button.

## STORING A CALLER ID RECORD IN MEMORY

1. Use the REVIEW buttons ( $\wedge$   $\vee$ ) to select the record you want to store in memory.
2. Press the MEMORY button to put the handset into memory mode.
3. Use the REVIEW buttons ( $\wedge$   $\vee$ ) to select the desired memory location.
4. Press MEMORY to store the record.

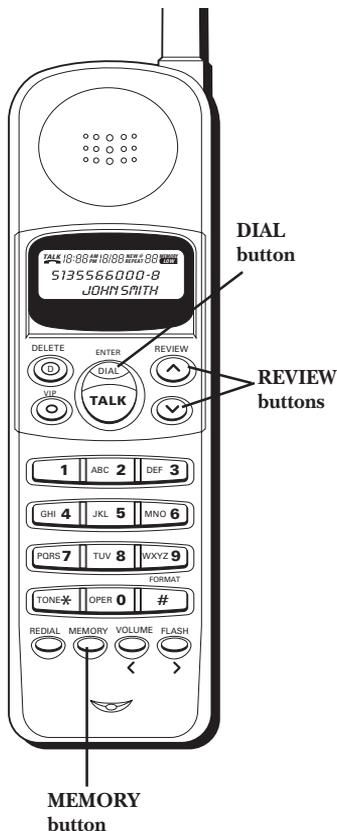

## DELETING RECORDS

When 40 records have been stored, new calls are added to the beginning of the caller list, and the oldest calls are deleted. You can also manually delete records.

### DELETING AN INDIVIDUAL RECORD

1. Use the REVIEW buttons (▲ ▼) to select the record you want to delete.
2. Press the DELETE button. (*DELETE ENTRY?* appears in the display.)
3. Press DELETE again to confirm.

### DELETING ALL RECORDS

1. Use the REVIEW buttons (▲ ▼) to select the record you want to delete.
2. Press and hold the DELETE button. (*DELETE ALL?* appears in the display.)
3. Press DELETE again and hold until a double confirmation beep is heard.

## VIP RECORDS

You can store as many as five records into a VIP list for easier access.

### STORING A VIP RECORD

1. Use the REVIEW buttons (▲ ▼) to select the record you want to add to the VIP list.
2. Press the VIP button.
3. Use the REVIEW buttons (▲ ▼) to select the a VIP location.
4. Press VIP again to store the record.

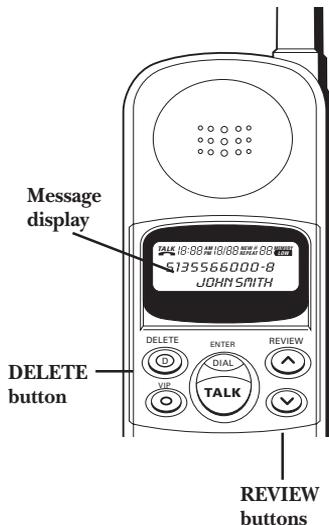

## REVIEWING VIP RECORDS

1. Press the VIP button.
2. Press REVIEW  $\blacktriangle$  to review the VIP list from the oldest record to the newest, and press REVIEW  $\blacktriangledown$  to review the VIP list from the newest record to the oldest.

## DIALING A VIP RECORD

1. Press the VIP button.
2. Press REVIEW ( $\blacktriangle \blacktriangledown$ ) to review the VIP list.
3. Select the record you want to dial, and then press DIAL.

## DELETING A VIP RECORD

1. Press the VIP button.
2. Press REVIEW ( $\blacktriangle \blacktriangledown$ ) to review the VIP list.
3. Select the record you want to delete, and then press DELETE. (*DELETEENTRY?* appears in the display.)
4. Press DELETE again to confirm.

## DELETING ALL VIP RECORDS

1. Press the VIP button.
2. Press REVIEW ( $\blacktriangle \blacktriangledown$ ) to review the VIP list.
3. Press and hold the DELETE button. (*DELETEALL?* appears in the display.)
4. Press DELETE again to confirm.

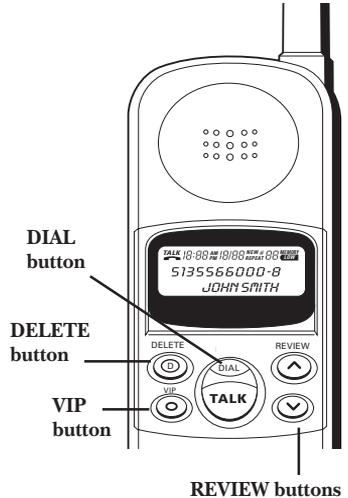

# CALLER ID MESSAGES

The following indicators show the status of a message or the unit.

<b>New 3</b>	There are 40 total calls stored in your phone's Caller ID memory, 3 of them are new calls and 10 repeat.
<b>Repeat 10</b>	
<b>Total 40</b>	
<b>Change AREA CODE from 317 to _ _ _</b>	Prompt asking you to enter your area code when you set up your Caller ID.
<b>PAGE</b>	Your handset is being paged from the base.
<b>LOW BATTERY</b>	Your phone battery needs recharging.
<b>Delete Entry?</b>	Prompt asking you if you want to erase a Caller ID record.
<b>DELETED</b>	Confirms that a Caller ID record has been deleted.
<b>Delete ALL???</b>	Prompt asking you if you want to erase all Caller ID records.
<b>*** EMPTY***</b>	Space is available to store name and number in memory.
<b>Invalid CID</b>	Caller information has been interrupted during transmission or the phone is excessively noisy.
<b>OUT OF AREA</b>	The call comes from an area with no Caller ID service.
<b>OUT OF RANGE</b>	Your handset is too far from the base.
<b>PRIVATE</b>	The person is calling from a number that has been blocked from transmission.
<b>PHONE</b>	The TALK button has been pressed and there is a dial tone.
<b>01 : 29 VOL : ■■■■</b>	Shows phone has been turned ON for 1 minute and 29 seconds. Volume is at level 4.

## CALL WAITING DISPLAY

To utilize the full capabilities of this unit, you must have Caller ID with name and number delivery as well as Call Waiting Deluxe (Call Waiting with Caller ID) service installed. This unit will let you know when a call is waiting as well as who is calling before you answer.

This unit does not provide Caller ID and Call Waiting features unless services have been ordered from your local telephone company at a monthly charge. Check with your local telephone company to confirm both of these services are available. If you only have Caller ID service, this unit will not receive and display Call Waiting with Caller ID information.

1. When you receive a call waiting call, check the display to see who is calling.
2. Press the FLASH button to answer the call.
3. If you choose not to answer the call, the Call Waiting Caller ID information will be stored for future reference.
4. When you finish the call waiting call, press FLASH again to go back to the original call.



# FORMATTING LONG DISTANCE NUMBERS

## ENTERING LOCAL AREA CODE

**NOTE:** In order for the CALL BACK feature to operate properly, you MUST initially enter your local 3-digit area code.

1. Press REVIEW  $\wedge$  button.
2. Press “\*” button.
3. Enter the desired 3-digit area code.

You may need to add the area code (or 1+ area code) to some numbers in order to dial them.

1. Use the REVIEW buttons (  $\wedge$   $\vee$  ) to select the record you want to dial.
2. Use the FORMAT (#) button to scroll through the options:
  - Press FORMAT (#) once to add the area code (i.e. 123-456-7890)
  - Press FORMAT (#) again to add 1 plus the area code (i.e. 1-123-456-7890)
  - Press FORMAT (#) a third time to go back to the 7-digit number (i.e. 456-7890).
3. Press DIAL to dial the number.



# CHANGING THE BATTERY

---

Your cordless handset is powered by a nickel cadmium battery pack (#5-2419). The battery pack needs to be recharged periodically. A fully charged battery gives you approximately 4 hours of talk time or 7 days of stand-by time. Return the handset to the base whenever possible to keep the battery adequately charged.

The handset runs on a consumer-replaceable, nickel-cadmium battery pack. If you experience any of the following problems, you may need to replace the battery pack: short talk time, poor sound quality, limited range, CHARGE/IN USE light fails to light. Make sure phone is OFF before you replace battery.

1. Remove the battery compartment door.
2. Remove the battery pack.
3. Insert the new battery into the compartment on the back of the handset.
4. Replace the battery compartment door.
5. Return the handset to the base unit for at least 12 hours to adequately charge a new battery pack.

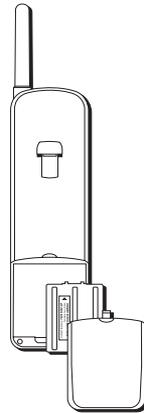

## BATTERY SAFETY PRECAUTIONS

- Don't disassemble, mutilate, puncture, wet, or dispose of battery in fire. Like other batteries of this type, if it is burned or punctured, it could release toxic materials which can cause injury.
- Keep batteries out of the reach of children.

**NOTE:** The RBRC seal on the battery used in your product indicates that we are participating in a program to collect and recycle Nickel Cadmium batteries throughout the United States of America. Please call 1-800-8-BATTERY for information or contact your local recycling center.





## GENERAL PRODUCT CARE

To keep your telephone working and looking good, follow these guidelines:

- Avoid putting the phone near heating appliances and devices that generate electrical noise (for example, motors or fluorescent lamps).
- DO NOT expose to direct sunlight or moisture.
- Avoid dropping the handset, as well as other rough treatment to the phone.
- Clean the phone with a soft cloth.
- Never use a strong cleaning agent or abrasive powder because this will damage the finish.
- Retain the original packaging in case you need to ship the phone at a later date.
- Periodically clean the charge contacts on the handset and base with a soft cloth.

## CAUSES OF POOR RECEPTION

- Aluminum siding.
- Foil backing on insulation.
- Heating ducts and other metal construction can shield radio signals.
- You're too close to appliances such as microwaves, stoves, computers, etc.
- Atmospheric conditions, such as strong storms.
- Base is installed in the basement or lower floor of the house.
- Base is plugged into an AC outlet with other electronic devices.
- Handset battery is low.
- You're out of range of the base.

## SERVICE

The FCC requires this product to be serviced only by the manufacturer or its authorized service agents. For instructions on how to obtain service, refer to the warranty included in this Guide.

Attach your sales receipt to the booklet for future reference or jot down the date this product was purchased or received as a gift. This information will be valuable if service should be required during the warranty period.

Purchase date \_\_\_\_\_ Name of store \_\_\_\_\_

# TROUBLESHOOTING GUIDE

---

In case of difficulty, please check the following Troubleshooting Guide before seeking service.

<i>Problem</i>	<i>Solution</i>
No dial tone	<ul style="list-style-type: none"><li>• Check installation:<ul style="list-style-type: none"><li>– Is the base power cord connected to a working outlet?</li><li>– Is the telephone line cord connected to the base unit and the wall jack?</li></ul></li><li>• Disconnect the base from the wall jack and connect another phone to the same jack. If there is no dial tone in the second phone, the problem might be your wiring or local service.</li><li>• Is the battery pack installed correctly?</li><li>• Did the handset beep when you pressed the TALK button? Did the TALK light come on? The battery may need to be charged.</li><li>• Make sure the battery is properly charged (12 hours).</li><li>• Is the handset out of range of the base? Move closer to the base unit.</li><li>• Place handset in base for 10 seconds to reset the phone.</li><li>• If the phone still does not work, disconnect the power cord and remove the battery pack. Then reconnect the power cord and reinstall the battery pack. Place handset in the base for 10 seconds to allow it to re-initialize.</li></ul>
Dial tone is OK, but can't dial out	<ul style="list-style-type: none"><li>• Make sure the TONE/PULSE switch on the base is set correctly.</li></ul>
Handset does not ring	<ul style="list-style-type: none"><li>• Make sure the RINGER ON/OFF switch on the handset is turned to ON.</li><li>• You may have too many extension phones on your line. Try unplugging some phones.</li><li>• See solutions for "No dial tone."</li></ul>

<i>Problem</i>	<i>Solution</i>
Cannot hear phone You experience noise, or fading in and out	<ul style="list-style-type: none"> <li>• Press VOLUME button on the handset.</li> <li>• Charge battery.</li> <li>• Is handset out of range? Move closer to the base.</li> <li>• Relocate the base unit away from TV's computers, micro waves or any other appliances or electronic devices that may cause interference.</li> <li>• Make sure base is not plugged into an outlet with another household appliance.</li> </ul>
Unit beeps	<ul style="list-style-type: none"> <li>• You may be receiving an out-of-range alert, move closer to the base.</li> <li>• Place handset in base for 10 seconds to reset the phone. The CHARGE/IN USE comes on when reset is successful.</li> <li>• Put handset in base for 12 hours to recharge battery.</li> <li>• Clean charging contacts on handset and base with a soft cloth or an eraser.</li> <li>• See solutions for "No dial tone."</li> <li>• Replace battery.</li> </ul>
Cannot hear the PAGE/FIND tone	<ul style="list-style-type: none"> <li>• Set the RINGER to ON.</li> </ul>
Range is shorter	<ul style="list-style-type: none"> <li>• Position the base antenna upward. than normal</li> </ul>
Battery will not hold a charge	<ul style="list-style-type: none"> <li>• Be sure you are sufficiently charging the battery. The battery should be charged for 12 hours.</li> <li>• Make sure battery contacts on both the handset and the base are making contact and are clean; free of dirt or lint.</li> <li>• When the handset is placed in the base, make sure that the base CHARGE/IN USE light is on.</li> </ul>
Memory Dialing does not work	<ul style="list-style-type: none"> <li>• Memory location must be 2 digits (i.e, 01,02, etc.).</li> <li>• Did you program the memory location keys correctly?</li> <li>• Did you follow proper dialing sequence?</li> <li>• Make sure TONE/PULSE switch is correctly set.</li> </ul>

# INDEX

---

## A

Adding a Pause When  
You Store a Number in  
Memory 13

## B

Battery 24  
Battery installation 6

## C

Call Waiting Display 22  
Caller ID 17  
    Call Waiting feature 22  
    Deleting a record 19  
    Dialing a Caller ID  
    record 18  
    Display 17  
    Reviewing records 18  
    Storing a record in  
    memory 18  
    Storing a record 14  
    VIP records 19  
        deleting 20  
        dialing 20  
        reviewing 20  
        storing 19

Caller ID Messages 21

Chain dialing stored  
numbers 16

Changing the Battery 24

## D

Deleting Caller ID records  
19

Deleting stored  
numbers 14, 15

Dialing a stored  
number 15

Digital Security  
System 4

## F

FCC Registration  
Information 2

Flash Button 10

## G

General Product Care 25

## H

Handset display 17

Handset Earpiece  
Volume 10

Handset Setup 6

Handset sound signals 16

Hearing Aid  
Compatibility 2

## I

Installation, desktop 7

Interference  
Information 2

## L

Limited Warranty 29

## M

Making a call 9

Memory Feature 12  
    Deleting a stored  
    number 14

    Storing a Caller ID  
    number 18

    Storing a Caller ID  
    record 14

Modular Jack  
Requirements 5

## P

Paging 11

Pause 13

Poor Reception 25

## R

Receiving a Call 9  
Redial 9

Ring Tone 10

Ringer Volume 10

## S

Selecting a Ring Tone 10  
Service 25

Stored number,  
deleting 14

Storing a caller ID record  
in memory 14

Storing a Number in  
Memory 12

Storing a Temporary Tone  
Number in Memory 14

## T

Talk light 9

Temporary Tone 11

Troubleshooting  
Guide 26

## V

VIP records 19

    Deleting 20

    Dialing 20

    Reviewing 20

    Storing 19

Volume, handset 10

## W

Wall Mount Installation 8

# LIMITED WARRANTY

---

## **What your warranty covers:**

- Any defect in materials or workmanship.

## **For how long after your purchase:**

- One year.

(The warranty for rental units begins with the first rental or 45 days from date of shipment to the rental firm, whichever comes first.)

## **What we will do:**

- Provide you with a new, or at our option, a refurbished unit.
- The exchange unit is under warranty for the remainder of the original product's warranty period.

## **How to make a warranty claim:**

- Properly pack your unit. Include any cables, etc., which were originally provided with the product. We recommend using the original carton and packing materials.
- Include in the package evidence of purchase date such as the bill of sale. Also print your name and address and a description of the defect.
- Pay any charges billed to you by the Exchange Center for service not covered by the warranty.
- A new or refurbished unit will be shipped to you prepaid freight.

## **What your warranty *does not* cover:**

- Customer instruction. (Your Owner's Manual provides information regarding operating instructions and user controls. For additional information, ask your dealer.)
- Installation and set-up service adjustments.
- Batteries.
- Damage from misuse or neglect.
- Products which have been modified or incorporated into other products.
- Products purchased or serviced outside the USA.
- Acts of God, such as but not limited to lightning damage.

## **Product Registration:**

- Please complete and mail the Product Registration Card packed with your unit. It will make it easier to contact you should it ever be necessary. The return of the card is not required for warranty coverage.

## **How state law relates to this warranty:**

- This warranty gives you specific legal rights, and you may have other rights which vary from state to state.

## **If you purchased your product outside the USA:**

- This warranty does not apply. Contact your dealer for warranty information.

Model 2-931SST  
20980590 (Rev. 3, E/S)  
98-52  
Printed in Thailand

## Free Manuals Download Website

<http://myh66.com>

<http://usermanuals.us>

<http://www.somanuals.com>

<http://www.4manuals.cc>

<http://www.manual-lib.com>

<http://www.404manual.com>

<http://www.luxmanual.com>

<http://aubethermostatmanual.com>

Golf course search by state

<http://golfingnear.com>

Email search by domain

<http://emailbydomain.com>

Auto manuals search

<http://auto.somanuals.com>

TV manuals search

<http://tv.somanuals.com>