



Precautions of Use

The quality of communication depends on the location and environment of the base and the handset. The **21828** must be kept away from sources of excessive heat (radiators, direct sunlight, etc.) and protected against vibrations and dust. Never allow your telephone to come into contact with water or other liquids or with aerosols. To reduce the risk of interference and optimize reception, take particular care to keep it away from the immediate vicinity of windows, large metal objects, reinforced concrete, televisions, music centres, halogen lamps or heating devices, fluorescent lighting, burglar alarms, microwave ovens, computers, etc.

To clean the **21828**, use a lightly moistened antistatic cloth

Information for DECT product:

The **21828** telephone is compliant with the DECTTM* standard. It is designed to transmit and receive telephone calls and be connected to the public telephone "Country" network.

*DECT is a trademark registered by ETSI.

Safety

In the event of danger, the main adaptor acts as 230V power isolating device. It should therefore, as a precaution, be installed close to the appliance and be easily accessible.

If the main adaptor fails, it must be replaced by an identical model.

If not connected to the main power or if there is a main power failure, installations with cordless handsets will no longer work. You will



then be unable to make or receive calls in the event of an emergency. This is why we recommend that you also have a conventional telephone as a backup. The appliance is designed for connection to an analogue telephone line class TRT3 (telecommunications network voltage).

! Do not use your telephone to notify a gas leak when you are in the vicinity of the leak.

It is recommended that you avoid using this device during electrical storms.

IMPORTANT: Because cordless phones operate on electricity, you should have one phone in your home that isn't cordless, in case the power in your home goes out.

WARNING:
TO PREVENT FIRE OR ELECTRICAL SHOCK HAZARD, DO NOT EXPOSE THIS PRODUCT TO RAIN OR MOISTURE.

 <p>THE LIGHTING FLASH AND ARROW HEAD WITHIN THE TRIANGLE IS A WARNING SIGN ALERTING YOU OF "DANGEROUS VOLTAGE" INSIDE THE PRODUCT.</p>	<p>CAUTION RISK OF ELECTRIC SHOCK DO NOT OPEN</p> <p>CAUTION: TO REDUCE THE RISK OF ELECTRICAL SHOCK, DO NOT REMOVE COVER (OR BACK). NO USER SERVICEABLE PARTS INSIDE. REFER SERVICING TO QUALIFIED SERVICE PERSONNEL.</p>	 <p>THE EXCLAMATION WITHIN THE TRIANGLE IS WARNING SIGN ALERTING YOU OF IMPORTANT INSTRUCTIONS ACCOMPANYING THE PRODUCT.</p>
<p>SEE MARKING ON BOTTOM / BACK OF PRODUCT</p>		

Battery Safety Precautions

- Do not burn, disassemble, mutilate, or puncture. Like other batteries of this type, toxic materials could be released which can cause injury.
- To reduce the risk of fire or personal injury, use only the battery listed in User's Guide.
- Keep batteries out of children.
- Remove batteries if storing over 30 days.

 **CAUTION:** Danger of explosion if battery is incorrectly replaced. Replace only with GP60AAAHC – NiMH 1.2V 600mAh rechargeable battery or equivalent. Only use rechargeable batteries with exactly the same specifications as those supplied with the product. Using non-rechargeable or non-conforming batteries can damage the product. The batteries could split or leak if incorrectly inserted, opened or exposed to heat. Never dispose of batteries in a fire: the cell could explode. Check with local code for possible special disposal instruction.

Installation

Packaging Contents

Model name: 21828

	Solo	Duo		
Base stations	1	1		
Handsets	1	2		
Power plugs	1	2		
Telephone line	1	1		
Batteries, type AAA, "1.2V 600mAh"	2	4		
Charging station	0	1		
Operating instructions	1 + optional	1 + optional		

Please check the contents of the package carefully. If anything is missing or shows signs of transport damage, do NOT put the telephone into service! In such a case, contact either your sales outlet with the purchase receipt.

Note: Keep the equipment package so that it will not be damaged in the event of transport.

Connecting the Base Station and Power Plug

Connecting the plugs to the corresponding sockets in the base station (they can not be connected incorrectly because the sockets and plugs are designed prevent reverse poling). Lay the cable under the telephone to the rear. Plug the telephone line in the telephone connection socket. Insert the power plug at the other end in the power outlet. The base station is now ready to operate.

Only use the connection cable supplied.

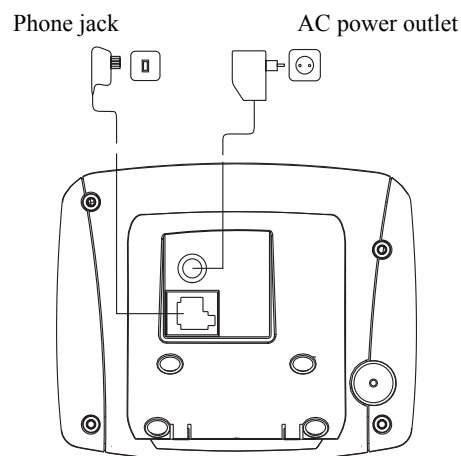

CAUTION:

Plug the adaptor to the socket outlet that near the equipment and shall be easily accessible. Use only the ATLINKS power supply that came with this unit. Using other power supplies may damage the unit.

Connecting the charging station

Insert the power plug in the socket on the rear side of the charging station. Insert the power plug at the other end in the power outlet. The charging station is now ready to operate.

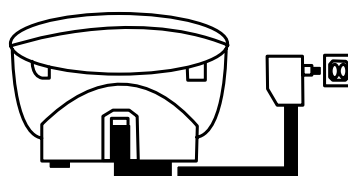

AC power outlet

Getting Started

- Install and Charge the Battery Pack

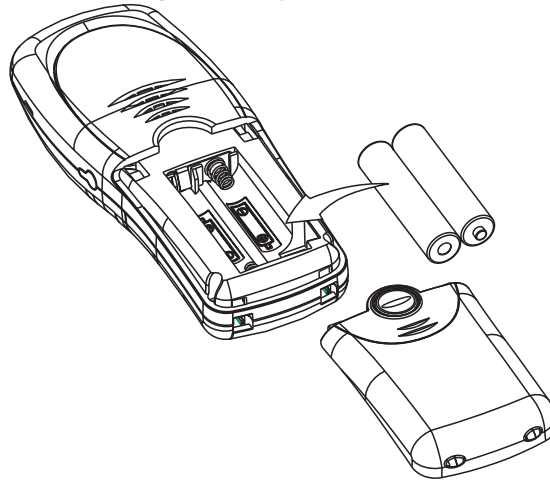

Insert two pieces AAA batteries in the compartment, ensuring correct polarity and close the compartment.

- Place the handset in the base station to charge for 14 hours prior for first use. If you don't properly charge the phone, battery performance will be compromised.

Warning: The handset does not work and damaged if the wrong batteries are inserted.

Features

We are very pleased that you have purchased this highly sophisticated, cordless telephone which is equipped with the following features:

- Digital cordless telephone complying to DECT* standards
- 10 MMI menu language
- Teleconference
- Call forwarding
- Internal, free communication between handsets
- Prefix dialing
- Automatic call answering on/off
- Call log function with caller list for 20 numbers or names from phone book (network dependent)
- Alphanumeric LC display (7 segment, 10 segment display)
- Phone book for 30 entries with name and call number
- Extended redialing for 5 call numbers
- Microphone muting function
- Acoustic battery and range warning signals
- Key lock
- Key input tone on/off
- 10 incoming call ringing melodies
- Ringing volume control (5 levels and silent)
- DTMF/Pulse dialing
- Operation of up to 4 handsets
- Paging function from base station to handset
- Programmable number barring
- Up to 100 hours standby
- Up to 10 hours continuous call time
- Operation with 2 standard AAA batteries (Ni-MH)
- Adjustable flash time

* DECT = Digital Enhanced Cordless Telecommunication = Standard for Cordless Telephones.

Menu Structure (Handset)

1 CALL LOG

2 PHONE BOOK	1 NEW ENTRY	ENTER NO	ENTER NAME	NORMAL RING
	2 LIST ENTRY			VIP RING 1-10
	3 EDIT ENTRY			
	4 DELETE			
	5 DELETE ALL	CONFIRM?		

		VOLUME	[-----]
3 HANDSET	1 RINGER	EXT RINGER	MELODY 1-10
		INT RINGER	MELODY 1-10
	2 HS NAME		
	3 PREFIX MEM		
	4 KEY TONE	ON/OFF	
	5 AUTO ANS	ON/OFF	
	6 CALL TIMER	ON/OFF	
	7 DEFAULT	CONFIRM?	
	8 REGISTER	SEARCHING	

4 BASE	1 BARRING	ENTER PIN	HANDSET1,.....	DISABLE
	2 EMERGENCY	ENTER PIN	1	EXTERNAL
			2	NUMBER ENTER NO
	3 RINGER	[-----]	MELODY	
			1-10	
	4 FLASH TIME	100/300/600		
	5 DIAL MODE	TONE		
		PULSE		
	6 CHANGE PIN	ENTER PIN	NEW PIN	REPEAT
	7 DEFAULT	ENTER PIN	CONFIRM?	
	8 Deregister	ENTER PIN	HANDSET1,.....	CONFIRM?

5 LANGUAGE	ENGLISH
	DEUTSCH
	ITALIANO
	FRANCAIS
	ESPANOL
	PORTUGUES
	NEDERLAND
	POLSKI
	SVENSKA
	TURKCE

Handset and Base Layouts

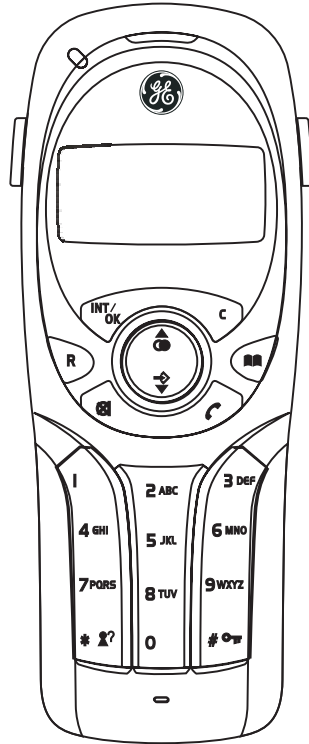



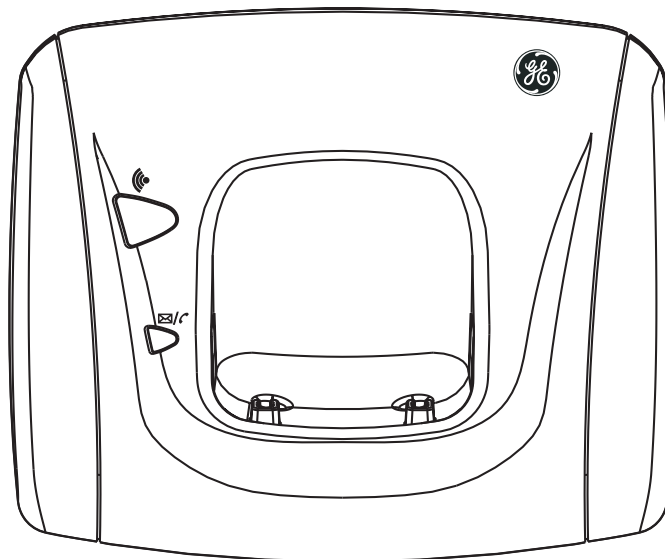



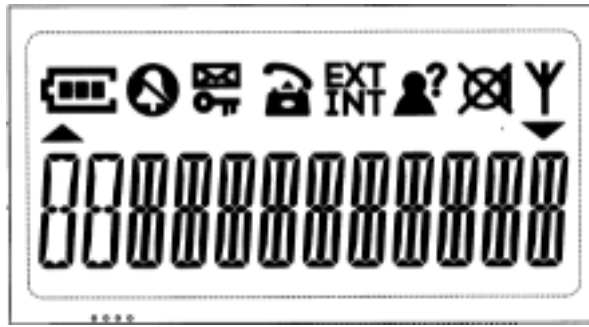

	Menu / down key
	CID key / Asterisk key
INT / OK	INT / OK key
C	Cancel
	Mute key
	Redial / Pause key / Up key
	External call key.
	Phone book key
R	Flash key
# /	Hash key / lock key



	Paging
	In-use / CID LED: Steady Flash: OFF-hook / Voice Mail Waiting Indicator (VMWI)

LCD Display



	Battery icon
	Phone icon
EXT	External call icon
INT	Internal call icon
	CLI icon
	No ring icon
	Mute icon
	Key lock icon
	Aerial icon
▲ / ▼	Up / Down arrow
	Voice mail waiting indicator (VMWI icon)

Using the Handset Telephone

Using the telephone

- When the handset is inserted in the station charging unit, it starts to charge automatically. To optimize the battery performance, charge the handset battery for 14 hours prefer to first use.

Note: This phone defaults to Tone Dialing. To change Pulse Dialing, see chapter “Base Station Settings – Changing the Dialing Mode”. If you don’t know which type of service you have, please check with the local telephone company.

Selecting the Language

Ten different languages are available for selection for each handset.

- In standby mode, press ▼ button and “5” key. Current language is displayed.
- Press ▼ or ▲ as often as necessary to select the required language.
- Press “INT/OK” key to confirm the selection.

Note: The following languages are available:

**ENGLISH; DEUTSCH; ITALIANO; FRANCAIS;
ESPANOL; PORTUGUES; NEDERLANDS; POLSKI;
SVENSKA; TURKCE**

Making Internal Calls

IMPORTANT: Internal calls can be made only if more than one handset is registered on the base station.

- Press “INT/OK” key.
- Press the number of the required handset (1...). Carry out the conversation.
- Press  key to end the call.

Note: If an external call is received during an internal call, short acoustic signals are issued (call waiting).



Making External Calls

Direct dialing

- Press  key and wait for a dialing tone.
- Dial the telephone number and complete the call.

- Press  key to end the call.

On hook dialing

- Dial the telephone number (delete any incorrect entries by pressing “C” key).
- Press  key to carry out the conversation.
- Press  key to end the call.

VMWI/LED



The VMWI/LED in the handset will flash when there are new voice message calls received. Icon  turns on and the LCD display “Message” in the call log memory.

This service need subscription to local operator and it supports the FSK CLI system only.



Taking Calls

When an external call is received, all registered handsets and the base station ring. EXT flashes in the handset display and, if configured, the telephone number of the caller appears (network depended). If the caller has been entered in your phone book, the name appears. The incoming call VMWI/LED on the base station flashes. In the case of an internal call or on pressing the paging key on the base station, INT flashes in the handset display.

Handset is in the base station





- Take the handset from the base station; a connection is automatically established (when the AUTO ANS function is active). Otherwise, press  key.
- Carry out the conversation.
- Press  key to end the call.

Handset is not in the base station





- Press  key. Carry out the conversation.
- Press  key to end the call.

Redialing

The phone stores the last five numbers dialed in the redial memory

- Press  key; the last call number dialed is displayed. Press  or  key to search the required number in the redial memory list.
- Press  key to carry out the conversation.
- Press  key to end the call.

Dialing from the Phone Book

- Press  key; the first entry in the phone book appears. (Or “MEM EMPTY” if no entry)
- Press  or  key to select the required subscriber from the phone book. Alternatively, enter the first letter of the name required.
- Press  key. The number is dialed. Carry out the conversation.

Note: How to store entries in the phone book is explained in the Chapter “Phone Book”.



Call Log Operations

IMPORTANT: To use the “Call Log” function, you must subscribe to your network operator’s Caller Line Identification (CLI) service.

Browse, Call Back, Delete, Save

If calls have been received in your absence, these are stored in the CALL LOG memory when your telephone service has enabled this function. The number of calls appears in the display. Incoming calls are also indicated in the display for 10 seconds during a call.



- Press  key as often as necessary until CALL LOG menu appears. Alternatively, press and hold “*” key. Then press “INT/OK” key.

- Browse: Press  or  key to browse through the CALL LOG memory.

Or

- Call Back: Press  key to call back.

Or

- Delete: Press or hold “C” key two seconds to delete one or all the entries. Selection is made using  or  key.

Or

- Save: Press  key to enter the subscribers in the phone book. Enter the name and press “INT/OK” key.

Note: 1. The CALL LOG symbol and display indicator only disappear after browsing through all the entries.

2. It is only possible to enter subscribers in the phone book who are not already entered.

Muting the Microphone

- Press  key to switch the microphone on or off during a call.

Holding Calls / Forwarding Calls

If the telephone is connected to a PABX system, it is possible to put calls on hold and call other extension lines or to forward calls.

- Press “R” key to put the call on hold and dial the extension number (e.g. 23).
- Press “R” key once more to take the call back again or press  key to forward the call.

Note: If several handsets are registered on the base station and a call should be put on hold or forwarded, press “INT/OK” key instead of “R”.



Note: The above information can vary according to the PABX system used. Therefore, refer to the relevant information of the PABX network.

Teleconference

After have received an external call, it is possible to include a second handset in the conversation (three way conference).

- Press “INT/OK” key and enter the number of the corresponding handset (e.g. 2) which will join the teleconference.
- The external caller is kept on hold. As soon as the other handset takes the call, press and hold “#” key 2 seconds to activate the teleconference.
- By pressing  key, any of the handsets quit from the teleconference and the other handset continues with the external call.

Changing the Receiver Volume

- Press  or  key to change the receiver volume during a call.

Paging the Handset

If a handset has been misplaced, it is possible to call all the handsets.

- Short press “page” key on the base station.

Entering a Dialing Pause (P)

If the telephone is connected to a PABX system, it may be necessary to insert a dialing pause. To do this, press  key after entering the relevant digit in the pre-dial buffer, e.g. 0, for an outside line (0P...). A “P” appears in the display indicating a pause. The pause can also be entered when programming numbers in the phone book.

Switching the Key Lock On/Off

Incoming calls can still be received when key locked.

- Press and hold “#” key for 2 seconds to activate or deactivate the key lock.

Phone Book

The telephone can store up to 30 entries in the phone book with name and call number. When the function is supported by the telephone provider service and the caller, the handset displays the name of the caller (when stored in the phone book).

Store Entries

- Press ▼ key until the PHONE BOOK menu appears and press “INT/OK” key.
- Press ▲ or ▼ key to select “NEW ENTRY” and press “INT/OK” key.
- Enter number (max. 25 digits) and press “INT/OK” key when finished.
- Enter name (max. 10 characters) and press “INT/OK” key when finished.
- Select the ringing tone with ▲ or ▼ key and press “INT/OK” key when finished.
- “MEM FULL” appear stand for memory full.

List Entries / Edit Entries / Delete Entries

- Press ▼ key until the PHONE BOOK menu appears and press “INT/OK” key.
- Press ▲ or ▼ key to select submenu and press “INT/OK” key.
- Press ▲ or ▼ key to scroll through the phone book. Alternatively, enter the first letter of the name required.
- If editing, edit the number and name (using “C” for deleting). Press “INT/OK” key when finished.

Handset Settings

Changing the Ringing Volume

- Press ▼ key until the HANDSET menu appears and Press “INT/OK” key three times.
- Press ▲ or ▼ key to select the required volume and Press “INT/OK” key.
- Note: The ringer volume can be heard at different volumes. If the ringer symbol appears as non dotted line, the ringing volume will be switched to OFF.

Changing the Ringer Melody (external / internal)

- Press ▼ key until the HANDSET menu appears and Press “INT/OK” key twice.
- Use ▲ or ▼ key to select the required submenu (EXT RINGER or INT RINGER) and press “INT/OK” key.
- Use ▲ or ▼ key to select the required melody (1-10) and press “INT/OK” key to confirm.

Entering/Changing Handset Name

It is possible to assign a name to each handset. This name is then displayed when the phone is in standby mode.

- Press ▼ key until the HANDSET menu appears and press “INT/OK” key.
- Press ▲ or ▼ key to select the submenu and press “INT/OK” key.
- Enter/change the name of the handset (e.g. MOBIL 1) and press “INT/OK” key to confirm.

Switching the Key Tone On/Off

- Press ▼ key as often as necessary until the HANDSET menu appears and press “INT/OK” key.
- Press ▲ or ▼ key to select the submenu and press “INT/OK” key.
- Press ▲ or ▼ key to select the setting and press “INT/OK” key to confirm.

Saving a Prefix

It is possible to save prefix numbers in the handset. This number is then recalled after pressing and hold “0” key for two seconds.

- Press ▼ key as often as necessary until the HANDSET menu appears and press “INT/OK” key.
- Press ▲ or ▼ key to select the submenu and press “INT/OK” key.

- Enter prefix number (e.g. access code of the subscriber you call most frequently).
- Press “INT/OK” key to confirm.

Activating/Deactivating Automatic Call

Answering

The automatic call answering function enables the incoming call to be taken immediately when the handset is removed from the base station.

- Press ▼ key as often as necessary until the HANDSET menu appears and press “INT/OK” key.
- Press ▲ or ▼ key to select the submenu and press “INT/OK” key.
- Use ▲ or ▼ key to switch automatic call answering on or off and press “INT/OK” key to confirm the input.
- Press “INT/OK” key to confirm.

Activating/Deactivating Call Timer

It is possible to display the call duration of a call on the handset. The timer starts when the conversation begins.

- Press ▼ key as often as necessary until the HANDSET menu appears and press “INT/OK” key.
- Press ▲ or ▼ key to select the submenu and press “INT/OK” key.
- Use ▲ or ▼ key to switch the call timer on or off and press “INT/OK” key to confirm.

Default Settings

The handsets can be reset to the default settings. In doing so, all the settings which you have changed are returned to their default values. The phone book entries are retained.

- Press ▼ key until the HANDSET menu appears and press “INT/OK” key.
- Press ▲ or ▼ key to select the submenu and press “INT/OK” key to confirm.

Note: The display will switch back to standby mode.

Key assignment Overview

1	SPACE, 1	7	P, Q, R, S, 7
2	A, B, C, 2	8	T, U, V, 8
3	D, E, F, 3	9	W, X, Y, Z, 9
4	G, H, I, 4	0	+, -, 0
5	J, K, L, 5	*	[,], U
6	M, N, O, 6	#	?, :, .

Registering Additional Handsets

Further handset of the same model can be registered on one base station.

- Press ▼ key until the HANDSET menu appears and press “INT/OK” key.
- Press ▲ or ▼ key to select the submenu “REGISTER” and press “INT/OK” key.
- Handset display shows “SEARCHING”.
- Press and hold “page” key on the base station more than 4 seconds until acknowledgement signal is heard.
- Enter the PIN (default setting = 0000) and press “INT/OK” key.

Note: After the connection has been established, the name and number of the handset (the next available handset number should be 2) appear in the display.

The base will be ready for registration for 10 minutes when the page key is pressed and hold for more than 4 seconds. After selecting “REGISTER”, the handset starts searching for a base station which is available for registration. The “Aerial” icon starts flashing.

If a base is found, user will be asked to enter the PIN for that base. If the input PIN is correct, the registration procedure will be completed with a confirm tone

Base Station Settings (using the Handset)

Barring Calls

The following options are available for selection for barring calls:

Option	Description
DISABLE	All telephone calls are possible.
EXTERNAL	All external calls are barred.
NUMBER	Define a number which should be barred, e.g. 0190

- Press ▼ key until the BASE menu appears and press “INT/OK” key.
- Press ▲ or ▼ key to select the required submenu and press “INT/OK” key.
- Enter the PIN (factory setting is 0000) and press “INT/OK” key.
- Use ▲ or ▼ key to select the handset which should be barred and press “INT/OK” key.
- Use ▲ or ▼ key to select an option and press “INT/OK” key.

Entering/Changing Emergency Number

Emergency numbers are free of any restriction, i.e. they can still be called even if call barring of any kind is set.

Before emergency numbers can be used, they must be stored. The emergency numbers can then be dialed manually or from the phone book if they are stored there.

Two different emergency numbers (maximum of five digits) can be programmed. Example: three digit emergency number = 123. All numbers which begin with 123 are dialed even if the unit is only programmed for internal calls.

- Press ▼ key until the BASE menu appears and press “INT/OK” key.
- Press ▲ or ▼ key to select the required submenu and press “INT/OK” key.
- Enter the PIN (factory setting = 0000) and press “INT/OK” key.
- Use ▲ or ▼ key to select the emergency number to be changed and change it.
- Press “INT/OK” key.

Note: Save the emergency numbers in the phone book, too (refer to chapter “Phone Book”), e.g. with self explanatory names such as “Doctor” or “Fire”. If these numbers should be positioned at the top of the phone book list in the display, enter a space preceding the name “DOC” and “FIRE”.

Ringer

- Press ▼ key until the BASE menu appears and Press “INT/OK” key.
- Press ▲ or ▼ key to select the required submenu and Press “INT/OK” key.
- Press ▲ or ▼ key to select the ringer volume and Press “INT/OK” key.
- Press ▲ or ▼ key to select the ringing melody and Press “INT/OK” key.

Changing the Flash Time

- Press ▼ key until the BASE menu appears and press “INT/OK” key.
- Press ▲ or ▼ key to select the required submenu and press “INT/OK” key.
- Press ▲ or ▼ key to select the required flash time and press “INT/OK” key.

Changing the Dialing Mode

- Press ▼ key until the BASE menu appears and press “INT/OK” key.

- Press \blacktriangle or \blacktriangledown key to select the required submenu and press “INT/OK” key.
- Press \blacktriangle or \blacktriangledown key to select the required dialing mode and press “INT/OK” key.

Note: This Flash Time / Dialing mode is used only when dialing from handset. Use the Base switch when dialing from Base.

Changing the PIN

- Press \blacktriangledown key until the BASE menu appears and press “INT/OK” key.
- Press \blacktriangle or \blacktriangledown key to select the required submenu and press “INT/OK” key.
- Enter old PIN (0000) and press “INT/OK” key.
- Enter new PIN (e.g. 1111) and press “INT/OK” key.
- Enter new PIN again (e.g. 1111) and press “INT/OK” key to confirm.

Default Settings

- Press \blacktriangledown key until the BASE menu appears and press “INT/OK” key.
- Press \blacktriangle or \blacktriangledown key to select the required submenu and press “INT/OK” key.
- Enter the PIN (factory setting = 0000) and press “INT/OK” key.
- Press “INT/OK” key to confirm.

Deregister HS

If several handsets are registered on one base station, they can deregister each other mutually. The last handset can not be deregistered.

- Press \blacktriangledown key until the BASE menu appears and press “INT/OK” key.
- Press \blacktriangle or \blacktriangledown key to select the required submenu and press “INT/OK” key.
- Enter the PIN (factory setting = 0000) and press “INT/OK” key.
- If necessary, Use \blacktriangle or \blacktriangledown key to select the handset and press “INT/OK” key.
- Press “INT/OK” key to confirm.

Technical Specifications

Handset Operating Time: (average values*)	Approx. 10 hours talk time Approx. 100 hours standby
AC / DC Adaptor	3515-0635-ADC Input: 230V AC / 50 Hz Output: 6V DC, 350mA Single-phase AC excluding IT installations defined by the EN 60950 standard. Caution: the network voltage is classified as a hazard by the criteria of this standard.
AC / AC Adaptor (for Handset charging)	3515-0720-AAC Input: 230V AC / 50 Hz Output: 7V AC, 200mA Single-phase AC excluding IT installations defined by the EN 60950 standard. Caution: the network voltage is classified as a hazard by the criteria of this standard.
Telephone connection	Appliance designed for connection to an analogue telephone line class TNV3 (telecommunications network voltage) as defined by the EN 60950 standard.
Rechargeable Battery	GP60AAAHC, 1.2V / 600mAh / Ni-MH, AAA x 2 or equivalent
Operating Temperature:	0 to 45 °C

* For guidance only, depends on initial battery charge.

General Product Care

Simply wipe the base station with a damp cloth or an antistatic wipe. Never use a dry cloth as this can cause static discharge.

Troubleshooting Guide

When you forget base PIN, following the procedure to Reset the units. **ALL MEMORY AND SETTING WILL BE LOST.**

- Refer to handset – Call Log Operation procedure, select **DELETE ALL** to delete all Call Log Memories in handset.
- Disconnect the line cord and AC power supply.
- Hold “PAGE” button and plug in the AC power supply.
- When a Beep tone heard and in-use LED turns On, release “PAGE” button. Press “PAGE” button three times again.
- The In-Use LED will turn Off.
- The unit will return to its default setting a PIN code (0000).
- Unplug AC power of base station and plug in again, handset LCD will display “----”.
- Following “Registering Additional Handsets” to register all handsets again.

PROBLEMS	CAUSES	SOLUTIONS
Registration not work.	The battery is not sufficiently charged.	Charge the battery for 14 hours (see Battery Charging).
	Handset and base station were not prepare for registration.	Unplug and then plug in the power adaptor.
No display.	The battery has not been charged.	Charge the battery or replace them (see Battery Charging)
No reactions to keystroke.	The keypad is locked.	Press * key longer than 2 seconds.
No radio connection to the base station: blinking!	The handset is outside the base station range.	Move closer to the base station.
	The handset is not registered.	Register the handset (see Registering Handset).
	The base station does not work.	Unplug and then plug the power adaptor to the power outlet (220-230V AC / 50 Hz) and the other end into the power jack on base bottom.

Environment



Used equipment and used handset batteries must be disposed of in compliance with current environmental protection regulations. You should return them to your reseller or dispose of them at an approved recycling centre.

Do not attempt to open the batteries, as they contain chemical substance. In the event of leakage, avoid contact with the skin, eyes and mouth. In the event of contact, rinse the affected part for several minutes in running water. Clean the product with absorbent paper or a dry cloth and contact your reseller for replacement batteries.

Model: FS21828
00006822 (Rev. 1 E)
05-34
Printed in China

Free Manuals Download Website

<http://myh66.com>

<http://usermanuals.us>

<http://www.somanuals.com>

<http://www.4manuals.cc>

<http://www.manual-lib.com>

<http://www.404manual.com>

<http://www.luxmanual.com>

<http://aubethermostatmanual.com>

Golf course search by state

<http://golfingnear.com>

Email search by domain

<http://emailbydomain.com>

Auto manuals search

<http://auto.somanuals.com>

TV manuals search

<http://tv.somanuals.com>