



GE1100P

DVD User's Guide



We bring good things to life.

CAUTION

RISK OF ELECTRIC SHOCK
DO NOT OPEN

**TO REDUCE THE RISK OF ELECTRIC SHOCK,
DO NOT REMOVE THE COVER (OR BACK).
NO USER-SERVICEABLE PARTS ARE INSIDE.
REFER SERVICING TO QUALIFIED SERVICE
PERSONNEL.**



This symbol indicates "dangerous voltage" inside the product that presents a risk of electric shock or personal injury.



This symbol indicates important instructions accompanying the product.

CAUTION: DVD PLAYERS USE A VISIBLE LASER BEAM WHICH COULD CAUSE HAZARDOUS RADIATION EXPOSURE IF DIRECTED. BE SURE TO OPERATE THE PLAYER CORRECTLY AS INSTRUCTED.

WARNING

To reduce the risk of fire or shock hazard, do not expose this DVD player to rain or moisture.

CAUTION

THIS PRODUCT UTILIZES A LASER. USE OF CONTROLS OR ADJUSTMENTS OR PERFORMANCE OF PROCEDURES OTHER THAN THOSE SPECIFIED HEREIN MAY RESULT IN HAZARDOUS RADIATION EXPOSURE. DO NOT OPEN COVERS AND DO NOT REPAIR YOURSELF. REFER SERVICING TO QUALIFIED PERSONNEL.

CAUTIONS

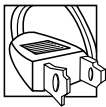

Caution: To prevent electric shock, match wide blade of plug to wide slot, fully insert.

Attention: Pour éviter les chocs électriques, introduire la lame la plus large de la fiche dans la borne correspondante de la prise et pousser jusqu'au fond.

This product satisfies FCC regulations when shielded cables and connectors are used to connect the unit to other equipment. To prevent electromagnetic interference with electric appliances, such as radios and televisions, use shielded cables and connectors for connections.

FCC NOTE (for U.S.A.):

This equipment has been tested and found to comply with the limits for a Class B digital device, pursuant to Part 15 of the FCC rules. These limits are designed to provide reasonable protection against harmful interference in a residential installation. This equipment generates, uses and can radiate radio frequency energy and, if not installed and used in accordance with the instructions, may cause harmful interference to radio communications. However, there is no guarantee that interference will not occur in a particular installation. If this equipment does cause harmful interference to radio or television reception, which can be determined by turning the equipment off and on, the user is encouraged to try to correct the interference by one or more of the following measures.

- Reorient or relocate the receiving antenna.
- Increase the separation between the equipment and receiver.
- Connect this equipment into an outlet on a circuit different from that to which the receiver is connected.
- Consult the dealer or an experienced radio/TV technician for help.

This class B digital apparatus meets all requirements of the Canadian Interference--Causing Equipment Regulations.

Note:

This unit can be used only where the power supply is AC 120 V, 50-60Hz. It cannot be used elsewhere.

Note:

This DVD player is designed and manufactured to respond to the Locale Management Information. If the Locale number of a DVD disc does not correspond to the Locale number of this DVD player, this DVD player cannot play the disc. The Locale number for this DVD player is Locale #1.

Note:

This device is protected by U.S. patent numbers 4,631,603 and 4,577,216 and 4,819,098 and other intellectual property rights. The use of Macrovision's copy protection technology in the device must be authorized by Macrovision and is intended for home and other limited pay-per-view uses only, unless otherwise authorized in writing by Macrovision. Reverse engineering or disassembly is prohibited.

Product Registration

Please fill out the product registration card and return it immediately. Returning this card allows us to contact you if needed.

Keep your sales receipt to obtain warranty parts and service and for proof of purchase. Attach it here and record the serial number in case you need it. The number is located on the back of the player.

Model No. **GE1100P** _____

Serial No. _____

Purchase Date: _____

Dealer/Address/Phone: _____

**CLASS 1
LASER
PRODUCT**

TABLE OF CONTENTS

| | |
|--|-----------|
| Before You Begin | 3 |
| A Short Glossary of DVD Terminology | 4 |
| A Quick Tour of the Remote | 4 |
| Installing Batteries in the Remote | 6 |
| Important Battery Information | 6 |
| Types of Discs that the Player Can Play | 6 |
| Connections | 7 |
| Jacks and Cables | 8 |
| Choosing a Connection | 9 |
| DVD Player + TV without A/V Input Jacks | 10 |
| DVD Player + TV with A/V Input Jacks | 11 |
| DVD Player + TV + Dolby Digital Receiver | 12 |
| DVD Player + TV + VCR | 13 |
| Connect the AC Power Cord | 14 |
| Setting Up the Menu Languages | 14 |
| Other Language Options | 14 |
| Menu System Navigation Tool | 14 |
| Playing DVDs | 15 |
| Loading and Playing a DVD | 16 |
| DVD Playback Features | 17 |
| Chapter Scan | 17 |
| Fast Motion Playback (Picture Scan) | 17 |
| Freeze Frame and Frame Advance | 17 |
| Slow Motion Playback (In Freeze Frame Mode) | 17 |
| Repeating Play | 18 |
| Selecting Specific Scenes on a DVD | 18 |
| Selecting a Title Number | 18 |
| Selecting a Chapter Number | 18 |
| Using the Elapsed Time | 19 |
| Selecting a Title Using the TITLE Button | 20 |
| Using a DVD's Author Menu | 20 |
| Using the Subtitle Feature | 21 |
| Changing the Subtitle Language (On the Player) | 21 |
| Changing the Audio Language | 22 |
| Changing the Camera Angle | 22 |
| Using the Marker Feature | 22 |
| Storing a Marker During DVD Playback | 23 |
| Playing a Marked Part | 23 |
| Clearing a Marker | 24 |
| Playing Karaoke Discs | 24 |

TABLE OF CONTENTS

| | |
|---|-----------|
| Playing Audio CDs | 25 |
| Loading and Playing an Audio CD | 26 |
| Audio CD Playback Features | 26 |
| Skipping Tracks | 26 |
| Repeating Play | 27 |
| Selecting a Specific Track | 27 |
| Program Playback | 28 |
| Deleting Programmed Tracks | 28 |
| | |
| Playing Video CDs | 29 |
| Loading and Playing a Video CD | 30 |
| If the Video CD Has Playback Control | 30 |
| Bypassing Playback Control | 31 |
| Video CD Playback Features | 31 |
| Skipping Tracks | 31 |
| Repeating Play | 32 |
| Selecting a Specific Track | 32 |
| Program Playback | 33 |
| Changing the Audio Channel Output | 33 |
| Program Playback With Playback Control | 34 |
| Deleting Programmed Tracks | 34 |
| Setting Up the Rating Level | 36 |
| Unlocking the Rating Level | 37 |
| Selecting the Initial Audio Language | 37 |
| Selecting the Initial Subtitle Language | 38 |
| Selecting the TV Screen Setting | 40 |
| Turning the On-Screen Messages | |
| Feature On or Off | 41 |
| Changing the Menu Language | 42 |
| | |
| Reference | 46 |
| Front Panel Controls | 46 |
| Front Panel Messages | 46 |
| Front Panel Display | 47 |
| Back Panel | 47 |
| Handling Cautions | 49 |
| Limited Warranty | 50 |
| Index | 53 |

BEFORE YOU BEGIN

There's Always a Catch

Because DVD is a new technology, we recommend that you take some time right now to read through this manual and familiarize yourself with the player.

I Know, You Really Want to Get Going

I know that you'd rather use your DVD player than read about it, so I've divided this manual up into sections that address how to use each type of disc that you can play on your player: DVDs, Audio CDs, and Video CDs. So, you don't have to read all of the book at once.

Read the First Two Sections First

The first two sections, "Before You Begin" and "Connections" include key information to get you started in the right direction. I suggest that you read at least these two sections before you do anything; then you can go back to the sections that discuss the features as you want to use them.

A Note about the Illustrations

The illustrations in this book are representational, and in some instances may not exactly match the item represented.

BEFORE YOU BEGIN

A Short Glossary of DVD Terminology

Angles When making a DVD, the studio can incorporate various camera angles which you can select by using the ANGLE button on the remote. Note that not all DVDs contain multiple camera angles.

Author Menu The Author menu is the menu on a disc that allows you to change settings for that disc. We call it the "author" menu because its features are "authored" by the maker of the disc, and may vary from disc to disc.

Chapter Each *Title* on a DVD can be divided into chapters (similar to tracks on an audio CD).

Dolby Digital* If you have a Dolby Pro Logic Surround decoder, you will obtain the full benefit of Pro Logic from the same DVD movies that provide full 5.1-channel Dolby Digital soundtracks, as well as from titles with the Dolby Surround mark.

Title A DVD may contain several different titles, for example if a disc contains four different movies, each might be considered a title (and each may have several *Chapters* within it).

Subtitling Because so much information can be stored on a DVD, many discs may contain foreign language subtitles.

A Quick Tour of the Remote

(Buttons Listed in Alphabetical Order)

ANGLE Use this button to access various camera angles on a DVD (if the DVD contains multiple camera angles).

ARROWS Use the arrows to navigate through the menu system of both the DVD player and the DVD discs. Use SELECT to choose a highlighted option.

AUDIO Use this button to access various audio streams on a disc (if the disc contains multiple audio streams).

CLEAR Allows you to clear information, for example to delete a marker that you have set.

DIGITS (0-9) Use the digit keys to input information such as chapter numbers, track numbers, or to make selections on some menu screens.

FWD Allows you to search forward through a disc while it is in play mode (or slow speed search in pause mode).

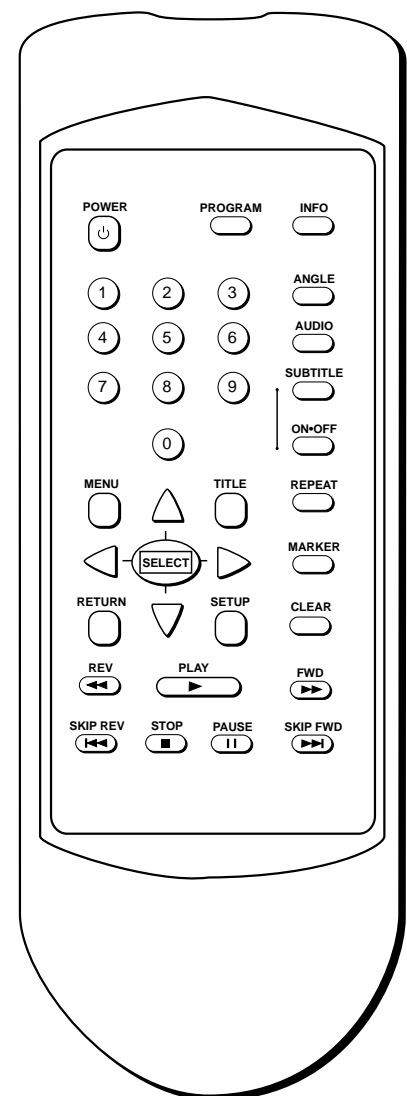

* Dolby Digital is a trademark of Dolby Laboratories Licensing Corporation

BEFORE YOU BEGIN

INFO Displays information about the disc, such as the available titles, and lets you choose which title you want to view.

MARKER Allows you to select (or “mark”) places on a disc so that you can quickly find them.

MENU Brings up the main menu of the DVD disc. The information you see will vary from disc to disc, and some discs may contain no menu at all.

ON•OFF Turns the subtitling feature on and off. To select a language option for subtitles, you need to use the **SUBTITLE** button.

PAUSE Pauses disc play.

PLAY Begins disc play (and closes disc tray, if open).

POWER Turns on power when the unit is in standby mode; or puts the unit in standby mode when power is on.

PROGRAM Allows you to program the order in which tracks are played during audio CD playback.

REPEAT Allows you to repeat the play of a Title, Chapter, or Track.

RETURN While using the on-screen menu system, takes you to the preceding menu screen.

REV Allows you to search backward through a disc while it is in play mode (or slow speed search in pause mode).

SELECT Use **SELECT** to choose a highlighted option.

SETUP Brings up the DVD player’s Setup menu.

SUBTITLE Allows you to temporarily change the language preference for the subtitle feature.

SKIP FWD Allows you move to the beginning of the next chapter or track on a disc (in effect, “skipping” the chapter or track).

SKIP REV Allows you move to the beginning of the preceding chapter or track on a disc (in effect, “skipping” the chapter or track).

STOP Stops disc play.

TITLE Allows you to see the Titles that are available on the current DVD disc (if the disc contains a title menu).

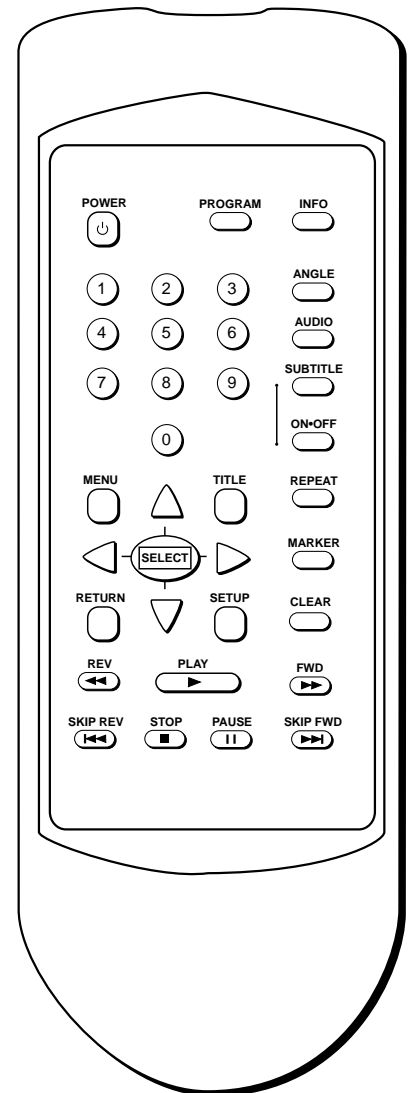

When **!** or **!!** appears on-screen, it indicates an invalid button press.

BEFORE YOU BEGIN

Installing Batteries in the Remote

1. Open the battery door on the back of the remote.
2. Insert fresh batteries. Make sure that the polarities (+ and -) are aligned correctly.
3. Replace the battery door.

Important Battery Information

- If you're not going to use the remote for a month or more, be sure to remove the batteries because they can leak and cause damage.
- Dispose of batteries in the proper manner, according to federal, state, and local regulations.
- Any battery may leak electrolyte if mixed with a different battery type, if inserted incorrectly, if all batteries are not replaced at the same time, if disposed of in fire, or if an attempt is made to charge a battery not intended to be recharged.
- Discard leaky batteries immediately. Leaking batteries can cause skin burns or other personal injury.

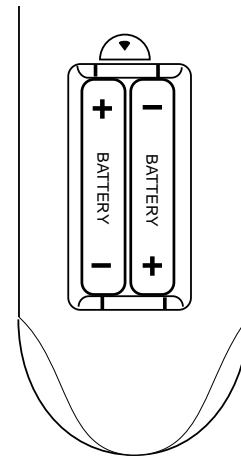

Types of Discs that the Player Can Play

This DVD player is capable of playing the following types of discs, having the corresponding logos:

- Audio CDs



- Video CDs



- DVDs



DO NOT Use CD-R Discs!

The wave length of the pickup of this DVD player may cause CD-R discs to be erased. **DO NOT** play CD-R discs in this player!

CONNECTIONS

A Few Things You should Know

Before you connect your DVD player, there are a few things that you need to know.

Protect Your Components from Power Surges

- Connect all components before plugging any power cords into the wall outlet.
- Always turn off the DVD player, TV and other components before you connect or disconnect any cables.

Position Cables Correctly to Avoid Audio Hum or Interference

- Insert all cable plugs firmly into their jacks.
- Place the audio/video cables to the sides of the TV's back panel instead of straight down the middle after you connect your components.
- Try not to coil any twin-lead cables and keep them away from the audio/video cables as much as possible.
- Make sure all antennas and cables are properly grounded.

Protect Your Components from Overheating

- Do not block ventilation holes in any of the components. Arrange the components so that air can circulate freely.
- Do not stack components.
- Allow adequate ventilation when placing your components in a stand.

CAUTION

Do not stack electronic components or other objects on top of the DVD player. See Safety Information, inside front cover.

CONNECTIONS

Jacks and Cables

S-Video Jack and Cable

The S-Video jack provides the best picture quality for your DVD player. This jack is available on many TVs and is used in conjunction with audio cables to connect the DVD player to your TV.

Remember also to connect the left and right audio cables because the S-Video jack carries only the picture signal, not the sound.



Audio/Video Jacks and Cables (RCA-type)

The audio/video jacks provide very good picture and stereo sound quality, and should be used if your TV has no S-Video jack.

These jacks are used for most audio/video connections between components. The DVD audio/video jacks are color coded (yellow for video, red for right audio, and white for left audio). If your TV has only one input for audio (mono), connect it to the right (red) audio jack on the DVD player.

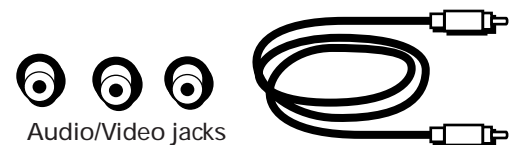

RF Jacks and Coaxial Cables (F-type)

You may not need coaxial cables to connect the DVD player to your TV, but you may need to use coaxial cables to carry the cable, satellite, or off-air signal to your television.

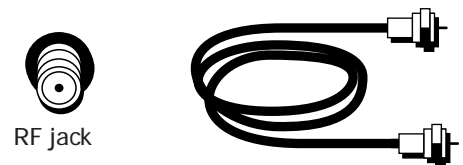

Optical Cable (for Connecting to a Dolby Digital Receiver)

If you own a Dolby Digital receiver that uses an optical cable-type input, you can use the optical cable to connect the DVD player to that receiver to get the best sound quality.

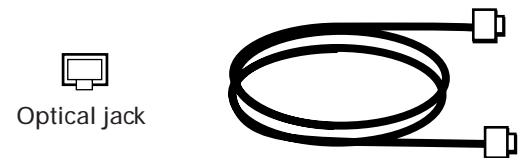

RF Modulator

If your television has only an RF input jack, you will need to use an RF modulator (not included) to convert the line output signal to an RF signal.

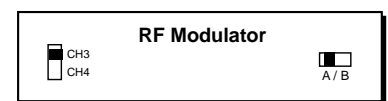

(Front)



(Back)

CONNECTIONS

Choosing a Connection

The following pages show examples of connections commonly used to connect the DVD player with a TV and other components. Refer to your TV, VCR, or Dolby Digital Receiver owner's manual for more information on hooking up your specific components.

DVD Player + TV without A/V Input Jacks 10

If your television only has antenna (RF) inputs, you will need to get an RF converter in order to connect the DVD player. This connection gives you a good quality picture and sound.

DVD Player + TV with A/V Input Jacks (and/or S-Video) .. 11

If your television has A/V input jacks use them to connect your DVD for better quality picture and sound. (For the best quality picture, use the S-Video input if your television has one.)

DVD Player + Stereo Amplifier/Receiver + TV 12

If your television has an S-Video input, and you have a Dolby Digital Receiver (with optical-type input jack), use this connection to get the best quality picture and sound.

DVD Player + TV + VCR 13

If you want to include a VCR in your connection scheme, this shows you one possible connection.

Finishing the Connection

After you have connected all of the components, you will need to attach the power cord, and set the on-screen menu language (see page 14 for more information).

Don't Forget to Plug It In

After you've connected the components, don't forget to plug in the DVD player.

CONNECTIONS

DVD Player + TV without A/V Input Jacks (Good Picture and Sound Quality)

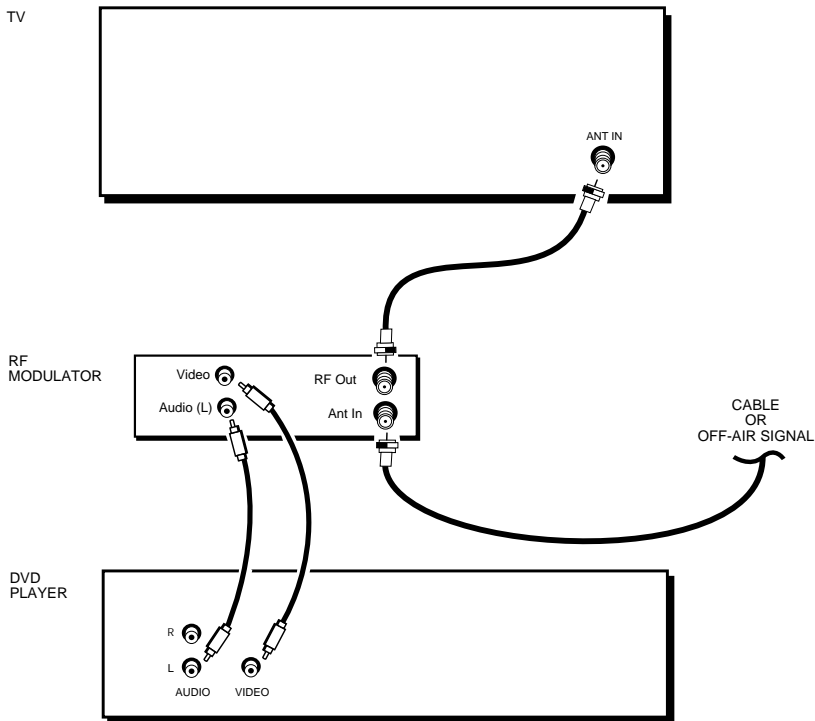

To Connect the DVD Player

If you do not have audio/video input jacks on your television, you need to use an RF modulator, and a splitter.

1. Connect one end of the A/V cables to the Left Audio and the Video outputs on the DVD player.
2. Connect the other end to the corresponding inputs on the RF modulator.
3. Connect the off-air antenna or your cable signal to the antenna input on the RF modulator (if it has one).
4. Connect the output from the modulator to the antenna input on your television.

To Watch DVD

Tune your television to RF modulator output channel (the modulator should have a CH 3/4 switch to indicate the output channel).

NOTE:

- You may need to adjust the A/B switch on the RF modulator to watch television programming.

CAUTION

Do not stack electronic components or other objects on top of the DVD player. See Safety Information, inside front cover.

Consult the owner's manuals of the additional components you are connecting for more detailed connection information for those particular components.

CONNECTIONS

DVD Player + TV with A/V Input Jacks

(Better Picture and Sound Quality)

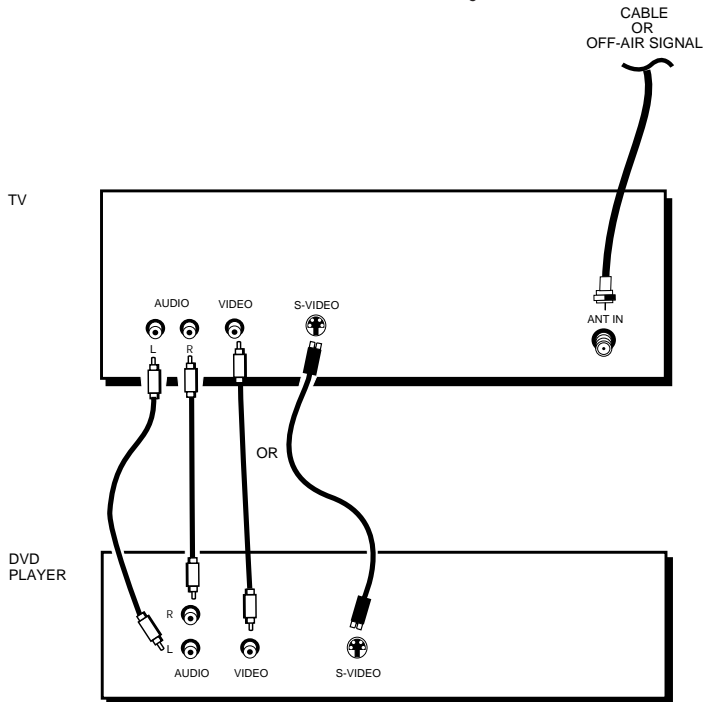

To Connect the DVD Player

1. Connect the left and right audio cables.
2. Connect the video cable (or the S-Video cable if your television has an S-Video input).

NOTE:

- Your cable or off-air connection to the television should not be affected by this connection. Connect as you normally would to your television. (You may need to consult your television's owner's manual for details.)

To Watch DVD

Tune your television to either the Video or S-Video input channel. Consult your television manual for specific details.

CAUTION

Do not stack electronic components or other objects on top of the DVD player. See Safety Information, inside front cover.

Consult the owner's manuals of the additional components you are connecting for more detailed connection information for those particular components.

CONNECTIONS

DVD Player + TV + Dolby Digital Receiver

(Best Picture and Sound Quality)

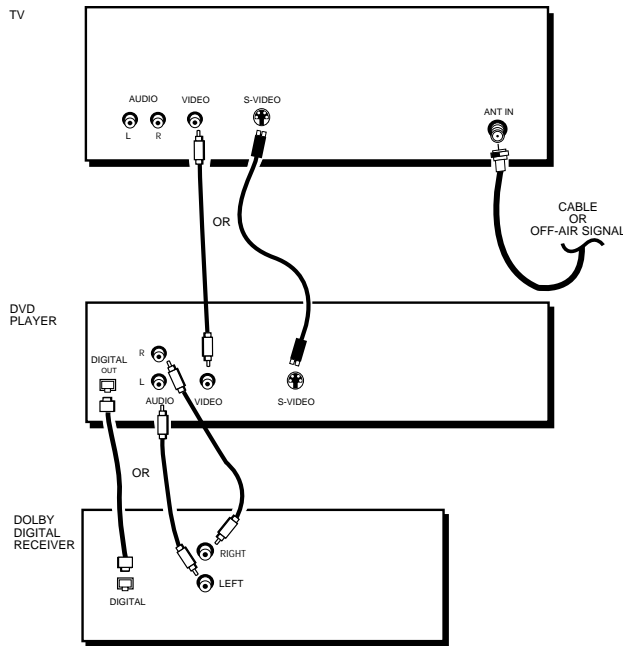

To Connect the DVD Player

1. Connect the left and right A/V cables to the Dolby Digital receiver,
Or
Connect an optical cable to the DIGITAL OUT jack on the DVD player and to the digital input on a Dolby Digital receiver.
2. Connect the video cable (or the S-Video cable if your television has an S-Video input).

Dolby Digital

This format is used when 5.1-channel audio signals are recorded onto the digital track of film. It provides 5 separate (discrete) channels: left, right, center, left rear, right rear, and common subwoofer.

To Watch DVD

Tune your television to either the Video or S-Video input channel for the video output. Use your Dolby Digital receiver for audio output.

PLEASE READ BEFORE USING THE DIGITAL OUT JACK!

This player's Digital Output jack fully complies with the international standard governing this type of jack (IEC 958), and is designed for connection to a Dolby Digital (AC-3) receiver or Dolby Digital (AC-3) decoder.

DO NOT use the Digital Output jack to connect to equipment other than a Dolby Digital (AC-3) receiver or Dolby Digital (AC-3) decoder. Such a connection can create a high level of noise that may be harmful to your ears, and could damage headphones or speakers.

Older digital equipment, some of which is not fully compliant with IEC 958, is likely to cause this problem.

CAUTION

Do not stack electronic components or other objects on top of the DVD player. See Safety Information, inside front cover.

Consult the owner's manuals of the additional components you are connecting for more detailed connection information for those particular components.

CONNECTIONS

DVD Player + TV + VCR

The following is one possible connection if you want to include a VCR in your connection scheme.

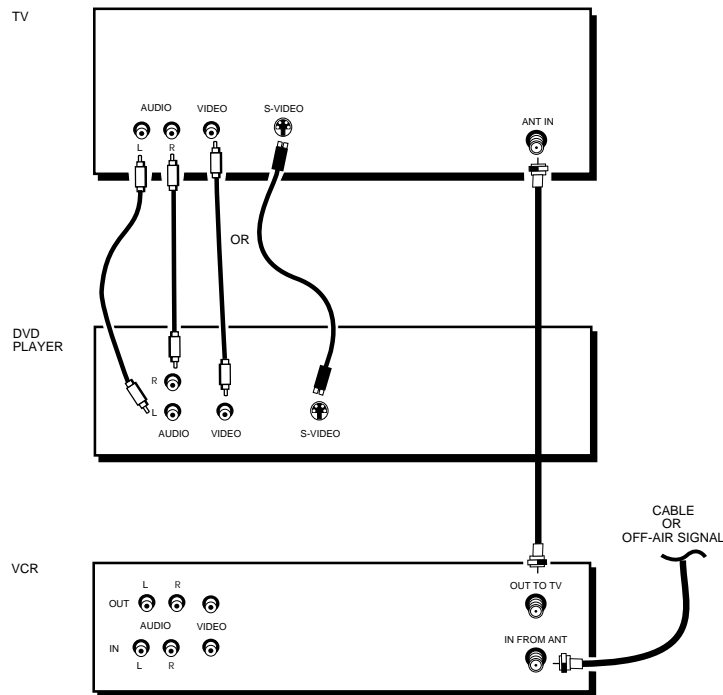

To Connect the DVD Player

1. Connect the left and right audio cables.
2. Connect the video cable (or the S-Video cable if your television has an S-Video input).

To Connect the VCR

1. Connect the off-air antenna or cable signal to the antenna input on the VCR.
2. Connect the antenna output on the VCR to the antenna input on the television.

To Watch DVD

Tune your television to either the Video or S-Video input channel. Consult your television manual for specific details.

To Watch VCR

Tune your television to channel 3 or 4 depending on how you set the CH3/4 switch on the back of the VCR.

CAUTION

Do not stack electronic components or other objects on top of the DVD player. See Safety Information, inside front cover.

Consult the owner's manuals of the additional components you are connecting for more detailed connection information for those particular components.

CONNECTIONS

Connect the AC Power Cord

After you have connected the components, you need to connect the AC power cord. Connect the AC power cord to the back of the DVD player and to an AC power outlet (AC120 V, 50-60 Hz).

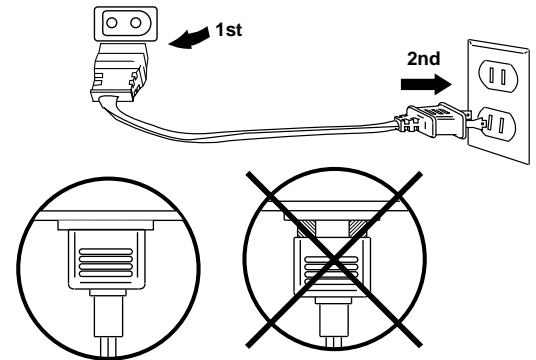

NOTE: Make sure that the plug is fully seated in the DVD player.

Setting Up the Menu Languages

By default, the menu language is set to English. If you want to change the menu language, go to the Setup menu and select the "Menu Language" option.

Other Language Options

The Menu Languages feature changes the language only for the text on the menu screens. There are other language options available for subtitling and audio.

For more information on these language options, see "Using the Setup Menu."

Menu System Navigation Tool

The menu system has an on-screen navigation tool located in the lower right-hand corner, indicating which arrows you can press to point to menu options.

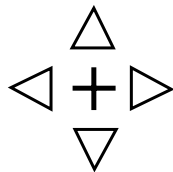

The arrows that are lit up represent the arrow buttons on the remote or front panel that are currently available. When the crosshair (+) is lit, you can press the SELECT button to select the option currently highlighted in the menu screen.

PLAYING DVDS

A New Way of Looking At Things

In this section you learn how to use your DVD player to play Digital Video Discs (DVDs for short).

As a little up-front information, you should know that although some of the remote buttons look the same as those you would use with a VCR or CD player, the functions work somewhat differently. So, take some time now to find out how to play DVDs, and then you can sit back and enjoy all of the features it has to offer you.

Also Keep In Mind...

In order for some of the player's features to work, the DVDs that you use must be encoded by the studios with specific information. For example, a disc must contain subtitles in order for the player to show them to you.

Regional Coding

Both the DVD player and the discs are coded by region. These regional codes must match in order for the disc to play. If the codes do not match, the disc will not play. This player's regional code is Locale #1.



PLAYING DVDS

Loading and Playing a DVD

Before you load a disc, make sure that it is compatible with the player. Note that the following discs CANNOT be used with this player:

- Laserdisc
- CD-I, CD-ROM, CD-R, DVD-ROM
- Mini Disc
- Discs recorded using other broadcast standards (i.e. PAL or SECAM)
- CD-G discs play audio only, not graphics

To Load and Play a DVD

Make sure that you have properly connected the DVD player (see "Connections"), and that the player is in the power on state.

1. Press the OPEN/CLOSE button on the front of the DVD player.
2. Place a disc gently into the tray with the disc's label facing up.
3. Press the PLAY button to close the disc tray.

The DVD player reads the table of contents, and displays the disc's title menu (if it has one).



Insert disc with the label side facing up.



An example of a disc's title menu.

4. Use the arrow buttons to point to (highlight) a menu item, and then press SELECT to begin playing the highlighted menu item.
5. Press STOP to stop playback.

Resume Feature

When you stop disc play, the player remembers where you stopped, so when you press PLAY again to begin play, it will pick up where you left off (unless the disc is removed, or the player is unplugged). Because Resume uses elapsed time as a marker, this feature does not work with discs that do not keep elapsed time (for example, interactive CDs),

PLAYING DVDS

DVD Playback Features

Several options are available during DVD playback.

Chapter Scan

Because the DVD is divided into Chapters, you can skip through a disc's contents one chapter at a time.

- Press and release SKIP REV to go to the beginning of the preceding Chapter.
- Press and release SKIP FWD to go to the beginning of the next Chapter.

Fast Motion Playback (Picture Scan)

To scan through a section of the disc during playback, use the Picture Scan feature:

1. Press the REV or FWD button during playback to search through a disc.
2. Press the button a second time to search at a faster speed.
3. Press PLAY to resume normal playback.

Note:

- This feature may not work with all discs.

Freeze Frame and Frame Advance

1. Press PAUSE once to freeze playback.
2. Each subsequent press of the PAUSE button advances the picture one frame at a time.
3. Press PLAY to resume normal playback.

Slow Motion Playback (In Freeze Frame Mode)

While the disc is in freeze frame mode, you can invoke either forward or backward slow motion playback.

- Press REV for backward slow motion playback.
- Press and hold FWD for forward slow motion playback.
- Press PLAY to resume normal playback.

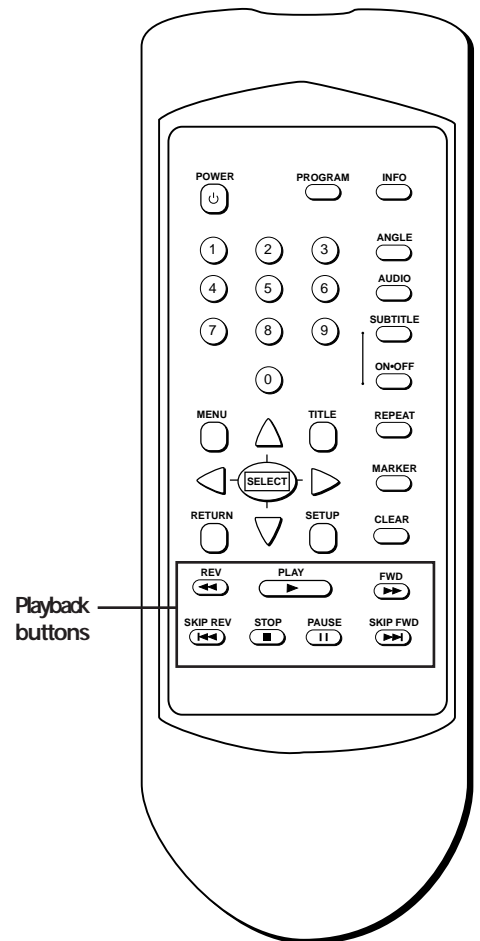

Slow Motion Backward

Because of the nature of MPEG2 video, searching backward does not provide as clear a picture as searching forward, and the picture may appear "jumpy."

PLAYING DVDS

Repeating Play

You can use this feature to repeat a chapter or a title.

1. Press REPEAT once to repeat the chapter currently playing.
2. Press REPEAT twice to repeat the title currently playing.
3. Press REPEAT a third time to turn off the repeat feature.

Notes:

- The repeat indicator on the front panel appears when you are in repeat mode.
- The on-screen display indicates which repeat mode you are using: REPEAT CHAPTER, REPEAT TITLE, or STANDARD PLAY.
- The Repeat feature does not work with interactive DVDs.

Selecting Specific Scenes on a DVD

Use the on-screen display to go to a specific scene on a DVD.

Selecting a Title Number

1. Press the INFO button during disc playback.

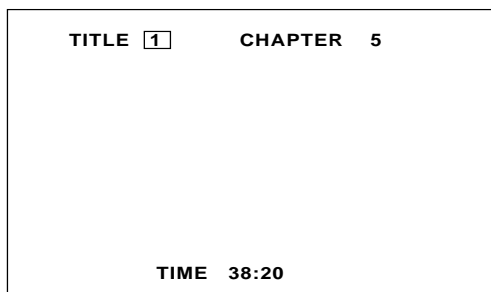

Enter the number of the title and press PLAY.

2. Use the digits on the remote to enter a different title number.
3. Press PLAY to begin playing the selected title.

Selecting a Chapter Number

1. Press the INFO button during disc playback.

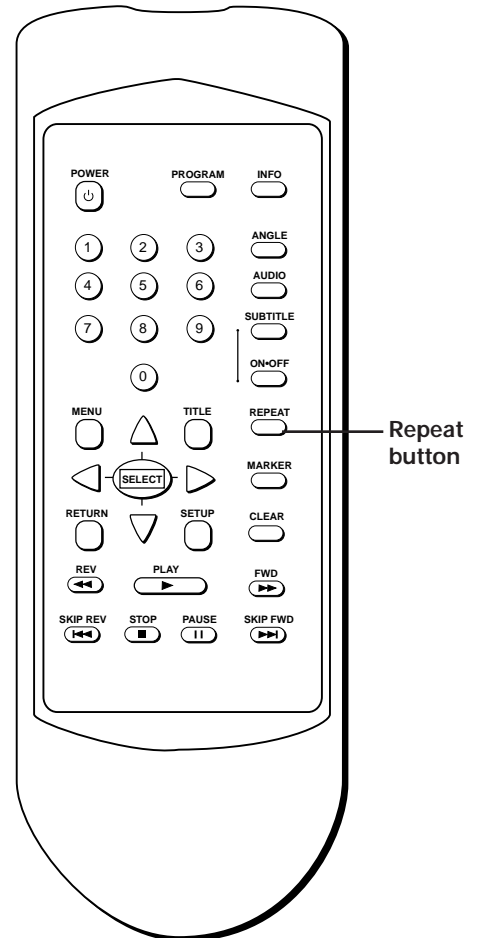

What's a Scene?

Because DVD is a digital format, the information can be separated in many different ways. One way that a DVD might be separated is by scenes (as in a movies). Each scene might be a chapter on a DVD, so rather than watching the whole movie to get to a scene, you can just go straight to it.

PLAYING DVDS

- Use the right arrow on the remote to highlight the current chapter number.

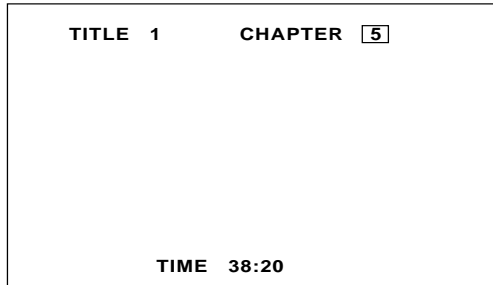

Enter a new chapter number and press PLAY.

- Use the digits on the remote to enter a different chapter number.
- Press PLAY to begin playing the selected chapter.

Notes for Title/Chapter Select:

- If you select a number that does not exist on the DVD, the message "NUMBER OUT OF RANGE" appears.
- This feature does not function when using a DVD without multiple title or chapter numbers.

Using the Elapsed Time

- Press the INFO button during disc playback.
- Use the arrows to highlight the time value.

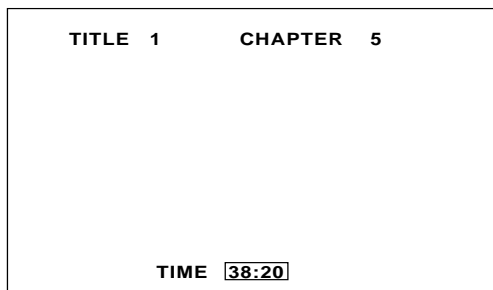

Use the arrows to highlight the time value.

- Use the digits on the remote to enter the elapsed playing time from which you want to start.
- Press PLAY to start playback at the elapsed time indicated.

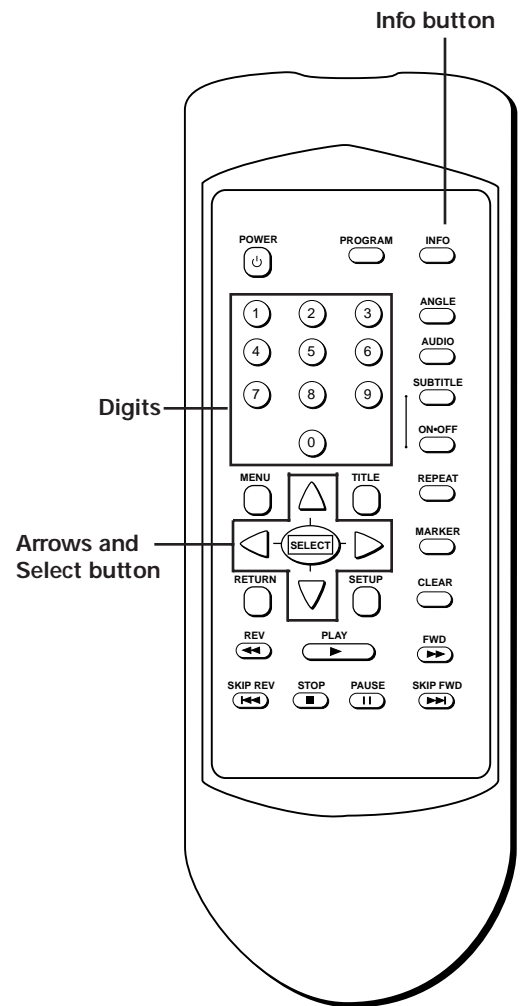

PLAYING DVDS

Note:

- Some discs might not display the elapsed time, and thus cannot be searched using this feature.

Selecting a Title Using the TITLE Button

You can use the TITLE button on the remote to access a list of titles available on a DVD.

1. Press TITLE.
2. Use the arrows to highlight a title, and then press SELECT.

The selected title begins play.

Notes:

- Not all DVDs contain multiple titles.
- Depending on the type of DVD, another menu may be displayed.

Using a DVD's Author Menu

Each DVD is capable of having its own menu structure which allows you to change the settings for audio, subtitling, and angle for that disc only. In this manual we refer to this menu as the "Author" menu because its contents are created by the author (manufacturer) of the disc. Although the Author menu's contents and operation differ from disc to disc, the following example may give you an idea of what to expect when you use this feature.

1. Press MENU to bring up the DVD's Author menu.

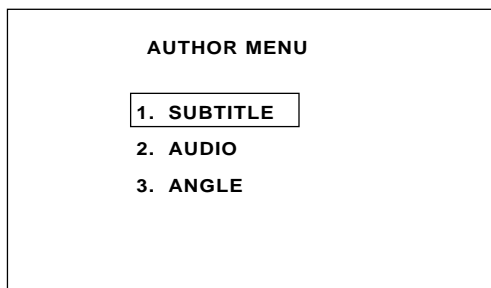

The Subtitle setting is selected here.

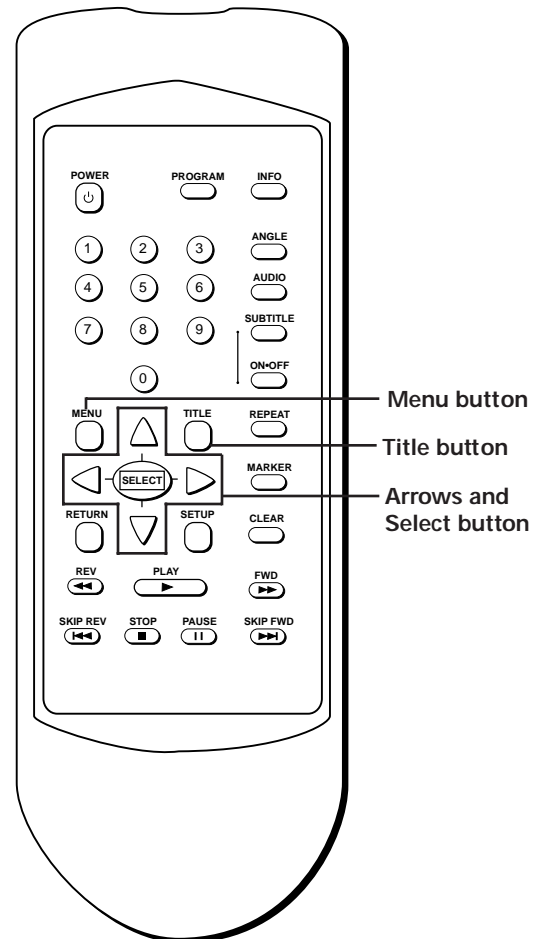

Initialized Settings

"Initialized settings" are the settings to which the player will default each time it is turned on.

Any settings you change by using the features listed on this page only temporarily override the initialized settings.

Use the SETUP menu of the DVD player to change the initialized settings. (See "Using the Setup Menu" for more details.)

PLAYING DVDS

- Use the arrows to highlight the setting you want to change, and then press SELECT.

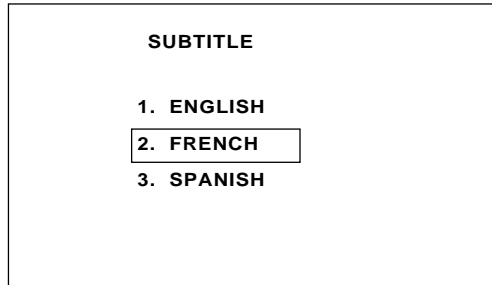

French is selected.

- Use the arrows to highlight a subtitle language (from the Subtitle menu), and then press SELECT.

Subtitling for this DVD will now appear in French.

Notes:

- The Author menu is disc dependent, and its operation may vary from disc to disc.
- If the DVD is removed from the disc tray, or the player is turned off, these settings are returned to the initialized settings.

Using the Subtitle Feature

When a DVD is recorded with subtitles, you can use the Subtitle feature to view the subtitles on-screen. The ON•OFF button on the remote (located beneath the SUBTITLE button), turns subtitling on or off. If the DVD has been recorded with subtitles, they will appear on-screen.

Changing the Subtitle Language (On the Player)

You can temporarily change the initialized subtitle language by using the SUBTITLE button on the remote.

- Press SUBTITLE.
- Use the up/down arrows on the remote to select a subtitle language.

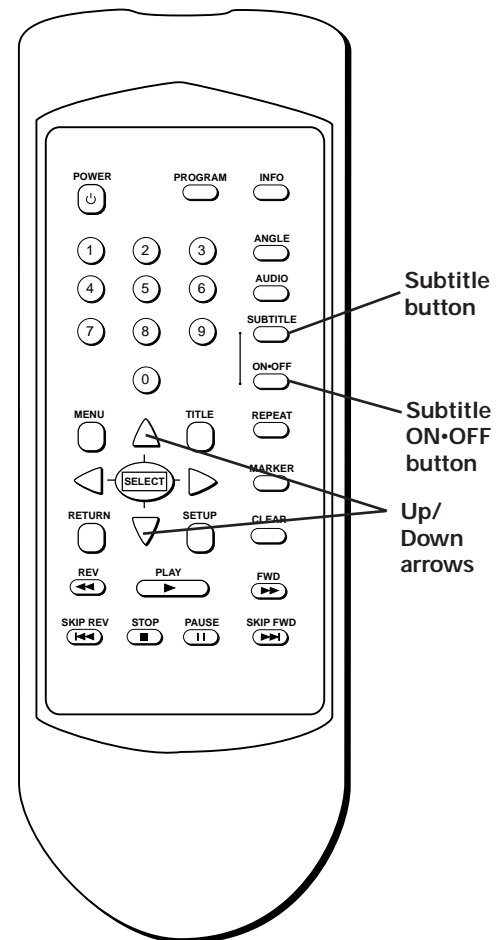

Make sure that the player's subtitle feature is turned on, or the subtitling will not appear on-screen.

PLAYING DVDS

Note:

- When the player is turned on, the initialized subtitle language is selected. If the disc does not contain the same initialized language as that of the player, the “default” language is automatically selected.

Changing the Audio Language

You can temporarily change the initialized audio language (provided that additional languages are recorded on the DVD).

1. Press AUDIO.
2. Use the up/down arrows on the remote to select an audio language.

Note:

- When the player is turned on, the initialized audio language is selected. If the disc does not contain the same initialized language as that of the player, the “default” language is automatically selected.

Changing the Camera Angle

Some DVDs are recorded using multiple camera angles. Use the ANGLE button on the remote to select a different angle.

1. Press ANGLE.
2. Use the up/down arrows on the remote to select an alternate angle.

Notes:

- This feature does not work when a DVD has not been recorded with a multi-camera angle system.
- You can identify the section on a DVD that contains the multi-camera angles by a mark that appears at the beginning of each section.

Using the Marker Feature

Use the Marker feature to select (or mark) parts of a DVD so that you can quickly find the section at a later time. This feature can be used during DVD playback.

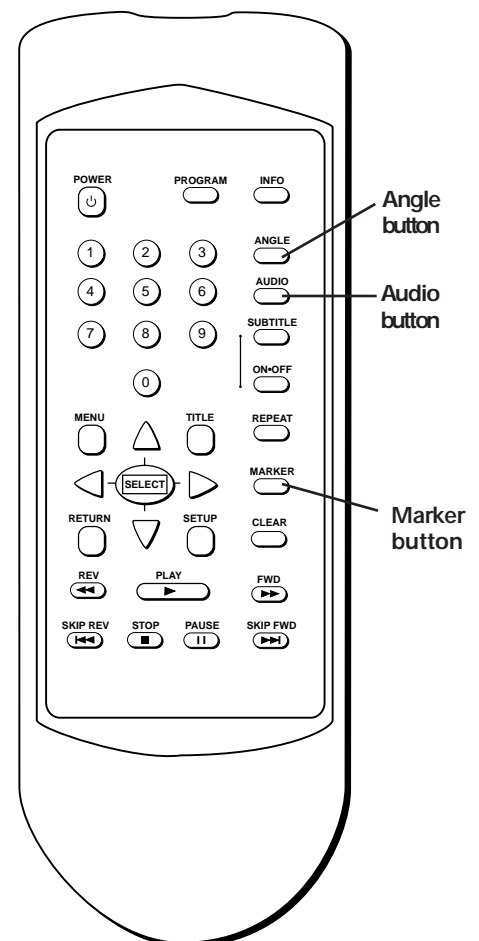

PLAYING DVDS

Storing a Marker During DVD Playback

1. Press the MARKER button at the point during playback that you want to mark.

The Marker display appears on-screen.

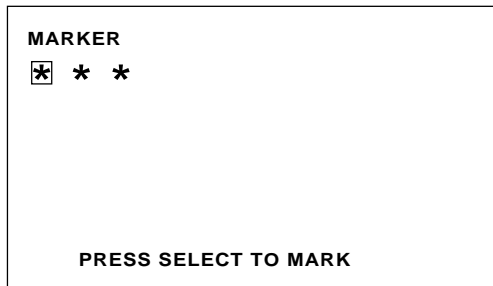

The Marker display screen.

2. Press the SELECT button to place a mark. You can place as many as three markers on a disc.

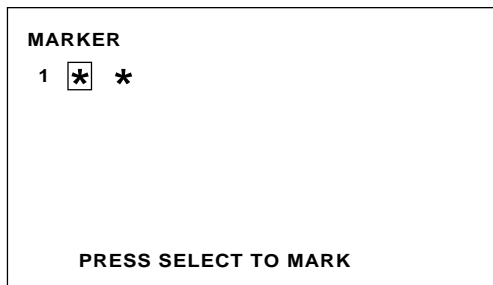

Marker 1 has been placed

Playing a Marked Part

1. Press the MARKER button.

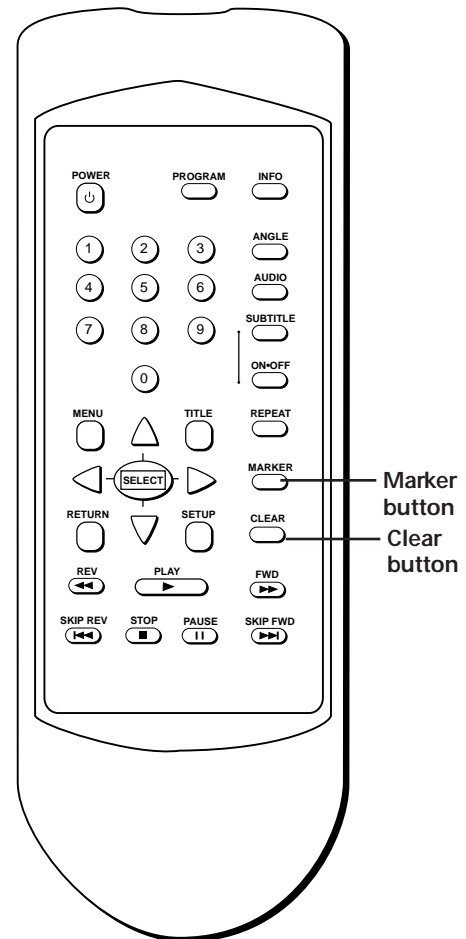

PLAYING DVDS

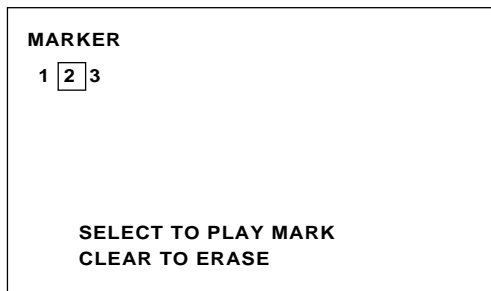

Highlight an existing marker and press SELECT.

2. Use the arrows to highlight an existing marker.
3. Press SELECT to go that part of the DVD and automatically begin playback from there.

Clearing a Marker

1. Press the MARKER button.

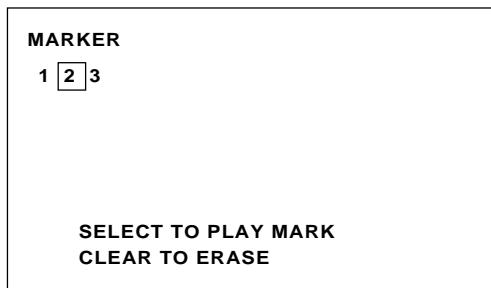

Highlight an existing marker and press CLEAR.

2. Use the arrows to highlight an existing marker.
3. Press CLEAR to delete the highlighted marker.

Playing Karaoke Discs

Use the AUDIO button and the arrows to change both the audio language, and the audio output of a karaoke disc.

1. Press the AUDIO button on the remote.
2. Use the up/down arrows change the audio language (if necessary).
3. Use the left/right arrows to turn on or turn off the voice output.

Changing Songs on a Karaoke Disc

Each song on a karaoke disc is the equivalent of a title, so you may not be able to skip an entire song by pressing the skip buttons only once.

PLAYING AUDIO CDS

Just Like Your CD Player

Your DVD player can play Audio Compact Discs, as well as DVDs. If you've used a CD player before, you will probably notice that your DVD player has a lot of the same features as a CD player.

This section gives you all the information you need to know to play Audio CDs on your DVD player.



PLAYING AUDIO CDS

Loading and Playing an Audio CD

Before you load a disc, make sure that it is compatible with the player. Note that the following discs CANNOT be used with this player:

- Laserdisc
- CD-I, CD-ROM, CD-R, DVD-ROM
- Mini Disc
- Discs recorded using other broadcast standards (i.e. PAL or SECAM)
- CD-G discs play audio only, not graphics

To Load and Play an Audio CD

Make sure that you have properly connected the DVD player (see "Connections"), before you begin.

1. Press the OPEN/CLOSE button on the front of the DVD player.
2. Place a disc gently into the tray with the disc's label facing up.
3. Press the PLAY button to close the disc tray.

The DVD player reads the disc's table of contents, and then begins disc playback.

5. Press STOP to stop playback.



Insert with the label facing up.

Audio CD Playback Features

When playing audio CDs, your DVD player has many of the same features that your CD player has, including track skip, repeat play, and programmed playback.

Skipping Tracks

- To skip forward to the beginning of the next track on a CD, press the SKIP FWD (▶▶) button.
- To skip backward to the beginning of the preceding track on a CD, press the SKIP REV (◀◀) button.

PLAYING AUDIO CDS

Repeating Play

- Press the REPEAT button once to repeat the current track.
- Press REPEAT a second time to repeat all tracks.
- Press REPEAT a third time to resume normal playback.

Selecting a Specific Track

1. Press the INFO button.

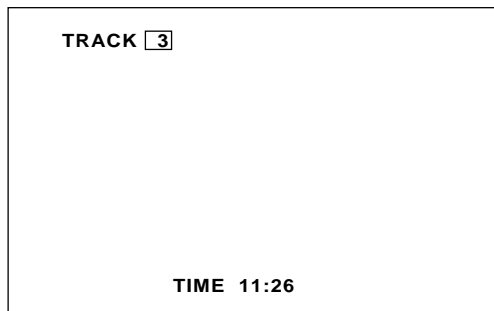

Enter the track number you want to hear.

2. Use the digit buttons to enter the desired track.
3. Press PLAY to begin playback.

Note:

- You can also use the digit buttons on the remote to enter a track number directly.
- If you select a number that does not exist on the disc, the message "NUMBER OUT OF RANGE" is displayed.

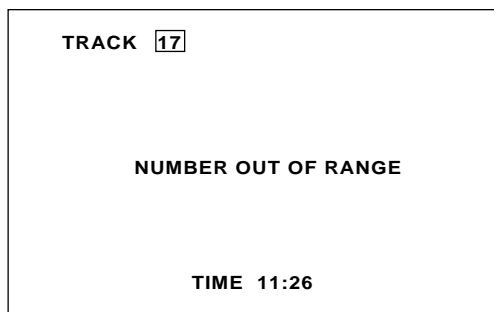

The "Number out of Range" message means that the track does not exist on the disc.

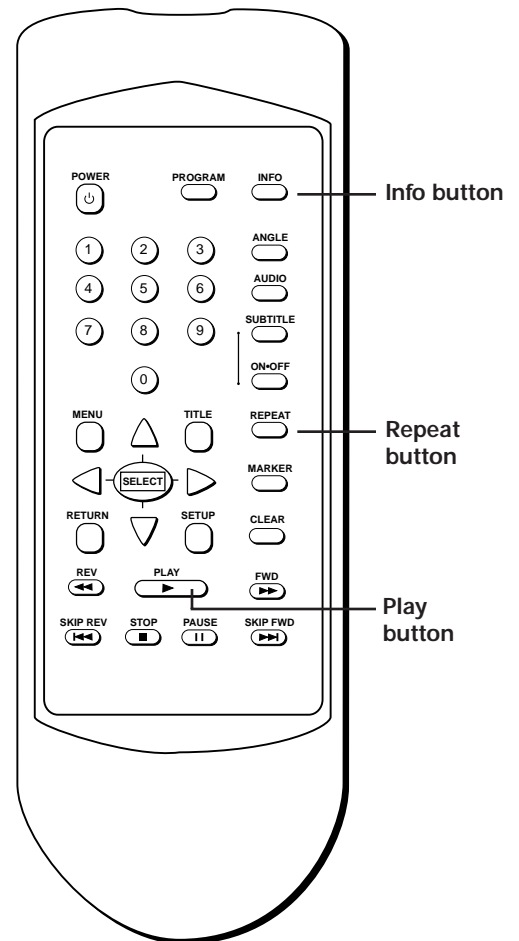

PLAYING AUDIO CDS

Program Playback

Program playback lets you set up a specific order for Audio CD playback.

1. Press the PROGRAM button (while in stop mode) to bring up the program playback menu.

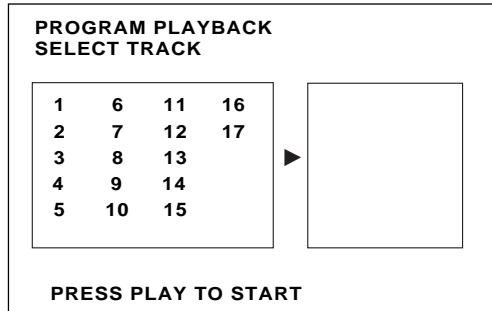

The Program Playback menu for an audio CD.

2. Use the arrows on the remote to highlight a track number.
3. Press SELECT to choose the track number.

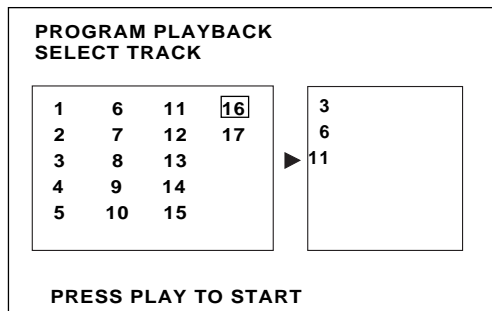

Use the arrow buttons to highlight, and the SELECT button to choose a title/chapter.

4. Press PLAY to begin program playback.

Notes:

- When the program is completed, the disc stops and the Program Playback menu is displayed again.
- To resume normal playback, press the PROGRAM button and then press the PLAY button.

Deleting Programmed Tracks

Press the CLEAR button in stop mode to delete tracks. Note that all programmed tracks are deleted when the DVD player is turned off or the disc is removed.

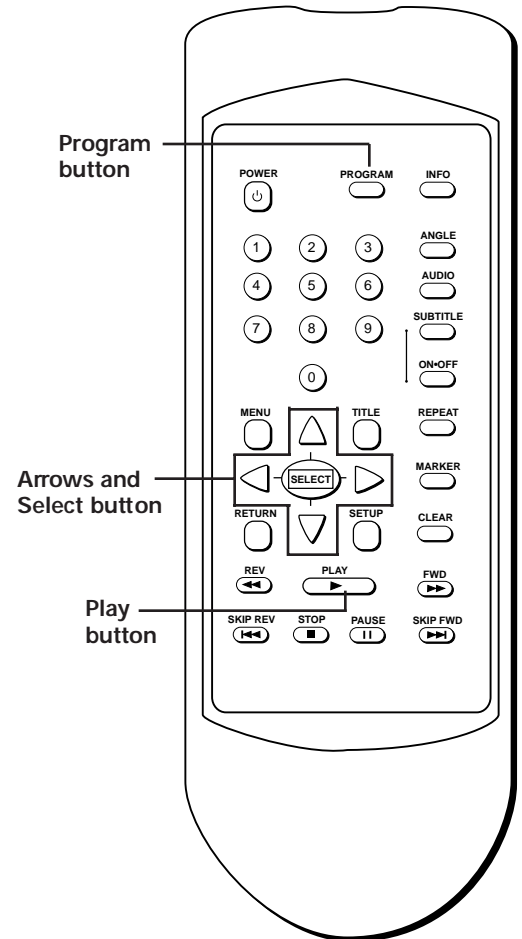

PLAYING VIDEO CDS

What's a Video CD?

The Video CD format is similar to DVD in that Video CDs can contain movies. The big difference is in the amount of information that can be stored on a single CD.

This section gives you all the information you need to know to play Video CDs on your DVD player.



PLAYING VIDEO CDS

Loading and Playing a Video CD

Before you load a disc, make sure that it is compatible with the player. Note that the following discs CANNOT be used with this player:

- Laserdisc
- CD-I CD-ROM, CD-R, DVD-ROM
- Mini Disc
- Discs recorded using other color TV systems (i.e. PAL or SECAM)
- CD-G discs play audio only, not graphics

To Load and Play a Video CD

Make sure that you have properly connected the DVD player (see "Connections"), before you begin.

1. Press the OPEN/CLOSE button on the front of the DVD player.
2. Place a disc gently into the tray with the disc's label facing up.
3. Press the PLAY button to close the disc tray.

The DVD player reads the disc's table of contents, and then begins disc playback

4. Press STOP to stop playback.

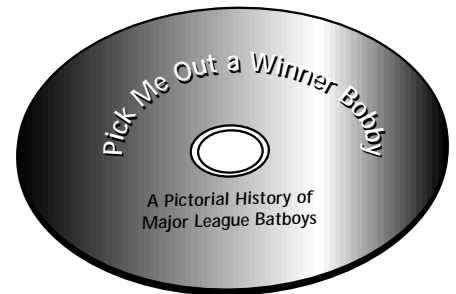

Insert with the label facing up.

If the Video CD Has Playback Control

If a disc is encoded with the playback control function, a menu screen appears after the disc is loaded into the player (see step 3 above).

Pick Me Out a Winner Bobby:
A Pictorial History of Major League Batboys

Title Menu

1. **The Early Days**
2. **Scandal in the Dugout**
3. **The War Years**
4. **A New Era**
5. **The Modern Day Bat Carrier**

For More Information About Playback Control...

Check the instructions that accompany the Video CD for more information on how to use the playback control function for that specific disc.

PLAYING VIDEO CDS

1. Use the digits on the remote to select a title.
2. Press SELECT to begin playback the selected title.
3. Press RETURN to stop playback and return to the menu;

Or

Press STOP to stop CD playback, and remove the menu from the screen.

Bypassing Playback Control

If a Video CD has Playback Control, you can bypass the menu by following these steps when you first load the disc:

1. Press STOP to put the player in Stop mode.
2. Use the digits to enter the desired track number, and then press PLAY. When playback begins, the disc will respond as if it is not in playback control mode.

Note:

- To resume playback control mode, press STOP, and then press MENU.

Video CD Playback Features

The DVD player gives you several options when playing Video CDs, including skipping tracks, repeat play, and programmed playback.

Skipping Tracks

- To skip forward to the beginning of the next track on a Video CD, press the SKIP FWD (▶▶) button.
- To skip backward to the beginning of the preceding track on a Video CD, press the SKIP REV (◀◀) button.

Note:

- For some Video CDs, the SKIP buttons may bring up the menu screen instead.
- The Skip feature does not work while a Video CD is in playback control mode.

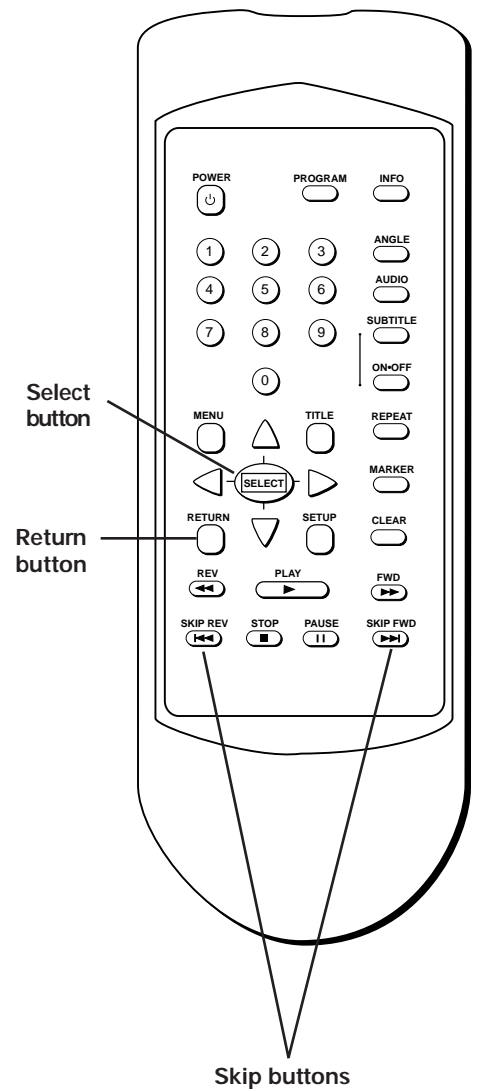

PLAYING VIDEO CDS

Repeating Play

- Press REPEAT once to repeat the current track.
- Press REPEAT a second time to repeat all tracks.
- Press REPEAT a third time to resume normal playback.

Note:

- The repeat feature does not work while a Video CD is played using the menu.
- The Repeat feature does not work while a Video CD is in playback control mode.

Selecting a Specific Track

1. Press the INFO button.

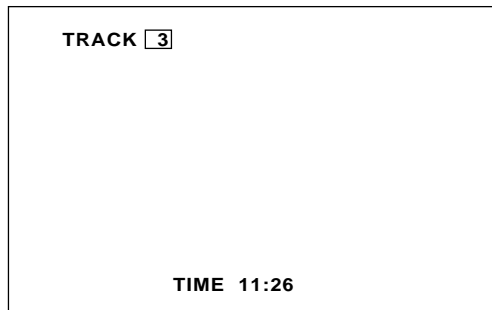

Enter the track number you want to hear.

2. Use the digit buttons to enter the desired track.
3. Press PLAY to begin playback.

Notes:

- This feature does not work in Playback Control mode.
- You can also use the digit buttons on the remote to enter a track number directly.
- If you select a number that does not exist on the disc, the message "NUMBER OUT OF RANGE" is displayed.

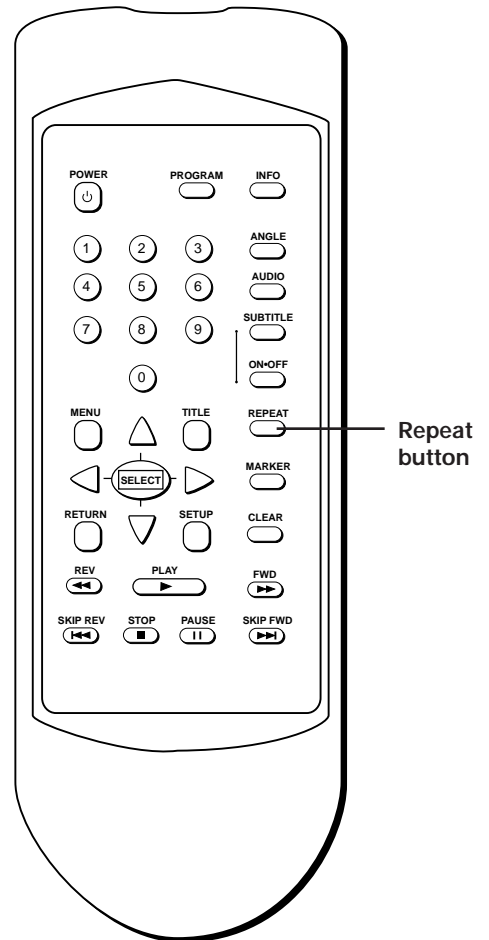

PLAYING VIDEO CDS

Changing the Audio Channel Output

You can change the channel output from the player by using the AUDIO button and the up arrow on the remote control. Note that you must be playing a stereo Video CD.

1. Press AUDIO.
2. Press the Up Arrow to scroll through the audio output options (see diagram below).

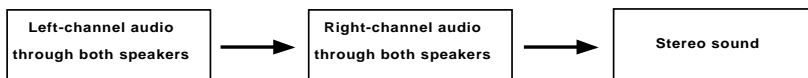

Note:

- Use the Down Arrow to scroll backward through the Audio Channel Output options.

Program Playback

Program playback lets you set up a specific order for the playback of tracks on a disc.

If a disc has Playback control, you must bypass the playback control before you can program tracks (see "Bypassing Playback Control").

1. Press the PROGRAM button (while in stop mode) to bring up the program playback menu.

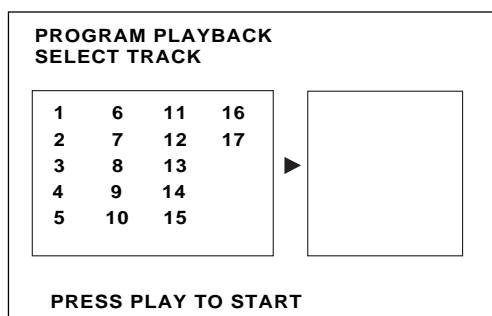

The Program Playback menu for an video CD.

2. Use the arrow buttons on the remote to highlight a track number.

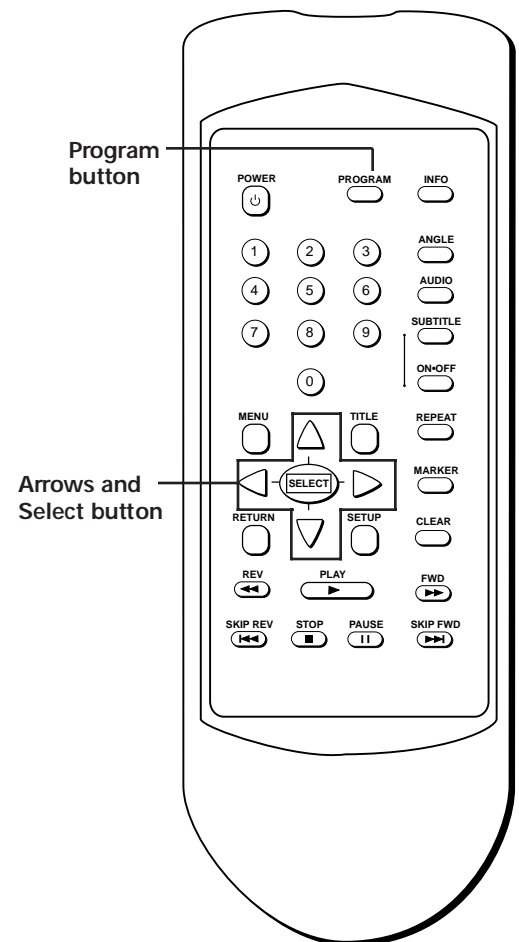

PLAYING VIDEO CDS

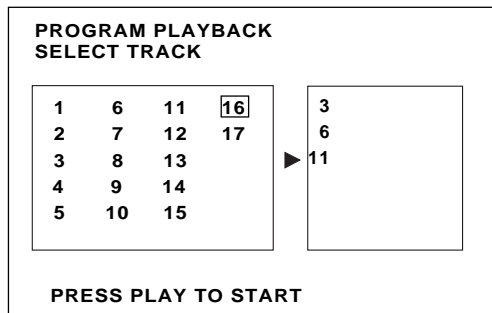

Use the arrow buttons to highlight, and the SELECT button to choose a track.

3. Press SELECT to choose the title and chapter number.
4. Press PLAY to begin programmed playback.

Notes:

- When the program is completed, the disc stops and the program playback menu is displayed again.
- To resume normal playback, press the PROGRAM button twice, and then press the PLAY button.

Program Playback With Playback Control

To use the Program Playback feature with discs that have Playback Control, you need to bypass the Playback Control feature (see "Bypassing Playback Control" earlier in this chapter).

Deleting Programmed Tracks

Press the CLEAR button in stop mode (when the disc is not rotating) to delete programmed tracks one by one.

Notes:

- All programmed tracks are deleted when the DVD player is turned off or the disc is removed.

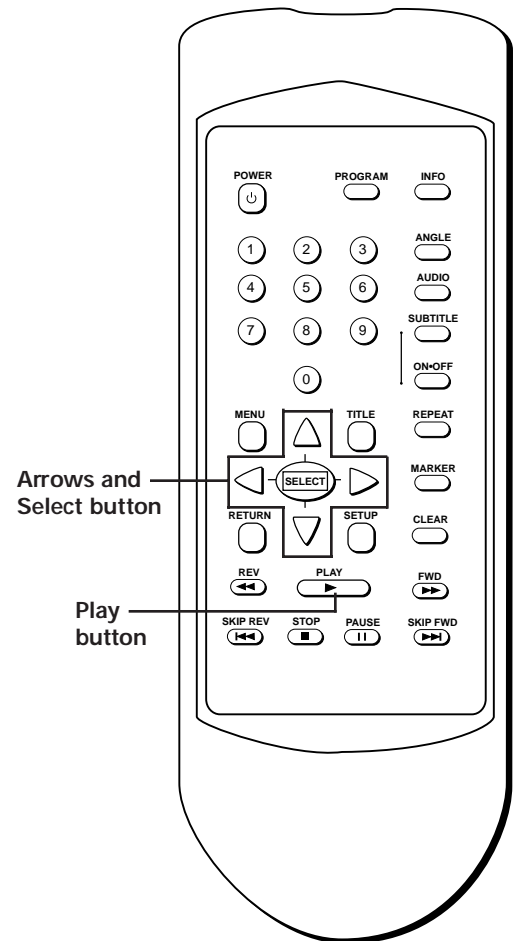

USING THE SETUP MENU

Putting You In Control

The Setup menu lets you customize your DVD player by allowing you to set up a rating level, select various language preferences, and even adjust the player to the type of television screen you have (i.e. wide-screen).

To access the Setup menu, press the SETUP button on the remote control.

USING THE SETUP MENU

Setting Up the Rating Level

The rating level feature works in conjunction with DVDs that have been assigned a rating level, and helps you to control the types of DVDs that your family watches.

1. Press the SETUP button on the remote control.

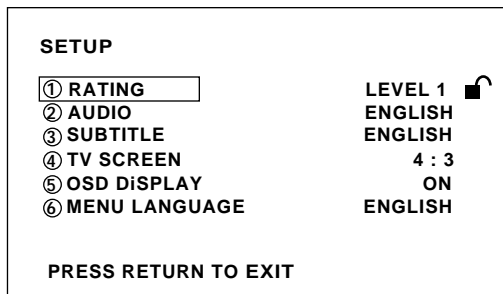

Select RATING from the Setup menu.

2. Use the arrows on the remote to highlight "RATING" and then press SELECT.

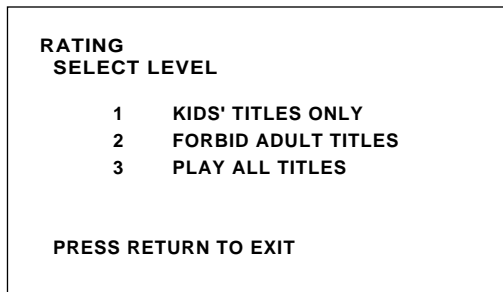

Use arrows to set the rating level.

3. Use the arrows to select your preferred level, and then press SELECT to set the rating.

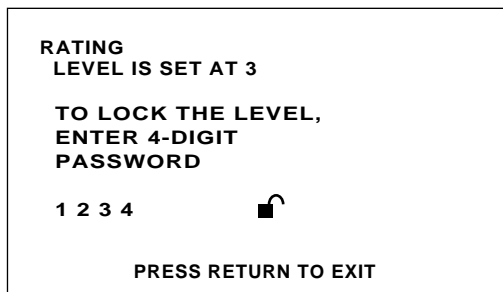

Enter a 4-digit password to lock the rating level.

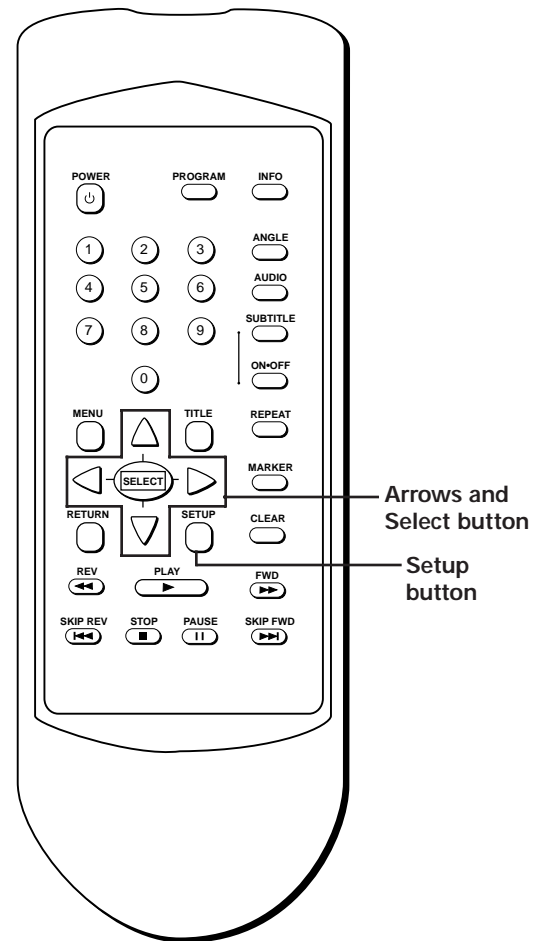

If the Rating Level Feature Doesn't Work...

In order for the Rating Level feature to work, the disc must be encoded with the proper rating information. If the maker of the disc did not encode rating information, then this feature will not work properly.

USING THE SETUP MENU

- To keep the rating level you set from being changed, you can "lock" the level by entering a four-digit password using the digits on the remote, and then pressing SELECT.

Unlocking the Rating Level

In order to unlock the rating level, you need to enter the four-digit password.



You need to enter the 4-digit password before you can change the rating level.

Selecting the Initial Audio Language

A DVD may contain the audio portion of the disc in a variety of languages. Use the Audio menu to select an initial language in which you want to hear a DVD's audio.

- Press the SETUP button on the remote control.

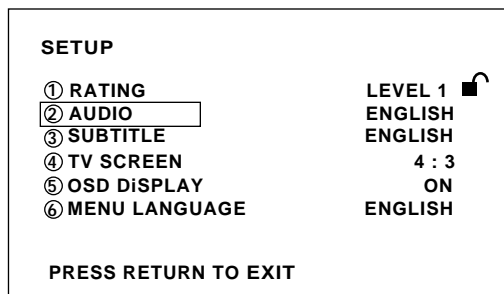

Select AUDIO from the Setup menu.

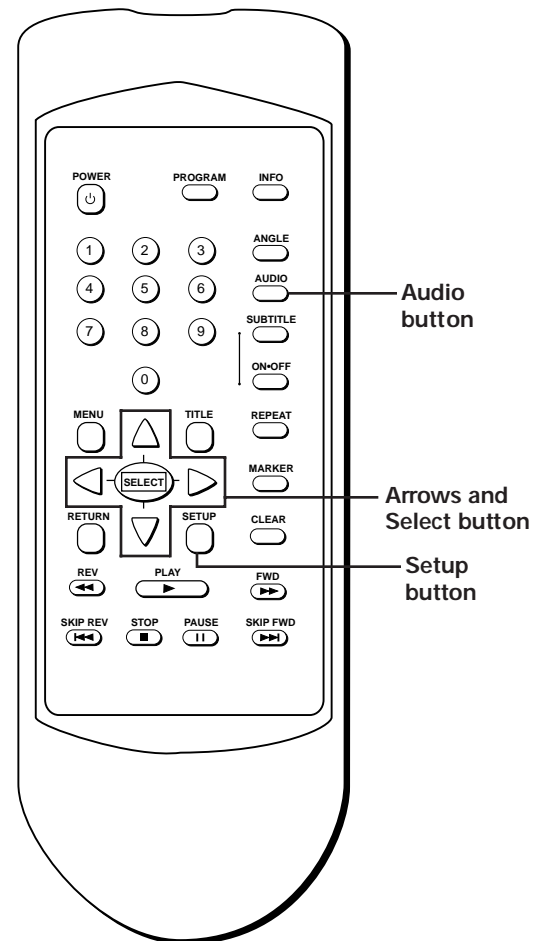

USING THE SETUP MENU

2. Use the arrows on the remote to highlight "AUDIO" and then press SELECT.

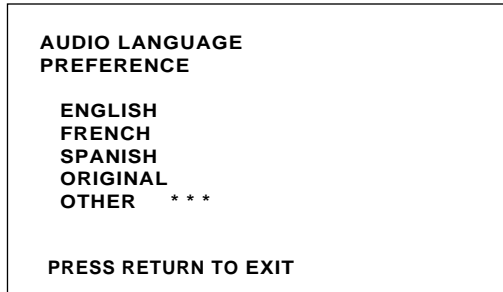

Select an initial audio language setting.

3. Use the arrows on the remote to highlight a language, and then press SELECT.

If the language you want is not listed, select "OTHER," enter the appropriate code from the list of language codes at the end of this chapter, and then press SELECT.

Notes:

- Some discs may not contain the language you select as your initial language; in that case the disc will use its top-priority language setting.
- You can temporarily change the initial audio setting by using the AUDIO button on the remote control (see "DVD Playback Features").

Selecting the Initial Subtitle Language

A DVD may contain subtitles in several languages. Use the Subtitle menu to select an initial language in which you want to view subtitles.

1. Press the SETUP button on the remote control.

The Original Language Setting

When you set the Audio language to "Original Language," it tells the player that you want to hear the original language in which the disc is recorded, that way when people talk in a movie, their lips always match up with the words.

USING THE SETUP MENU

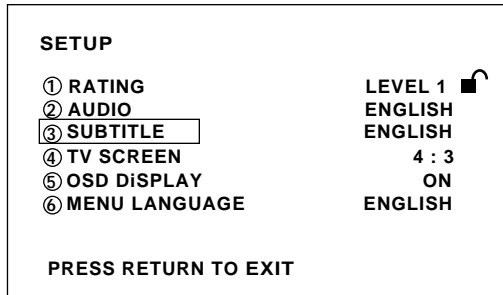

Select **SUBTITLE** from the Setup menu.

- Use the arrows on the remote to highlight "SUBTITLE" and then press SELECT.

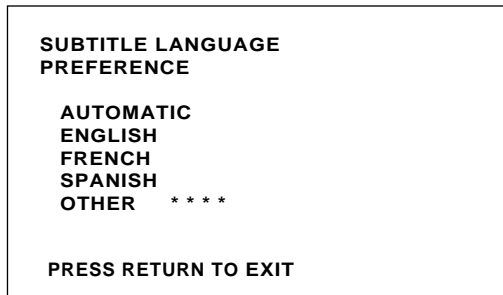

Select an initial subtitle language setting.

- Use the arrows on the remote to highlight a language, and then press SELECT.

If the language you want is not listed, select "OTHER," enter the appropriate code from the list of language codes at the end of this chapter, and then press SELECT.

Notes:

- Some discs may not contain the language you select as your initial language; in that case the disc will use its top-priority language setting.
- Make sure that the subtitle feature is on in order to view subtitling. You can temporarily change the initial subtitling setting by using the SUBTITLE button on the remote control (see "DVD Playback Features").

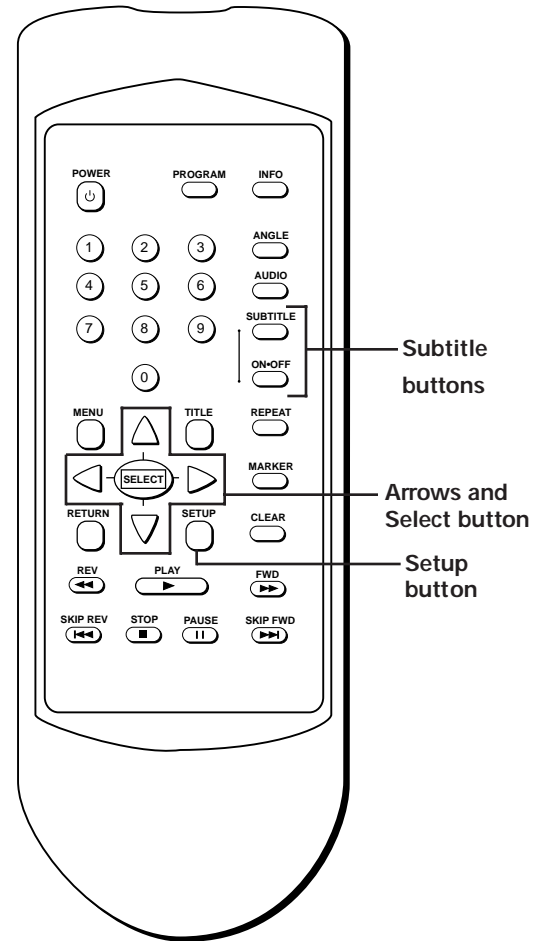

Automatic Subtitling

If you set the Subtitle Language to "Automatic," the subtitling feature automatically turns off when the initial audio language setting is available on the disc. If the initial audio language is not available, then subtitling in that language appears (if available on the disc).

USING THE SETUP MENU

Selecting the TV Screen Setting

Depending on the type of television you have, you may want to adjust the screen setting (aspect ratio).

1. Press the SETUP button on the remote control.

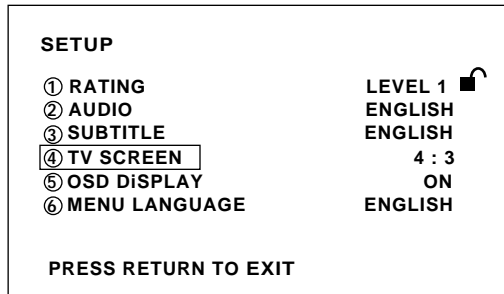

Select TV SCREEN from the Setup menu.

2. Use the arrows on the remote to highlight "TV SCREEN" and then press SELECT.

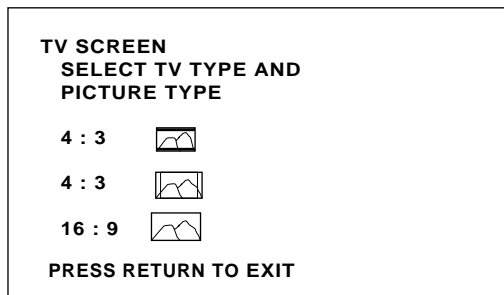

Select a TV screen setting to match your television..

3. Use the arrows on the remote to highlight a screen setting, and then press SELECT.

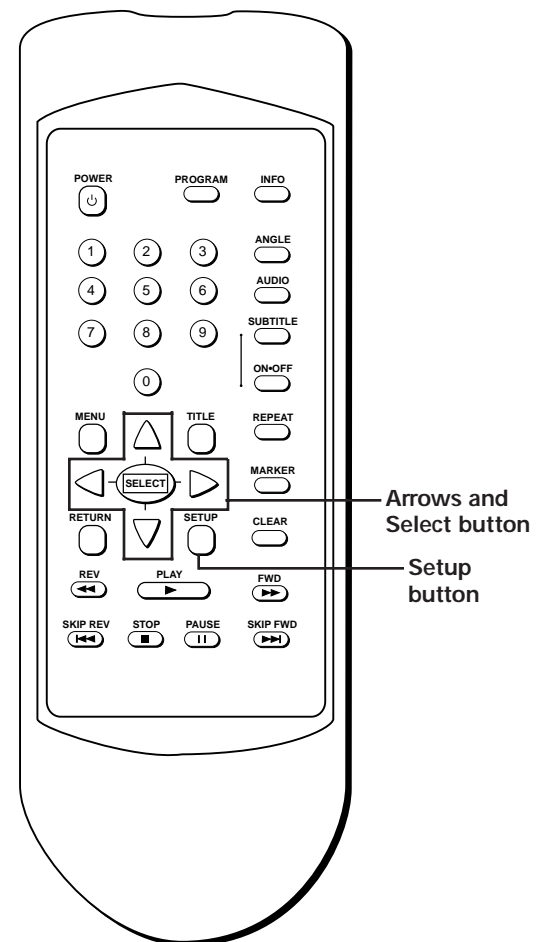

USING THE SETUP MENU

A Little More about Your Options

4 : 3 (Letterbox)

Select this for conventional size televisions. The aspect ratio is selected according to the disc played.

4 : 3 (Pan/Scan)

Select this for conventional size televisions. All video material is played to fit a 4:3 screen.

16 : 9 (Widescreen)

Select this for wide-screen televisions.

Turning the On-Screen Messages Feature On or Off

Use this feature to turn on or turn off the messages that appear on-screen when you use certain features.

1. Press the SETUP button on the remote control.

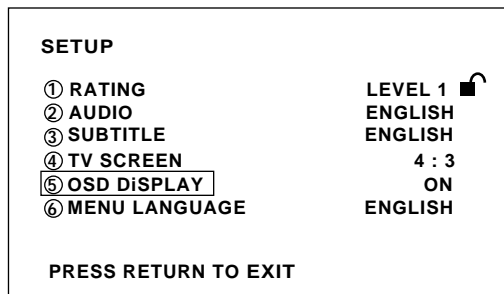

Select OSD DISPLAY from the Setup menu.

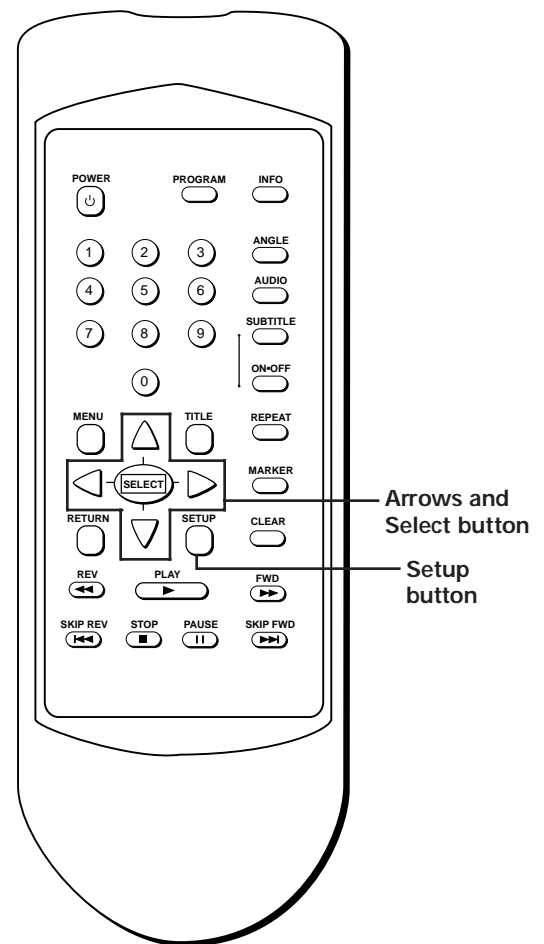

USING THE SETUP MENU

- Use the arrows on the remote to highlight "OSD DISPLAY" and then press SELECT.

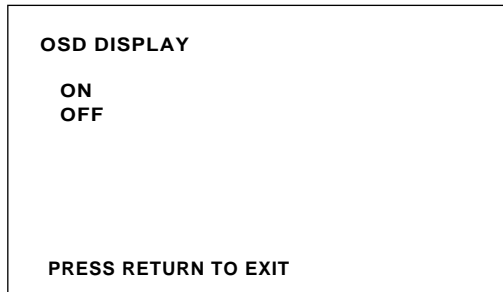

Select a TV screen setting to match your television..

- Use the arrows on the remote to highlight "ON" or "OFF," and then press SELECT.

Changing the Menu Language

Use this feature to change the language for the on-screen menu system for the player, and for discs.

- Press the SETUP button on the remote control.

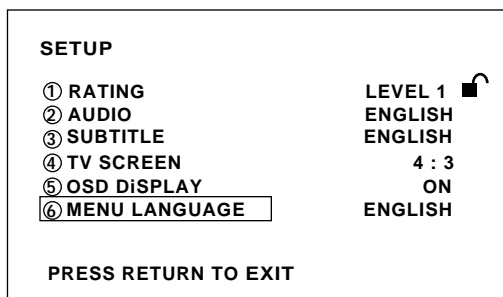

Select MENU LANGUAGE from the Setup menu.

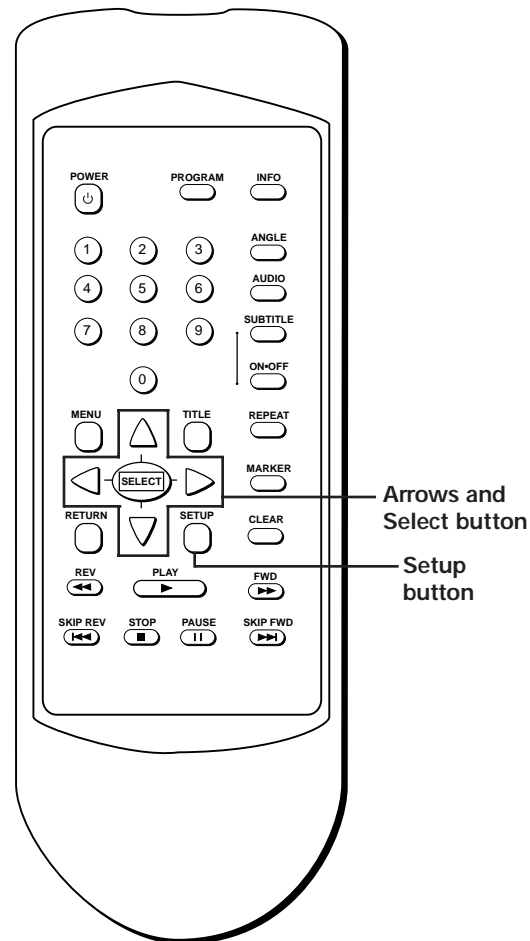

USING THE SETUP MENU

2. Use the arrows on the remote to highlight "MENU LANGUAGE" and then press SELECT.

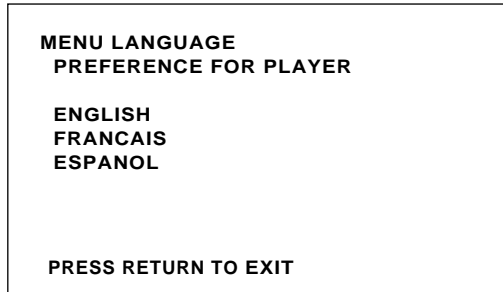

Select a new menu language for the player.

3. Use the arrows on the remote to highlight the desired language for the on-screen menu system, and then press SELECT.

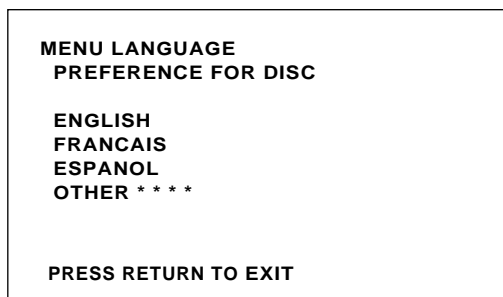

Select a new menu language for discs.

4. Use the arrows on the remote to highlight the desired language for disc menus, and then press SELECT.

If the language you want is not listed, select "OTHER," enter the appropriate code from the list of language codes at the end of this chapter, and then press SELECT.

USING THE SETUP MENU

Don't forget to press the SELECT button after you enter the code.

| Language | Code | Language | Code | Language | Code |
|-----------------|------|------------------|------|----------------|------|
| Abkhazian | 6566 | Hungarian | 7285 | Romanian | 8279 |
| Afar | 6565 | Icelandic | 7383 | Russian | 8285 |
| Afrikaans | 6570 | Indonesian | 7378 | Samoan | 8377 |
| Albanian | 8381 | Interlingua | 7365 | Sangho | 8371 |
| Ameharic | 6577 | Interlingue | 7369 | Sanskrit | 8365 |
| Arabic | 6582 | Inupiak | 7375 | Scots Gaelic | 7168 |
| Armenian | 7289 | Irish | 7165 | Serbian | 8382 |
| Assamese | 6583 | Italian | 7384 | Servo-Croatian | 8372 |
| Aymara | 6588 | Japanese | 7465 | Sesotho | 8384 |
| Azerbaijani | 6590 | Javanese | 7487 | Setswana | 8478 |
| Bashkir | 6665 | Kannada | 7578 | Shona | 8378 |
| Basque | 6985 | Kashmiri | 7583 | Sindhi | 8368 |
| Bengali; Bangla | 6678 | Kazakh | 7575 | Singhalese | 8373 |
| Bhutani | 6890 | Kinyarwanda | 8287 | Siswati | 8383 |
| Bihari | 6672 | Kirghiz | 7589 | Slovak | 8375 |
| Bislama | 6673 | Kirundi | 8278 | Slovenian | 8376 |
| Breton | 6682 | Korean | 7579 | Somali | 8379 |
| Bulgarian | 6671 | Kurdish | 7585 | Spanish | 6983 |
| Burmese | 7789 | Laothian | 7679 | Sundanese | 8385 |
| Byelorussian | 6669 | Latin | 7665 | Swahili | 8387 |
| Cambodian | 7577 | Latvian, Lettish | 7686 | Swedish | 8386 |
| Catalan | 6765 | Lingala | 7678 | Tagalog | 8476 |
| Chinese | 9072 | Lithuanian | 7684 | Tajik | 8471 |
| Corsican | 6779 | Macedonian | 7775 | Tamil | 8465 |
| Croatian | 7282 | Malagsy | 7771 | Tatar | 8484 |
| Czech | 6783 | Malay | 7783 | Telugu | 8469 |
| Danish | 6865 | Malayalam | 7776 | Thai | 8472 |
| Dutch | 7876 | Maltese | 7784 | Tibetan | 6679 |
| English | 6978 | Maori | 7773 | Tigrinya | 8473 |
| Esperanto | 6979 | Marathi | 7782 | Tonga | 8479 |
| Estonian | 6984 | Moldavian | 7779 | Tsonga | 8483 |
| Faroese | 7079 | Mongolian | 7778 | Turkish | 8482 |
| Fiji | 7074 | Naru | 7865 | Turkmen | 8475 |
| Finnish | 7073 | Nepali | 7869 | Twi | 8487 |
| French | 7082 | Norwegian | 7879 | Ukrainian | 8575 |
| Frisian | 7089 | Occitan | 7967 | Urdu | 8582 |
| Galician | 7176 | Oriya | 7982 | Uzbek | 8590 |
| Georgian | 7565 | Oromo (Afan) | 7977 | Vietnamese | 8673 |
| German | 6869 | Panjabi | 8065 | Volapük | 8679 |
| Greek | 6976 | Pashto, Pushto | 8083 | Welsh | 6789 |
| Greenlandic | 7576 | Persian | 7065 | Wolof | 8779 |
| Guarani | 7178 | Polish | 8076 | Xhosa | 8872 |
| Gujarati | 7185 | Portuguese | 8084 | Yiddish | 7473 |
| Hausa | 7265 | Quechua | 8185 | Yoruba | 8979 |
| Hebrew | 7387 | Rhaero-Romance | 8277 | Zulu | 9085 |
| Hindi | 7273 | | | | |

REFERENCE

About the DVD Player

This section includes extra information about the DVD player, including a description of the front panel and front panel display, the back panel, and some basic use and care guidelines.

Troubleshooting

This short troubleshooting section will hopefully solve any problems that you might encounter with your DVD player.

Limited Warranty

The Limited Warranty includes information on getting service for you DVD player.

Front Panel Controls

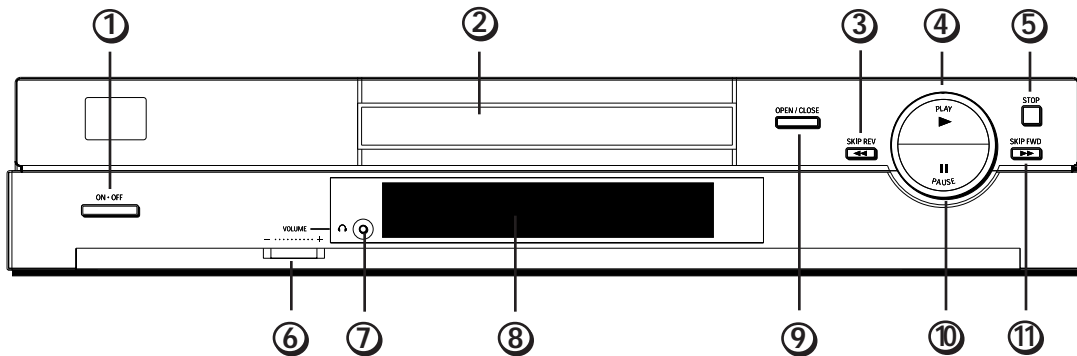

1. ON•OFF button.
2. Disc tray Press OPEN/CLOSE to open and close the disc tray.
3. SKIP REV Allows you move to the beginning of the preceding chapter or track on a disc (in effect, “skipping” the chapter or track).
4. PLAY Begins disc play (and closes disc tray if open).
5. STOP Stops disc play.
6. VOLUME Use to adjust headphone volume level.
7. PHONES Headphone jack.
8. Front Panel Display (See following page for details).
9. OPEN•CLOSE Press to open and close the disc tray.
10. PAUSE Pauses disc play (also use for frame advance).
11. SKIP FWD Allows you move to the beginning of the next chapter or track on a disc (in effect, “skipping” the chapter or track).

Front Panel Messages

The following messages appear in the display:

- OPEN The disc tray is open.
CLOSE The disc tray is being retracted.
NO DISC No disc is loaded.
OFF Power has been turned off.

REFERENCE

Front Panel Display

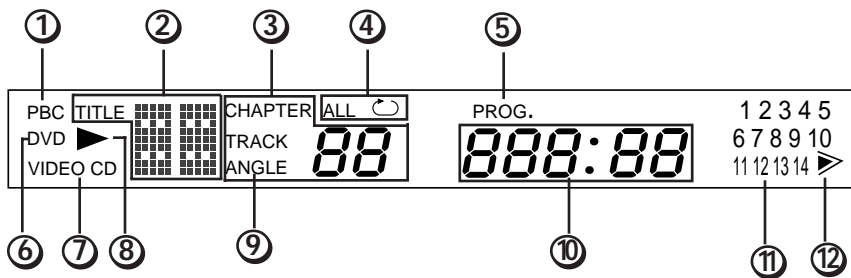

1. Displayed when the Video CD is played using the menu (for example, with playback control).
2. Indicates the play modes or the title number of a DVD.
3. Indicates the chapter number for a DVD.
Indicates the track number for an Audio or Video CD.
4. Indicates repeat play modes: indicates chapter or track repeat. indicates all disc repeat.
5. Indicates Program Playback mode.
6. Indicates that a DVD is loaded.
7. Indicates that a Video CD or CD (audio) is loaded.
8. Indicates Playback mode.
9. Indicates that the Angle feature is activated.
10. Indicates time (i.e. elapsed time of playback).
11. Shows the chapters or track numbers on a disc.
12. Indicates that a disc contains 15 or more chapters or tracks. If the 15th (or subsequent) chapter or track is played, this indicator is lit.

Back Panel

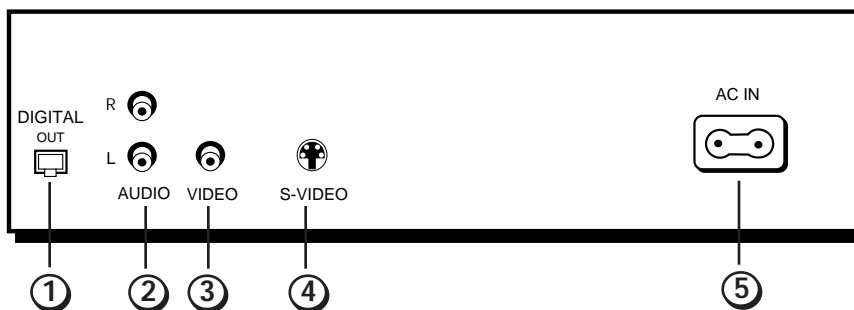

1. DIGITAL OUT Use to connect to a Dolby Digital receiver for best sound quality.
2. AUDIO (R / L) Connect to the audio inputs on your television.
3. VIDEO Connect to the video input on your television for a good quality picture.
4. S-VIDEO Connect to the S-Video input on your television for the best picture quality.
5. AC IN Connect the AC power cord here.

REFERENCE

| Common Problem | Solution |
|---|---|
| No Power | Insert the power plug securely into the outlet. |
| Power turns itself off. | The power is automatically turned off after approx. 30 minutes have elapsed in the stop mode (auto power-off feature). Turn power back on. |
| Play fails to start, even when PLAY is pressed Play commences but then stops immediately | <ul style="list-style-type: none"> • Ensure that the disc is installed with the label side facing up. • This player plays only DVD discs, Audio CDs and Video CDs. • The disc is dirty. Clean it. • Condensation has formed. allow player to dry out. |
| No picture | <ul style="list-style-type: none"> • Ensure that the equipment is connected properly. • Turn on the TV's power. • Ensure that the input setting for the TV is correct. |
| Picture is distorted during rapid advance or reverse | The picture will be somewhat disturbed at these times: this is normal. |
| No sound or distorted sound | <ul style="list-style-type: none"> • Ensure that the equipment is connected properly. • Ensure that the input settings and the volume adjustment for the TV and stereo system are correct. • No sound is heard during still frame advance or slow-motion play |
| No operations can be performed with remote | <ul style="list-style-type: none"> • Check the batteries in the remote. • Operate the remote control at a distance of no more than 20 feet. • Remove any obstacles between the remote and the DVD player |

| DVD Problem | Solution |
|--|---|
| Subtitle and/or audio language is not the one | If the subtitle and/or audio language does not exist on the disc, the initial settings will not be seen/heard. The disc's priority language is selected instead. Set the subtitle and or audio language initial setting manually. |
| No on-screen display | The OFF setting is selected for OSD DISPLAY; select ON. |
| The menu is displayed in a a foreign language. | The MENU LANGUAGE preference is set to that language. Go to the Setup menu and select the language you prefer. |
| Play doesn't begin when a title is selected. | The rating level has been set and the disc is subject to that restriction. |
| No rapid advance or reverse. | Some DVD discs have sections that prohibit rapid advance/reverse. |
| Disc won't play. | Both the player and the DVD is coded by region. If the regional codes don't match, the disc cannot be played. |
| Forgot Rating Limit Password. | With the power on, press and hold the SKIP REV and PAUSE buttons, then press POWER. This resets the password feature, as well as the Setup menu settings. You may be required to select a menu language the next time you power up |
| Cannot copy discs to videotape. | This player is equipped with anticopy protection. |

REFERENCE

| Self-Diagnostic Message | Problem/Solution |
|-------------------------|--|
| U 1 1 | The disc is dirty. Wipe the disc with a soft cloth. |
| H - - F - - | When you see a code that begins with "H" or "F" it means that the unit is not functioning properly. Turn the unit off and on again by pressing the POWER button twice, or unplug the AC power cord from the wall outlet, and then plug the unit back in. This will make the unit operate normally if external electrical influences such as lightning or static electricity have affected the operation of the unit. |

Handling Cautions

- Before connecting other components to this player, be sure to turn them all off.
- Do not move the player while a disc is being played, or the disc may be scratched or broken, and the player's internal parts may be damaged.
- Do not put a flower vase filled with water or any small metal objects on the player.
- Be careful not to put your hand into the disc tray.
- Do not place anything other than the disc in the disc tray.
- Exterior influences such as lightning and static electricity can affect normal operation of this player. If this occurs, turn the player off and on again with the POWER button, or disconnect and then reconnect the AC power cord to the AC power outlet. The player will operate normally.
- Be sure to remove the disc and turn off the player after use.
- Disconnect the AC power cord from the AC outlet when you don't intend to use the player for long periods of time.

Maintenance of Cabinet

For safety reasons, be sure to disconnect the AC power cord from the AC outlet.

- Do not use benzene, thinner, or other solvents for cleaning.
- Wipe the cabinet with a soft cloth.

Formation of Condensation

Due to sharp changes in temperature and humidity, condensation may form if warm air comes in contact with any cold parts inside the player.

- When condensation forms inside the player, the player may not operate correctly. If this occurs, leave the player at room temperature until the inside of the player becomes dry and operational.
- If condensation forms on a disc, wipe the disc with a soft and dry cloth by moving the cloth from the center hole toward the outer edge.

REFERENCE

What your warranty covers:

- Any defect in materials or workmanship.

For how long after your purchase:

- 90 days - Unit exchange, which includes parts and labor.
- 91 days to 1 year - Unit exchange, which includes parts only; you pay the labor.
- The warranty for rental units begins with the first rental or 45 days from date of shipment to the rental firm, whichever comes first.

What we will do:

During the initial 90 days:

Exchange the DVD unit with a new or, at our option, refurbished unit.

After the 90 days and within one year:

Exchange the DVD unit with a new or, at our option, refurbished unit. We will bill you a flat exchange charge to replace a defective unit. This charge covers the labor cost for its repair.

How you get service:

- Call 1-800-311-9263 and have your unit's date of purchase and model/serial number ready. The model/serial number information is on the back of your unit.
- A representative will troubleshoot your problem over the phone.
- If the representative determines that you should receive a replacement unit you will be provided with a Return Authorization (RA) number and the location of a nearby exchange point if one exists. No returns will be accepted without the RA number.

To receive a replacement unit before you return yours:

If you are located near an exchange point:

1. We will send a replacement unit to our exchange point.
2. The exchange location will notify you of its arrival.
3. Take your unit and your evidence of purchase date, such as a bill of sale, to the exchange location and you will be provided the new or refurbished unit. Please retain all accessories such as the remote control hand unit.

REFERENCE

4. If the repairs are covered by your warranty, you will not be billed.

If you are not located near an exchange point:

1. Provide your Discover, MasteGErd or Visa account number and expiration date to your phone representative. This is for security purposes only and your account will not be charged at this time.
2. We will send you a replacement unit.
3. If you return the unit to us within 14 days from the date you were provided a Return Authorization number, only items not covered by warranty will be charged to your account. If your unit is not received within 14 days, the suggested retail value of the unit will be charged to your credit card. This amount will be credited if the unit is subsequently received.
4. Ship your defective unit back to us, excluding all accessories the replacement unit's carton. Shipping instructions will be included in the carton along with your RA number which will allow you to easily ship the unit back to us. Make sure you insure your shipment in case of damage or loss. Include with the shipment:
 - Evidence of purchase date, such as a bill of sale, to verify your unit's warranty eligibility.
 - A brief note describing your unit's problem.
 - Your name, address and phone number.

Thomson assumes no responsibility of warranty shipments from the customer to the factory if not shipped in the manner prescribed by Thomson.

Return transportation, storage, handling and insurance costs are your responsibility. We accept no responsibility in case of damage or loss.

To receive a replacement unit after we have received your unit:

- Write the RA number on the outside of the carton used to return the unit. Make sure you insure your shipment in case of damage or loss.
- Carefully pack the unit using the original box and packing material if possible. Please retain all accessories that were included with your unit such as the remote control hand unit.
- Include with the shipment:
 1. Evidence of purchase date, such as a bill of sale, to verify your unit's warranty eligibility.
 2. A brief note describing your unit's problem.
 3. Your name, address and phone number.
- The representative will advise the address to mail a cashier's check or money order for payment if there are any out of warranty labor or parts charges, and you elect not to use your credit card.
- After we receive your product, a new or refurbished unit will be shipped to you.

What your warranty *does not* cover:

- Acts of God, such as but not limited to lightning damage.
- Adjustment of customer controls.
- Damage from misuse or neglect.
- A unit that has been modified or incorporated into other products or is used for institutional or other commercial purposes.
- Batteries.
- Units purchased or serviced outside the U.S.A.
- Shipping damage if the unit was not packed and shipped in the manner prescribed by Thomson.
- Storage fees may be charged by the exchange point if you fail to pickup the replacement unit in a timely manner.

Product Registration:

- Please complete and mail the Product Registration Card packed with your DVD product. It will make it easier to contact you should it ever be necessary. The return of the card is not required for a warranty coverage.

How state law relates to warranty:

- This warranty gives you specific legal rights and you may have other rights that vary from state to state.

If you purchased your product outside the United States:

- This warranty does not apply. See your dealer for warranty information.

REFERENCE

A

- AC power cord 14
 - connecting 14
- Angles 4
- Audio channel output, changing 28
- Audio language, changing 22
- Audio/Aideo jacks 8

B

- Back panel 47

C

- Camera angle, changing 22
- Care and maintenance 49
- Clear button 4
- Coaxial cable (F-type) 8
- Connections 9

D

- Discs
 - types that can be played 6
- Dolby Digital 4
- Dolby Digital Receiver 8
- DVD menu 16

F

- Fast motion playback 17
- Frame advance 17
- Freeze frame (pause) 17
- Front panel controls 46
- Front panel display 47
 - messages 46
- Front panel messages 46, 49

I

- Info button 5, 32
- Initialized settings 20
- Initial audio language 37
- Initial subtitle language 38

K

- Karaoke 24

L

- Language codes 44
- Limited Warranty 50
- Loading a disc
 - audio 26
 - DVD 16
 - Video CD 30
- Locking the rating level 36

M

- Marker button 23
- Marker feature 23
 - clearing a marker 24
 - playing a marked part 24
- Menu language, changing 41
- Menu languages 14
 - selecting 14
- Menu system navigation tool 14

N

- Navigation tool 14
- "Number out of Range" message 19

O

- ON•OFF button (subtitle feature) 5
- On-screen messages, turning on/off 41
- On-screen navigation tool 14
- Optical cable 8
- OSD Display option (from Setup menu) 41

P

- Password 36
- Picture scan 17
- Playback control (Video CD) 30
- Playback features 17
 - audio CD 26
- Power Button 5
- Program button 5
- Program playback (video CD) 33
- Program playback, audio 28

R

- Rating level 36
- Remote control
 - buttons 4, 4–5
 - installing batteries 6
- Repeat play
 - audio CD 27
 - DVD 18
 - icons 47
 - video CD 32
- RF jack 8
- RF modulator 10

S

- S-Video jack 8
- Searching for scenes by elapsed time 19
- Selecting a title 20
- Selecting a track (video CD) 32
- Self-diagnostic message 49
- Setup button 35
- Setup menu 35, 36
- Skip buttons (Rev/Fwd) 5, 46
- Skipping tracks (audio CD) 26
- Slow motion playback 17
- Subtitle button 5, 21
- Subtitle feature 4, 21, 38
 - changing the language 22
 - initial language 38
 - ON•OFF button 5
 - turning on 39
- Subtitling 4

T

- Title 4
- Title button 5, 20
- Track selection (audio CD) 27
- Track skip (video CD) 31
- TV screen settings 40

V

- Video CD 29

 **THOMSON CONSUMER ELECTRONICS**

10330 North Meridian Street
Indianapolis, IN 46290

©1997 Thomson Consumer Electronics, Inc.

Trademark(s)® Registered

Marca(s) Registrada(s)

Printed in Japan

TOCOM 15180900

Free Manuals Download Website

<http://myh66.com>

<http://usermanuals.us>

<http://www.somanuals.com>

<http://www.4manuals.cc>

<http://www.manual-lib.com>

<http://www.404manual.com>

<http://www.luxmanual.com>

<http://aubethermostatmanual.com>

Golf course search by state

<http://golfingnear.com>

Email search by domain

<http://emailbydomain.com>

Auto manuals search

<http://auto.somanuals.com>

TV manuals search

<http://tv.somanuals.com>