



GE1101P

DVD User's Guide



CAUTION

RISK OF ELECTRIC SHOCK
DO NOT OPEN

TO REDUCE THE RISK OF ELECTRIC SHOCK, DO NOT REMOVE THE COVER (OR BACK). NO USER-SERVICEABLE PARTS ARE INSIDE. REFER SERVICING TO QUALIFIED SERVICE PERSONNEL.



This symbol indicates "dangerous voltage" inside the product that presents a risk of electric shock or personal injury.



This symbol indicates important instructions accompanying the product.

CAUTION: DVD PLAYERS USE A VISIBLE LASER BEAM WHICH COULD CAUSE HAZARDOUS RADIATION EXPOSURE IF DIRECTED. BE SURE TO OPERATE THE PLAYER CORRECTLY AS INSTRUCTED.

CAUTIONS

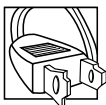

Caution: To prevent electric shock, match wide blade of plug to wide slot, fully insert.

Attention: Pour éviter les chocs électriques, introduire la lame la plus large de la fiche dans la borne correspondante de la prise et pousser jusqu'au fond.

This product satisfies FCC regulations when shielded cables and connectors are used to connect the unit to other equipment. To prevent electromagnetic interference with electric appliances, such as radios and televisions, use shielded cables and connectors for connections.

FCC NOTE (for U.S.A.):

This equipment has been tested and found to comply with the limits for a Class B digital device, pursuant to Part 15 of the FCC rules. These limits are designed to provide reasonable protection against harmful interference in a residential installation. This equipment generates, uses and can radiate radio frequency energy and, if not installed and used in accordance with the instructions, may cause harmful interference to radio communications. However, there is no guarantee that interference will not occur in a particular installation. If this equipment does cause harmful interference to radio or television reception, which can be determined by turning the equipment off and on, the user is encouraged to try to correct the interference by one or more of the following measures.

- Reorient or relocate the receiving antenna.
- Increase the separation between the equipment and receiver.
- Connect this equipment into an outlet on a circuit different from that to which the receiver is connected.
- Consult the dealer or an experienced radio/TV technician for help.

This class B digital apparatus meets all requirements of the Canadian Interference--Causing Equipment Regulations.

Product Registration

Please fill out the product registration card and return it immediately. Returning this card allows us to contact you if needed.

Keep your sales receipt to obtain warranty parts and service and for proof of purchase. Attach it here and record the serial number in case you need it. The number is located on the back of the player.

Model No. GE1101P

Serial No.

Purchase Date:

Dealer/Address/Phone:

WARNING

To reduce the risk of fire or shock hazard, do not expose this DVD player to rain or moisture.

CAUTION

THIS PRODUCT UTILIZES A LASER. USE OF CONTROLS OR ADJUSTMENTS OR PERFORMANCE OF PROCEDURES OTHER THAN THOSE SPECIFIED HEREIN MAY RESULT IN HAZARDOUS RADIATION EXPOSURE. DO NOT OPEN COVERS AND DO NOT REPAIR YOURSELF. REFER SERVICING TO QUALIFIED PERSONNEL.

Note:

This unit can be used only where the power supply is AC 120 V, 50-60Hz. It cannot be used elsewhere.

Note:

This DVD player is designed and manufactured to respond to the Region Management Information. If the Region number of a DVD disc does not correspond to the Region number of this DVD player, this DVD player cannot play the disc. The Region number for this DVD player is Region No. 1.

Note:

This device is protected by U.S. patent numbers 4,631,603 and 4,577,216 and 4,819,098 and other intellectual property rights. The use of Macrovision's copy protection technology in the device must be authorized by Macrovision and is intended for home and other limited pay-per-view uses only, unless otherwise authorized in writing by Macrovision. Reverse engineering or disassembly is prohibited.

**CLASS 1
LASER
PRODUCT**

Table of Contents

Chapter 1: Connections and Setup

Things to Consider Before You Connect.....	6
Types of Discs Your DVD Player will Play	6
Choose Your Connection	7
Cables Needed to Connect Components to Your TV	7
DVD Player + TV with Audio/Video Input Jacks	8
DVD Player + TV + VCR	9
DVD Player + TV + Dolby Pro Logic, Dolby Digital or DTS Receiver	11
DVD Player + TV + Dolby Pro Logic or Stereo Receiver.....	13
DVD Player + TV + VCR + Satellite Receiver	15
The Jacks on the Back of the DVD Player	16
Front Panel Controls	17
Install Batteries in the Remote	18
Important Battery Information	18
Point the Remote in the Right Direction	18
How to Find Your TV's Video Input Channel	19
Remote Control Buttons	20

Chapter 2: Playing DVDs

Regional Coding	24
Using Different Menus	24
Loading and Playing Discs	24
Using a Disc Menu	25
DVD Playback Features	27
Fast Motion Playback (Picture Scan)	27
Freeze Frame and Frame Advance	27
Slow Motion Playback	27
Play Mode	28
Random	28
Program	28
Selecting a Title Number	29
Selecting a Chapter Number	29
Remaining Play time	29
The Index Feature	30
Subtitles	30
Changing the Audio Language	30
Changing the Camera Angle	30
Using the Repeat Feature	30
To Repeat a Chapter or Title	31
A•B Repeat	32

Manufactured under license from Dolby Laboratories. "Dolby" and the double-D symbol are trademarks of Dolby Laboratories. Confidential unpublished works. ©1992-1997 Dolby Laboratories, Inc. All rights reserved.

DTS is a registered trademark of Digital Home Theater Systems, Inc.

Table of Contents

Chapter 3: Playing Audio CDs and MP3 Discs

Loading and Playing an Audio CD	34
Audio CD Playback Features	34
Skipping Tracks	34
Time Search	34
Remaining Play Time	35
Play Mode	35
Random	35
Using the Repeat Feature	36
To Repeat a Track or Disc	36
A-B Repeat	36
Playing Mp3 Discs	37
Pitch	37
Karaoke	38
Pitch	38

Chapter 4: Playing Video CDs

What is a Video CD?	40
The Video CD Disc Menu	40
If the Video CD Has Playback Control	40
Bypassing Playback Control	40
Resuming Playback Control	41
Using the Time Search Feature	41
A-B Repeat	41
Remaining Play Time	41
The Index Feature	42

Chapter 5: The Menu System

The Display Menu	44
Image	44
Standard	45
Angle	45
Menu Language	45
Selecting Digital Output Type	46
Subtitles	46
The Sound Menu	47
Compression	47
Range	47
Mono/Stereo	47
Speakers	48

Chapter 5: The Menu System *(continued)*

Password Setup	49
Creating a Password	49
Changing the Password Mode	49
The Preferences Menu	50
Selecting the Audio Preference	50
Selecting the Subtitle Language	50
Changing the Disc Menu Language	51
Setting the Rating Limit	51
Defaults	52
Language Code List	52

Chapter 6: Other Information

Troubleshooting	54
Warranty	56
Accessories Order Form	59
Index	61

This page intentionally left blank.

Connections and Setup

Chapter Overview

- Things to Consider
- Choose your Connection
- The Jacks on the Back of the DVD Player
- Front Panel Controls
- Front Panel Display
- Installing the Batteries
- How to Find Your TV's Input Channel
- How to Move Around the DVD Player's Menu System
- Set the Menu Language
- Setting Other Options
- The Remote Control



Connections and Setup

Things to Consider Before You Connect

Protect Against Power Surges

- Connect all components before you plug any of their power cords into the wall outlet.
- Turn off the TV and/or components before you connect or disconnect any cables.
- Make sure all antennas and cables are properly grounded. Refer to the Important Safeguards sheet packed with your DVD player.

Protect Components from Overheating

- Don't block ventilation holes on any of the components. Arrange the components so that air can circulate freely.
- Don't stack components.
- When you place components in a stand, make sure you allow adequate ventilation.
- If you connect an audio receiver or amplifier, place it on the top shelf so the heated air from it won't flow around other components.

Position Cables Properly to Avoid Audio Interference

- Insert each cable firmly into the designated jack.
- If you place components above the TV, route all cables down the side of the back of the TV instead of straight down the middle of the back of the TV.
- If your antenna uses 300-ohm twin lead cables, do not coil the cables. Also, keep the twin lead cables away from audio/video cables.

Connection Pictures

Audio/video cables are usually bundled together. For better visibility, the connection pictures in this book show each cable separately (audio left, audio right, and video).

Note: The illustrations in this book are representational, and in some instances may not exactly match the item represented.



Types of Discs Your DVD Player will Play

- DVD video discs – DVD video discs contain high quality picture and sound content.
- Audio discs – Audio CDs contain musical or sound content only.
- Video CDs – Like DVD discs, VCDs contain picture and sound content. VCDs hold less content than DVD discs.
- CD-R (MP3 files) – CD-R discs with MP3 files recorded or downloaded on them..

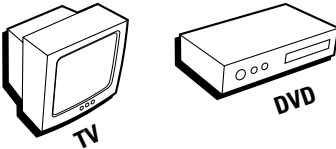

Choose Your Connection

There are several ways to connect your DVD player. Please use the following chart to determine which connection is best for you. Turn to the appropriate page and connect your DVD player.

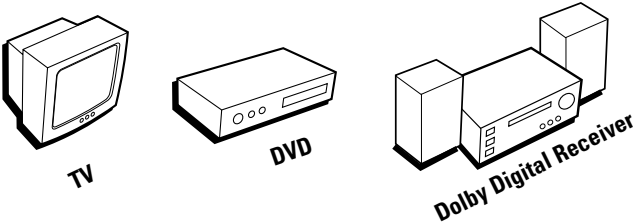
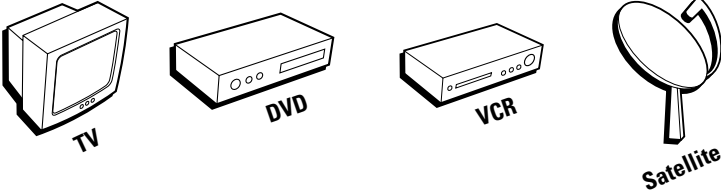
Components	Cables Needed	Connection Title	Go to...
	<ul style="list-style-type: none"> • Coaxial • Audio/video • S-Video (optional) 	TV + DVD	page 8
	<ul style="list-style-type: none"> • Coaxial • Audio/video • S-Video (optional) 	TV + DVD + VCR	page 9
	<ul style="list-style-type: none"> • Coaxial • Audio/video • S-Video (optional) 	TV + DVD + Dolby Digital	pages 10-13
	<ul style="list-style-type: none"> • Coaxial • Audio/video • S-Video (optional) 	TV + DVD + VCR + Satellite	page 14-15

Cables Needed to Connect Components to Your TV

The pictures below show the cables needed for the connections represented in this book.

Note: Audio/Video cables (A/V cables for short) are usually sold as a bundled set, but the connection pictures in this book show each cable separately for better visibility.

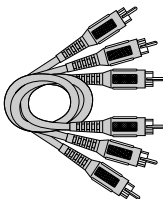

Audio/Video cables

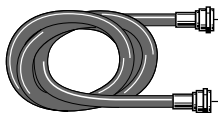

Coaxial cable

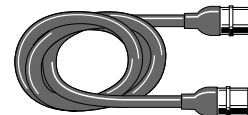

S-Video cable

Connections and Setup

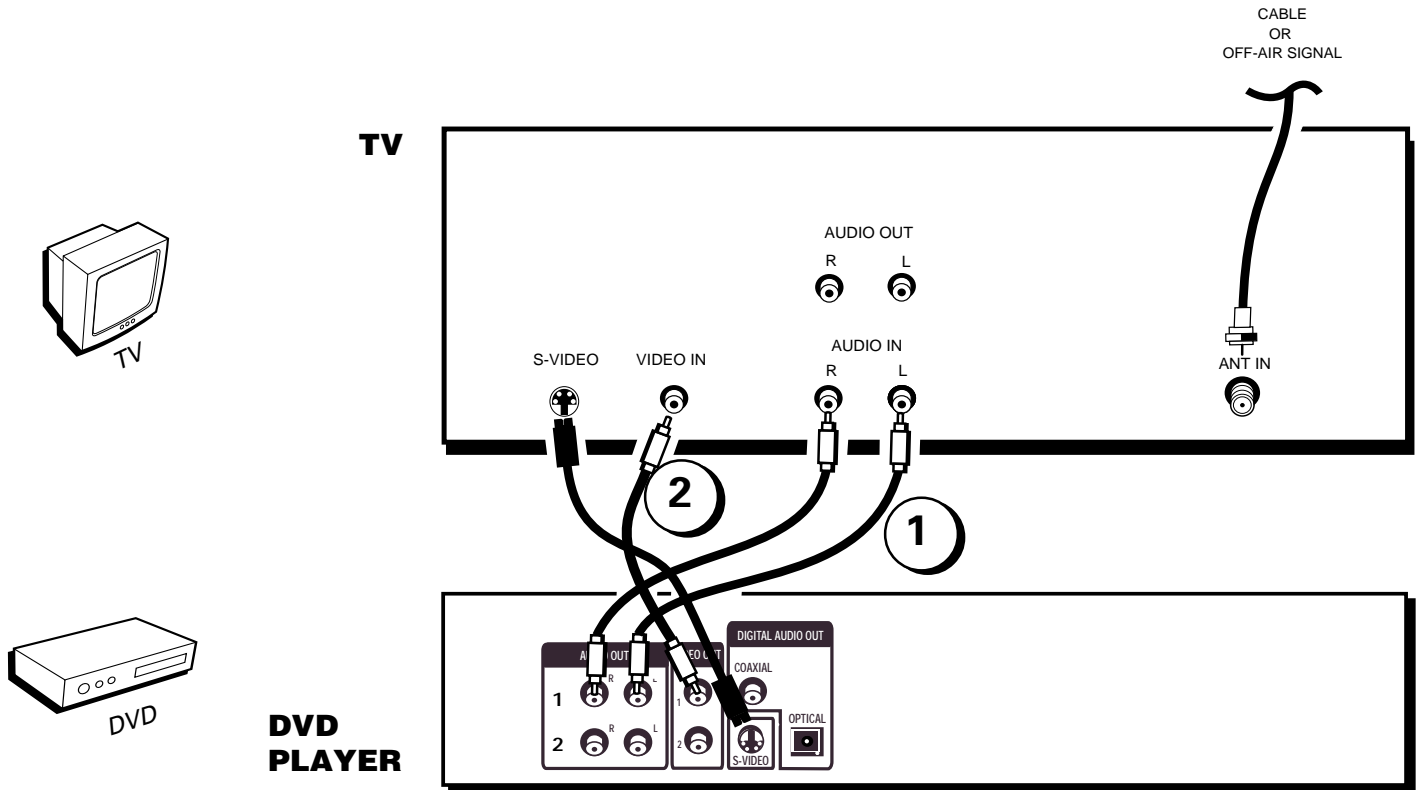

DVD Player + TV with Audio/Video Input Jacks

1. Connect the audio cables to the AUDIO OUT L (left – white) and R (right – red) jacks on the back of your DVD Player, and to the corresponding Audio Input jacks on your TV.
2. Connect the video cable.
 - **Basic video connection** – Connect the video cable (yellow) to the VIDEO OUT jack on the back of your DVD Player, and to the Video Input jack on your TV.

OR

- **S-Video (optional)** – If your TV has an S-Video Input jack, connect the S-Video cable to the S-VIDEO OUT jack on the back of your DVD Player and to the S-Video jack on your TV. If your TV doesn't have S-Video, use the basic video connection listed above.

Note: Your cable or off-air connection to the television should not be affected by this connection. Connect your cable or off-air antenna to your television as you normally would. You may need to consult your television manual for details.

Go to page 19

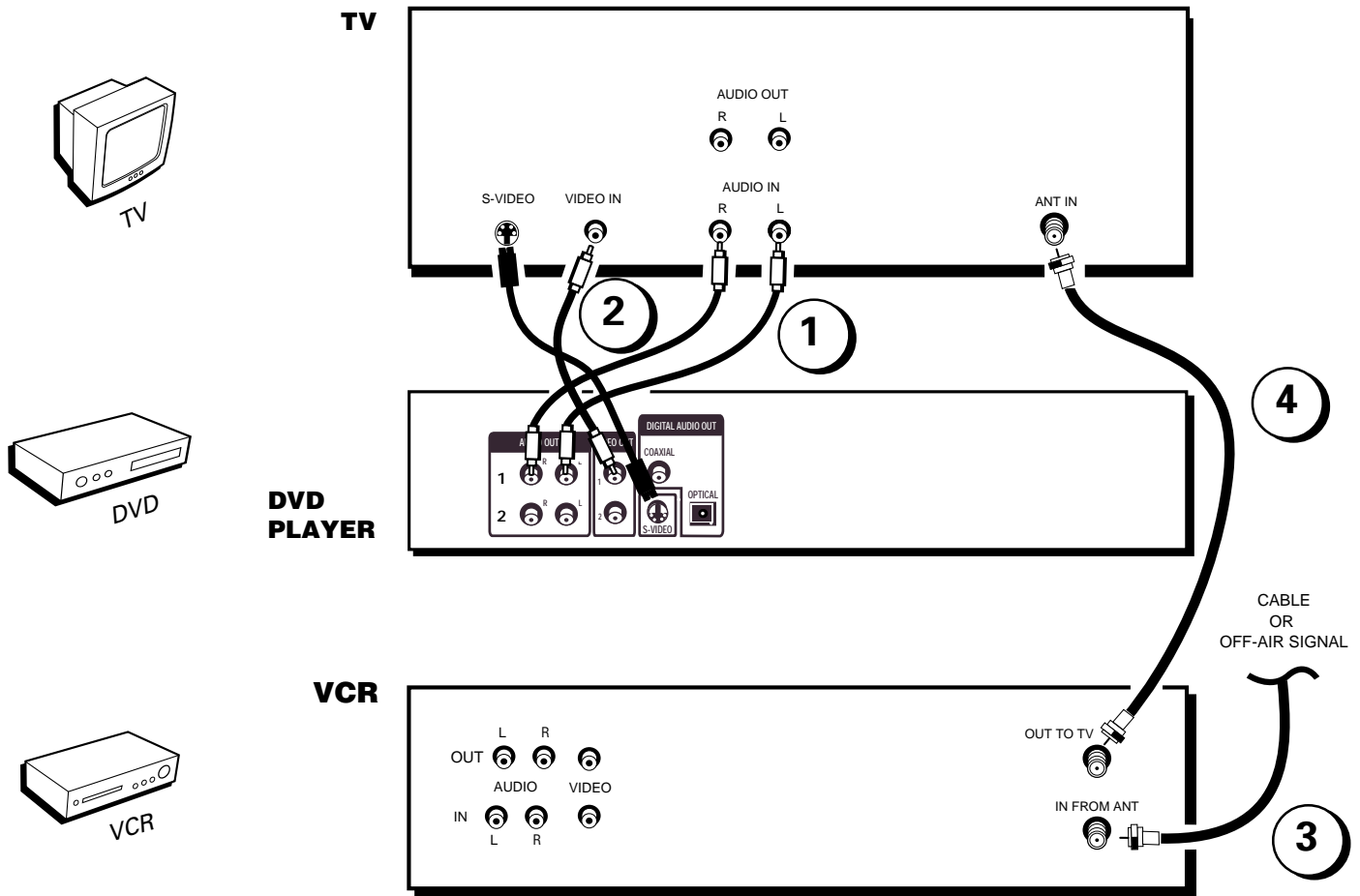

DVD Player + TV + VCR

1. Connect the audio cables to the AUDIO OUT L (left - white) and R (right - red) jacks on the back of your DVD Player, and to the corresponding Audio Input jacks on your TV.
2. Connect the video cable.
 - **Basic video connection** - Connect the video cable (yellow) to the VIDEO OUT jack on the back of your DVD Player, and to the Video Input jack on your TV.
- OR
- **S-Video** (optional) - If your TV has an S-Video Input jack, connect the S-Video cable to the S-VIDEO OUT jack on the back of your DVD Player and to the S-Video jack on your TV. If your TV doesn't have S-Video, use the basic video connection listed above.
3. Connect the antenna or cable to the Antenna Input jack on the VCR.
4. Connect a coaxial cable to the antenna output jack on the VCR and to the Antenna Input jack on the television.
5. Plug the power cord into an AC outlet.

Go to page 19

Connections and Setup

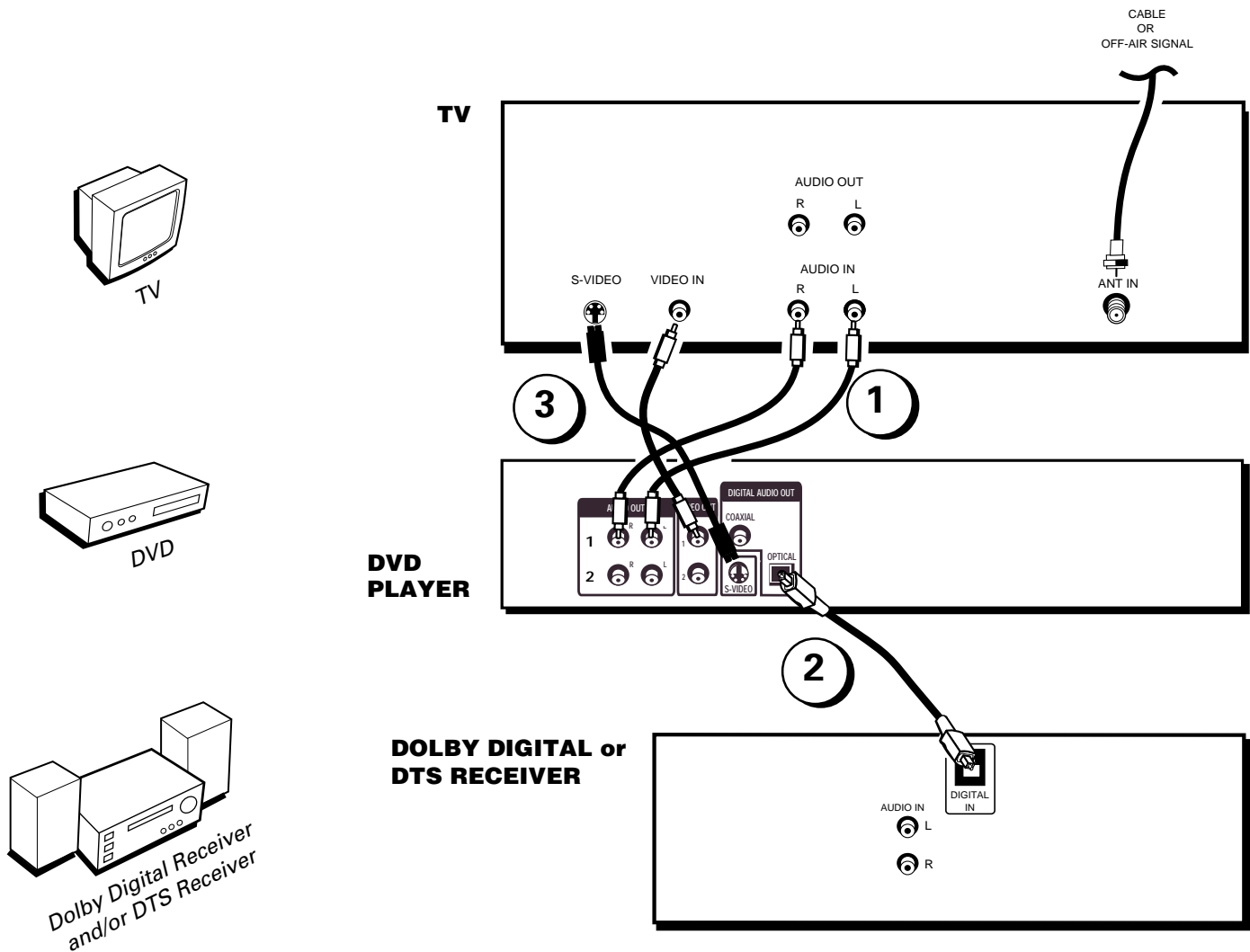

Dolby Digital® and DTS®

Both Dolby Digital and DTS are audio formats used to record 5.1-channel audio signals onto the digital track of film (while the film is being made). Both of these formats provide up to six separate channels: left, right, center, left rear, right rear, and common subwoofer.

The disc will play 5.1-channel sound only if you've connected a DTS or Dolby Digital receiver or decoder and if the original movie the disc was recorded from was encoded in the Dolby Digital or DTS format.

Please Read This Before Using the DIGITAL AUDIO OUT Jack!

This player's digital output jack is designed for a connection to a Dolby Digital or DTS receiver or decoder.

Older digital equipment may not be compatible with the Dolby Digital bitstream. Such a connection can create a high level of noise that may be harmful to your ears, and could damage headphones or speakers.

It is important to choose the correct Digital Output setting in the DVD Player's Sound menu, especially when you use the DIGITAL AUDIO OUT jack. For more information, see chapter 5.

DVD Player + TV + Dolby Digital or DTS Receiver

To Connect the DVD Player

1. Connect the left and right audio cables to your audio/video receiver and to the AUDIO OUT L (left – white) and R (right – red) jacks on the back of your DVD Player.
 2. If you have a Dolby Digital or DTS receiver, insert an optical digital cable (not provided) to the DIGITAL AUDIO OUT jack on the DVD player to the Digital Input jack on the back of the receiver. You must also set the Digital Output setting in the Sound menu (see chapter 5).
 3. Connect the video cable.
 - **Basic video connection** – Connect the video cable (yellow) to the VIDEO OUT jack on the back of your DVD Player, and to the Video Input jack on your TV.
- OR**
- **S-Video** (optional) – If your TV has an S-Video Input jack, connect the S-Video cable to the S-VIDEO OUT jack on the back of your DVD Player and to the S-Video jack on your TV. If your TV doesn't have S-Video, use the basic video connection listed above.
 4. Plug the power cord into an AC outlet.

Go to page 19

Manufactured under license from Dolby Laboratories. "Dolby" and the double-D symbol are trademarks of Dolby Laboratories. Confidential unpublished works. ©1992-1997 Dolby Laboratories, Inc. All rights reserved.

DTS is a registered trademark of Digital Home Theater Systems, Inc.

Connections and Setup

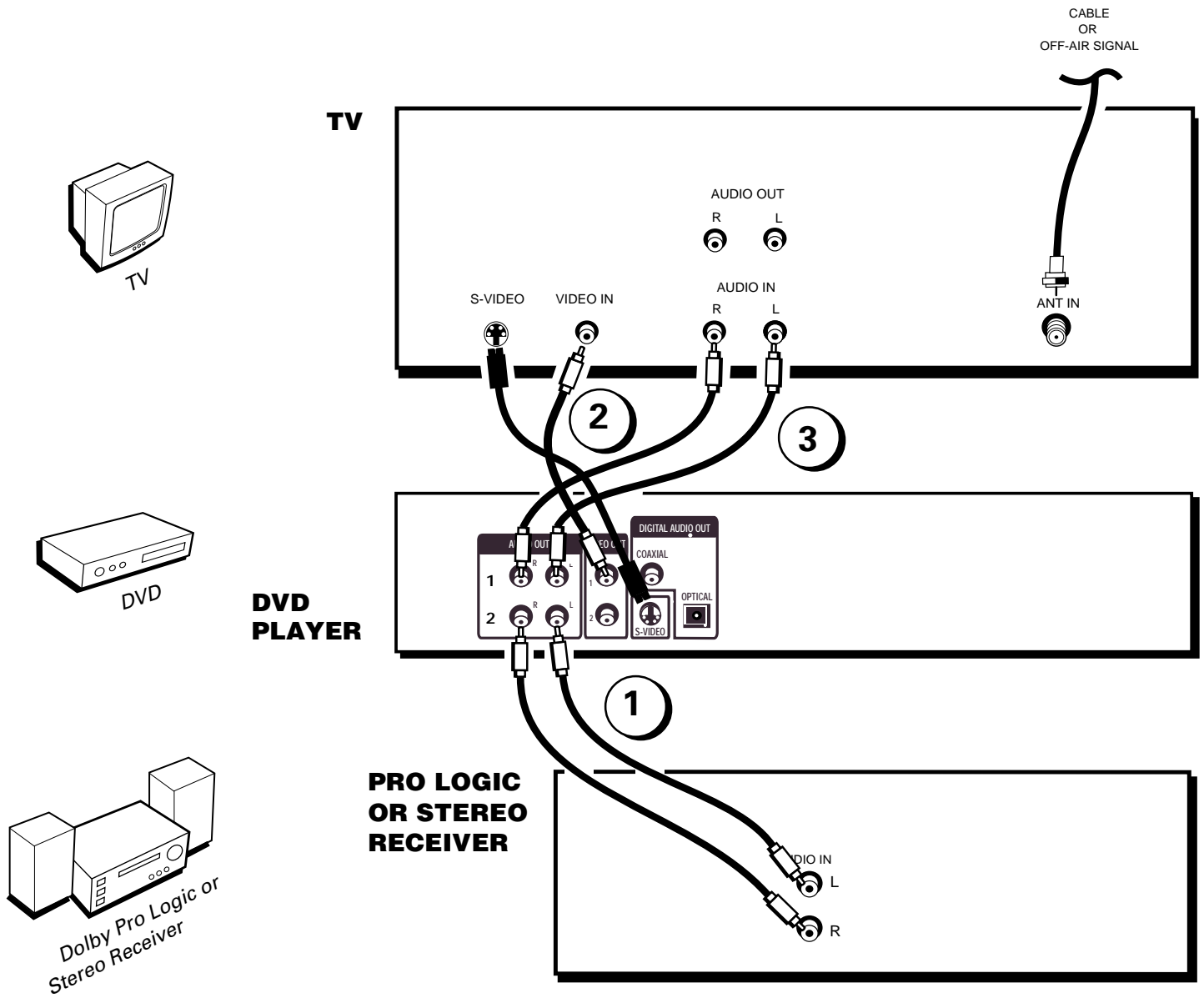

DVD Player + TV + Dolby Pro Logic or Stereo Receiver

To Connect the DVD Player

1. Connect the left and right audio cables to your audio/video receiver and to the AUDIO OUT FRONT L (left – white) and R (right – red) jacks on the back of your DVD Player.
2. Connect the video cable.
 - **Basic video connection** – Connect the video cable (yellow) to the VIDEO OUT jack on the back of your DVD Player, and to the Video Input jack on your TV.

OR

- **S-Video** – If your TV has an S-Video Input jack, connect the S-Video cable to the S-VIDEO OUT jack on the back of your DVD Player and to the S-Video jack on your TV. If your TV doesn't have S-Video, use the basic video connection listed above.
3. **Down Mix Audio** (optional) – Connect the second set of AUDIO OUT jacks on the back of the DVD player to the AUDIO IN jacks on the back of the TV. This allows you to listen to discs without going through the receiver. For example, if it's late at night and you want to listen to a disc without 6-channel sound on, you can turn off the receiver and listen to the disc through the TV speakers.
 4. Connect the AC power cord to an AC outlet.

Go to page 19

Connections and Setup

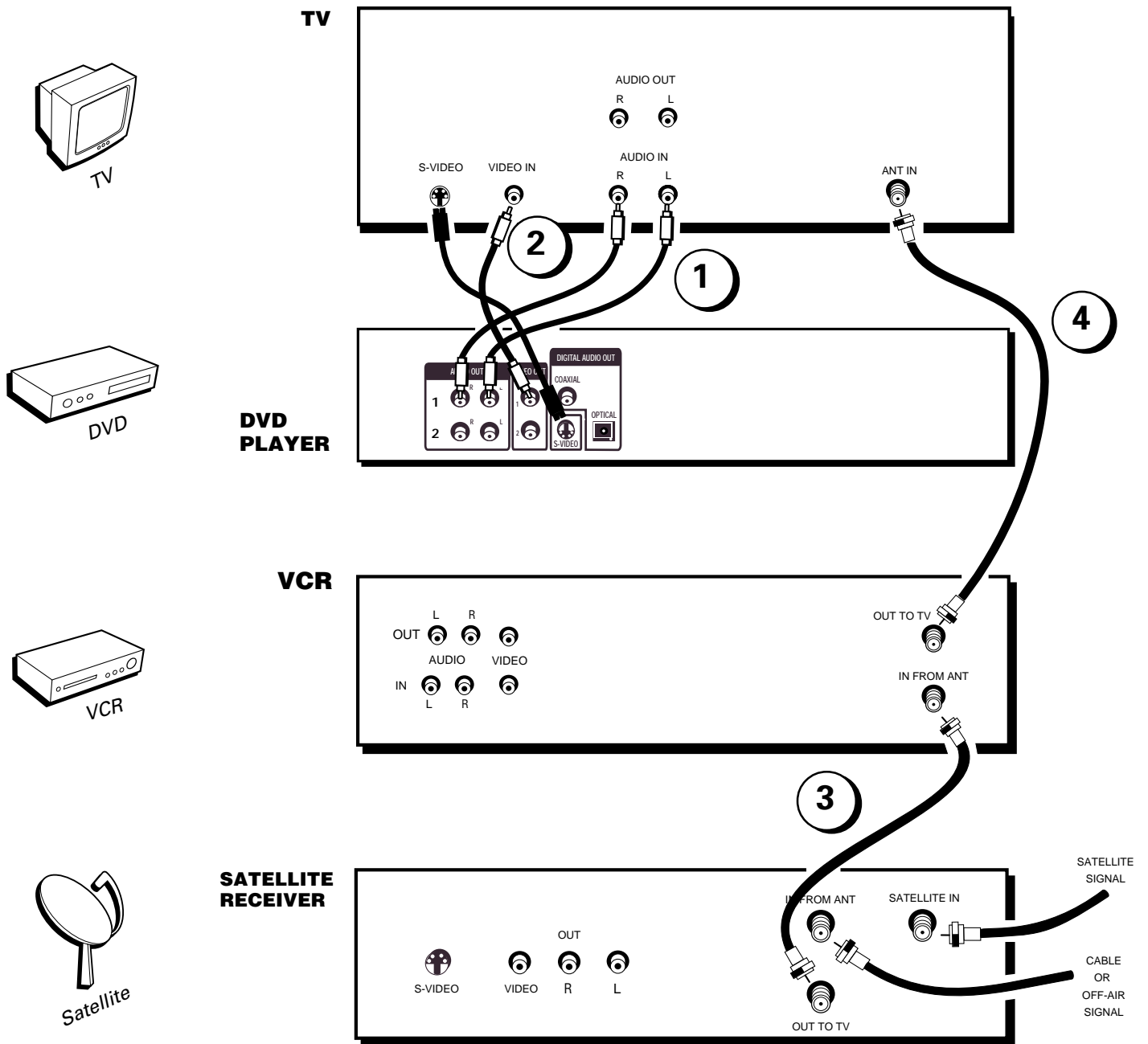

DVD Player + TV + VCR + Satellite Receiver

1. Connect the audio cables to the AUDIO OUT L (left – white) and R (right – red) jacks on the back of your DVD Player, and to the corresponding Audio Input jacks on your TV.
 2. Connect the video cable.
 - **Basic video connection** – Connect the video cable (yellow) to the VIDEO OUT jack on the back of your DVD Player, and to the Video Input jack on your TV.
- OR**
- **S-Video** (optional) – If your TV has an S-Video Input jack, connect the S-Video cable to the S-VIDEO OUT jack on the back of your DVD Player and to the S-Video jack on your TV. If your TV doesn't have S-Video, use the basic video connection listed above.
 3. Connect a coaxial cable to the antenna output jack on the VCR and to the Antenna Input jack on the television.
 4. Use a coaxial cable to connect the antenna output on the satellite receiver to the antenna input on the VCR.
 5. Plug the power cord into an AC outlet.

Go to page 19

Connections and Setup

The Jacks on the Back of the DVD Player

When connecting, make sure you connect Output jacks to Input jacks, Video to Video, Right Audio to Right Audio, etc.

AUDIO OUT R and L

Insert audio cables (left and right) from these jacks on your DVD player to the corresponding Audio Input jacks (left and right) on your TV or receiver.

VIDEO OUT

(Composite Video Output)
Connect a video cable to this jack and to the Video Input jack on your TV.

DIGITAL AUDIO OUT

Use a digital optical cable (not provided) to connect your DVD Player to a compatible Dolby Digital or DTS receiver or decoder.

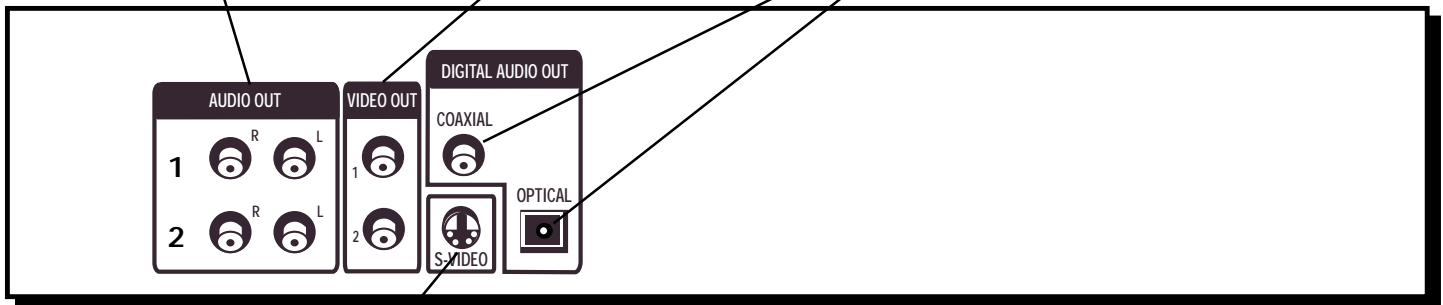

S-VIDEO

If your TV has an S-Video jack, you can connect an S-Video cable for increased video quality. The S-Video cable only carries the picture signal; remember to connect the left and right audio cables.

Front Panel Controls

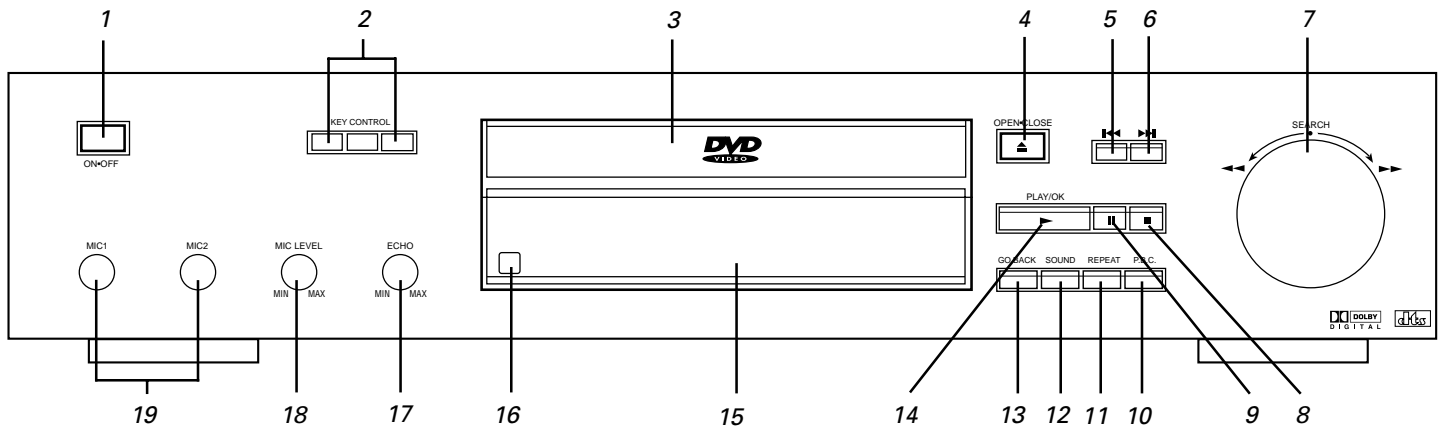

1. **ON•OFF** Use to turn the power on and off.
2. **Pitch** Controls pitch when playing karaoke discs. Press \flat to lower the pitch. Each push of the button lowers the pitch one step, up to seven steps. Press \sharp to raise the pitch.
3. **Disc Tray** Press OPEN•CLOSE to open and close disc tray.
4. **OPEN•CLOSE** Press to open and close the disc tray.
5. **Previous** Moves to the beginning of the preceding title, chapter, or track on a disc (in effect, “skipping” the title, chapter, or track). Press and hold to reverse through the DVD or CD; each subsequent press and hold increases the reverse speed.
6. **Next** Moves to the beginning of the next title, chapter, or track on a disc (in effect, “skipping” the title, chapter, or track). Press and hold to forward through the DVD or CD; each subsequent press and hold increases the forward speed.
7. **SEARCH** Turn the knob to the right for fast forward motion playback. Turn the knob to the left for fast reverse motion playback.
8. **STOP** Stops disc play.
9. **PAUSE** Pauses disc play.
10. **P.B.C.** For Video CDs with playback control, turns playback control on/off.
11. **REPEAT** Accesses Repeat modes.
12. **SOUND** Changes the audio language.
13. **GO BACK** Returns to the previous menu.
14. **PLAY** Begins disc play (and closes disc tray if open).
15. **Front Panel Display** (See following page for details.)
16. **Remote Sensor** The sensor that reads signals from the remote.
17. **Echo** Controls the amount of echo when playing a Karaoke disc.
18. **MIC LEVEL** Controls the microphone volume level when playing a karaoke disc.
19. **MIC1/MIC2** Plug in a karaoke microphone here.

Install Batteries in the Remote

1. Remove the battery compartment cover on the back of the remote.
2. Insert new batteries. Match the polarities (+ and -) on the batteries with the diagram on the remote.
3. Put the battery compartment cover back on the remote.

Important Battery Information

- If you're not going to use the remote for a month or more, be sure to remove the batteries because they can leak and cause damage.
- Dispose of batteries in the proper manner, according to federal, state, and local regulations.
- Any battery may leak electrolyte if mixed with a different battery type, if inserted incorrectly, if all batteries are not replaced at the same time, if disposed of in fire, or if an attempt is made to charge a battery not intended to be recharged.
- Discard leaky batteries immediately. Leaking batteries can cause skin burns or other personal injury.

Point the Remote in the Right Direction

When you want the remote to operate the DVD Player, point the remote at the DVD Player, *not* the TV. The remote has to be pointed in the correct direction and toward the correct component in order for the remote control's signal to communicate with the sensor on the component. Make sure there is a clear path between the remote control and the component you want to operate so the signal isn't blocked.

Turn on the TV and DVD Player

How to Find Your TV's Video Input Channel

You need to tune your TV to the Video Input Channel (or S-Video Channel if you connected the S-Video cable to your TV and to your DVD Player) to see the DVD Player's menu and to see the content that's on a disc. The video channel on TVs varies for different brands and different models. In order for your DVD remote to work, your TV must be set on the correct video input channel.

- If your TV brand is RCA, GE, or PROSCAN, press the TV button on the TV remote (not the DVD remote). Then press the INPUT button on the remote.
- If you have another brand, consult your TV's Owner's Manual.

If those options don't work, try one of the following options.

- Press a button on the TV remote (see table below).
- Select it from the TV's menu system.
- Tune directly to the DVD input channel by pressing a specific number (see table below).
- Go through all the channels in the channel list by pressing the channel up/down buttons on the TV.

Some common scenarios are listed in the following table:

Video Input Channel Variations		
Button/switch on the TV	Button on the TV Remote	Channel #
VIDEO	VID 1	00
SIGNAL	LINE	90
VID 1	VID	91
VID 2	VIDEO	92
S-VID	S-VID	93
S-VIDEO	INPUT	VID 1
	S-VIDEO	VID 2
	SOURCE	
	AUX	

Connections and Setup

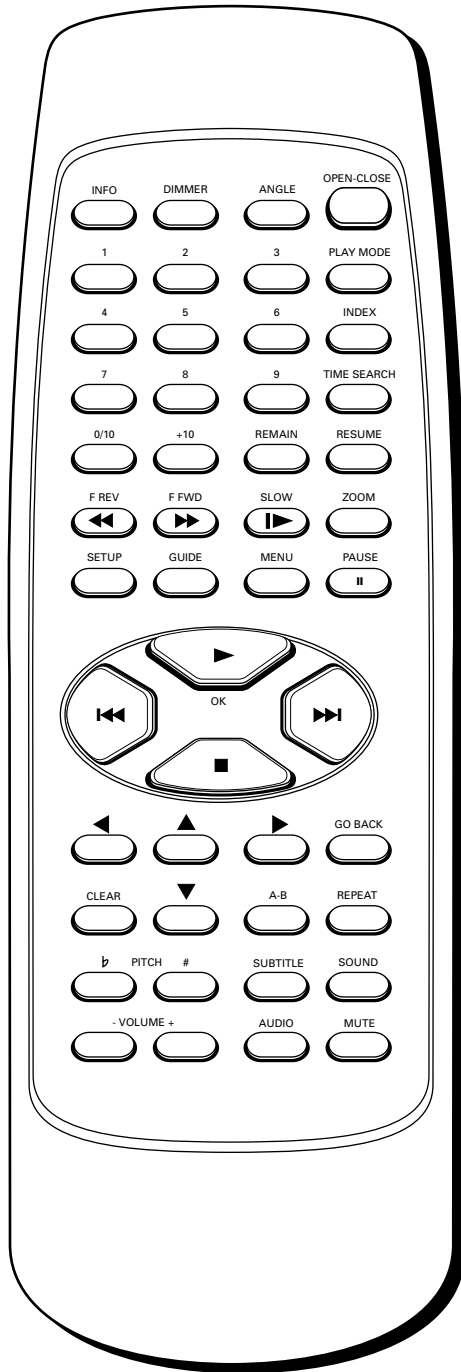

Remote Control Buttons

(from left to right)

This section describes what each button does when the remote is operating the DVD Player.

INFO Brings up the Info Display.

Dimmer Dims the display panel on the front of the player. The first press dims the display, the second press turns it off completely, and the third press returns the display to normal.

OPEN/CLOSE Press and hold to open and close the disc tray.

Number buttons (1-9) Use the number buttons to input information such as chapter numbers, track numbers, or to make selections on some menu screens.

Number buttons (0/10 and +10) The 0/10 button is used to enter a zero or a 10. The +10 button is used to enter numbers larger than 10. For the number 11, press +10 and 1. For 12, press +10 and 2, etc. The +10 button is also used to enter 2-digit numbers larger than 19. Each consecutive press of the button increases by ten. For example, press +10 twice for the number 20. So, if you press the +10 button 3 times, the number displayed is 30. For the number 34, you would press the +10 button three times and the 4 button once.

PLAY MODE Press this button to access the Play Mode info banner to set random and program playback.

INDEX Displays a pictorial index of chapters or tracks.

TIME SEARCH Allows you to select a title or chapter and begin playback from that point.

REMAIN Shows the remaining playback time of titles and chapters.

RESUME Continues playback from point where playback was stopped.

REV Press this button during playback to reverse the disc one frame at a time.

FWD Press this button during playback to advance through the disc one frame at a time.

SLOW Plays content in slow motion.

ZOOM Zooms in on picture.

SETUP Accesses the DVD player's menu system.

GUIDE Accesses the DVD disc guide (if available).

MENU Brings up the DVD player menu.

II Press this button to pause disc play. For DVD discs, press again to play forward a frame at a time.

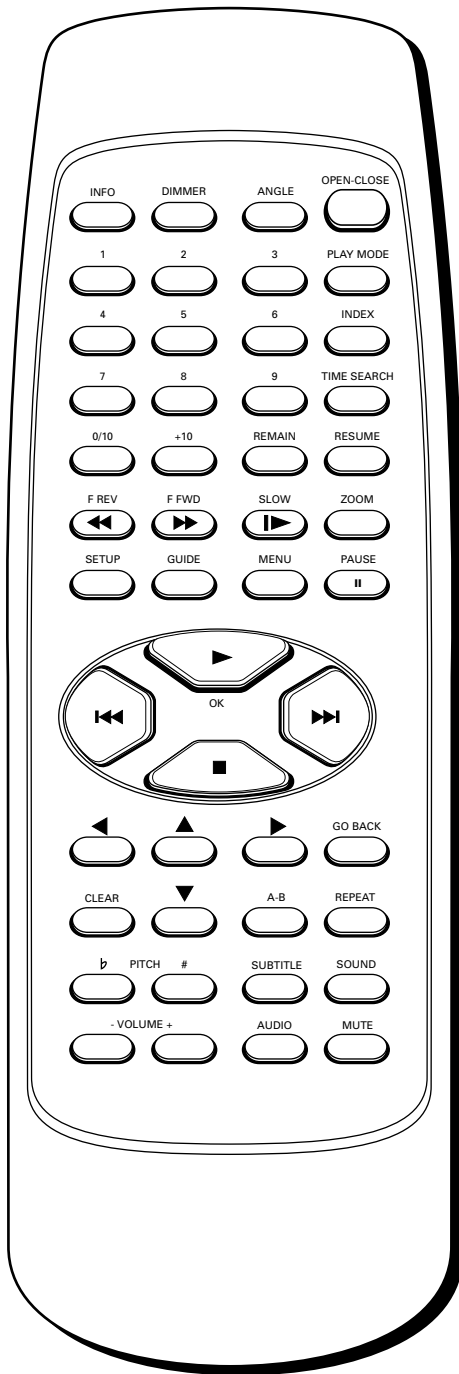

PLAY/OK Begins disc play and selects menu items.

⏮ Allows you to search backward through a disc while it is in play mode. Advances backward one chapter at a time.

⏭ Allows you to search forward through a disc while it is in play mode. Advances forward one chapter at a time.

STOP Stops disc play.

Arrow buttons Use the arrow buttons (left, right, up, and down) to move through the on-screen menus. You highlight a menu item by pressing the arrow buttons and select a highlighted item by pressing the OK button.

GO BACK Returns you to the previous menu.

CLEAR Clears on-screen displays from screen.

A-B Allows you repeat a portion of the disc from a designated point (A) to another designated point (B).

REPEAT Press this button to bring up the Repeat info banner. You can repeat part or all of a chapter, track, or an entire disc.

PITCH Controls pitch when playing karaoke.

SUBTITLE When a disc is playing, press this button to show the Subtitle banner (if the disc was created with subtitles).

SOUND Switches between Stereo and Mono.

ANGLE Press this button to access various camera angles on a disc (if the disc contains multiple camera angles).

VOLUME +/- Adjusts the volume level.

AUDIO Allows you to select a different language to play a DVD disc in (provided the disc was authored with multiple languages).

MUTE Lowers the volume to an inaudible level.

This page intentionally left blank.

Playing DVDs

Chapter Overview

- Regional Coding
- Using Different Menus
- Loading and Playing Discs
- Using a Disc Menu
- DVD Playback Features
- Using the On-Screen Info Banner
- Special Features



Playing DVDs

Regional Coding

Both the DVD player and the discs are coded by region. These regional codes must match in order for the disc to play. If the codes don't match, the disc won't play. This player's code is region 1.

Using Different Menus

Each disc is programmed with different features. There are three separate ways you can use to access features:

- **The Disc menu** – The Disc menu is part of each disc and is separate from the DVD player's menu. The contents of each disc menu varies according to how the disc was authored and what features are included. The disc menu is turned on and off (while the disc is playing) with the MENU button on the remote.
- **The DVD player menu** – The DVD player's menu system is accessed only when a disc isn't playing. Press MENU on the remote to bring up the DVD player menu.

Remember that a feature will only work if the disc was programmed with that feature. For example, if you have subtitles turned on, the subtitles will only appear if the disc was created with subtitles. If a menu item is "grayed out" it means that item isn't available.

- **Information Banners** – Banners are a type of information display that appear across the top of the screen during playback. Information banners are activated by pressing the INFO button on the remote.

Loading and Playing Discs

Your DVD player plays DVD discs and audio CD discs. Before you load a disc, make sure that it is compatible with the player. The following discs CANNOT be used with this player:

- Laserdiscs
- CD-I, CD-ROM (computer-only discs), CD-RW, DVD-ROM
- Discs recorded using other broadcast standards (i.e. PAL or SECAM)
- CD-G discs play audio only, not graphics

To Load and Play a Disc

Turn on the TV and your DVD player (press ON•OFF on the player or the remote control).



This is an example of a one-sided disc.

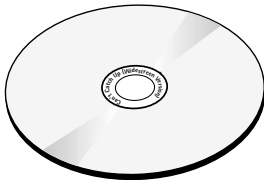

This is an example of a 2-sided disc. The title is in the center.

1. Press the OPEN•CLOSE button on the remote control or the front of the DVD Player.
2. Place a disc gently into the tray with the disc's label facing up (double-sided discs have content on both sides, so you can place either side up).
3. Press the OPEN•CLOSE or PLAY button on the front of the player to close the disc tray.

The DVD Player reads the disc's table of contents, and then one of three things happens depending on how the disc was programmed:

- The disc starts playing.
- The disc menu appears on the screen. One of the options will start disc play. Highlight that option and press OK.
- The DVD Player's main menu appears on the screen. Press the PLAY/OK button on the remote.

When you stop playing a disc, the player remembers where you stopped. When you start playing the disc again, the DVD Player picks up where you left off. To begin the title over, press STOP twice.

Using a Disc Menu

A disc is capable of having an on-screen menu that is separate from the DVD player's menu system and on-screen information banners. The disc menu might only contain a list of the titles and chapters, or it may allow you to change features such as language and playback settings.

Note: "Default settings" are the settings that the player will default to each time it is turned on.

Any settings you change with the disc menu only temporarily override the default settings.

Use the Setup Menu of the DVD player to change the default settings (See chapter 6).

Although the content and operation of disc menus varies from disc to disc, the following example will give you an idea of what to expect.

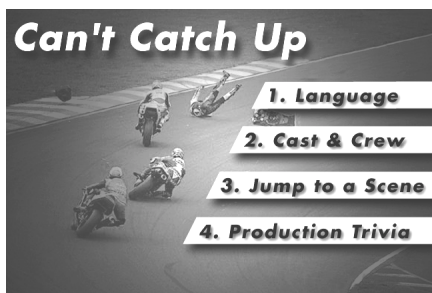

An example of a disc menu. Menus on discs vary.

1. While the disc is playing, press MENU. The disc menu appears.

Tip

Many discs skip the disc menu and start playing automatically. To access the disc menu when you're playing a disc, press MENU on the remote.

Playing DVDs

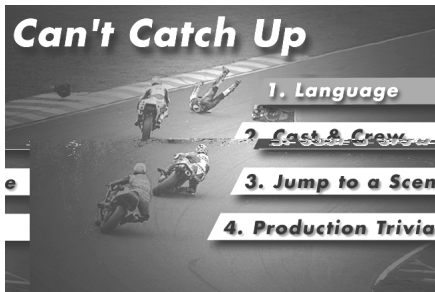

In this example, The *Language* setting is highlighted. To see language options, press OK on the remote.



In the example on the left, English is highlighted. Press OK on the remote to play the disc with English dialog.

2. Press the up/down arrow buttons to highlight the menu item you want to choose, and press OK. In the example on the left, *Language* has been highlighted.

3. Press the up/down arrows to select a language, and press OK.
4. Press MENU to resume playback.

Note: Any settings you change on the disc menu only override the settings in the DVD Player's menu temporarily. Default settings are the settings that you set up in the DVD Player's menu system. To change the default settings, see Chapter 5.

DVD Playback Features

Fast Motion Playback (Picture Scan)

You can search in forward or reverse mode.



In the above example, the picture advances 2 frames at a time.

1. Press the REV or FWD button on the remote during playback to search through a disc.
2. Press the button again on the remote to search at the next speed. Picture Scan has 4 speeds. With each consecutive press of the button, the search speed increases. If you press the button more than 5 times, Picture Scan cycles back to normal playback.
3. Press the PLAY/OK button on the remote to resume normal playback.

Freeze Frame and Frame Advance

1. Press **||** once to freeze playback.
2. Press of the **||** button again to advance the picture one frame at a time.
3. Press PLAY/OK to resume normal playback.

Slow Motion Playback

1. Press SLOW on the remote for forward slow motion playback.
2. Press the button again to decrease the speed. With each consecutive press of the SLOW button, the playback speed decreases. For example, The first press of the SLOW button plays back at 1/2 speed, , the second press plays back at 1/4 speed, etc.
3. To resume normal playback, press PLAY/OK or keep pressing the REV button until normal playback is resumed.

Skipping Chapters

Use the **▶▶** button to go to the next chapter and the **◀◀** button to go to the previous chapter.

Playing DVDs

Play Mode

Random

The Random option plays a disc's chapters in random order. If there is more than one title, the title with the most chapters is selected. If there is more than one title and all titles have an equal amount of chapters, the first title is selected. If each title has only one chapter each, the titles/chapters will be played in random order.

1. Press STOP twice to stop playback.
2. Press PLAY MODE on the remote control (the Play Mode info banner appears).
3. Press the PLAY MODE button until the *Random* option is displayed.
4. Press PLAY/OK.

To stop Random playback, press STOP and PLAY/OK to resume normal playback.

Program

The Program playback option allows you to enter the order in which you want chapters to play.

1. Press STOP twice to stop playback.
2. Press PLAY MODE on the remote control (the Play Mode info banner appears).
3. Press the PLAY MODE button until the PROGRAM option is displayed.
4. Use the number buttons to enter the chapters/tracks in the order you want them to play.
5. Press PLAY/OK. The chapters will play in the programmed order.

To stop Program playback, press STOP and PLAY/OK to resume normal playback.



In the example above, the first chapter in the program will be the fifth chapter.

Selecting a Title Number

1. Press the TIME SEARCH button on the remote control to bring up the Info Display.
2. Use the left/right arrow keys to highlight the *Title* number. Use the number buttons to enter the title you want to play.

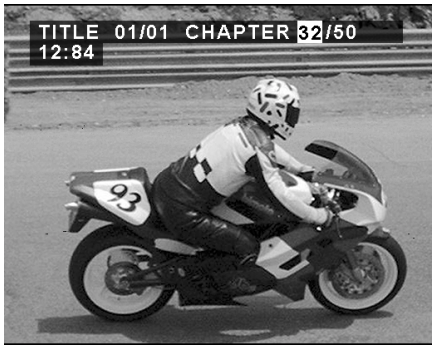

In the example above, the Chapter number is highlighted. Use the number buttons on the remote to enter the desired chapter number.

Selecting a Chapter Number

1. Press the TIME SEARCH button on the remote control to bring up the Info Display.
2. Use the left/right arrow keys to highlight the *Chapter* number. Use the number buttons to enter the chapter you want to play.

Notes:

These features won't work with a DVD without title and chapter numbers.

Using Time Search to Enter an Elapsed Time

You can use the TIME SEARCH feature to go to a specific point in a Title.

1. Press the TIME SEARCH button twice (The time prompt appears in place of the Chapter information).
2. Use the number buttons to enter the elapsed time you want to go to in that title. For example, entering 01:35:12 will start playback one hour, thirty-five minutes and twelve seconds into the title.

Note: Use the 0/10 button to enter zeros. For example, to enter 01:21:36, press the 0/10 button, then the 1, then the 2, etc.

Remaining Play Time

You can use the REMAIN button on the remote to see the remaining time of a title, chapter or track.

1. Press the INFO button to bring up the Info Display.
2. Press the REMAIN button on the remote. The currently elapsed time is displayed.
3. Press REMAIN again. The remaining running time of the currently playing title is displayed.
4. Press REMAIN a third time. The elapsed chapter time is displayed.
5. Press the REMAIN button a fourth time. The remaining time for the currently playing chapter is displayed.
6. Press CLEAR to clear the display from the screen.

Playing DVDs

The Index Feature

The index feature displays small pictures or “thumbnails” of each chapter on the disc.



The Index feature displays thumbnails of each chapter in the current title.

1. Press STOP twice.
2. Press the INDEX button (the index may take a moment to load).
3. The screen displays thumbnails of the first nine chapters. Each thumbnail has a number in the corner. You can select and play a chapter by pressing that number on the remote.
4. To view the next nine thumbnails, press the ►► button to go forward and the ◀◀ button to go to the previous page.
5. To exit the index without making a selection, press the STOP button.

Subtitles

When a DVD is recorded with subtitles, you can use the Subtitle feature to view the subtitles on-screen. To turn subtitles on:

1. Press the SUBTITLES button on the remote. The Info Banner displays the default subtitle language and the number of subtitle languages available. If no subtitles are available, the screen displays NO SUBTITLE.
2. Press the SUBTITLE button again to turn subtitles on. The subtitles will be displayed in the default language. To display subtitles in a different language, press the SUBTITLES button to scroll through the available subtitles.
3. To turn subtitles off, press the SUBTITLES button until subtitles are off.

Note: If the disc does not contain this language, the disc's default language is automatically selected.



When the SUBTITLES button is pressed, the Info Display shows the number of available subtitles and the currently selected subtitle.

Changing the Audio Language

When a DVD is recorded with multiple soundtracks, you can use the Audio feature to temporarily change the audio language (the language of the soundtrack).

1. During disc playback, press AUDIO on the remote (the audio language banner appears).
2. Press the AUDIO button to scroll through available languages.

Note: When you play a disc the player's default audio language is selected. If the disc does not contain this language, the disc's default language is automatically selected.

This feature is disc-dependent, and may not work with all DVDs.

Changing the Camera Angle

Some DVDs contain multiple angles of a particular scene or sequence.

1. During disc playback, press ANGLE on the remote. (The angle icon appears. If no additional camera angles are available, the  symbol will be displayed.)
2. If multiple camera angles are available, the ANGLE icon displays the current angle number and the number of angles available. For example, 1/4 indicates that angle one is being displayed, and there are four different angles available.
3. Press the ANGLE button again to go to the next camera angle.
4. To resume normal playback, scroll through the camera angles until ANGLE turns off.

Note: This feature does not work when a DVD has not been recorded with a multi-camera angle system.

Using the Repeat Feature

There are four repeat options:

- Off
- Chapter – repeats the chapter that is playing
- Title – repeats the title that is playing
- A-B Repeat – repeats a selected segment of the disc

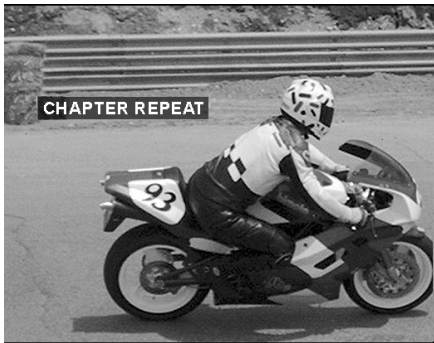

Press the REPEAT button to select Title or Chapter Repeat.

To Repeat a Chapter or Title:

The REPEAT button toggles between chapter repeat, title repeat and off.

1. While a disc is playing, press REPEAT (the repeat banner appears).
2. Press REPEAT again to turn on chapter repeat. The current chapter will repeat until you turn REPEAT off or select title repeat.
3. To repeat a title, push the REPEAT button again.
4. To turn repeat off, press the REPEAT button until REPEAT OFF is displayed.

A-B Repeat

A-B Repeat lets you repeat a specific segment on the DVD that you define.



Use A-B Repeat to set a specified segment to repeat.

1. At the start of the segment you want to repeat, Press the A-B button on the remote. The Info Display shows “REPEAT A.”
2. Allow the movie to play to the end of the segment you want to mark. You must let the movie play in standard playback mode to set the B point in A-B Repeat. If you rewind or fast-forward, A-B Repeat is cancelled.
3. Press A-B again to set the B point.
4. The segment that you set plays until you turn off Repeat. To turn A-B repeat off, press A-B to resume normal playback.

Playing Audio CDs and MP3 discs

Chapter Overview

What is a CD
How to play a CD
What is an MP3 disc
How to play an MP3 disc



Playing Audio CDs and MP3 Discs

Loading and Playing an Audio CD

Be sure that the disc is inserted with the label facing up. Do not touch the disc surface. Do not use a CD-ROM drive to play an audio CD. Do not use a DVD-ROM drive to play an audio CD. Do not use a CD-ROM drive to play a DVD-ROM disc. Do not use a DVD-ROM drive to play a CD-ROM disc.

Label side

CD-I, CD-ROM, DVD-ROM

MP3

CD-G, CD-DA, CD-DA, CD-DA



Insert with the label facing up.

To Load and Play an Audio CD

1. Press **OPEN** to load the disc. Press **CLOSE** to close the disc tray. Press **PLAY** to start playback.
2. Press **PAUSE** to pause playback. Press **STOP** to stop playback.
3. Press **OPEN** to load the disc. Press **PLAY** to start playback. Press **STOP** to stop playback. Press **STOP** to stop playback. Press **STOP** to stop playback.
4. Press **PLAY** to start playback.
5. Press **STOP** to stop playback.

Audio CD Playback Features

When playing an audio CD, you can use the following features:

Skipping Tracks

To skip to the next track, press **▶▶**. To skip to the previous track, press **◀◀**.

Time Search

To use the Time Search feature, press **TIME SEARCH**.

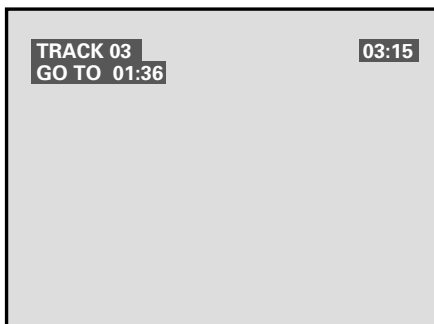

1. Press **TIME SEARCH** to enter the Time Search mode. Press **0** to enter the track number. Press **▶▶** to skip to the next track.
2. Press **0** to enter the time. Press **▶▶** to skip to the next track.

Note: Use the 10/0 button to enter zeros. For example, to enter 01:36, press the 10/0 button, then the 3, then the 6.

Use the Time Search feature to go to an elapsed time in a track.

Remaining Play Time

- Y' ca REMAIN b a a ac .
1. P REMAIN b . T a a a ac a
a ac b .
 2. P REMAIN a a a a c.

Play Mode

Random

- T Ra a a c' ac a .
1. P STOP a bac .
 2. P PLAY MODE c' (*Play Mode* ba a a).
 3. P PLAY MODE b *Random* a .
 4. P P a .
- T' Ra a bac , STOP a RESUME a a bac PLAY
MODE *Continue* a .

Program

- T P' a a bac a c' a
a ac a .
1. P STOP a bac .
 2. P PLAY MODE c' (P a M' ba a a).
 3. P PLAY MODE b P' a a .
 4. U b b ac a a . A
a a b , T I a
b b a c' a ac b .
 5. E a ac a a .
 6. P PLAY.
- T' P' a a bac , STOP a PLAY a
a bac , PLAY MODE *Continue* a .

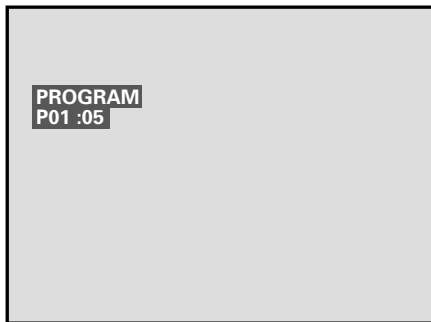

In the example above, the first in the Program Play list will be track 5.

Playing Audio CDs and MP3 Discs

Using the Repeat Feature

T a a a :
 D c a c
 T ac a ac a a
 A-B R a a a c c

To Repeat a Track or Disc:

1. W a c a , REPEAT (a ba a a a *Repeat one*).
2. T c ac a REPEAT c REPEAT ALL a c.
3. T a c, REPEAT a a (T a ba a *Repeat All*).
4. T a , REPEAT b REPEAT OFF a .

A-B Repeat

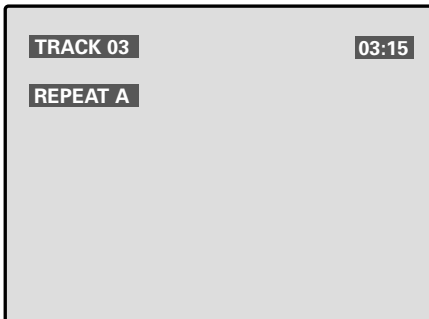

Use the A-B Repeat feature to repeat a segment you have set.

- A-B R a a a c c c a .
1. A a a a , P A-B b . T I D a REPEAT A.
 2. A c a a a a a . Y c a a a bac B A-B R a . I a - a , A-B R a ca c .
 3. P A-B b a a B . T A-B R a a a . R a . T A-B a , A-B b a a .

Playing Audio CDs and MP3 Discs

Playing MP3 discs

When you first load an MP3 disc, the MP3 player displays the track list. To view the track list, press the **PLAY** button.

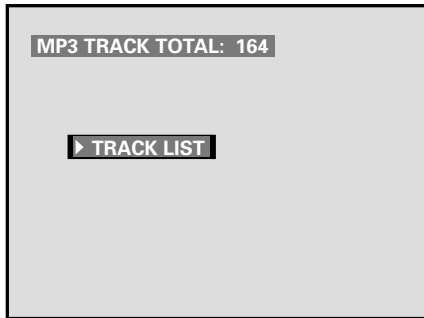

When you first load an MP3 disc, press **PLAY** to bring up the track list.

1. Press **OPEN** to view the track list.
2. Press **PLAY** to start playing the selected track.
3. Press **OPEN** to view the track list.
4. Press **PLAY** to start playing the selected track.
5. Press **STOP** to stop playing the selected track.

Selecting Tracks

Once you have the track list displayed, you can select a track to play. To select a track, use the **UP** and **DOWN** arrow keys to move the cursor to the track you want to play. Press **PLAY** to start playing the selected track.

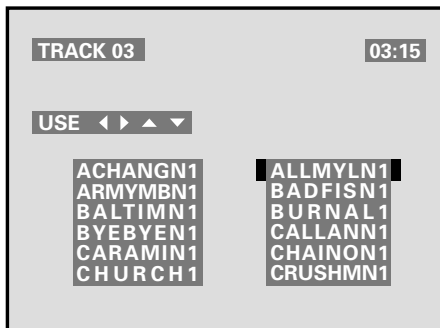

In the example above, track 2 is highlighted. Track 3 is the second track in column 1 (ARMYMBN1).

Skipping Tracks

To skip tracks, use the **SKIP** and **REVERSE** buttons. Press **SKIP** to skip to the next track. Press **REVERSE** to skip to the previous track. Press **STOP** to stop playing the selected track.

Playing Audio CDs and MP3 Discs

Karaoke

Y' DVD a ca b ' a Ka a' .

1. L' a a Ka a' c.

2. T ' ' c ' ' ' ' ' .

3. C' c ' c ' ' ' MIC1 a MIC2 ac ' ' ' a .

4. T c ' ' ' a a ' ' ' .

5. T ECHO ' b ' a ' .

6. P b b ' ' c a ac .

7. P SOUND ' ' c .

8. T' Ka a' a , c ' ' ' a c' c .

Pitch

Y' ca c a c ' a a ' ' ' c .

P b ' ' c . Eac ' b ' ' c ' , ' .

P # ' a c . Eac ' b ' a c ' , ' .

Playing Video CDs

Chapter Overview

- What is a Video CD?
- The Video CD Disc Menu
- Loading and Playing a Video CD
- Video CD Playback Features
- Disc View



Playing Video CDs

What is a Video CD?

Like DVD video discs, Video CDs contain picture and sound content. Video CDs (VCDs) are encoded in a different format. VCDs don't hold as much information as DVD discs and the picture quality is not as high.

VCDs can have more than one title. Each title is divided into tracks (similar to chapters on a DVD disc).

The Video CD Disc Menu

A Video CD disc is capable of having an on-screen menu that is separate from the DVD player's menu system and on-screen information banners. If the disc has a menu, the menu will appear after the disc is loaded into the player.

The content and operation of disc menus varies from disc to disc. Check the instructions that accompany the Video CD for more information on how to use the playback control functions for that specific disc.

If a disc menu appears:

1. Use the number buttons on the remote to select a track (similar to a title).
2. Press PLAY/OK on the remote to begin playback of the selected track.
3. Press ►► or ◀◀ on the remote to scroll through the tracks.
4. Press the STOP button on the remote to stop playback and return to the disc menu.

To bring up the disc menu during disc play, press the MENU button on the remote.

If the Video CD Has Playback Control

If a disc is encoded with the playback control function, a menu screen appears after the disc is loaded into the player.

1. Use the number buttons on the remote to select a track.
2. Press PLAY/OK to begin playback of the selected track.
3. Press ►► or ◀◀ on the remote to scroll through the tracks.
4. Press GO BACK to stop playback and return to the menu or press STOP to stop playback and remove the menu from the screen.

Bypassing Playback Control

If a Video CD has playback control, you can bypass the disc's menu by following these steps when you first load the discs.

1. Press STOP to put the player in the stop mode.
2. Use the number buttons on the remote to enter the desired track number, and then press PLAY/OK. When playback begins, the disc will respond as if it is not in the Playback Control mode.

Resuming Playback Control

To resume the Playback Control mode, press MENU (the disc's menu appears).

Using the Time Search Feature

You can use the Time Search feature to begin playback from any point on the disc (in the currently playing title) by entering the elapsed time. For example, if you have a favorite scene that begins 12:34 minutes into the movie, you can go directly to that point in the title.

1. Press the TIME SEARCH button on the remote (the time search prompt will be displayed).
2. Enter the elapsed time where you want to begin playback. As soon as you enter the last number, playback will begin from the time that you specified.

Note: This feature does not work in Playback Control mode.

A•B Repeat

A-B Repeat lets you repeat a specific segment on the DVD that you define. The segment will repeat until you turn it off.



Use A-B Repeat to repeat a segment if a track that you've set.

1. At the start of the segment you want to repeat, Press the A-B button on the remote. The Info Display shows "REPEAT A."
2. Allow the movie to play to the end of the segment you want to mark. You must let the movie play in standard playback mode to set the B point in A-B Repeat. If you rewind or fast-forward, A-B Repeat is cancelled.
3. Press A-B again to set the B point.
4. The segment that you set plays until you turn A-B Repeat off. To turn A-B repeat off, press A-B to resume normal playback.

Remaining Play time

You can use the REMAIN button on the remote to see the remaining time of a title or track.

1. Press the REMAIN button. The remaining running time of the currently playing track is displayed.
2. Press REMAIN a second time. The total remaining time is displayed.
3. Press CLEAR to clear the display from the screen.

Playing Video CDs

The Index Feature

The index feature displays small pictures or “thumbnails” of each title and track on the disc.

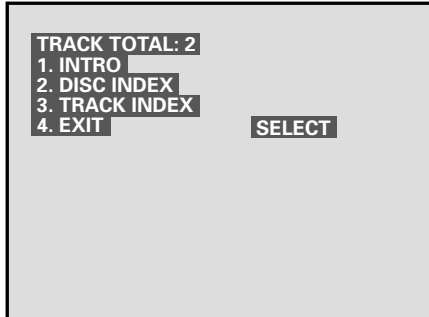

This is the Index menu. Press a number button to select the corresponding option.



Tracks are displayed nine to a page. Press the number button displayed in the corner of a thumbnail to select that track.

1. Press STOP twice.
2. Press the INDEX button (the index may take a moment to load).
3. The Index menu is displayed. The options are numbered. Use the number buttons on the remote to select an option.
 - **Intro** plays the first few seconds of the title.
 - **Disc Index** shows thumbnails of the titles available on the disc.
 - **Track Index** shows thumbnails of the tracks of the currently selected title.
4. If you select Disc Index or Track Index, the screen displays thumbnails of the available titles or chapters. Up to nine thumbnails are displayed per screen. Each thumbnail has a number in the corner. You can select and play a chapter by pressing that number on the remote.
5. To view the next nine thumbnails, press the ►► button to go forward and the ◀◀ button to go to the previous page.
6. To exit the index without making a selection, press the STOP button.

The Menu System

Chapter Overview

- The Display Menu
- The Sound Menu
- Password Setup
- The Preferences Menu



The Menu System

The Setup Menu

The Display Menu

Image

Depending on the type of television you have, you may want to adjust the screen setting (aspect ratio). The default setting is 4x3 (pan & scan).



4x3 PS (Pan & Scan)



4x3 Letterbox



16x9 Widescreen

1. With no disc playing, press **SETUP** (the main menu appears).
2. Use the arrow buttons to highlight the **DISPLAY** option. Press **PLAY/OK** to select (The **DISPLAY** menu is displayed).
3. Use the up/down arrow buttons to highlight the **IMAGE** option. The image display options appear on the right.
4. Press the right arrow button to move to the image options. Use the up/down arrow buttons to highlight the desired image display. When an option is highlighted, the option description appears at the bottom of the screen.
5. Press **PLAY/OK** to select the option.
6. Press the left arrow button to return to the Display menu options on the left. To return to the main menu, highlight the **MAIN MENU** option and press **PLAY/OK**.

4 x 3 P&S – Choose this setting if you want the movie to fill the entire screen of your TV. This might mean that parts of the picture (the left and right edges) won't be seen.

Most discs produced in a widescreen format can't be cropped in this fashion. This means the black bars will appear at the top and the bottom of the screen.

4 x 3 LB – Choose this setting if you want to see movies in their original aspect ratio (height-to-width ratio). You'll see the entire frame of the movie, but it will take up a smaller portion of the screen vertically. The movie might appear with black bars at the top and bottom of the screen.

16 x 9 Wide – Choose this setting if your DVD Player is connected to a widescreen TV. If you choose this setting and you don't have a widescreen TV, the images on the screen may appear distorted due to vertical compression.

If you play a disc recorded in 4 x 3 format on a widescreen TV, the left and right side of the screen will appear black.

Standard

This feature can be used to select a different color system according to the type of TV being used. The TV Type is preset for you and should not be changed.

Angle

The Angle icon is displayed when there is more than one camera angle available for the scene that is playing. If you don't want the Angle icon displayed on-screen, you may turn it off.

1. With no disc playing, press **SETUP** (the main menu appears).
2. Use the arrow buttons to highlight the *Display* option. Press **PLAY/OK** to select (The Display menu is displayed).
3. Use the up/down arrow buttons to highlight the *Angle* option. The angle choices appear on the right.
4. Press the right arrow button to move to the angle choices. Use the up/down arrow buttons to highlight the desired choice.
5. Press **PLAY/OK** to select the choice.
6. Press the left arrow button to return to the Display menu options on the left. To return to the main menu, highlight the *Main Menu* option and press **PLAY/OK**.

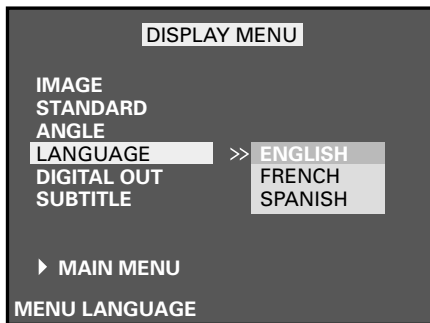

The Display Menu with the Language option highlighted.

Menu Language

Use this feature to change the language for the player's on-screen menu system. The default is English.

1. With no disc playing, press **SETUP** (the main menu appears).
2. Use the arrow buttons to highlight the *Display* option. Press **PLAY/OK** to select (The Display menu appears).
3. Use the up/down arrow buttons to highlight the *Language* option. The language choices appear on the right.
4. Press the right arrow button to move to the language choices. Use the up/down arrow buttons to highlight the desired language.
5. Press **PLAY/OK** to select the language. The menu will immediately change to the selected language.
6. Press the left arrow button to return to the Display menu options on the left. To return to the main menu, highlight the *Main Menu* option and press **PLAY/OK**.

The Menu System

Selecting Digital Output Type

If you have a receiver with a digital signal input, use this feature to select your player's type of digital output.

OFF No signal is output from the optical or coaxial port.

BITSTREAM Select this option when the DVD player is connected with a power amplifier through optical or coaxial port. The power amplifier connected must have Dolby Digital, DTS and MPEG decoding.

PCM Select this option when the DVD player is connected with a 2-channel digital or stereo amplifier.

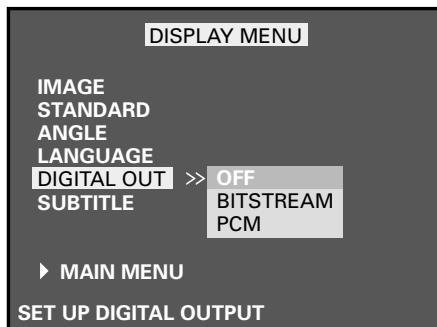

The Display Menu with the Digital Output option selected.

1. With no disc playing, press SETUP (the main menu appears).
2. Use the arrow buttons to highlight the *Display* option. Press PLAY/OK to select (The Display menu is displayed).
3. Use the up/down arrow buttons to highlight the *Digital Output* option. The digital output choices appear on the right.
4. Press the right arrow button to move to the digital output choices. Use the up/down arrow buttons to highlight the desired choice. When an option is highlighted, the option description appears at the bottom of the screen.
5. Press PLAY/OK to select the choice.
6. Press the left arrow button to return to the Display menu options on the left. To return to the main menu, highlight the *Main Menu* option and press PLAY/OK.

Subtitles

Subtitles can be turned on or off.

1. With no disc playing, press SETUP (the main menu appears).
2. Use the arrow buttons to highlight the *Display* option. Press PLAY/OK to select (The DISPLAY menu is displayed).
3. Use the up/down arrow buttons to highlight the *Subtitles* option. The subtitle choices (on or off) appear on the right.
4. Press the right arrow button to move to the subtitle choices. Use the up/down arrow buttons to highlight the desired choice. When a choice is highlighted, its description appears at the bottom of the screen.
5. Press PLAY/OK to select the choice.
6. Press the left arrow button to return to the Display menu options on the left. To return to the main menu, highlight the *Main Menu* option and press PLAY/OK.

Note: If the disc is playing, you can use the SUBTITLE button on the remote to toggle subtitles on or off.

The Sound Menu

Compression

This feature compresses the dynamic range (quietest sound to loudest sound) of a disc's soundtrack. For example, action scenes might be very loud, while whispered dialog is quiet. The Compression feature evens out the range of the volume by making loud sounds quieter and soft sounds louder. The Compression option is always on. You can adjust the compression with the Range option (see below).

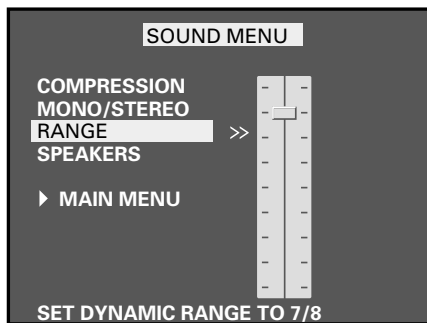

Use the up/down arrow keys to set the Dynamic Range.

Range

You can adjust the compression range with the *Range* option.

1. With no disc playing, press SETUP (the main menu appears).
2. Use the arrow buttons to highlight the *Sound* option and press PLAY/OK to select it (The *Sound* menu is displayed).
3. Highlight the *Range* option and press PLAY/OK to select it.
4. A slider bar appears. Press the right arrow button to move to the slider bar. Use the up/down arrow buttons to adjust the range.
5. When the range is adjusted, press the left arrow button to return to the Sound menu options. To return to the main menu, highlight the *Main Menu* option and press PLAY/OK.

Mono/Stereo

This option allows you to set the output mode of the left and right audio signals.

1. With no disc playing, press SETUP (the main menu appears).
2. Use the arrow buttons to highlight the *Sound* option. Press PLAY/OK to select (The *Sound* menu is displayed).
3. Use the up/down arrow buttons to highlight the *Mono/Stereo* option. The mono/stereo choices appear on the right.
4. Press the right arrow button to move to the mono/stereo choices. Use the up/down arrow buttons to highlight the desired choice. When a choice is highlighted, its description appears at the bottom of the screen.
5. Press PLAY/OK to select the choice.
6. Press the left arrow button to return to the Display menu options on the left. To return to the main menu, highlight the *Main Menu* option and press PLAY/OK.

Note: the Mixed Mono setting only works when the disc being played is 5.1-channel.

The Menu System

Speakers

The Front Speaker feature has two options:

- **STEREO+** If you have a Dolby Pro Logic receiver hooked up, select this option so the receiver can decode the signals and reproduce a surround sound effect.
- **STEREO** Select this option if you have a stereo receiver hooked up.

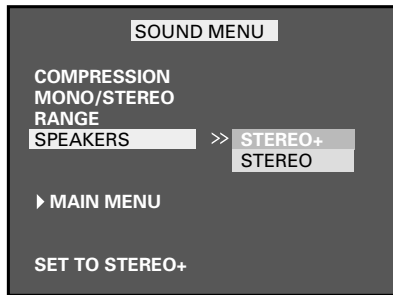

The Display Menu with the Speakers option selected.

1. With no disc playing, press SETUP (the main menu appears).
2. Use the arrow buttons to highlight the *Speakers* option. Press PLAY/OK to select (The *Speaker* menu is displayed).
3. Use the up/down arrow buttons to highlight the *Speaker* option. The speaker choices appear on the right.
4. Press the right arrow button to move to the speaker choices. Use the up/down arrow buttons to highlight the desired choice. When an choice is highlighted, it's description appears at the bottom of the screen.
5. Press PLAY/OK to select the choice.
6. Press the left arrow button to return to the Display menu options on the left. To return to the main menu, highlight the *Main Menu* option and press PLAY/OK.

Password Setup

Creating a Password

You can use a password to control what types of movies your family watches.

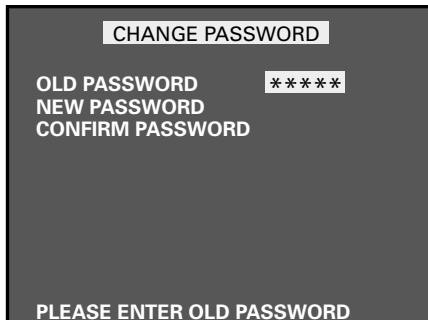
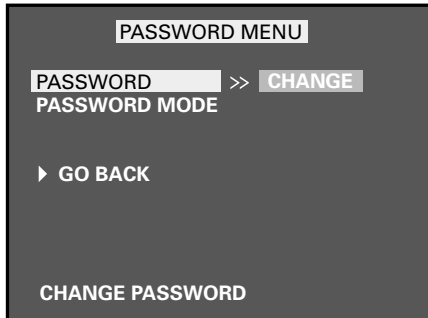

Setting a Password gives you control over what type of content your family watches.

1. With no disc playing, press SETUP (the main menu appears).
2. Use the down arrow to highlight *Password* (the *Password* menu appears).
3. Highlight the *Password* option.
4. Press the right arrow to highlight the Change option and press PLAY/OK to select it (the Change Password screen appears).
5. You will be prompted for the old password. The first time you use the password feature, you will need to enter the default password, which is 99999.
6. You will be prompted for a new password. Enter a 5-digit number (this is your password).
7. To confirm the new password, you will be prompted to re-enter it. Re-enter the new password.
 - If you've re-entered the new password incorrectly, the message *New password not confirmed* appears at the bottom of the screen. Re-enter the new password.
8. Press PLAY/OK to return to the Password menu.

Changing the Password Mode

The Password feature can be turned on or off. In order for parental rating to work, password must be turned on.

1. With no disc playing, press SETUP (the main menu appears).
2. Use the down arrow to highlight *Password* (the Password menu appears).
3. Highlight the *Password Mode* option.
4. Use the right arrow to move to the on/off options. Use the up/down arrows to highlight the desired option.
5. Press PLAY/OK to select the option.
6. Enter your password.
7. Press PLAY/OK to return to the Password menu.

Note: If Password Mode is turned on and you play a disc which is higher than the parental rating you've set, you must enter your password to play that disc.

The Menu System

The Preferences Menu

Selecting the Audio Preference

Use the Audio menu to select the soundtrack language that you prefer. If the disc you are playing has that language available, it will play in that language. If your preferred audio language isn't available, the disc's default language will be played.

1. With no disc playing, press SETUP (the main menu appears).
2. Use the down arrow to highlight *Preferences* (the *Preferences* menu appears).
3. Highlight the *Audio* option. A list of language choices appear on the right.
4. Use the right arrow to move to the language choices. Use the up/down arrows to highlight the desired choice.
5. Press PLAY/OK to select the option.
 - If you select the *Other* option, a screen will appear that requires you to enter a code for the language you want. Refer to the Other Language List on page 52 for the appropriate code. Type in the appropriate code and press PLAY/OK.

*Note: The **Other** language option may not work if the disc you are playing was not authored with that language.*

6. Press the left arrow to return to the *Preferences* options.

Notes:

Not all discs provide multiple languages for the soundtrack.

Some discs may not contain the language you selected as your initial language; in that case the disc will use its own default language setting.

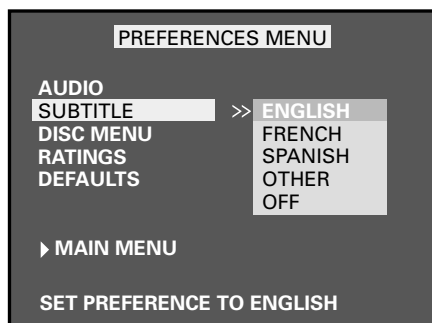

The Preferences Menu with the Subtitle option selected.

Selecting the Subtitle Language

Use the Subtitle Language menu to select the subtitle language you prefer. If the disc you are playing has that language available, it will display subtitles in that language. If your preferred subtitle language isn't available, the disc's default language will be displayed.

1. With no disc playing, press SETUP (the main menu appears).
2. Use the down arrow to highlight *Preferences* (the *Preferences* menu appears).
3. Highlight the *Subtitle* option. A list of languages appears on the right.
4. Use the right arrow to move to the language choices. Use the up/down arrows to highlight the desired choice.
5. Press PLAY/OK to select the choice.
 - If you select the *Other* option, a screen will appear that requires you to enter a code for the language you want. Refer to the Other Language List on page 52 for the appropriate code. Type in the appropriate code and press PLAY/OK.

*Note: The **Other** language option may not work if the disc you are playing was not authored with that language.*

6. Press the left arrow to return to the *Preferences* options.

Note: Not all discs provide multiple languages for the subtitles.

Changing the Disc Menu Language

Use the *Disc Menu* option to select the language you want a DVD's disc menu to be displayed in (not the same as the player menu).

1. With no disc playing, press SETUP (the main menu appears).
 2. Use the down arrow to highlight *Preferences* (the *Preferences* menu appears).
 3. Highlight the *Disc Menu* option. A list of languages appears on the right.
 4. Use the right arrow to move to the language choices. Use the up/down arrows to highlight the desired choice.
 5. Press PLAY/OK to select the choice.
- If you select the *Other* option, a screen will appear that requires you to enter a code for the language you want. Refer to the Other Language List on page 52 for the appropriate code. Type in the appropriate code and press PLAY/OK.

*Note: The **Other** language option may not work if the disc you are playing was not authored with that language.*

6. Press the left arrow to return to the *Preferences* options.

Setting the Rating Limit

The Parental feature is a rating limit system, like movie ratings. It works with DVD discs that have been assigned a rating. This helps you control the types of DVDs that your family watches.

This option lets you determine how your player will react to discs that contain movies that are rated (in the U.S.A., the Motion Pictures Association of America rates movies as G, PG, PG-13, etc.).

You decide which ratings require a password and which ones don't. This system ranks the ratings 1 through 8 in order to accommodate different countries' ratings systems (1 is considered a movie title with the least offensive material).

In order for the Rating level feature to work, the disc must be encoded with rating information and

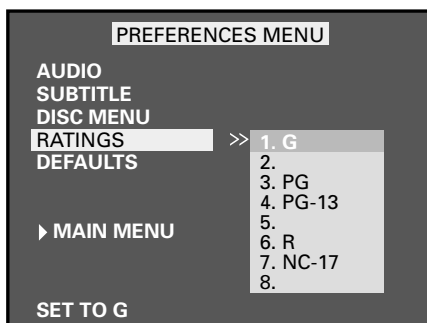

The Preferences Menu with the Subtitle option selected.

the Password Mode must be turned on.

1. With no disc playing, press SETUP (the main menu appears).
2. Use the down arrow to highlight *Preferences* (the *Preferences* menu appears).
3. Highlight the *Ratings* option. The ratings list appears on the right.
4. Use the right arrow to move to the rating options. Use the up/down arrows to highlight the desired rating.
5. Press PLAY/OK to select the option.
6. Press the left arrow to return to the *Preferences* options.

The Menu System

Defaults

Use the Default feature to reset ALL options to the factory defaults.

1. With no disc playing, press SETUP (the main menu appears).
2. Use the down arrow to highlight *Preferences* (the *Preferences* menu appears).
3. Highlight the *Defaults* option.
4. Use the right arrow to move to the *Reset* option.
5. Press PLAY/OK to select the option.
6. Press the left arrow to return to the *Preferences* options. To return to the main menu, highlight the main menu option and press PLAY/OK.

Language Code List

Language	Code	Language	Code	Language	Code	Language	Code
Abkhazian	6566	French	7082	Lithuanian	7684	Sindhi	8368
Afar	6565	Frisian	7089	Macedonian	7775	Singhalese	8373
Afrikaans	6570	Galician	7176	Malagsy	7771	Siswati	8383
Albanian	8381	Georgian	7565	Malay	7783	Slovak	8375
Ameharic	6577	German	6869	Malayalam	7776	Slovenian	8376
Arabic	6582	Greek	6976	Maltese	7784	Somali	8379
Armenian	7289	Greenlandic	7576	Maori	7773	Spanish	6983
Assamese	6583	Guarani	7178	Marathi	7782	Sundanese	8385
Aymara	6588	Gujarati	7185	Moldavian	7779	Swahili	8387
Azerbaijani	6590	Hausa	7265	Mongolian	7778	Swedish	8386
Bashkir	6665	Hebrew	7387	Naru	7865	Tagalog	8476
Basque	6985	Hindi	7273	Nepali	7869	Tajik	8471
Bengali; Bangla	6678	Hungarian	7285	Norwegian	7879	Tamil	8465
Bhutani	6890	Icelandic	7383	Occitan	7967	Tatar	8484
Bihari	6672	Indonesian	7378	Oriya	7982	Telugu	8469
Bislama	6673	Interlingua	7365	Oromo (Afan)	7977	Thai	8472
Breton	6682	Interlingue	7369	Panjabi	8065	Tibetan	6679
Bulgarian	6671	Inupiak	7375	Pashto, Pushto	8083	Tigrinya	8473
Burmese	7789	Irish	7165	Persian	7065	Tonga	8479
Byelorussian	6669	Italian	7384	Polish	8076	Tsonga	8483
Cambodian	7577	Japanese	7465	Portuguese	8084	Turkish	8482
Catalan	6765	Javanese	7487	Quechua	8185	Turkmen	8475
Chinese	9072	Kannada	7578	Rhaero-Romance	8277	TThai	7472
Corsican	6779	Kashmiri	7583	Romanian	8279		
Croatian	7282	Kazakh	7575	Russian	8285		
Czech	6783	Kinyarwanda	8287	Samoan	8377		
Danish	6865	Kirghiz	7589	Sangho	8371		
Dutch	7876	Kirundi	8278	Sanskrit	8365		
English	6978	Korean	7579	Scots Gaelic	7168		
Esperanto	6979	Kurdish	7585	Serbian	8382		
Estonian	6984	Laothian	7679	Servo-Croatian	8372		
Faroese	7079	Latin	7665	Sesotho	8384		
Fiji	7074	Latvian, Lettish	7686	Setswana	8478		
Finnish	7073	Lingala	7678	Shona	8378		

Other Information

Chapter Overview

- Troubleshooting
- GE Digital Video Disc (DVD) Limited Warranty
- Accessories and Order Form



Reference

Troubleshooting

Common Problem	Solution
No Power	Insert the power cord's plug securely into the outlet.
Power turns itself off	The power is automatically turned off after approx 30 minutes have elapsed in the stop mode (auto power-off feature). Turn power back on.
Player fails to start, even when PLAY is pressed	<ul style="list-style-type: none">• Ensure that the disc is installed with the label side facing up.• This player plays only DVD discs, Audio CDs and Video CDs.
Play commences but then stops immediately	<ul style="list-style-type: none">• The disc is dirty. Clean it.• Condensation has formed. Allow player to dry out.
No picture	<ul style="list-style-type: none">• Ensure that the equipment is connected properly.• Turn on the TV's power.• Ensure that the input setting for the TV is correct.
Picture is distorted during forward and reverse scan	<ul style="list-style-type: none">• It is normal for some distortion to appear while scanning.
No sound or distorted sound	<ul style="list-style-type: none">• Ensure that the equipment is connected properly.• Ensure that the input settings and the volume adjustment for the TV and/or receiver are correct.• No sound is heard during still, frame advance, or slow-motion play.
No operations can be performed with remote	<ul style="list-style-type: none">• The batteries in the remote may need replacing.• Operate the remote control closer to the DVD player.• Remove any obstacles between the remote and the DVD player or other component.• Remove batteries and hold down one or more buttons for 60 seconds to drain the microprocessor inside the remote to reset it. Reinstall batteries and try remote again. You may need to reprogram it.
The  icon appears on screen	<ul style="list-style-type: none">• The feature or action cannot be completed at this time because:<ol style="list-style-type: none">1. The disc's software restricts it.2. The disc's software doesn't support the feature (e.g., angles).3. The feature is not available at the moment.4. You've requested a title or chapter number or search time that is out of range.
No sound while playing a DVD	<ul style="list-style-type: none">• The DTS option is selected but your receiver has no DTS decoder, or you don't have a receiver connected.

Troubleshooting

DVD Problem	Solution
Subtitle and/or audio language is not the one selected from the initial setting	If the subtitle and/or audio language does not exist on the disc, the initial settings will not be seen/heard. The disc's priority language is selected instead. Set the subtitle and or audio language initial setting manually.
No on-screen display	The OFF setting is selected for OSD Display; select ON in the Setup menu.
Play doesn't begin when a title is selected	The rating level has been set and the disc is subject to that restriction.
No forward or reverse scan	Some DVDs have sections that prohibit rapid scanning, or title and chapter skip.
Disc won't play	<ul style="list-style-type: none"> • Both the player and the DVD is coded by region. If the regional codes don't match, the disc cannot be played. This player is Region No. 1. Check the disc code. • Verify that the disc is a type that this player can read. See page 22. • Clean the disc. • Try another disc to see if the disc that won't play is bad.
Desired angle cannot be changed	Some DVDs do not have the multi-camera angle system, and some discs have it only on certain portions.
Picture is not displayed with correct aspect ratio	Make sure the TV SCREEN feature in the Setup menu is set correctly for your television.
Forgot Rating Limit Password	With the power on, press and hold the STOP and PLAY/PAUSE buttons on the player. This resets the password feature and all other settings to the initial factory settings. You may be required to select a menu language the next time you power up.
Cannot copy discs to video tape	This player is equipped with anticopy protection.
"will not read disc" or other error message	Turn the player off and unplug it to reset the DVD player. Wait approximately 2 minutes, plug the player back in and turn it on.

Reference

GE DIGITAL VIDEO DISC (DVD) LIMITED WARRANTY

What your warranty covers:

- Any defect in materials or workmanship.

For how long after your purchase:

- 90 days - Unit exchange, which includes parts and labor.
- 91 days to 1 year - Unit exchange, which includes parts only; you pay the labor.
- The warranty for rental units begins with the first rental or 45 days from date of shipment to the rental firm, whichever comes first.

What we will do:

During the initial 90 days:

Exchange the DVD unit with a new or, at our option, refurbished unit.

After the 90 days and within one year:

Exchange the DVD unit with a new or, at our option, refurbished unit. We will bill you a flat exchange charge to replace a defective unit. This charge covers the labor cost for its repair.

How you get service:

- Call 1-800-311-9263 and have your unit's date of purchase and model/serial number ready. The model/serial number information is on the back of your unit.
- A representative will troubleshoot your problem over the phone.
- If the representative determines that you should receive a replacement unit you will be provided with a Return Authorization (RA) number and the location of a nearby exchange point if one exists. No returns will be accepted without the RA number.

To receive a replacement unit before you return yours:

Option I:

1. Provide your Discover, Mastercard or Visa account number and expiration date to your phone representative. This is for security purposes only and your account will not be charged at this time.
2. We will send you a replacement unit.
3. If you return the unit to us within 14 days from the date you were provided a RA number, only items not covered by warranty will be charged to your account. If your unit is not received within 14 days, the suggested retail value of the receiver will be charged to your credit card. This amount will be credited, less a \$10 handling fee, if the unit is subsequently received.
4. Ship your defective unit back to us using the replacement unit's carton. Shipping instructions will be included on the carton along with your RA number which will allow you to easily ship the unit back to us. Make sure you insure your shipment in case of damage or loss. Include with the shipment:
 - Evidence of purchase date such as a bill of sale.
 - A brief note describing your receiver problem.
 - Your name, address and phone number.

Option II:

1. For a fee of \$10.00, we will send a replacement unit to our exchange point.
2. The exchange location will notify you of its arrival.
3. Take your unit and evidence of purchase date, such as a bill of sale, to the exchange location and you will be provided the new or refurbished unit. Please retain all accessories such as the remote control hand unit.

4. If the repairs are covered by your warranty, you will not be billed.

Thomson assumes no responsibility for warranty shipments from the customer to the factory if not shipped in the manner prescribed by Thomson.

Return transportation, storage, handling and insurance costs are your responsibility. We accept no responsibility in case of damage or loss.

To receive a replacement unit after we have received your unit:

- Write the RA number on the outside of the carton used to return the unit. Make sure you insure your shipment in case of damage or loss.
- Carefully pack the unit using the original box and packing material if possible. Please retain all accessories that were included with your unit such as the remote control hand unit.
- Include with the shipment:
 1. Evidence of purchase date, such as a bill of sale, to verify your unit's warranty eligibility.
 2. A brief note describing your unit's problem.
 3. Your name, address and phone number.
- The representative will advise the address to mail a cashier's check or money order for payment if there are any out of warranty labor or parts charges, and you elect not to use your credit card.
- After we receive your product, a new or refurbished unit will be shipped to you.

What your warranty *does not* cover:

- Acts of nature, such as but not limited to lightning damage.
- Adjustment of customer controls.
- Damage from misuse or neglect.
- A unit that has been modified or incorporated into other products or is used for institutional or other commercial purposes.
- Batteries.
- Units purchased or serviced outside the U.S.A.
- Shipping damage if the unit was not packed and shipped in the manner prescribed by Thomson.
- Storage fees may be charged by the exchange point if you fail to pickup the replacement unit in a timely manner

Product Registration:

- Please complete and mail the Product Registration Card packed with your DVD product. It will make it easier to contact you should it ever be necessary. The return of the card is not required for warranty coverage.

How state law relates to warranty:

- This warranty gives you specific legal rights and you may have other rights that vary from state to state.

If you purchased your product outside the United States:

- This warranty does not apply. See your dealer for warranty information.

This page intentionally left blank.

Accessories and Order Form



Optical Plug to Optical Plug DV3 (3 ft.) DV6 (6 ft.)



Optical Plug to Mini Plug DV3M (3 ft.) DV6M (6 ft.)



Coaxial Digital Audio Cable DT3A (3 ft.) DT6A (6 ft.)

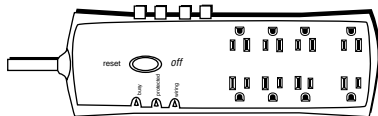

Surge Protector (SCTV160)

Accessory Order Form for Your DVD Player

Description	Part No.	Price	Qty
Optical Plug to Optical Plug (3 ft.)	DV3	\$15.95	
Optical Plug to Optical Plug (6 ft.)	DV6	\$19.95	
Optical Plug to Mini Plug (3 ft.)	DV3M	\$15.95	
Optical Plug to Mini Plug (6 ft.)	DV6M	\$19.95	
Coaxial Digital Audio Cable (3 ft.)	DT3A	\$9.95	
Coaxial Digital Audio Cable (6 ft.)	DT6A	\$14.95	
Surge Protector	SCTV160	\$49.95	

Total Merchandise	\$
Sales Tax	\$
We are required by law to collect the appropriate sales tax for each individual state, country, and locality to which the merchandise is being sent.	
Shipping and Handling	\$ 5.00
Total Amount Enclosed	\$
Use VISA, MasterCard or Discover Card preferably. Money order or check must be in U.S. currency only. No COD or CASH.	

Prices are subject to change without notice.

All accessories are subject to availability.

Please complete other side also 



Detach Here

Reference

Charge your order on your VISA, MasterCard, or Discover Card by filling in below

USE YOUR CREDIT CARD

IMPORTANT: Copy complete account number from your VISA card



My card expires:

IMPORTANT: Copy complete account number from your MasterCard



Copy Number above your name on MasterCard My card expires:

IMPORTANT: Copy complete account number from your Discover Card



My card expires:

AUTHORIZED SIGNATURE
(Credit card order will not be processed without signature)

Print or type your name and address clearly.



A complete and correct order will save you days of waiting.

Name: _____

Street: _____

_____ Apt. _____

City: _____

State: _____ Zip: _____

Daytime Telephone No.: _____

Please make sure that both sides of this form have been filled out completely.

- Allow 4 weeks for delivery.
- All accessories are subject to availability.
- Prices are subject to change.

To Place an Order:

To place your order by phone, have your Visa, MasterCard or Discover Card ready and call the toll-free number listed below.

Use this number only to place an order for accessory items listed on this order form.

1-800-338-0376

To place your order by mail, detach and mail the completed order form with credit card information, money order or check in US currency (made payable to Thomson multimedia Inc.) to the following address:

Video Accessories
PO Box 8419
Ronks, PA 17573

Index

Symbols

- 16 x 9 wide 44
- 4 x 3 Letterbox 44
- 4 x 3 Standard 44

A

- A-B repeat
 - Audio CD 36
 - DVD 32
 - VCD 41
- Accessories 59
- ANGLE button 20, 30
- Aspect ratio 44
- Audio
 - Dolby Digital 10
- AUDIO button 30
- Audio CD
 - loading a disc 34
 - playback features 34
- Audio equipment
 - Dolby Digital 10
 - DTS 10
- Audio language
 - changing 30, 50
- Audio R and L jacks 16

B

- Batteries, remote 18
- Buttons, remote 20

C

- Cables
 - needed for connecting 7
- Camera angle 30
- Chapter number, selecting 29
- Chapter, repeating 31, 36
- Common Problems 54
- Compression 47
- Connections 8, 9, 11
 - DVD player + TV with Audio/Video Input
 - Jacks 8
 - DVD player + TV + VCR 9
 - DVD player + TV+ Dolby Digital or DTS
 - Receiver 11
 - DVD player + TV+ Dolby Pro Logic or Stereo Receiver 13
 - DVD player + TV + VCR + Satellite
 - Receiver 15
- Connections, types of 7

D

- Defaults 52
- DIGITAL AUDIO OUT jack 10, 16
- Digital output type, selecting 46
- DIMMER button 20
- Disc
 - loading and playing 24
- Disc menu 24
- Disc Menu Language 51
- Discs
 - digital video discs 24
 - types you can't play 24
- Dolby Digital 11
- Dolby Pro Logic 11, 13
- DTS 10
- DVD
 - playback features 27

F

- Fast motion playback 27
- Frame Advance 27
- Freeze frame (pause) 27
- Front panel controls 17
- FWD 21

G

- GO BACK button 21

I

- INDEX button 21
- Index 29
- INFO button 21
- Input channel 19
- Installing batteries 18

J

- Jacks
 - AUDIO OUT R L 16
 - DIGITAL AUDIO OUT 16
 - R and L 16
 - S-VIDEO 16
 - VIDEO OUT 16

K

- Karaoke 37
- Key Control 21, 38

L

- LANGUAGE button 21
- Language Code List 52
- Loading a disc
 - audio CD 34
 - DVD 25

M

- MP3
 - playing files 37
- Motion Pictures Association of America 52
- MUTE button 21

N

- Number buttons 20

O

- ON•OFF button 17
- OPEN•CLOSE button 17
- Order form, accessories 59

P

- Password, changing 49
- PAUSE button 27
- Picture scan 27
- PLAY button 17, 27
- PLAY MODE button 20
- Play Mode
 - Random 28, 35
 - Program 28, 35
- Playback features
 - audio CD 34
 - DVD 27
 - Frame advance 27
 - Freeze frame 27
 - Slow motion 27
- Playing
 - digital video discs 24
- Play Time
 - remaining 29, 35

Reference

R

R and L jacks 16
Range 47
Rating Limit 51
REMAIN button 20
Remaining play time 29, 35
Regional coding 24
Remote control
 pointing 18
Remote, installing batteries 18
Repeat
 A-B 31, 36, 41
 chapter 31, 36
 title 31, 36
REPEAT button 21, 31, 36, 41
Repeat play 31, 36, 41
RESUME button 20
REV button 27

S

S-VIDEO jack 16
Satellite
 connecting 15
Search
 fast motion playback 27
Selecting
 Chapter number 29
 Title number 29
SETUP button 21
Skipping Chapters 27
Skipping Tracks
 CDs 34
 MP3 37
 VCDs 40
Slow motion playback 27
Sound Menu 47
Speakers 48
STEP button 21
Stereo 48
Subtitles
 turning on/off 46
 selecting a language 50
 codes 52
SUBTITLE button 21

T

TIME SEARCH button 21
Title
 repeating 31, 36
Title Number
 selecting 29
Troubleshooting 54
TV's Video Input Channel 19
Types of Discs the Player Can Play 18

V

VCDs 40
Video CDs 40
Video Input Channel 19
VIDEO OUT jack 16
VOLUME 21

Z

ZOOM button 20

Please do not send any products to the Indianapolis address listed in this manual or on the carton. This will only add delays in service for your product.

Thomson multimedia Inc.

10330 North Meridian Street
Indianapolis, IN 46290

©2001 Thomson multimedia Inc.

Trademark(s)® Registered

Marca(s) Registrada(s)

Printed in China

TOCOM 1564788A

Free Manuals Download Website

<http://myh66.com>

<http://usermanuals.us>

<http://www.somanuals.com>

<http://www.4manuals.cc>

<http://www.manual-lib.com>

<http://www.404manual.com>

<http://www.luxmanual.com>

<http://aubethermostatmanual.com>

Golf course search by state

<http://golfingnear.com>

Email search by domain

<http://emailbydomain.com>

Auto manuals search

<http://auto.somanuals.com>

TV manuals search

<http://tv.somanuals.com>