

GE Monogram®

Use and Care Guide

Dishwasher

ZBD4200

ZBD4500

Introduction

Your new Monogram dishwasher makes an eloquent statement of style, convenience and kitchen planning flexibility. Whether you chose it for its purity of design, practical features or assiduous attention to detail—or for all of these reasons—you'll find that your Monogram dishwasher's superior blend of form and function will delight you for years to come.

The information on the following pages will help you operate and maintain your dishwasher properly.

If you have any other questions—in the USA, please call the GE Answer Center® 800.626.2000. In Canada, please call 1.888.880.3030.

Contents

Appliance Registration	3, 21, 22	Optional Accessories	15
Before You Call for Service	17–19	Safety Instructions	4–6
Care and Cleaning	16	The Clean Sensor	10
Consumer Services	3, 20	Using the Dishwasher	11, 12
Control Panel	7, 8	Warranty Card	21
Flashing Display Lights	9	Canada Warranty	23
Loading the Racks	13, 14	USA Warranty	Back Cover
Model and Serial Number Location	3, 7		

Before using your dishwasher

Read this guide carefully. It is intended to help you operate and maintain your new dishwasher properly.

Keep it handy for answers to your questions.

If you do not understand something or need more help, call in the USA:

GE Answer Center®

800.626.2000

24 hours a day, 7 days a week.

In Canada, call 1.888.880.3030.

Write down the model & serial numbers

You can find the model and serial numbers at the inside left tub flange.

These numbers are also on the Consumer Product Ownership Registration Card packed separately with your dishwasher.

Before sending in this card, please write these numbers here:

Model Number

Serial Number

Use these numbers in any correspondence or service calls concerning your dishwasher.

If you received a damaged dishwasher

Immediately contact the dealer (or builder) that sold you the dishwasher.

Save time & money

Before you request service, check the Problem Solver in the back of this guide.

It lists causes of minor operating problems that you can correct yourself.

If you need service

To obtain service, see the Consumer Services page in the back of this guide.

We are proud of our service and want you to be pleased. If for some reason you are not happy with the service you receive, here are the steps to follow for further help.

For customers in the USA:

FIRST, contact the people who serviced your appliance. Explain why you are not pleased. In most cases, this will solve the problem.

NEXT, if you are still not pleased, write all the details—including your phone number—to:

Manager, Customer Relations
GE Appliances
Appliance Park
Louisville, KY 40225

For customers in Canada:

FIRST, contact the people who serviced your appliance. Explain why you are not pleased. In most cases, this will solve the problem.

NEXT, if you are still not pleased, write all the details—including your phone number—to:

Manager, Consumer Relations
Camco Inc.
1 Factory Lane, Suite 310
Moncton, N.B. E1C 9M3

IMPORTANT SAFETY INSTRUCTIONS

MESURES DE SÉCURITÉ IMPORTANTES

▲ WARNING!

For your safety, the information in this guide must be followed to minimize the risk of fire, explosion, electric shock, or to prevent property damage, personal injury, or loss of life.

- Do not tamper with controls.
- Do not abuse, sit on, or stand on the door or dish rack of the dishwasher.

- Do not discard a dishwasher without first removing the door of the washing compartment.
- Do not store or use combustible materials, gasoline or other flammable vapors and liquids in the vicinity of this or any other appliance.
- Do not allow children to play inside, on or with this appliance or any discarded appliance.

▲ MISE EN GARDE!

Pour votre sécurité, veuillez suivre à la lettre les directives données dans le présent guide afin de réduire les risques d'incendie, d'explosion ou de chocs électriques, et prévenir les dommages matériels et les blessures graves ou mortelles.

- Ne modifiez pas le fonctionnement des commandes.
- Ne montez pas ou ne vous assoyez pas sur la porte ou les paniers du lave-vaisselle, et ne les utilisez pas de façon abusive.

- Ne jetez pas un lave-vaisselle sans en avoir d'abord enlevé la porte.
- N'entreposez pas et n'utilisez pas d'essence, de vapeurs ou de liquides inflammables à proximité de cet appareil ou de tout autre électroménager.
- Ne laissez pas les enfants jouer avec le lave-vaisselle ni monter dessus. Ne les laissez pas s'introduire à l'intérieur de cet appareil ou d'un vieil appareil qui ne sert plus.

▲ WATER HEATER SAFETY

Under certain conditions hydrogen gas may be produced in a water heater that has not been used for two weeks or more. HYDROGEN GAS IS EXPLOSIVE.

If the hot water has not been used for two weeks or more, prevent the possibility of damage or injury by turning on all hot water

faucets and allowing them to run for several minutes. Do this before using any electrical appliance which is connected to the hot water system. This simple procedure will allow any built-up hydrogen gas to escape. Since the gas is flammable, do not smoke or use an open flame or appliance during this process.

▲ SÉCURITÉ DU CHAUFFE-EAU

Dans certaines conditions, il peut se former de l'hydrogène à l'intérieur d'un chauffe-eau qui n'a pas servi pendant deux semaines ou plus. L'HYDROGÈNE EST UN GAZ EXPLOSIF.

Pour réduire les risques de dommages ou de blessures lorsque l'eau chaude n'a pas été utilisée depuis deux semaines ou plus, ouvrez

tous les robinets d'eau chaude et laissez l'eau couler pendant plusieurs minutes avant d'utiliser un appareil électrique raccordé au système d'eau chaude. Vous éliminerez ainsi l'hydrogène qui pourrait s'y être accumulé. Puisqu'il s'agit d'un gaz inflammable, ne fumez pas ou n'utilisez pas une flamme nue au cours de ce processus.

PROPER INSTALLATION AND MAINTENANCE

This dishwasher must be properly installed and located in accordance with the Installation Instructions before it is used. If you did not receive an Installation Instructions sheet with your dishwasher, you can receive one by calling us toll-free in the USA, at the GE Answer Center®, 800.626.2000. In Canada, call 1.888.880.3030.

- Connect to a grounded metal, permanent wiring system; or run an equipment-grounding conductor with the circuit conductors and connect to the equipment-grounding terminal or lead of the appliance.
- Improper connection of the equipment-grounding conductor can result in a risk of electric shock. Check with a qualified electrician or service representative if you are in doubt whether the appliance is properly grounded.
- Dispose of discarded appliances and shipping or packing material properly.
- Do not attempt to repair or replace any part of your dishwasher unless it is specifically recommended in this manual. All other servicing should be referred to a qualified technician.
- To minimize the possibility of electric shock, disconnect this appliance from the power supply before attempting any maintenance. **NOTE:** Turning the dishwasher off does not disconnect the appliance from the power supply. We recommend having a qualified technician service your appliance.

INSTALLATION ET ENTRETIEN APPROPRIÉS

Avant de l'utiliser, vous devez installer correctement ce lave-vaisselle conformément aux directives d'installation fournies. Si vous n'avez pas reçu une feuille de directives d'installation avec votre lave-vaisselle, vous pouvez en obtenir un exemplaire en téléphonant sans frais au Centre de réponse GE des États-Unis au 1.800.626.2000. Au Canada, composez le 1.888.880.3030.

- Cet appareil doit être relié à un système de câblage électrique permanent, mis à la terre. Sinon, un fil de mise à la terre pour appareillage doit être installé et raccordé à la borne ou au fil de mise à la terre de l'appareil.
- Un raccordement non approprié du fil de mise à la terre pour appareillage peut présenter des risques de chocs électriques. Si vous doutez de la qualité de la mise à la terre de votre électroménager, consultez un représentant du Service après-vente ou un électricien qualifié.
- Jetez de la façon appropriée les vieux électroménagers, ainsi que le matériel d'emballage et d'expédition.
- Ne tentez pas de réparer ou de remplacer toute pièce de votre lave-vaisselle, à moins que cela ne soit spécifiquement recommandé dans le présent guide. Confiez toutes les autres réparations à un réparateur qualifié.
- Afin de réduire les risques de chocs électriques, débranchez toujours l'appareil avant de le réparer. **REMARQUE :** Lorsque vous mettez la commande du lave-vaisselle à OFF (arrêt), le courant qui alimente l'appareil n'est pas coupé. Nous vous recommandons de confier la réparation de votre appareil à un réparateur qualifié.

WHEN USING YOUR DISHWASHER

Use this appliance only for its intended purpose as described in this Owner's Guide.

! CAUTION

Contents washed in SaniWash may be hot to the touch. Use care before unloading.

- Use only powder, tabs, liquid detergents or rinse agents recommended for use in a dishwasher and keep them out of the reach of children.
- Locate sharp items so that they are not likely to damage the door seal.
- Load sharp knives with the handles up to reduce the risk of cut-type injuries.
- Do not wash plastic items unless marked *dishwasher safe* or the equivalent. For plastic items not so marked, check the manufacturer's recommendations.

- Non-Dishware Items: Do not wash items such as electronic air cleaner filters, furnace filters and paint brushes in your dishwasher. Damage to dishwasher and discoloration or staining of dishwasher may result.
- Do not touch the heating element during or immediately after use.
- Do not operate your dishwasher unless all enclosure panels are properly in place.
- Close supervision is necessary if this appliance is used by or near children.
- Load light plastic items so they will not become dislodged and drop to the bottom of the dishwasher—they might come into contact with the heating element and be damaged.

Read and follow this Safety Information carefully.
SAVE THESE INSTRUCTIONS

LORSQUE VOUS UTILISEZ VOTRE LAVE-VAISSELLE

N'utilisez ce lave-vaisselle que pour l'usage auquel il est destiné, comme expliqué dans le présent Guide d'utilisation.

! AVERTISSEMENT

La vaisselle lavée à l'aide du programme SaniWash peut être chaude. Procéder avec précaution lors du déchargement.

- N'utilisez que des détergents liquides, en poudre ou en pastilles et les produits de rinçage recommandés pour lave-vaisselle. Gardez tous ces produits hors de portée des enfants.
- Placez les couteaux les poignées vers le haut afin de réduire les risques de coupures.
- Ne lavez pas d'articles en plastique dans le lave-vaisselle, à moins qu'ils portent la mention *lavable au lave-vaisselle* ou toute mention équivalente. Lorsque les articles de plastique ne portent aucune mention, lisez les recommandations du fabricant.

- Articles divers : Ne lavez pas des articles comme les filtres à air électroniques, les filtres de fournaise et les pinceaux dans votre lave-vaisselle. Ils pourraient endommager le lave-vaisselle et décolorer ou tacher la cuve.
- Ne touchez pas à l'élément chauffant pendant ou immédiatement après le lavage.
- Ne faites pas fonctionner votre lave-vaisselle lorsque l'un de ses panneaux est enlevé.
- Il faut exercer une étroite surveillance lorsque vous faites fonctionner le lave-vaisselle en présence d'enfants.
- Placez les articles légers en plastique de façon qu'ils ne bougent pas ou ne tombent au fond de l'appareil pendant le lavage. Ils pourraient être endommagés s'ils entrent en contact avec l'élément chauffant.

Veillez lire et suivre à la lettre ces mesures de sécurité.
CONSERVEZ CES DIRECTIVES

Control Panel

Dishwasher

You can locate your model number on the tub wall just inside the door. Throughout this manual, features and appearance may vary from your model.

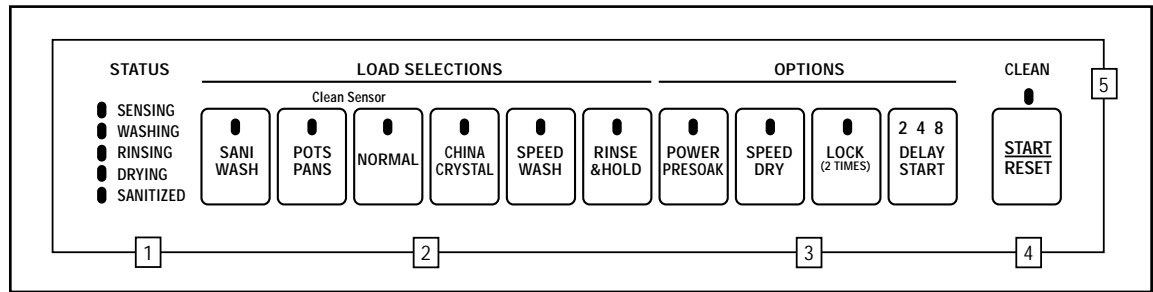

Control Settings

1. The Status

The Status display tells you what is happening while the dishwasher is in operation and also any malfunctions if they occur. The lights will come *ON* indicating the sequence of operation the dishwasher is in.

SENSING	Displayed during periods using CLEANSENSOR technology to measure the amount of soil in the load and decide if another prewash is needed. The SENSING light is displayed only during the NORMAL and POTS PANS cycles.
WASHING	Displayed during prewash and main wash periods.
RINSING	Displayed during rinse periods.
DRYING	Displayed during SPEED DRYING.
SANITIZED	Displayed when cycle has met sanitization conditions. Light remains <i>ON</i> until door is opened.

2. Load Selections

The light above the selected pad will be *ON* to indicate which LOAD SELECTION has been selected.

SANI WASH	This cycle raises the water temperature in the final rinse to sanitize your dishware. The cycle length will vary depending on the temperature of your inlet water. NOTE: The SaniWash cycle is monitored for sanitization requirements. If the cycle is interrupted during or after the main wash portion or if the incoming water temperature is so low that adequate water heating cannot be achieved, the sanitizing conditions will not be met. In these cases, the sanitized light will not illuminate at the end of the cycle.
POTS PANS	For heavily soiled dishes or cookware with dried-on or baked-on soils. Everyday dishes may be included. This cycle will not remove burned-on foods.
NORMAL	For loads of everyday dishes and glassware with medium soils.
CHINA CRYSTAL	For lightly soiled china and crystal.
SPEED WASH	For lightly soiled dishes and glassware.
RINSE & HOLD	For rinsing partial loads that will be washed later. Do not use detergent with this cycle.

3. Options

The light above the selected pad will be *ON* to indicate which option has been selected.

POWER PRESOAK	For use with heavily soiled and/or dried-on, baked-on soils. This option MUST be selected PRIOR to starting the cycle. This option adds 16 minutes to the cycle time.
SPEED DRY OFF	Shuts off the drying heat option. Dishes air dry naturally and energy is saved. You can prop the door open after the CLEAN light illuminates.
SPEED DRY ON	Turns the heater on for fast drying. This cycle will extend the time ON to your wash cycle by 23 minutes for the NORMAL cycle and 30 minutes for the SANIWASH cycle. NOTE: Cannot be selected with RINSE & HOLD cycle.
LOCK	<p>When the LOCK pad is touched twice within 3 seconds, all pads become inoperative. You can lock the controls to prevent any selections from being made. Or you can lock the controls after you have started a cycle or selected DELAY START so the cycle or DELAY START is not interrupted.</p> <p>Children cannot accidentally start dishwasher by touching pads with this option selected.</p> <p>To unlock the dishwasher after it has been locked, touch the LOCK pad twice within 3 seconds. The light above the LOCK pad will turn off.</p>
DELAY START	You can delay the start of a wash cycle for up to 8 hours. Press the DELAY START pad to choose the number of hours you want to delay the start of the cycle. The machine will count down and start automatically at the correct time. Pressing the START/RESET button will cancel the DELAY START selection. NOTE: If you forget to latch the door a reminder signal will beep until you do so.
RESET	To change a cycle after washing starts, touch the START/RESET pad to cancel the cycle. After water is pumped out and the motor stops, you can reprogram and restart the dishwasher. This will take approximately 90 seconds.

4. Start

Close and latch the door. Touch the **START/RESET** pad to begin the cycle. Water fill begins and approximately 40 seconds later the wash action begins.

NOTE: The dishwasher remembers your last cycle so you don't have to reprogram each time. When the dishwasher is loaded and the door latch is in the locked position, the control panel lights will be on and display the last settings you selected.

If you do not want to change any of the settings, simply touch the **START/RESET** pad to begin the cycle.





















Also, if a power failure occurs, **NORMAL** and **SPEED DRY** will automatically be programmed. Make any new selections and touch the **START/RESET** pad to begin the cycle.

5. Clean

This light is illuminated when a wash cycle is complete. The light will stay on until the door is opened.

Flashing Display Lights

Dishwasher

System Lights	What It Means	What To Do
<p>STATUS  SENSING  WASHING  RINSING  DRYING  SANITIZED</p>	CLEANSENSOR Error	<p>If the sensing light does not come at the beginning of the NORMAL or POTS PANS cycle, the CLEANSENSOR is not working. Call for service. The dishwasher will continue to work without the CLEANSENSOR.</p> <p>NOTE: This light will not stay on the entire cycle.</p>
<p>STATUS  SENSING  WASHING  RINSING  DRYING  SANITIZED</p>	START/RESET pad has been pressed	Allow dishwasher to drain and reset before selecting a new cycle.
<p>STATUS  SENSING  WASHING  RINSING  DRYING  SANITIZED</p> <p>PLUS A BEEPING SOUND</p>	Control Error	<p>Press the START/RESET pad to turn off the beeper. But the RINSING light will continue to flash. If this continues, call for service.</p>
<p>STATUS  SENSING  WASHING  RINSING  DRYING  SANITIZED</p> <p>PLUS A BEEPING SOUND</p>	Control Error	<p>Press the START/RESET pad to turn off the beeper and the dishwasher will attempt to reset. Then restart the wash cycle. If this error continues, call for service.</p>

The Clean Sensor

Dishwasher

The dishwasher has an exclusive CleanSensor System that measures the amount of soil in the load and determines the number of prewashes needed to clean the dishes.

<i>CYCLE</i>	<i>SOIL LEVEL</i>	<i>CYCLE SEQUENCES</i>								<i>WATER USAGE GALLONS</i>	<i>TOTAL TIME MINUTES</i>
<i>Sani Wash</i>		PreWash	PreWash			Main Wash		Pre Rinse	Final Rinse	8.5	45-90
<i>Pots Pans</i>	<i>Heavy</i>	PreWash	PreWash	PreWash	Pre Wash	Main Wash		Pre Rinse	Final Rinse	11.5	68-83
	<i>Medium</i>	PreWash	PreWash	PreWash		Main Wash		Pre Rinse	Final Rinse	9.9	64
	<i>Light</i>	PreWash	PreWash			Main Wash		Pre Rinse	Final Rinse	8.3	60
<i>Normal</i>	<i>Heavy</i>	PreWash	PreWash	PreWash		Main Wash	Pre Rinse	Pre Rinse	Final Rinse	11.5	62
	<i>Medium</i>	PreWash	PreWash			Main Wash	Pre Rinse	Pre Rinse	Final Rinse	9.9	58
	<i>Light</i>	PreWash				Main Wash	Pre Rinse	Pre Rinse	Final Rinse	8.3	54
<i>China/Crystal</i>		PreWash				Main Wash		Pre Rinse	Final Rinse	6.6	33
<i>Speed Wash</i>		PreWash	PreWash			Main Wash		Pre Rinse	Final Rinse	8.3	38
<i>Rinse & Hold</i>									Rinse	1.6	4

Water Temperature

The entering water must be at least 120°F. and not more than 150°F., for effective cleaning and to prevent dish damage. Check the water temperature with a candy or meat thermometer. Turn on the hot water faucet nearest the dishwasher, place the thermometer in a glass and let the water run continuously into the glass until the temperature stops rising.

Rinse Agent

A rinse agent, such as JET-DRY®, makes water flow off the dishes quickly thereby reducing water spotting.

Fill the rinse agent dispenser until it reaches the bottom of lip inside the opening. Do not overfill the dispenser. Replace the cap.

To check if rinse agent is needed, press the clear center of the fill cap 2 or 3 times. If rinse agent fills the center of the fill cap, you have enough.

- A full dispenser should last about one month.
- If rinse agent is spilled, wipe up the excess.

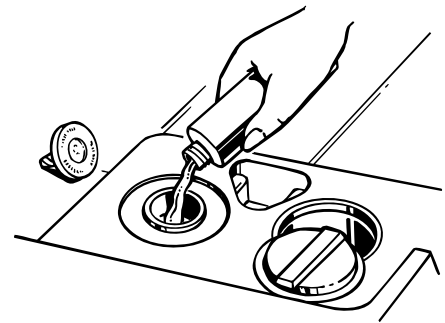

Dish Preparation Prior to Loading

- No prerinsing of normal food soil is required.
 - Scrape off hard soils including bones, toothpicks, skins and seeds.
 - Remove large quantities of any food.
 - Remove leafy vegetables, meat trimmings, and excessive amounts of grease or oil.
 - Remove foods with high acid content—they can discolor stainless steel.
-

Dishwasher Door

1. The door must be closed and latched into place to select a LOAD SELECTION or an OPTION.
2. If the door is opened during a cycle and left open, *the dishwasher will beep once every minute* until the door is closed and latched into place.

Adding a Forgotten Dish

A forgotten dish can be added any time before the detergent cup opens.

1. Push the door latch to the left.
2. Do not open the door until the water spray action stops. Steam may rise out of the dishwasher.
3. Add forgotten dishes.
4. Close the door and push the latch to the far right.

Detergents

Use only detergent specifically made for use in dishwashers. Keep your detergent fresh and dry. Do not put powder detergent into the dispenser until you are ready to wash dishes.

You will find two detergent dispensers on the inside door of your dishwasher. All wash cycles require detergent in the main cup. Wash cycles with two washes will also use the open cup.

The amount of detergent to use depends on whether your water is hard or soft. With hard water, fill the main cup and open cup completely. With soft water, fill both cups halfway. When using automatic dishwashing detergent tabs, simply place one in the main cup and close.

Protect your dishes and dishwasher by contacting your water department and asking how hard your water is. Twelve or more grains is extremely hard water. A water softener is recommended. Without it, lime can build up in the water valve, which could stick while open and cause flooding. Too much detergent with soft water can cause a permanent cloudiness of glassware, called etching.

NOTE: To open detergent cup after it has been closed, unlatch the door. Press the START/RESET pad three times within two seconds and the detergent cup will release. You may also turn the detergent cup handle counter-clockwise until it releases. A snapping sound may be heard.

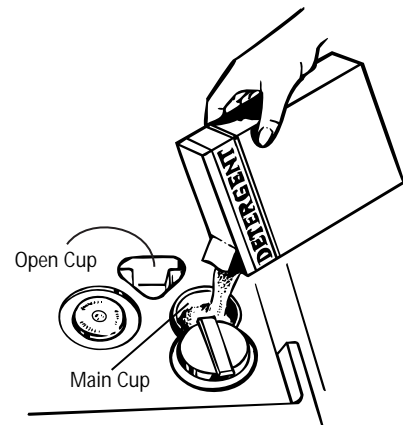

Loading the Racks

Dishwasher

Upper Rack

The upper rack is for glasses, cups and saucers. Cups and glasses fit best along the sides. This is also a secure place for dishwasher-safe plastics.

The cup shelf (on some models) may be placed in the up or down position to add flexibility. A wine glass holder (on some models) secures wine glasses at an angle for best washability. Because wine glasses come in various sizes, after loading, slowly push in the rack to make sure they will clear the top of the dishwasher.

The upper rack is good for all kinds of odd-shaped utensils. Saucepans, mixing bowls and other items should be placed face down. Fold-down fingers provide flexibility for extra large and hard-to-fit items.

Secure larger dishwasher-safe plastics over two fingers when possible.

Make sure small plastic items are secure so they can't fall onto the heater.

Be sure that items do not protrude through the bottom of the rack and block rotation of the middle spray arm. This could result in poor wash performance for items in the upper rack.

Check to make sure that tall items will not block rotation of the top wash arm.

Features and appearance of racks and silverware baskets may vary from your model.

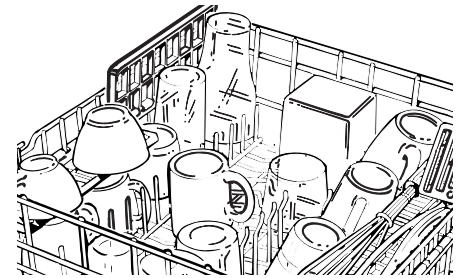

Wash Tower

Keep the center area clear in the lower rack.

The wash tower rises through the center of the lower rack during the wash and rinse portions of the cycle. The wash tower shoots water into the mid-level wash arm located under the upper rack. Blocking the wash tower could result in poor wash performance for items in the upper rack.

A second wash tower is located in the top rack. Water from the wash tower in the lower rack shoots up into this wash tower and out the openings at the top. When loading items around this wash tower do not block the top openings.

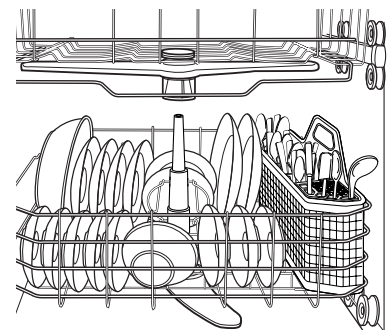

Do not block or load tall things next to the wash tower.

Lower Rack

When loading the lower rack, do not load large platters or trays in the front right corner. They may prevent detergent from circulating during the wash cycle.

The lower rack is best used for plates, saucers, and cookware. Large items such as broiler pans and racks should go along the sides. Load platters, pots and bowls along the sides, in corners, or in the back. The soiled side of items should face the center of the rack. Also, be careful not to let a portion of an item such as a pot or dish handle extend through the bottom rack. This could block the wash arm and cause poor washing results.

Fold-down fingers provide flexibility for extra large and hard-to-fit items. The fingers may be left in the up position or folded down to customize the lower rack.

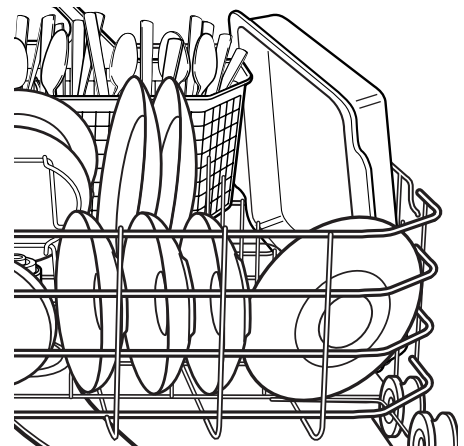

Loading the Racks

Dishwasher

Silverware Basket

A variety of options are available regarding the three piece silverware basket in your dishwasher. The complete basket is designed to fit on the right side or back of the lower rack. Additionally, each end of the basket is removable to better accommodate flatware and lower rack capacity needs.

To load flatware, simply push the adjustable handle to either side. Put flatware in the basket with knife handles up to protect your hands. Place spoons in the basket with the handles down. Mix knives, forks and spoons so they don't nest together. Distribute evenly. Small plastic items, such as measuring cups and lids for small containers, should go in the bottom of the silverware basket with silverware on top.

The lids of both end baskets can be closed to contain small items. Long items can be placed on the cupshelf in the upper rack.

Features and appearance of racks and silverware baskets may vary from your model.

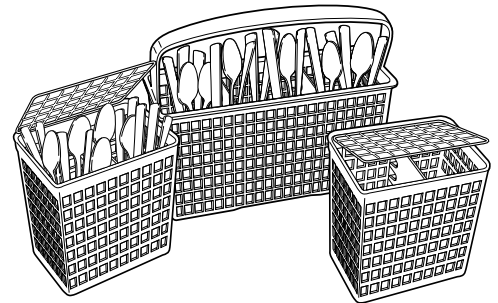

To remove the end baskets, grasp the basket at opposite corners and slide apart.

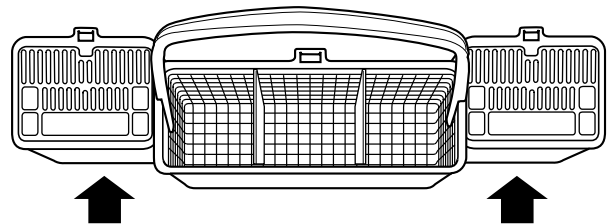

Follow these guidelines for loading 10 place settings

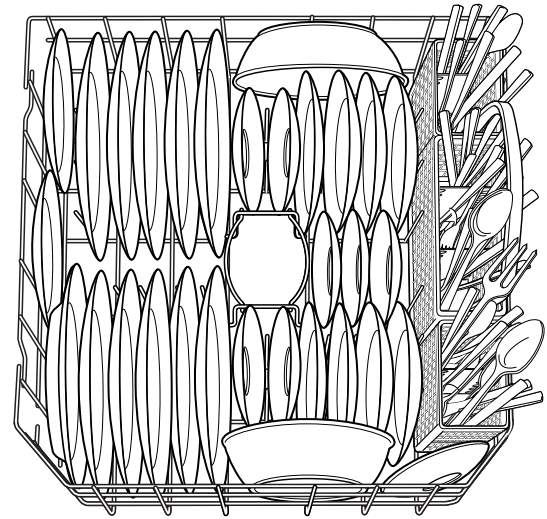
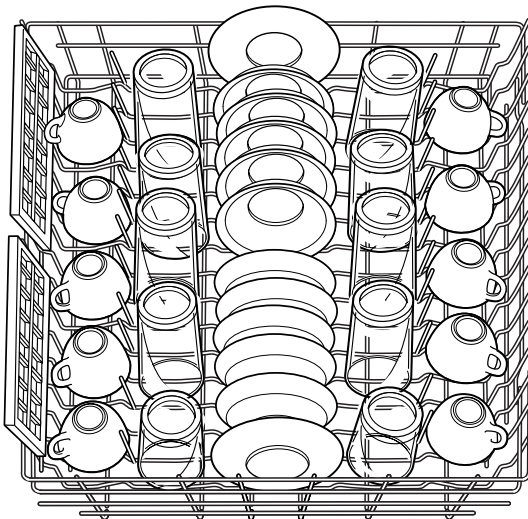

Change the Dishwasher's Appearance

You can change the door and lower access panel appearance of your dishwasher by ordering one of these optional accessories:

- Stainless Steel Panels
- 1/4" Wood Panel Trim Kit
- 3/4" Trimless Panel Kit

These accessories are available at extra cost (Visa, MasterCard, or Discover cards accepted) by calling 800-626-2002.

Specify accessory number when ordering.

Descriptions of Optional Accessories

Door panels— Replacement door panels and lower access panels are available in Stainless Steel. Order GPF400S.

NOTE: The GPF100 dishwasher door spring kit will be included with the stainless steel panel and must be installed with it.

Wood panel trim kit— This accessory contains trim and instructions for you to supply and install a 1/4" thick decorative wood door and lower access panel:

- GPF425B (Black)
- GPF425W (White)

NOTE: The GPF100 dishwasher door spring kit must also be ordered and installed when the door panel weighs four lbs. or more.

Trimless panel kit— This accessory contains parts and instructions for you to supply and install a 3/4" thick decorative wood door and lower access panel:

- GPF475

NOTE: The GPF100 dishwasher door spring kit is included with the trimless panel kit and must be installed with it.

Control Panel

To clean the control panel use a lightly dampened cloth then dry thoroughly. To clean the exterior use a good appliance polish wax.

Never use sharp objects, scouring pads or harsh cleaners on any part of the dishwasher.

Protect Against Freezing

If your dishwasher is left in an unheated place during the winter, ask a service technician to:

1. Cut off electrical power to the dishwasher. Remove fuses or trip circuit breaker.
 2. Turn off the water supply and disconnect the water inlet line from the water valve.
 3. Drain water from the water inlet line and water valve. (Use a pan to catch the water.)
 4. Reconnect the water inlet line to the water valve.
-

The Air Gap

An air gap protects your dishwasher against water backing up into it if a drain clogs. The air gap is not a part of the dishwasher. It is not covered by your warranty. Not all plumbing codes require air gaps, so you may not have one.

The air gap is easy to clean.

1. Turn off the dishwasher and lift off the chrome cover.
2. Remove the plastic cap and clean with a toothpick.

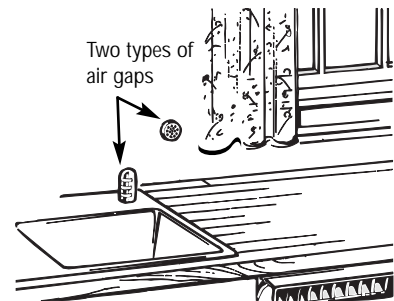

Check the air gap any time your dishwasher isn't draining well.

Caring for GPF400S Optional Accessory

The stainless steel panels can be cleaned with Stainless Steel Magic or a similar product using a clean, soft cloth.

You can order Stainless Steel Magic # WX10X15 through GE Parts by calling 800-626-2002.

Before You Call For Service

Dishwasher

*Questions?
Use this
problem
solver*

PROBLEM	POSSIBLE CAUSE	WHAT TO DO
Control panel lights go off when you're setting	Time too long between touching of selected pads	<ul style="list-style-type: none"> ·Each pad must be touched within 30 seconds of the others. To relight, touch any pad again, or unlock and relatch the door.
Noise	Some of the sounds you will hear are normal	<ul style="list-style-type: none"> ·Hard food disposal shredding action. ·Drain valve opening to pump water out. ·Timer control as cycle progresses. ·Detergent cup opening. ·The motor stopping during the drying period. ·Water draining out of the tub immediately after you touch the START/RESET pad.
	Utensils are not secure in the rack or something small has dropped into the rack	<ul style="list-style-type: none"> ·Make sure everything is secured in dishwasher.
	Motor hums	<ul style="list-style-type: none"> ·Dishwasher has not been used on a regular basis. If you do not use your dishwasher often, set it to fill and pump out once every week. This will help keep the seal moist and the garbage disposer clear.
Detergent left in dispenser cups	Dishes are blocking the detergent cups	<ul style="list-style-type: none"> ·Reposition the dishes.
Detergent cup lid latched accidentally by user		<ul style="list-style-type: none"> ·Unlatch the door. Press the START/RESET pad three times within two seconds. The detergent cup will trip.
Water standing in the bottom of the tub	This is normal	<ul style="list-style-type: none"> ·A small amount of clean water around the outlet on the tub bottom at the back of the tub keeps the water seal lubricated.
Water won't pump out of the tub	Drain is clogged	<ul style="list-style-type: none"> ·If you have an air gap, clean it. ·Check to see if your kitchen sink is draining well. If not, you may need a plumber. ·If the dishwasher drains into a disposer, run disposer clear.

Before You Call For Service

Dishwasher

*Questions?
Use this
problem
solver*

PROBLEM	POSSIBLE CAUSE	WHAT TO DO
Suds in the tub	Correct detergent wasn't used	<ul style="list-style-type: none"> ·Use only automatic dishwasher detergents to avoid sudsing. ·To remove suds from the tub, open the dishwasher and let suds evaporate. Add 1 gallon of cold water to the tub. Close the door until it locks into place. Pump out water by pressing START/RESET, then immediately press START/RESET again. Repeat if necessary.
	Rinse agent was spilled	<ul style="list-style-type: none"> ·Always wipe up rinse agent spills immediately.
Stained tub interior	Detergent with colorant was used	<ul style="list-style-type: none"> ·Some detergents contain colorant (pigment or dyes) that will discolor the tub interior with extended use. Check the detergent cup for signs of any discoloration. If cup is discolored, change to detergent without any colorant.
Dishes and flatware not clean	Inlet water temperature is below 120°F.	<ul style="list-style-type: none"> ·Raise the water heater temperature to 120°F.
	Water pressure is temporarily low	<ul style="list-style-type: none"> ·Turn on a faucet. Is water coming out more slowly than usual? If so, wait until pressure is normal before using your dishwasher.
	Air gap is clogged	<ul style="list-style-type: none"> ·Clean the air gap.
	Improper rack loading	<ul style="list-style-type: none"> ·Make sure large dishware does not block the detergent dispenser or the wash arms.
Spots and filming on glasses and flatware	Extremely hard water	<ul style="list-style-type: none"> ·To remove stubborn spots from glassware:
	Low inlet water temperature	1 Remove all metal utensils from the dishwasher.
	Overloading the dishwasher	2 Do not add detergent.
	Improper loading	3 Select the POT PANS cycle and SPEED DRY option.
	Old or damp powder detergent	4 Start the dishwasher and allow to run for 26 minutes. Dishwasher will now be in the main wash.
	Rinse agent dispenser empty	5 Open the door and pour 2 cups (500 ml) of white vinegar into the bottom of the dishwasher.
Too little detergent	6 Close the door and allow to complete the cycle. If vinegar rinse doesn't work: Repeat as above, except use 1/4 cup (60 ml) of citric acid crystals instead of vinegar.	

Questions?
Use this
problem
solver

PROBLEM	POSSIBLE CAUSE	WHAT TO DO
Cloudiness on glassware	Combination of soft water and too much detergent	·This is called etching and is permanent. To prevent this from happening, use less detergent if you have soft water. Wash glassware in the shortest cycle that will get them clean.
	Water temperature entering the dishwasher exceeds 150°F.	·Lower the water heater temperature.
Black or gray marks on dishes	Aluminum utensils have rubbed against dishes	·Remove marks with a mild, abrasive cleaner.
Yellow or brown film on inside surfaces	Tea or coffee stains	·Remove the stain by hand, using a solution of 1/2 cup bleach and 3 cups warm water. ▲WARNING Before cleaning interior wait at least 20 minutes after a cycle for the heating element to cool down. Failure to do so can result in burns.
	An overall yellow or brown film can be caused by iron deposits in water	·A special filter in the water supply line is the only way to correct this problem. Contact a water softener company.
White film on inside surfaces	Hard water minerals	·To clean the interior, apply dishwasher detergent to a damp sponge. Wear rubber gloves. Do not use any type of cleanser other than dishwasher detergent because it may cause foaming or sudsing.
Dishes do not dry	Low inlet water temperature	·Make sure inlet water temperature is correct. ·Select SPEED DRY Option.
	Rinse agent dispenser is empty	·Check the rinse agent dispenser.
Control panel responded to inputs but dishwasher never filled with water	Door latch may not be properly seated	·Call for service.
Dishwasher won't run	Fuse is blown, or the circuit breaker tripped	·Replace fuse or reset circuit breaker. Remove any other appliances from the circuit. ·Try resetting the START/RESET pad.
Steam	This is normal	·Steam comes through the vent by the door latch during drying and when water is being pumped out.
Sanitized light does not illuminate at the end of the cycle	The door was opened and the cycle was interrupted during or after the main wash portion	·Do not interrupt the cycle anytime during or after main wash.
	The incoming water temperature was too low	·Raise the water heater temperature to 120°F.

With the purchase of your new Monogram appliance, receive the assurance that if you ever need information or assistance from GE, we will be there. All you have to do is call—toll-free!

GE Answer Center®

***In the USA:
800.626.2000***

Whatever your question about any Monogram major appliance, GE Answer Center® information service is available to help. Your call—and your question—will be answered promptly and courteously. And you can call any time. GE Answer Center® service is open 24 hours a day, 7 days a week.

In Canada, call 1.888.880.3030.

In-Home Repair Service

***In the USA:
800.444.1845***

***In Canada:
1.888.880.3030***

A GE consumer service professional will provide expert repair service, scheduled at a time that's convenient for you. Many GE Consumer Service company-operated locations offer you service today or tomorrow, or at your convenience (7:00 a.m. to 7:00 p.m. weekdays, 9:00 a.m. to 2:00 p.m. Saturdays). Our factory-trained technicians know your appliance inside and out—so most repairs can be handled in just one visit.

For Customers With Special Needs...

***In the USA:
800.626.2000***

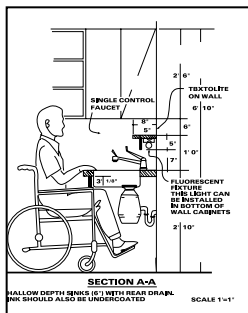

GE offers Braille controls for a variety of GE appliances, and a brochure to assist in planning a barrier-free kitchen for persons with limited mobility.

Consumers with impaired hearing or speech who have access to a TDD or a conventional teletypewriter may call 800.TDD.GEAC (800.833.4322) to request information or service.

Service Contracts

***In the USA:
800.626.2224***

***In Canada:
1.888.880.3030***

You can have the secure feeling that GE Consumer Service will still be there after your warranty expires. Purchase a GE contract while your warranty is still in effect and you'll receive a substantial discount. With a multiple-year contract, you're assured of future service at today's prices.

Parts and Accessories

***In the USA:
800.626.2002***

***In Canada:
1.888.880.3030***

Individuals qualified to service their own appliances can have parts or accessories sent directly to their home. The GE parts system provides access to over 47,000 parts...and all GE Genuine Renewal Parts are fully warranted.

User maintenance instructions contained in this guide cover procedures intended to be performed by any user. Other servicing generally should be referred to qualified service personnel. Caution must be exercised, since improper servicing may cause unsafe operation.

**Consumer Product
Ownership Registration**
Important Mail Today

GE Appliances



Place
1st Class
Letter
Stamp
Here

General Electric Company
Warranty Registration Department
P.O. Box 34070
Louisville, KY 40232-4070

Consumer Product Ownership Registration

Dear Customer:

Thank you for purchasing our product and thank you for placing your confidence in us. We are proud to have you as a customer!

Follow these three steps to protect your new appliance investment:

1 Complete and mail your Consumer Product Ownership Registration today. Have the peace of mind of knowing we can contact you in the unlikely event of a safety modification.

2 After completing this registration, write your model and serial numbers in this guide. You will need this information should you require service. The service number in the USA: 800.444.1845. In Canada: 1.888.880.3030

3 Read your Use and Care Guide carefully. It will help you operate your new appliance properly. If you have questions, or need more information, in the USA, call the GE Answer Center® 800.626.2000. In Canada, call 1.888.880.3030.

Important: To ensure that your product is registered, mail the separate product registration card. If the separate card is missing, fold and mail this form. No envelope is needed.

Consumer Product Ownership Registration



Product
Dishwasher

Model No.

Serial No.

Mr. Mrs.
Ms. Miss

First Name _____ Last Name _____

Street Address _____

Apt. # _____

City _____ State _____ Zip Code _____

Date Placed In Use Month _____ Day _____ Year _____ Phone Number _____ - _____ - _____



General Electric Company
Louisville, KY 40225

TAPE CLOSED

YOUR MONOGRAM DISHWASHER WARRANTY

Staple sales slip or cancelled check here. Proof of original purchase date is needed to obtain service under warranty.

WHAT IS COVERED

From the Date of the Original Purchase

ONE-YEAR

Any part of the dishwasher which fails due to a defect in materials or workmanship. During this full one-year warranty, GE will also provide, free of charge, all labor and in-home service to replace the defective part.

Second Year

Any part of the dishwasher which fails due to a defect in materials or workmanship. During this second-year limited warranty, you will be responsible for any labor or in-home service costs.

Five Years

The dishwasher rack, if it should rust, or the electronic control module if it should fail due to a defect in materials or workmanship. During this five-year limited warranty, you will be responsible for any labor or in-home service costs.

Lifetime

The PermaTuf® tub or door liner, if it fails to contain water due to a defect in materials or workmanship. During this full lifetime warranty, GE will also provide, free of charge, all labor and in-home service to replace the defective part.

.....
This warranty is extended to the original purchaser and any succeeding owner for products purchased for ordinary home use in Canada. Proof of the original purchase date is needed to obtain service under the warranty.

All warranty service will be provided by our Factory Service Centers or by our authorized Customer Care® servicers during normal working hours.

Should your appliance need service, during warranty period or beyond, call 1.888.880.3030.

WHAT IS NOT COVERED

- Service trips to your home to teach you how to use the product.

Read your Use and Care material.

If you then have any questions about operating the product, please contact your dealer or our Consumer Relations office at the address below, or call, toll free:

1.888.880.3030

- Improper installation.
- Replacement of house fuses or resetting of circuit breakers.
- Failure of the product if it is abused, misused, or used for other than the intended purpose or used commercially.

- Damage to product caused by accident, fire, floods or acts of God.
- Incidental or consequential damage to personal property caused by possible defects with this appliance.
- Cleaning or servicing of the air gap device in the drain line.

WARRANTOR IS NOT RESPONSIBLE FOR CONSEQUENTIAL DAMAGES.

Some provinces do not allow the exclusion or limitation of incidental or consequential damages, so the above limitation or exclusion may not apply to you. This warranty gives you specific legal rights, and you may also have other rights which vary from province to province. To know what your legal rights are in your province, consult your local or provincial consumer affairs office.

Warrantor: Camco Inc. If further help is needed concerning this warranty, write: Manager, Consumer Relations, Camco Inc., 1 Factory Lane, Suite 310, Moncton, N.B. E1C 9M3.

YOUR MONOGRAM DISHWASHER WARRANTY

Staple sales slip or cancelled check here. Proof of original purchase date is needed to obtain service under warranty.

WHAT IS COVERED

From the Date of the Original Purchase

Control Settings

ONE-YEAR

Any part of the dishwasher which fails due to a defect in materials or workmanship. During this **full one-year warranty**, GE will also provide, **free of charge**, all labor and in-home service to replace the defective part.

Second Year

Any part of the dishwasher which fails due to a defect in materials or workmanship. During this **second-year limited warranty**, you will be responsible for any labor or in-home service costs.

Five Years

The **dishwasher rack**, if it should rust, or the **electronic control module** if it should fail due to a defect in materials or workmanship. During this **five-year limited warranty**, you will be responsible for any labor or in-home service costs.

Lifetime

The **PermaTuf® tub or door liner**, if it fails to contain water due to a defect in materials or workmanship. During this **full lifetime warranty**, GE will also provide, **free of charge**, all labor and in-home service to replace the defective part.

.....
This warranty is extended to the original purchaser and any succeeding owner for products purchased for ordinary home use in the 48 mainland states, Alaska, Hawaii and Washington, D.C. Proof of the original purchase date is needed to obtain service under the warranty.

All warranty service will be provided by our Factory Service Centers or by our authorized Customer Care® servicers during normal working hours.

Should your appliance need service, during warranty period or beyond, call 800.444.1845.

WHAT IS NOT COVERED

- Service trips to your home to teach you how to use the product.
- Failure of the product if it is abused, misused, or used for other than the intended purpose or used commercially.
- **Read your Use and Care material.**
- Damage to product caused by accident, fire, floods or acts of God.
- If you then have any questions about operating the product, please contact your dealer or our Consumer Affairs office at the address below, or call, toll free:
- Incidental or consequential damage to personal property caused by possible defects with this appliance.
- **GE Answer Center®**
- **800.626.2000**
- **consumer information service**
- Improper installation.
- Cleaning or servicing of the air gap device in the drain line.
- Replacement of house fuses or resetting of circuit breakers.
- **WARRANTOR IS NOT RESPONSIBLE FOR CONSEQUENTIAL DAMAGES.**

Some states do not allow the exclusion or limitation of incidental or consequential damages, so the above limitation or exclusion may not apply to you. This warranty gives you specific legal rights, and you may also have other rights which vary from state to state. To know what your legal rights are in your state, consult your local or state consumer affairs office or your state's Attorney General.

Warrantor: General Electric Company. Louisville, KY 40225



Part No. 165D4700P192
Pub No. 49-5867

Free Manuals Download Website

<http://myh66.com>

<http://usermanuals.us>

<http://www.somanuals.com>

<http://www.4manuals.cc>

<http://www.manual-lib.com>

<http://www.404manual.com>

<http://www.luxmanual.com>

<http://aubethermostatmanual.com>

Golf course search by state

<http://golfingnear.com>

Email search by domain

<http://emailbydomain.com>

Auto manuals search

<http://auto.somanuals.com>

TV manuals search

<http://tv.somanuals.com>