

Use and Care Guide

Dishwasher



Safety Instructions3



Installation Instructions

Built-in Dishwasher15-21
Portable Dishwasher4-5
Undersink Dishwasher...15, 21, 26



Operating Instructions, Tips

Appliance Registration2
China, Crystal, Sterling14
Detergent Guide8, 9
Dispenser Cups9
Features6, 7
How to Operate6, 7
Loading10, 11
Operating Instructions6, 7
Rinse Agent8
Water Temperature8



Care and Cleaning

Winter Storage13
Wood Top13



Problem Solver18-20



Preparation

Front Panel Change12



Consumer Services

Model and Serial Numbers2
Repair Service2
Camco Service25

For service please call
1-800-361-3400

TRY

Cascade

For Virtually Spotless results!

IMPORTANT

ADD ONE LITRE OF WATER BEFORE INITIAL START

You must add one litre of water into the
dishwasher to facilitate the first start.

RECYCLED PAPER



RECYCLABLE

We care about our environment

Download from Www.Somanuals.com. All Manuals Search And Download.

500A200P047





A NOTE TO CONSUMERS

We'd like to thank you and congratulate you for making the wise decision in purchasing your dishwasher. This User Guide is designed to be kept near your dishwasher at all times for quick and easy reference. Features may vary on some dishwasher models. Please read the following tips to insure your dishwasher is operating at its best performance.

We care about you and your appliance and we want your dishwasher *to do its job for you.*



• **HOT WATER** – Your dishwasher needs hot water for best results. **Water entering the dishwasher should be at least 120°F.** but your dishwasher performs **BETTER** with **HIGHER** water temperatures not to exceed 150°F.



• **WATER HARDNESS** – The hardness of the water plays an important part in how well your dishwasher cleans. In areas where water is very hard (12 grains or more), it may be necessary to install a water softener. If you do not know the hardness of your water supply, contact your local water department.



• **DETERGENTS** – Only use detergents labeled for use in automatic dishwashers. **▲ Never use laundry detergents or liquid soaps...** that will cause oversudsing and leaks. The amount of detergent you use depends on the water hardness and the amount of soil on your dishes. In most cases, detergent amounts should be increased for hard water and heavy soil.



• **RINSE AGENT** – should always be used:
– to reduce water spotting
– to improve drying.
Always check and refill the rinse agent when necessary.



• **FOR BEST RESULTS** – The cycles and the options you choose have an effect on the results you get. Please, see the Operating Instructions and Tips for more information.



Before using your dishwasher, read this guide carefully.

It is intended to help you operate and maintain your new dishwasher properly.

Keep it handy for answers to your questions.

If you don't understand something or need more help, call:

1-800-361-3400

or refer to page 25.



If you received a damaged dishwasher...

Immediately contact the dealer (or builder) that sold you the dishwasher.

Save time and money. Before you request service...

Check the Problem Solver in the back of this guide. It lists causes of minor operating problems that you can correct yourself.



Write down the model and serial numbers.

You'll find them on a label fastened to the tub wall just inside the dishwasher door.

These numbers are also on the Consumer Product Ownership Registration Card that came with your dishwasher. Before sending in this card, please write these numbers here:

Model Number

Serial Number

Use these numbers in any correspondence or service calls concerning your dishwasher. Staple sales slip here.

We'll be there...

No matter what major appliance you buy from us, you always get more than a quality product. You receive the added assurance that, should you ever need our help, we'll be there.

We ask that you please be sure to read all the Important Safety Instructions before operating your new appliance to insure your safety.

IMPORTANT SAFETY INSTRUCTIONS

Read all instructions before using this appliance.



WARNING - When using this appliance, always exercise basic safety precautions, including the following.

- Use this appliance only for its intended purpose, as you will find described in this Use and Care Guide.



This dishwasher must be properly installed and located in accordance with the Installation Instructions before it is used.

- This appliance must be connected to a grounded metal, permanent wiring system; or an equipment-grounding conductor must be run with the circuit conductors and connected to the equipment-grounding terminal or lead of the appliance. See Installation Instructions for grounding details.
- Connect to a properly rated, protected and sized power-supply circuit to avoid electrical overload.



Do not store or use combustible materials, gasoline or other flammable vapors and liquids in the vicinity of this or any other appliance .

- Use only powder or liquid detergents or wetting agents recommended for use in a dishwasher
- Do not wash plastic items unless marked "dishwasher safe" or the equivalent. For plastic items not so marked, check the manufacturer's recommendations.
- Load light plastic items so they will not become dislodged and drop to the bottom of the dishwasher - they might come into contact with the Calrod® heating element and be damaged.

To minimize the possibility of injury.

- When loading items to be washed:
 - A. Locate sharp items so that they are not likely to damage the door seal, and
 - B. Load sharp knives with handles up to reduce the risk of cut-type injuries.
- Do not tamper with controls.

- Do not touch the Calrod® heating element during or immediately after use.
- Do not operate your dishwasher unless all enclosure panels are properly in place.
- Do not abuse, sit on, or stand on the door or dish rack of the dishwasher,.
- Close supervision is necessary if this appliance is used by or near children. Do not allow children to play inside, on or with this appliance or any discarded appliance. Dispose of discarded appliances and shipping or packing material properly. Before discarding a dishwasher, remove the door of the washing compartment.



- Keep all washing detergents and wetting agents out of the reach of children, preferably in a locked

cabinet. Observe all warnings on container labels to avoid personal injury.

- To minimize the possibility of electric shock, disconnect this appliance from the power supply before attempting any maintenance. **NOTE:** Turning the control dial to the OFF position does not disconnect the appliance from the power supply. We recommend having a qualified technician service your appliance.



WARNING-HYDROGEN GAS is produced by the chemical action within your water heater. It can accumulate in the water heater and/or water pipes if hot water has not been used for a period of two weeks or longer. **HYDROGEN GAS IS EXPLOSIVE.** To prevent the possibility of damage or injury, if you have not used hot water for two weeks or more, or moved into a residence in which the hot water system may not have been used for some time, turn on all hot water faucets and allow them to run for several minutes before using any electrical appliance which is connected to the hot water system. This will allow any hydrogen gas to escape. Also, since the gas is flammable, do not smoke or use an open flame or appliance during this process.

SAVE THESE INSTRUCTIONS



HOW TO USE THE UNICOUPLE

(Portable Models Only)

Before operating your dishwasher the first time...

Attach the Faucet Adapter. The special faucet adapter supplied with your dishwasher must be assembled to the sink faucet before you can use your dishwasher.

The faucet adapter is designed to fit standard spouts having internal or external threads. You will find the adapter and two washers in the "Faucet Adapter" packet in your dishwasher.

To install faucet adapter, first remove the old aerator or trim ring on your faucet spout.

If faucet has external threads:

Insert the thinner of the two washers into the faucet adapter and attach it to the faucet spout.

Tighten with pliers.

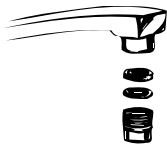

If faucet has internal threads:

Insert both washers into the faucet adapter and attach it to the faucet spout.

Tighten with pliers.

If the faucet adapter threads do not match your faucet spout, your local hardware or plumbing supply

store normally has additional fittings to adapt your faucet spout to the special faucet adapter.

NOTE: A sink spray attachment hose can burst if it is installed on the same sink with your dishwasher. We suggest that you disconnect the sink spray attachment if your sink has one and plug the hole.

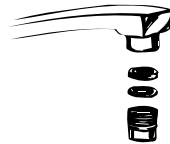

How to connect the Unicouple

1. Pull Unicouple and its hoses completely out from storage compartment located at rear of dishwasher and attach it to the faucet adapter.

2. Attach the Unicouple connector to the faucet adapter by depressing collar at the top of the connector. When Unicoupler is all the way up onto the adapter, release the collar. It will then snap into position to lock the Unicouple in place.

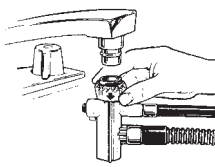

PULL RING DOWN

The Unicouple's small hose carries water from the faucet to the dishwasher. Its large hose carries drain water to the sink. Be sure Unicouple is pointing toward the sink bowl drain opening and the sink drain is open for water that will drain from your dishwasher. If your dishwasher drains into a disposer, operate the disposer until it is completely empty before starting the dishwasher.

3. Turn hot water fully on before starting the dishwasher.

How to disconnect the Unicouple from faucet adapter

1. Turn off the hot water.
2. Release the water pressure by depressing the pressure release button. This relieves water pressure and protects you, and the room, from severe splashing.

3. Release Unicouple from faucet by depressing the collar at the top of the Unicouple connector.

How to disconnect your dishwasher

1. Remove the power cord plug from the wall receptacle.
2. Disconnect Unicouple from faucet adapter.

NOTE: When motor stops at the end of the final rinse, the Unicouple can be disconnected and returned to storage.

How to drain excess water from Unicouple hoses

If the sink is 34" or higher from the floor, the excess water in Unicouple hoses cannot be drained directly into the sink. It will be necessary to drain excess water from hoses into a bowl or suitable container that is held outside and lower than the sink.



HOW TO CONNECT ELECTRICITY



GROUNDING INSTRUCTIONS

This appliance must be grounded. In the event of a malfunction or breakdown, grounding will reduce the risk of electric shock by providing a path of least resistance for electric current. This appliance is equipped with a cord having an equipment-grounding conductor and a grounding plug. The plug must be plugged into an appropriate outlet that is installed and grounded in accordance with all local codes and ordinances.

WARNING

Improper connection of the equipment-grounding conductor can result in a risk of electric shock. Check with a qualified electrician or service representative if you are in doubt whether the appliance is properly grounded. Do not modify the plug provided with the appliance; if it will not fit the outlet, have a proper outlet installed by a qualified electrician.

Caution, for personal safety:

DO NOT USE AN EXTENSION CORD OR AN ADAPTER PLUG WITH THIS APPLIANCE. DO NOT, UNDER ANY CIRCUMSTANCES, CUT OR REMOVE THE THIRD GROUNDING PRONG FROM THE POWER CORD.

Dishwasher must be electrically grounded in accordance with local codes and ordinances.

Electrical requirements

- This appliance must be supplied with 120V, 60 Hz, and connected to an individual, properly grounded branch circuit, protected by a 15 amp circuit breaker or fuse.
- If the electric supply provided does not meet the above specifications, it is recommended that a licensed electrician install an approved outlet.
- Your dishwasher circuit should not be used for any other appliance while the dishwasher is in operation as the dishwasher requires the full capacity of the circuit.
- If the wall receptacle you plug the dishwasher's power cord into is controlled by a switch, turn on the switch.

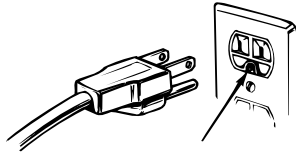

INSURE PROPER
GROUND EXISTS
BEFORE USE



HOW TO OPERATE YOUR DISHWASHER

Models With Delay

Wash Cycle	Water Use Gallons/Litres (approx.)	Wash Cycle Time Minutes (approx)	Cycle Sequences
POTSCRUBBER	8.5 / 38.6	68	Rinse Rinse Rinse Main Wash Rinse Rinse Rinse
NORMAL	7.2 / 32.7	68	Rinse Rinse Main Wash Rinse Rinse Rinse
LIGHT	6.1 / 27.7	68	Rinse Rinse Main Wash Rinse Rinse
WATER SAVER	4.8 / 21.8	68	Rinse Main Wash Rinse Rinse
SHORT OR WATER SAVER (on the dial)	5.5 / 25.0	52	Rinse Main Wash Rinse Rinse Rinse
RINSE & HOLD	2.3 / 10.5	9	Rinse Rinse Rinse
HOTSTART adds	1.3 / 5.9	30 to selected cycle	Rinse, start selected cycle

Models Without Delay

Wash Cycle	Water Use Gallons/Litres (approx.)	Wash Cycle Time Minutes (approx)	Cycle Sequences
POTSCRUBBER	7.8 / 35.5	63	Rinse Rinse Rinse Main Wash Rinse Rinse Rinse
NORMAL	6.7 / 30.5	63	Rinse Rinse Main Wash Rinse Rinse Rinse
LIGHT	5.7 / 25.9	68	Rinse Rinse Main Wash Rinse Rinse
SHORT OR WATER SAVER (on the dial)	5.5 / 25.0	55	Rinse Main Wash Rinse Rinse Rinse
RINSE & HOLD	2.2 / 10.0	9	Rinse Rinse Rinse
HOTSTART adds	1.3 / 5.9	30 to selected cycle	Rinse, start selected cycle

HOW TO OPERATE YOUR DISHWASHER



Load your dishwasher according to the instructions in the USE AND CARE GUIDE.

HOW TO GET STARTED (3 EASY STEPS)

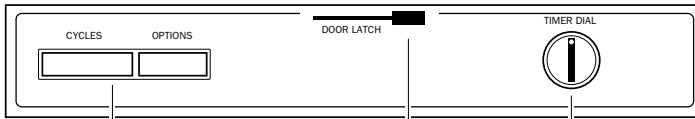

SELECT A CYCLE AND OPTIONS **1**

CLOSE DISHWASHER AND LATCH **2**

TURN TO START **3**

PS...Have you added soap and rinse agent?

How to select a cycle

NOTE: Your dishwasher will have some or all of these cycles or options. Read the list to become familiar with the choice your dishwasher has. To make sure you have clean dishes, you should always choose a higher performance cycle if you are not certain.

CYCLES ON PUSHBUTTONS

Cycles	Cycle Description
POTSCRUBBER or POTS AND PANS HOTSTART	For heavily soiled dishes or cookware with dried-on soils. Everyday dishes may be included. This cycle will not remove burned-on foods. Preheats wash water to the correct temperature.
NORMAL	For loads of everyday dishes, glasses and cookware with medium soils. Designed to yield high performance on average soils.
LIGHT or WATER SAVER	For dishes with light soils
RINSE	For rinsing partial loads that will be washed later. Make sure ENERGY SAVER option is selected. <i>Do not use detergent.</i>

CYCLES ON DIALS

Cycles	Cycle Description
HOTSTART	Preheats wash water to the correct temperature. 1)-Select a cycle and any options. 2)-Be sure the door is unlatched. 3)-Slowly turn the dial to HOTSTART. 4) - Latch the door to START the cycle.
SHORT WASH or WATER SAVER	For quickly washing loads of everyday dishes with medium soils that have not dried-on, such as loads consisting mostly of glasses. 1)-Select the NORMAL cycle and any options. 2)-Be sure the door is unlatched. 3)-Slowly turn the dial to SHORT. 4)-Latch the door to START the cycle.
RINSE AND HOLD	For rinsing partial loads that will be washed later. Make sure ENERGY SAVER is selected. <i>Do not use detergent.</i> 1)-Make sure ENERGY SAVER is selected. 2)-Be sure the door is unlatched. 3)-Slowly turn the dial to RINSE AND HOLD. 4)-Latch the door to START the cycle.
PLATE WARMER	For warming clean dishes and serving plates. This cycle will take approximately 32 minutes. 1)-Load clean dishware to be warmed. 2)-Select HEAT DRY or DRYING. 3)-Be sure the door is unlatched. 4)-Slowly turn the dial to PLATE WARMER. 5)-Latch the door and START the cycle.

ENERGY OPTIONS

Energy Options	Energy Options Description
HEAT WASH	Provides extra heat for best performance. It is used best with heavily-soiled dishes.
HEAT DRY or DRYING ON	Turn the drying heater on for fast drying. This option will extend the time to your wash cycle by approximately 32 minutes.
ENERGY SAVER	Turns all of the other OPTIONS off.
AIR DRY or DRYING OFF	Turns off the drying heat option. Dishes air dry naturally and energy is saved.

ENERGY OPTIONS

DELAY START	DELAY START allows you to delay the start time of any PUSH BUTTON CYCLE automatically. 1)-Select your desired wash cycle and options. 2)-Turn the dial to the desired time. 3)-The door must be latched for the dishwasher to operate.
-------------	--



How to Test Water Temperature

To get dishes clean and dry you need hot water.

Check your water temperature with a candy or meat thermometer. Turn on the hot water faucet nearest the dishwasher. Put the thermometer in a glass and let the water run continuously into the glass until

the temperature stops rising. If the water temperature is below 49°C (120°F), adjust your water heater.

To prevent dish damage, inlet water should not exceed 65°C (150°F).

How to Use a Rinse Agent

A rinse aid such as *JET DRY* makes water flow off dishes quicker than usual. This lessens water spotting and makes drying faster, too.

For best dishwashing performance, use of a rinse agent is recommended.

How to fill the rinse agent dispenser.

Unscrew the cap. Note the FULL line on the tip of the cap. On some models, the dispenser can be checked by pressing the clear centre of the fill cap 2 or 3 times. Add the liquid rinse agent until it just reaches the top of the full line. Replace the cap. The dispenser automatically releases the rinse agent into the final rinse water.

DO NOT FILL PAST “MAX” LINE.

If you accidentally spill: Wipe up the rinse agent with a damp cloth. Don't leave the spill in the dishwasher. It can keep your detergent from working.

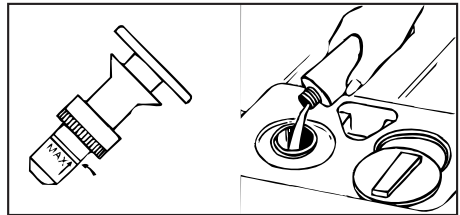



How to Choose and Use the Right Detergent

First, use only powder or liquid detergent specifically made for use in dishwashers. Other types will cause over sudsing..

Second, check phosphate content. Phosphate helps prevent hard-water materials from forming spots or film on dishes. If your water is hard (7 grains or more), your detergent has to work harder. Detergents with a higher phosphate level will probably work better. If phosphate content is low (8.7% or less), you'll have to use extra detergent with hard water.

Your water department can tell you how hard your water is. So can your county extension agent or your area's water softener company. Just call and ask them how many "grains" of hardness there are in your water.

How much detergent should you use? That depends. Is your water "hard" or "soft"? With

hard water, you need extra detergent to get dishes clean. With soft water, you need less detergent.

Too much detergent with soft water not only wastes money, it can be harmful. It can cause a permanent cloudiness of glassware, called "etching". An outside layer of glass is etched away! Of course, this takes some time. But why take a chance when it's easy to find out the hardness of your water.

Keep detergent fresh and dry. Under the sink isn't a good place to store detergent because there is too much moisture. Don't put powder detergent into dispenser until you're ready to wash dishes, either. (It won't be fresh OR dry.)

Some detergents contain colorant (pigment or dyes) that will discolor the tub interior with extended use. Check the detergent cup for signs of any discoloration. If cup is discolored, change to detergent without any colorant.

Loading Detergent

You'll find two detergent dispensers on the inside door of your dishwasher. Two, because some cycles use two washes.

(Be sure the CYCLE INDICATOR DIAL is at OFF position before adding detergent. Otherwise, the detergent cup will not close and latch properly).

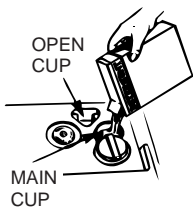

Close the main cup.

NOTE: To open the detergent cup after it has been closed, unlatch the door and rotate the Cycle Indicator Dial a full turn to the OFF position. When the closed cup contains soap it is best that the door be in a partially open position before rotating the Cycle Indicator Dial. This will help reduce the amount of detergent and rinse aid agent spillage into the tub.



GRASP HANDLE, ROTATE AND CLOSE TIGHTLY

Try the Cascade that best meets your own needs!



For Virtually Spotless results!



No need to pre-wash your dishes



HOW TO LOAD YOUR DISHWASHER

For best dishwashing results follow these loading guidelines. Features and appearance of racks and silverware baskets may vary from your model.

Upper Rack

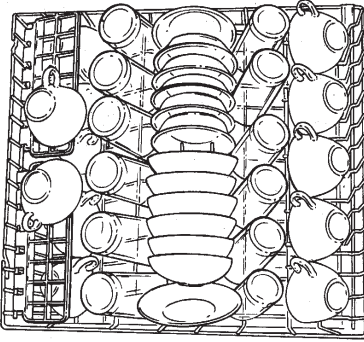

12 place settings

The upper rack is for glasses, cups and bowls. Cups and glasses fit best along the sides. This is also a secure place for dishwasher-safe plastics.

A cup shelf may be placed in the up or down position to add flexibility. Load the bottom row first, then fold the shelf down and load the top row.

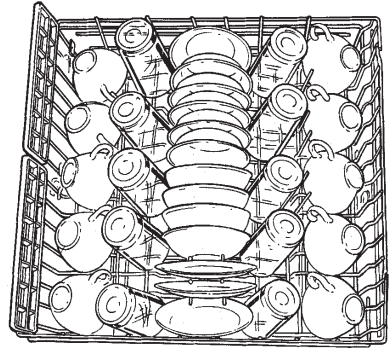

10 place settings

NOTE:

- Secure larger dishwasher-safe plastics over two fingers when possible.
- Make sure when loading that small plastic items are secured, so they can't fall onto the heating element.

Lower Rack

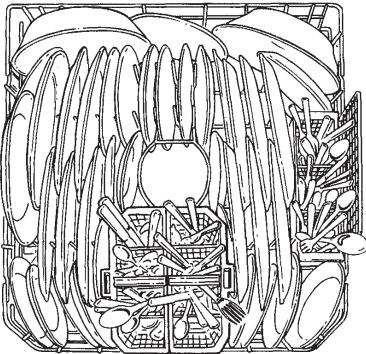

12 place settings

NOTE: When loading the lower rack, do not load large platters or trays in the front right corner. They may prevent detergent from circulating in the wash cycle.

The lower rack is best used for plates, saucers, and cookware. Large items such as broiler pans and racks should go along the sides. Load platters, pots and bowls along the sides, in corners, or in the back.

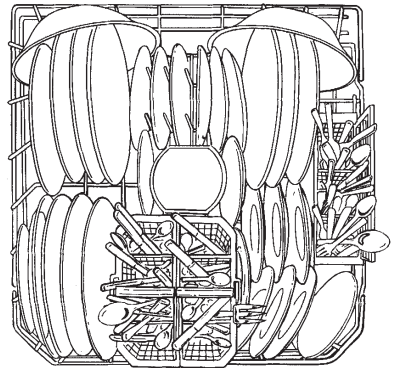

10 place settings

Place all items to be washed with the soiled side facing the centre of the rack.



Wash Tower

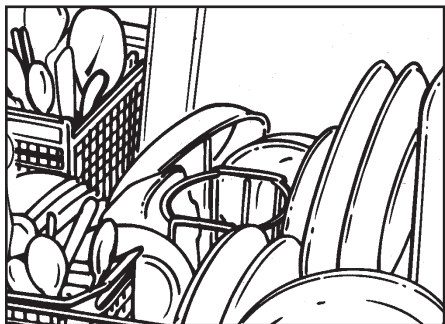

Keep the center area clear in the lower rack.

The wash tower rises through the center of the lower rack during the wash and rinse portions of the cycle. **Don't block it or load tall things next to it.**

Also, be careful not to let a portion of an item such as a pot or dish handle extend through the bottom rack. This could block the wash arm and cause poor washing results.

Silverware Baskets

NOTE: Don't place the silverware basket in the front right corner because the detergent could pour into it and damage silverware.



Don't let any item extend through bottom.

Put flatware in the removable basket with fork and knife handles up to protect your hands. Place spoons and larger serving forks in the basket with handles down. Mix knives, forks and spoons so they don't nest together. Distribute evenly.

To increase the flexibility of the lower rack, the silverware basket may be split. Grasp the basket at opposite corners and slide apart. The basket sections should be placed in the lower rack by hanging them on the top hoop.

Security cell covers hinged in the silverware basket handles can be lowered to either side to secure lightweight items from the effects of the vigorous wash action.

Small plastic items, such as measuring spoons and lids from small containers, should go in the covered silverware basket.

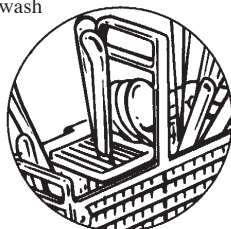

Forget a dish? Here's when you can add it.

Add dishes any time during the RINSE & HOLD cycle. With other wash cycles, you can add dishes at any time BEFORE the main detergent wash portion of the cycle.

However, opening the door during any cycle lessens cleaning power. So try to load everything at the beginning.

Here's how to add a forgotten dish:

1. Push the door latch to the left. Washing will stop.
2. Wait a few seconds until the water calms. Then open the door. **WARNING:** Hot vapor may rise from opened door.
3. Add dishes you've forgotten.
4. Close the door and push the latch to the far right. When the door is locked, washing will continue.



ABOUT OPTIONAL ACCESSORIES

You can change the door and lower access panel appearance of your dishwasher by ordering of these optional accessories:

- Colour Panels
- 1/4" Wood Panel Trim Kit
- 3/4" Trimless Panel Kit

These accessories are available at extra cost. Please consult the Yellow pages for your local Camco phone number.

Descriptions of Optional Accessories

Colour panels – Replacement door panels and lower access panels are available in the following colours:

- GPF300A (Almond)
- GPF300B (Black)
- GPF300W (White)

Wood panel trim kit – This accessory contains *trim and instructions* for you to supply and install a 1/4" thick decorative wood door and lower access panel:

- GPF325A (Almond)
- GPF325B (Black)
- GPF325W (White)

NOTE: The **GPF100 dishwasher door spring kit** must also be ordered and installed *when the door panel weighs four lbs. or more.*

Trimless panel kit

This accessory contains *parts and instructions* for you to supply and install a 3/4" thick decorative wood door and lower access panel:

- GPF375

NOTE: The **GPF100 dishwasher door spring kit** will be included with the *trimless panel kit* and must be installed with it.

Conversion Kit

At any time, portable/convertible dishwashers can be built-in under your kitchen counter. A special conversion kit is available from your dealer or service organization.

CARE AND CLEANING



USER MAINTENANCE INSTRUCTIONS

Clean the control panel with a lightly dampened cloth. Dry thoroughly. Do not use abrasive or sharp objects on the panel. They can damage it.

Clean the outside with a good appliance polish wax. The outside cabinet finish is durable, but it can scratch. So use no scouring pads, or harsh or gritty cleaners.

The inside usually takes care of itself. If it should ever need cleaning, use a mild cleansing powder. Scouring pads and harsh cleaners can mar the finish.

Alternatively, to remove stains inside the PermaTuf® tub or, if you wish to refresh the inside of your unit (including the water distribution system), you may also use citric acid. Fill both detergent cups completely with citric acid and run dishwasher through a full cycle without any dishes. You may repeat as often as you feel necessary.

Citric acid is widely available in powder form at most drugstores across the country. Do not use liquid bleach.

DO NOT USE LIQUID BLEACH

Not Using Your Dishwasher in Winter? Protect Against Freezing.

(On built-in models only)

If your dishwasher is left in an unheated place during the winter, ask a service technician to:

- Cut off electrical power to the dishwasher. Remove fuses or trip circuit breaker.
- Turn off the water supply.
- Disconnect the water inlet line from the water valve.
- Drain water from the inlet line and water valve.

(Use a pan to catch the water.)

- Reconnect the water inlet line to the water valve.

- Drain collection chamber at rear of unit below filter by disconnecting hose to pump. Reconnect after draining.

- Remove the plastic pump cover in the tub bottom and use a sponge to soak up water in the rubber boot.

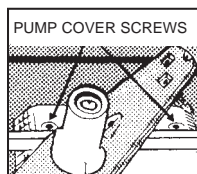

Care of the Dishwasher Top

Before using, wipe well with a dry cloth to remove surface dust. Do not use the top of your dishwasher as a cutting board. It can be scarred

permanently. Never let water stand on the dishwasher top.

Care & Cleaning of the Dishwasher

Cleaning – Outside

The following are Options for Cleaning Stainless Steel:

1. Use soap and water, rinse with clean water and dry with a cotton cloth.
2. Use Stainless Steel Magic or a similar product. It is available from your parts dealer. Be sure to follow the manufacturers instructions.

3. Use a thick paste or baking soda and water. Rub with a soft cloth.
4. Use a non-detergent based cleaner (eg. Formula 409 Glass and Surface cleaner).

Do not use steel wool, acids, abrasives, ammonia or a commercial oven cleaner.

These instructions apply to Stainless Steel surfaces, and could damage other surfaces.



WHAT YOU CAN USUALLY WASH SAFELY IN YOUR DISHWASHER.

Material	Usually Safe	Exceptions (not safe)	Special Instructions
Aluminum	YES	Some coloured anodized aluminium can fade	Some darkening or spotting possible. Remove by scouring with soap-filled steel wool pads.
China/Stoneware	YES	Antique, metal-trimmed, hand-painted or over-the glaze patterns fade. Gold leaf will discolour.	If in doubt, check with the manufacturer. Or test wash one piece daily for at least a month. Compare with the rest of the set.
Crystal	YES	Antique, metal-trimmed or hand-painted patterns fade. Gold leaf will discolour.	Load securely to prevent movement. Check your manufacturer's instruction for your crystal.
Non-dishwasher items - such as electronic air cleaning filters, furnace filters, paintbrushes, etc.	NO		Do not wash in dishwasher. Damage to dishwasher and discolouration or staining of dishwasher may result.
GLASS	YES	Milk glass may yellow.	
Iron	NO	Iron will rust	
Pewter	NO	Pewter tarnishes	
Plastics	YES		If it doesn't say DISHWASHER SAFE, test one piece in the top rack before washing an entire set.
Stainless Steel	YES		Rinse if not washing immediately. Salty or acid foods can stain if left on.
Sterling Silver and Silver Plate	YES	Don't put in same silverware basket with stainless steel. Contact between metals can damage silver. Don't wash copper utensils in the same load. Silver may get a brown film. Adhesive used to attach some hollow-handle knives can loosen.	Rinse if not washing immediately. Salty or acid foods can stain if left on. Dry detergent can cause difficult-to-remove black spots. Place in back section of silverware basket to avoid exposure to detergent from the detergent cup.
Non-stick coatings	YES		After washing, wipe the non-stick coating area with vegetable oil to keep it from losing its non-stick quality.
Tin	NO	Tin can rust.	
Wood	NO	Wood can warp, crack or lose its finish wian any type of washing.	

BUILT-IN DISHWASHER INSTALLATION INSTRUCTIONS



ALL ROUGH-IN PLUMBING AND ELECTRICAL MUST BE COMPLETED BEFORE THE DISHWASHER IS PLACED IN THE UNDERCOUNTER OPENING. ALL ELECTRICAL AND PLUMBING WORK MUST BE IN ACCORDANCE WITH LOCAL CODES. DISHWASHER SHOULD NOT BE INSTALLED IN AREA WHERE FREEZING OF WATER MAY OCCUR.

WARNING

TO REDUCE THE RISK OF ELECTRIC SHOCK, FIRE, OR INJURY TO PERSONS, THE INSTALLER MUST ENSURE THAT THE DISHWASHER IS COMPLETELY ENCLOSED AT THE TIME OF INSTALLATION.

MATERIALS YOU WILL NEED

Materials required:

- 90° elbow
(3/8" NPT external thread on one end and opposite end sized to fit water supply)
- Thread seal tape
- Wire nuts (2)

For new installations only:

- Waste tee for house plumbing, if applicable
- Electrical cable or power cord, if applicable
- Screw type hose clamps
- Strain relief for electrical connection
- Hand shut-off valve (optional)
- Water line 3/8" min. copper or 1/2" min. plastic



Electrical Cable or Power Cord



90° Elbow



Screw Type Clamps



Strain Relief

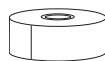

Thread Seal Tape



Wire Nuts



Waste Tee



Hot Water Line



Wire Nuts

PREPARE DISHWASHER ENCLOSURE (For Undersink Dishwasher - see page 26)

- The touch cabinet opening must have a minimum width of 24", and a minimum of 34" high from floor to underside of the countertop. Figure A
- The back wall should be free of pipes or wires. Figure A
- Adjacent cabinets should be square and plumb to ensure a good fit. Figure A
- For corner installation, allow 2" min. clearance between dishwasher and adjacent cabinet or wall or other appliances. Figure B

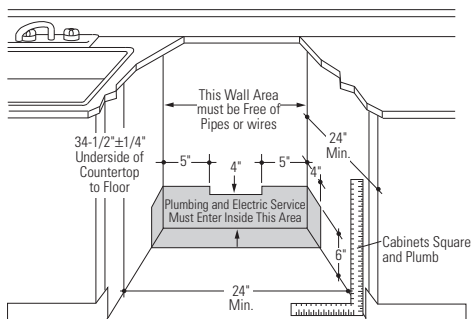
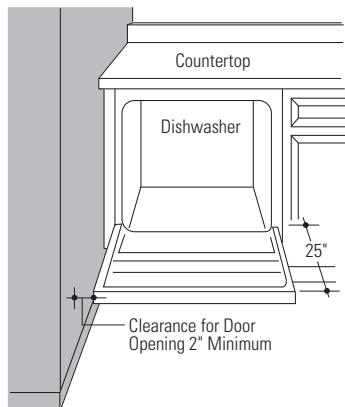

- Make sure the floor is level inside the opening and even with the finished floor of the kitchen.
- The dishwasher must be installed no more than 10 feet from sink for proper drainage.
- This dishwasher must be fully enclosed on the top, sides and back.
- The dishwasher must not support any part of the enclosure.



PREPARE DRAIN PLUMBING

DRAIN REQUIREMENTS

- Follow local codes and ordinances.
- If dishwasher is not adjacent to sink, horizontal drain line should not be longer than 10 feet and should not contain more than three 90° long radius turns.

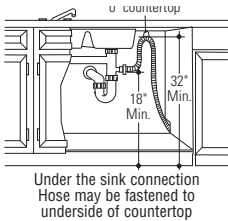
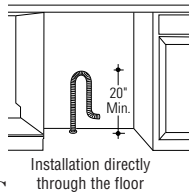

Fig. C



IMPORTANT

TO PREVENT POSSIBLE DRAIN FROM SINK INTO DISHWASHER OR SIPHONING OF DISHWASHER WATER, DRAIN LINE MUST BE ROUTED AS FOLLOWS:
 MIN. 30" ABOVE THE FLOOR FOR UNDER THE SINK CONNECTION.
 MIN. 20" ABOVE THE FLOOR FOR INSTALLATION DIRECTLY THROUGH THE FLOOR.

DRAIN PREPARATION

A drain hose already connected to the pump outlet is supplied with the dishwasher. If the drain hose is not long enough and has to be extended, use a 1/2" O.D. copper tubing with clamp. THE RUBBER END OF THE DRAIN HOSE MAY BE CUT OFF TO ACCOMMODATE THE FOLLOWING SIZES OF TAIL PIECE OR WASTE TEE: 5/8", 3/4" OR 1"

1. A suggested method of connecting the drain hose to a WASTE TEE or a Y branch tailpiece on the existing sink trap is shown in Figure C. They are made by several manufacturers purposely for electric dishwashers.
2. When connecting the drain hose to a DISPOSER, remove hopper plug before making connection. Install waste tee or disposer according to manufacturer's instructions.

Note: be sure to remove drain plug from disposer before attaching drain line. dishwasher will not drain if plug is left in place.

CABINET PREPARATION

Drill 1-1/2" inch diameter hole in the cabinet wall within the shaded area shown in Figure A for the drain hose. Make sure there are no sharp edges. Drain hose will be passed through this hole and connected to the drain in a later step.

PREPARE HOT WATER LINE

Follow local codes and ordinances.

1. The hot water line may enter from either side, the rear or from the floor within the shaded area shown in Figure D.
2. Cut a hole approximately 1-1/2" dia. within the shaded area to admit the line.
3. Turn off the water supply.
4. Install a hand shut-off valve in the supply line in an accessible location, such as under the sink. (The shut-off valve is optional, but recommended and may be required by local codes.)
5. Water connection is on left side of dishwasher. Install the hot water inlet line, using no less than 3/8" O.D. copper tubing or 1/2" O.D. plastic tubing. Route line as shown in Figure D. Extend the water line forward at least 19" from rear wall.
6. The water valve has a 3/8 N.P.T. internal thread. We recommend use of 90 degrees elbow for connection of copper tubing to water valve. (See Figure E)

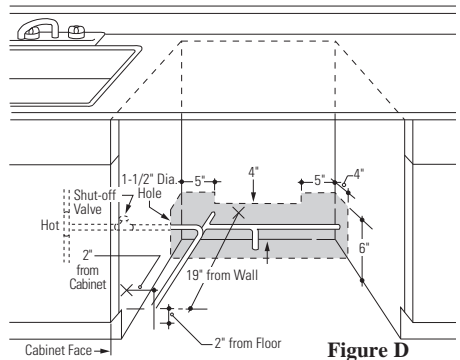
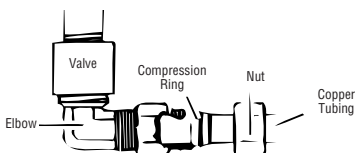

Figure D

7. Adjust the water heater to deliver water between the temperatures of 120°F and 150°F as it comes in the dishwasher.
8. Flush water line to clean out debris.
9. The water pressure of the hot water supply line must be between 20-120 PSI.



PREPARE ELECTRICAL WIRING



GROUNDING INSTRUCTIONS

(FOR THE APPLIANCES SOLD WITHOUT A CORD SET)

This appliance must be connected to a grounded metal, permanent wiring system or an equipment-grounding conductor must be run with the circuit conductors and connected to the equipment-grounding terminal or lead on the appliance.

GROUNDING INSTRUCTIONS

(FOR THE APPLIANCES SOLD WITH A CORD SET)

This appliance must be grounded. In the event of a malfunction or breakdown, grounding will reduce the risk of electric shock by providing a path of least resistance for electric current. This appliance is equipped with a cord having an equipment-grounding plug. The plug must be plugged into an appropriate outlet that is installed and grounded in accordance with all local codes and ordinances.

WARNING

Improper connection of the equipment-grounding conductor can result in a risk of electric shock. Check with a qualified electrician or service representative if you are in doubt whether the appliance is properly grounded. Do not modify the plug provided with the appliance; if it will not fit the outlet, have a proper outlet installed by a qualified electrician.



WARNING: FOR PERSONAL SAFETY:

REMOVE HOUSE FUSE OR OPEN CIRCUIT BREAKER BEFORE BEGINNING INSTALLATION.

DO NOT USE AN EXTENSION CORD OR ADAPTER PLUG WITH THIS APPLIANCE.

FOLLOW NATIONAL ELECTRICAL CODES OR PREVAILING LOCAL CODES AND ORDINANCES.

ELECTRICAL REQUIREMENTS:

- This appliance must be supplied with 120V, 60 Hz., and connected to an individual, properly grounded branch circuit protected by a 15 amperes circuit breaker or fuse.
- Wiring must be 2 insulated wires with ground. Minimum size No. 14 gage.
- If the electrical supply provided does not meet the above requirements, call a licensed electrician before proceeding.

CABINET PREPARATION & WIRING ROUTING

- Wiring may enter from either side, the rear, or from the floor within the shaded area shown in Figure F.
- Cut hole 1-1/2" max. dia. within the shaded area to admit the electrical cable or power cord. The hole must be free of sharp edges. If the cabinet wall partition is metal, the edge of the hole must be covered with a rubber cord protector.

ELECTRICAL CONNECTIONS TO DISHWASHER

A. Dishwasher Sold Without Power Cord
Electrical connection is on right side of dishwasher.

- For cable direct connections the cable must be routed as shown in Figure F. Cable must extend a minimum of 24" from the rear wall.

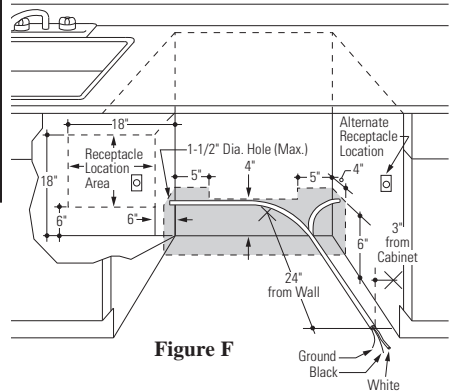

Figure F

B. Dishwasher Sold With Power Cord

1. Install 3-prong grounding type receptacle in the rear wall of sink cabinet next to dishwasher. Receptacle is installed at least 6", but not more than 18", from cabinet opening for dishwasher. **Do not install receptacle in cabinet opening for dishwasher.**
2. Edges of wall opening for power cord should be smooth and well rounded. If the cabinet wall partition is metal, the edge of the opening must be covered using a rubber cord protector. For those models supplied with a power cord, the protector is in a bag inside the dishwasher.
3. Push power cord plug through hole in cabinet wall **before installing** dishwasher in cabinet opening. Take care when installing or moving dishwasher to avoid damage to power supply cord.



INSTALLATION INSTRUCTIONS

CAUTION

Do not remove the wood base until you are ready to install the dishwasher. The dishwasher will tip over when the door is opened.

Check door balance before wood base is removed

Locate the 2 Phillips head countertop mounting screws wrapped with yellow tape and stuck to the top or side of the dishwasher. Set aside for use in Step 10.

Check door balance by opening and closing door. If necessary latch door and adjust one or both springs before the wood base is removed.

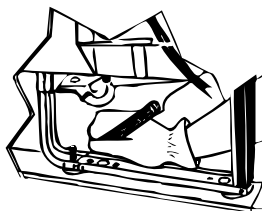

Moving spring hook to rear hole increases spring tension

Spring hook MUST be turned to the outside

Step 1. Remove leveling legs and wood base

Move the dishwasher close to the cabinet and lay it on its back. Remove the four leveling legs with an adjustable wrench. Remove and discard the wood base. Do not "Kick" wood base off, damage will occur.

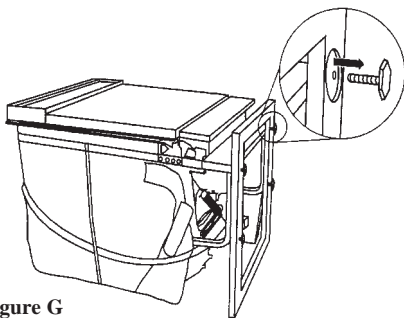

Figure G

Step 2. Install Leveling legs

Screw leveling legs back into the dishwasher frame. The legs should extend approximately 3/4" away from the frame.

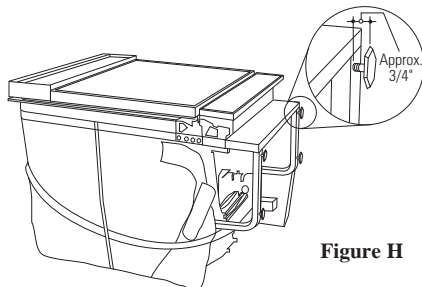

Figure H

Step 3. Remove access panel and toe-kick

Remove the two screws below the access panel and set aside for reuse. Remove access panel by backing out the two screws located between the door and access panel. These screws are secured to access panel with plastic retainers. The junction box is located behind the access panel.

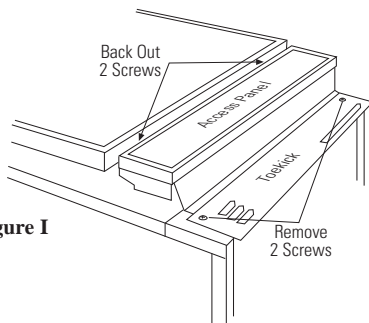

Figure I

Step 4. Install 90° elbow

Install the 90° elbow fitting to the water valve using thread seal tape on the threads. The water valve requires 3/8" NPT fitting with external threads. The opposite end should fit water supply line. Position the end of the elbow to face the rear of the dishwasher.

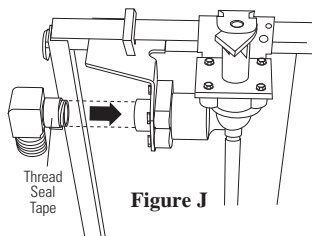

Figure J

INSTALLATION INSTRUCTIONS



Step 5. Position water line and power supply

Position the water supply line and house wiring on the floor of the opening to avoid interference with base of dishwasher and components under dishwasher.

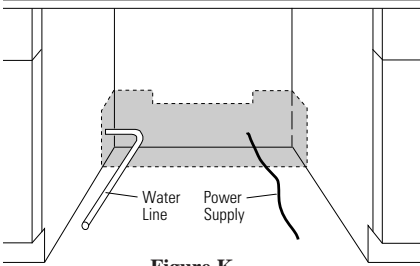

Figure K

Step 6. Insert drain hose through cabinet

Upright dishwasher and position in front of the cabinet opening. Insert the drain hose into the hole previously drilled in the cabinet wall. If a power cord is used, guide the end through a separate hole cut for the electrical cord.

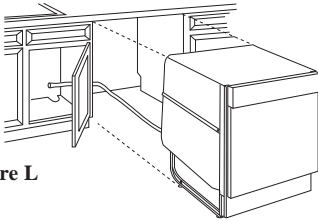

Figure L

Step 7. Slide dishwasher into cabinet

Slide the dishwasher into the opening a few inches at a time.

As you proceed, pull the drain hose through the opening and under the sink. Make sure drain hose is not kinked under dishwasher. Check to be sure there is no interference with water line and wiring.

DO NOT PUSH AGAINST FRONT DOOR PANEL WITH YOUR KNEE. Damage to the door panel will occur.



Figure M

Step 8. Align water and electrical lines

Route the water line and electrical supply to their connection locations under the dishwasher. Do not connect water and electrical in this step.

Step 9. Level dishwasher

Level the dishwasher by adjusting the four leveling legs individually for correct alignment. See Figure N. Dishwasher should be level left to right and front to back for proper dish rack operation and dishwasher performance. Dishwasher door should be in alignment with adjacent cabinets. See Figure O.

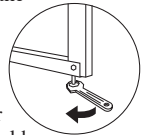

Figure N

Step 10. Position dishwasher and fasten to cabinet

Open the door and position the dishwasher tub flange $3/4$ " from the cabinet opening. Fasten the dishwasher to the underside of the countertop, using the 2 Phillips screws provided in Step 1. Be sure screws are driven straight and flush to avoid interference with door operation. See Figure O.

Important: Make sure that dishwasher is centered in the opening and there is no interference with cabinets when opening or closing the door. Interference may cause a water leak when dishwasher is in operation.

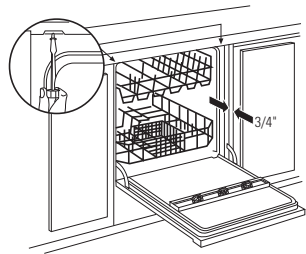

Figure O

Step 11. Connect water supply

Connect water supply line to 90° elbow installed in Step 4.

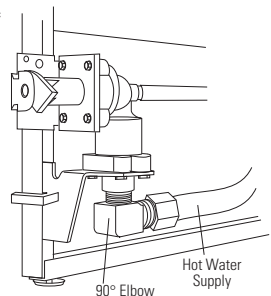

Figure P



INSTALLATION INSTRUCTIONS

Step 12. Connect drain line

Follow all local codes and ordinances.

DRAIN LINE PREPARATION

1. All models are supplied with a pre-attached 78" long corrugated drain hose. The molded end is designed to fit 5/8", 3/4" or 1" diameter connections to the waste tee or disposer. Cut on premarked line as required for your installation as illustrated in Figure Q.

Note: DO NOT CUT CORRUGATED PORTION OF HOSE.

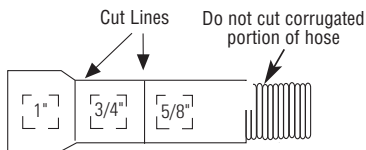

Figure Q

If the location requires a longer drain hose, add up to 42" length to the factory installed hose. Use 5/8" inside diameter hose and thin wall copper coupler to join the hose ends. Secure connection with appropriate clamps (not supplied).

Note: TOTAL DRAIN HOSE LENGTH MUST NOT EXCEED 10 FEET FOR PROPER DRAIN OPERATION.

DRAIN LINE INSTALLATION

Connect drain line to waste tee or disposer as previously outlined in "Prepare Drain Plumbing" section of this manual. Refer to Figure S.

Secure connection using appropriate clamps (not supplied).

Make sure drain hose is not kinked.

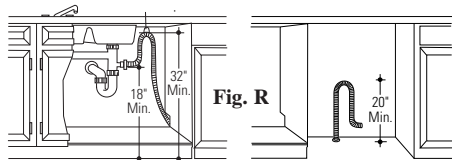

Fig. R

Under the sink connection
Hose may be fastened to
underside of countertop

Installation directly
through the floor

IMPORTANT: TO PREVENT POSSIBLE DRAIN FROM SINK INTO DISHWASHER OR SIPHONING OF DISHWASHER WATER, DRAIN LINE MUST BE ROUTED AS FOLLOWS:

MIN. 30" ABOVE THE FLOOR FOR UNDER THE SINK CONNECTION.

MIN. 20" ABOVE THE FLOOR FOR INSTALLATION DIRECTLY THROUGH THE FLOOR.

Step 13. Connect power supply

Verify that power is turned off at source. If power cord is used, plug it into the wall outlet and go to Step 14.

If dishwasher is to be directly wired to house wiring, continue with this step.

Remove junction box cover.

Secure the power supply cable to the back of the junction box with a strain relief (not supplied). Connect incoming wires to dishwasher wires using wire nuts of appropriate size. Connect incoming white to white wire, black to black wire and incoming ground to green wire as shown in Figure S. **Replace the junction box cover.**



WARNING If house wiring is not 2-wire as shown in Figure S **with a ground wire**, a ground must be provided by the installer.

When house wiring is aluminum, be sure to use UL/CSA. recognized anti-oxidant compound and aluminum-to-copper connectors.



WARNING Check to be sure that wiring is not pinched or in contact with the door springs.

NOTE: Check that harness leads are threaded through small hole in bracket.

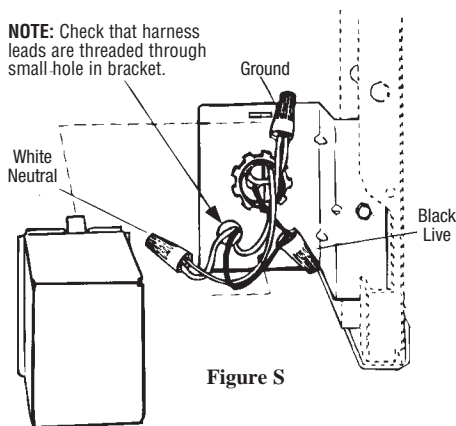

Figure S

INSTALLATION INSTRUCTIONS



Step 14. Pre-test check list

- Check to be sure power is off.
- Open dishwasher door and remove all foam and cardboard packaging.
- Read the Use & Care manual to familiarize yourself with the operation of the dishwasher.
- Add two quarts of water to the bottom of the dishwasher to lubricate the pump seal.
- Remove the protective film if present from the control panel and trim.
- Check to be sure that wiring is secure under the dishwasher. Reattach connections if necessary.
- Pull lower rack about half way out. Check to be sure it does not roll back into dishwasher or further out. If it does, relevel dishwasher.
- Turn on water supply.
- Check for plumbing leaks. Tighten connections if necessary.
- Turn on the hot water faucet at the sink. Verify that temperature is at least 120°F. Adjust the water heater to deliver water between 120° and 150°F if necessary.

Step 15. Dishwasher wet test check list

- Turn on power supply.
- Latch door.
- Select normal cycle on push-button or electronic models.
- On dial models, turn control dial just enough to start dishwasher. Be careful not to turn the dial past the first water fill. On electronic models, push start pad.
- Check to be sure that water enters the dishwasher. This could take up to 4 minutes. If water does not enter the dishwasher, check to be sure that water is turned on.
- Check for leaks under the dishwasher. If a leak is found, turn off power supply, tighten connections and restore power.
- Check for leaks around the door. A leak around the door could be caused by dishwasher door rubbing or hitting against adjacent cabinetry. Reposition the dishwasher if necessary.
- The dishwasher will drain about 5 minutes after the first fill. Check drain lines. If leaks are found, turn off power, correct as necessary and restore power.

- Let the dishwasher run through another fill and drain cycle. Check again to be sure there are no leaks.
- At the end of the second drain, push the reset pad on electronic models. On dial models, unlatch the door and rotate the dial clockwise to the "OFF" position.

Step 16. Replace access panel and toekick

Refer to Figure T. Place the toekick against the legs of the dishwasher. Align the access panel to the dishwasher and tighten the two access panel screws. Align the toekick and make sure the bottom edge is against the floor. Insert and tighten the two toekick attachment screws, making sure the bottom edge of the toekick stays in contact with the floor.

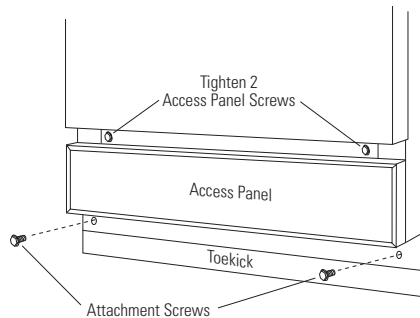

Figure T

Step 17. Literature

- Be sure to leave complete literature package and installation instructions with consumer.



QUESTIONS? USE THIS PROBLEM SOLVER

PROBLEM	POSSIBLE CAUSE
DISHWASHER WON'T RUN	A fuse in your home may be blown, or the circuit breaker tripped. Replace a fuse or reset circuit breaker. Remove any other appliances from the circuit.
UNUSUAL NOISE	Utensils may not be secure on rack pins, or something small may have dropped from the rack. Water is causing utensils to rattle. Make sure everything is securely placed in dishwasher.
DISHES DON'T DRY	Make sure inlet water temperature is correct. (See How to Test Water Temperature section.) Unload the bottom rack first. Water from dishes in the top rack may be spilling into the bottom rack. Check for improper loading. Dishes shouldn't nest together. Avoid overloading. Check the rinse agent dispenser to see that it's not empty.
UNCLEAN DISHES AND FLATWARE	Check inlet water temperature. It should be 49°C (120°F). (To test, see How to Test Water Temperature section.) Water pressure may be temporarily low. Turn on a faucet. Is water coming out slower than usual? If so, wait until pressure is normal before using your dishwasher. Improper rack loading. (See Loading section.) Rising Wash Tower blocked. (See Loading Section.)
DETERGENT LEFT IN DISPENSER CUPS	Water may not be reaching the detergent cups. Move dishes that may be blocking detergent cup. The dispenser cover may not be opening or may be blocked by improperly loaded items. If you used a powder detergent, open the cup and remove any caked-on detergent. If the cup still doesn't open automatically, call for service. Detergent may be old. If the powder detergent is hard or caked in the box, throw it away. The detergent may not be working well. Try Cascade Gel.
DETERGENT CUP LID WON'T LATCH AFTER ADDING DETERGENT	Cycle Indicator Dial must be OFF for cup lid to close and latch properly. If you unlatch the door and open it to dry your dishes, the Cycle Indicator Dial does not advance by itself.
YELLOW OR BROWN FILM	An overall yellow or brown film on dishes or glassware can be caused by iron deposits in water. A special filter in the water supply line is the only way to correct this problem. Your water softener company can tell you about the filter. Yellow film on sterling silver results when you wash copper utensils in the same load. Silver polish will usually remove this stain.
CYCLE AND OPTION INDICATOR LIGHTS STAY ON WHEN CYCLE IS COMPLETED.	This is normal. Unlatch the door to turn off the lights

(continued next page)

QUESTIONS? USE THIS PROBLEM SOLVER



PROBLEM	POSSIBLE CAUSE
SPOTS AND FILMING ON GLASSES AND FLATWARE	<p>Spotting can be caused by all these things:</p> <ul style="list-style-type: none"> • Extremely hard water. (See How to Choose and Use Detergent section.) • Low inlet water temperature. (See How to Test Water Temperature Section.) • Overloading the dishwasher. • Improper loading. (See Loading section.) • Old or damp powder detergent. • Phosphate level in detergent too low. (See How to Choose and Use Detergent section.) • Rinse agent dispenser empty. (See How to Use a Rinse Agent section.) • Too little detergent. (See How to Choose and Use Detergent section.) <p>Local water conditions and personal preferences vary. Try several brands of detergents to find one that gives the best results for you. A liquid dishwasher detergent may help reduce filming.</p> <p>To remove stubborn spots and film from glassware:</p> <ol style="list-style-type: none"> 1. Remove all metal utensils from the dishwasher. 2. Do not add detergent. 3. Select POTSCRUBBER cycle. 4. Start the dishwasher and allow to run for 18 to 22 minutes. The dishwasher will now be in the main wash. 5. Then open the door and pour 2 cups (500 ml) of white vinegar into the bottom of the dishwasher. 6. Close the door and allow to complete the cycle. <p>If vinegar rinse doesn't work: Repeat as above, except use 1/4 cup (60 ml) of citric acid crystals instead of vinegar. (Most drugstores carry citric acid crystals. If yours doesn't, call Service Parts.)</p> <p>Using a vinegar or citric acid crystal rinse more than twice a month? Consider a home water softener.</p>
CLOUDINESS ON GLASSWARE	<p>If vinegar or citric acid crystal rinse doesn't work, the cloudiness is "etching." The film cannot be removed.</p> <p>It can be prevented: Use less detergent if you have soft water. Wash glassware in the shortest cycle that will get them clean. Water temperature entering the dishwasher exceeds 63° C (150° F).</p>
CHIPPING OF CHINA	<p>Rough handling can cause chipping. Load with care. Make sure glassware and china are secure and can't jar loose. (See Loading section.) Make sure tall glasses and stemware will clear the top of the tub when you push the rack into the dishwasher.</p> <p>Always use the top rack for delicate items.</p>
BLACK OR GRAY MARKS ON DISHES	<p>Aluminum utensils often leave marks when they rub against dishes. Remove marks with a mild abrasive cleanser.</p>

(continued next page)



QUESTIONS? USE THIS PROBLEM SOLVER

PROBLEM	POSSIBLE CAUSE
SMALL AMOUNT OF WATER STANDING IN THE BOTTOM OF THE TUB	Water around the outlet on the tub bottom at the back of the tub is normal. It is clean water. It's there to keep the water seal lubricated.
WATER WON'T PUMP OUT OF THE TUB	<p>If the entire bottom of the tub has water, you may have a drain problem. Clean the air gap, if you have one. (See Care and Cleaning section.)</p> <p>Check the kitchen sink. Is it draining well? You may need a plumber.</p> <p>If dishwasher drains into disposer, run disposer to clear. Be sure disposer is not clogged.</p>
DISHWASHER LEAKS	<p>Suds can cause unit to overflow. That's why it's so important to use a detergent that's designed for automatic dishwashers.</p> <p>Spilling the rinse agent can cause foam during washing. This can lead to overflowing. Wipe up accidental spill of rinse agent with a damp cloth.</p>
MOTOR HUMS	<p>Dishwasher has not been used on a regular basis.</p> <p>If you do not use your dishwasher often, set it to fill and pump out once every week. This will help keep the seal moist, and the food disposer clear.</p>
SUDS IN THE TUB	<p>Sudsing detergents are not meant for dishwashers. USE ONLY AUTOMATIC DISHWASHER DETERGENTS TO AVOID SUDSING.</p> <p>To remove suds from the tub: Open the dishwasher. Let suds evaporate. Add 1 gallon of cold water to the tub. Close and latch the dishwasher. Pump out water by slowly turning the control dial until a drain period is reached.</p> <p>Repeat if necessary.</p>
STAINING OF TUB INTERIOR	Some detergents contain colorant (pigment or dyes) that will discolor the tub interior with extended use. Check the detergent cup for signs of any discoloration. If cup is discolored, change to detergent without any colorant.
SOUNDS YOU WILL HEAR	<p>You'll hear occasional clicking sounds. These are normal.</p> <ul style="list-style-type: none">• Food disposal shredding action.• Drain valve opening to pump water out.• Timer control as cycle progresses.• Detergent cup opening. <p>During the drying period:</p> <ul style="list-style-type: none">• The motor stops.
VAPOR AT THE VENT	Water vapor comes through the vent by the door latch during drying and when water is being pumped out.



CAMCO Service Telephone Numbers

QUESTIONS?

If you have any questions concerning your appliance, please write to:

Director, Consumer Relations
CAMCO, Inc.
1 Factory Lane
Suite 310, Moncton, N.B.
E1C 9M3

IN-HOME REPAIR SERVICE

1-800-361-3400

Expert CAMCO repair service is only a phone call away.

SERVICE CONTRACTS

1-800-461-3636

Purchase a CAMCO service contract while your warranty is still in effect and you will receive a substantial discount. CAMCO Consumer Service will still be there after your warranty expires.

PARTS & ACCESSORIES

Individuals qualified to service their own appliances can have parts or accessories sent directly to their homes (VISA, MasterCard cards are accepted)

Instructions contained in this manual cover procedures to be performed by any user. Other servicing generally should be referred to a qualified service personnel. Caution must be exercised, since improper servicing may cause unsafe operation.

Please consult your yellow pages for your local Camco number.

SERVICE SATISFACTION

If you are not satisfied with the service you received:

First, contact the people who serviced your appliance.

Next, if you are still not pleased, write all the details (including your phone number) to:

Director, Consumer Relations,
1 Factory Lane
Suite 310, Moncton, N.B.
E1C 9M3



PREPARE ENCLOSURE FOR AN UNDERSINK DISHWASHER

WARNING

TO REDUCE THE RISK OF ELECTRIC SHOCK, FIRE OR INJURY TO PERSONS, THE INSTALLER MUST ENSURE THAT THE DISHWASHER IS COMPLETELY ENCLOSED AT THE TIME OF INSTALLATION.

- The touch cabinet opening must have a minimum width of 24", and a minimum of 34" high from floor to underside of the countertop.
- This dishwasher is designed to fit under a special sink bowl (either double or single) with a depth of 6" or less in a 1-1/2" countertop.
- Water line to sink faucet and drain from sink can be run through Area "A".
- Hot water line to dishwasher is installed in Area "B".
- Garbage disposer is installed in Area "C".

(To continue installation go to page 16)

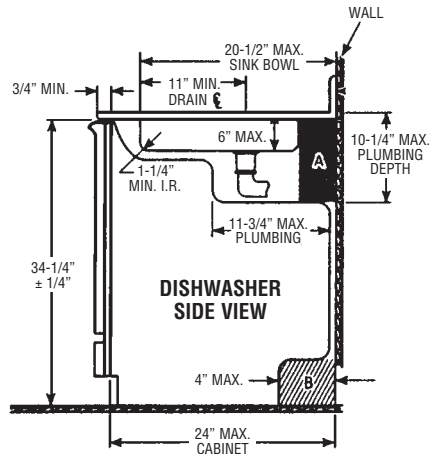
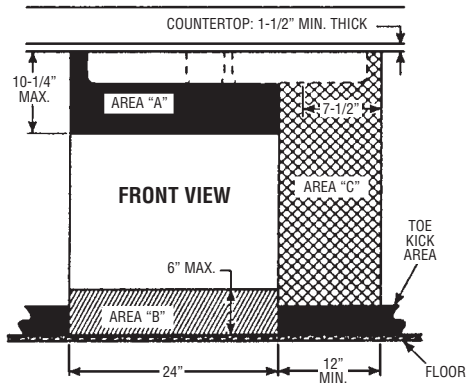

Free Manuals Download Website

<http://myh66.com>

<http://usermanuals.us>

<http://www.somanuals.com>

<http://www.4manuals.cc>

<http://www.manual-lib.com>

<http://www.404manual.com>

<http://www.luxmanual.com>

<http://aubethermostatmanual.com>

Golf course search by state

<http://golfingnear.com>

Email search by domain

<http://emailbydomain.com>

Auto manuals search

<http://auto.somanuals.com>

TV manuals search

<http://tv.somanuals.com>