



Dishwashers

Safety Instructions 2, 3

Operating Instructions

Care and Cleaning9

Control Panels4

Control Settings 5

Dial Cycles6

Loading the Dishwasher Racks . .8, 9

Optional Accessories10

Using the Dishwasher7, 8

Troubleshooting Tips 11, 12

Consumer Support

Consumer Support Back Cover

Product Registration 13, 14

Warranty 15

Owner's Manual

EDW1500J Series

GSD3200J Series

GSD4000J Series

GSD4100J Series

GSD4200J Series

SSD3900J Series

Write the model and serial numbers here:

Model # _____

Serial # _____

You can find them on a label on the tub wall just inside the door.



IMPORTANT SAFETY INFORMATION. READ ALL INSTRUCTIONS BEFORE USING.

⚠ WARNING!

For your safety, the information in this manual must be followed to minimize the risk of fire or explosion, electric shock, or to prevent property damage, personal injury, or death.



WATER HEATER SAFETY

*Under certain conditions, hydrogen gas may be produced in a water heater that has not been used for two weeks or more. **HYDROGEN GAS IS EXPLOSIVE.***

If the hot water has not been used for two weeks or more, prevent the possibility of damage or injury by turning on all hot water faucets and allow them to run for several minutes. Do this before using any electrical appliance which is connected to the hot water system. This simple procedure will allow any built-up hydrogen gas to escape. Since the gas is flammable, do not smoke or use an open flame or appliance during this process.

Use this appliance only for its intended purpose as described in this Owner's Manual.



PROPER INSTALLATION AND MAINTENANCE

This dishwasher must be properly installed and located in accordance with the Installation Instructions before it is used. If you did not receive an Installation Instructions sheet with your dishwasher, you can receive one by visiting our website at GEAppliances.com.

- Connect to a grounded metal, permanent wiring system; or run an equipment-grounding conductor with the circuit conductors and connect to the equipment-grounding terminal or lead of the appliance.
- Improper connection of the equipment-grounding conductor can result in a risk of electric shock. Check with a qualified electrician or service representative if you are in doubt whether the appliance is properly grounded.
- Use supply conductors rated at least 75°C (167°F).
- Dispose of discarded appliances and shipping or packing material properly.
- Do not attempt to repair or replace any part of your dishwasher unless it is specifically recommended in this manual. All other servicing should be referred to a qualified technician.
- To minimize the possibility of electric shock, disconnect this appliance from the power supply before attempting any maintenance. **NOTE:** Turning the dishwasher off does not disconnect the appliance from the power supply. We recommend having a qualified technician service your appliance.

⚠ WARNING!

DO NOT...



- Do not tamper with controls.
- Do not abuse, sit on or stand on the door or dish rack of the dishwasher.
- Do not discard a dishwasher without first removing the door of the washing compartment.
- Do not store or use combustible materials, gasoline or other flammable vapors and liquids in the vicinity of this or any other appliance.
- Do not allow children to play around dishwasher when opening or closing door due to the possibility of small fingers being pinched in door.
- Do not allow children to play with, on or around this appliance or any discarded appliance.

⚠ **WARNING! RISK OF CHILD ENTRAPMENT**

PROPER DISPOSAL OF THE DISHWASHER

Junked or abandoned dishwashers are dangerous...even if they will sit for "just a few days." If you are getting rid of your old dishwasher, please follow the instructions below to help prevent accidents.

Before You Throw Away Your Old Dishwasher:

- Take off the door of the washing compartment or remove the door latch keeper (as shown).

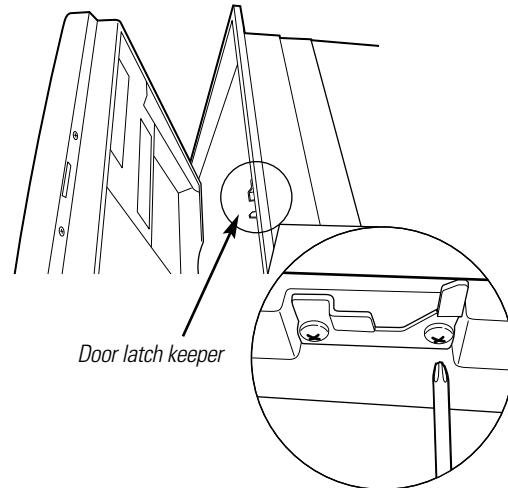

WHEN USING YOUR DISHWASHER

- Use only powder, tabs, liquid detergents or rinse agents recommended for use in a dishwasher and keep them out of the reach of children. **Cascade®**, **Cascade Complete®** and **Electrasol®** Automatic Dishwashing Detergents, and **Jet-Dry®** rinse agent have been approved for use in all GE dishwashers.
- Locate sharp items so that they are not likely to damage the door seal.
- Load sharp knives with the handles up to reduce the risk of cut-type injuries.
- Using a detergent that is not specifically designed for dishwashers will cause the dishwasher to fill with suds.
- Do not wash plastic items unless marked *dishwasher safe* or the equivalent. For plastic items not so marked, check the manufacturer's recommendations.
- Non-Dishware Items: Do not wash items such as electronic air cleaner filters, furnace filters and paint brushes in your dishwasher. Damage to dishwasher and discoloration or staining of dishwasher may result.
- Do not touch the heating element during or immediately after use.
- Do not operate your dishwasher unless all enclosure panels are properly in place.
- Close supervision is necessary if this appliance is used by or near children.
- Load light, plastic items so they will not become dislodged and drop to the bottom of the dishwasher—they might come into contact with the heating element and be damaged.

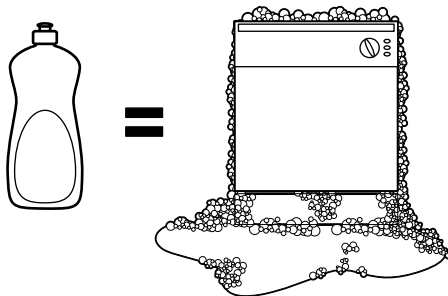

READ AND FOLLOW THIS SAFETY INFORMATION CAREFULLY.
SAVE THESE INSTRUCTIONS

About the dishwasher control panel.

You can locate your model number on the tub wall just inside the door. Throughout this manual, features and appearance may vary from your model.

Model GSD3200J Series

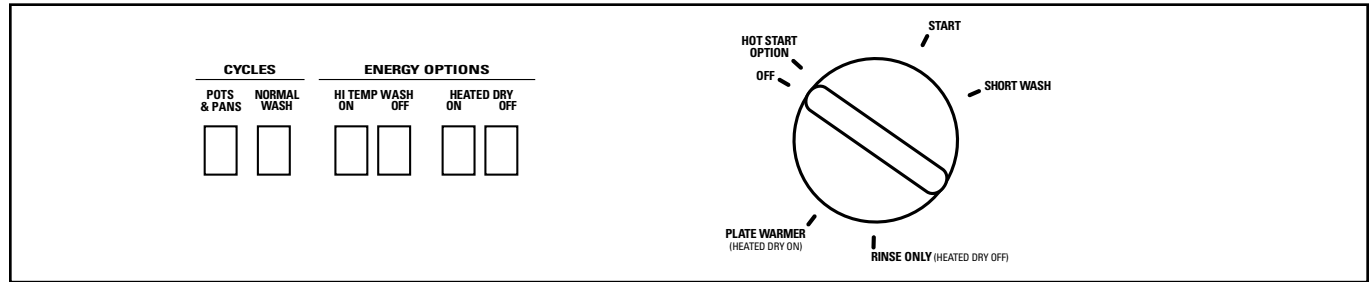

Models EDW1500J Series, GSD4000J Series and SSD3900J Series

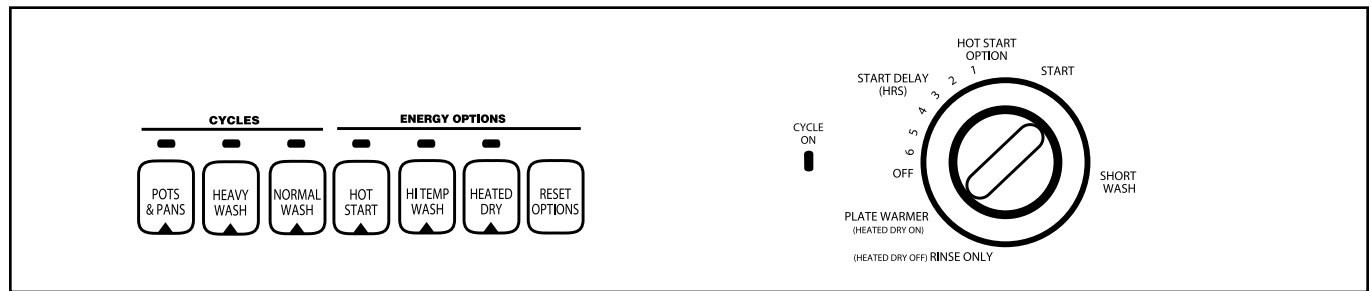

Models GSD4100J Series and GSD4200J Series

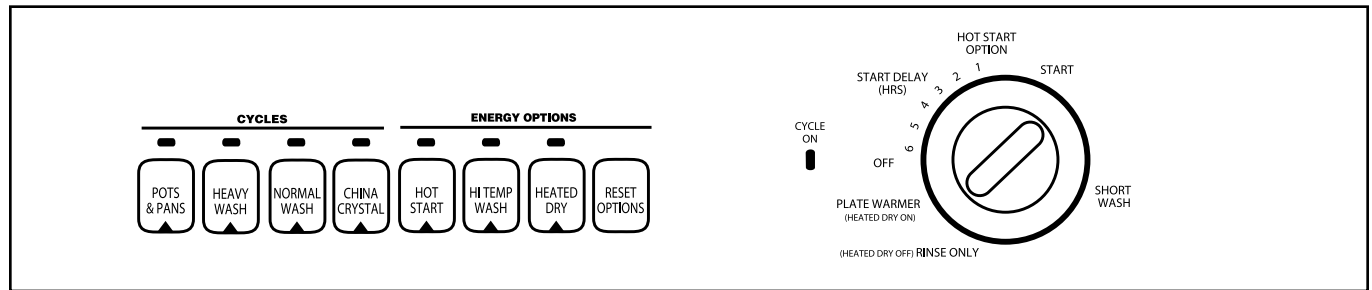

Control Settings

1 Cycles

POTS & PANS/ HEAVY WASH For heavily soiled dishes or cookware with dried-on or baked-on soils. Everyday dishes may be included. This cycle will not remove burned-on foods.

NORMAL WASH For loads of everyday dishes, glasses and cookware with medium soils. **NOTE:** Many dishes have lighter soil than normal. Choosing a cycle other than **NORMAL WASH** will save energy and water.

SHORT WASH For quickly washing loads of everyday dishes with medium soils that have not dried on, such as loads consisting mostly of glasses.

RINSE ONLY For rinsing partial loads that will be washed later. *Do not use detergent.*

PLATE WARMER For warming clean dishes and serving plates. This cycle will take approximately 30 minutes.

HOT START Preheats wash water to the correct temperature.

2 Energy Options

HI TEMP WASH (ON) Provides extra heat for best performance. It is used best with heavily soiled dishes.

HI TEMP WASH OFF Turns **HI TEMP WASH** off. *(on some models)*

HEATED DRY (ON) Turns the heating element on for fast drying. This option will extend the time of your wash cycle. Available on all wash cycles except **RINSE ONLY**. Adds approx. 32 minutes to the cycle.

HEATED DRY OFF Turns **HEATED DRY** off. Dishes air dry naturally and energy is saved. *(on some models)*

3 Start

Slowly turn the Dial to the **START** or **ON** position, or the selected cycle. Don't turn it past the **START, ON** or cycle position, or you could accidentally miss a rinse.

There is a time delay between start-up and water fill so you will not hear any wash action right away.

■ Latch the door to begin the cycle.

Cycle Chart

Model	Cycle	Water Usage (gal.)	Cycle Time (min.)
GSD3200J Series	Hot Start Option ¹	3.4	26
	Pots & Pans	10.9	61
	Normal Wash*	6.8	61
	Short Wash*	6.2	48
	Rinse Only*	4.5	13
	Drying/Plate Warmer	0.0	30
EDW1500J Series	Hot Start Option ¹	1.7	33
GSD4000J Series	Pots & Pans	10.9	71
GSD4100J Series	Heavy Wash	9.3	71
GSD4200J Series	Normal Wash*	6.8	71
SSD3900J Series	China/Crystal	9.3	71
	Short Wash*	6.2	58
	Rinse Only*/Rinse & Hold*	3.0	13
	Drying/Plate Warmer	0.0	30
* Normal Wash should be selected to run this cycle.			
¹ Hot Start Option adds water amount and cycle time shown when selected.			
Note: Not all models have every cycle listed.			

About the dial cycles.

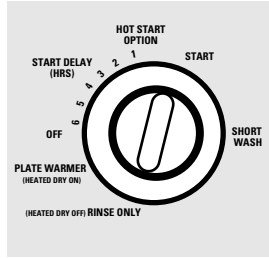

Rinse Only

For rinsing partial loads that will be washed later. *Do not use detergent.*

- 1 Make sure **HEATED DRY** is not selected.
- 2 Be sure the door is unlatched.
- 3 Slowly turn the Dial to **RINSE ONLY**.
- 4 Latch the door to start the cycle.

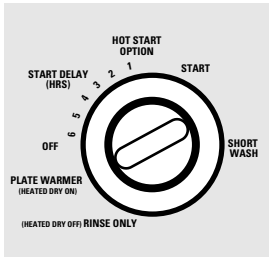
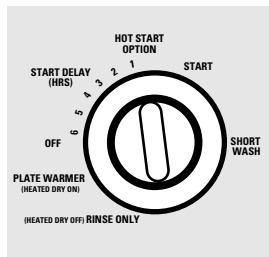

Plate Warmer

For warming clean dishes and serving plates. This cycle will take approximately 32 minutes.

- 1 Load clean dishware to be warmed.
- 2 Select **HEATED DRY ON**.
- 3 Be sure the door is unlatched.
- 4 Slowly turn the Dial to **PLATE WARMER**.
- 5 Latch the door to start the cycle.



Hot Start

Preheats wash water to the correct temperature.

- 1 Select the **HOT START** cycle and any other option.
- 2 Be sure the door is unlatched.
- 3 Slowly turn the Dial to **HOT START**.
- 4 Latch the door to start the cycle.

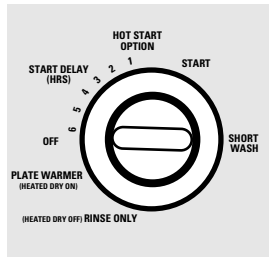

Short Wash

For quickly washing loads of everyday dishes with light to medium soils that have not dried on.

- 1 Select the **NORMAL WASH** cycle and any options.
- 2 Be sure the door is unlatched.
- 3 Slowly turn the Dial to **SHORT WASH**.
- 4 Latch the door to start the cycle.

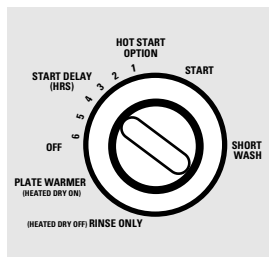

Start Delay

The **START DELAY** will allow you to delay the start time of any cycle not on the Dial automatically for up to either 5 or 6 hours (depending on model).

- 1 Be sure the door is unlatched.
- 2 Select the wash cycle and option you want.
- 3 Slowly turn the Dial to the desired time. The **CYCLE ON** light will come on.
- 4 Latch the door to start the cycle.



Check the Water Temperature

The entering water must be at least 120°F and not more than 150°F, for effective cleaning and to prevent dish damage. Check the water temperature with a candy or meat thermometer. Turn on the

hot water faucet nearest the dishwasher, place the thermometer in a glass and let the water run continuously into the glass until the temperature stops rising.



Use Jet-Dry® or Cascade Rinse Aid® Rinse Agent

Jet-Dry® or Cascade Rinse Aid® rinse agent removes spots and prevents new film buildup on your dishes, glasses, flatware, cookware and plastic.

Filling the Dispenser

Fill the rinse agent dispenser until it reaches the bottom of lip inside the opening. Replace cap.

To check if rinse agent is needed, remove the cap and look into the dispenser.

A full dispenser should last about one month.

If rinse agent spills, wipe up the excess.

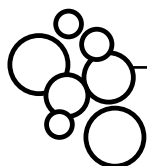
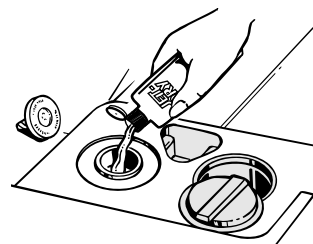

Proper Use of Detergent

Use only detergent specifically made for use in dishwashers. **Cascade®, Cascade® Complete** and **Electrasol®** Automatic Dishwashing Detergents have been approved for use in all GE dishwashers. Keep your detergent fresh and dry. Don't put powder detergent into the dispenser until you're ready to wash dishes.

The amount of detergent to use depends on whether your water is *hard* or *soft*. With hard water, you need extra detergent. With soft water, you need less detergent.

Protect your dishes and dishwasher by contacting your water department and asking how hard your water is. Twelve or more grains is extremely hard water. A water softener is recommended. Without it, lime can build up in the water valve, which could stick while open and cause flooding. Too much detergent with soft water can cause a permanent cloudiness of glassware, called *etching*.

You'll find two detergent dispensers on the inside door of your dishwasher. All wash cycles require detergent in the main cup. Wash cycles with two washes will also use the open cup. When using automatic dishwashing detergent tabs, simply place one tab in the main cup and close.

Be sure the Dial is **OFF** before adding detergent. Otherwise, the detergent cup will not close and latch properly. Add detergent then close the main cup.

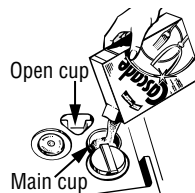

NOTE: To open detergent cup after it has been closed, simply turn the detergent cup handle counterclockwise until it releases. A snapping sound may be heard.

DO NOT USE HAND DISH DETERGENT

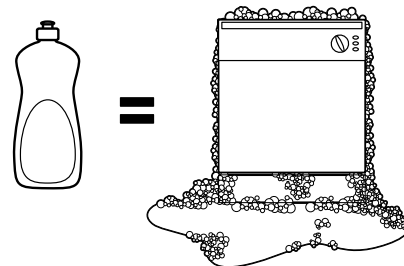

NOTE: Using a detergent that is not specifically designed for dishwashers will cause the dishwasher to fill with suds. During operation, these suds will spill out of the dishwasher vents, covering the kitchen floor and making the floor wet.

Because so many detergent containers look alike, store the dishwasher detergent in a separate space from all other cleaners. Show anyone who may use the dishwasher the correct detergent and where it is stored.

While there will be no lasting damage to the dishwasher, your dishes will not get clean using a dishwashing detergent that is not formulated to work with dishwashers.

Using the dishwasher.



Forget to Add a Dish?

A forgotten dish can be added any time before the main wash.

- 1 Push the door latch to the left.
- 2 Once the water calms, open the door. Steam may rise out of the dishwasher.
- 3 Add forgotten dishes.
- 4 Close the door and push the latch to the far right.

Loading the dishwasher racks.

For best dishwashing results, follow these loading guidelines. Features and appearance of racks and silverware baskets may vary from your model.

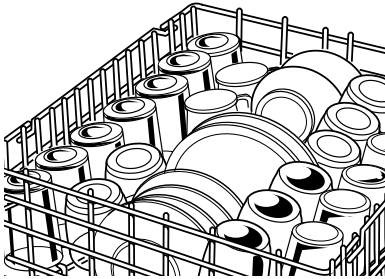

Upper Rack

The upper rack is for glasses, cups and saucers. Cups and glasses fit best along the sides. This is also a secure place for dishwasher-safe plastics. The upper rack is good for all kinds of odd-shaped utensils. Saucepans, mixing bowls and other items should be placed face down.

The *cup shelf* (on some models) may be placed in the up or down position to add flexibility.

Secure larger dishwasher-safe plastics over two fingers when possible.

Make sure small plastic items are secure so they can't fall onto the heating element.

Check to make sure that tall items will not block the rotation of the top wash arm.

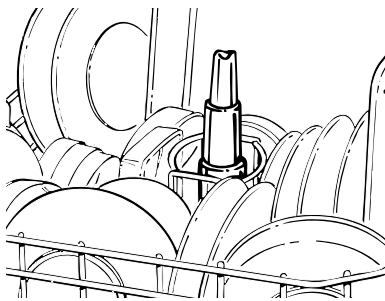

The Wash Tower

Keep the center area clear in the lower rack.

The wash tower rises through the center of the lower rack during the wash and rinse portions of the cycle.

Don't block or load tall things next to the Wash Tower.

Also, be careful not to let a portion of an item such as a pot or dish handle extend through the bottom rack. This could block the wash arm and cause poor washing results.

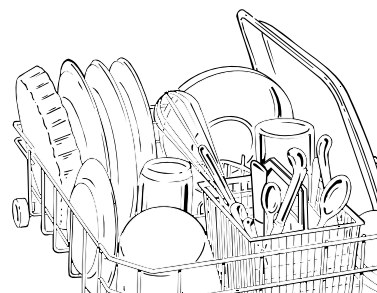

Lower Rack

When loading the lower rack, do not load large platters or trays in the front right corner. They may prevent detergent from circulating during the wash cycle.

The lower rack is best used for plates, saucers and cookware. Large items such as broiler pans and racks should go along the sides. Load platters, pots and bowls along the sides, in corners or in the back. The soiled side of items should face the center of the rack.

Silverware Basket

Put flatware in the removable basket with fork and knife handles up to protect your hands. Place spoons in the basket with handles down. Mix knives, forks and spoons so they don't nest together. Distribute evenly. Small plastic items, such as measuring spoons and lids from small containers, should go in the bottom of the silverware basket with silverware on top.

To increase the flexibility of the lower rack, the silverware basket may be split (on some models). Grasp the basket at opposite corners and slide apart. The basket sections should be placed in the lower rack by hanging them on the top hoop.

A cover can be lowered to either side of the split basket to secure lightweight items from the effects of the vigorous wash action.



Single basket
(on some models)



Split basket
(on some models)



The accessory basket (on some models) can hold small items such as: baby bottle nipples, plastic lids, corn cob holders, etc. It can hang from the top hoop of the upper rack along the right side or it can also hang on the right or left side of the lower rack. When hanging the accessory basket on the right side in the upper rack, make sure the top is closed and nothing is sticking out.

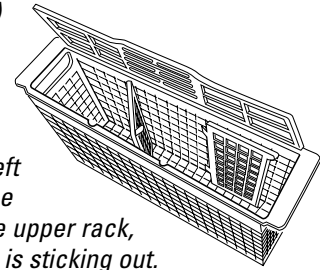

Caring for the dishwasher.

To clean the control panel, use a lightly dampened cloth then dry thoroughly. To clean the exterior use a good appliance polish.

Never use sharp objects, scouring pads or harsh cleaners on any part of the dishwasher.

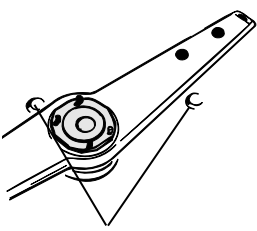

Sump cover screws

Protect Against Freezing

If your dishwasher is left in an unheated place during the winter, ask a service technician to:

- 1 Cut off electrical power to the dishwasher. Remove fuses or trip circuit breaker.
- 2 Turn off the water supply and disconnect the water inlet line from the water valve.
- 3 Drain water from the inlet line and water valve. (Use a pan to catch the water.)
- 4 Reconnect the water inlet line to the water valve.
- 5 Remove the plastic sump cover in the tub bottom and use a sponge to soak up water in the rubber boot.

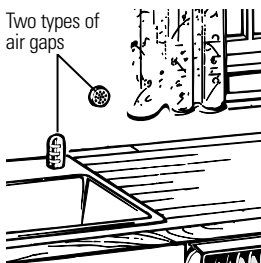

Check the air gap any time your dishwasher isn't draining well.

Does Your Dishwasher Have an Air Gap?

An air gap protects your dishwasher against water backing up into it if a drain clogs. The air gap is not a part of the dishwasher. It is not covered by your warranty. Not all plumbing codes require air gaps, so you may not have one.

The air gap is easy to clean.

- 1 Turn off the dishwasher and lift off the chrome cover.
- 2 Unscrew the plastic cap and clean with a toothpick.

Caring for the dishwasher.

Stainless Steel Panels

The stainless steel panels can be cleaned with **CERAMA BRYTE**® Stainless Steel Appliance Cleaner or a similar product using a clean, soft cloth.

You can order **CERAMA BRYTE**® Stainless Steel Appliance Cleaner through GE Parts by Calling 800.626.2002.

About optional accessories.

You can change the door and lower access panel appearance of your dishwasher by ordering one of these optional accessories:

- 1/4" Wood Panel Trim Kit
- 3/4" Trimless Wood Panel Kit

These accessories are available at extra cost (VISA, MasterCard or Discover cards accepted) by calling 800.626.2002.

Specify accessory number when ordering.



Descriptions of Optional Accessories

Wood panel trim kit—This accessory contains *trim and instructions* for you to supply and install a 1/4" thick decorative wood door and lower access panel. For models:

GSD3200J Series

- GPF325B (Black)
- GPF325C (Bisque)
- GPF325W (White)

EDW1500J Series, GSD4000J Series, GSD4100J Series, GSD4200J Series and SSD3900J Series

- GPF425B (Black)
- GPF425C (Bisque)
- GPF425W (White)

NOTE: The GPF100 dishwasher door spring kit must also be ordered and installed *when the door panel weighs 4 lbs. or more.*

Trimless wood panel kit—This accessory contains *parts and instructions* for you to supply and install a 3/4" thick decorative wood door and lower access panel. For models:

GSD3200J Series

- GPF375

EDW1500J Series, GSD4000J Series, GSD4100J Series, GSD4200J Series and SSD3900J Series

- GPF475

NOTE: The GPF100 dishwasher door spring kit will be included with the *trimless panel kit* and must be installed with it.

About rack accessories.

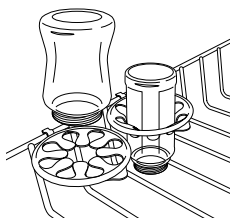

For best results, the Baby Bottle Holder should be installed on the upper rack of the dishwasher.

Baby Bottle Holder Part Number: WX69X200

- Prevents movement of baby bottles during the dishwasher cycle
- Snaps easily onto any dishwasher upper rack
- Eliminates hand washing
- Fits all baby bottles

You can order a package of 5 Baby Bottle Holders, at extra cost, by calling 800.626.2002, or through the Internet at GEAppliances.com (Visa, MasterCard or Discover cards accepted).

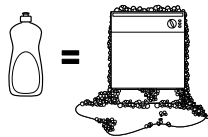

Troubleshooting Tips
Save time and money! Review the charts on the following pages, or visit **GEAppliances.com**. You may not need to call for service.

Problem	Possible Causes	What To Do
Dishwasher won't run	Fuse is blown, or the circuit breaker tripped	<ul style="list-style-type: none"> • Replace fuse or reset circuit breaker. Remove any other appliances from the circuit.
Noise	Some of the sounds you'll hear are normal	<ul style="list-style-type: none"> • Soft food disposal shredding action. • Drain valve opening to pump water out. • Timer control as cycle progresses. • Detergent cup opening. • The motor stopping during the drying period.
	Utensils are not secure in the rack or something small has dropped into the rack	<ul style="list-style-type: none"> • Make sure everything is secured in dishwasher.
	Motor hums	<ul style="list-style-type: none"> • Dishwasher has not been used on a regular basis. If you do not use your dishwasher often, set it to fill and pump out once every week. This will help keep the seal moist and the garbage disposer clear.
Water standing in the bottom of the tub	This is normal	<ul style="list-style-type: none"> • A small amount of clean water around the outlet on the tub bottom at the back of the tub keeps the water seal lubricated.
Water won't pump out of the tub	Drain is clogged	<ul style="list-style-type: none"> • If you have an air gap, clean it. • Check to see if your kitchen sink is draining well. If not, you may need a plumber. • If the dishwasher drains into a disposer, run disposer clear.
Suds in the tub	Correct detergent wasn't used	<ul style="list-style-type: none"> • Use only automatic dishwasher detergents to avoid sudsing. Cascade®, Cascade® Complete and Electrasol® Automatic Dishwashing Detergents have been approved for use in all GE dishwashers. • To remove suds from the tub, open the dishwasher and let suds evaporate. Add 1 gallon of cold water to the tub. Close and latch the dishwasher. Pump out water by slowly turning the Dial until a drain period is reached. Repeat if necessary.
	 Rinse agent was spilled	<ul style="list-style-type: none"> • Always wipe up rinse agent spills immediately.
Stained tub interior	Detergent with colorant was used	<ul style="list-style-type: none"> • Some detergents contain colorant (pigment or dyes) that will discolor the tub interior with extended use. Check the detergent cup for signs of any discoloration. If cup is discolored, change to detergent without any colorant. Cascade®, Cascade® Complete and Electrasol® Automatic Dishwashing Detergents have been approved for use in all GE dishwashers.
	Some tomato-based foods can stain	<ul style="list-style-type: none"> • Use of the RINSE ONLY cycle (on some models) after adding the dish to the load can decrease the level of staining. GE recommends Cascade® Plastic Booster™ to help remove these types of stains.
Dishes don't dry	Low inlet water temperature	<ul style="list-style-type: none"> • Make sure inlet water temperature is correct.
	Rinse agent dispenser is empty	<ul style="list-style-type: none"> • Check the rinse agent dispenser.
Steam	This is normal	<ul style="list-style-type: none"> • Steam comes through the vent by the door latch during drying and when water is being pumped out.
Black or gray marks on dishes	Aluminum utensils have rubbed against dishes	<ul style="list-style-type: none"> • Remove marks with a mild, abrasive cleaner.

Before you call for service...

Safety Instructions

Problem	Possible Causes	What To Do
Dishes and flatware not clean	Inlet water temperature is below 120°F	<ul style="list-style-type: none"> • Raise the water heater temperature to 120°F. • Use the HOT START feature.
	Water pressure is temporarily low	<ul style="list-style-type: none"> • Turn on a faucet. Is water coming out more slowly than usual? If so, wait until pressure is normal before using your dishwasher.
	Air gap is clogged	<ul style="list-style-type: none"> • Clean the air gap.
	Improper rack loading	<ul style="list-style-type: none"> • Make sure large dishware does not block the detergent dispenser or the wash arm.

Operating Instructions

Spots and filming on glasses and flatware	Extremely hard water	<ul style="list-style-type: none"> • Use Jet-Dry® or Cascade Rinse Aid® rinse agent to remove spots and prevent new film buildup.
	Low inlet water temperature	<ul style="list-style-type: none"> • To remove stubborn spots and pre-existing film from glassware: <ol style="list-style-type: none"> 1 Remove all metal utensils from the dishwasher. 2 Do not add detergent. 3 Select the longest cycle. 4 Start the dishwasher and allow to run for 18 to 22 minutes. Dishwasher will now be in the main wash. 5 Open the door and pour 2 cups (500 ml) of white vinegar into the bottom of the dishwasher. 6 Close the door and allow to complete the cycle. If vinegar rinse doesn't work: Repeat as above, except use 1/4 cup (60 ml) of citric acid crystals instead of vinegar.
	Overloading the dishwasher	
	Improper loading	
	Old or damp powder detergent	
	Rinse agent dispenser empty	
Too little detergent		
Cloudiness on glassware	Combination of soft water and too much detergent	<ul style="list-style-type: none"> • This is called <i>etching</i> and is permanent. To prevent this from happening, use less detergent if you have soft water. Wash glassware in the shortest cycle that will get them clean.
	Water temperature entering the dishwasher exceeds 150°F	<ul style="list-style-type: none"> • Lower the water heater temperature.

Troubleshooting Tips

Yellow or brown film on tub	Tea or coffee stains	<ul style="list-style-type: none"> • Remove the stain by hand, using a solution of 1/2 cup bleach and 3 cups warm water. <p>▲ WARNING Before cleaning interior, wait at least 20 minutes after a cycle for the heating element to cool down. Failure to do so can result in burns.</p>
	An overall yellow or brown film can be caused by iron deposits in water	<ul style="list-style-type: none"> • A special filter in the water supply line is the only way to correct this problem. Contact a water softener company.

Consumer Support

White film on inside surfaces	Hard water minerals	<ul style="list-style-type: none"> • GE recommends Jet-Dry® or Cascade Rinse Aid® to help remove some hard water mineral stains. <p>• For extreme staining, clean the interior by applying automatic dishwashing detergent to a damp sponge. Wear rubber gloves. Do not use any type of cleanser other than those recommended or hand dishwashing detergent because it may cause foaming or sudsing. Cascade®, Cascade Complete® and Electrasol® Dishwashing Detergents have been approved for use in all GE dishwashers.</p>
Detergent cup lid won't latch	Dial is not in the OFF position	<ul style="list-style-type: none"> • Turn the Dial to OFF and slide the door latch to the left.
Detergent left in dispenser cups	Dishes are blocking the detergent cups	<ul style="list-style-type: none"> • Reposition the dishes.

GE Service Protection Plus™

GE, a name recognized worldwide for quality and dependability, offers you Service Protection Plus™—comprehensive protection on all your appliances—**No Matter What Brand!**

Benefits Include:

- Backed by GE
- All brands covered
- Unlimited service calls
- All parts and labor costs included
- No out-of-pocket expenses
- No hidden deductibles
- One 800 number to call

***We'll Cover Any Appliance.
Anywhere. Anytime.****

You will be completely satisfied with our service protection or you may request your money back on the remaining value of your contract. No questions asked. It's that simple.

Protect your refrigerator, dishwasher, washer and dryer, range, TV, VCR and much more—**any brand!** Plus there's no extra charge for emergency service and low monthly financing is available. Even icemaker coverage and food spoilage protection is offered. You can rest easy, knowing that all your valuable household products are protected against expensive repairs.

Place your confidence in GE and call us in the U.S. toll-free at **800.626.2224** for more information.

*All brands covered, up to 20 years old, in the continental U.S.

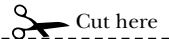

Please place in envelope and mail to:

General Electric Company
Warranty Registration Department
P.O. Box 32150
Louisville, KY 40232-2150

Consumer Product Ownership Registration

Dear Customer:

Thank you for purchasing our product and thank you for placing your confidence in us.

We are proud to have you as a customer!

Follow these three steps to protect your new appliance investment:

1

Complete and mail your Consumer Product Ownership Registration today. Have the peace of mind of knowing we can contact you in the unlikely event of a safety modification.

2

After mailing the registration below, store this document in a safe place. It contains information you will need should you require service. Our service number is 800.GE.CARES (800.432.2737).

3

Read your Owner's Manual carefully. It will help you operate your new appliance properly.

Model Number

Serial Number

Important: If you did not get a registration card with your product, detach and return the form below to ensure that your product is registered, or register online at GEAppliances.com.

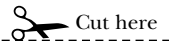

Consumer Product Ownership Registration



Model Number

Serial Number

Mr. Ms. Mrs. Miss

First Name

Last Name

Street Address

Apt. #

E-mail Address*

City

State

Zip Code

Date Placed In Use
Month

Day

Year

Phone Number --



GE Appliances

GE Consumer Products
General Electric Company
Louisville, Kentucky
www.GEAppliances.com

* Please provide your e-mail address to receive, via e-mail, discounts, special offers and other important communications from GE Appliances (GEA).

Check here if you do not want to receive communications from GEA's carefully selected partners.

FAILURE TO COMPLETE AND RETURN THIS CARD DOES NOT DIMINISH YOUR WARRANTY RIGHTS.

For information about GEA's privacy and data usage policy, go to www.GEAppliances.com and click on "Privacy Policy" or call 800.626.2224.

GE Dishwasher Warranty.



All warranty service provided by our Factory Service Centers, or an authorized Customer Care® technician. To schedule service, on-line, 24 hours a day, visit us at GEAppliances.com, or call 800.GE.CARES (800.432.2737).

Staple your receipt here.
Proof of the original purchase date is needed to obtain service under the warranty.

For The Period Of: GE Will Replace:

One Year From the date of the original purchase	Any part of the dishwasher which fails due to a defect in materials or workmanship. During this full one-year warranty , GE will also provide, free of charge , all labor and in-home service to replace the defective part.
Second Year From the date of the original purchase	Any part of the Water Distribution System which fails due to a defect in materials or workmanship. Associated inlet and drain plumbing parts are not covered by this warranty. During this second-year limited warranty , you will be responsible for any labor or in-home service costs.
Ten Years From the date of the original purchase	The PermaTuf® tub or door liner , if it fails to contain water due to a defect in materials or workmanship. During this full warranty , GE will also provide, free of charge , all labor and in-home service to replace the defective part.

What Is Not Covered:

- Service trips to your home to teach you how to use the product.
- Improper installation, delivery or maintenance.
- Failure of the product if it is abused, misused, or used for other than the intended purpose or used commercially.
- Replacement of house fuses or resetting of circuit breakers.
- Damage to the product caused by accident, fire, floods or acts of God.
- Incidental or consequential damage caused by possible defects with this appliance.
- Cleaning or servicing of the air gap device in the drain line.
- Damage caused after delivery.

This warranty is extended to the original purchaser and any succeeding owner for products purchased for home use within the USA. In Alaska, the warranty excludes the cost of shipping or service calls to your home.

Some states do not allow the exclusion or limitation of incidental or consequential damages. This warranty gives you specific legal rights, and you may also have other rights which vary from state to state. To know what your legal rights are, consult your local or state consumer affairs office or your state's Attorney General.

Warrantor: General Electric Company. Louisville, KY 40225

Consumer Support.



GE Appliances Website

GEAppliances.com

Have a question or need assistance with your appliance? Try the GE Appliances Website 24 hours a day, any day of the year! For greater convenience and faster service, you can now download Owner's Manuals, order parts, catalogs, or even schedule service on-line. You can also "Ask Our Team of Experts™" your questions, and so much more...

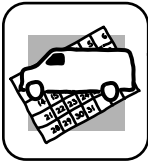

Schedule Service

GEAppliances.com

Expert GE repair service is only one step away from your door. Get on-line and schedule your service at your convenience 24 hours any day of the year! Or call 800.GE.CARES (800.432.2737) during normal business hours.



Real Life Design Studio

GEAppliances.com

GE supports the Universal Design concept—products, services and environments that can be used by people of all ages, sizes and capabilities. We recognize the need to design for a wide range of physical and mental abilities and impairments. For details of GE's Universal Design applications, including kitchen design ideas for people with disabilities, check out our Website today. For the hearing impaired, please call 800.TDD.GEAC (800.833.4322).



Extended Warranties

GEAppliances.com

Purchase a GE extended warranty and learn about special discounts that are available while your warranty is still in effect. You can purchase it on-line anytime, or call 800.626.2224 during normal business hours. GE Consumer Home Services will still be there after your warranty expires.

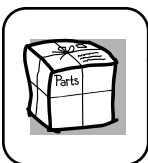

Parts and Accessories

GEAppliances.com

Individuals qualified to service their own appliances can have parts or accessories sent directly to their homes (VISA, MasterCard and Discover cards are accepted). Order on-line today, 24 hours every day or by phone at 800.626.2002 during normal business hours.

Instructions contained in this manual cover procedures to be performed by any user. Other servicing generally should be referred to qualified service personnel. Caution must be exercised, since improper servicing may cause unsafe operation.

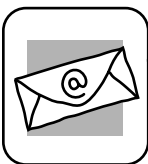

Contact Us

GEAppliances.com

If you are not satisfied with the service you receive from GE, contact us on our Website with all the details including your phone number, or write to:
General Manager, Customer Relations
GE Appliances, Appliance Park
Louisville, KY 40225



Register Your Appliance

GEAppliances.com

Register your new appliance on-line—at your convenience! Timely product registration will allow for enhanced communication and prompt service under the terms of your warranty, should the need arise. You may also mail in the pre-printed registration card included in the packing material.

Free Manuals Download Website

<http://myh66.com>

<http://usermanuals.us>

<http://www.somanuals.com>

<http://www.4manuals.cc>

<http://www.manual-lib.com>

<http://www.404manual.com>

<http://www.luxmanual.com>

<http://aubethermostatmanual.com>

Golf course search by state

<http://golfingnear.com>

Email search by domain

<http://emailbydomain.com>

Auto manuals search

<http://auto.somanuals.com>

TV manuals search

<http://tv.somanuals.com>