



# Washers

**Safety Instructions**..... 2, 3

**Operating Instructions**

Control Panels..... 4  
Control Settings..... 5, 6  
Features..... 6-9  
Loading and Using the Washer..... 9, 10  
Cleaning the Washer..... 11-13

**Installation Instructions**..... 14-19

Preparing to Install Your Washer..... 14  
Location of Your Washer..... 15  
Rough-In Dimensions..... 15  
Unpacking Your Washer..... 16  
Electrical Requirements..... 16  
Grounding Requirements..... 16  
Water Supply Requirements..... 17  
Drain Requirements..... 17  
Installing the Washer..... 17-18  
Replacement Parts..... 18  
Adaptive Vibration Control..... 19

**Troubleshooting Tips**..... 20-23

**Consumer Support**

Warranty..... 24, 25  
Service Telephone Numbers..... 26

**Owner's Manual & Installation Instructions**

- GFWH2400
- GFWH2405
- GFWS3500
- GFWS3505
- GFWS3600
- GFWS3605



As an ENERGY STAR® partner, GE has determined that this product meets the ENERGY STAR® guidelines for energy efficiency.

**Write the model and serial numbers here:**

**Model #** \_\_\_\_\_

**Serial #** \_\_\_\_\_

You can find them on a label on the side of the washer.

# IMPORTANT SAFETY INFORMATION. READ ALL INSTRUCTIONS BEFORE USING.

**⚠ WARNING!** For your safety, the information in this manual must be followed to minimize the risk of fire or explosion, electric shock, or to prevent property damage, personal injury or loss of life.

The instructions in this manual and all other literature included with this washer are not meant to cover every possible condition and situation that may occur. Good, safe practices and caution **MUST** be applied when installing, operating and maintaining any appliance.



## WATER HEATER SAFETY

Under certain conditions, hydrogen gas may be produced in a water heater that has not been used for two weeks or more. Hydrogen gas can be explosive under these circumstances.

If the hot water has not been used for two weeks or more, prevent the possibility of damage or injury by turning on all hot water faucets and allowing them to run for several minutes. Do this before using any electrical appliance which is connected to the hot water system. This simple procedure will allow any built-up hydrogen gas to escape. Since the gas is flammable, do not smoke or use an open flame or appliance during this process.



## PROPER INSTALLATION

This washer must be properly installed and located in accordance with the Installation Instructions before it is used.

- Install or store where it will not be exposed to temperatures below freezing or exposed to the weather, which could cause permanent damage and invalidate the warranty.
- Properly ground washer to conform with all governing codes and ordinances. Follow details in Installation Instructions.



## YOUR LAUNDRY AREA

- Keep the area underneath and around your appliances free of combustible materials such as lint, paper, rags and chemicals.
- Do not leave the washer door open. An open door could entice children to hang on the door or crawl inside the washer.
- Close supervision is necessary if this appliance is used by or near children. Do not allow children to play on, with or inside this or any other appliance.



## WHEN USING THE WASHER

Use this appliance only for its intended purpose as described in this Owner's Manual.

- Never reach into washer while it is moving. Wait until the machine has completely stopped before opening the door.
- Do not mix chlorine bleach with ammonia or acids such as vinegar and/or rust remover. Mixing different chemicals can produce a toxic gas which may cause death.
- Do not wash or dry articles that have been cleaned in, washed in, soaked in or spotted with combustible or explosive substances (such as wax, oil, paint, gasoline, degreasers, dry-cleaning solvents, kerosene, etc.) which may ignite or explode. Do not add these substances to the wash water. Do not use or place these substances around your washer or dryer during operation.
- The laundry process can reduce the flame retardancy of fabrics. To avoid such a result, carefully follow the garment manufacturer's wash and care instructions.
- To minimize the possibility of electric shock, unplug this appliance from the power supply or disconnect the washer at the building's distribution panel by removing the fuse or switching off the circuit breaker before attempting any maintenance or cleaning. **NOTE:** Pressing the power button does **NOT** disconnect the appliance from the power supply.
- Never attempt to operate this appliance if it is damaged, malfunctioning, partially disassembled, or has missing or broken parts, including a damaged cord or plug.
- Do not slam the washer door closed. Do not try to force the door open when locked (LOCKED indicator ON). This could result in damage to the washer.
- The washer is equipped with an electrical overload protector. The motor will stop if it becomes overheated. The washer will automatically restart after a cool-down period of up to 2 hours, if the washer has not been manually turned off during this time.



## WHEN NOT IN USE

- Turn off water faucets to relieve pressure on hoses and valves and to minimize leakage if a break or rupture should occur. Check the condition of the fill hoses; GE recommends changing the hoses every 5 years.
- Before discarding a washer, or removing it from service, remove the washer door to prevent children from hiding inside.
- Do not attempt to repair or replace any part of this appliance unless specifically recommended in this Owner's Manual, or in published user-repair instructions that you understand and have the skills to carry out.
- Do not tamper with controls.



**READ AND FOLLOW THIS SAFETY INFORMATION CAREFULLY.  
SAVE THESE INSTRUCTIONS**

# About the washer control panel.

Find the illustration that closely matches your model and see the cycle descriptions starting on page 6 for details.

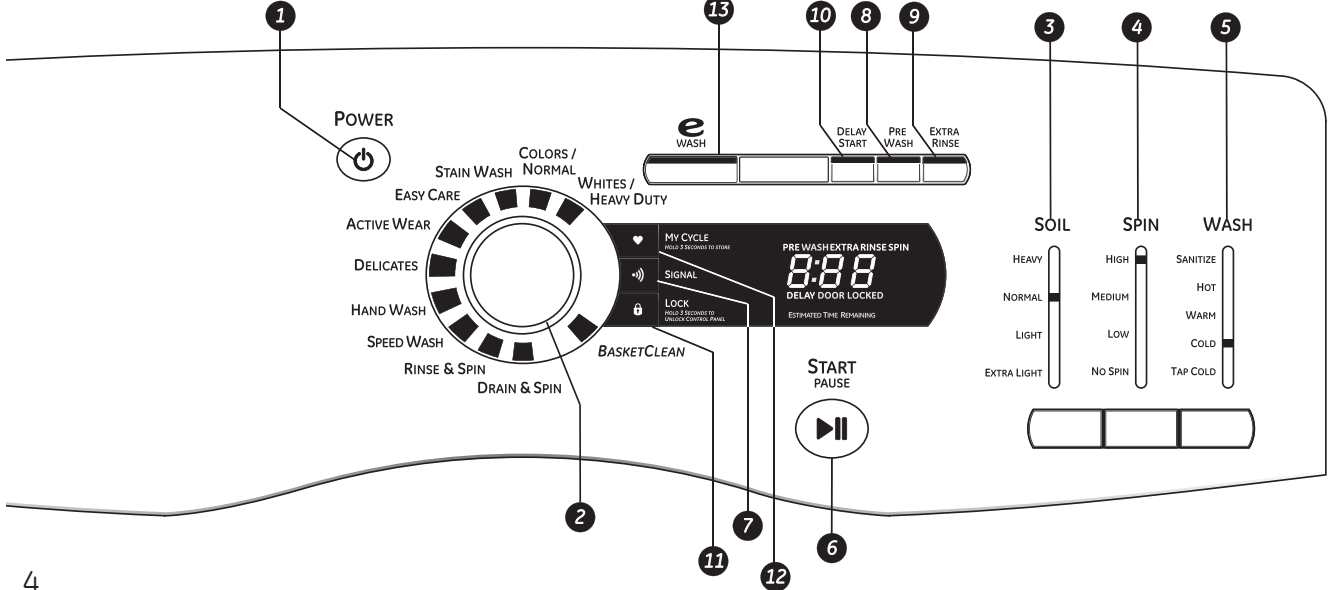
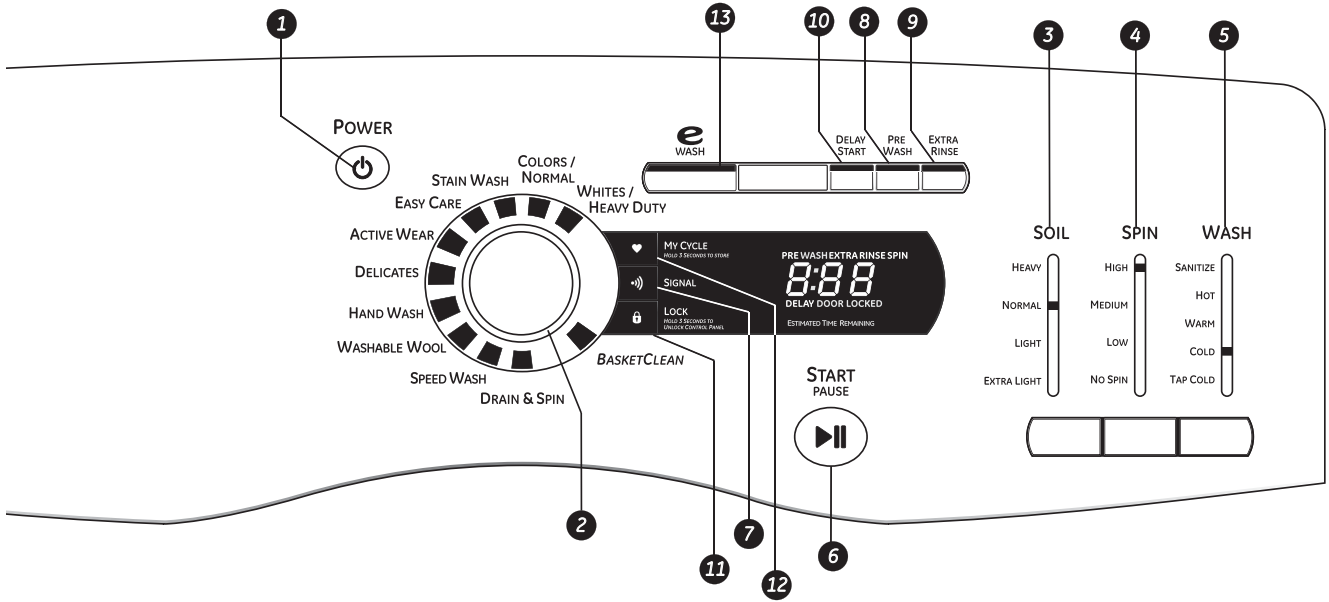
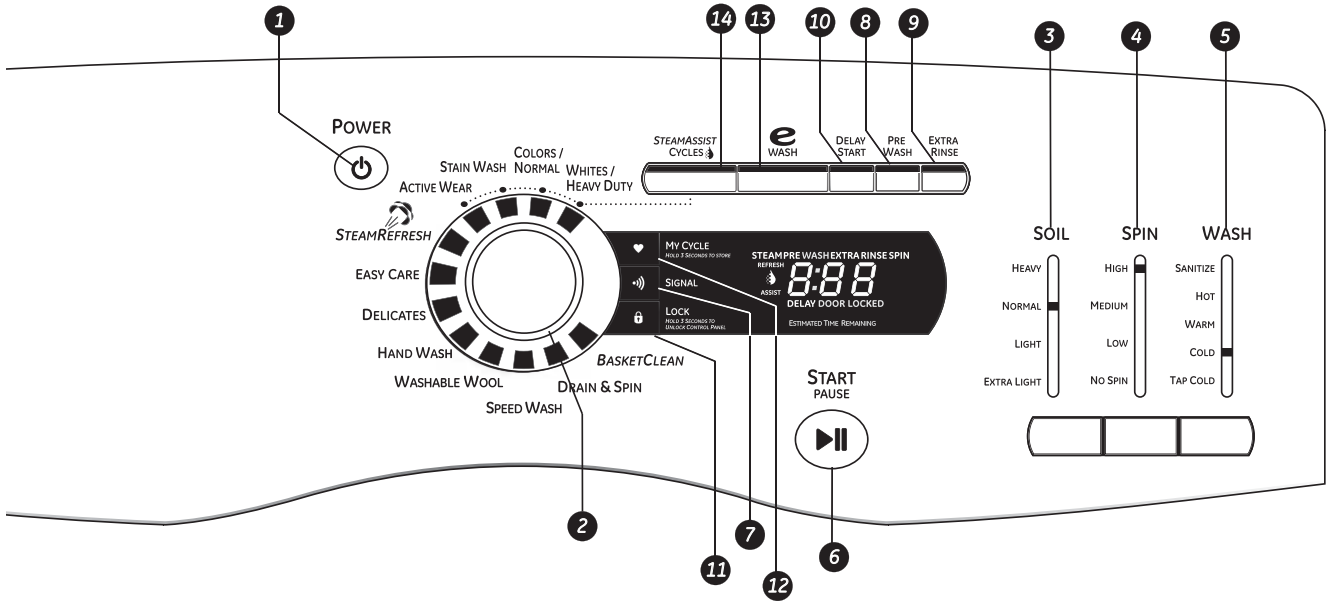

**1**

### Power

Press to “wake up” the display. If the display is active, press to put the washer into standby mode.

**NOTE:** Pressing **POWER** does not disconnect the appliance from the power supply.

**2**

### Wash Cycles

The wash cycles are optimized for specific types of wash loads. The chart below will help you match the wash setting with the loads. The GentleClean™ lifters lightly tumble the clothes into the water and detergent solution to clean the load.

<b>WHITES/HEAVY DUTY</b>	For heavily to lightly soiled white cottons, household linens, work and play clothes.
<b>COLORS/NORMAL</b>	For heavy to lightly soiled colorfast cottons, household linens, work and play clothes.
<b>STAIN WASH</b>	For heavy soiled colorfast cottons, household linens, work and play clothes.
<b>EASY CARE (PERMA PRESS)</b>	For wrinkle-free and permanent press items.
<b>ACTIVE WEAR</b>	For active sports, exercise and some casual wear clothes. Fabrics include modern technology finishes and fibers such as spandex, stretch and micro-fibers.
<b>DELICATES</b>	For lingerie and special-care fabrics with light to normal soil. Provides gentle tumbling and soak during wash and rinse.
<b>HANDWASH</b>	For items labeled hand-washable with light soils. Provides gentle rocking to mimic the handwashing action.
<b>WASHABLE WOOL</b> <i>(some models)</i>	For the washing of machine washable wool products, provided that they are washed according to the instructions on the garment label. When selecting this cycle, you must use a detergent suitable for washing wool.
<b>SPEED WASH</b>	For lightly soiled items that are needed in a hurry. Cycle time is approximately 30 minutes, depending on selected options.
<b>DRAIN &amp; SPIN</b>	Drain and spin at any time.
<b>RINSE &amp; SPIN</b> <i>(some models)</i>	Rinse and spin at any time.
<b>BASKET CLEAN</b>	Use for cleaning the basket of residue and odor. Recommended use of once per month.
<b>STEAM REFRESH</b> <i>(some models)</i>	To de-wrinkle 1 to 5 cotton blend items. This is not a wash cycle, but a cycle that applies only steam to the garments. The washer will beep upon completion of the cycle, and will continue to tumble for 30 minutes to keep wrinkles from setting in. <b>Press Start/Pause</b> to remove clothes. If clothes are slightly damp after completion of the cycle, hang dry clothes for 10 minutes before wearing.

## About the washer control panel.

### 3 Soil Level

Changing the SOIL LEVEL increases or decreases the wash time to remove different amounts of soil. To change the SOIL LEVEL, press the **SOIL LEVEL** button until you have reached the desired setting. You can choose between Extra Light, Light, Normal or Heavy soil.

### 4 Spin Speed

Changing the SPIN SPEED changes the final spin speed of the cycles. Always follow the fabric manufacturer's care label when changing the SPIN SPEED.

To change the SPIN SPEED, press the **SPIN SPEED** button until you have reached the desired setting. Higher spin speeds are not available on certain cycles, such as Delicates.

Higher spin speeds remove more water from the clothes and will help reduce dry time, but may also increase the possibility of setting wrinkles on some fabrics.

### 5 Wash Temp

Adjust to select the proper water temperature for the wash cycle. The prewash and rinse water is always cold to help reduce energy usage and reduce setting of stains and wrinkles.

Follow the fabric manufacturer's care label when selecting the wash temperature.

To change the wash temperature, press the **WASH TEMP** button until you have reached the desired setting. The Sanitized wash temperature is not available on certain cycles, such as Delicates.

When selecting the Sanitize wash temperature, the washer increases the water temperature to sanitize and kill more than 99% of many common bacteria found in home laundry. The sanitize wash temperature is only available on Stain Wash and Whites wash cycles. For best results, select the heavy soil setting when using the Sanitize wash temperature setting.

**NOTE:** The first 10 seconds of the wash fill is always cold. This feature assists in conditioning the fabric and preventing stains from setting on garments.

### 6 START/PAUSE

Press to start a wash cycle. If the washer is running, pressing it once will pause the washer and unlock the door. Press again to restart the wash cycle.

**NOTE:** If the washer is paused and the cycle is not restarted within 2 hours, the current wash cycle will be cancelled.

**NOTE:** The washer performs automatic system checks after pressing the **START** button. Water will flow in 45 seconds or less. You may hear the door lock and unlock before water flows; this is normal.

## About the washer features.

**NOTE:** Features may not be available on all washer models.

7

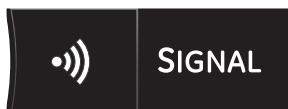

### Cycle Signal

Use the **SIGNAL** button to change the volume of the end of cycle signal.

Press the button until you reach the desired volume.

8



### Prewash

Prewash is an extra wash before the main wash. Use it for heavily soiled clothes or for clothes with a care label that recommends prewashing before washing. Be sure to add high-efficiency

detergent, or the proper wash additive to the prewash dispenser.

**NOTE:** When selecting prewash, it is recommended to use powder detergent in the main wash (detergent) compartment.

# About the washer features.

NOTE: Features may not be available on all washer models.

GEAppliances.com

Safety Instructions

Operating Instructions

Installation Instructions

Troubleshooting Tips

Consumer Support

9

EXTRA  
RINSE



## Extra Rinse

Use an extra rinse when additional rinsing is desired to remove excess dirt and detergent from soiled loads.

10

DELAY  
START



## Delay Start

You can delay the start of a wash cycle for 10–18 hours, depending on the model. Press the **DELAY START** button to choose the number of hours you want to delay the start of the cycle, then press the **START** button. The machine will count down and start automatically at the correct time.

**NOTE:** If you forget to fully close the door, a reminder signal will beep reminding you to do so.

**NOTE:** If you open the door when the delay is counting down, the machine will enter the pause state. You must close the door and press **START** again in order to restart the countdown.

11



LOCK  
HOLD 3 SECONDS TO  
UNLOCK CONTROL PANEL

## Lock

You can lock the controls to prevent any selections from being made. Or you can lock the controls after you have started a cycle.

*Children cannot accidentally start the washer by touching pads with this option selected.*

To lock the washer, press and hold the **LOCK** button for 3 seconds. To unlock the washer controls, press and hold the **LOCK** button for 3 seconds.

The control lock icon on the display will light up when it is on.

**NOTE:** The **POWER** button can still be used when the machine is locked.

12



MY CYCLE  
HOLD 3 SECONDS TO STORE

## MY CYCLE (on some models)

To save a favorite cycle, set the desired settings for wash cycle, soil level, spin speed and wash temp settings and hold down the **MY CYCLE** button for 3 seconds. A beep will sound to indicate the cycle has been saved.

To use your custom cycle, press the **MY CYCLE** button before washing a load.

To change the saved cycle, set the desired settings and hold down the **MY CYCLE** button for 3 seconds.

**NOTE:** When using **MY CYCLE**, wash options cannot be modified after the cycle has been started.

**NOTE:** If you change wash options with **MY CYCLE** before starting the cycle, the **MY CYCLE** light will turn off and you will be returned to the base cycle.

13

e  
WASH



## ENERGY SAVINGS WASH (on some models)

Use **"e" WASH** to save energy on specified wash cycles. **"e" WASH** cannot be used with **STEAM REFRESH**, **STAIN WASH** and **BASKET WASH**.

14

STEAM ASSIST  
CYCLES



## STEAM ASSIST (on some models)

**STEAM ASSIST** adds steam into the washer during **WHITES/HEAVY DUTY**, **COLORS/NORMAL**, **STAIN WASH** or **ACTIVE WEAR** cycles.

### To use:

1. Turn power **ON** and select a wash cycle.

The **STEAM ASSIST** option is only available on **WHITES/HEAVY DUTY**, **COLORS/NORMAL**, **STAIN WASH**, **ACTIVE WEAR** or **EASY CARE** cycles.

2. Select the **STEAM ASSIST** button to activate Steam.
3. Press the **START/PAUSE** button.

## About the washer features.

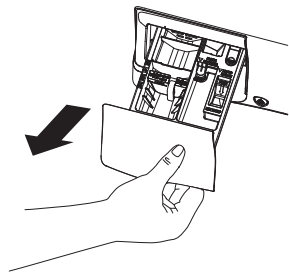

### The Dispenser Drawer

Slowly open the dispenser drawer by pulling it out until it stops.

After adding laundry products, slowly close the dispenser drawer. Closing the drawer too quickly could result in early dispensing of the bleach, fabric softener or detergent.

You may see water in the bleach and fabric softener compartments at the end of the cycle. This is a result of the flushing/siphoning action and is part of the normal operation of the washer.

**Use only HE High-Efficiency detergent.**

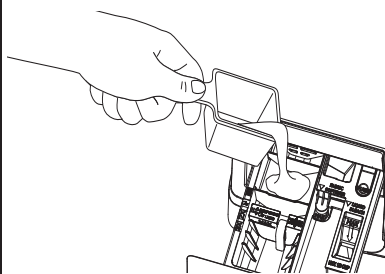

### The Prewash Compartment

- Only use the Prewash Compartment if you are selecting the Prewash cycle for heavily soiled clothes. Add measured detergent or prewash additive to the back left prewash compartment of the dispenser drawer.
- Detergent or prewash additive is flushed from the dispenser in the prewash cycle (if selected).

**NOTE:** Liquid detergent will drain into the washer drum as it is added.

- Detergent usage may need to be adjusted for water temperature, water hardness, size and soil level of the load. Avoid using too much detergent in your washer as it can lead to over sudsing and leave detergent residue on the clothes.

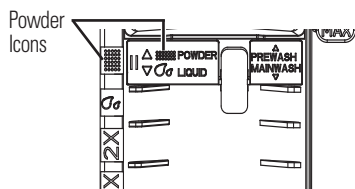

Insert in rear position for powder detergent

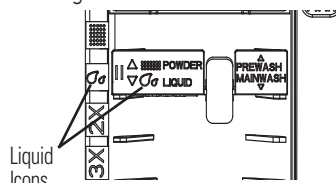



Insert in forward position for liquid detergent

### The Detergent Compartment

- Only use high-efficiency detergent in this washer. **DO NOT** fill above the MAX line.
- DO NOT** fill high-efficiency detergent to the MAX line. Use detergent manufacturer's recommended amount.

The detergent selection insert must be placed in the detergent compartment in a specific position according to the type of detergent you are using.

- **Powder Detergent** - Place the insert in the rear position. The Powder Icons  must line up on center when the insert is in the powder position.
- **Liquid Detergent** - Place the insert in the forward position. The Liquid Icons  must line up on center when the insert is in the liquid position.

Move the insert by pulling it up and replace it by sliding it down between either the rear or front detergent compartment molded rails, as desired, for powder or liquid detergent.

- Add measured detergent to the front left detergent compartment of the dispenser drawer.
- High Efficiency Detergent is flushed from the dispenser at the beginning of the wash cycle. Either powdered or liquid detergent can be used.
- Detergent usage may need to be adjusted for water temperature, water hardness, size and soil level of the load. Avoid using too much detergent in your washer as it can lead to oversudsing and detergent residue being left on the clothes.
- **DO NOT** put clumped detergent in the dispenser. Clumped detergent can cause a leak.



### The Liquid Bleach Compartment

If desired, measure out the recommended amount of liquid bleach, not to exceed 1/3 cup (80 ml) and pour into the center compartment labeled "LIQUID BLEACH" marked with this symbol .

It is recommended to use High-Efficiency (HE) bleach in this front-load washer.

Do not exceed the maximum fill line. Overfilling can cause early dispensing of the bleach which could result in damaged clothes.

**NOTE:** Do not use powdered bleach in the dispenser.



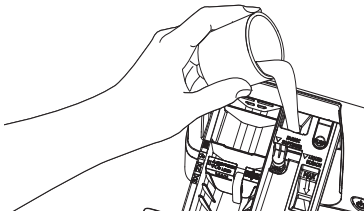

### The Fabric Softener Compartment

If desired, pour the recommended amount of liquid fabric softener into the compartment labeled "FABRIC SOFTENER."

Use only liquid fabric softener in the dispenser.

*Dilute with water to the maximum fill line.*

*Do not exceed the maximum fill line. Overfilling can cause early dispensing of the fabric softener, which could stain clothes.*

**NOTE:** *Do not pour fabric softener directly on the wash load.*

## Loading and using the washer.

Always follow fabric manufacturer's care label when laundering.



### Sorting Wash Loads

Sort laundry into loads that can be washed together.

<u>Colors</u>	<u>Soil</u>	<u>Fabric</u>	<u>Lint</u>
Whites	Heavy	Delicates	Lint Producers
Lights	Normal	Easy Care	Lint Collectors
Darks	Light	Sturdy Cottons	

- Combine large and small items in a load. Load large items first. Large items should not be more than half the total wash load.
- Washing single items is not recommended. This may cause an out-of-balance load. Add one or two similar items.
- Pillows and comforters should not be mixed with other items. This may cause an out-of-balance load.

### Preparing Clothes

Follow these steps to maximize garment care.

- To avoid snags during washing:
  - Close garment zippers, snaps, buttons and hooks.
  - Mend seams, hems, tears.
  - Empty all items from pockets.
  - Remove nonwashable garment accessories such as ornaments and nonwashable trim materials.
- To avoid tangling, tie strings, draw ties and belt-like materials.
- Brush away surface dirt and lint; treat spots and stains.
- Promptly wash wet or stained garments to maximize results.
- Mix garments using recommended maximum load sizes on page 10.
- Use nylon mesh garment bags to wash small items.
- Wash multiple garments at one time for best results.

## Loading and using the washer.

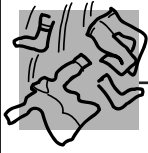

### Loading the Washer

Wash drum may be fully loaded with loosely added items. **Do not wash fabrics containing flammable materials (waxes, cleaning fluids, etc.).**

To add items after washer has started, press **START/PAUSE** and wait until the door is unlatched. The washer may take up to 30 seconds to unlock the door after pressing **START/PAUSE** depending on the machine conditions. Do not try to force open the door when it is locked. After the door unlocks, open gently. Add items, close the door and press **START/PAUSE** to restart.

#### Maximum Loading Sizes\*

WORKWEAR	LINENS	MIXED LOAD	DELICATES**	SPEED WASH (2-4 GARMENTS)
4 Jeans 5 Workwear Shirts 5 Workwear Pants	2 Bath Sheets 10 Bath Towels/ 12 Washcloths 7 Hand Towels/ 2 Terrycloth Bath Mats <b>OR</b> 2 Flat Queen-Sized Sheets 2 Fitted Queen-Sized Sheets 4 Pillowcases	4 Pillowcases 2 Hand Towels 2 Flat Sheets/ 2 Fitted Sheets 2 Bath Towels/ 4 Washcloths <b>OR</b> 6 Shirts (Men's or Women's) 4 Pair Pants (Khakis or Twills) 5 T-Shirts 7 Pairs of Boxers 4 Pairs of Shorts <b>OR</b> 6 T-Shirts 4 Pairs of Sweatpants 4 Sweatshirts 2 Hoodies 7 Pairs of Socks	7 Bras 7 Panties 3 Slips 2 Camisoles 4 Nightgowns	2 Casual Wear Work Shirts 1 Pair Casual Wear Work Pants <b>OR</b> 3 Soccer Uniforms

\*Exceeding maximum recommended load sizes may affect cleaning performance and garment care.

\*\*Using a nylon mesh bag for small items is recommended.



## Care and Cleaning

**Exterior:** Immediately wipe off any spills. Wipe with damp cloth. Do not hit surface with sharp objects.

**Moving and Storage:** Ask the service technician to remove water from drain pump and hoses. Do not store the washer where it will be exposed to the weather. When moving the washer, the tub should be kept stationary by using the shipping bolts removed during installation. See Installation Instructions in this book. If these parts are not available, they can be ordered by visiting our Website at [GEAppliances.com](http://GEAppliances.com) or by calling 800.GE.CARES. In Canada, visit [www.geappliances.ca](http://www.geappliances.ca) or call 1.800.561.3344.

**Long Vacations:** Be sure the water supply is shut off at the faucets. Drain all water from the hoses if the weather will be below freezing.

### Cleaning the Interior of the Washer

To clean the interior of the washer, select the **BasketClean** feature on the control panel. The cycle will use more water, in addition to bleach, to refresh your washer.

**NOTE:** Read the instructions below completely before starting the **BasketClean** cycle.

1. Remove any garments or objects from the washer and ensure the washer basket is empty.
2. Open the washer door and pour one cup or 250 ml of liquid bleach or other washing machine cleaner into the basket.
3. Close the door and select the **BasketClean** cycle. Push the **START** button.
4. When the **BasketClean** cycle is working, you will see **ESTIMATED TIME REMAINING** on the display. Do not interrupt the cycle.
5. After the cycle is complete, leave the door open slightly for better ventilation.

If for any reason the cycle needs to be interrupted, the door will not open immediately. Forcing open the door at this stage may cause water to flood. The door will open after the water is drained to a level where it would not flood the floor.

**BasketClean** may be interrupted by pressing the **START/PAUSE** button in between cycles. A power outage in the house might also interrupt the cycle. When the power supply is back, the **BasketClean** cycle resumes where it had stopped. When interrupted, be sure to run a complete **BasketClean** cycle before using the washer. If the **POWER** button is pressed during **BasketClean**, the cycle will be lost.

#### IMPORTANT:

- Run **BasketClean** with 1 Cup (250 ml) of bleach once a month.
- After the completion of a **BasketClean** cycle, the interior of your washer may have a bleach smell.
- It is recommended to run a light color load after the **BasketClean** cycle.

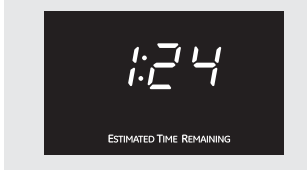
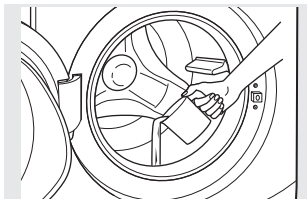

## Cleaning the washer.

### Cleaning the Pump Filter

Due to the nature of the front-load washer, it is sometimes possible for small articles to pass to the pump. The washer has a filter to capture lost items so they are not dumped to the drain. To retrieve lost items, clean out the pump filter.

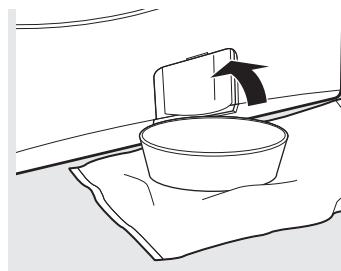
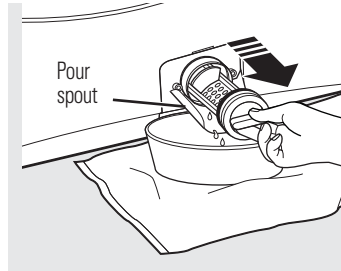
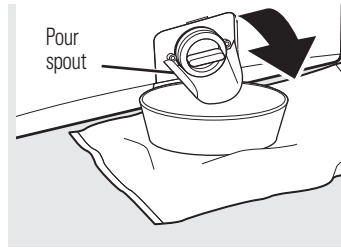
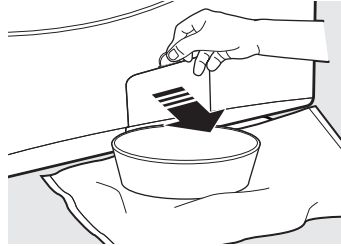

1. Using a small flathead screwdriver, open the access door.
2. Place a shallow pan or dish under the pump access door and towels on the floor in front of the washer to protect the floor. It is normal to catch about a cup of water when the filter is removed.
3. Pull down the pour spout.
4. Turn the pump filter counterclockwise and remove the filter slowly, controlling the flow of the draining water.
5. Remove the filter and clean the debris from the filter.
6. Replace the filter and turn clockwise. Tighten securely.
7. Flip up the pour spout.
8. Close the access door by hooking the bottom tabs first, then rotating the access door shut.

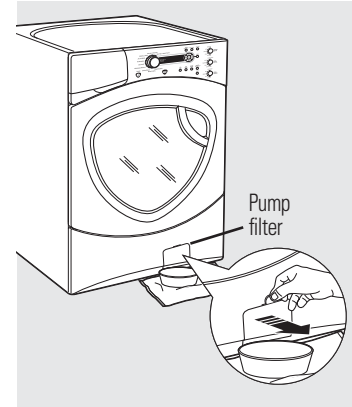

### Cleaning the Door Gasket

Open the washer door. Using both hands, press down the door gasket. Remove any foreign objects if found trapped inside the gasket. Make sure there is nothing blocking the holes behind the gasket.

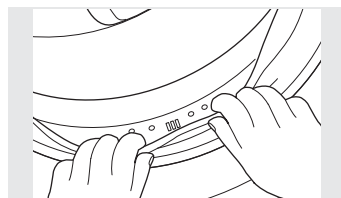

While holding down the door gasket, inspect the interior gasket by pulling it down with your fingers. Remove any foreign objects if found trapped inside this gasket. Make sure there is nothing blocking the holes behind the gasket.

When you are finished cleaning the door gasket, remove your hands and the gasket will return to the operating position.

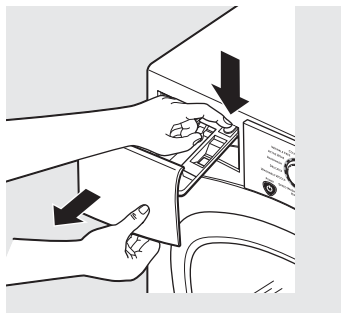

Lock tab is visible only after drawer has been pulled out

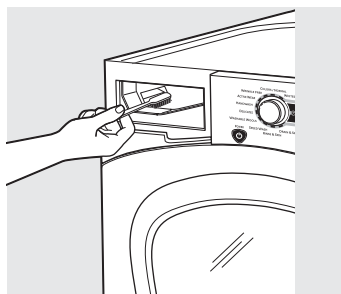
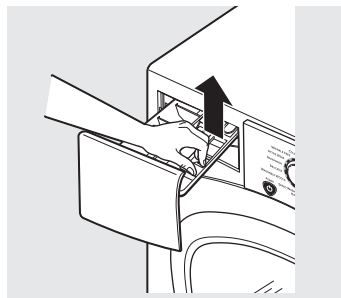

**Dispenser Drawer Area:** Detergent and fabric softener may build up in the dispenser drawer. Residue should be removed once or twice a month.

- Remove the drawer by first pulling it out until it stops. Then reach back into the left rear corner of the drawer cavity and press down firmly on the lock tab, pulling out the drawer.

- Remove the inserts from the bleach and fabric softener compartments and the detergent insert. Rinse the inserts and the drawer with hot water to remove traces of accumulated laundry products.

- To clean the drawer opening, use a small brush to clean the recess. Remove all residue from the upper and lower parts of the recess.

- Return inserts to the proper compartments. Replace the dispenser drawer.

# Installation Instructions

# Washer

If you have any questions, call 800.GE.CARES (800.432.2737) or visit our Website at: [GEAppliances.com](http://GEAppliances.com). In Canada, visit [www.geappliances.com](http://www.geappliances.com) or call 1.800.561.3344.

## BEFORE YOU BEGIN

Read these instructions completely and carefully.

- **IMPORTANT** – Save these instructions for local inspector's use.
- **IMPORTANT** – Observe all governing codes and ordinances.
- **Note to Installer** – Be sure to leave these instructions with the Consumer.
- **Note to Consumer** – Keep these instructions for future reference.
- **Skill level** – Installation of this appliance requires basic mechanical and electrical skills.
- **Completion time** – 1-3 hours
- Proper installation is the responsibility of the installer.
- Product failure due to improper installation is not covered under the Warranty.

## FOR YOUR SAFETY:

### WARNING

- This appliance must be properly grounded and installed as described in these *Installation Instructions*.
- Do not install or store the appliance in an area where it will be exposed to water/weather. See the *Location of Your Washer* section.
- **NOTE:** This appliance must be properly grounded, and electrical service to the washer must conform with local codes and ordinances and the latest edition of the National Electrical Code, ANSI/NFPA 70.

## TOOLS REQUIRED FOR WASHER INSTALLATION

- 1/4" nut driver
- 3/8" socket with ratchet
- 3/8" open-end wrench
- Adjustable wrench or 7/16" socket with ratchet
- Adjustable wrench or 9/16" open-end wrench
- Channel-lock adjustable pliers
- Carpenter's level

## PARTS SUPPLIED

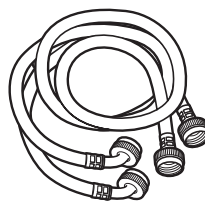

Water Hoses (2)



Cable Tie

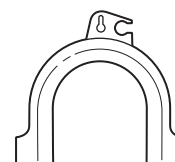

Hose Guide

## STACK BRACKET KIT

A stack bracket kit is available at additional cost. It can be ordered in the United States by visiting our website at [GEAppliances.com](http://GEAppliances.com) or calling 800.GE.CARES. Order kit #WE25X10018 or GEFLSTACK. In Canada, please contact your nearest parts retailer.

# Installation Instructions

## LOCATION OF YOUR WASHER

### Do Not Install the Washer:

1. In an area exposed to dripping water or outside weather conditions. The ambient temperature should never be below 60°F (15.6°C) for proper washer operation.
2. In an area where it will come in contact with curtains or drapes.
3. On carpet. The floor **MUST** be a hard surface with a maximum slope of 1/2" per foot (1.27 cm per 30 cm). To make sure the washer does not vibrate or move, you may have to reinforce the floor.

**NOTE:** If floor is in poor condition, use 3/4" impregnated plywood sheet solidly attached to the existing floor covering.

### IMPORTANT:

### Minimum Installation Clearances

- When installed in alcove: Sides, Rear, Top = 0" (0 cm)
- When installed in closet: Sides, Rear, Top = 0" (0 cm), Front = 1" (2.54 cm)
- Closet door ventilation openings required: 2 louvers each 60 square in. (387 cm<sup>2</sup>), located 3" (7.6 cm) from top and bottom of door

## ROUGH-IN DIMENSIONS

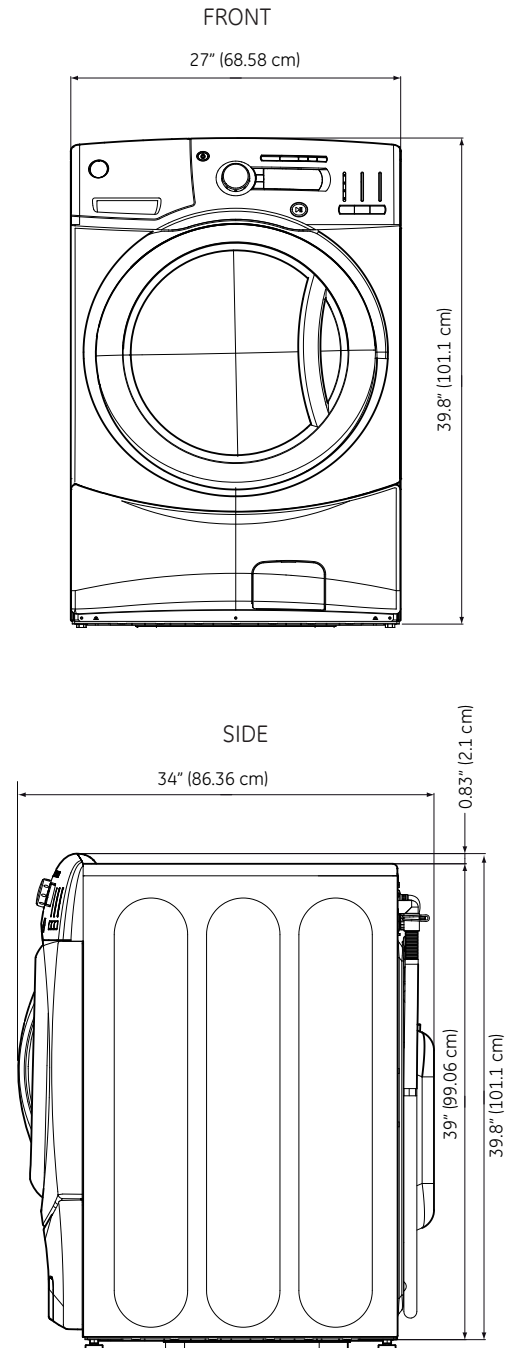

### \*NOTE:

With Washer Legs: 40.5" (102.5 cm)  
(0.75" adjustability)

With Pedestal: 53.75" (136.6 cm)  
(0.75" adjustability)

Stacked: 82.75" (209.8 cm)

# Installation Instructions

## UNPACKING THE WASHER

**⚠ WARNING:** Recycle or destroy the carton and plastic bags after the washer is unpacked. Make materials inaccessible to children. Children might use them for play. Cartons covered with rugs, bedspreads or plastic sheets can become airtight chambers causing suffocation.

1. Cut and remove the top and bottom packaging straps.
2. While it is in the carton, carefully lay the washer on its side. **DO NOT** lay the washer on its front or back.
3. Turn down the bottom flaps—remove all base packaging, including the cardboard, styrofoam base and styrofoam tub support (inserted in center of base).

**NOTE:** If you are installing a pedestal, proceed to the installation instructions that come with the pedestal.

4. Carefully return the washer to an upright position and remove the carton.
5. Carefully move the washer to within 4 feet (122 cm) of the final location.
6. Remove the following from the back side of the washer:
  - 4 bolts
  - 4 plastic spacers (including rubber grommets)
  - 4 power cord retainers

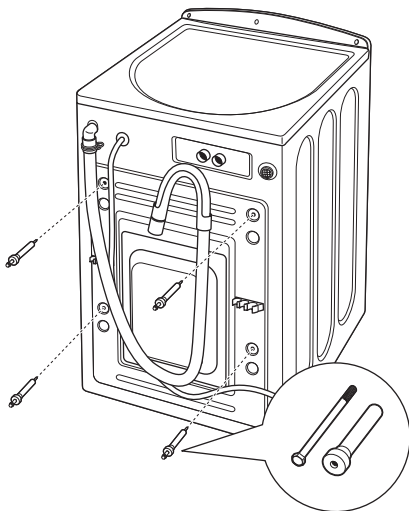

**NOTE:** Failure to remove the shipping braces can cause the washer to become severely unbalanced.

**Save all bolts for future use.**

**NOTE:** If you must transport the washer at a later date, you must reinstall the shipping support hardware to prevent shipping damage. Keep the hardware in the plastic bag provided.

**In case you misplace your shipping bolts, replacements are available at additional cost. They can be ordered in the United States by visiting our website at [GEAppliances.com](http://GEAppliances.com) or calling 800.GE.CARES. Order kit #WH49X10039. In Canada, please contact your nearest parts retailer.**

## ELECTRICAL REQUIREMENTS

Read these instructions completely and carefully.

**⚠ WARNING:** TO REDUCE THE RISK OF FIRE, ELECTRICAL SHOCK AND PERSONAL INJURY:

- **DO NOT USE AN EXTENSION CORD OR AN ADAPTER PLUG WITH THIS APPLIANCE.**

Washer must be electrically grounded in accordance with local codes and ordinances, or in the absence of local codes, in accordance with the NATIONAL ELECTRICAL CODE, ANSI/NFPA NO. 70.

**CIRCUIT** – Individual, properly polarized and grounded 15-amp branch circuit fused with 15-amp time-delay fuse or circuit breaker.

**POWER SUPPLY** – 2-wire, with ground, 120-volt, single-phase, 60-Hz, alternating current.

**OUTLET RECEPTACLE** – Properly grounded 3-prong receptacle to be located so the power supply cord is accessible when the washer is in an installed position.

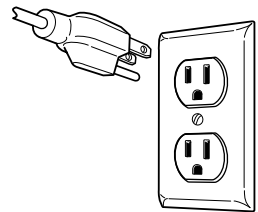

## GROUNDING REQUIREMENTS

**⚠ WARNING:** Improper connection of the equipment grounding conductor can result in a risk of electrical shock. Check with a licensed electrician if you are in doubt as to whether the appliance is properly grounded.

1. The washer **MUST** be grounded. In the event of malfunction or breakdown, grounding will reduce the risk of electrical shock by providing a path of least resistance for electrical current.
2. Since your washer is equipped with a power supply cord having an equipment-grounding conductor and a grounding plug, the plug **MUST** be plugged into an appropriate, copper-wired receptacle that is properly installed and grounded in accordance with all local codes and ordinances or in the absence of local codes, with the National Electrical Codes, ANSI/NFPA 70 (latest edition). If in doubt, call a licensed electrician. **DO NOT** cut off or alter the grounding prong on the power supply cord. In situations where a two-slot receptacle is present, it is the owner's responsibility to have a licensed electrician replace it with a **properly grounded** three-prong grounding-type receptacle.



# Installation Instructions

## WATER SUPPLY REQUIREMENTS

Hot and cold water faucets **MUST** be installed within 42 inches (107 cm) of your washer's water inlet. The faucets **MUST** be 3/4" (1.9 cm) garden hose-type so inlet hoses can be connected. Water pressure **MUST** be between 10 and 120 pounds per square inch. Your water department can advise you of your water pressure. The hot water temperature should be set to deliver water at 120° to 140°F (48°–60°C) to provide proper Automatic Temperature Control (ATC) performance.

NOTE: A water softener is recommended to reduce buildup of scale inside the steam generator if the home water supply is very hard.

## DRAIN REQUIREMENTS

1. Drain capable of eliminating 17 gals (64.3 L) per minute.
2. A standpipe diameter of 1-1/4" (3.18 cm) minimum.
3. The standpipe height above the floor should be:  
Minimum height: 24" (61 cm)  
Maximum height: 96" (244 cm)

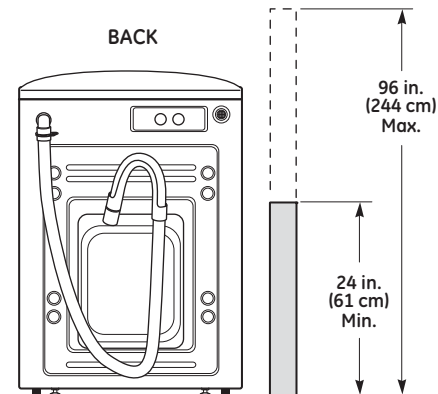

NOTE: The drain hose attached to the washer can reach a 58" (147 cm) high standpipe. For a higher standpipe, contact an authorized parts distributor.

## INSTALLING THE WASHER

1. Run some water from the hot and cold faucets to flush the water lines and remove particles that might clog up the water valve screens.
2. Remove the inlet hoses from the plastic bag.
3. (90° elbow end) Carefully connect the inlet hose marked HOT to the outside "H" outlet of the water valve. Tighten by hand, then tighten another 2/3 turn with pliers. Carefully connect the other inlet hose to the inside "C" outlet of the water valve. Tighten by hand; then tighten another 2/3 turn with pliers. **Do not crossthread or over-tighten these connections.**
4. Connect the inlet hose ends to the HOT and COLD water faucets tightly by hand, then tighten another 2/3 turn with pliers. Turn the water on and check for leaks.

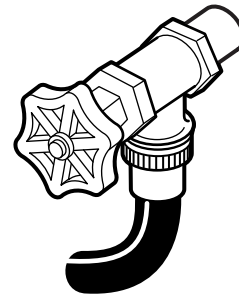
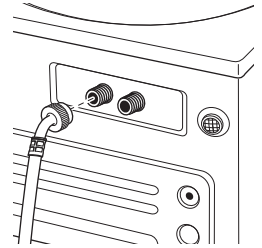

5. Carefully move the washer to its final location. Gently rock the washer into position. It is important not to damage the rubber leveling legs when moving your washer to its final location. Damaged legs can increase washer vibration. It may be helpful to spray window cleaner on the floor to help move your washer into its final position.

NOTE: To reduce vibration, ensure that all four rubber leveling legs are firmly touching the floor. Push and pull on the back right and then back left of your washer.

NOTE: Do not use the dispenser drawer or door to lift the washer.

NOTE: If you are installing into a drain pan, you can use a 24-inch long 2x4 to lever the washer into place.

# Installation Instructions

## INSTALLING THE WASHER (cont.)

6. With the washer in its final position, place a level on top of the washer (if the washer is installed under a counter, the washer should not be able to rock). Adjust the front leveling legs up or down to ensure the washer is resting solid. Turn the lock nuts on each leg up towards the base of the washer and snug with a wrench.

**NOTE:** Keep the leg extension at a minimum to prevent excessive vibration. The farther out the legs are extended, the more the washer will vibrate.

If the floor is not level or is damaged, you may have to extend the rear leveling legs.

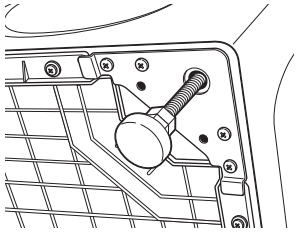

7. Attach the U-shaped hose guide to the end of the drain hose. Place the hose in a laundry tub or standpipe and secure it with the cable tie provided in the enclosure package.

**NOTE:** Placing the drain hose too far down the drain pipe can cause a siphoning action. No more than 7 inches of hose should be in the drain pipe. There must be an air gap around the drain hose. A snug fit can cause a siphoning action.

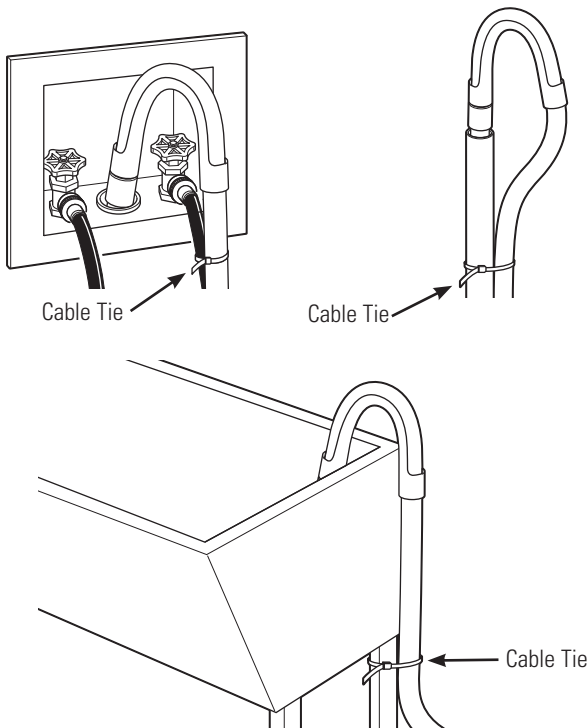

8. Plug the power cord into a grounded outlet.

**NOTE:** Check to be sure the power is off at the circuit breaker/fuse box before plugging the power cord into an outlet.

9. Turn on the power at the circuit breaker/fuse box.

10. Read the rest of this Owner's Manual. It contains valuable and helpful information that will save you time and money.

11. Before starting the washer, check to make sure:

- Main power is turned on.
- The washer is plugged in.
- The water faucets are turned on.
- The unit is level and all four leveling legs are firmly on the floor.
- The shipping support hardware is removed and saved.
- The drain hose is properly tied up.
- There are no leaks at the faucet, drain line or washer.

12. Run the washer through a complete cycle. Check for water leaks and proper operation.

13. If your washer does not operate, please review the *Before You Call For Service* section before calling for service.

14. Place these instructions in a location near the washer for future reference.

## REPLACEMENT PARTS

If replacement parts are needed for your washer, they can be ordered in the United States by visiting our Website at [GEAppliances.com](http://GEAppliances.com) or by calling 800.GE.CARES. In Canada, please contact your nearest parts retailer.

# Installation Instructions

## ADAPTIVE VIBRATION CONTROL

Your GE washer is equipped with Adaptive Vibration Control Technology. Using information about the floor, this system can reduce vibration and improve spin performance in some installations by adapting the spin cycle. The DEFAULT configuration is specially designed to provide optimal performance across the widest range of floor types. Follow the procedure below to enable more specific adaptive settings. Your washer can be returned quickly and easily to the DEFAULT configuration at any time using the same procedure.

## Floor Type Selection

1. With the unit powered off, press and hold **EXTRA RINSE** and **SPIN** buttons simultaneously for 3 seconds.

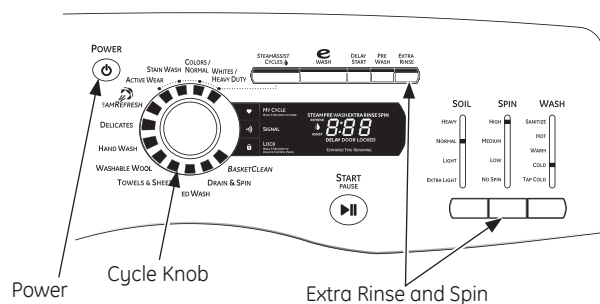

2. Rotate the cycle knob and select **FL1**, **FL2**, **FL3**, or **FL4**. Press the **START** button to make the selection. See the table below for suggested installations.

FL1	Default**
FL2	Concrete Floor
FL3	Strong Wood Floor
FL4	Normal Wood Floor

\*\*The default setting is acceptable for most installations.

3. Rotate the cycle knob and select **PE1** or **PE2** for pedestal. Press the **START** button to make the selection. **PE1** is **YES** and **PE2** is **NO**.

FL1

PE1

## Before you call for service...



**Troubleshooting Tips**  
Save time and money! Review the charts on the following pages first and you may not need to call for service.

Problem	Possible Cause	What To Do
<b>Not draining</b> <b>Not spinning</b> <b>Not agitating</b>	<b>Load is out of balance</b>	<ul style="list-style-type: none"> <li>• Redistribute clothes and run drain &amp; spin or rinse &amp; spin.</li> <li>• Increase load size if washing small load containing heavy and light items.</li> <li>• See page 12 on how to clean the Pump Filter.</li> <li>• Straighten drain hose and make sure washer is not sitting on it.</li> <li>• Check household plumbing. You may need to call a plumber.</li> <li>• Ensure there is an air gap between hose and drain.</li> </ul>
	<b>Pump clogged</b> <b>Drain hose is kinked or improperly connected</b> <b>Household drain may be clogged</b> <b>Drain hose siphoning; drain hose pushed too far down the drain</b>	
<b>Leaking water</b>	<b>Door gasket is damaged</b>	<ul style="list-style-type: none"> <li>• Check to see if gasket is seated and not torn. Objects left in pockets may cause damage to the washer (nails, screws, pens, pencils)</li> <li>• Water may drip from the door when the door is opened. This is a normal operation.</li> <li>• Carefully wipe off rubber door seal. Sometimes dirt or clothing is left in this seal and can cause a small leak</li> <li>• If this area is wet, you have oversudsing condition. Use less detergent.</li> <li>• Make sure hose connections are tight at washer and faucets and make sure end of drain hose is correctly inserted in and secured to drain facility.</li> <li>• Check household plumbing. You may need to call a plumber.</li> <li>• Powder soap may cause clogs inside the dispenser and cause water to leak out the front of the dispenser. Remove drawer and clean both drawer and inside of dispenser box. Please refer to <i>Cleaning the Washer</i> section.</li> <li>• Use HE and correct amount of detergent.</li> <li>• If new installation, check for crack on inside of dispenser box.</li> </ul>
	<b>Door gasket not damaged</b>	
	<b>Check back left of washer for water</b>	
	<b>Fill hoses or drain hose is improperly connected</b>	
	<b>Household drain may be clogged</b>	
	<b>Dispenser clogged</b>	
<b>Clothes too wet</b>	<b>Load is out of balance</b>	<ul style="list-style-type: none"> <li>• Redistribute clothes and run drain &amp; spin or rinse &amp; spin.</li> <li>• Increase load size if washing small load containing heavy and light items.</li> <li>• The machine will slow the spin speed down to 410 rpm if it has a hard time balancing the load. This speed is normal.</li> <li>• See page 12 on how to clean the Pump Filter.</li> <li>• The dry weight of the load should be less than 16 lb.</li> <li>• Straighten drain hose and make sure washer is not sitting on it.</li> <li>• Check household plumbing. You may need to call a plumber.</li> <li>• Ensure there is an air gap between hose and drain.</li> </ul>
	<b>Pump clogged</b> <b>Overloading</b> <b>Drain hose is kinked or improperly connected</b> <b>Household drain may be clogged</b> <b>Drain hose siphoning; drain hose pushed too far down the drain</b>	

Problem	Possible Cause	What To Do
<i>Incomplete cycle or timer not advancing</i>	<p>Automatic load redistribution</p> <p>Pump clogged</p> <p>Drain hose is kinked or improperly connected</p> <p>Household drain may be clogged</p> <p>Drain hose siphoning; drain hose pushed too far down the drain</p>	<ul style="list-style-type: none"> <li>• Timer adds 3 minutes to cycle for each rebalance. 11 or 15 rebalances may be done. This is normal operation. Do nothing; the machine will finish the wash cycle.</li> <li>• See page 12 on how to clean the Pump Filter.</li> <li>• Straighten drain hose and make sure washer is not sitting on it.</li> <li>• Check household plumbing. You may need to call a plumber.</li> <li>• Ensure there is an air gap between hose and drain.</li> </ul>
<i>Loud or unusual noise; vibration or shaking</i>	<p>Cabinet moving</p> <p>All rubber leveling legs are not firmly touching the floor</p> <p>Unbalanced load</p> <p>Pump clogged</p>	<ul style="list-style-type: none"> <li>• Washer is designed to move 1/4" to reduce forces transmitted to the floor. This movement is normal.</li> <li>• Push and pull on the back right and then back left of your washer to check if it is level. If the washer is uneven, adjust the rubber leveling legs so they are all firmly touching the floor and locked in place. Your installer should correct this problem.</li> <li>• Open door and manually redistribute load. To check machine, run rinse and spin with no load. If normal, unbalance was caused by load.</li> <li>• See page 12 on how to clean the Pump Filter.</li> </ul>
<i>No power/ washer not working or dead</i>	<p>Washer is unplugged</p> <p>Water supply is turned off</p> <p>Circuit breaker/fuse is tripped/blown</p> <p>Automatic self system checks</p>	<ul style="list-style-type: none"> <li>• Make sure cord is plugged securely into a working outlet.</li> <li>• Turn both hot and cold faucets fully on.</li> <li>• Check house circuit breakers/fuses. Replace fuses or reset breaker. Washer should have separate outlet.</li> <li>• First time the washer is plugged in, automatic checks occur. It may take up to 20 seconds before you can use your washer. This is normal operation.</li> </ul>
<i>Snags, holes, tears, rips or excessive wear</i>	<p>Overloaded</p> <p>Pens, pencils, nails, screws or other objects left in pockets</p> <p>Pins, snaps, hooks, sharp buttons, belt buckles, zippers and sharp objects left in pockets</p>	<ul style="list-style-type: none"> <li>• Do not exceed maximum recommended load sizes. See recommended maximum load sizes on page 10.</li> <li>• Remove loose items from pockets.</li> <li>• Fasten snaps, hooks, buttons and zippers.</li> </ul>
<i>Control time wrong or changes</i>	This is normal	<ul style="list-style-type: none"> <li>• During spin the washer may need to rebalance the load sometimes to reduce vibrations. When this happens, the estimated time is increased causing time left to increase or jump.</li> </ul>
<i>Not enough water</i>	This is normal	<ul style="list-style-type: none"> <li>• Horizontal washers do not require the tub to fill with water like top-load washers.</li> </ul>
<i>Washer pauses or has to be restarted, or washer door is locked and will not open</i>	Pump clogged	<ul style="list-style-type: none"> <li>• See page 12 on how to clean the Pump Filter.</li> </ul>
<i>Door unlocks or press START and machine doesn't operate</i>	<p>This is normal</p> <p>Incorrect operation</p>	<ul style="list-style-type: none"> <li>• Front-load washers start up differently than top-load washers, and it takes 30 seconds to check the system. The door will lock and unlock.</li> <li>• Simply open and close the door firmly; then press <b>START</b>.</li> </ul>

## Before you call for service...

Problem	Possible Cause	What To Do
<i>Water does not enter washer or enters slowly</i>	Automatic self system checks Water supply is turned off Water valve screens are stopped up	<ul style="list-style-type: none"> <li>• After <b>START</b> is pressed, the washer does several system checks. Water will flow 60 seconds after <b>START</b> is pressed.</li> <li>• Turn on both hot and cold faucets fully.</li> <li>• Turn off the water source and remove the water connection hoses from the upper back of the washer. Use a brush or toothpick to clean the screens in the machine. Reconnect the hoses and turn the water back on.</li> </ul>
<i>Wrinkling</i>	Improper sorting Overloading Incorrect wash cycle Repeated washing in water that is too hot	<ul style="list-style-type: none"> <li>• Avoid mixing heavy items (like work clothes) with light items (like blouses).</li> <li>• Load your washer so clothes have enough room to move freely.</li> <li>• Match cycle selection to the type of fabric you are washing (especially for easy care loads).</li> <li>• Wash in warm or cold water.</li> </ul>
<i>Grayed or yellowed clothes</i>	Not enough detergent Not using HE (high efficiency) detergent Hard water Water is not hot enough Detergent is not dissolving Dye transfer	<ul style="list-style-type: none"> <li>• Use correct amount of detergent.</li> <li>• Use HE detergent.</li> <li>• Use hottest water safe for fabric.</li> <li>• Use a water conditioner like Calgon brand or install a water softener.</li> <li>• Make sure water heater is delivering water at 120°–140°F (48°–60°C).</li> <li>• Try a liquid detergent.</li> <li>• Sort clothes by color. If fabric label states wash separately, unstable dyes may be indicated.</li> </ul>
<i>Colored spots</i>	Incorrect use of fabric softener Dye transfer	<ul style="list-style-type: none"> <li>• Check fabric softener package for instructions and follow directions for using dispenser.</li> <li>• Sort whites or lightly colored items from dark colors.</li> <li>• Promptly remove wash load from washer.</li> </ul>
<i>Water temperature is incorrect</i>	Water supply is improperly connected House water heater is not set properly	<ul style="list-style-type: none"> <li>• Make sure hoses are connected to correct faucets.</li> <li>• Make sure house water heater is delivering water at 120°–140°F (48°–60°C).</li> </ul>
<i>Slight variation in metallic color</i>	This is normal	<ul style="list-style-type: none"> <li>• Due to the metallic properties of paint used for this unique product, slight variations of color may occur due to viewing angles and lighting conditions.</li> </ul>
<i>Bad odor inside your Washer</i>	Washer unused for a long time, not using recommended quality of HE detergent or used too much detergent	<ul style="list-style-type: none"> <li>• Run a <b>BasketClean</b> cycle.</li> <li>• In case of strong odor, you may need to run the <b>BasketClean</b> cycle more than once.</li> <li>• Use only the amount of detergent recommended on the detergent container.</li> <li>• Use only HE (high efficiency) detergent.</li> <li>• Always remove wet items from the washer promptly after machine stops running.</li> <li>• Leave the door slightly open for the water to air dry. Close supervision is necessary if this appliance is used by or near children. Do not allow children to play on, with or inside this or any other appliance.</li> </ul>

Problem	Possible Cause	What To Do
<i>Detergent leak</i>	<p><b>Incorrect placement of detergent insert</b></p> <p><b>This is normal</b></p>	<ul style="list-style-type: none"> <li>• Make sure detergent insert is properly located and fully seated. Never put detergent above max line.</li> <li>• It is normal operation to see detergent leak on door gasket about 20 seconds after filling the dispenser.</li> </ul>
<i>Improper dispensing of softener or bleach</i>	<p><b>Dispenser clogged</b></p> <p><b>Softener or bleach is filled above the max line</b></p> <p><b>Softener or bleach cap issue</b></p>	<ul style="list-style-type: none"> <li>• Monthly clean the dispenser drawer to remove buildup of chemicals.</li> <li>• Make sure to have the correct amount of softener or bleach.</li> <li>• Make sure softener and bleach cap for dispenser are seated or they will not work.</li> </ul>

Safety Instructions

Operating Instructions

Installation Instructions

Troubleshooting Tips

Consumer Support

## GE Washer Warranty.



All warranty service provided by our Factory Service Centers, or an authorized Customer Care<sup>®</sup> technician. To schedule service, visit us on-line at [GEAppliances.com](http://GEAppliances.com), or call 800.GE.CARES (800.432.2737). Please have serial number and model number available when calling for service.

Staple your receipt here.  
Proof of the original purchase date is needed to obtain service under the warranty.

### For The Period Of: We Will Replace:

#### One Year

From the date of the original purchase

**Any part** of the washer which fails due to a defect in materials or workmanship. During this **limited one-year warranty**, GE will also provide, **free of charge**, all labor and related service costs to replace the defective part.

### What Is Not Covered (in the United States):

- Service trips to your home to teach you how to use the product.
- Improper installation, delivery or maintenance.
- Failure of the product if it is abused, misused, or used for other than the intended purpose or used commercially.
- Damage after delivery.
- Replacement of house fuses or resetting of circuit breakers.
- Damage to the product caused by accident, fire, floods or acts of God.
- Incidental or consequential damage caused by possible defects with this appliance.
- Product not accessible to provide required service.

**EXCLUSION OF IMPLIED WARRANTIES—Your sole and exclusive remedy is product repair as provided in this Limited Warranty. Any implied warranties, including the implied warranties of merchantability or fitness for a particular purpose, are limited to one year or the shortest period allowed by law.**

This warranty is extended to the original purchaser and any succeeding owner for products purchased for home use within the USA. If the product is located in an area where service by a GE Authorized Servicer is not available, you may be responsible for a trip charge or you may be required to bring the product to an Authorized GE Service location for service. In Alaska, the warranty excludes the cost of shipping or service calls to your home.

Some states do not allow the exclusion or limitation of incidental or consequential damages. This warranty gives you specific legal rights, and you may also have other rights which vary from state to state. To know what your legal rights are, consult your local or state consumer affairs office or your state's Attorney General.

**Warrantor: General Electric Company. Louisville, KY 40225**



# GE Washer Warranty. *(For customers in Canada)*



All warranty service provided by our Factory Service Centres or an authorized technician. For service, call 1.800.561.3344. Please have serial number and model number available when calling for service.

Staple your receipt here.  
Proof of the original purchase date is needed to obtain service under the warranty.

## For The Period Of: We Will Replace:

### One Year

From the date of the original purchase

**Any part** of the washer which fails due to a defect in materials or workmanship. During this **limited one-year warranty**, Mabe will also provide, **free of charge**, all labour and related service costs to replace the defective part.

## What Is Not Covered (in Canada):

- Service trips to your home to teach you how to use the product.
- Improper installation, delivery or maintenance.
- Failure of the product if it is abused, misused, or used for other than the intended purpose or used commercially.
- Damage after delivery.
- Replacement of house fuses or resetting of circuit breakers.
- Damage to the product caused by accident, fire, floods or acts of God.
- Incidental or consequential damage caused by possible defects with this appliance.
- Product not accessible to provide required service.

**EXCLUSION OF IMPLIED WARRANTIES**—Your sole and exclusive remedy is product repair as provided in this Limited Warranty. Any implied warranties, including the implied warranties of merchantability or fitness for a particular purpose, are limited to one year or the shortest period allowed by law.

This warranty is extended to the original purchaser and any succeeding owner for products purchased in Canada for home use within Canada. In-home warranty service will be provided in areas where it is available and deemed reasonable by Mabe to provide.

Some states or provinces do not allow the exclusion or limitation of incidental or consequential damages, so the above exclusion may not apply to you. This warranty gives you specific legal rights, and you may also have other rights which vary from province to province. To know what your legal rights are in your province, consult your local or provincial consumer affairs office.

**Warrantor: Mabe Canada Inc.,  
Burlington, Ontario**

Safety Instructions

Operating Instructions

Installation Instructions

Troubleshooting Tips

Consumer Support

# Consumer Support.

---



## GE Appliances Website

In the U.S.: **GEAppliances.com**

Have a question or need assistance with your appliance? Try the GE Appliances Website 24 hours a day, any day of the year! For greater convenience and faster service, you can now download Owner's Manuals, order parts or even schedule service on-line. **In Canada: [www.GEAppliances.ca](http://www.GEAppliances.ca)**



## Schedule Service

In the U.S.: **GEAppliances.com**

Expert GE repair service is only one step away from your door. Get on-line and schedule your service at your convenience any day of the year! Or call 800.GE.CARES (800.432.2737) during normal business hours.

**In Canada, call 1.800.561.3344**



## Real Life Design Studio

In the U.S.: **GEAppliances.com**

GE supports the Universal Design concept—products, services and environments that can be used by people of all ages, sizes and capabilities. We recognize the need to design for a wide range of physical and mental abilities and impairments. For details of GE's Universal Design applications, including kitchen design ideas for people with disabilities, check out our Website today. For the hearing impaired, please call 800.TDD.GEAC (800.833.4322).

**In Canada, contact:** Manager, Consumer Relations, Mabe Canada Inc.  
Suite 310, 1 Factory Lane  
Moncton, N.B. E1C 9M3



## Extended Warranties

In the U.S.: **GEAppliances.com**

Purchase a GE extended warranty and learn about special discounts that are available while your warranty is still in effect. You can purchase it on-line anytime, or call 800.626.2224 during normal business hours. GE Consumer Home Services will still be there after your warranty expires. **In Canada, contact your local extended warranty provider.**

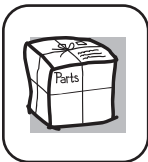

## Parts and Accessories

In the U.S.: **GEAppliances.com**

Individuals qualified to service their own appliances can have parts or accessories sent directly to their homes (VISA, MasterCard and Discover cards are accepted). Order on-line today, 24 hours every day or by phone at 800.626.2002 during normal business hours.

**Instructions contained in this manual cover procedures to be performed by any user. Other servicing generally should be referred to qualified service personnel. Caution must be exercised, since improper servicing may cause unsafe operation.**

Customers **in Canada** should consult the yellow pages for the nearest Mabe service center, or call 1.800.661.1616.



## Contact Us

In the U.S.: **GEAppliances.com**

If you are not satisfied with the service you receive from GE, contact us on our Website with all the details including your phone number, or write to:

General Manager, Customer Relations  
GE Appliances, Appliance Park  
Louisville, KY 40225

**In Canada: [www.GEAppliances.ca](http://www.GEAppliances.ca), or write to:**

Director, Consumer Relations, Mabe Canada Inc.  
Suite 310, 1 Factory Lane  
Moncton, N.B. E1C 9M3



## Register Your Appliance

In the U.S.: **GEAppliances.com**

**Register your new appliance on-line—at your convenience!** Timely product registration will allow for enhanced communication and prompt service under the terms of your warranty, should the need arise. You may also mail in the pre-printed registration card included in the packing material. **In Canada: [www.GEAppliances.ca](http://www.GEAppliances.ca)**

## Free Manuals Download Website

<http://myh66.com>

<http://usermanuals.us>

<http://www.somanuals.com>

<http://www.4manuals.cc>

<http://www.manual-lib.com>

<http://www.404manual.com>

<http://www.luxmanual.com>

<http://aubethermostatmanual.com>

Golf course search by state

<http://golfingnear.com>

Email search by domain

<http://emailbydomain.com>

Auto manuals search

<http://auto.somanuals.com>

TV manuals search

<http://tv.somanuals.com>