



Built-In Gas Wall Oven

Safety Instructions2, 4-6

Operating Instructions, Tips

Aluminum foil14, 19
Baking feature14-15
Broiling feature21, 22
Clock and timer8
Control features and settings .7
Door latch23
Ignition12
Light12
Preheating14
Roasting feature19, 20
Self-cleaning
instructions23-24
Shelves13
Special features of your
oven control10-11
Timed baking16-17
Type of margarine18
Vent12

Care and Cleaning

Broiler pan and grid25
Burner air adjustment
shutters28
Control panel26
Door removal27
Light replacement25
Orifice hood adjustment28
Oven bottom26
Oven vents25
Self-cleaning
instructions23-24
Shelves26
Storage drawer25

Before You Call For Service

Thermostat adjustment –
do it yourself18
Troubleshooting tips29-31

Consumer Services

Important phone
numbersBack Cover
Model and serial number
location3
Product registration . . .3, 33, 34
Warranty35

Owner's Manual

JGRP17



**IMPORTANT SAFETY INFORMATION.
READ ALL INSTRUCTIONS BEFORE USING.**

WARNING: If the information in this manual is not followed exactly, a fire or explosion may result causing property damage, personal injury or death.

- Do not store or use gasoline or other flammable vapors and liquids in the vicinity of this or any other appliance.
- **WHAT TO DO IF YOU SMELL GAS**
 - Do not try to light any appliance.
 - Do not touch any electrical switch; do not use any phone in your building.
 - Immediately call your gas supplier from a neighbor's phone. Follow the gas supplier's instructions.
 - If you cannot reach your gas supplier, call the fire department.
- Installation and service must be performed by a qualified installer, service agency or the gas supplier.



IMPORTANT!

Fill out the Consumer Product Registration Card.

Two easy ways to register your appliance!

- Through the internet at www.geappliances.com
- Complete and mail the enclosed Product Registration Card



FOR YOUR RECORDS

Write the model and serial numbers here:

You can find them on a label on the front of the oven behind the door.

Staple sales slip or cancelled check here.

Proof of the original purchase date is needed to obtain service under the warranty.



READ THIS MANUAL

Inside you will find many helpful hints on how to use and maintain your oven properly. Just a little preventive care on your part can save you a great deal of time and money over the life of your oven.



IF YOU NEED SERVICE

You'll find many answers to common problems in the *Before You Call For Service* section. If you review our chart of *Troubleshooting Tips* first, you may not need to call for service at all.

If you do need service, you can relax knowing help is only a phone call away. A list of toll-free customer service numbers is included in the back section of this manual. Or, in the United States, you can always call the GE Answer Center® at 800.626.2000, 24 hours a day, 7 days a week.

OR

Visit our Website at: www.geappliances.com



REMOVAL OF PACKAGING TAPE

To remove the adhesive residue left from packaging tape, use household dishwashing liquid, mineral oil or cooking oil. With a soft cloth, rub into the area and allow to soak. Rinse and dry well. Repeat procedure using an appliance polish to insure no damage is done to the oven. Packaging tape can be found in the following areas: Control Panel Area, Door Handle, Door Trim and Oven Area.

NOTE: This should be done before the oven is turned on for the first time. The tape cannot be removed once the oven has heated.

IMPORTANT SAFETY INFORMATION. READ ALL INSTRUCTIONS BEFORE USING.

⚠ WARNING!

For your safety, the information in this manual must be followed to minimize the risk of fire or explosion, electric shock, or to prevent property damage, personal injury or loss of life.



IMPORTANT SAFETY NOTICE

The California Safe Drinking Water and Toxic Enforcement Act requires the Governor of California to publish a list of substances known to the state to cause birth defects or other reproductive harm, and requires businesses to warn customers of potential exposure to such substances.

Gas appliances can cause minor exposure to four of these substances, namely benzene, carbon monoxide, formaldehyde and soot, caused primarily by the incomplete combustion of natural gas or LP fuels. Properly adjusted burners, indicated by a bluish rather than a yellow flame, will minimize incomplete combustion. Exposure to these substances can be minimized by venting with an open window or using a ventilation fan or hood.



SAFETY PRECAUTIONS

Have the installer show you the location of the oven gas shut-off valve and how to shut it off if necessary.

- Have your oven installed and properly grounded by a qualified installer, in accordance with the Installation Instructions. Any adjustment and service should be performed only by qualified gas oven installers or service technicians.
- Do not attempt to repair or replace any part of your oven unless it is specifically recommended in this manual. All other service should be referred to a qualified technician.
- Be sure all packaging materials are removed from the oven before operating it to prevent fire or smoke damage should the packaging material ignite.
- Do not touch the interior surface of the oven. These surfaces may be hot enough to burn even though they are dark in color. During and after use, do not touch, or let clothing or other flammable materials contact any interior area of the oven; allow sufficient time for cooling first.
Potentially hot surfaces include the oven vent openings, surfaces near the opening and crevices around the door.
- Be sure your oven is correctly adjusted by a qualified service technician or installer for the type of gas (natural or LP) that is to be used. Your oven can be converted for use with either type of gas. See the Installation Instructions.
- Be sure the oven is securely installed in a cabinet that is firmly attached to the house structure. Never allow anyone to climb, sit, stand or hang on the oven door.
- Do not leave children alone or unattended where an oven is hot or in operation. They could be seriously burned.
- Do not allow anyone to climb, stand or hang on the oven door or storage drawer. They could damage the oven.

Remember: The inside surfaces of an oven may be hot when the door is opened.

WARNING: These adjustments must be made by a qualified service technician in accordance with the manufacturer's instructions and all codes and requirements of the authority having jurisdiction. Failure to follow these instructions could result in serious injury or property damage. The qualified agency performing this work assumes responsibility for the conversion.

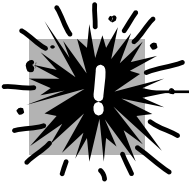

SAFETY PRECAUTIONS

- **CAUTION:** Items of interest to children should not be stored in cabinets above an oven—children climbing on the oven to reach items could be seriously injured.
- For your safety, never use your appliance for warming or heating the room.
- Never wear loose fitting or hanging garments while using the appliance. Be careful when reaching for items stored in cabinets over the oven. Flammable material could be ignited if brought in contact with flame or hot oven surfaces and may cause severe burns.
- Do not store flammable materials in the oven or storage drawer.
- Do not store or use combustible materials, gasoline or other flammable vapors and liquids in the vicinity of this or any other appliance.
- Do not let cooking grease or other flammable materials accumulate in or near the oven.
- Do not use water on grease fires. Smother fire or flame or use a multi-purpose dry chemical or foam-type fire extinguisher. Flame in the oven can be smothered completely by closing the oven door and turning the oven off or by using a multi-purpose dry chemical or foam-type fire extinguisher.
- Use only dry pot holders—moist or damp pot holders on hot surfaces may result in burns from steam. Do not let pot holders come near open flames when lifting cookware. Do not use a towel or other bulky cloth. Such cloths can catch fire on a hot burner.
- Always keep dish towels, dish cloths, pot holders and other linens a safe distance from your oven.
- Always keep wooden and plastic utensils and canned food a safe distance away from your oven.
- Do not leave paper products, cooking utensils or food in the oven when not in use.



COOK MEAT AND POULTRY THOROUGHLY...

Cook meat and poultry thoroughly—meat to at least an INTERNAL temperature of 160°F. and poultry to at least an INTERNAL temperature of 180°F. Cooking to these temperatures usually protects against foodborne illness.



OVEN

Stand away from the oven when opening the door of a hot oven. The hot air and steam that escape can cause burns to hands, face and eyes.

- Do not use the oven for a storage area. Items stored in the oven can ignite.
- Keep the oven vent ducts unobstructed.
- Keep the oven free from grease buildup.
- Place the oven shelves in the desired position while the oven is cool.
- Pulling out the shelf to the stop-lock is a convenience in lifting heavy foods. It is also a precaution against burns from touching hot surfaces of the door or oven walls.
- Do not heat unopened food containers. Pressure could build up and the container could burst, causing an injury.
- Never use aluminum foil to line the oven bottom. Improper use of foil could start a fire.
- Do not use aluminum foil anywhere in the oven except as described in this manual. Misuse could result in a fire hazard or damage to the oven.
- When using cooking or roasting bags in the oven, follow the manufacturer's directions.
- Do not use your oven to dry newspapers. If overheated, they can catch fire.
- Use only glass cookware that is recommended for use in gas ovens.

IMPORTANT SAFETY INFORMATION. READ ALL INSTRUCTIONS BEFORE USING.



OVEN

- Always remove the broiler pan from oven as soon as you finish broiling. Grease left in the pan can catch fire if oven is used without removing the grease from the broiler pan.
- When broiling, if meat is too close to the flame, the fat may ignite. Trim excess fat to prevent excessive flare-ups.
- Make sure the broiler pan is in place correctly to reduce the possibility of grease fires.
- If you should have a grease fire in the broiler pan, turn the oven off, and keep the oven door closed to contain fire until it burns out.
- Never leave jars or cans of fat drippings in or near your oven.



SELF-CLEANING OVEN

- Be sure to wipe up excess spillage before self-cleaning operation.
- Before self-cleaning the oven, remove the shelves, broiler pan, grid and other cookware.
- Do not clean the door gasket. The door gasket is essential for a good seal. Care should be taken not to rub, damage or move the gasket.
- Clean only parts listed in this Owner's Manual.
- If the self-cleaning mode malfunctions, turn the oven off and disconnect the power supply. Have it serviced by a qualified technician.
- Do not use oven cleaners. No commercial oven cleaner or oven liner of any kind should be used in or around any part of the oven. Residue from oven cleaners will damage the inside of the oven when the self-clean cycle is used.



READ AND FOLLOW THIS SAFETY INFORMATION CAREFULLY.

SAVE THESE INSTRUCTIONS

Using the oven controls.

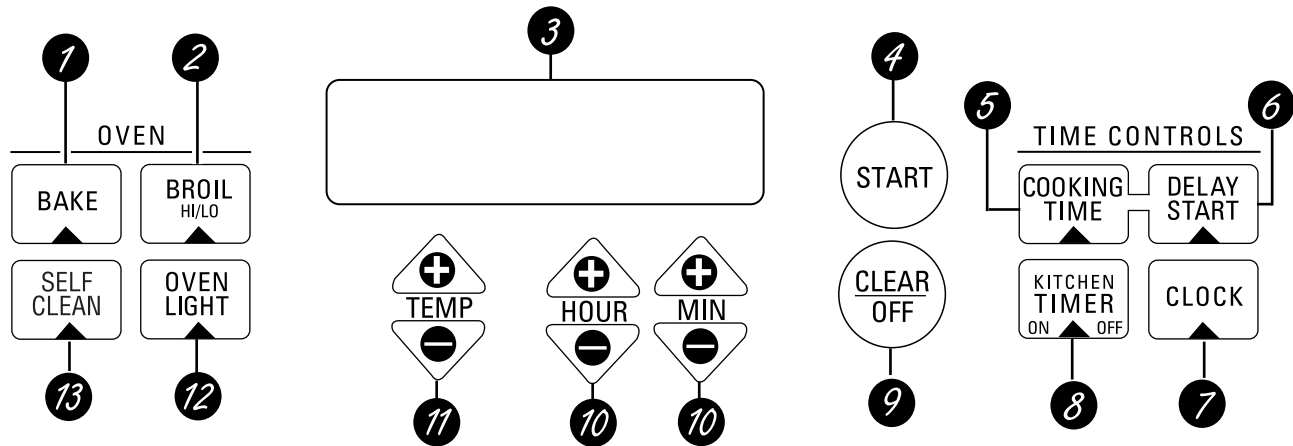

Oven Control, Clock and Timer Features and Settings



- 1** **BAKE Pad**
Touch this pad to select the bake function.
- 2** **BROIL HI/LO Pad**
Touch this pad to select the broil function.
- 3** **Display**
Shows the operations you have selected, the time of day and the cooking status.
- 4** **START Pad**
Must be touched to start any cooking or cleaning function.
- 5** **COOKING TIME Pad**
Touch this pad and then the **HOUR** and **MIN** pads to set the amount of time you want your food to cook. The oven will shut off when the cooking time has run out.
- 6** **DELAY START Pad**
Use along with the **COOKING TIME** or **SELF CLEAN** pads to set the oven to start and stop automatically at a time you set.
- 7** **CLOCK Pad**
Touch this pad to enter the time of day.
- 8** **KITCHEN TIMER ON/OFF Pad**
Touch this pad to select the timer feature. The timer does not control oven operations. The timer can time up to 9 hours and 59 minutes.
- 9** **CLEAR/OFF Pad**
Touch this pad to cancel **ALL** oven operations except the clock and timer.
- 10** **HOUR +/- and MIN +/- Pads**
Touch these pads to set times up to 9 hours and 59 minutes—for example, the time of day on the clock, the timer, the starting and length of cooking time for Timed Bake and the starting and length of cleaning time for Self-Clean.
- 11** **TEMP +/- Pads**
Touch these pads to set the cooking temperature you want to use.
- 12** **OVEN LIGHT ON/OFF Pad**
Touch this pad to turn the oven light on or off.
- 13** **SELF CLEAN Pad**
Touch this pad to select the self-cleaning function. See the *Using the self-cleaning oven* section.

If "F— and a number or letter" flash in the display and the oven control signals, this indicates a function error code.

Touch the **CLEAR/OFF** pad. Allow the oven to cool for one hour. Put the oven back into operation.

If function error code repeats, disconnect power to the oven and call for service.

Using the clock and timer.

Clock

The clock must be set for the automatic oven timing functions to work properly.

The time of day clock **cannot** be changed during Delay Start. (It can be changed during a regular bake or broil operation.)

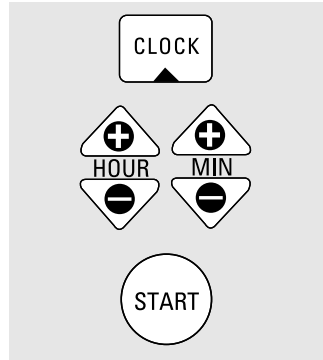

To Set the Clock

- 1 Touch the **CLOCK** pad.
- 2 Touch the **HOUR** and **MIN +/-** pads to set the time of day.
- 3 Touch the **START** pad. This enters the time and starts the clock.

To check the time of day when the display is showing other information, simply touch the **CLOCK** pad. The time of day shows until another pad is touched.

Timer

You may program the timer to time cooking or other household activities for up to 9 hours and 59 minutes.

The timer counts down in minutes, 1 minute at a time, until the last 60 seconds are reached, then the control will beep one time. The sections will not be displayed until the last minute is reached.

When the timer reaches “:00”, the control will beep 3 times followed by one beep every 6 seconds until **KITCHEN TIMER ON/OFF** is touched.

The 6-second tone can be canceled by following the steps in the *Special Features of Your Oven Control* section under Tones at the End of a Timed Cycle.

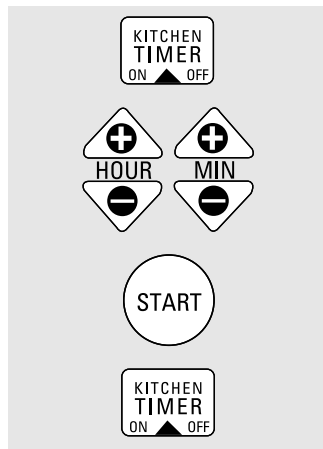

How to Set the Timer

- 1 Touch the **KITCHEN TIMER ON/OFF** pad.
- 2 Touch the **HOUR** and **MIN +/-** pads until the amount of time you want shows in the display.

If you make a mistake, touch the **KITCHEN TIMER ON/OFF** pad and begin again.

- 3 Touch the **START** pad.

After touching the **START** pad, **SET** disappears; this tells you the time is counting down, although the display does not change until one minute has passed.

- 4 When time is up, the oven control signals until you touch the **KITCHEN TIMER ON/OFF** pad. Display then shows the time of day.

NOTE: The minute timer is independent of all the other functions and it does not control the oven. The **CLEAR/OFF** pad does not affect the timer.

Power Failure

If a flashing time of day is in the display, you have experienced a power failure. Reset the clock.

To reset the clock, touch the **CLOCK** pad. Enter the correct time of day by touching the **HOUR** and **MIN +/-** pads. Touch the **START** pad.

The control has a series of tones that will sound at different times. These tones may sound while you set the control for an oven function or at the end of the oven function. They will also alert you when an incorrect time or temperature has been entered or if there is a problem with the oven.

Tones While Setting the Control

When you touch a touch pad you will hear a beep. This beep will let you know you have placed enough pressure on the pad to activate it.

Attention Tone

This tone will sound if you set an invalid function or try to set an additional function. The tone can be quickly identified by watching the display messages.

Preheat Notification Tone

When you set an oven temperature the oven automatically starts to heat. When the temperature inside the oven reaches your set temperature a tone will sound to let you know to place the food in the oven.

Special features of your oven control.

Your new touch pad control has additional features that you may choose to use. The following are the features and how you may activate them.

The special feature modes can only be activated while the display is showing the time of day clock. They remain in the control's memory until the steps are repeated.

When the display shows your choice, touch the **START** pad. The special features will remain in memory after a power failure.

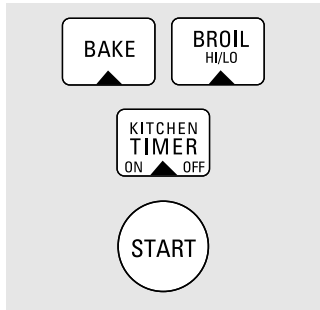

Tones at the End of a Timed Cycle

At the end of a timed cycle, 3 short beeps will sound followed by one beep every 6 seconds, until the **CLEAR/OFF** pad is touched. This continuous 6-second beep may be canceled.

To cancel the 6-second beep:

- 1 Touch the **BAKE** and **BROIL HI/LO** pads at the same time for 2 seconds until the display shows **SF**.

- 2 Touch the **KITCHEN TIMER ON/OFF** pad. The display shows **CON BEEP** (continuous beep). Touch the **KITCHEN TIMER ON/OFF** pad again. The display shows **BEEP**. (This cancels the one beep every 6 seconds.)

- 3 Touch the **START** pad.

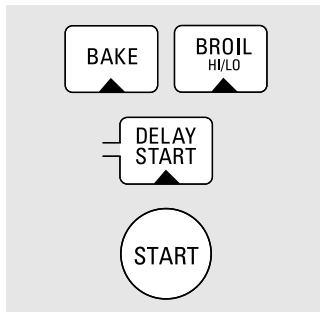

12-Hour Shut-Off

With this feature, should you forget and leave the oven on, the control will automatically turn off the oven after 12 hours during baking functions or after 3 hours during a broil function.

If you wish to turn **OFF** this feature, follow the steps below:

- 1 Touch the **BAKE** and **BROIL HI/LO** pads at the same time for 2 seconds until the display shows **SF**.

- 2 Touch the **DELAY START** pad. The display will show **12 shdn** (12 hour shut-off). Touch the **DELAY START** pad again and the display will show **no shdn** (no shut-off).

- 3 Touch the **START** pad to activate the no shut-off and leave the control set in this special features mode.

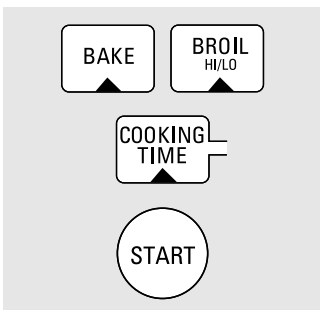

Cook and Hold

Your new control has a cook and hold feature that keeps cooked foods warm for up to 3 hours after the cooking function is finished.

To activate this feature, follow the steps below:

- 1 Touch the **BAKE** and **BROIL HI/LO** pads at the same time for 2 seconds until the display shows **SF**.

- 2 Touch the **COOKING TIME** pad. The display will show **Hid OFF**.

Touch the **COOKING TIME** pad again to activate the feature. The display will show **Hid ON**.

- 3 Touch the **START** pad to activate the cook and hold feature and leave the control set in this special features mode.

12-Hour, 24-Hour or Clock Black-Out

Your control is set to use a 12-hour clock.

If you would prefer to have a 24-hour military time clock or black-out the clock display, follow the steps below:

- 1 Touch the **BAKE** and **BROIL HI/LO** pads at the same time for 2 seconds until the display shows **SF**.
- 2 Touch the **CLOCK** pad once. The display will show **12 hr**.

Touch the **CLOCK** pad again to change to the 24-hour military time clock. The display will show **24 hr**.

Touch the **CLOCK** pad again to black-out the clock display. The display will show **OFF**.

- 3 Touch the **START** pad to activate your choice and leave the control set in this special features mode.

NOTE: If the clock is in the black-out mode you will not be able to use the Delay Start function.

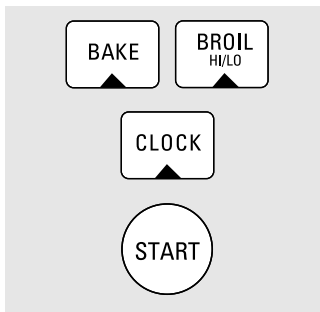

Control Lockout

Your control will allow you to lock out the touch pads so they cannot be activated when touched.

To lock the controls:

- 1 Touch the **BAKE** and **BROIL HI/LO** pads at the same time for 2 seconds until the display shows **SF**.
- 2 Touch the **SELF CLEAN** pad. The display will show **LOC OFF**.

Touch the **SELF CLEAN** pad again. The display will show **LOC**.

- 3 Touch the **START** pad to activate the control lockout feature and leave the control set in this special features mode.

When this feature is on and the touch pads are touched the control will beep and the display will show **LOC**.

NOTE: The control lockout mode will not affect the clock, timer and oven light touch pads.

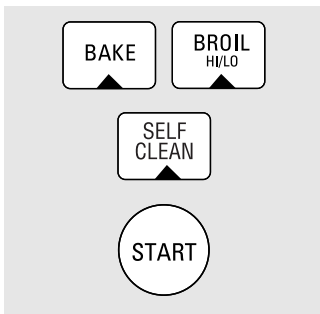

Fahrenheit or Centigrade Temperature Selection

Your oven control is set to use the Fahrenheit temperature selections but you may change this to use the Centigrade selections.

- 1 Touch the **BAKE** and **BROIL HI/LO** pads at the same time for 2 seconds until the display shows **SF**.
- 2 Touch the **BROIL HI/LO** pad. The display will show **F** (Fahrenheit).

- 3 Touch the **BROIL HI/LO** pad again. The display will show **C** (Centigrade).

- 4 Touch the **START** pad.

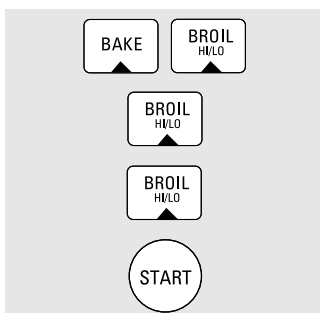

Changing the Speed of the +/- Pads

As you use the +/- pads when setting a time or temperature, you may notice the display changes slowly. This special feature allows you to change the speed.

To set the speed you prefer, follow the steps below:

- 1 Touch the **BAKE** and **BROIL HI/LO** pads at the same time for 2 seconds until the display shows **SF**.
- 2 Touch the **+** pad. The display will show you a set speed between 1 and 5.

- 3 Touch the **+** pad to increase the speed up to the number 5.

Touch the **-** pad to decrease the speed down to the number 1.

- 4 Touch the **START** pad to activate the setting and leave the control set in this special features mode.

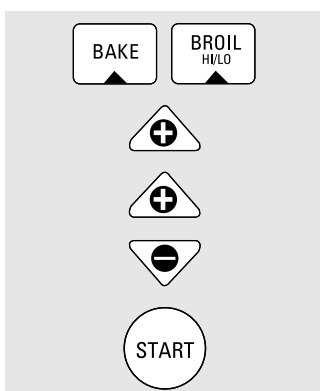

Using the oven.

Before you begin...

- 1 Look at the controls. Be sure you understand how to set them properly.
- 2 Check the oven interior. Look at the shelves. Take a practice run at removing and replacing them properly to give sure, sturdy support.
- 3 Read over the information and tips that follow.
- 4 Keep this guide handy so you can refer to it, especially during the first weeks of using your new oven.

NOTES:

- You may notice a "burning" or "oily" smell the first few times you turn your oven on. This is normal in a new oven and will disappear in a short time. To speed the process, set a Self-Clean cycle for 4 hours. See the Using the Self-Cleaning Oven section.
- A cooling fan may automatically turn on and off to cool internal parts. This is normal, and the fan may continue to run even after the oven is turned off.

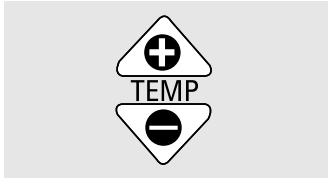

Automatic Ignition

The oven burner is lit by electric ignition.

To light the burner, do the following:

- 1 Touch the pad for the desired function. Then touch the **TEMP +/-** pads until the desired temperature is displayed. The burner should ignite within 60 seconds.

After the oven reaches the selected temperature, the oven burner cycles off completely, then on with a full flame to keep the oven temperature controlled.

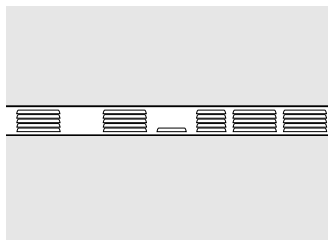

Oven Vent

When the oven is on, heated air moves through a vent behind the grille.

The vent area could get hot during oven use.

The vent is needed for proper air flow in the oven and good baking results. Do not block this vent. Doing so may cause oven failure or fire.

Power Outage

The oven burner will not light in the event of an electrical power outage.

CAUTION: Do not attempt to light it manually with a match.



Oven Light

Touch the **OVEN LIGHT** pad to turn the light on or off.

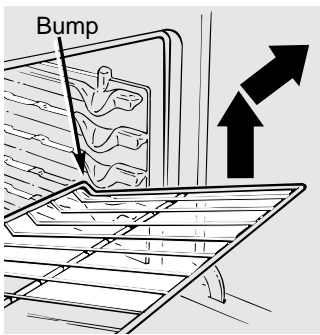

Oven Shelves

The shelves are designed with stop-locks so that, when placed correctly on the shelf supports, they will stop before coming completely out of the oven and will not tilt when you are removing food from them or placing food on them.

When placing cookware on a shelf, pull the shelf out to the bump on the shelf support. Place the cookware on the shelf, then slide the shelf back into the oven. This will eliminate reaching into the hot oven.

To remove a shelf from the oven, pull the shelf toward you, tilt the front end upward and pull the shelf out.

To replace, place the shelf on the shelf support with the stop-locks (curved extension of the shelf) facing up and toward the rear of the oven. Tilt up the front and push the shelf toward the back of the oven until it goes past the bump on the shelf support. Then lower the front of the shelf and push it all the way back.

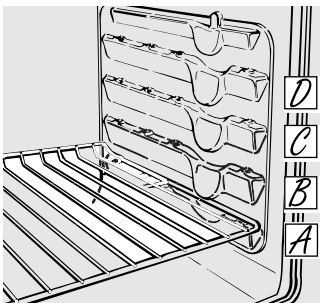

Shelf Positions

The oven has 4 shelf supports, identified in this illustration as A (bottom), B, C and D (top).

Shelf positions for cooking are suggested in the *Baking*, *Roasting* and *Broiling* sections.

Oven Moisture

As your oven heats up, the changing temperature of the air in the oven may cause water droplets to form on the door glass. These droplets are harmless and will evaporate as the oven continues to heat up.

Using the baking feature.

Your oven temperature is controlled very accurately using an oven control system. It is recommended that you operate the oven for a number of weeks using the time given on recipes as a guide to become familiar with your new oven's performance.

If you think an adjustment is necessary, see the *Adjust the Oven Thermostat* section. It lists easy *Do It Yourself* instructions on how to adjust the thermostat.

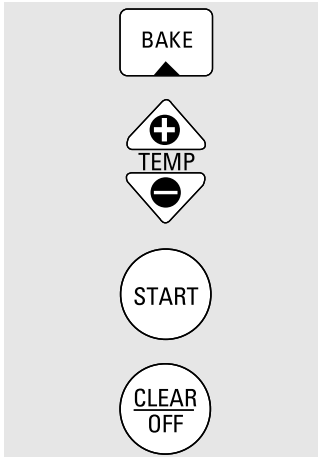

How to Set Your Oven for Baking

To avoid possible burns, place the shelves in the correct position before you turn the oven on.

- 1 Touch the **BAKE** pad.
- 2 Touch the **TEMP +/-** pads to set the oven temperature.
- 3 Touch the **START** pad.

When the oven starts to heat, the changing temperature will be in the display. (The display starts changing once the temperature reaches 100°F.)

To change the oven temperature during the Bake cycle, touch the **BAKE** pad and set the new temperature.

- 4 Touch the **CLEAR/OFF** pad when the baking is finished.

NOTE: A cooling fan may automatically turn on and off to cool internal parts. This is normal, and the fan may continue to run even after the oven is turned off.

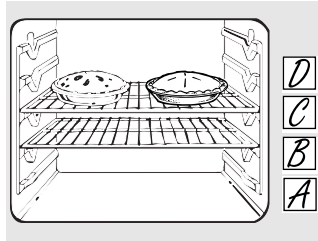

Oven Shelves

Arrange the oven shelf or shelves in the desired locations while the oven is cool. The correct shelf position depends on the kind of food and the browning desired.

As a general rule, place most foods in the middle of the oven, on either shelf position **B** or **C**. See the chart for suggested shelf positions.

Type of Food	Shelf Position
Angel food cake	A
Frozen pies (on cookie sheet)	A
Bundt or pound cakes	A or B
Roasting	A or B
Biscuits, muffins, brownies, cookies, cupcakes, layer cakes, pies, pie shells	B or C
Casseroles	B or C

Preheating

Preheat the oven if the recipe calls for it. Preheat means bringing the oven up to the specified temperature before putting the food in the oven. To preheat, set the oven at the correct temperature—selecting a higher temperature does not shorten preheat time.

Preheating is necessary for good results when baking cakes, cookies, pastry and breads. For most casseroles and roasts, preheating is not necessary. For ovens without a preheat indicator light or tone, preheat 10 minutes. After the oven is preheated, place the food in the oven as quickly as possible to prevent heat from escaping.

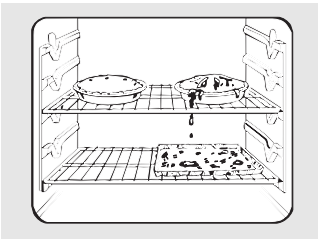

Aluminum Foil

Never entirely cover a shelf with aluminum foil. This will disturb the heat circulation and result in poor baking. A smaller sheet of foil may be used to catch a spillover by placing it on a lower shelf several inches below the food.

Baking Pans

Use the proper baking pan. The type of finish on the pan determines the amount of browning that will occur.

- Dark, rough or dull pans absorb heat resulting in a browner, crisper crust. Use this type for pies.
- Shiny, bright and smooth pans reflect heat, resulting in a lighter, more delicate browning. Cakes and cookies require this type of pan.
- Glass baking dishes also absorb heat. When baking in glass baking dishes, the temperature may need to be reduced by 25°F.
- If you are using dark non-stick pans, you may find that you need to reduce the oven temperature 25°F. to prevent over-browning.

Pan Placement

For even cooking and proper browning, there must be enough room for air circulation in the oven. Baking results will be better if baking pans are centered as much as possible rather than being placed to the front or to the back of the oven.

Pans should not touch each other or the walls of the oven. Allow 1- to 1½-inch space between pans as well as from the back of the oven, the door and the sides. If you need to use two shelves, stagger the pans so one is not directly above the other.

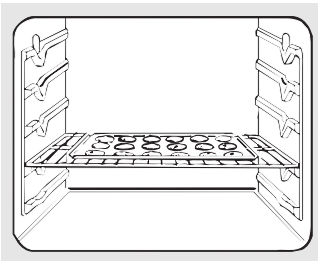

Cookies

When baking cookies, flat cookie sheets (without sides) produce better-looking cookies. Cookies baked in a jelly roll pan (short sides all around) may have darker edges and pale or light browning may occur.

Do not use a cookie sheet so large that it touches the walls or the door of the oven. Never entirely cover a shelf with a large cookie sheet.

For best results during baking, use only one cookie sheet in the oven at a time.

Pies

For best results, bake pies in dark, rough or dull pans to produce a browner, crisper crust. Frozen pies in foil pans should be placed on an aluminum cookie sheet for baking since the shiny foil pan reflects heat away from the pie crust; the cookie sheet helps retain it.

Cakes

When baking cakes, warped or bent pans will cause uneven baking results and poorly shaped products. A cake baked in a pan larger than the recipe recommends will usually be crisper, thinner and drier than it should be. If baked in a pan smaller than recommended, it may be undercooked and batter may overflow. Check the recipe to make sure the pan size used is the one recommended.

Peeking

Set the timer for the estimated cooking time and do not open the door to look at your food. Most recipes provide minimum and maximum baking times such as “bake 30-40 minutes.”

DO NOT open the door to check until the minimum time. Opening the oven door frequently during cooking allows heat to escape and makes baking times longer. Your baking results may also be affected.

Using the timed baking feature.

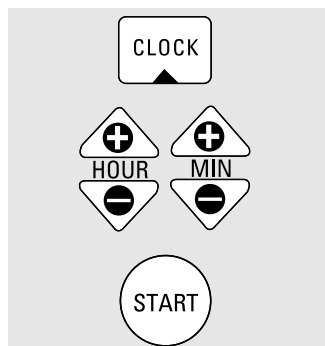

How to Set Your Oven for Time Bake

The oven control allows you to turn the oven on or off automatically at specific times that you set. Examples of Immediate Start (oven turns on now and you set it to turn off automatically at the end of cooking time) and Delay Start and Stop (setting the oven to turn on automatically at a later time and turn off after a preset cooking time) will be described.

NOTE: Before beginning, make sure the clock shows the correct time of day.

To set the clock, do the following:

- 1 Touch the **CLOCK** pad.
- 2 Touch the **HOUR** and **MIN +/-** pads to set the time of day.
- 3 Touch the **START** pad.

NOTE: An attention tone will sound if you are using Timed Baking and do not touch the **START** pad after entering the baking temperature.

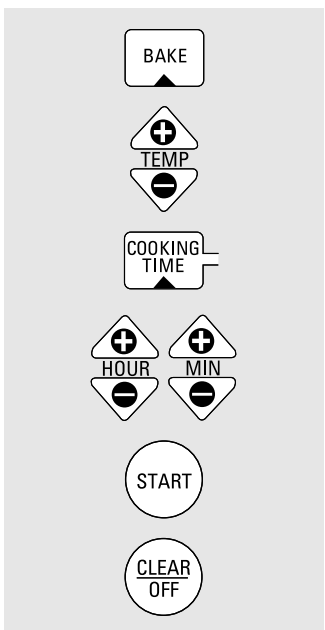

How to Set Immediate Start and Automatic Stop

CAUTION: To avoid possible burns, place the shelves in the correct position before you turn the oven on.

The oven will turn on immediately and cook for a selected length of time. At the end of cooking time, the oven will turn off automatically.

- 1 Touch the **BAKE** pad.
- 2 Touch the **TEMP +/-** pads to set the oven temperature.
- 3 Touch the **COOKING TIME** pad.

NOTE: If your recipe requires preheating, you may need to add additional time to the length of the cooking time.

- 4 Touch the **HOUR** and **MIN +/-** pads to set the baking time.

The oven temperature and the cooking time that you entered will be displayed.

- 5 Touch the **START** pad. The display shows the oven temperature that you set and the cooking time countdown. (The display starts changing once the the temperature reaches 100°F.)

The oven will continue to cook for the programmed amount of time, then shut off automatically.

- 6 Touch the **CLEAR/OFF** pad to clear the end of cycle tone if necessary.

NOTES:

- The low temperature zone of this oven (between 170°F. and 200°F.) is available to keep hot cooked foods warm. Food kept in the oven longer than two hours at these low temperatures may spoil.
- Foods that spoil easily, such as milk, eggs, fish, stuffings, poultry and pork, should not be allowed to sit for more than one hour before or after cooking. Room temperature promotes the growth of harmful bacteria. Be sure the oven light is off because heat from the bulb will speed harmful bacteria growth.

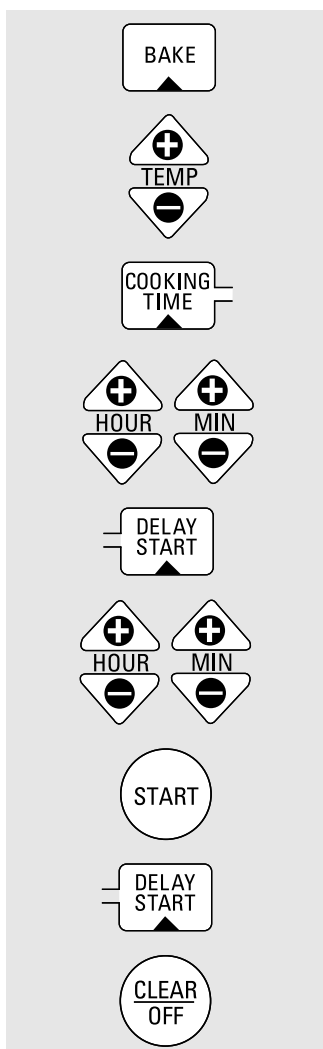

How to Set Delay Start and Automatic Stop

CAUTION: To avoid possible burns, place the shelves in the correct position before you turn the oven on.

You can set the control to delay the start of cooking, cook for a specific length of time and then turn off automatically.

- 1 Touch the **BAKE** pad.
- 2 Touch the **TEMP +/-** pads to set the oven temperature.
- 3 Touch the **COOKING TIME** pad.

NOTE: If your recipe requires preheating, you may need to add additional time to the length of the cooking time.

- 4 Touch the **HOUR** and **MIN +/-** pads to set the baking time.
- 5 Touch the **DELAY START** pad.
- 6 Touch the **HOUR** and **MIN +/-** pads to set the time of day you want the oven to turn on and start cooking.
- 7 Touch the **START** pad.

If you would like to check the times you have set, touch the **DELAY START** pad to check the start time you have set or touch the **COOKING TIME** pad to check the length of cooking time you have set.

When the oven turns on at the time of day you have set, the display will show the changing temperature (starting at 100°F.) and the cooking time countdown.

At the end of cooking time the oven will turn off and the end of cycle tone will sound.

- 8 Touch the **CLEAR/OFF** pad to clear the end of cycle tone if necessary.

NOTES:

- The low temperature zone of this oven (between 170°F. and 200°F.) is available to keep hot cooked foods warm. Food kept in the oven longer than two hours at these low temperatures may spoil.
- Foods that spoil easily, such as milk, eggs, fish, stuffings, poultry and pork, should not be allowed to sit for more than one hour before or after cooking. Room temperature promotes the growth of harmful bacteria. Be sure the oven light is off because heat from the bulb will speed harmful bacteria growth.

Adjust the oven thermostat—Do it yourself!

You may find that your new oven cooks differently than the one it replaced. Use your new oven for a few weeks to become more familiar with it. If you still think your new oven is too hot or too cold, you can adjust the thermostat yourself.

Do not use thermometers, such as those found in grocery stores, to check the temperature setting of your oven. These thermometers may vary 20–40 degrees.

NOTE: This adjustment will not affect the broiling or self-cleaning temperatures. The adjustment will be retained in memory after a power failure.

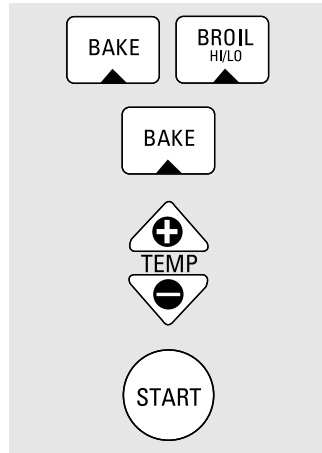

To Adjust the Thermostat

- 1 Touch the **BAKE** and **BROIL HI/LO** pads at the same time for 2 seconds until the display shows **SF**.
- 2 Touch the **BAKE** pad. A two-digit number shows in the display.
- 3 The oven temperature can be adjusted up as much as 35°F. or down as much as 35°F. Touch the **TEMP +** pad to increase the temperature in 1-degree increments. Touch the **TEMP -** pad to decrease the temperature in 1-degree increments.
- 4 When you have made the adjustment, touch the **START** pad to go back to the time of day display. Use your oven as you would normally.

The type of margarine will affect baking performance!

Most recipes for baking have been developed using high-fat products such as butter or margarine (80% fat). If you decrease the fat, the recipe may not give the same results as with a higher fat product.

Recipe failure can result if cakes, pies, pastries, cookies or candies are made with low-fat spreads. The lower the fat content of a spread product, the more noticeable these differences become.

Federal standards require products labeled “margarine” to contain at least 80% fat by weight. Low fat spreads, on the other hand, contain less fat and more water. The high moisture content of these spreads affects the texture and flavor of baked goods. For best results with your old favorite recipes, use margarine, butter or stick spreads containing at least 70% vegetable oil.

Using the roasting feature.

Roasting is cooking by dry heat. Tender meat or poultry can be roasted uncovered in your oven. Roasting temperatures, which should be low and steady, keep spattering to a minimum.

Before You Begin Roasting...

Roasting is really a baking procedure used for meats. Therefore, the oven controls are set for Baking or Timed Baking. (You may hear a slight clicking sound, indicating the oven is working properly.) Timed Baking will turn the oven on and off automatically.

Most meats continue to cook slightly after being removed from the oven. The internal temperature will rise about 5° to 10°F. during the recommended standing time of 10 to 20 minutes. This allows roasts to firm up and makes them easier to carve.

To compensate for this rise in temperature, you may want to remove the roast sooner (at 5° to 10°F. less than the temperature in the Roasting Guide).

REMEMBER: Food will continue to cook in the hot oven and therefore should be removed when the desired internal temperature has been reached.

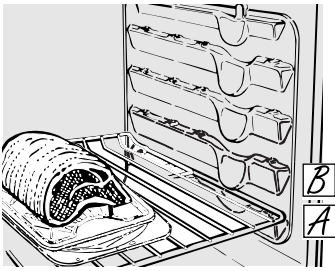

How to Set Your Oven for Roasting

- 1 Place the shelf in **A** or **B** position. No preheating is necessary.
- 2 Check the weight of the meat. Place the meat fat side up, or poultry breast side up, on roasting grid in a shallow pan. The melting fat will baste the meat. Select a pan as close to the size of the meat as possible. (The broiler pan with grid is a good pan for this.)

- 3 Touch the **BAKE** pad.

To change the oven temperature during the roasting cycle, touch the **BAKE** pad and set the new temperature.

- 4 Touch the **TEMP +/-** pad to set the oven temperature.
- 5 Touch the **START** pad.
- 6 Touch the **CLEAR/OFF** pad when roasting is finished.

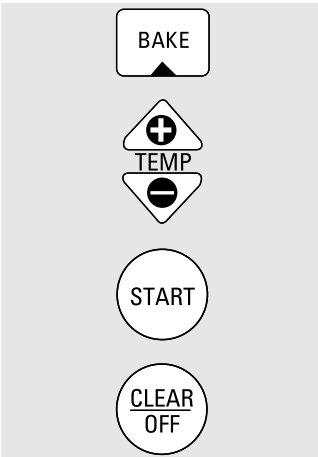

Aluminum Foil

You can use aluminum foil to line the broiler pan. This makes clean-up easier when using the pan for marinating, cooking with fruits, cooking heavily cured meats or basting food during cooking. Press the foil tightly around the inside of the pan.

Using the roasting feature.

Questions and Answers

Q. Is it necessary to check for doneness with a meat thermometer?

A. Checking the finished internal temperature at the completion of cooking time is recommended. Temperatures are shown in the Roasting Guide. For roasts over 8 lbs. check with thermometer at half-hour intervals after half the cooking time has passed.

Q. Why is my roast crumbling when I try to carve it?

A. Roasts are easier to slice if allowed to cool 10 to 20 minutes after removing them from the oven. Be sure to cut across the grain of the meat.

Q. Do I need to preheat my oven each time I cook a roast or poultry?

A. It is not necessary to preheat your oven.

Q. When buying a roast, are there any special tips that would help me cook it more evenly?

A. Yes. Buy a roast as even in thickness as possible, or buy rolled roasts.

Q. Can I seal the sides of my foil "tent" when roasting a turkey?

A. Sealing the foil will steam the meat. Leaving it unsealed allows the air to circulate and brown the meat.

Frozen roasts of beef, pork, lamb, etc., can be started without thawing, but allow 10 to 25 minutes per pound additional time (10 minutes per pound for roasts under 5 pounds, more time for larger roasts).

Make sure poultry is thawed before roasting. Unthawed poultry often does not cook evenly. Some commercial frozen poultry can be cooked successfully without thawing. Follow the directions given on the package label.

Roasting Guide

Type	Oven Temperature	Doneness	Approximate Roasting Time in Minutes per Pound		Internal Temperature °F.
Meat			3 to 5 lbs.	6 to 8 lbs.	
Tender cuts; rib, high quality sirloin tip, rump or top round†	325°	Rare: Medium: Well Done:	24–33 35–39 40–45	18–22 22–29 30–35	140°–150°* 150°–160° 170°–185°
Lamb leg or bone-in shouldert	325°	Rare: Medium: Well Done:	21–25 25–30 30–35	20–23 24–28 28–33	140°–150°* 150°–160° 170°–185°
Veal shoulder, leg or loin†	325°	Well Done:	35–45	30–40	170°–180°
Pork loin, rib or shouldert	325°	Well Done:	35–45	30–40	170°–180°
Ham, precooked	325°	To Warm:	17–20 minutes per pound (any weight)		115°–125°
Poultry			3 to 5 lbs.	Over 5 lbs.	
Chicken or Duck	325°	Well Done:	35–40	30–35	185°–190°
Chicken pieces	350°	Well Done:	35–40		185°–190°
Turkey	325°	Well Done:	10 to 15 lbs. 18–25	Over 15 lbs. 15–20	In thigh: 185°–190°

†For boneless rolled roasts over 6 inches thick, add 5 to 10 minutes per pound to times given above.

*The U.S. Department of Agriculture says "Rare beef is popular, but you should know that cooking it to only 140°F. means some food poisoning organisms may survive." (Source: *Safe Food Book. Your Kitchen Guide.* USDA Rev. June 1985.)

Using the broiling feature.

Broiling is cooking food by direct heat from above the food. Most fish and tender cuts of meat can be broiled. Follow these directions to keep spattering and smoking to a minimum.

Before You Begin Broiling...

If the meat has fat or gristle around the edge, cut vertical slashes through it about 2" apart. If desired, the fat may be trimmed, leaving a layer about 1/8" thick.

Place the meat on the broiler grid in the broiler pan. Always use the grid so the fat drips into the broiler pan; otherwise the juices may become hot enough to catch on fire.

Position the broiler pan on a shelf on the recommended shelf position as suggested in the Broiling Guide. **Place the sump area of the broiler pan to the front of the door.**

NOTE: Always broil with the oven door closed.

Turn the food using tongs only once during broiling. Time the foods for the first side according to the Broiling Guide.

Turn the food, then use the times given for the second side as a guide to the preferred doneness.

To test if your broiler is working properly: Cover the entire broiler pan grid with bread. Place the broiler pan on the third shelf from the bottom. Broil until the bread is golden brown. If you have browning on both sides of the pan, your broiler is working properly. If toast browns only on one side of the pan, call for service.

BROIL
HI/LO

START

CLEAR
OFF

How to Set Your Oven for Broiling

- 1 Touch the **BROIL HI/LO** pad.
- 2 Touch the **BROIL HI/LO** pad again (alternates between **LO Broil** and **HI Broil**).
- 3 Touch the **START** pad.
- 4 Touch the **CLEAR/OFF** pad when broiling is finished.

Use of Aluminum Foil

You can use aluminum foil to line your broiler pan and broiler grid. However, you must mold the foil tightly to the grid and cut slits in it just like the grid.

Without the slits, the foil will prevent fat and meat juices from draining into the broiler pan. The juices could become hot enough to catch on fire. If you do not cut the slits, you are frying, not broiling.

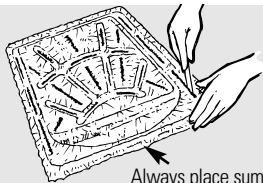

Always place sump to the front of the door.

Questions and Answers

Q. Are there blue flames on both sides of the broil burner?

A. Yes, but the bright orange glow of the burner igniter may make the flame difficult to see. If you cannot see the flame on both sides and feel your broil burner is not functioning properly, try the "toast test."

Q. When broiling, is it necessary to always use a grid in the pan?

A. Yes. Using the grid suspends the meat over the pan. As the meat cooks, the juices fall into the pan, thus keeping

meat drier. Juices are protected by the grid and stay cooler, thus preventing excessive spatter and smoking.

Q. Should I salt the meat before broiling?

A. No. Salt draws out the juices and allows them to evaporate. Always salt after cooking. Piercing the meat with a fork allows juices to escape. Turn the meat with tongs instead of a fork.

Using the broiling feature.

- Always use the broiler pan and grid that comes with your oven. It is designed to minimize smoking and spattering by trapping the juices in the shielded lower part of the pan.
 - When arranging the food on the pan, do not let fatty edges hang over the sides because the dripping fat will soil the oven bottom.
 - The broiler does not need to be preheated. However, for very thin foods, or to increase browning, preheat if desired.
 - Use **LO Broil** to cook foods such as poultry or thick pork chops evenly without over-browning them.
 - Frozen steaks can be broiled by positioning the shelf at next lowest shelf position and increasing cooking time given in this guide 1½ times per side.
- NOTE:** Always broil with the oven door closed.
- For steaks and chops, slash fat evenly around the outside edges of the meat. To slash, cut crosswise through the outer fat surface just to the edge of the meat. Use tongs to turn the meat over to prevent piercing the meat and losing juices.
 - If desired, marinate meats or chicken before broiling. Or brush with barbecue sauce last 5 to 10 minutes only.

The size, weight, thickness, starting temperature, and your preference of doneness will affect broiling times. This guide is based on meats at refrigerator temperature.

†The U.S. Department of Agriculture says "Rare beef is popular, but you should know that cooking it to only 140°F. means some food poisoning organisms may survive." (Source: Safe Food Book, Your Kitchen Guide, USDA Rev. June 1985.)

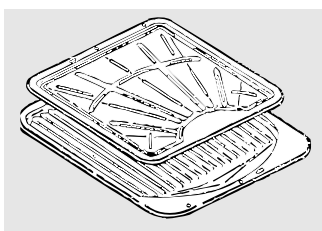

Always use the broiler pan and grid that came with your oven. It is designed to minimize smoking and spattering by trapping juices in the shielded lower part of the pan.

Broiling Guide

Food	Quantity and/or Thickness	Shelf Position	First Side Time (min.)	Second Side Time (min.)	Comments
Bacon	1/2 lb. (about 8 thin slices)	C	5	2½	Arrange in single layer.
Ground Beef Well Done	1 lb. (4 patties) 1/2 to 3/4" thick	C	8-9	6-7	Space evenly. Up to 8 patties take about the same time.
Beef Steaks					
Rare†	1" thick	B	9	7	Steaks less than 1" thick cook through before browning. Pan frying is recommended. Slash fat.
Medium	(1 to 1½ lbs.)	B	12-13	5-6	
Well Done		B	13	8-9	
Rare†	1½" thick	B	10	6-7	
Medium	(2 to 2½ lbs.)	B	15	9-12	
Well Done		B	25	16-18	
Chicken	1 whole (2 to 2½ lbs.), split lengthwise	A	28-30	18-20	Reduce times about 5 to 10 minutes per side for cut-up chicken. Brush each side with melted butter. Broil with skin-side-down first.
Bakery Products					
Bread (Toast) or Toaster Pastries	2-4 slices 1 pkg. (2)	C or D	2-3	1/2-1	Space evenly. Place English muffins cut-side-up and brush with melted butter, if desired.
English Muffins	2 split	C or D	3-4		
Lobster Tails	2-4 (6 to 8 oz. each)	C	13-16	Do not turn over.	Cut through back of shell, spread open. Brush with melted butter before broiling and after half of broiling time.
Fish Fillets	1/4 to 1/2" thick (1 lb.)	B	5	5	Handle and turn very carefully. Brush with lemon butter before and during cooking, if desired. Preheat broiler to increase browning.
Ham Slices Precooked	1" thick	C	8	8	Increase times 5 to 10 minutes per side for 1½" thick or home cured ham.
Pork Chops Well Done	2 (1½" thick) 2 (1" thick) about 1 lb.	B B	10-12 12-13	4-5 8-9	Slash fat.
Lamb Chops					
Medium	2 (1" thick)	B	8	4-7	Slash fat.
Well Done	about 10-12 oz.	B	10	10	
Medium	2 (1½" thick) about 1 lb.	B	10	4-6	
Well Done		B	17	12-14	
Wieners Similar, precooked sausages, bratwurst	10 (1 lb pkg.)	C	6	1-2	If desired, split sausages in half lengthwise; cut into 5" to 6" pieces.

Using the self-cleaning oven.

The oven door must be closed and all controls set correctly for the cycle to work properly.

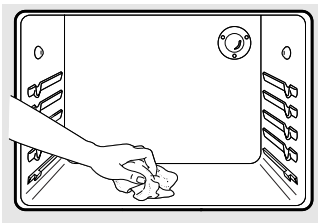

Wipe up heavy soil on the oven bottom.

Before a Clean Cycle

For the first self-clean cycle, we recommend venting your kitchen with an open window or using a ventilation fan or hood.

Remove the shelves, broiler pan, broiler grid, all cookware and any aluminum foil from the oven.

The oven shelves can be self-cleaned, but they will darken, lose their luster and become hard to slide.

Soil on the front frame of the oven and outside the gasket on the door will need to be cleaned by hand. Clean these areas with hot water, soap-filled steel-wool pads or cleansers such as Soft Scrub®. Rinse well with clean water and dry.

Do not clean the gasket. The fiberglass material of the oven door gasket cannot withstand abrasion. It is essential for the gasket to remain intact. If you notice it becoming worn or frayed, replace it.

Wipe up any heavy spillovers on the oven bottom.

Make sure the oven light bulb cover is in place and the oven light is off.

IMPORTANT: The health of some birds is extremely sensitive to the fumes given off during the self-cleaning cycle of any oven. Move birds to another well-ventilated room.

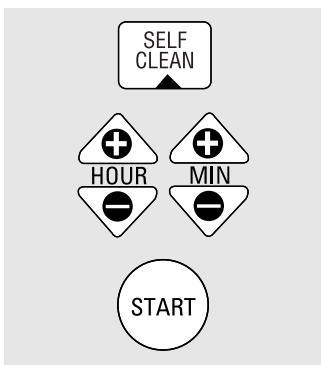

How to Set the Oven for Cleaning

- 1 Touch the **SELF CLEAN** pad.
- 2 Touch the **HOUR** and **MIN +** or **-** pads to enter the desired clean time, if a time other than 4 hours is needed.

Clean cycle time is normally 4 hours. You can change the clean time to any time between 3 hours and 5 hours, depending on how dirty your oven is.

- 3 Touch the **START** pad.

The door locks automatically. The display will show the clean time remaining. It will not be possible to open the oven door until the temperature drops below the lock temperature and the **LOCKED DOOR** light goes off.

When the **LOCKED DOOR** light is off, open the door.

The oven shuts off automatically when the clean cycle is complete.

NOTES:

- The words **LOCK DOOR** will flash and the oven control will signal if you set the clean cycle and forget to close the oven door.
- To stop a clean cycle, touch the **CLEAR/OFF** pad. When the **LOCKED DOOR** light goes off indicating the oven has cooled below the locking temperature, open the door.

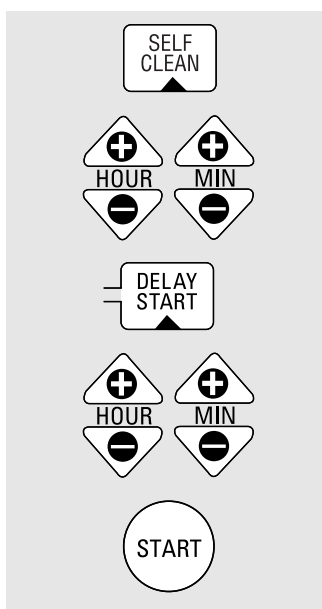

How to Delay the Start of Cleaning

Delay Start is setting the oven to start the clean cycle automatically at a later time than the present time of day.

NOTE: Before beginning, make sure the oven clock shows the correct time of day.

- 1 Touch the **SELF CLEAN** pad.
- 2 Touch the **HOUR** and **MIN +** or **-** pads to enter the desired clean time.
- 3 Touch the **DELAY START** pad. The earliest start time you can set will appear in the display.
- 4 Touch the **HOUR** and **MIN +** or **-** pads to enter the time of day you want the clean cycle to start.

- 5 Touch the **START** pad.

The door locks automatically. The display will show the start time. It will not be possible to open the oven door until the temperature drops below the lock temperature and the **LOCKED DOOR** light goes off.

When the **LOCKED DOOR** light is off, open the door.

NOTE:

- You can find out when the clean cycle will start by touching the **DELAY START** pad.

Using the self-cleaning oven.

After a Clean Cycle

You may notice some white ash in the oven. Wipe it up with a damp cloth after the oven cools.

If white spots remain, remove them with a soap-filled steel-wool pad and rinse thoroughly with a vinegar and water mixture.

These deposits are usually a salt residue that cannot be removed by the clean cycle.

If the oven is not clean after one clean cycle, repeat the cycle.

NOTES:

- You cannot set the oven for cooking until the oven is cool enough for the door to unlock.
- While the oven is self-cleaning, you can touch the **CLOCK** pad to display the time of day. To return to the clean countdown, touch the **COOKING TIME** pad.
- If you have left the shelves in the oven during the self-clean cycle and they become hard to slide, apply a small amount of vegetable oil or cooking oil to a paper towel and wipe the edges of the oven shelves with the paper towel.

Questions and Answers

Q. If my oven clock is not set to the correct time of day, can I still self-clean my oven?

A. If the clock is not set to the correct time of day you will not be able to set a delay-clean cycle to end at a specific time.

Q. Can I use commercial oven cleaners on any part of my self-cleaning oven?

A. No cleaners or coatings should be used around any part of this oven. If you do use them and do not thoroughly rinse the oven with water, wiping it absolutely clean afterwards, the residue can scar the oven surface and damage metal parts the next time the oven is automatically cleaned.

Q. What should I do if excessive smoking occurs during cleaning?

A. This is caused by excessive soil. Turn the oven off. Open the windows to rid the room of smoke. Wait until the oven has cooled and the words "LOCKED DOOR" are off in the display. Wipe up the excess soil and reset the clean cycle.

Q. Is the "crackling" or "popping" sound I hear during cleaning normal?

A. Yes. This is the sound of the metal heating and cooling during both the cooking and cleaning functions.

Q. Should there be any odor during the cleaning?

A. Yes, there will be an odor during the first few cleanings. Failure to wipe out excessive soil might also cause a strong odor when cleaning.

Q. What causes the hair-like lines on the enameled surface of my oven?

A. This is a normal condition, resulting from heating and cooling during cleaning. These lines do not affect how your oven performs.

Q. Why do I have ash left in my oven after cleaning?

A. Some types of soil will leave a deposit which is ash. It can be removed with a damp sponge or cloth.

Q. My oven shelves do not slide easily. What is the matter?

A. If you have left the oven shelves in the oven during many cleanings, the shelves will lose their luster and become hard to slide. To make shelves slide more easily wipe the shelf supports with cooking oil.

Q. I have left my oven shelves in the oven during the self-clean cycle and they have become gray. Is this normal?

A. Yes. After the self-clean cycle, the shelves will lose some luster and discolor to a deep gray color.

Care and cleaning of the oven.

Be sure electrical power is off and all surfaces are cool before cleaning any part of the oven.

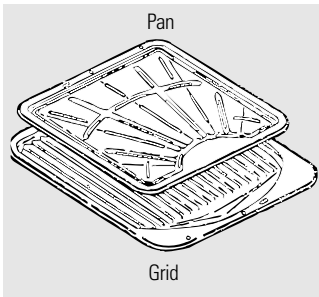

Broiler Pan and Grid

After broiling, remove the broiler pan from the oven. Remove the grid from the pan. Carefully pour out grease from the pan into a proper container. Wash and rinse the broiler pan and grid in hot water with a soap-filled or plastic scouring pad.

If food has burned on, sprinkle the grid with detergent while hot and cover with wet paper towels or a dishcloth. Soaking the pan will remove burned-on foods.

The broiler pan and grid may be cleaned with a commercial oven cleaner.

Both the broiler pan and grid can also be cleaned in a dishwasher.

Do not store a soiled broiler pan and grid anywhere in the oven.

CAUTION: Do not clean the broiler pan or grid in a self-cleaning oven.

Removable Storage Drawer

The storage drawer is a good place to store cookware and bakeware. Do not store plastics and flammable material in the drawer.

Do not overload the storage drawer. If the drawer is too heavy, it may slip off the track when opened. To open the drawer, grasp the center of the handle and pull straight out.

Most cleaning can be done with the drawer in place. However, the drawer may be removed if further cleaning is needed. Use soap and warm water to thoroughly clean.

To remove:

Pull the drawer straight out and lift over the guide stops.

To replace:

Lift over the guide stops and slide the drawer into place.

To clean both the inside and the outside:

Wipe with soap and water. Rinse well.

Do not use cleansing powders or harsh abrasives which may scratch the surface.

Oven Air Vents

Never block the vents (air openings) of the oven. They provide the air inlet and outlet that are necessary for the oven to operate properly with correct combustion.

Air openings are located under the control panel, above the door.

Oven Light Replacement

CAUTION: Before replacing your oven light bulb, disconnect the electrical power to the oven at the main fuse or circuit breaker panel. Be sure to let the light cover and bulb cool completely.

The oven light bulb is covered with a removable glass cover that is held in place with a bail-shaped wire. Remove the oven door, if desired, to reach the cover easily.

To remove:

- 1 Hold a hand under the cover so it doesn't fall when released. With fingers of the same hand, firmly push back the wire cover holder. Lift off the cover.

Do not remove any screws to remove the cover.

- 2 Do not touch hot bulb with a wet cloth. Replace bulb with a 40-watt household appliance bulb.

To replace cover:

- 1 Place it into the groove of the light receptacle. Pull the wire forward to the center of the cover until it snaps into place. When in place, the wire holds the cover firmly. Be certain the wire is in the depression in the center of the cover.
- 2 Connect electrical power to the oven.

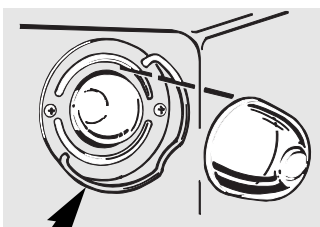
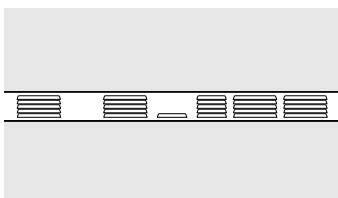

Wire cover holder

Care and cleaning of the oven.

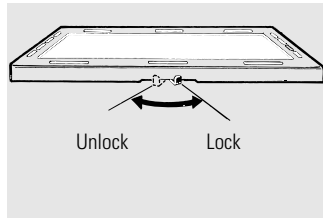

Removable Oven Bottom

The oven bottom can be removed to clean large spills, and to enable you to reach the oven burner. **Oven bottom must be replaced before using the self-clean cycle.**

To remove:

- 1 Slide the tab at the center front of the oven bottom to the left.
- 2 Lift the oven bottom up and out.

To replace:

- 1 Slip the oven bottom into the oven so the tabs in the rear of the oven bottom fit into the slots in the oven back.
- 2 Lower the front of the oven bottom into place and slide the front tab to the right to lock the oven bottom into place.

The oven bottom has a porcelain enamel finish. To make cleaning easier, protect the oven bottom from excessive spillovers by placing a cookie sheet on the shelf below the shelf you are cooking on. This is particularly important when baking a fruit pie or other foods with a high acid content. Hot fruit fillings or other foods that are highly acidic (such as tomatoes, sauerkraut, and sauces with vinegar or lemon juice) may cause pitting and damage to the porcelain enamel surface and should be wiped up immediately.

We don't recommend using aluminum foil on the oven bottom. It can affect air flow if the holes are blocked and it can concentrate heat at the bottom of the oven, resulting in poor baking performance.

To clean up spillovers, use soap and water, an abrasive cleaner or soap-filled steel-wool pad. Rinse well to remove any soap before self-cleaning.

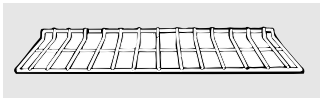

Oven Shelves

Clean the shelves with an abrasive cleanser or steel wool. After cleaning, rinse the shelves with clean water and dry with a clean cloth.

NOTE: Take the shelves out of the oven before you begin the self-clean cycle.

Control Panel

It's a good idea to wipe the control panel after each use of the oven. Clean with mild soap and water or vinegar and water, rinse with clean water and polish dry with a soft cloth.

Do not use abrasive cleansers, strong liquid cleaners, plastic scouring pads or oven cleaners on the control panel—they will damage the finish. A 50/50 solution of vinegar and hot water works well.

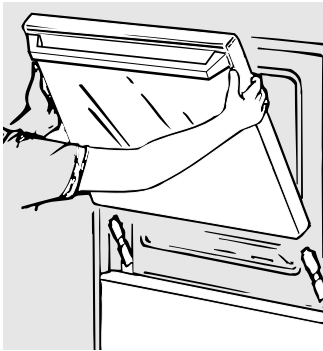

Lift the door straight up and off the hinges.

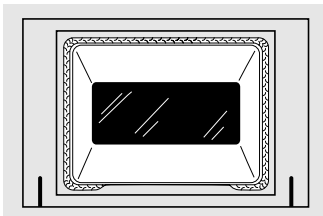

The gasket is designed with a gap at the bottom to allow for proper air circulation.

Do not rub or clean the door gasket—it has an extremely low resistance to abrasion.

If you notice the gasket becoming worn, frayed or damaged in any way or if it has become displaced on the door, you should have it replaced.

Lift-Off Oven Door

The oven door is removable, but it is heavy. You may need help removing and replacing the door. Do not lift the door by the handle. This can cause the glass to break or can cause damage to the door.

To remove the door, open it a few inches to the special stop position that will hold the door open. Grasp firmly on each side and lift the door straight up and off the hinges.

NOTES:

- Be careful not to place hands between the hinge and the oven door frame as the hinge could snap back and pinch fingers.

- While working in the oven area, cover the hinges with towels or empty paper towel rolls to prevent pinched fingers and chipping the porcelain enamel on the frame.

To replace the door, make sure the hinges are in the special stop position. Position the slots in the bottom of the door squarely over the hinges. Then lower the door slowly and evenly over both hinges at the same time. If the hinges snap back against the oven frame, pull them back out.

To clean the inside of the door:

- Do not allow excess water to run into any holes or slots in the door.
- Because the area inside the gasket is cleaned during the self clean cycle, you do not need to clean this by hand. Any soap left on the liner causes additional stains when the oven is heated.
- The area outside the gasket can be cleaned with a soap-filled steel-wool or plastic pad.

To clean the outside of the door:

- Use soap and water to thoroughly clean the top, sides and front of the oven door. Rinse well. You may also use a glass cleaner to clean the glass on the outside of the door.
- Spillage of marinades, fruit juices, tomato sauces and basting materials containing acids may cause discoloration and should be wiped up immediately. When the surface is cool, clean and rinse.
- Do not use oven cleaners, cleansing powders or harsh abrasives on the outside of the door.

Care and cleaning of the oven.

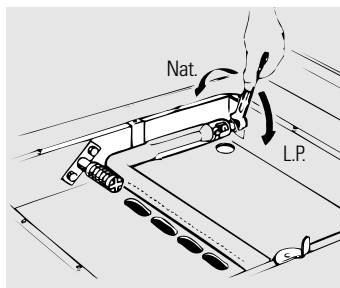

Adjusting Orifice Hoods

Check the inner cones of the flames. The inner cones of the flames should be about 1/2" long. If the flames are not right, use a 1/2" open-end wrench or adjustable joint pliers to adjust the orifice hood.

WARNING: If you attempt to measure the inner cone of the flame, please use caution. Burns could result.

To shorten the cones, tighten the orifice hood by turning in the "L.P." direction. To lengthen the cones, loosen the orifice hood by turning in the "Nat." direction.

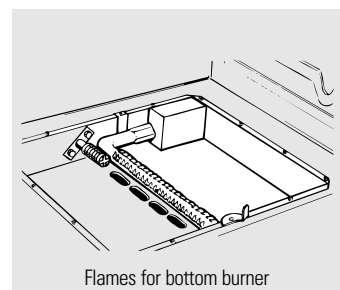
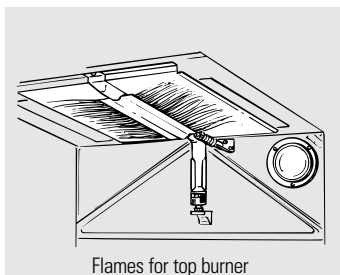
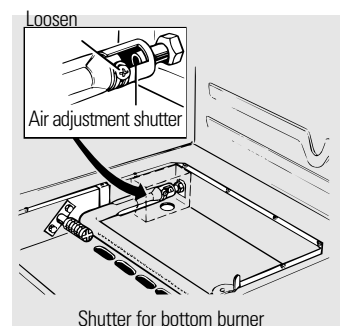
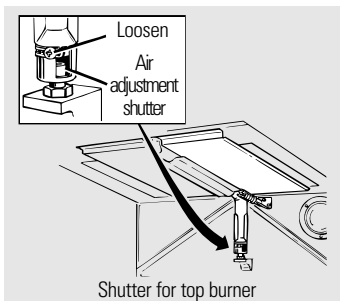

Broil and Oven Burner Air Adjustment Shutters

Air adjustment shutters for the broil and oven burners regulate the flow of air to the flame.

All ovens are factory adjusted for use with the natural gas used in most areas. But, since the gas in some areas may be different, you should check all adjustments described. If you are using LP gas, all the adjustments must be made.

The air adjustment shutter for the top burner is in the center of the rear wall of the oven.

The shutter for the bottom burner is near the back wall. Remove the oven bottom for access.

Turn the burner full on and check the flames. The burner flames should not flutter or blow away from the burner. They should be blue in color with no trace of yellow. Foreign particles in the gas line may cause an orange flame at first, but this will soon disappear. If the flames are yellow or flutter, open the air shutter more. If they blow away from the burner, close the air shutter more. See the illustration in the *Troubleshooting Tips* of this guide for correct flame appearance.

To adjust the flow of air to either burner, loosen the Phillips head screw and rotate the shutter to allow more or less air into the burner tube as needed.

The flames for the top (broil) burner should burn steady with approximately 1" blue cones and should not extend out over the edges of the burner baffle.

To determine if the bottom burner flames are proper, remove the oven bottom and the burner baffle. The flames should have 1/2" to 3/4" blue cones with no yellow tipping. When the baffle is back in place, the flames will resettle.

Visually check the color of the flames every 6 months. If they look like illustration (A) in the *Troubleshooting Tips* in this guide, call for service.

When checking the flames, before and after adjustments, the oven door should be closed.

Before You Call For Service...



Troubleshooting Tips
 Save time and money! Review the charts on the following pages first and you may not need to call for service.



Problem	Possible Causes	What To Do
Oven will not work	Circuit breaker has been tripped or a fuse has blown.	• Reset circuit breaker or replace fuse.
	Oven control not properly set.	• Set the control according to this manual.
Control signals after entering cooking time or start time	You forgot to enter a bake temperature or cleaning time.	• Touch the BAKE pad and desired temperature or the SELF CLEAN pad and desired clean time.
Food does not bake or roast properly	Oven controls improperly set.	• See the <i>Baking or Roasting</i> section.
	Shelf position is incorrect.	• See the <i>Baking</i> section.
	Oven thermostat needs adjustment.	• See the <i>Adjust the oven thermostat—Do it yourself!</i> section.
	Clock not set correctly when timed cooking.	• See the <i>Using the clock and timer</i> section.
	Aluminum foil used improperly in the oven.	• See the <i>Baking or Roasting</i> section.
Oven bottom not securely seated in position.	• See the <i>Care and cleaning of the oven</i> section.	
Food does not broil properly	Oven controls improperly set.	• Make sure you touch the BROIL HI/LO pad.
	Oven door not closed.	• See the <i>Broiling</i> section.
	Improper shelf position being used.	• See the <i>Broiling Guide</i> .
	Food being cooked in a hot pan.	• Use the broiling pan and grid that came with your oven. Make sure they are cool.
	Cookware not suited for broiling.	• Use the broiling pan and grid that came with your oven.
	Aluminum foil used on the the broiling pan and grid has not been fitted properly and slit as recommended.	• See the <i>Broiling</i> section.
	Oven bottom not securely seated in position.	• See the <i>Care and cleaning</i> section.
Oven temperature too hot or too cold	Oven thermostat needs adjustment.	• See the <i>Adjust the oven thermostat—Do it yourself!</i> section.
Clock and timer do not work	A fuse in your home may be blown or the circuit breaker tripped.	• Replace the fuse or reset the circuit breaker.
	Oven controls improperly set.	• See the <i>Using the clock and timer</i> section.

Before You Call For Service...



Troubleshooting Tips

Problem	Possible Causes	What To Do
Oven light does not work	<p>Light bulb is loose or defective.</p> <p>The pad operating the oven light is broken.</p>	<ul style="list-style-type: none"> • Tighten or replace the bulb. • Call for service.
Oven will not self-clean	<p>The oven temperature is too high to set a self-clean operation.</p> <p>The oven door is not fully closed.</p> <p>Oven controls improperly set.</p>	<ul style="list-style-type: none"> • Allow the oven to cool to room temperature and reset the controls. • Close door. • See the <i>Using the self-cleaning oven</i> section.
"Crackling" or "popping" sound	This is the sound of the metal heating and cooling during both the cooking and cleaning functions.	<ul style="list-style-type: none"> • This is normal.
Excessive smoking	Excessive soil.	<ul style="list-style-type: none"> • Touch the CLEAR/OFF pad. Open the windows to rid the room of smoke. Wait until the LOCKED DOOR light goes off. Wipe up the excess soil and reset the clean cycle.
Oven door will not open after a clean cycle	Oven too hot.	<ul style="list-style-type: none"> • Allow the oven to cool below locking temperature.
Oven not clean after a clean cycle	<p>Oven controls improperly set.</p> <p>Oven was heavily soiled.</p>	<ul style="list-style-type: none"> • See the <i>Using the self-cleaning oven</i> section. • Clean up heavy spillovers before starting the clean cycle. Heavily soiled ovens may need to self-clean again or for a longer period of time.
"LOCK DOOR" flashes in the display	The self-clean cycle has been selected but the door is not closed.	<ul style="list-style-type: none"> • Close the oven door.
LOCKED DOOR light flashes in the display	The oven door is locked because the temperature inside the oven has not dropped below the locking temperature.	<ul style="list-style-type: none"> • Touch the CLEAR/OFF pad. Allow the oven to cool.
"F—and a number or letter" flash in the display	<p>You have a function error code.</p> <p>Function error code repeats.</p>	<ul style="list-style-type: none"> • Touch the CLEAR/OFF pad. Allow the oven to cool for one hour. Put the oven back into operation. • Disconnect all power to the oven for 5 minutes and then reconnect power. If the function error code continues repeating, call for service.

Problem	Possible Causes	What To Do
Display goes blank	A fuse in your home may be blown or the circuit breaker tripped.	<ul style="list-style-type: none"> • Replace the fuse or reset the circuit breaker.
	The clock is in the black-out mode.	<ul style="list-style-type: none"> • See the <i>Special features of your oven control</i> section.
Display flashes	Power failure.	<ul style="list-style-type: none"> • Reset the clock.
Unable to get the display to show "SF"	Oven control pads were not touched properly.	<ul style="list-style-type: none"> • The BAKE and BROIL HI/LO pads must be touched at the same time and held for 2 seconds.
Power outage, clock flashes	Power outage or surge.	<ul style="list-style-type: none"> • Reset the clock. If the oven was in use, you must reset it by touching the CLEAR/OFF pad, setting the clock and resetting any cooking function.
"Burning" or "oily" odor emitting from the vent	This is normal in a new oven and will disappear in time.	<ul style="list-style-type: none"> • To speed the process, set a self-clean cycle for a minimum of 3 hours. See the <i>Using the self-cleaning oven</i> section.
Strong odor	Improper air/gas ratio in oven.	<ul style="list-style-type: none"> • Adjust the oven burner air shutter.
	Insulation around the inside of the oven.	<ul style="list-style-type: none"> • This is normal in a new oven, and will disappear in time.
Fan noise	A cooling fan may turn on and off automatically.	<ul style="list-style-type: none"> • This is normal. The fan will run until the function is over or the door is opened.
Cannot see flames on both sides of broil burner	Bright glow of igniter makes flames difficult to see.	<ul style="list-style-type: none"> • See the <i>Broiling</i> section.
Burners have yellow or yellow-tipped flames	Combustion quality of burner flames needs to be determined visually.	<ul style="list-style-type: none"> • Use the illustrations below to determine if your burner flames are normal. If burner flames look like A, call for service. Normal burner flames should look like B or C, depending on the type of gas you use. With LP gas, some yellow tipping on outer cones is normal. <div style="display: flex; justify-content: space-around; align-items: flex-start; margin-top: 10px;"> <div style="text-align: center;">  <p>A—Yellow flames Call for service</p> </div> <div style="text-align: center;">  <p>B—Yellow tips on outer cones Normal for LP gas</p> </div> <div style="text-align: center;">  <p>C—Soft blue flames Normal for natural gas</p> </div> </div>

GE Service Protection Plus™

GE, a name recognized worldwide for quality and dependability, offers you Service Protection Plus™—comprehensive protection on all your appliances—**No Matter What Brand!**

Benefits Include:

- Backed by GE
- All brands covered
- Unlimited service calls
- All parts and labor costs included
- No out-of-pocket expenses
- No hidden deductibles
- One 800 number to call

***We'll Cover Any Appliance.
Anywhere. Anytime.****

You will be completely satisfied with our service protection or you may request your money back on the remaining value of your contract. No questions asked. It's that simple.

Protect your refrigerator, dishwasher, washer and dryer, range, TV, VCR and much more—**any brand!** Plus there's no extra charge for emergency service and low monthly financing is available. Even icemaker coverage and food spoilage protection is offered. You can rest easy, knowing that all your valuable household products are protected against expensive repairs.

Place your confidence in GE and call us in the U.S. toll-free at **800-626-2224** for more information.

*All brands covered, up to 20 years old, in the continental U.S.



Please place in envelope and mail to:

General Electric Company
Warranty Registration Department
P.O. Box 32150
Louisville, KY 40232-2150

GE Gas Oven Warranty.



All warranty service provided by our Factory Service Centers or an authorized Customer Care® technician. For service, call 800-GE-CARES.

For The Period Of: **GE Will Replace, At No Charge To You:**

One Year

From the date of the original purchase

Any part of the oven which fails due to a defect in materials or workmanship. During this **full one-year warranty**, GE will also provide, **free of charge**, all labor and in-home service to replace the defective part.

What GE Will Not Cover:

- Service trips to your home to teach you how to use the product.
- Replacement of house fuses or resetting of circuit breakers.
- Improper installation.
- Damage to the product caused by accident, fire, floods or acts of God.
- Failure of the product if it is abused, misused, or used for other than the intended purpose or used commercially.
- Incidental or consequential damage to personal property caused by possible defects with this appliance.

This warranty is extended to the original purchaser and any succeeding owner for products purchased for home use within the USA. In Alaska, the warranty excludes the cost of shipping or service calls to your home.

Some states do not allow the exclusion or limitation of incidental or consequential damages. This warranty gives you specific legal rights, and you may also have other rights which vary from state to state. To know what your legal rights are, consult your local or state consumer affairs office or your state's Attorney General.

Warrantor: General Electric Company, Louisville, KY 40225

Service Telephone Numbers.



GE Answer Center® 800.626.2000

The GE Answer Center® is open 24 hours a day, 7 days a week.

OR

Visit our Website at: www.geappliances.com



In-Home Repair Service 800-GE-CARES (800-432-2737)

Expert GE repair service is only a phone call away.

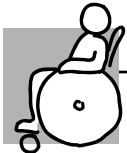

Special Needs Service 800.626.2000

800-TDD-GEAC (800-833-4322)

GE offers, free of charge, a brochure to assist in planning a barrier-free kitchen for persons with limited mobility.



Service Contracts 800-626-2224

Purchase a GE service contract while your warranty is still in effect and you'll receive a substantial discount. GE Consumer Service will still be there after your warranty expires.

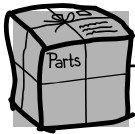

Parts and Accessories 800-626-2002

Individuals qualified to service their own appliances can have parts or accessories sent directly to their homes (VISA, MasterCard and Discover cards are accepted).

Instructions contained in this manual cover procedures to be performed by any user. Other servicing generally should be referred to qualified service personnel. Caution must be exercised, since improper servicing may cause unsafe operation.



Service Satisfaction

If you are not satisfied with the service you receive from GE:

First, contact the people who serviced your appliance.

Next, if you are still not pleased, **in the U.S.**, write all the details—including your phone number—to: Manager, Customer Relations, GE Appliances, Appliance Park, Louisville, KY 40225.

Free Manuals Download Website

<http://myh66.com>

<http://usermanuals.us>

<http://www.somanuals.com>

<http://www.4manuals.cc>

<http://www.manual-lib.com>

<http://www.404manual.com>

<http://www.luxmanual.com>

<http://aubethermostatmanual.com>

Golf course search by state

<http://golfingnear.com>

Email search by domain

<http://emailbydomain.com>

Auto manuals search

<http://auto.somanuals.com>

TV manuals search

<http://tv.somanuals.com>