

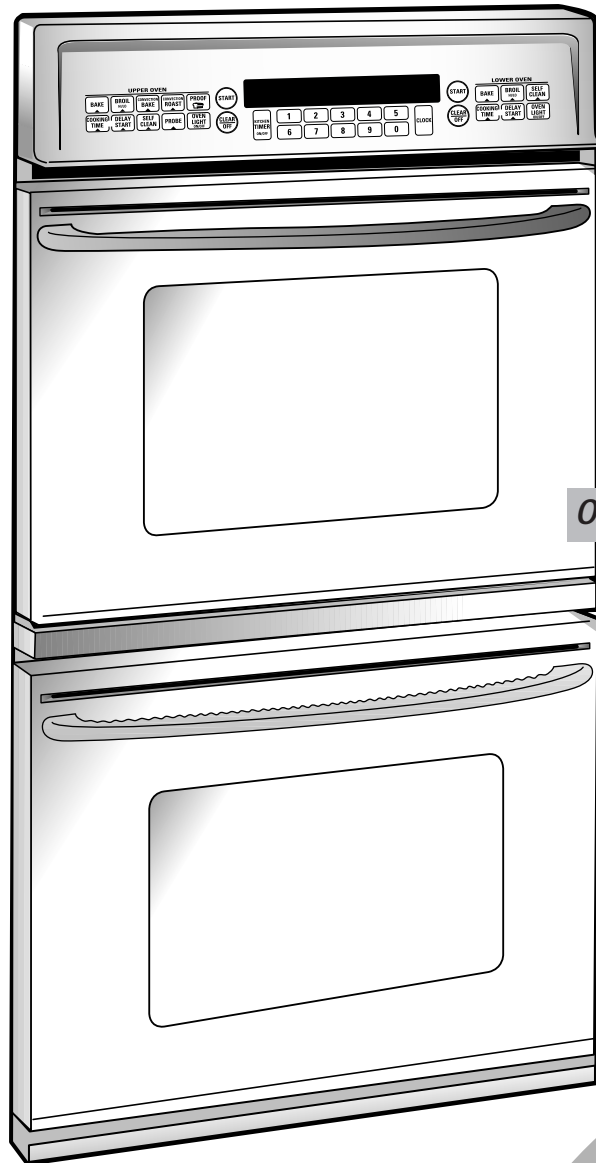

GE Appliances

Electric Convection
Built-In Oven



Owner's Manual

- JKP18*
- JTP18*
- JKP56*
- JTP56*
- JK910*
- JK950*
- JT910*
- JT950*



Part No. 164D3333P143-2 Pub. No. 49-8908-2 10-98 CG

Safety Instructions	<p>Safety Information</p> <p>Safety Precautions 3, 4</p> <p>Oven 5</p> <p>Self-Cleaning Oven 5</p>
Operating Instructions	<p>Operating Instructions</p> <p>Using the Oven 6–22</p> <p>Using the Clock and Timer .. 12</p> <p>Timed Baking & Roasting 13, 18</p> <p>Using the Probe 14</p> <p>Proofing 19</p> <p>Gourmet Shelf and Baking Stones 19</p> <p>Oven Thermostat 20</p>
Care and Cleaning	<p>Care and Cleaning</p> <p>Self-Cleaning Oven 21, 22</p> <p>Shelves 24</p> <p>Broiler Pan and Grid 24</p> <p>Probe 24</p> <p>Baking Stones 24</p> <p>Oven Light Bulb 25</p>
Troubleshooting Tips	<p>Troubleshooting Tips</p> <p>Before You Call For Service 26–28</p>
Customer Service	<p>Customer Service</p> <p>Product Registration 29</p> <p>Warranty 31</p> <p>Service Telephone Numbers Back Cover</p>

Congratulations! You Are Now Part of the GE Family.

Welcome to the GE family. We're proud of our quality products and we are committed to providing dependable service. You'll see it in this easy-to-use Owner's Manual and you'll hear it in the friendly voices of our customer service department.

Best of all, you'll experience these values each time you use your oven. That's important, because your new oven will be part of your family for many years. And we hope you will be part of ours for a long time to come.

We thank you for buying GE. We appreciate your purchase, and hope you will continue to rely on us whenever you need quality appliances for your home.

GE & You, A Service Partnership.



IMPORTANT!

Fill out and return the Consumer Product Registration Card that is packed with this product. If you cannot find it, please send in the duplicate card printed in the back of this manual.



FOR YOUR RECORDS

Write the model and serial numbers here:

You can find them on a label on the front of the oven behind the oven door on single oven models, or the front of the lower oven behind the oven door on double oven models.

Staple sales slip or cancelled check here.

Proof of the original purchase date is needed to obtain service under the warranty.

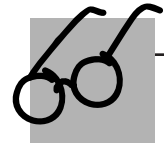

READ THIS MANUAL

Inside you will find many helpful hints on how to use and maintain your oven properly. Just a little preventive care on your part can save you a great deal of time and money over the life of your oven.

You'll find many answers to common problems in the *Before You Call For Service* section. If you review our chart of *Troubleshooting Tips* first, you may not need to call for service at all.



IF YOU NEED SERVICE

If you do need service, you can relax knowing help is only a phone call away. A list of toll-free customer service numbers is included in the back section of this manual. Or you can always call the GE Answer Center® at 800.626.2000, 24 hours a day, 7 days a week.

IMPORTANT SAFETY INFORMATION. READ ALL INSTRUCTIONS BEFORE USING.

⚠ WARNING!

For your safety, the information in this manual must be followed to minimize the risk of fire or explosion, electric shock, or to prevent property damage, personal injury, or loss of life.



IMPORTANT SAFETY NOTICE

The California Safe Drinking Water and Toxic Enforcement Act requires the Governor of California to publish a list of substances known to the state to cause cancer, birth defects or other reproductive harm, and requires businesses to warn customers of potential exposure to such substances.

The fiberglass insulation in self-clean ovens gives off a very small amount of carbon monoxide during the cleaning cycle. Exposure can be minimized by venting with an open window or using a ventilation fan or hood.



SAFETY PRECAUTIONS

When using electrical appliances, basic safety precautions should be followed, including the following:

- Use this appliance only for its intended purpose as described in this Owner's Manual.
- Be sure your appliance is properly installed and grounded by a qualified technician in accordance with the provided installation instructions.
- Do not attempt to repair or replace any part of your oven unless it is specifically recommended in this manual. All other servicing should be referred to a qualified technician.
- Have the installer show you the location of the circuit breaker or fuse. Mark it for easy reference.
- Before performing any service, disconnect the oven power supply at the household distribution panel by removing the fuse or switching off the circuit breaker.
- Do not leave children alone—children should not be left alone or unattended in an area where an appliance is in use. They should never be allowed to sit or stand on any part of the appliance.
- Do not allow anyone to climb, stand or hang on the door. They could damage the oven, or cause severe personal injury.
- Be sure the oven is securely installed in a cabinet that is firmly attached to the house structure. Never allow anyone to climb, sit, stand or hang on the oven door.
- Never leave the oven door open when you are not watching the oven.
- Always keep combustible wall covering, curtains or drapes a safe distance from your oven.
- Always keep dish towels, dish cloths, pot holders and other linens a safe distance from your oven.
- Always keep wooden and plastic utensils and canned food a safe distance away from your oven.
- Teach children not to play with the controls or any other part of the oven.

IMPORTANT SAFETY INFORMATION. READ ALL INSTRUCTIONS BEFORE USING.



⚠ WARNING! SAFETY PRECAUTIONS

- Do not store flammable materials in an oven.
- **CAUTION:** Items of interest to children should not be stored in cabinets above an oven; children climbing on the oven to reach items could be seriously injured.
- Never wear loose-fitting or hanging garments while using the appliance. Be careful when reaching for items stored in cabinets over the oven. Flammable material could be ignited if brought in contact with hot surfaces or heating elements and may cause severe burns.
- Use only dry pot holders—moist or damp pot holders on hot surfaces may result in burns from steam. Do not let pot holders touch hot heating elements. Do not use a towel or other bulky cloth.
- For your safety, never use your appliance for warming or heating the room.
- Do not let cooking grease or other flammable materials accumulate in or near the oven.
- Do not use water on grease fires. Never pick up a flaming pan. Turn the controls off.
Flame in the oven can be smothered completely by closing the oven door and turning the oven off or by using a multi-purpose dry chemical or foam-type fire extinguisher.
- Do not touch the heating elements or the interior surface of the oven. These surfaces may be hot enough to burn even though they are dark in color. During and after use, do not touch, or let clothing or other flammable materials contact any interior area of the oven; allow sufficient time for cooling first.
Potentially hot surfaces include oven vent openings, surfaces near the openings, crevices around the oven door, the edges of the window and metal trim parts above the door.
REMEMBER: The inside surface of the oven may be hot when the door is opened.
- Never leave jars or cans of fat drippings in or near your oven.
- Do not store or use combustible materials, gasoline or other flammable vapors and liquids in the vicinity of this or any other appliance.
- Stand away from the oven when opening the oven door. Hot air or steam which escapes can cause burns to hands, face and/or eyes.
- Do not heat unopened food containers. Pressure could build up and the container could burst, causing an injury.
- Keep the oven vent unobstructed.
- Keep the oven free from grease buildup.
- Place the oven shelf in the desired position while the oven is cool. If shelves must be handled when hot, do not let pot holder contact the heating elements.
- When using cooking or roasting bags in the oven, follow the manufacturer's directions.
- Pulling out the shelf to the stop-lock is a convenience in lifting heavy foods. It is also a precaution against burns from touching hot surfaces of the door or oven walls.
- Do not use the oven to dry newspapers. If overheated, they can catch on fire.
- Do not use the oven for a storage area. Items stored in an oven can ignite.
- Do not leave paper products, cooking utensils or food in the oven when not in use.
- After broiling, always take the broiler pan out of the oven and clean it. Leftover grease in the broiler pan can catch fire next time you use the pan.
- Clean only parts listed in this Use and Care Manual.
- Do not use aluminum foil to line oven bottoms, except as suggested in this manual. Improper installation of aluminum foil may result in a risk of electric shock or fire.



COOK MEAT AND POULTRY THOROUGHLY...

Cook meat and poultry thoroughly—meat to at least an INTERNAL temperature of 160°F. and poultry to at least an INTERNAL temperature of 180°F. Cooking to these temperatures usually protects against foodborne illness.

SELF-CLEANING OVEN

- Do not clean the door gasket. The door gasket is essential for a good seal. Care should be taken not to rub, damage or move the gasket.
- Do not use oven cleaners. No commercial oven cleaner or oven liner protective coating of any kind should be used in or around any part of the oven. Residue from oven cleaners will damage the inside of the oven when the self-clean cycle is used.
- Before self-cleaning the oven, remove the broiler pan, grid and other cookware.
- Be sure to wipe up excess spillage before starting the self-cleaning operation.
- If the self-cleaning mode malfunctions, turn the oven off and disconnect the power supply. Have it serviced by a qualified technician.



Read and follow this Safety Information carefully.

SAVE THESE INSTRUCTIONS

Using the oven controls.

Throughout this manual, features and appearance may vary from your model.

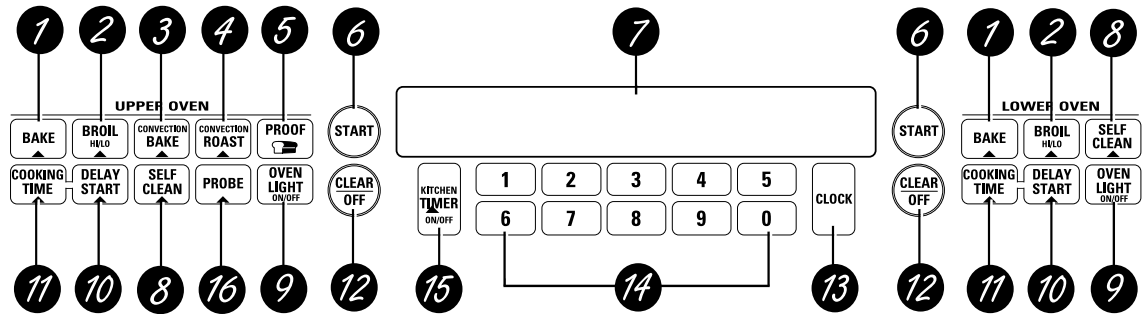

Double oven control shown.

Oven Control, Clock and Timer Features and Settings

- 1** **BAKE Pad**
Press this pad to select the bake function.
- 2** **BROIL HI/LO Pad**
Press this pad to select the broil function.
- 3** **CONVECTION BAKE Pad**
Press this pad to select baking with the convection function.
- 4** **CONVECTION ROAST Pad**
Press this pad to select roasting with the convection function.
- 5** **PROOF Pad (on some models)**
Press this pad to select a warm environment useful for rising yeast-leavened products.
- 6** **START Pad**
Must be pressed to start any cooking or cleaning function.
- 7** **Display**
Shows the time of day, oven temperature, whether the oven is in the bake, broil or self-cleaning mode and the times set for the timer or automatic oven operations.
- 8** **SELF CLEAN Pad**
Press this pad to select the self-cleaning function. See the *Using the self-cleaning oven* section.
- 9** **OVEN LIGHT Pad**
Press this pad to turn the oven light on or off.
- 10** **DELAY START Pad**
Use along with **COOKING TIME** or **SELF CLEAN** pads to set the oven to start and stop automatically at a time you set.
- 11** **COOKING TIME Pad**
Press this pad and then press the number pads to set the amount of time you want your food to cook. The oven will shut off when the cooking time has run out.
- 12** **CLEAR/OFF Pad**
Press this pad to cancel **ALL** oven operations except the clock and timer.
- 13** **CLOCK Pad**
Press this pad before setting the clock.
- 14** **Number Pads**
Use to set any function requiring numbers such as the time of day on the clock, the timer, the oven temperature, the internal food temperature, the start time and length of operation for timed baking and self-cleaning.
- 15** **KITCHEN TIMER ON/OFF Pad**
Press this pad to select the timer feature.
- 16** **PROBE Pad**
Press this pad when using the probe to cook food.

*If "F- and a number or letter" flash in the display and the oven control signals, this indicates a function error code. Press the **CLEAR/OFF** pad. Allow the oven to cool for one hour. Put the oven back into operation. If the function error code repeats, disconnect the power to the oven and call for service.*

If your oven was set for a timed oven operation and a power outage occurred, the clock and all programmed functions must be reset.

The time of day will flash in the display when there has been a power outage.

Special features of your oven control.

Your new touch pad control has additional features that you may choose to use. The following are the features and how you may activate them.

The special feature modes can only be activated while the display is showing the time of day. They remain in the control's memory until the steps are repeated.

When the display shows your choice, press the **START** pad. The special features will remain in memory after a power failure.

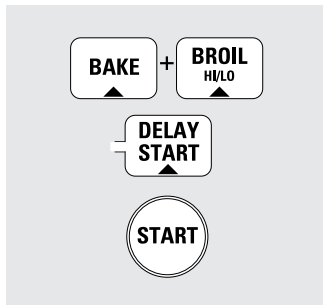

12 Hour Shut-Off

With this feature, should you forget and leave the oven on, the control will automatically turn off the oven after 12 hours during baking functions or after 3 hours during a broil function.

If you wish to turn **OFF** this feature, follow the steps below.

- 1 Press the **BAKE** and **BROIL HI/LO** pads (on double oven models use the **upper** oven controls) at the same time for 3 seconds until the display shows **SF**.

- 2 Press the **DELAY START** pad. The display will show **12 shdn** (12 hour shut-off). Press the **DELAY START** pad again and the display will show **no shdn** (no shut-off).
- 3 Press the **START** pad to activate the no shut-off and leave the control set in this special features mode.

NOTE: On double oven models this activates this special feature for both ovens.

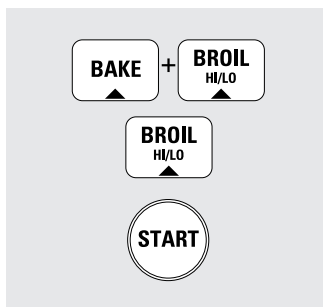

Fahrenheit or Centigrade Temperature Selection

Your oven control is set to use the Fahrenheit temperature selections but you may change this to use the Centigrade selections.

- 1 Press the **BAKE** and **BROIL HI/LO** pads (on double oven models use the **upper** oven controls) at the same time for 3 seconds until the display shows **SF**.

- 2 Press the **BROIL HI/LO** pad. The display will show **F** (Fahrenheit).
- 3 Press the **BROIL HI/LO** pad again. The display will show **C** (Centigrade).
- 4 Press the **START** pad.

NOTE: On double oven models the new setting will be displayed for both ovens.

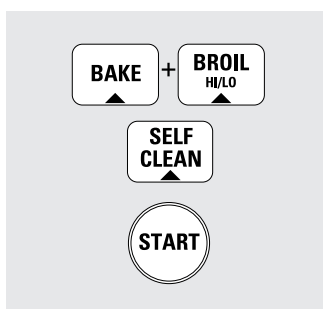

Control Lockout

Your control will allow you to lock down the touch pads so they cannot be activated when pressed.

- 1 Press the **BAKE** and **BROIL HI/LO** pads (on double oven models use the **upper** oven controls) at the same time for 3 seconds until the display shows **SF**.
- 2 Press the **SELF CLEAN** pad. The display will show **LOC OFF**.
Press the **SELF CLEAN** pad again. The display will show **LOC ON**.
- 3 Press the **START** pad to activate the control lockout feature and leave the control set in this special features mode.

When this feature is on and the touch pads are pressed the control will beep and the display will show **LOC**.

NOTE:

- The control lockout mode will not affect the **CLOCK**, **KITCHEN TIMER ON/OFF** and **OVEN LIGHT ON/OFF** touch pads.
- On double oven models this activates this special feature for both ovens.

Special features of your oven control.

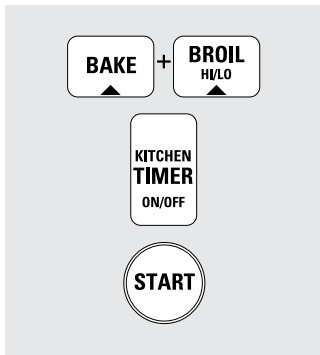

Tones at the End of a Timed Cycle

At the end of a timed cycle, 3 short beeps will sound followed by one beep every 6 seconds until the **CLEAR/OFF** pad is pressed. This continuous 6 second beep may be canceled.

To cancel the 6 second beep:

- 1 Press the **BAKE** and **BROIL HI/LO** pads (on double oven models use the **upper** oven controls) at the same time for 3 seconds until the display shows **SF**.

- 2 Press the **KITCHEN TIMER ON/OFF** pad. The display shows **CON BEEP** (continuous beep). Press the **KITCHEN TIMER ON/OFF** pad again. The display shows **BEEP**. (This cancels the one beep every 6 seconds.)

- 3 Press the **START** pad.

NOTE: On double oven models this cancels the end of cycle tone for both ovens.

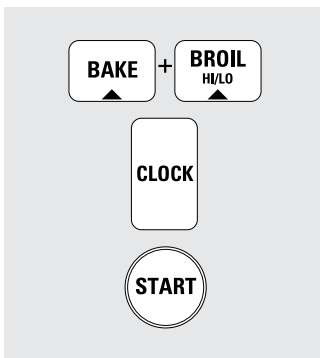

12 Hour, 24 Hour or Clock Black-Out

Your control is set to use a 12 hour clock.

If you would prefer to have a 24 hour military time clock or black-out the clock display, follow the steps below.

- 1 Press the **BAKE** and **BROIL HI/LO** pads (on double oven models use the **upper** oven controls) at the same time for 3 seconds until the display shows **SF**.

- 2 Press the **CLOCK** pad once. The display will show **12 hr**. If this is the choice you want, press the **START** pad.

Press the **CLOCK** pad again to change to the 24 hour military time clock. The display will show **24 hr**. If this is the choice you want, press the **START** pad.

Press the **CLOCK** pad again to black-out the clock display. The display will show **OFF**. If this is the choice you want, press the **START** pad.

NOTE: If the clock is in the black-out mode you will not be able to use the Delay Start function.

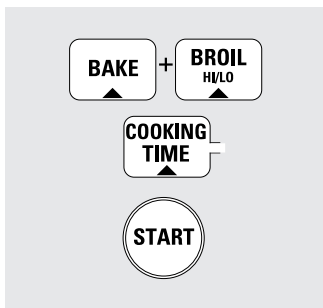

Cook and Hold

Your new control has a cook and hold feature that keeps cooked foods warm for up to 3 hours after the cooking function is finished.

To activate this feature, follow the steps below.

On double oven models both ovens follow the same step 1. Then proceed with steps 2 through 3, using the pads for the upper or lower oven.

- 1 Press the **BAKE** and **BROIL HI/LO** pads (on double oven models use the *upper* oven controls) at the same time for 3 seconds until the display shows **SF**.

- 2 Press the **COOKING TIME** pad. The display will show **Hid OFF**.

Press the **COOKING TIME** pad again to activate the feature. The display will show **Hid ON**.

- 3 Press the **START** pad to activate the cook and hold feature and leave the control set in this special features mode.

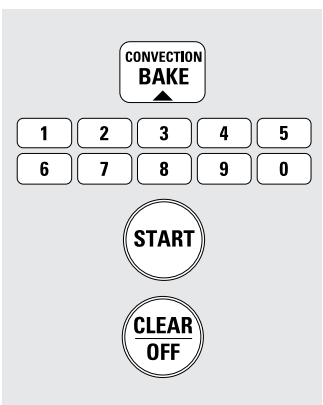

Using Convection Conversion

By using the Convection Conversion feature you can automatically convert the oven temperature from regular baking to Convection Bake temperatures.

To convert the oven temperature for convection baking, follow the steps below.

- 1 Press and hold the **CONVECTION BAKE** pad for 4 to 5 seconds.
CON Con Bake will show in the display.

- 2 Using the number pads, enter the temperature recommended in the recipe.

- 3 Press the **START** pad.

The display shows the converted (reduced) temperature. For example, if you entered a recipe temperature of 350°F., the display will show **325°F.** when it is converted.

- 4 Press the **CLEAR/OFF** pad when baking is finished.

NOTE: Conversion must be set each time you want to use it. It is not held in memory.

Using the oven.

To avoid possible burns, place the shelves in the desired position before you turn the oven on.

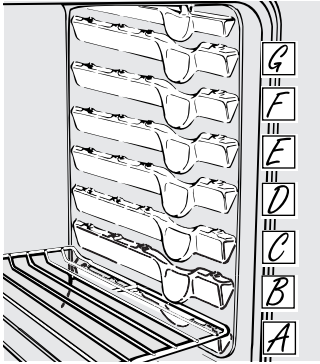

30" ovens (shown) have 7 shelf positions.

27" ovens have 4 shelf positions.

Before you begin...

The shelves have stop-locks, so that when placed correctly on the supports, they will stop before coming completely out, and will not tilt.

When placing and removing cookware, pull the shelf out to the bump on the shelf support.

To remove a shelf, pull it toward you, tilt the front end up and pull it out.

To replace, place the end of the shelf (stop-locks) on the support, tilt up the front and push the shelf in.

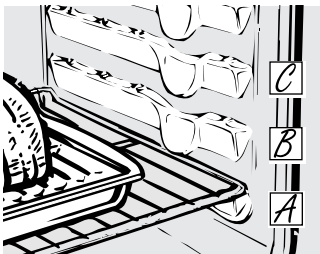

How to Set the Oven for Baking or Roasting

- 1 Press the **BAKE** pad.
- 2 Press the number pads to set the desired temperature.
- 3 Press the **START** pad.
- 4 Check food for doneness at minimum time on recipe. Cook longer if necessary.
- 5 Press the **CLEAR/OFF** pad when cooking is complete.

NOTE: A cooling fan may automatically turn on and off to cool internal parts. This is normal, and the fan may continue to run even after the oven is turned off.

Type of Food	Shelf Position	
	27" Oven	30" Oven
Frozen pies (on cookie sheet)	B or C	C or D
Angel food cake, bundt or pound cakes	A	B
Biscuits, muffins, brownies, cookies, cupcakes, layer cakes, pies	B or C	C or D
Casseroles	B or C	C or D

Preheating and Pan Placement

Preheat the oven if the recipe calls for it. To preheat, set the oven at the correct temperature. Preheating is necessary for good results when baking cakes, cookies, pastry and breads.

For ovens without a preheat indicator light or tone, preheat 10 minutes.

Baking results will be better if baking pans are centered in the oven as much as possible. Pans should not touch each other or the walls of the oven. If you need to use two shelves, stagger the pans so one is not directly above the other, and leave approximately 1½" between pans, from the front, back and sides of the wall.

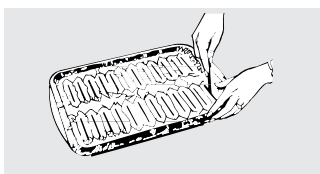

Cut slits in the foil just like the grid.

Aluminum Foil

You can use aluminum foil to line the broiler pan and broiler grid. However, you must mold the foil tightly to the grid and cut slits in it just like the grid.

Aluminum foil may also be used to catch a spillover.

Never entirely cover a shelf with aluminum foil. This will disturb the heat circulation and result in poor baking.

A smaller sheet of foil may be used to catch a spillover by placing it on a lower shelf several inches below the food.

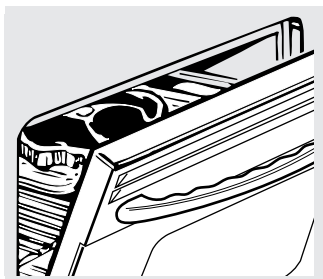

How to Set the Oven for Broiling

- 1 Place the meat or fish on the broiler grid in the broiler pan.
- 2 Follow suggested shelf positions in the *Broiling Guide*.
- 3 Press the **BROIL HI/LO** pad once for **HI Broil**.
To change to **LO Broil**, press the **BROIL HI/LO** pad again.
- 4 Press the **START** pad.
- 5 When broiling is finished, press the **CLEAR/OFF** pad.

If your oven is connected to 208 volts, rare steaks may be broiled by preheating the broiler and positioning the oven shelf one position higher.

NOTE: Broil will not work if the temperature probe is plugged in.

Leave the door open to the broil stop position. The door stays open by itself, yet the proper temperature is maintained in the oven.

Broiling Guide

Food	Quantity and/or Thickness	27" Ovens Shelf Position	27" Ovens First Side Time (min.)	27" Ovens Second Side Time (min.)	30" Ovens Shelf Position	30" Ovens First Side Time (min.)	30" Ovens Second Side Time (min.)	Comments
Ground Beef Well Done	1 lb. (4 patties) 1/2 to 3/4" thick	C	10	7	E E	10 10	7 9	Space evenly. Up to 8 patties take about the same time.
Beef Steaks								
Rare	1" thick	C	6	5	E	8	6	Steaks less than 1" thick cook through before browning. Pan frying is recommended. Slash fat.
Medium	1 to 1½ lbs.	C	8	6	E	10	8	
Well Done		C	12	11	E	12	10	
Rare	1½" thick	C	10	7-8	E	10	8	Pan frying is recommended. Slash fat.
Medium	2 to 2½ lbs.	C	15	14-16	E	15	14-16	
Well Done		C	25	20-25	E	25	20-25	
Chicken	1 whole 2 to 2½ lbs., split lengthwise	A	35	10-15	C	25	10	Reduce time about 5 to 10 minutes per side for cut-up chicken. Brush each side with melted butter. Broil skin-side-down first.
Loyster Tails	2-4 6 to 8 oz. each	B	13-16	Do not turn over.	C	13-16	Do not turn over.	Cut through back of shell. Spread open. Brush with melted butter before broiling and after half of broiling time.
Fish Fillets	1/4 to 1/2" thick	C	5	5	E	5	5	Handle and turn very carefully. Brush with lemon butter before and during cooking, if desired. Preheat broiler to increase browning.
Ham Slices (precooked)	1" thick	B	8	8	D	8	8	Increase time 5 to 10 minutes per side for 1½" thick or home-cured ham.
Pork Chops Well Done	2 (1/2" thick) 2 (1" thick) about 1 lb.	C B	10 13	10 13	E D	10 15	10 15	Slash fat.
Lamb Chops								
Medium	2 (1" thick) about 10	C	10	9	E	10	9	Slash fat.
Well Done	to 12 oz.	C	12	10	E	12	10	
Medium	2 (1½" thick) about 1 lb.	C	14	12	E	14	12	
Well Done		B	17	12-14	E	17	12-14	

Using the clock and timer.



Make sure the clock is set to the correct time of day.

To Set the Clock

The clock must be set to the correct time of day for the automatic oven timing functions to work properly. The time of day cannot be changed during a timed baking or self-cleaning cycle.

- 1 Press the **CLOCK** pad.
- 2 Press the number pads.
- 3 Press the **START** pad.



The timer is a minute timer only. The timer does not control oven operations. The maximum setting on the timer is 9 hours and 59 minutes.

To Set the Timer

- 1 Press the **KITCHEN TIMER ON/OFF** pad.
- 2 Press the number pads until the amount of time you want shows in the display. For example, to set 2 hours and 45 minutes, press **2**, **4** and **5** in that order. If you make a mistake press the **KITCHEN TIMER ON/OFF** pad and begin again.
- 3 Press the **START** pad.
- 4 When the timer reaches **:00**, the control will beep 3 times followed by one beep every 6 seconds until the **KITCHEN TIMER ON/OFF** pad is pressed.

The 6 second tone can be canceled by following the steps in the *Special features of your oven control* section under *Tones at the End of a Timed Cycle*.

NOTE: On some models the time counts down immediately when the **START** pad is pressed. The timer is actually counting down in seconds that are not shown on the display until the last minute.

To Reset the Timer

If the display is still showing the time remaining, you may change it by pressing the **KITCHEN TIMER ON/OFF** pad, then press the number pads until the time you want appears in the display.

If the remaining time is not in the display (clock, delay start or cooking time are in the display), recall the remaining time by pressing the **KITCHEN TIMER ON/OFF** pad and then pressing the number pads to enter the new time you want.

To Cancel the Timer

Press the **KITCHEN TIMER ON/OFF** pad twice.

Using the timed baking and roasting features.

On double oven models, you can use timed baking in one oven while using self-clean in the other; you can also use timed baking in both ovens at the same time.

NOTE: Foods that spoil easily—such as milk, eggs, fish, stuffings, poultry and pork—should not be allowed to sit for more than 1 hour before or after cooking. Room temperature promotes the growth of harmful bacteria. Be sure that the oven light is off because heat from the bulb will speed harmful bacteria growth.

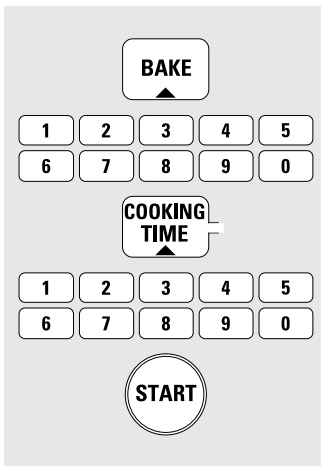

How to Set an Immediate Start and Automatic Stop

The oven will turn on immediately and cook for a selected length of time. At the end of the cooking time the oven will turn off automatically.

Make sure the clock shows the correct time of day.

- 1 Press the **BAKE** pad.
- 2 Using the number pads, enter the desired temperature.
- 3 Press the **COOKING TIME** pad.

NOTE: If your recipe requires preheating, you may need to add additional time to the length of the cooking time.

- 4 Using the number pads, enter the desired baking time. The oven temperature and the cooking time that you entered will be displayed.

- 5 Press the **START** pad.

The display shows the oven temperature that you set and the cooking time countdown. The display starts changing once the temperature reaches 100°F.

NOTE: On double oven models when using both ovens at the same time, the times showing in the display will be for the last oven set. To display the time set for the first oven set, press the **COOKING TIME** pad for that oven.

The oven will continue to cook for the programmed amount of time, then shut off automatically.

Press the **CLEAR/OFF** pad to clear the display.

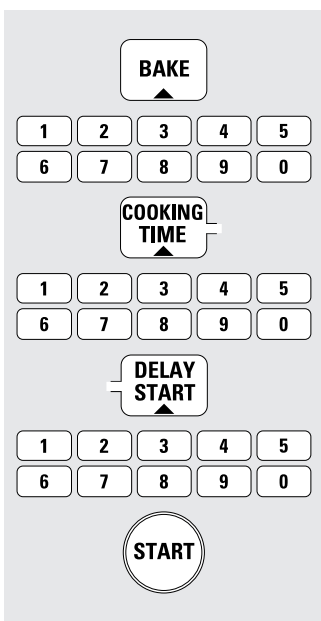

How to Set a Delayed Start and Automatic Stop

You can set the oven control to delay-start the oven, cook for a specific length of time and then turn off automatically.

Make sure the clock shows the correct time of day.

- 1 Press the **BAKE** pad.
- 2 Using the number pads, enter the desired temperature.
- 3 Press the **COOKING TIME** pad.

NOTE: If your recipe requires preheating, you may need to add additional time to the length of the cooking time.

- 4 Using the number pads, enter the desired baking time.
- 5 Press the **DELAY START** pad.
- 6 Using the number pads, enter the time of day you want the oven to turn on and start cooking.
- 7 Press the **START** pad.

NOTE: An attention tone will sound if you are using timed baking and do not press the **START** pad after entering the baking temperature.

If you would like to check the times you have set, press the **DELAY START** pad to check the start time you have set or press the **COOKING TIME** pad to check the length of cooking time you have set.

When the oven turns on at the time of day you have set, the display will show the changing temperature (starting at 100°F.) and the cooking time countdown.

NOTE: On double oven models when using both ovens at the same time, the times showing in the display will be for the last oven set. To display the time set for the first oven set, press the **DELAY START** or the **COOKING TIME** pad for that oven.

At the end of timed baking, the oven will turn off. The end of cycle tone will sound.

Press the **CLEAR/OFF** pad to clear the display.

Using the probe.

For many foods, especially roasts and poultry, internal food temperature is the best test for doneness. The temperature probe takes the guesswork out of roasting by cooking foods to the exact doneness you want.

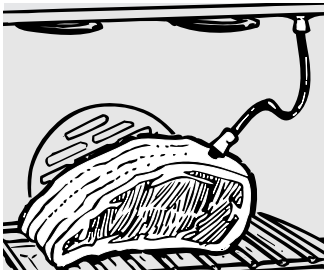

The temperature probe has a skewer-like probe at one end and a plug at the other end that goes into the outlet in the oven.

NOTE: Double oven models have a probe in the upper oven only.

Use of probes other than the one provided with this product may result in damage to the probe.

Use the handles of the probe and plug when inserting and removing them from the meat and outlet.

- To avoid damaging your probe, do not use tongs to pull on the cable when removing it.
- To avoid breaking the probe, make sure food is completely defrosted before inserting.

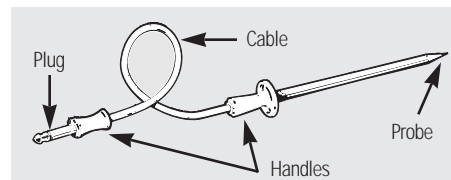

- To prevent possible burns, do not unplug the probe from the outlet until the oven has cooled.
- Never leave your probe inside the oven during a self-cleaning cycle.
- Do not store the probe in the oven.

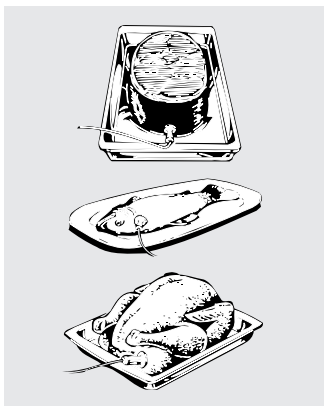

After preparing the meat and placing it on a trivet or on the broiler pan grid, follow these directions for proper probe placement.

- 1 Lay the probe on the outside of the meat along the top or side and mark with your finger where the edge of the meat comes to on the probe. The point should rest in the center of the thickest meaty part of the roast.
- 2 Insert the probe completely into the meat. It should not touch the bone, fat or gristle.

For roasts with no bone, insert the probe into the meatiest part of the roast. For bone-in ham or lamb, insert the probe into the center of the lowest large muscle or joint.

Insert the probe into the center of dishes such as meat loaf or casseroles. When cooking fish, insert the probe from just above the gill into the meatiest area, parallel to the backbone.

Insert the probe into the meatiest part of the inner thigh from below and parallel to the leg of a whole turkey.

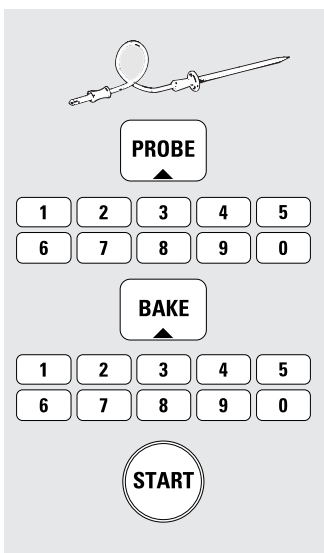

How to Set the Oven For Roasting When Using the Probe

- 1 Insert the probe into the meat.
- 2 Plug the probe into the outlet in the oven. Make sure it's pushed all the way in. Close the oven door.
- 3 Press the **PROBE** pad.
- 4 Press the number pads to set the desired internal food or meat temperature.
- 5 Press the **BAKE** pad.
- 6 Press the number pads to set the desired oven temperature.
- 7 Press the **START** pad.

The display will flash if the probe is inserted into the outlet and you have not set a probe temperature and pressed the **START** pad.

When the oven starts to heat, the word **LO** will be in the display.

After the internal temperature of the meat reaches 100°F., the changing internal temperature will be shown in the display.

- 8 When the internal temperature of the meat reaches the number you have set, the probe and the oven turn off and the oven control signals. To stop the signal, press the **CLEAR/OFF** pad. Use hot pads to remove the probe from the food. Do not use tongs to pull on it—they might damage it.

To change the oven temperature during the Roast cycle, press the **BAKE** pad and then the number pads to set the new temperature.

- If the probe is removed from the food before the final temperature is reached, a tone will sound and the display will flash until the probe is removed from the oven.
- You can use the timer even though you cannot use timed oven operations.

Using the convection oven.

The convection oven fan shuts off when the oven door is opened. **DO NOT** leave the door open for long periods of time while using convection cooking or you may shorten the life of the convection heating element.

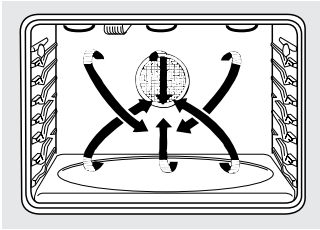

In a convection oven, a fan circulates hot air over, under and around the food.

This circulating hot air is evenly distributed throughout the oven cavity. As a result, foods are evenly cooked and browned—often in less time with convection heat. (appearance may vary)

To help you understand the difference between convection bake and roast and traditional bake and roast, here are some general guidelines.

Convection Bake

- Ideal for evenly browned baked foods cooked on multiple shelves.
- Good for large quantities of baked foods.
- Good results with cookies, biscuits, muffins, brownies, cupcakes, cream puffs, sweet rolls, angel food cake and bread.

Heat comes from the heating element in the rear of the oven. The convection fan circulates the heated air evenly over and around the food. Preheating is not necessary with foods having a bake time of over 15 minutes.

Convection Roast

- Good for large tender cuts of meat, uncovered.

Heat comes from the top heating element. The convection fan circulates the heated air evenly over and around the food. Meat and poultry are browned on all sides as if they were cooked on a rotisserie. Using the roasting rack provided, heated air will be circulated over, under and around the food being roasted. The heated air seals in juices quickly for a moist and tender product while, at the same time, creating a rich golden brown exterior.

Roasts or poultry should be cooked on a shelf (on 27" models use the offset shelf) in the lowest shelf position (A).

When you are convection roasting it is important that you use the broiler pan and grid and the special roasting rack for best convection roasting results. The pan is used to catch grease spills and the grid is used to prevent grease spatters.

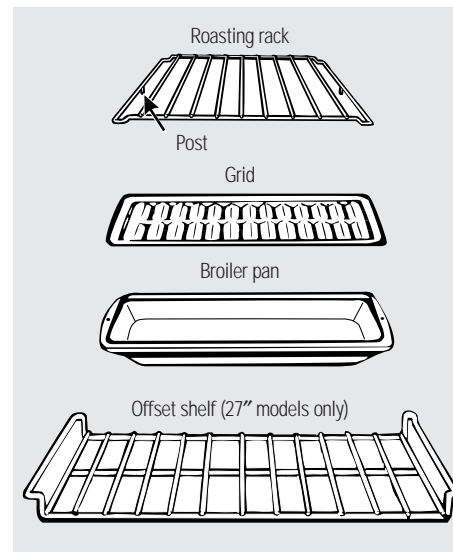

Place the meat on the special roasting rack. The rack holds the meat. The rack allows the heated air to circulate under the meat and increase browning on the underside of the meat or poultry.

- Place the shelf (on 27" models use the offset shelf) in the lowest shelf position (A).
- Place the grid on the broiler pan and put the roasting rack over them making sure the posts on the roasting rack fit into the holes in the broiler pan.

CAUTION: When you are using the offset shelf (on 27" models) in the lowest position (A), you will need to use caution when pulling the shelf out. We recommend that you pull the shelf out several inches and then, using two pot holders, pull the shelf out by holding the sides of it. The offset shelf is low and you could be burned if you place your hand in the middle of the shelf and pull all the way out. Be very careful not to burn your hand on the door when using a shelf in the lowest position (A).

Adapting Recipes...

You can use your favorite recipes in the convection oven.

When baking, reduce baking temperature by 25°F.

No need to preheat when cooking longer than 15 minutes.

- For more information on adapting recipes, see the Convection Cookbook.
- Use pan size recommended.
- Some package instructions for frozen casseroles or main dishes have been developed using commercial convection ovens. For best results in this oven, preheat the oven and use the temperature on the package.

Using the convection oven.

Cookware for Convection Cooking

Before using your convection oven, check to see if your cookware leaves room for air circulation in the oven. If you are baking with several pans, leave space between them. Also, be sure the pans do not touch each other or the walls of the oven.

Paper and Plastic

Heat-resistant paper and plastic containers that are recommended for use in regular ovens can be used in convection ovens. Plastic cookware that is heat-resistant to temperatures of 400°F. can also be used.

Metal and Glass

Any type of cookware will work in your convection oven. However, metal pans heat the fastest and are recommended for convection baking.

■ Darkened or matte-finished pans will bake faster than shiny pans.

■ Glass or ceramic pans cook more slowly.

When baking cookies, you will get the best results if you use a flat cookie sheet instead of a pan with low sides.

For recipes like oven-baked chicken, use a pan with low sides. Hot air cannot circulate well around food in a pan with high sides.

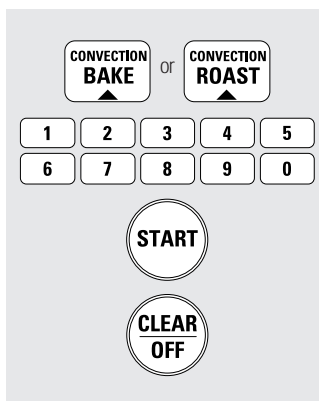

How to Set the Oven for Convection Baking or Roasting

- 1 Press the **CONVECTION BAKE** or **CONVECTION ROAST** pad.
- 2 Press the number pads to set the desired oven temperature.
- 3 Press the **START** pad.

To change the oven temperature, press the **CONVECTION BAKE** or **CONVECTION ROAST** pad and then the number pads to set the new temperature.

When the oven starts to heat the changing temperature, starting at 100°F., will be displayed. When the oven reaches the temperature you set, 3 beeps will sound.

- 4 Press the **CLEAR/OFF** pad when finished.

NOTE:

- You will hear a fan while cooking with convection. The fan will stop when the door is opened but the heat will not turn off.
- You may hear the oven clicking during baking. This is normal.

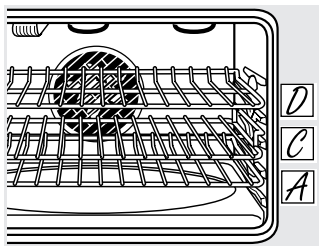

Multi-shelf position 27" oven

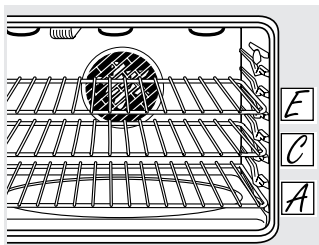

Multi-shelf position 30" oven

Multi-Shelf Baking

When convection baking with only 1 shelf, follow the shelf positions recommended in the Using the oven section.

Because heated air is circulated evenly throughout the oven, foods can be baked with excellent results using multiple shelves.

Multi-shelf baking may increase cook times slightly for some foods but the overall result is time saved. Cookies, muffins, biscuits, and other quickbreads give very good results with multi-shelf baking.

30" Ovens

When baking on 3 shelves, place one shelf in the bottom (A) position, one on the third (C) position and one in the 5th (E) position.

27" Ovens

When baking on 3 shelves, divide the oven into thirds by placing the offset shelf in the third (C) shelf position and the straight shelves in first (A) and fourth (D) shelf positions.

For two-shelf baking, place the offset shelf in the bottom (A) shelf position. Place the straight shelf in the third (C) shelf position.

CAUTION: When you are using the offset shelf (on 27" models) in the lowest position (A), you will need to use caution when pulling the shelf out. We recommend that you pull the shelf out several inches and then, using two pot holders, pull the shelf out by holding the sides of it. The offset shelf is low and you could be burned if you place your hand in the middle of the shelf and pull all the way out. Be very careful not to burn your hand on the door when using a shelf in the lowest position (A).

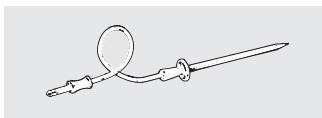

For best results when roasting large turkeys and roasts, we recommend using the probe included in the convection oven.

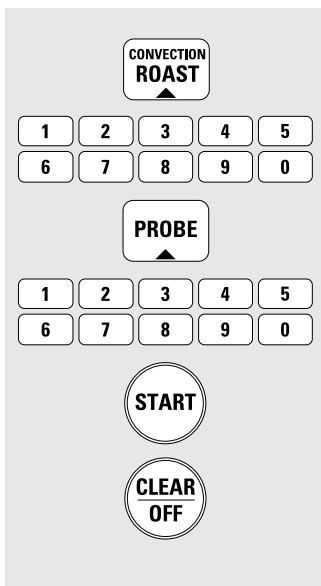

To change the oven temperature during the Convection Roast cycle, press the CONVECTION ROAST pad and then press the number pads to set the new desired temperature.

How to Set the Oven for Convection Roasting when Using the Probe

The display will flash **PROBE** and the oven control will signal if the probe is inserted into the outlet, and you have not set a probe temperature and pressed the **START** pad.

- 1 Place the shelf (on 27" models use the offset shelf) in the lowest position (A). Insert the probe into the meat.
- 2 Plug the probe into the outlet in the oven. Make sure it is pushed all the way in. Close the oven door.
- 3 Press the **CONVECTION ROAST** pad.
- 4 Press the number pads to set the desired oven temperature.
- 5 Press the **PROBE** pad.
- 6 Press the number pads to set the desired internal meat temperature.
- 7 Press the **START** pad.

When the oven starts to heat, the word **LO** will be in the display.

After the internal temperature of the meat reaches 100°F., the changing internal temperature will be shown in the display.

Convection Roasting Guide

Meats		Minutes/Lb.	Oven Temp.	Internal Temp.		
Beef	Rib, Boneless Rib, Top Sirloin (3 to 5 lbs.)	Rare Medium Well	20–24 24–28 28–32	325°F. 325°F. 325°F.	140°F.† 160°F. 170°F.	
	Beef Tenderloin	Rare Medium	10–14 14–18	325°F. 325°F.	140°F.† 160°F.	
	Pork	Bone-in, Boneless (3 to 5 lbs.)		23–27	325°F.	170°F.
	Chops (1/2 to 1" thick)	2 chops 4 chops 6 chops	30–35 total 35–40 total 40–45 total	325°F. 325°F. 325°F.	170°F. 170°F. 170°F.	
Ham	Canned, Butt, Shank (3 to 5 lbs. fully cooked)		14–18	325°F.	140°F.	
Lamb	Bone-in, Boneless (3 to 5 lbs.)	Medium Well	17–20 20–24	325°F. 325°F.	160°F. 170°F.	
Seafood	Fish, whole (3 to 5 lbs.)		30–40 total	400°F.		
	Lobster Tails (6 to 8 oz. each)		20–25 total	350°F.		
Poultry	Whole Chicken (2½ to 3½ lbs.)		24–26	350°F.	180°–185°F.	
	Cornish Hens Unstuffed (1 to 1½ lbs.)		50–55 total	350°F.	180°–185°F.	
	Stuffed (1 to 1½ lbs.)		55–60 total	350°F.	180°–185°F.	
	Duckling (4 to 5 lbs.)		24–26	325°F.	180°–185°F.	
	Turkey, whole*					
	Unstuffed (10 to 16 lbs.)		8–11	325°F.	180°–185°F.	
Unstuffed (18 to 24 lbs.)		7–10	325°F.	180°–185°F.		
	Turkey Breast (4 to 6 lbs.)		16–19	325°F.	170°F.	

* Stuffed birds generally require 30–45 minutes additional roasting time. Shield legs and breast with foil to prevent over-browning and drying of skin.

† The U.S. Department of Agriculture says "Rare beef is popular, but you should know that cooking it to only 140°F. means some food poisoning organisms may survive." (Source: Safe Food Book. Your Kitchen Guide. USDA Rev. June 1985.)

- 8 When the internal temperature of the meat reaches the number you have set, the probe and the oven turn off and the oven control signals. To stop the signal, press the **CLEAR/OFF** pad. Use hot pads to remove the probe from the food. Do not use tongs to pull on it—they might damage it.

CAUTION: To prevent possible burns, do not unplug the probe from the oven outlet until the oven has cooled. Do not store the probe in the oven.

NOTE:

- If the probe is removed from the food before the final temperature is reached, a tone will sound and the display will flash until the probe is removed from the oven.
- You will hear a fan while cooking with this feature. The fan will stop when the door is opened but the heat will not turn off.
- You can use the timer even though you cannot use timed oven operations.
- On double oven models, you will not be able to use the probe in the upper oven during timed oven operations. This is because with the probe you are cooking by temperature rather than time.

Using the timed features for convection baking.

On double oven models, you can use timed baking in one oven while using self-clean in the other; you can also use timed baking in both ovens at the same time.

You will hear a fan while cooking with this feature. The fan will stop when the door is opened but the heat will not turn off.

NOTE: Foods that spoil easily—such as milk, eggs, fish, stuffings, poultry and pork—should not be allowed to sit for more than 1 hour before or after cooking. Room temperature promotes the growth of harmful bacteria. Be sure that the oven light is off because heat from the bulb will speed harmful bacteria growth.

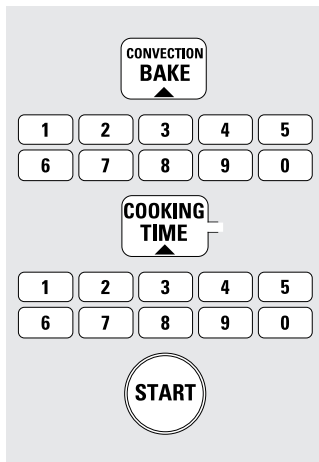

How to Set an Immediate Start and Automatic Stop

The oven will turn on immediately and cook for a selected length of time. At the end of the cooking time the oven will turn off automatically.

Make sure the clock shows the correct time of day.

- 1 Press the **CONVECTION BAKE** pad.
- 2 Press the number pads to set the desired oven temperature.
- 3 Press the **COOKING TIME** pad.

NOTE: If your recipe requires preheating, you may need to add additional time to the length of the cooking time.

- 4 Press the number pads to set the desired length of cooking time. The minimum cooking time you can set is 1 minute. The oven temperature that you set and the cooking time that you entered will be in the display.

- 5 Press the **START** pad.

The display shows the oven temperature that you set and the cooking time countdown. The display starts changing once the temperature reaches 100°F.

NOTE: On double oven models when using both ovens at the same time, the times showing in the display will be for the last oven set. To display the time set for the first oven set, press the **COOKING TIME** pad for that oven.

- 6 At the end of timed convection bake the oven will turn off. The end of cycle tone will sound. Press the **CLEAR/OFF** pad to clear the display if necessary.
- 7 Remove the food from the oven. Remember, foods that are left in the oven continue cooking after the controls are off.

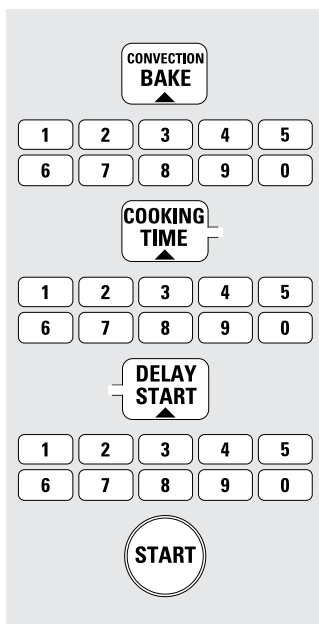

How to Set a Delayed Start and Automatic Stop

You can set the oven control to delay-start the oven, cook for a specific length of time and then turn off automatically.

Make sure the clock shows the correct time of day.

- 1 Press the **CONVECTION BAKE** pad.
- 2 Press the number pads to set the desired oven temperature.
- 3 Press the **COOKING TIME** pad.

NOTE: If your recipe requires preheating, you may need to add additional time to the length of the cooking time.

- 4 Press the number pads to set the desired cooking time.
- 5 Press the **DELAY START** pad.
- 6 Press the number pads to set the time of day you want the oven to turn on and start cooking.

If you would like to check the times you have set, press the **DELAY START** pad to check the start time you have set or press the **COOKING TIME** pad to check the length of cooking time you have set.

- 7 Press the **START** pad.

NOTE: An attention tone will sound if you are using timed baking and do not press the **START** pad after entering the baking temperature.

When the oven turns on at the time of day you have set, the display will show the changing temperature (starting at 100°F.) and the cooking time countdown.

NOTE: On double oven models when using both ovens at the same time, the times showing in the display will be for the last oven set. To display the time set for the first oven set, press the **DELAY START** or **COOKING TIME** pad for that oven.

At the end of timed convection bake the oven will turn off. The end of cycle tone will sound.

- 8 Press the **CLEAR/OFF** pad to clear the display if necessary. When baking is finished, remove the food from the oven. Remember, even though the oven shuts off automatically, foods continue cooking after the controls are off.

Using the proofing feature *(on some models)*

The proofing feature maintains a warm environment useful for rising yeast-leavened products.

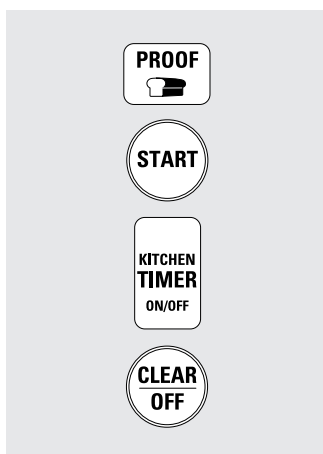

How to Set the Oven For Proofing

- 1 Place the covered dough in a dish in the oven on shelf B or C.

NOTE: For best results, cover the dough with a cloth or with greased plastic wrap (the plastic may need to be anchored underneath the container so the oven fan will not blow it off).

- 2 Press the **PROOF** pad and then the **START** pad.

The display will read **BRD** (bread).

The oven interior light turns on and remains on during proofing.

The proofing feature automatically provides the optimum temperature for the proofing process and therefore does not have a temperature adjustment.

- 3 Set the **KITCHEN TIMER** for the minimum proof time.

- 4 When proofing is finished, press the **CLEAR/OFF** pad.

- To avoid lowering the oven temperature and lengthening proofing time, do not open the oven door unnecessarily.
- Check bread products early to avoid over-proofing.

NOTE:

- Do not use the proofing mode for warming food or keeping food hot. The proofing oven temperature is not hot enough to hold foods at safe temperatures.
- Proofing feature on upper oven only.
- Proofing will not operate when oven is above 150 degrees. "HOT" will show in the display.

Using the gourmet shelf and baking stones *(on some models)*

The gourmet shelf and baking stones are excellent for baking bread and pizza.

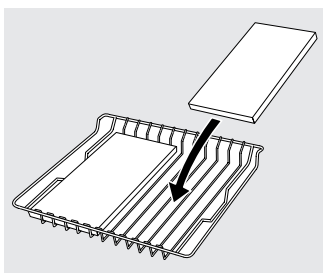

Carefully place the stones on the offset rack.

Do not drop the stones onto the rack or chipping may occur.

To remove the stones place a hand under the rack and push up on the stones.

- The shelf should be placed in the second rack position from the bottom and the stones carefully placed on it. Preheat to the desired baking temperature.
- Always preheat the stones before using them. For best results do not use baking stones with rising crust pizzas.

When using the gourmet shelf bake at the same temperature and for the same time that you would normally.

- Use a pizza peel (special wood paddle) to place pizza on or off the baking stones. Sprinkle corn meal on the baking stones and the peel to prevent sticking.
- The baking stones become very hot in the oven. Allow the stones to cool before removing them from the oven. Always use a heavy potholder or oven glove when handling the baking stones.

- The stones are made of a porous ceramic material and it is normal for the stones to accumulate stains with use. This will not affect their baking capabilities in any way.

Avoid sudden temperature changes. Don't place the heated stones on a cold surface or immerse them in water.

- Do not leave the stones in your oven when they are not being used. Baking times and browning may be affected.

Adjust the oven thermostat—Do it yourself!

You may find that your new oven cooks differently than the one it replaced. Use your new oven for a few weeks to become more familiar with it. If you still think your new oven is too hot or too cold, you can adjust the thermostat yourself.

Do not use thermometers, such as those found in grocery stores, to check the temperature setting of your oven. These thermometers may vary 20–40 degrees.

NOTE: This adjustment will not affect the broiling or the self-cleaning temperatures. The adjustment will be retained in memory after a power failure.

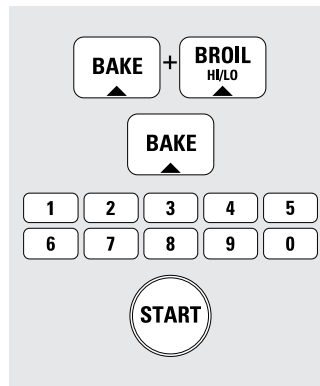

To Adjust the Thermostat

- 1 Press the **BAKE** and **BROIL HI/LO** pads at the same time for 3 seconds until the display shows **SF**.
- 2 Press the **BAKE** pad for the oven which you want to use. A two digit number shows in the display.
Press **BAKE** again to alternate between increasing and decreasing the oven temperature.
- 3 The oven temperature can be adjusted up to (+) 35°F. hotter or (-) 35°F. cooler. Press the number pads the same way you read them. For example, to change the oven temperature 15°F., press **1** and **5**.
- 4 When you have made the adjustment, press the **START** pad to go back to the time of day display. Use your oven as you would normally.

The type of margarine will affect baking performance!

Most recipes for baking have been developed using high fat products such as butter or margarine (80% fat). If you decrease the fat, the recipe may not give the same results as with a higher fat product.

Recipe failure can result if cakes, pies, pastries, cookies or candies are made with low fat spreads. The lower the fat content of a spread product, the more noticeable these differences become.

Federal standards require products labeled “margarine” to contain at least 80% fat by weight. Low fat spreads, on the other hand, contain less fat and more water. The high moisture content of these spreads affect the texture and flavor of baked goods. For best results with your old favorite recipes, use margarine, butter or stick spreads containing at least 70% vegetable oil.

Using the self-cleaning oven.

The oven door must be closed and all controls must be set correctly for the cycle to work properly.

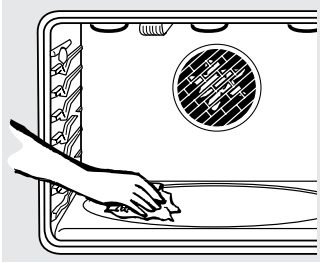

Wipe up heavy soil on the oven bottom. (appearance may vary)

Before a Clean Cycle

The oven must be cool in order to set the self-clean cycle.

We recommend venting your kitchen with an open window or using a ventilation fan or hood during the first self-clean cycle.

Remove the broiler pan, broiler grid, probe, all cookware and any aluminum foil from the oven.

The oven shelves and convection roasting rack can be self-cleaned, but they will darken, lose their luster and become hard to slide.

Do not use abrasives or oven cleaners. Clean the top, sides and outside of the oven door with soap and water.

Make sure the oven light bulb cover (on some models) is in place and the oven light is off.

IMPORTANT: The health of some birds is extremely sensitive to the fumes given off during the self-cleaning cycle of any oven. Move birds to another well ventilated room.

- On double oven models, you can set a clean cycle in both ovens at the same time. The last oven set will automatically delay its start until the end of the first oven's clean cycle.
- On double oven models, you can use timed baking in one oven and self-clean the other at the same time.

How to Set the Oven for Cleaning

- 1 Press the **SELF CLEAN** pad.
- 2 Using the number pads, enter the desired clean time, if a time other than 4 hours is needed.

Clean cycle time is normally 4 hours. You can change the clean time to any time between 3 hours and 5 hours, depending on how dirty your oven is.

- 3 Press the **START** pad.

The door locks automatically. The display will show the clean time remaining. It will not be possible to open the oven door until the temperature drops below the lock temperature and the **LOCKED DOOR** light goes off.

When the **LOCKED DOOR** light is off, open the door.

- The words **LOCK DOOR** will flash and the oven control will signal if you set the clean cycle and forget to close the oven door.
- To stop a clean cycle, press the **CLEAR/OFF** pad. When the **LOCKED DOOR** light goes off indicating the oven has cooled below the locking temperature, open the door.

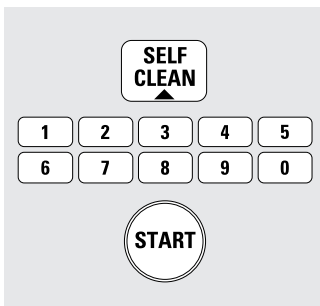

Using the self-cleaning oven.

The oven door must be closed and all controls must be set correctly for the cycle to work properly.

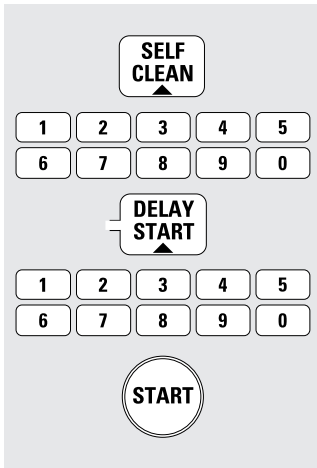

How to Delay the Start of Cleaning

- 1 Press the **SELF CLEAN** pad.
- 2 Using the number pads, enter the desired clean time.
- 3 Press the **DELAY START** pad.
- 4 Using the number pads, enter the time of day you want the clean cycle to start.
- 5 Press the **START** pad.

The door locks automatically. The display will show the start time. It will not be possible to open the oven door until the temperature drops below the lock temperature and the **LOCKED DOOR** light goes off.

When the **LOCKED DOOR** light is off, open the door.

NOTE: On double oven models, you can set a delay clean in both ovens at the same time. The second oven set will automatically delay the start of cleaning until the end of the first oven's clean cycle.

To recall the start time of the second oven set, press the **DELAY START** pad on the controls for the second oven.

After a Clean Cycle

You may notice some white ash in the oven. Wipe it up with a damp cloth after the oven cools.

If white spots remain, remove them with a soap-filled steel wool pad and rinse thoroughly with a vinegar and water mixture.

These deposits are usually a salt residue that cannot be removed by the clean cycle.

If the oven is not clean after one clean cycle, repeat the cycle.

■ You cannot set the oven for cooking until the oven is cool enough for the door to unlock.

■ While the oven is self-cleaning, you can press the **CLOCK** pad to display the time of day. To return to the clean countdown, press the **SELF CLEAN** pad.

■ If the shelves become hard to slide, wipe the shelf supports with cooking oil.

Care and cleaning of the oven.

Be sure electrical power is off and all surfaces are cool before cleaning any part of the oven.

How to Remove Packaging Tape

To assure no damage is done to the finish of the product, the safest way to remove the adhesive left from packaging tape on new appliances is an application of a household liquid dishwashing detergent, mineral oil or cooking oil.

Apply with a soft cloth and allow to soak. Wipe dry and then apply an appliance polish to thoroughly clean and protect the surface.

NOTE: The plastic tape must be removed from all chrome trim. It cannot be removed if it is baked on.

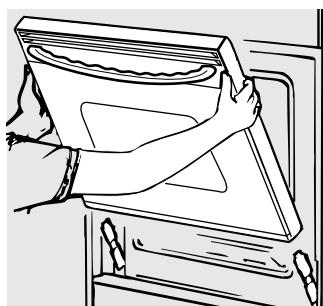

Lift the door straight up and off the hinges.

Lift-Off Oven Door

The oven door is removable for easier access to the light bulb.

Do not lift the door by the handle.

To remove the door, open it to the broil stop position. Grasp firmly on each side and lift the door straight up and off the hinges.

Do not place hands between the hinge and the oven door frame.

To replace the door, make sure the hinges are in the broil stop position. Position the slots in the bottom of the door squarely over the hinges and slowly lower it over both hinges.

To clean the inside of the door:

- Because the area inside the gasket is cleaned during the self-clean cycle, you do not need to clean this by hand.
- The area outside the gasket and the front frame can be cleaned with a soap-filled steel wool or plastic pad, hot water and detergent. Rinse well with a vinegar and water solution.

To clean the outside of the door:

- Use soap and water to thoroughly clean the top, sides and front of the oven door. Rinse well. You may also use a glass cleaner to clean the glass on the outside of the door. Do not let water drip into the vent openings.
- Spillage of marinades, fruit juices, tomato sauces and basting materials containing acids may cause discoloration and should be wiped up immediately. When surface is cool, clean and rinse.
- Do not use oven cleaners, cleaning powders or harsh abrasives on the outside of the door.

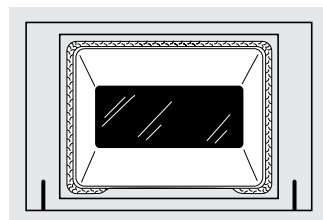

The gasket is designed with a gap at the bottom to allow for proper air circulation.

Do not rub or clean the door gasket—it has an extremely low resistance to abrasion.

If you notice the gasket becoming worn, frayed or damaged in any way or if it has become displaced on the door, you should have it replaced.

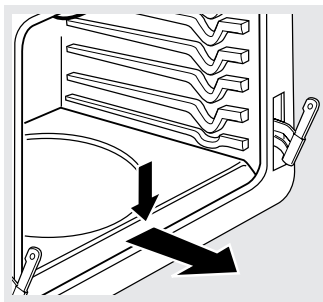

Press down and pull out.

Removable Oven Floor

To remove the oven floor:

- 1 Remove the oven door using the instructions in the *Lift-Off Oven Door* section of this manual.
- 2 Press down and pull out the removable oven floor.
- 3 Clean the oven floor with warm soapy water.

- 4 When re-installing the oven floor be sure to slide it all the way to the back of the oven.

IMPORTANT: Always replace the removable floor before the next use.

Care and cleaning of the oven.

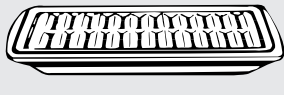

After broiling, remove the broiler pan from the oven.

Broiler Pan & Grid

Do not clean the broiler pan or grid in a self-cleaning oven.

After broiling, remove the broiler pan from the oven. Remove the grid from the pan. Carefully pour out the grease from the pan into a proper container.

Wash and rinse the broiler pan and grid in hot water with a soap-filled or plastic scouring pad.

If food has burned on, sprinkle the grid with detergent while hot and cover with wet paper towels or a dishcloth. Soaking the pan will remove burned-on foods.

Both the broiler pan and grid may be cleaned with a commercial oven cleaner.

Both the broiler pan and grid can also be cleaned in a dishwasher.

Do not store a soiled broiler pan and grid anywhere in the oven.

Control Panel

It's a good idea to wipe the control panel after each use. Clean with mild soap and water or vinegar and water, rinse with clean water and polish dry with a soft cloth.

Do not use abrasive cleansers, strong liquid cleansers, plastic scouring pads or oven cleansers on the control panel—they will damage the finish. A 50/50 solution of vinegar and hot water works well.

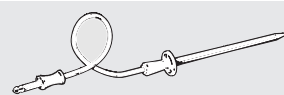

Probe

The temperature probe may be cleaned with soap and water or a soap-filled scouring pad. Cool the temperature probe before cleaning. Scour stubborn spots with a soap-filled scouring pad, rinse and dry.

■ Do not immerse the temperature probe in water.

■ Do not store the temperature probe in the oven.

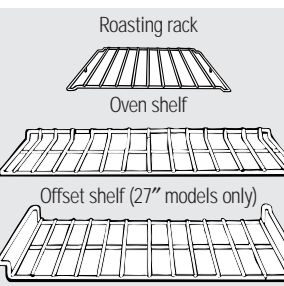

Oven Shelves and Convection Roasting Rack

Clean the oven shelves (including the offset shelf) and the convection roasting rack with an abrasive cleanser or steel wool. After cleaning, rinse the shelves and rack with clean water and dry with a clean cloth.

NOTE: The oven shelves and convection roasting rack may be cleaned in the self-cleaning oven. However, the shelves will darken in color, lose their luster and become hard to slide if cleaned during the self-cleaning cycle. You can wipe the shelf supports with cooking oil after self-cleaning to make the shelves slide more easily.

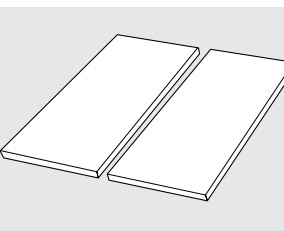

Baking Stones (on some models)

The baking stones are made of a porous ceramic material and it is normal for them to accumulate stains with use.

If you must clean them, allow them to cool. Scrape off soil and rinse well in warm water.

■ Do not wash with soaps and detergents as they may be absorbed by the stones and may transfer an unwanted taste.

■ Do not wash in an automatic dishwasher.

■ Allow the stones to cool completely before cleaning.

■ Do not put hot stones into water.

■ Make sure that the stones are thoroughly dry before baking.

■ Do not wash in an automatic dishwasher.

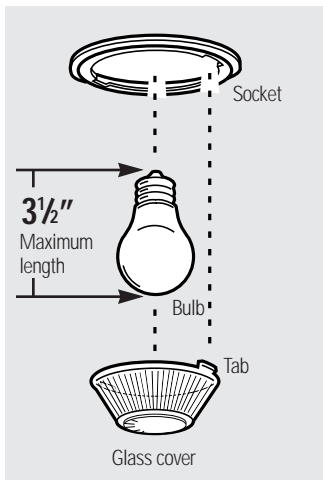

Oven Light Bulb (on some models)

NOTE: The glass cover (on some models) should be removed only when cold. Wearing latex gloves may offer a better grip.

Before replacing the bulb, disconnect electrical power to the oven at the main fuse or circuit breaker panel. Let the bulb cool completely before removing it. For your safety, do not touch a hot bulb with a damp cloth. If you do, the bulb will break.

To remove:

Turn the glass cover counterclockwise 1/4 turn until the tabs of the glass cover clear the grooves of the socket. Remove the bulb.

To replace:

Put in a new 40-watt appliance bulb. Place the tabs of the glass cover into the groove of the socket. Turn the glass cover clockwise 1/4 turn.

NOTE:

- A 40-watt appliance bulb is smaller than a standard 40-watt household bulb.
- Reconnect electrical power to the oven.
- For improved lighting inside the oven, clean the glass cover frequently using a wet cloth. This should be done when the oven is completely cool.

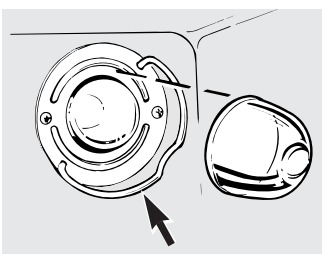

Wire cover holder

Oven Light Bulb (on some models)

CAUTION: Before replacing your oven light bulb, disconnect the electrical power to the oven at the main fuse or circuit breaker panel.

Be sure to let the light cover and bulb cool completely.

To remove the cover:

- 1 Hold a hand under the cover so it doesn't fall when released. With fingers of the same hand, firmly push back the wire cover holder. Lift off the cover.

Do not remove any screws to remove the cover.

- 2 Replace bulb with a 40-watt appliance bulb.

To replace the cover:

- 1 Place it into groove of the light receptacle. Pull wire forward to the center of the cover until it snaps into place.
- 2 Connect electrical power to the oven.

Stainless Steel (on some models)

Clean with warm sudsy water, a stainless steel cleaner such as Kleen King[®] or an all-purpose liquid or spray cleaner. Always scrub in the direction of the grain.

Rinse thoroughly with a sponge or cloth and clean water. Dry with a soft, clean cloth.

Do not use abrasive cleaners or a soap-filled steel wool pad, they will scratch the surface.

Oven Heating Elements

Do not clean the broil element. Any soil will burn off when the element is heated.

The bake element is not exposed and is under the removable oven floor. If spillovers, residue or ash accumulate on the removable oven floor, wipe up before self-cleaning.

To clean the oven floor, take out the removable floor and gently lift the bake element. Clean with warm soapy water. Always replace the removable floor before next use.

Before You Call For Service...



Troubleshooting Tips

Save time and money! Review the charts on the following pages first and you may not need to call for service.

Problem	Possible Causes	What To Do
Control signals after entering cooking time or delay start	You forgot to enter a bake temperature or cleaning time.	<ul style="list-style-type: none"> Press the BAKE pad and desired temperature or the SELF CLEAN pad and desired clean time.
Food does not bake or roast properly	Oven controls improperly set.	<ul style="list-style-type: none"> See the <i>Using the oven</i> section.
	Shelf position is incorrect or the shelf is not level.	<ul style="list-style-type: none"> See the <i>Using the oven</i> section.
	Incorrect cookware or cookware of improper size being used.	<ul style="list-style-type: none"> See the <i>Using the oven</i> section.
	Oven floor not in place.	<ul style="list-style-type: none"> Replace the oven floor.
	Oven thermostat needs adjustment.	<ul style="list-style-type: none"> See the <i>Adjust the oven thermostat—Do it yourself!</i> section.
Food does not broil properly	Door not open to the broil stop position as recommended.	<ul style="list-style-type: none"> See the <i>Using the oven</i> section.
	Oven controls improperly set.	<ul style="list-style-type: none"> Make sure you press the BROIL HI/LO pad.
	Improper shelf position being used.	<ul style="list-style-type: none"> See the <i>Broiling Guide</i>.
	Food being cooked in a hot pan.	<ul style="list-style-type: none"> Use the broiling pan and grid that came with your oven. Make sure it is cool.
	Cookware not suited for broiling.	<ul style="list-style-type: none"> Use the broiling pan and grid that came with your oven.
	The probe is plugged into the outlet in the oven.	<ul style="list-style-type: none"> Unplug and remove the probe from the oven.
	Aluminum foil used on the the broiling pan and grid has not been fitted properly and slit as recommended.	<ul style="list-style-type: none"> See the <i>Using the oven</i> section.
	In some areas the power (voltage) may be low.	<ul style="list-style-type: none"> Preheat the broil element for 10 minutes. Broil for the longest period of time recommended in the <i>Broiling Guide</i>.
Clock and timer do not work	A fuse in your home may be blown or the circuit breaker tripped.	<ul style="list-style-type: none"> Replace the fuse or reset the circuit breaker.
	Oven controls improperly set.	<ul style="list-style-type: none"> See the <i>Using the clock and timer</i> section.
Oven light does not work	Light bulb is loose or defective.	<ul style="list-style-type: none"> Tighten or replace the bulb.
	Pad operating light is broken.	<ul style="list-style-type: none"> Call for service.

Problem	Possible Causes	What To Do
<i>Oven temperature too hot or too cold</i>	Oven thermostat needs adjustment.	<ul style="list-style-type: none"> • See the <i>Adjust the oven thermostat—Do it yourself!</i> section.
<i>Oven will not work</i>	<p>A fuse in your home may be blown or the circuit breaker tripped.</p> <p>Oven controls improperly set.</p>	<ul style="list-style-type: none"> • Replace the fuse or reset the circuit breaker. • See the <i>Using the oven</i> section.
<i>Oven will not self-clean</i>	<p>The oven temperature is too high to set a self-clean operation.</p> <p>Oven controls improperly set.</p> <p>The probe is plugged into the outlet in the oven.</p>	<ul style="list-style-type: none"> • Allow the oven to cool to room temperature and reset the controls. • See the <i>Using the self-cleaning oven</i> section. • Remove the probe from the oven.
<i>“Crackling” or “popping” sound</i>	This is the sound of the metal heating and cooling during both the cooking and cleaning functions.	<ul style="list-style-type: none"> • This is normal.
<i>Excessive smoking during clean cycle</i>	Excessive soil.	<ul style="list-style-type: none"> • Press the CLEAR/OFF pad. Open the windows to rid the room of smoke. Wait until the LOCKED DOOR light goes off. Wipe up the excess soil and reset the clean cycle.
<i>Oven door will not open after a clean cycle</i>	Oven too hot.	<ul style="list-style-type: none"> • Allow the oven to cool below locking temperature.
<i>Oven not clean after a clean cycle</i>	<p>Oven controls not properly set.</p> <p>Oven was heavily soiled.</p>	<ul style="list-style-type: none"> • See the <i>Using the self-cleaning oven</i> section. • Clean up heavy spillovers before starting the clean cycle. Heavily soiled ovens may need to self-clean again or for a longer period of time.
<i>“LOCK DOOR” flashes in the display</i>	The self-clean cycle has been selected but the door is not closed.	<ul style="list-style-type: none"> • Close the oven door.
<i>LOCKED DOOR light is on when you want to cook</i>	The oven door is locked because the temperature inside the oven has not dropped below the locking temperature.	<ul style="list-style-type: none"> • Press the CLEAR/OFF pad. Allow the oven to cool.

Before You Call For Service...



Troubleshooting Tips

Problem	Possible Causes	What To Do
"F— and a number or letter" flash in the display	You have a function error code.	<ul style="list-style-type: none"> Press the CLEAR/OFF pad. Allow the oven to cool for one hour. Put the oven back into operation.
	If the function code repeats.	<ul style="list-style-type: none"> Disconnect all power to the oven for at least 30 seconds and then reconnect power. If the function error code repeats, call for service.
Display goes blank	A fuse in your home may be blown or the circuit breaker tripped.	<ul style="list-style-type: none"> Replace the fuse or reset the circuit breaker.
	The clock is in the black-out mode.	<ul style="list-style-type: none"> See the <i>Special features of your oven control</i> section.
Display flashes	Power failure.	<ul style="list-style-type: none"> Reset the clock.
Unable to get the display to show "SF"	Oven control pads were not pressed properly.	<ul style="list-style-type: none"> The BAKE and BROIL HI/LO pads (on double oven models use the upper oven controls) must be pressed at the same time and held for 3 seconds.
"Probe" appears in the display	This is reminding you to enter a probe temperature after plugging in the probe.	<ul style="list-style-type: none"> Enter a probe temperature.
Power outage, clock flashes	Power outage or surge.	<ul style="list-style-type: none"> Reset the clock. If the oven was in use, you must reset it by pressing the CLEAR/OFF pad, setting the clock and resetting any cooking function.
Steam from the vent	When using the convection feature, it is normal to see steam coming out of the oven vent. As the number of shelves or amount of food being cooked increases, the amount of visible steam will increase.	<ul style="list-style-type: none"> This is normal.
"Burning" or "oily" odor emitting from the vent	This is normal in a new oven and will disappear in time.	<ul style="list-style-type: none"> To speed the process, set a self-clean cycle for a minimum of 3 hours. See the <i>Using the self-cleaning oven</i> section.
Strong odor	An odor from the insulation around the inside of the oven is normal for the first few times the oven is used.	<ul style="list-style-type: none"> This is temporary.
Fan noise	A cooling fan or a convection fan (depending on the function you are using) may automatically turn on and off to cool internal parts.	<ul style="list-style-type: none"> This is normal. The cooling fan will turn off and on. The convection fan will run until the function is over or the door is opened.

GE Service Protection Plus™

GE, a name recognized worldwide for quality and dependability, offers you Service Protection Plus™—comprehensive protection on all your appliances—**No Matter What Brand!**

Benefits Include:

- **Backed by GE**
- **All brands covered**
- **Unlimited service calls**
- **All parts and labor costs included**
- **No out-of-pocket expenses**
- **No hidden deductibles**
- **One 800 number to call**

***We'll Cover Any Appliance.
Anywhere. Anytime.****

You will be completely satisfied with our service protection or you may request your money back on the remaining value of your contract. No questions asked. It's that simple.

Protect your refrigerator, dishwasher, washer and dryer, range, TV, VCR and much more—**any brand!** Plus there's no extra charge for emergency service and low monthly financing is available. Even icemaker coverage and food spoilage protection is offered. You can rest easy knowing that all your valuable household products are protected against expensive repairs.

Place your confidence in GE and call us in the U.S. toll-free at **800-626-2224** for more information.

*All brands covered, up to 20 years old, in the continental U.S.

 Cut here

Please place in envelope and mail to:

General Electric Company
Warranty Registration Department
P.O. Box 34070
Louisville, KY 40232-4070

Consumer Product Ownership Registration

Dear Customer:

Thank you for purchasing our product and thank you for placing your confidence in us. We are proud to have you as a customer!

Follow these three steps to protect your new appliance investment:

- 1** Complete and mail your Consumer Product Ownership Registration today. Have the peace of mind of knowing we can contact you in the unlikely event of a safety modification.
- 2** After mailing the registration below, store this document in a safe place. It contains information you will need should you require service. Our service number is 800-GE-CARES (800-452-2737).
- 3** Read your Owner's Manual carefully. It will help you operate your new appliance properly. If you have questions, or need more information call the GE Answer Center® 800.626.2000.

Model Number Serial Number

--	--

Important: If you did not get a registration card with your product, detach and return the form below to ensure that your product is registered.

 Cut here

Consumer Product Ownership Registration



Model Number Serial Number

--	--

Mr. Ms. Mrs. Miss

First Name

Last Name

Street Address

Apt. #

City

State Zip Code

Date Placed In Use
Month Day Year

Phone Number - -



GE Appliances

HOTPOINT

RCA

General Electric Company
Louisville, Kentucky 40225

GE Built-In Electric Oven Warranty



All warranty service provided by our Factory Service Centers or an authorized Customer Care® technician. For service, call 800-GE-CARES.

For The Period Of: **GE Will Replace, At No Charge To You:**

One Year
From the date of the original purchase

Any part of the oven which fails due to a defect in materials or workmanship. During this **full one-year warranty**, GE will also provide, **free of charge**, all labor and in-home service to replace the defective part.

What GE Will Not Cover:

- Service trips to your home to teach you how to use the product.
- Improper installation.
- Failure of the product if it is abused, misused, or used for other than the intended purpose or used commercially.
- Replacement of house fuses or resetting of circuit breakers.
- Damage to the product caused by accident, fire, floods or acts of God.
- Incidental or consequential damage to personal property caused by possible defects with this appliance.

This warranty is extended to the original purchaser and any succeeding owner for products purchased for home use within the USA. In Alaska, the warranty excludes the cost of shipping or service calls to your home.

Some states do not allow the exclusion or limitation of incidental or consequential damages. This warranty gives you specific legal rights, and you may also have other rights which vary from state to state. To know what your legal rights are, consult your local or state consumer affairs office or your state's Attorney General.

Warrantor: General Electric Company, Louisville, KY 40225

Safety Instructions

Operating Instructions

Care and Cleaning

Troubleshooting Tips

Customer Service

Service Telephone Numbers.



GE Answer Center® 800.626.2000

The GE Answer Center® is open 24 hours a day, 7 days a week.



In-Home Repair Service 800-GE-CARES (800-432-2737)

Expert GE repair service is only a phone call away.



Special Needs Service 800.626.2000

800-TDD-GEAC (800-833-4322)

GE offers, free of charge, a brochure to assist in planning a barrier-free kitchen for persons with limited mobility.



Service Contracts 800-626-2224

Purchase a GE service contract while your warranty is still in effect and you'll receive a substantial discount. GE Consumer Service will still be there after your warranty expires.

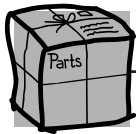

Parts and Accessories 800-626-2002

Individuals qualified to service their own appliances can have parts or accessories sent directly to their homes (VISA, MasterCard and Discover cards are accepted).

Instructions contained in this manual cover procedures to be performed by any user. Other servicing generally should be referred to qualified service personnel. Caution must be exercised, since improper servicing may cause unsafe operation.



Service Satisfaction

If you are not satisfied with the service you receive from GE:

First, contact the people who serviced your appliance.

Next, if you are still not pleased, write all the details—including your phone number—to:

Manager, Customer Relations
 GE Appliances
 Appliance Park
 Louisville, KY 40225

Finally, if your problem is still not resolved, write:

Major Appliance Consumer Action Program
 20 North Wacker Drive
 Chicago, IL 60606

Free Manuals Download Website

<http://myh66.com>

<http://usermanuals.us>

<http://www.somanuals.com>

<http://www.4manuals.cc>

<http://www.manual-lib.com>

<http://www.404manual.com>

<http://www.luxmanual.com>

<http://aubethermostatmanual.com>

Golf course search by state

<http://golfingnear.com>

Email search by domain

<http://emailbydomain.com>

Auto manuals search

<http://auto.somanuals.com>

TV manuals search

<http://tv.somanuals.com>