



GE Kaye

CTR -80

*Cold Temperature Reference
User's Guide*

World Headquarters

GE Kaye Instruments, Inc. • 101 Billerica Avenue, Building #7 • North Billerica, MA 01862 • USA
tel 978-262-0005, 800-964-5293 (US & Canada) • fax 978-439-8181 • email kaye@ge.com

European Headquarters

GE Kaye Europe • Sinsheimer Strasse 6 • D-75179 Pforzheim • Germany
tel +49 (0) 7231 14335 0 • fax +49 (0) 7231 14335 29 email info@kaye-europe.com

www.gekaye.com

Subject to change without notice. • Copyright 2002 • Printed in USA

Table of Contents

1	Before You Start	1
	1.1 Symbols Used.	1
	1.2 Safety Information	2
	1.2.1 Warnings.	2
	1.2.2 Cautions	4
	1.3 Customer Service Information	6
2	Introduction	7
3	Specifications and Environmental Conditions.	9
	3.1 Specifications.	9
	3.2 Environmental Conditions	9
	3.3 Hardware Warranty and Assistance.	10
	3.3.1 Instrument Warranty	10
	3.3.2 In-Warranty Repairs	10
	3.3.3 After-Warranty Repairs	10
	3.3.4 Equipment Maintenance Agreements.	11
	3.3.5 Customer Support.	11
	3.3.6 Customer Support Agreement	11
	3.3.7 Customer Site Assistance	11
4	Quick Start	13
	4.1 Unpacking.	13
	4.2 Set-up	13
	4.3 Power	14
	4.4 Setting the Temperature	14
5	Installation.	17
	5.1 Bath Environment.	17
	5.2 "Dry-out" Period	17
	5.3 Bath Preparation and Filling	17
	5.3.1 Drain Valve Installation Instructions	17
	5.3.2 Filling With Fluid	18
	5.4 Power	19
6	Bath Use	21
	6.1 General	21

6.2	Comparison Calibration	21
6.3	Calibration of Multiple Probes	22
7	Parts and Controls	23
7.1	Control Panel	23
7.2	Bath Tank and Lid.	24
7.3	Back Panel	24
8	General Operation	27
8.1	Bath Fluid	27
8.1.1	Temperature Range.	27
8.1.2	Viscosity.	27
8.1.3	Specific Heat	27
8.1.4	Thermal Conductivity	28
8.1.5	Thermal Expansion	28
8.1.6	Electrical Resistivity	28
8.1.7	Fluid Lifetime.	28
8.1.8	Safety	28
8.1.9	Cost	29
8.1.10	Commonly Used Fluids	29
8.1.10.1	Water (Distilled)	29
8.1.10.2	Ethanol	29
8.1.10.3	Mineral Oil	30
8.1.10.4	Silicone Oil (Dow Corning 200.05, 200.10, 200.20)	30
8.1.10.5	Halocarbon 0.8	30
8.1.11	Fluid Characteristics Table	30
8.1.11.1	Limitations and Disclaimer	31
8.2	Stirring	32
8.3	Power	32
8.4	Heater.	32
8.5	Refrigeration	32
8.5.1	Operation	33
8.5.2	Important Refrigerant Information	33
8.6	Temperature Controller	33
9	Controller Operation	35
9.1	Bath Temperature.	35
9.2	Temperature Set-point	35
9.2.1	Programmable Set-points	35
9.2.2	Set-point Value	37
9.2.3	Temperature Scale Units	37
9.3	Scan	38
9.3.1	Scan Control	38
9.3.2	Scan Rate	38

9.4	Secondary Menu	39
9.5	Heater Power	39
9.6	Proportional Band	39
9.7	Cutout	41
9.8	Controller Configuration	42
9.9	Operating Parameters	42
	9.9.1 High Limit	42
	9.9.2 Low Limit	42
	9.9.3 Cooling	43
9.10	Serial Interface Parameters	43
	9.10.1 Baud Rate	44
	9.10.2 Sample Period	44
	9.10.3 Duplex Mode	44
	9.10.4 Linefeed	45
9.11	Calibration Parameters	45
	9.11.1 Hard Cutout	46
	9.11.2 R	46
	9.11.3 ALPHA	46
	9.11.4 DELTA	46
	9.11.5 BETA	46
10	Digital Communication Interface	47
10.1	Serial Communications	47
	10.1.1 Wiring	48
	10.1.2 Setup	48
	10.1.2.1 Baud Rate	48
	10.1.2.2 Sample Period	49
	10.1.2.3 Duplex Mode	49
	10.1.2.4 Linefeed	49
	10.1.3 Serial Operation	49
10.2	Interface Commands	49
11	Calibration Procedure	53
11.1	Calibration Procedure	53
	11.1.1 Calibration Equipment	53
	11.1.2 Calibration	53
12	Maintenance	55
13	Trouble Shooting	57
13.1	Troubleshooting	57
13.2	CE Comments	58
	13.2.1 EMC Directive	58
	13.2.2 Low Voltage Directive (Safety)	58

13.3 Wiring Diagram. 59

Figures

Figure 1	Drain Valve Installation—IMPORTANT: Do Not Over Tighten. Follow the installation instructions above.	18
Figure 2	CTR-80 Control Panel	23
Figure 3	Back Panel	25
Figure 4	Controller Operation Flowchart	36
Figure 5	Serial Cable Wiring	48
Figure 6	Wiring Diagram	59

Tables













Table 1	International Electrical Symbols	1
Table 2	Table of Various Bath Fluids	31
Table 3	Controller Communications Commands.	50
Table 3	Controller Communications Commands continued	51



1 Before You Start

1.1 Symbols Used

Table 1 lists the International Electrical Symbols. Some or all of these symbols may be used on the instrument or in this manual.

Table 1 *International Electrical Symbols*

Symbol	Description
	AC (Alternating Current)
	AC-DC
	Battery
	Complies with European Union directives
	DC
	Double Insulated
	Electric Shock
	Fuse
	PE Ground
	Hot Surface (Burn Hazard)
	Read the User's Manual (Important Information)
	Off
	On

Symbol	Description
	Canadian Standards Association
CAT II	OVERVOLTAGE (Installation) CATEGORY II, Pollution Degree 2 per IEC1010-1 refers to the level of Impulse Withstand Voltage protection provided. Equipment of OVERVOLTAGE CATEGORY II is energy-consuming equipment to be supplied from the fixed installation. Examples include household, office, and laboratory appliances.
	C-TIC Australian EMC mark

1.2 Safety Information

Use this instrument only as specified in this manual. Otherwise, the protection provided by the instrument may be impaired. Refer to the safety information below.

The following definitions apply to the terms “Warning” and “Caution”.

- “Warning” identifies conditions and actions that may pose hazards to the user.
- “Caution” identifies conditions and actions that may damage the instrument being used.

1.2.1



Warnings

To avoid personal injury, follow these guidelines.

GENERAL

- **DO NOT** use the instrument for any application other than calibration work. The instrument was designed for temperature calibration. Any other use of the unit may cause unknown hazards to the user.
- **DO NOT** use the unit in environments other than those listed in the user’s guide.
- **DO NOT** overfill the bath. Overflowing extremely cold or hot fluid may be harmful to the operator. See Section 5.3, Bath Preparation and Filling, for specific instructions.
- Follow all safety guidelines listed in the user’s manual.
- Calibration Equipment should only be used by Trained Personnel.

- If this equipment is used in a manner not specified by the manufacturer, the protection provided by the equipment may be impaired.
- Before initial use, or after transport, or after storage in humid or semi-humid environments, or anytime the instrument has not been energized for more than 10 days, the instrument needs to be energized for a "dry-out" period of 2 hours before it can be assumed to meet all of the safety requirements of the IEC 1010-1. If the product is wet or has been in a wet environment, take necessary measures to remove moisture prior to applying power such as storage in a low humidity temperature chamber operating at 50 degree centigrade for 4 hours or more.
- **DO NOT** operate high temperature baths (500°C) near flammable materials. Extreme temperatures could ignite the flammable material.
- Overhead clearance is required. Do not place the instrument under a cabinet or other structure. Always leave enough clearance to allow for safe and easy insertion and removal of probes.
- The instrument is intended for indoor use only.

BURN HAZARD

- Extremely cold temperatures may be present in this equipment. Freezer burns and frostbite may result if personnel fail to observe safety precautions.
- High temperatures may be present in this equipment. Fires and severe burns may result if personnel fail to observe safety precautions.

ELECTRICAL HAZARD

- These guidelines must be followed to ensure that the safety mechanisms in this instrument will operate properly. This instrument must be plugged into a 115 VAC, 60Hz (230 VAC, 50Hz optional), AC only electric outlet. The power cord of the instrument is equipped with a three-pronged grounding plug for your protection against electrical shock hazards. It must be plugged directly into a properly grounded three-prong receptacle. The receptacle must be installed in accordance with local codes and ordinances. Consult a qualified electrician. **DO NOT** use an extension cord or adapter plug.
- **DO** use a ground fault interrupt device. This unit contains a liquid. A ground fault device is advised in case liquid is present in the electrical system and could cause an electrical shock.
- Always replace the power cord with an approved cord of the correct rating and type. If you have questions, contact Kaye Customer Service.

- High voltage is used in the operation of this equipment. Severe injury or death may result if personnel fail to observe the safety precautions. Before working inside the equipment, turn off the power and disconnect the power cord.

BATH FLUIDS

- Fluids used in this unit may produce noxious or toxic fumes under certain circumstances. Consult the fluid manufacturer's MSDS (Material Safety Data Sheet). Proper ventilation and safety precautions must be observed.
- The instrument is equipped with a soft cutout (user settable firmware) and a hard cutout (set at the factory). Check the flash point, boiling point, or other fluid characteristic applicable to the circumstances of the unit operation. Ensure that the soft cutout is adjusted to the fluid characteristics of the application. As a guideline, the soft cutout should be set 10°C to 15°C below the flash point of the bath fluid. See Section , Heat Transfer Fluid, for specific information on bath fluids and Section , Cutout.

1.2.2



Cautions

- **THE DRAIN VALVE MUST BE INSTALLED ON THE BACK OF THE BATH BEFORE ATTEMPTING TO FILL THE TANK WITH FLUID.** See Section 5.3, page 17 for drain installation instructions.
- Always operate this instrument at room temperature between 41°F and 122°F (5°C to 50°C). Allow sufficient air circulation by leaving at least 6 inches (15 cm) of clearance around the instrument.
- **DO NOT** overfill the bath. Overflowing liquid may damage the electrical system. Be sure to allow for thermal expansion of the fluid as the bath temperature increases. See Section 5.3, Bath Preparation and Filling, for specific instructions.
- **DO NOT** change the values of the bath calibration constants from the factory set values. The correct setting of these parameters is important to the safety and proper operation of the unit.
- The refrigeration may be damaged or the lifetime shortened if the set-point temperature is set above 60°C for more than one hour with the refrigeration manually on. Ensure that the refrigeration is off when the unit is used above 60°C.
- The **Factory Reset Sequence** should be performed only by authorized personnel if no other action is successful in correcting a malfunction. You must have a copy of the most recent Report of Test to restore the test parameters.

- **DO NOT** operate this instrument in an excessively wet, oily, dusty, or dirty environment.
- The unit is a precision instrument. Although it has been designed for optimum durability and trouble free operation, it must be handled with care. Position the unit before the tank is filled with fluid. Use the handles provided to move the unit. Due to the weight of the compressor, it may require two people to safely move the bath. If two people are used, place one person in the front and one person in the back of the unit, carefully slide hands under the unit and lift in unison. The area containing the compressor will be heavier than the rest of the unit. **Do not move a unit filled with fluid.**
- Most probes have handle temperature limits. Be sure that the probe handle temperature limit is not exceeded in the air above the instrument.
- The instrument and any thermometer probes used with it are sensitive instruments that can be easily damaged. Always handle these devices with care. Do not allow them to be dropped, struck, stressed, or overheated.

COLD BATHS

- Refrigerated baths require that the condensing coil be cleaned periodically. Accumulation of dust and dirt on the condenser will result in premature failure of the compressor.
- This bath has been equipped with a brownout and over voltage protection device as a safety feature to protect the system components.
- **Mode of Operation:** This bath needs to be plugged into the line voltage for at least 2 minutes before operation. This is only necessary for the first time that the bath is energized or when it is moved from one location to another. Turning the bath ON or OFF does not trigger the delay.
- If a High/Low voltage condition exists for longer than 5 seconds, the bath de-energizes. An amber indicator on the back panel lights when this condition exists.
- Re-energization is automatic upon correction of the fault condition and after a delay cycle of about 2 minutes. If a fault condition exists upon application of power, the bath will not energize.
- Under and Over Voltage Protection at 115 VAC
 - ◆ Voltage Cutout: $\pm 12.5\%$ (101 - 129 VAC)
 - ◆ Voltage Cut In: $\pm 7.5\%$ (106 - 124 VAC)
- Under and Over Voltage Protection at 230 VAC
 - ◆ Voltage Cutout: $\pm 12.5\%$ (203 - 257 VAC)

- ♦ Voltage Cut In: $\pm 7.5\%$ (213 - 247 VAC)

1.3 Customer Service Information

Kaye Instruments can be contacted by writing to:

World Headquarters

GE Kaye Instruments, Inc.
101 Billerica Avenue, Building 7
North Billerica, MA 01862
tel. +1 (978) 262 0005
fax +1 (978) 439 8181
e-mail kaye@ge.com

European Headquarters

GE Kaye Europe GmbH
Sinsheimer Strasse 6
D-75179 Pforzheim, Germany
tel. +49-(0)-7231-14335-0
fax +49-(0)-7231-14335-29
e-mail info@kaye-europe.com
service@kaye-europe.com

When contacting Kaye Instruments Customer Service, please have the following information available:

- Model Number
- Serial Number
- Voltage
- Complete description of the problem

2 Introduction

The Kaye CTR –80 is an ultra low temp bath useful in temperature calibration and other applications requiring stable temperatures. An innovative state of the art solid-state temperature controller has been incorporated which maintains the bath temperature with extreme stability. The temperature controller uses a micro-controller to execute the many operating functions.

The user interface is provided by the 8-digit LED display and four key-switches. Digital remote communications is available with an RS-232 interface.

The CTR –80 was designed to be compact and low cost without compromising performance. The CTR –80 operates over a wide temperature range from –80°C to 30°C and 50°C 100°C.

3 Specifications and Environmental Conditions

3.1 Specifications

Range	–80°C to 100°C (–112°F to 212°F)
Ambient Operating Range	15°C to 25°C (59°F to 77°F)
Stability	±0.006°C at –80°C (ethanol) ±0.010°C at 0°C (ethanol) ±0.010°C at 100°C (oil)
Uniformity	±0.008°C at –80°C (ethanol) ±0.012°C at 0°C (ethanol) ±0.012°C at 100°C (oil)
Set-Point Accuracy	±0.5°C
Set-Point Repeatability	±0.01°C
Resolution	0.01°
Access Opening	3.25" x 4.5" (86 x 114 mm)
Immersion Depth	7" (180 mm) max
Tank Capacity	1 gallon (4 liters)
Cooling Time	From 25°C to –80°C, 130 minutes
Refrigeration Cascade	Two ¼ HP compressors
Heater Power	500 W
Automation Package	Interface- <i>it</i> software and RS-232 included
Power	115 VAC (±10%), 60 Hz, 16 A or 230 VAC (±10%), 50 Hz, 8 A, specify, 1700 W
Size	12" W x 30" H x 24" D (305 x 762 x 610 mm)
Weight	115 lb. (52 kg)

3.2 Environmental Conditions

Although the instrument has been designed for optimum durability and trouble-free operation, it must be handled with care. The instrument should not be operated in an excessively dusty or dirty environment. Maintenance and cleaning recommendations can be found in the Maintenance Section of this manual.

The instrument operates safely under the following conditions:

- temperature range: 15–30°C (59–86°F)

- ambient relative humidity: 15–50%
- pressure: 75kPa–106kPa
- mains voltage within $\pm 10\%$ of nominal
- vibrations in the calibration environment should be minimized
- altitude less than 2,000 meters

3.3 Hardware Warranty and Assistance

3.3.1 Instrument Warranty

GE Kaye Instruments, Inc. warrants its products against defects in materials and workmanship for a period of 12 months from the date of shipment. GE Kaye Instruments, Inc. will, at its option, repair or replace products which prove defective during this warranty period provided they are returned to our facility in Billerica, Massachusetts, European warranty returns are sent to Pforzheim, Germany. Repairs necessitated by misuse of this product are not covered by this warranty. No other warranties are expressed or implied, including but not limited to the implied warranties of merchantability and fitness for a particular purpose. GE Kaye Instruments, Inc. is not liable for consequential damages.

3.3.2 In-Warranty Repairs

Customers are requested to discuss their problem with a Kaye Service Representative to insure a prompt and accurate assessment of their needs. Frequently, a problem can be resolved via phone or FAX with minimal inconvenience or delay.

If necessary, the Customer Service Representative will send replacement parts or authorize the return of the instrument to the factory for repair. Instruments serviced in this manner will be repaired, completely tested, and calibrated prior to shipment.

When an instrument is returned to the factory, the customer must prepay the freight charges. Kaye will prepay freight charges for the instrument's return via a comparable shipment method.

If Field Service is required under the warranty, the customer is responsible for travel and living expenses incurred by the Field Service Representative.

3.3.3 After-Warranty Repairs

Customers are requested to discuss their problem with a Kaye Service Representative to insure a prompt assessment of their needs. Frequently, a customer

installed exchange part will solve the problem with minimal inconvenience and expense.

Factory repairs can frequently be completed on a fixed price basis. A base service fee plus labor and materials will be charged in lieu of the fixed repair price upon customer request or if extensive repairs are required.

Customers are requested to obtain a return authorization number prior to returning any instrument for service.

All instruments serviced at the factory will be repaired, updated, calibrated, and completely tested prior to shipment.

3.3.4 Equipment Maintenance Agreements

An optional Equipment Maintenance Agreement provides an annual preventive maintenance visit with certified recalibration, plus replacement parts throughout the year. Contact the Customer Service Department at (800) 964-5293 for details and prices. European customers contact the Customer Service Department at +49 (0) 7231 14335 0.

3.3.5 Customer Support

Within 90 days of shipment from the factory, installation and initial configuration assistance will be provided by a Customer Service Representative via phone or FAX at no charge.

After 90 days from shipment, technical assistance or consultation will be limited to identification and resolution of instrument failures, unless a Customer Support Agreement has been purchased.

3.3.6 Customer Support Agreement

An optional Customer Support Agreement provides additional phone or FAX technical assistance for installation or program development. Contact the Customer Service Department for details.

3.3.7 Customer Site Assistance

Kaye can provide optional onsite assistance with installation, initial operation, and training of plant personnel. Contact the Customer Service Department for details.

4 Quick Start



Caution: READ SECTION 6 TITLED BATH USE before placing the bath in service. Incorrect handling can damage the bath and void the warranty.

This chapter gives a brief summary of the steps required to set up and operate the bath. This should be used as a general overview and reference and not as a substitute for the remainder of the manual. Please read Section 5 through 8 carefully before operating the bath.

4.1 Unpacking

Unpack the bath carefully and inspect it for any damage that may have occurred during shipment. If there is shipping damage, notify the carrier immediately. Verify that all components are present:

- CTR –80 Bath
- Access Hole Cover
- Manual
- RS-232 Cable
- Report of Test
- Drain Valve

4.2 Set-up



Caution: The drain valve must be installed on the back of the bath before attempting to fill the tank with fluid. See Section 5.3, on page 17 for drain installation instructions.



Warning: The instrument is equipped with a soft cutout (user settable firmware) and a hard cutout (set at the factory). Check the flash point, boiling point, or other fluid characteristic applicable to the circumstances of the unit operation. Ensure that the soft cutout is adjusted to the fluid characteristics of the application. As a guideline, the soft cutout should be set 10°C to 15°C below the flash point of the bath fluid. See Section , Heat Transfer Fluid, for specific information on bath fluids and Section , Cut-out.

Set up of the bath requires careful unpacking and placement of the bath, installing the drain valve, filling the bath with fluid, and connecting power. Consult Section 5 for detailed instructions for proper installation of the bath. Be sure to place the bath in a safe, clean and level location. Install the drain valve onto the pipe fitting at the back of the bath and make sure the valve is closed. See Section 5.3, Bath Preparation and Filling. Be sure to place the bath in a safe, clean and level location.

Fill the bath tank with an appropriate liquid. For operation at moderate bath temperatures, clean distilled water works well. For lower temperatures, ethanol (denatured) works well but is **NOT USABLE AT HIGHER TEMPERATURES** due to flammability.

Carefully pour the fluid into the bath tank through the large rectangular access hole above the tank avoiding spilling any fluid. The fluid must not exceed a height of 1/2 inch below the top of the tank or be less than 2 inches below the top.

4.3 Power

Plug the bath power cord into a mains outlet of the proper voltage, frequency, and current capability. See Section 3.1, Specifications, for power details. Refer to and read the CAUTION at the front of this manual concerning brownout and over voltage protection.

Turn the bath on using the front panel “POWER” switch. The bath will turn on and begin to heat or cool to reach the previously programmed temperature set-point. The front panel LED display will indicate the actual bath temperature. Set the cooling switch to “OFF” for temperatures above approximately 50°C. Set the switch to “ON” for lower temperatures. When the cooling switch has been turned on, the first stage compressor will power up. The second stage will come on automatically when proper conditions are met. This will take 2 to 4 minutes. Cooling in the bath will not begin until the second stage starts.

4.4 Setting the Temperature

In the following discussion and throughout this manual a solid box around the word SET, UP, DOWN or EXIT indicates the panel button to press while the dotted box indicates the display reading on the front panel. Explanation of the button function or display reading is written at the right.

To view or set the bath temperature set-point proceed as follows. The front panel LED display normally shows the actual bath temperature.

24.68 C *Bath temperature display*

When “SET” is pressed the display shows the set-point memory that is currently being used and its value. Eight set-point memories are available.



Access set-point selection

1. 25.0

Set-point 1, 25.0°C currently used

Press “SET” to select this memory and access the set-point value.



Access set-point value

⌈ 25.00

Current value of set-point 1, 25.00°C

Press “UP” or “DOWN” to change the set-point value.



Increment display

⌈ 30.00

New set-point value

Press SET to accept the new value. The bath begins heating or cooling to the new set-point.



Store new set-point

Press “EXIT” and the bath temperature will be displayed again.



Return to the temperature display

24.73 ⌈

Bath temperature display

The bath heats or cools until it reaches the new set-point temperature. Turn off the cooling to reach and control at higher temperatures.

When setting the set-point temperature be careful not to exceed the temperature limit of the bath fluid.

To obtain optimum control stability adjust the proportional band as discussed in Section 9.6.

5 Installation



Caution: READ SECTION 6 TITLED BATH USE before placing the bath in service. Incorrect handling can damage the bath and void the warranty.

5.1 Bath Environment

The CTR –80 Bath is a precision instrument which should be located in an appropriate environment. The location should be free of drafts, extreme temperatures and temperature changes, dirt, etc. The surface where the bath is placed must be level. Allow at least six inches around the bath for air circulation. The top surface of the bath may become hot at high temperatures. Beware of the danger of accidental fluid spills.

A fume hood should be used to remove any vapors given off by hot bath fluid.

5.2 “Dry-out” Period

Before initial use, after transport, and any time the instrument has not been energized for more than 10 days, the bath will need to be energized for a “dry-out” period of 1-2 hours before it can be assumed to meet all of the safety requirements of the IEC 1010-1.

5.3 Bath Preparation and Filling



Caution: Before filling the tank with fluid the drain valve must be installed onto the pipe fitting at the back of the bath.

5.3.1 Drain Valve Installation Instructions

The drain valve attaches to the swage fitting located on the lower backside of the bath. (See Figure 1.)

1. Place the valve onto the drain fitting and hand tighten in place by turning the hex nut (attached to the bath) counter clockwise while holding the valve stationary.
2. Using open-end wrenches, hold the valve in place and tighten the hex nub one quarter turn from the hand tightened position above.

The valve should be secured in place at this point. If not, repeat step number 2 being careful not to over tighten the assembly.

Ensure the valve handle is in the closed position before attempting to add fluid to the tank.

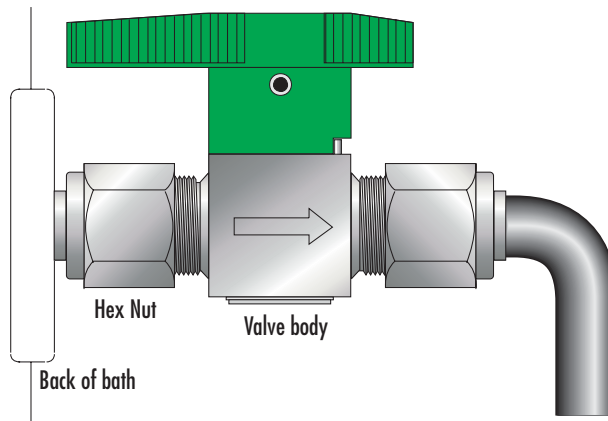

Figure 1 Drain Valve Installation—**IMPORTANT: Do Not Over Tighten.** Follow the installation instructions above.

5.3.2 Filling With Fluid

The CTR –80 Bath is not provided with a fluid. Depending on the desired temperature range, any of the following fluids, as well as others, may be used in the bath:

- Water
- Ethanol (Ethyl Alcohol)
- Ethylene glycol/water
- Mineral oil
- Silicone oil
- Halocarbon 0.8

Fluids are discussed in detail in Section 8.1.

Remove any access hole cover from the bath and check the tank for foreign matter (dirt, remnant packing material, etc.).

Fill the bath with clean unpolluted fluid. Fill the bath carefully through the large square access hole to a level that will allow for stirring and thermal expansion. **DO NOT** turn on the bath without fluid in the tank. The fluid should never exceed a height of 1/2" below the top of the tank or be less than 2 inches

below the top. Carefully monitor the bath fluid level as the bath temperature rises to prevent overflow or splashing. **Cautiously, remove excess hot fluid if necessary.**

5.4 Power

With the bath power switch off, plug the bath into an AC mains outlet of the appropriate voltage, frequency, and current capacity. See Section 3.1, Specifications, for power details. Refer to and read the CAUTION at the front of this manual concerning brownout and over voltage protection.

6 Bath Use



Caution: READ this section BEFORE PLACING THE BATH IN SERVICE

The information in this section is for general information only. It is not designed to be the basis for calibration laboratory procedures. Each laboratory will need to write their own specific procedures.

6.1 General

Be sure to select the correct fluid for the temperature range of the calibration. Bath fluids should be selected to operate safely with adequate thermal properties to meet the application requirements. Also, be aware that some fluids expand and could overflow the bath if not watched. Refer to General Operation, Section 8, for information specific to fluid selection and to the MSDS sheet specific to the fluid selected. The temperature range of any single fluid is likely less than that of the bath itself. This means that the type of bath fluid may have to change to cover the full range of the bath (see Section 8.1.1). Baths are most often set up to operate with a single fluid only over the useful range of that fluid. Other baths can be set up with other fluids to cover other temperature ranges required. This is generally the most productive and efficient approach.

The bath generates extreme temperatures. Precautions must be taken to prevent personal injury or damage to objects. Probes may be extremely hot or cold when removed from the bath. Cautiously handle probes to prevent personal injury. Carefully place probes on a heat/cold resistant surface or rack until they are at room temperature. It is advisable to wipe the probe with a clean soft cloth or paper towel before inserting it into another bath. This prevents the mixing of fluids from one bath to another. Always be sure that the probe is completely dry before inserting it into a hot fluid. **Some of the high temperature fluids react violently to water or other liquid mediums.** Be aware that cleaning the probe can be dangerous if the probe has not cooled to room temperature.

For optimum accuracy and stability, allow the bath adequate stabilization time after reaching the set-point temperature.

6.2 Comparison Calibration

Comparison calibration involves testing a probe (unit under test, UUT) against a reference probe. After inserting the probes to be calibrated into the bath, allow sufficient time for the probes to settle and the temperature of the bath to stabilize.

One of the significant dividends of using a bath rather than a dry-well to calibrate multiple probes is that the probes do not need to be identical in construc-

tion. The fluid in the bath allows different types of probes to be calibrated at the same time. However, stem effect from different types of probes is not totally eliminated. Even though all baths have horizontal and vertical gradients, these gradients are minimized inside the bath work area. Nevertheless, probes should be inserted to the same depth in the bath liquid. Be sure that all probes are inserted deep enough to prevent stem effect. We suggest a general rule-of-thumb for immersion depth to reduce the stem effect to a minimum: $20 \times$ the diameter of the UUT + the sensor length. **Do not submerge the probe handles.** If the probe handles get too warm during calibration at high temperatures, a heat shield could be used just below the probe handle. This heat shield could be as simple as aluminum foil slid over the probe before inserting it in the bath or as complicated as a specially designed reflective metal apparatus.

When calibrating over a wide temperature range, better results can generally be achieved by starting at the highest temperature and progressing down to the lowest temperature.

Probes can be held in place in the bath by using probe clamps or drilling holes in the access cover. Other fixtures to hold the probes can be designed. The object is to keep the reference probe and the probe(s) to be calibrated as closely grouped as possible in the working area of the bath. Bath stability is maximized when the bath working area is kept covered.

In preparing to use the bath for calibration start by:

- Placing the reference probe in the bath working area.
- Placing the probe to be calibrated, the UUT, in the bath working area as close as feasibly possible to the reference probe.

6.3 Calibration of Multiple Probes

Fully loading the bath with probes increases the time required for the temperature to stabilize after inserting the probes. Using the reference probe as the guide, be sure that the temperature has stabilized before starting the calibration.

7 Parts and Controls

7.1 Control Panel

The following controls and indicators are present on the controller front panel (see Figure 2 below): (1) the digital LED display, (2) the control buttons, (3) the on/off power switch, (4) the heater mode light, and (5) the cooling on/off switch.

- 1) The digital display is an important part of the temperature controller. It displays the set-point temperature and bath temperature as well as the various other bath functions, settings, and constants. The display shows temperatures according to the selected scale units °C or °F.
- 2) The control buttons (SET, DOWN, UP, and EXIT) are used to set the bath temperature set-point, access and set other operating parameters, and access and set bath calibration parameters. A brief description of the functions of the buttons follows:

SET - Used to display the next parameter in a menu and to set parameters to the displayed value.

DOWN - Used to decrement the displayed value of parameters.

UP - Used to increment the displayed value.

EXIT - Used to exit from a menu. When EXIT is pressed any changes made to the displayed value will be ignored.

- 3) The on/off switch controls power to the entire bath including the stirring motor.

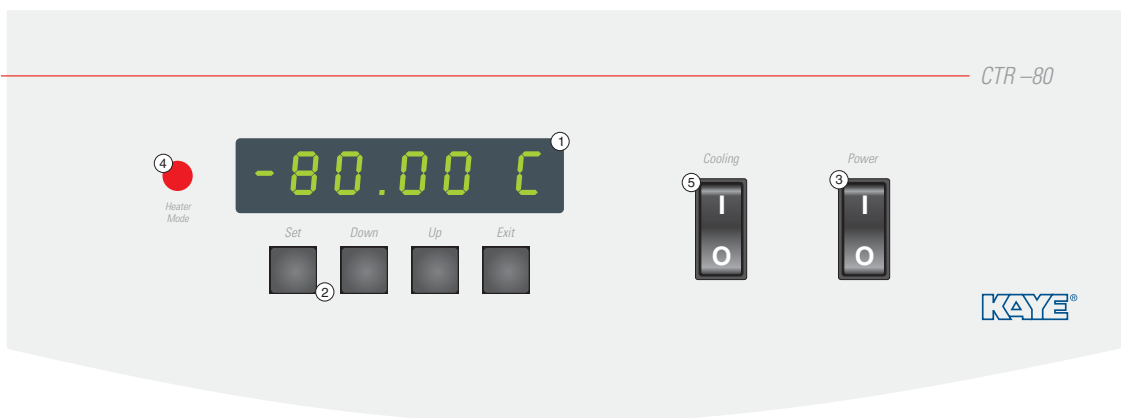

Figure 2 CTR-80 Control Panel

- 4) The heater mode is a red light emitting diode (LED). This indicator lets the user visually see the ratio of heating to cooling. When the indicator is lit the heater is on, and when it is off the heater is off and the bath is cooling.
- 5) The cooling switch turns on the refrigeration for control below 50°C and rapid cool down.

7.2 Bath Tank and Lid

The bath tank and lid assembly includes: the tank, the control probe, the stirring motor, the access hole, and the access hole cover.

- The bath tank is constructed of stainless steel. It is very resistant to oxidation in the presence of most chemicals and over a wide range of temperatures.
- The control probe provides the temperature feedback signal to the controller allowing the controller to maintain a constant temperature. The control probe is a precision platinum resistance thermometer (PRT). It is delicate and must be handled carefully. The probe is placed in the small hole in the top of the bath so that the probe tip is fully immersed in the bath fluid. It is located underneath the motor cover.
- The stirring motor is mounted on the bath tank lid under the motor cover. It drives the stirring propeller to provide mixing of the bath fluid. Proper mixing of the fluid is important for good constant temperature stability.
- On the bath lid is a work area access hole. This is used for filling the bath with fluids and placement of thermometers and devices into the bath. When possible the access hole should be covered (must be covered to reach minimum temperatures).
- An insulated access hole cover is provided and should be used to cover the access opening in the top of the bath. This improves bath temperature stability, prevents excess fluid evaporation or fumes and increases safety with hot fluid. The user may drill or cut holes in the cover to accommodate the instruments to be calibrated or immersed in the bath. Spare covers are available from GE Kaye Instruments. An optional access cover which provides locations for two reference thermometers and three wells for units under test is available.

7.3 Back Panel

On the back of the bath are 1) the system fuses, 2) the non-removable power cord, 3) the drain valve, 4) the RS-232 interface connector, and 5) removable vent panel.

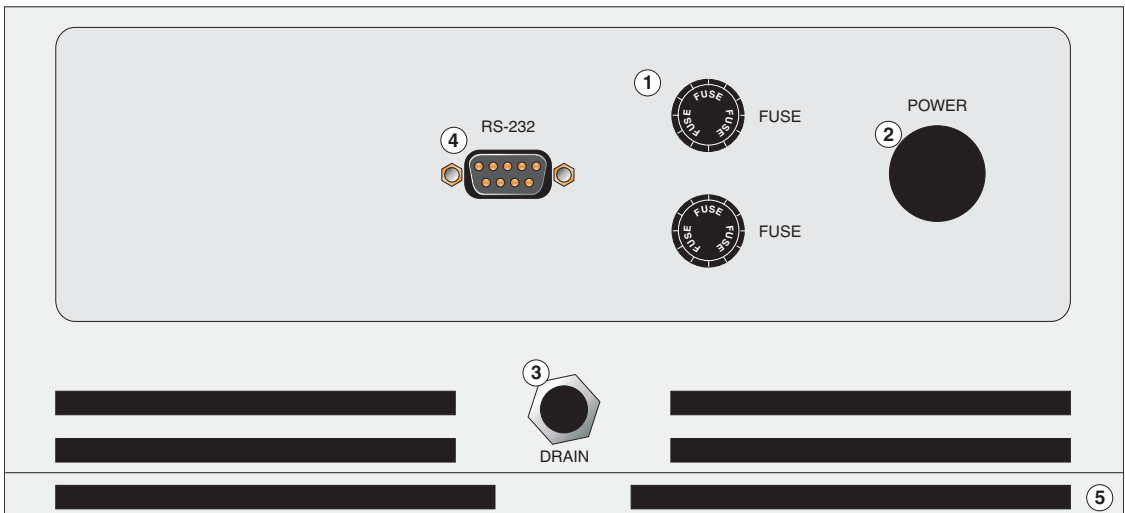

Figure 3 Back Panel

- 1) The system fuses are 20 amp SB, 250V for 115 VAC operation and 10 amp ST, 250 V for 230 VAC operation.
- 2) The power cord is rated at 115 VAC, 20 amps. (230 VAC, 10 amps optional.)
- 3) A drain plug is provided for ease of removing the fluid media from the bath. Always use a container of adequate size to hold the FULL LOAD of fluid. Some oils are more easily drained at higher temperatures.



Caution: Do not exceed a 100°C fluid temperature for draining. The valve could be damaged if 100°C is exceeded. Insulate the container from the floor and other objects.

- 4) The serial RS-232 interface attaches to the back of the bath at the connector labeled "RS-232".
- 5) The removable vent panel can be removed to access the condenser for cleaning. See Section 12, Maintenance.

8 General Operation

8.1 Bath Fluid

Many fluids work with the CTR -80 bath. Choosing a fluid requires consideration of many important characteristics of the fluid. Among these are temperature range, viscosity, specific heat, thermal conductivity, thermal expansion, electrical resistivity, fluid lifetime, safety, and cost. If the viscosity becomes too great, the stirrer may not function.

8.1.1 Temperature Range

One of the most important characteristics to consider is the temperature range of the fluid. Few fluids work well throughout the complete temperature range of the bath. The temperature at which the bath is operated must always be within the safe and useful temperature range of the fluid. Set the cutout to meet the temperature limits of the selected fluid. The lower temperature range of the fluid is determined by the freeze point of the fluid or the temperature at which the viscosity becomes too great. The upper temperature is usually limited by vaporization, flammability, or chemical breakdown of the fluid. Vaporization of the fluid at higher temperatures may affect temperature stability because of cool condensed fluid dripping into the bath from the lid.

8.1.2 Viscosity

Viscosity is a measure of the thickness of a fluid, how easily it can be poured and mixed. Viscosity affects the temperature stability of the bath. With low viscosity, fluid mixing is better which creates a more uniform temperature throughout the bath. This improves the bath response time which allows it to maintain a more constant temperature. For good control the viscosity should be less than ten centistokes. Twenty centistokes is about the upper limit of allowable viscosity. Viscosities greater than this cause very poor control stability and may also overheat or damage the stirring motor. With oils viscosity may vary greatly with temperature.

When using fluids with higher viscosities the controller proportional band may need to be increased to compensate for the reduced response time (see Section 9.6). Otherwise the temperature may begin to oscillate.

8.1.3 Specific Heat

Specific heat is the measure of the heat storage ability of the fluid. Specific heat, to a small degree, affects the control stability. It also affects the heating and cooling rates. Generally, a lower specific heat means quicker heating and cooling. The proportional band may require some adjustment depending on the specific heat of the fluid.

8.1.4 Thermal Conductivity

Thermal conductivity measures how easily heat flows through the fluid. Thermal conductivity of the fluid affects the control stability, temperature uniformity, and probe temperature settling time. Fluids with higher conductivity distribute heat more quickly and evenly improving bath performance.

8.1.5 Thermal Expansion

Thermal expansion describes how the volume of the fluid changes with temperature. Thermal expansion of the fluid used must be considered since the increase in fluid volume as the bath temperature changes may cause overflow. Excessive thermal expansion may also be undesirable in applications where constant liquid level is important. Many fluids including oils have significant thermal expansion.

8.1.6 Electrical Resistivity

Electrical resistivity describes how well the fluid insulates against the flow of electric current. In some applications, such as measuring the resistance of bare temperature sensors, it may be important that little or no electrical leakage occur through the fluid. In such conditions choose a fluid with very high resistivity.

8.1.7 Fluid Lifetime

Many fluids degrade over time because of evaporation, water absorption, gelling, or chemical breakdown. Often the degradation becomes significant near the upper temperature limit of the fluid, substantially reducing the fluid's lifetime.

8.1.8 Safety

When choosing a fluid always consider the safety issues associated. Obviously where there are conditions of extreme hot or cold there can be danger to people and equipment. Fluids may also be hazardous for other reasons. Some fluids may be considered toxic. Contact with eyes, skin, or inhalation of vapors may cause injury. A proper fume hood must be used if hazardous or bothersome vapors are produced.



Warning: *Fluids at high temperatures may pose danger from BURNS, FIRE, and TOXIC FUMES. Use appropriate caution and safety equipment.*

Fluids may be flammable and require special fire safety equipment and procedures. An important characteristic of the fluid to consider is the flash point. The

flash point is the temperature at which there is sufficient vapor given off so that when there is sufficient oxygen present and a ignition source is applied the vapor will ignite. This does not necessarily mean that fire will be sustained at the flash point. The flash point may be either of the open cup or closed cup type. Either condition may occur in a bath situation. The closed cup temperature is always the lower of the two. The closed cup represents the contained vapors inside the tank and the open cup represents the vapors escaping the tank. Oxygen and an ignition source will be less available inside the tank.

The cutout should be set to meet the temperature limits of the selected fluid.

Environmentally hazardous fluids require special disposal according to applicable federal or local laws after use.

8.1.9 Cost

Cost of bath fluids may vary greatly, from cents per gallon for water to hundreds of dollars per gallon for synthetic oils. Cost may be an important consideration when choosing a fluid.

8.1.10 Commonly Used Fluids

Below is a description of some of the more commonly used fluids and their characteristics.

8.1.10.1 Water (Distilled)

Water is often used because of its very low cost, availability, and excellent temperature control characteristics. Water has very low viscosity and good thermal conductivity and heat capacity which makes it among the best fluids for control stability at low temperatures. Temperature stability is much poorer at higher temperatures because water condenses on the lid, cools and drips into the bath. Water is safe and relatively inert. The electrical conductivity of water may prevent its use in some applications. Water has a limited temperature range, from a few degrees above 0°C to a few degrees below 100°C. At higher temperatures evaporation becomes significant. Water used in the bath should be **distilled** or **softened** to prevent mineral deposits. Consider using an algaecide chemical in the water to prevent contamination.

8.1.10.2 Ethanol

Denatured ethanol (ethyl alcohol) is often used at lower temperatures between -80°C and 10°C. It has good viscosity over its range and is inexpensive. Toxicity, vapors, and flammability at temperatures higher than 10°C are significant issues that must be considered.

8.1.10.3 Mineral Oil

Mineral oil or paraffin oil is often used at moderate temperatures above the range of water. Mineral oil is relatively inexpensive. At lower temperatures mineral oil is quite viscous and control may be poor. At higher temperatures vapor emission becomes significant. The vapors may be dangerous and use of a fume hood is highly recommended. As with most oils mineral oil will expand as temperature increases so be careful not to fill the bath too full that it overflows when heated. The viscosity and thermal characteristics of mineral oil is poorer than water so temperature stability will not be as good. Mineral oil has very low electrical conductivity. Use caution with mineral oil since it is flammable and may also cause serious injury if inhaled or ingested.

8.1.10.4 Silicone Oil (Dow Corning 200.05, 200.10, 200.20)

Silicone oils are available which offer a much wider operating temperature range than mineral oil. Like most oils, silicone oils have temperature control characteristics which are somewhat poorer than water. The viscosity changes significantly with temperature and thermal expansion also occurs. These oils have very high electrical resistivity. Silicone oils are fairly safe and non-toxic. Silicone oils are fairly expensive.

8.1.10.5 Halocarbon 0.8

Halocarbon 0.8 is a low temperature fluid with a wide temperature range. It may be used as low as -90 to -100°C before viscosity becomes too great. It may be used as high as 70°C before evaporation becomes excessive. Halocarbon does not absorb water and will therefore form ice at temperatures below 0°C . Ice crystals turn the fluid into a slush which effectively increases the viscosity and reduces temperature stability. Pumping systems may be rendered ineffective due to ice blockage. The ice (water) can be removed occasionally by heating the fluid up to 100°C for brief periods of time. Use halocarbon under a fume hood at higher temperatures to remove vapors. Toxicity is low but caution is always recommended. Halocarbon has excellent electrical resistivity. This fluid is fairly expensive.

8.1.11 Fluid Characteristics Table

Table 2 on page 31 provides help in selecting a heat exchange fluid media for your constant temperature bath. This table provides a numerical representation of most of the physical qualities important in making a selection. The list is not all inclusive. There may be other useful fluids not shown in this listing.

The table includes information on a variety of fluids which are often used as heat transfer fluid in baths. Because of the temperature range some fluids may not be useful with your bath.

Table 2 Table of Various Bath Fluids

Fluid (# = Hart Part No.)	Lower Temperature Limit*	Upper Temperature Limit*	Flash Point	Viscosity (centistokes)	Specific Gravity	Specific Heat (cal/g/°C)	Thermal Conductivity (cal/s/cm/°C)	Thermal Expansion (cm/cm/°C)	Resistivity (10 ¹² Ω-cm)
Halocarbon 0.8 #5019	-100°C (v)**	70°C (e)	NONE	5.7 @ -50°C 0.8 @ 40°C 0.5 @ 70°C	1.71 @ 40°C	0.2	0.0004	0.0011	
Methanol	-96°C (fr)	10°C (fl,cc)	12°C	1.3 @ -35°C 0.66 @ 0°C 0.45 @ 20°C	0.810 @ 0°C 0.792 @ 20°C	0.6	0.0005 @ 20°C	0.0014 @ 25°C	
Water	0°C (fr)	95°C (b)	NONE	1 @ 25°C 0.4 @ 75°C	1.00	1.00	0.0014	0.0002 @ 25°C	
Ethylene Glycol—50% #5020	-30°C (fr)	90°C (b)	NONE	7 @ 0°C 2 @ 50°C 0.7 @ 100°C	1.05	0.8 @ 0°C	0.001		
Mineral Oil No.7 #5011	10°C (v)	166°C (fl)	168°C	15 @ 75°C 5 @ 125°C	0.87 @ 25°C 0.84 @ 75°C 0.81 @ 125°C	0.48 @ 25°C 0.53 @ 75°C 0.57 @ 125°C	0.00025 @ 25°C	0.0007 @ 50°C	5 @ 25°C
Silicone Oil Type 200.05 #5010	-40°C (v)**	130°C (fl, cc)	133°C	5 @ 25°C	0.92 @ 25°C	0.4	0.00028 @ 25°C	0.00105	1000 @ 25°C 10 @ 150°C
Silicone Oil Type 200.10 #5012	-30°C (v)**	209°C (fl, cc)	211°C	10 @ 25°C 3 @ 135°C	0.934 @ 25°C	0.43 @ 40°C 0.45 @ 100°C 0.482 @ 200°C	0.00032 @ 25°C	0.00108	1000 @ 25°C 50 @ 150°C
Silicone Oil Type 200.20 #5013	10°C (v)	230°C (fl, cc)	232°C	20 @ 25°C	0.949 @ 25°C	0.370 @ 40°C 0.393 @ 100°C 0.420 @ 200°C	0.00034 @ 25°C	0.00107	1000 @ 25°C 50 @ 150°C
Silicone Oil Type 200.50 #5014	30°C (v)	278°C (fl, cc)	280°C	50 @ 25°C	0.96 @ 25°C	0.4	0.00037 @ 25°C	0.00104	1000 @ 25°C 50 @ 150°C
Silicone Oil Type 550 #5016	70°C (v)	230°C (fl, cc) 300°C (fl, oc)	232°C	50 @ 70°C 10 @ 104°C	1.07 @ 25°C	0.358 @ 40°C 0.386 @ 100°C 0.433 @ 200°C	0.00035 @ 25°C	0.00075	100 @ 25°C 1 @ 150°C
Silicone Oil Type 710 #5017	80°C (v)	300°C (fl, oc)	302°C	50 @ 80°C 7 @ 204°C	1.11 @ 25°C	0.363 @ 40°C 0.454 @ 100°C 0.505 @ 200°C	0.00035 @ 25°C	0.00077	100 @ 25°C 1 @ 150°C
Silicone Oil Type 210-H	66°C (v)	313°C (fl, oc)	315°C	50 @ 66°C 14 @ 204°C	0.96 @ 25°C	0.34 @ 100°C	0.0003	0.00095	100 @ 25°C 1 @ 150°C
Heat Transfer Salt #5001	180°C (fr)	550°C	NONE	34 @ 150°C 6.5 @ 300°C 2.4 @ 500°C	2.0 @ 150°C 1.9 @ 300°C 1.7 @ 500°C	0.33	0.0014	0.00041	1.7 Ω /cm ³

*Limiting Factors — b - boiling point e - high evaporation fl - flash point fr - freeze point v - viscosity — Flash point test oc = open cup cc = closed cup

**Very low water solubility, ice will form as a slush from condensation below freezing.

8.1.11.1 Limitations and Disclaimer

The information given in this manual regarding fluids is intended only to be used as a general guide in choosing a fluid. Though every effort has been made to provide correct information we cannot guarantee accuracy of data or assure suitability of a fluid for a particular application. Specifications may change and sources sometimes offer differing information. GE Kaye Instruments cannot be liable for any personal injury or damage to equipment, product or facilities resulting from the use of these fluids. The user of the bath is responsible for collecting correct information, exercising proper judgment, and insuring safe operation. Operating near the limits of certain properties such as the flash point or viscosity can compromise safety or performance. Your company's safety

policies regarding flash points, toxicity, and such issues must be considered. You are responsible for reading the (material safety data sheets) and acting accordingly.

8.2 Stirring

Stirring of the bath fluid is very important for stable temperature control. The fluid must be mixed well for good temperature uniformity and fast controller response. The stirrer is precisely adjusted for optimum performance.

8.3 Power

Power to the bath is provided by an AC mains supply. See Section 3.1, Specifications, for power details. Refer to and read the CAUTION at the front of this manual concerning brownout and over voltage protection. Power to the bath passes through a filter to prevent switching spikes from being transmitted to other equipment.

To turn on the bath switch the control panel power switch to the ON position. The stirring motor will turn on, the LED display will begin to show the bath temperature, and the heater will turn on or off until the bath temperature reaches the programmed set-point. When powered on the control panel display will briefly show a four digit number. This number indicates the number of times power has been applied to the bath. Also briefly displayed is data which indicates the controller hardware configuration. This data is used in some circumstances for diagnostic purposes.

8.4 Heater

The power to the bath heater is precisely controlled by the temperature controller to maintain a constant bath temperature. Power is controlled by periodically switching the heater on for a certain amount of time using a solid-state relay.

The front panel LED heater mode shows the state of the heater. The indicator glows red when the heater is on and is off when the heater is off. The indicator will pulse constantly when the bath is maintaining a stable temperature.

8.5 Refrigeration

This bath uses a two-stage refrigeration system which requires special refrigerants to enable it to reach low temperatures. This section describes some aspects of the cooling system and provides important information regarding refrigerants.

8.5.1 Operation

The bath controller automatically switches off cooling when the bath is operated above 50°C to protect the system from extreme pressures. The refrigeration system is also protected by a brownout and over voltage protection device that switches off power to the system when the line voltage is outside the safe operating range. The display indicates “L o L i n E” when this condition exists. A time delay prevents the refrigeration from restarting for a short time after adequate line voltage has been restored.

8.5.2 Important Refrigerant Information

The refrigeration system in this bath has been designed to perform at ultra-low temperatures. As a result, aspects of the design are uncommon and the refrigerants are non-standard.

The system is cascaded, meaning there are two separate systems with the first one chilling the second. This is required to reach temperatures below -40°C. Normal refrigeration does not use a cascading technique, and many refrigeration technicians are not familiar with such systems.

The first stage refrigerant is an HFC known as R-507. The second stage performs the ultra-low cooling. Its refrigerant is an HFC R-508B, also known as SUVA-95.

What this means to you:

- The cascade system is complex and its uncommon nature means that many local refrigeration service technicians may not be able to service it. If your bath needs service, call GE Kaye Instruments Customer Service at 1-800-964-KAYE
- The compressor manufacturer does not warranty their compressors when used with non-standard refrigerants. Warranty of these compressors must be handled through GE Kaye Instruments only. There is no other way for you to receive parts or service on your compressor. You must receive your parts or service from GE Kaye Instruments.

8.6 Temperature Controller

The bath temperature is controlled by a special digital temperature controller. The controller features a 24-bit analog-to-digital converter (DAC) that gives it remarkable accuracy and stability.

The bath temperature is monitored with a platinum resistance sensor in the control probe. The controller uses a proportional-integral-derivative (PID) algorithm to determine how much heat the bath needs. The bath is heated by a solid-state relay (SSR) controlled 500W heater.

The bath is operable within the temperature range given in the specifications. For protection against solid-state relay failure or other circuit failure, a thermocouple cutout automatically turns off the heater anytime the bath temperature exceeds the maximum temperature.

The controller allows the operator to set the bath temperature with high resolution, adjust the proportional band, monitor the heater output power, and program the controller configuration and calibration parameters. The controller may be operated in temperature units of degrees Celsius or Fahrenheit. The controller is operated and programmed from the front control panel using the four key switches and digital LED display. The controller is equipped with a serial RS-232 digital interface for remote operation. Operation of the controller using the front control panel is discussed following in Section 9. Operation using the digital interfaces is discussed in Section 10.

When the controller is set to a new set-point the bath heats or cools to the new temperature. Once the new temperature is reached the bath usually takes 15-20 minutes for the temperature to settle and stabilize. There may be a small amount of overshoot or undershoot.

9 Controller Operation

This section discusses in detail how to operate the bath temperature controller using the front control panel. Using the front panel key-switches and LED display the user may monitor the bath temperature, set the temperature set-point in degrees C or F, monitor the heater output power, adjust the controller proportional band, and program the calibration parameters, operating parameters, and serial interface configuration. Operation of the functions and parameters are shown in the flowchart in Figure 4 on page 36. This chart may be copied for reference.

In the following discussion a button with the word SET, UP, EXIT or DOWN inside indicates the panel button while the dotted box indicates the display reading. Explanation of the button or display reading are to the right of each button or display value.

9.1 Bath Temperature

The digital LED display on the front panel allows direct viewing of the actual bath temperature. This temperature value is what is normally shown on the display. The units, C or F, of the temperature value are displayed at the right. For example,

10.00C *Bath temperature in degrees Celsius*

The temperature display function may be accessed from any other function by pressing the “EXIT” button.

9.2 Temperature Set-point

The temperature set-point can be set to any value within the range and resolution as given in the specifications. Be careful not to exceed the safe temperature limits of any devices inserted into the bath.

Setting the temperature involves two steps: (1) select the set-point memory and (2) adjust the set-point value.

To protect the refrigeration system from excessive pressures, it will not operate above 50°C.

9.2.1 Programmable Set-points

The controller stores 8 set-point temperatures in memory. The set-points can be quickly recalled to conveniently set the calibrator to a previously programmed temperature set-point.

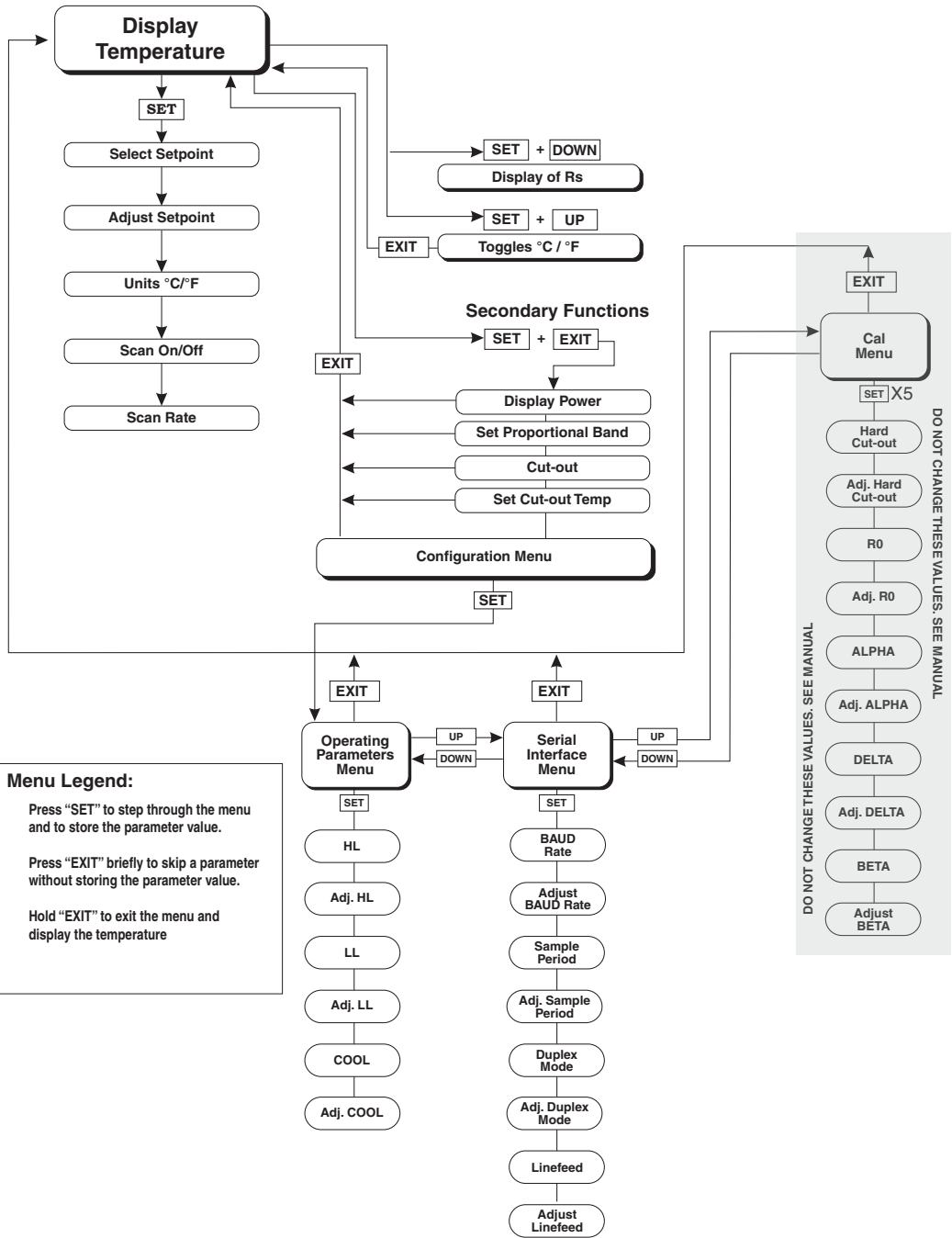

Menu Legend:

Press "SET" to step through the menu and to store the parameter value.

Press "EXIT" briefly to skip a parameter without storing the parameter value.

Hold "EXIT" to exit the menu and display the temperature

Figure 4 Controller Operation Flowchart

To set the temperature one must first select the set-point memory. This function is accessed from the temperature display function by pressing “SET”. The number of the set-point memory currently being used is shown at the left on the display followed by the current set-point value.

 *Bath temperature in degrees Celsius*

 *Access set-point memory*

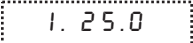
 *Set-point memory 1, 25°C currently used*

To change the set-point memory press “UP” or “DOWN”.

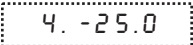
 *New set-point memory 4, -25°C*

Press “SET” to accept the new selection and access the set-point value.

 *Accept selected set-point memory*

9.2.2 Set-point Value

The set-point value may be adjusted after selecting the set-point memory and pressing “SET”.

 *Set-point 4 value in °C*

If the set-point value is correct, hold “EXIT” to resume displaying the well temperature. Press “UP” or “DOWN” to adjust the set-point value.

 *New set-point value*

When the desired set-point value is reached press “SET” to accept the new value and access the temperature scale units selection. If “EXIT” is pressed instead of “SET”, any changes made to the set-point are ignored.

 *Accept new set-point value*

9.2.3 Temperature Scale Units

The temperature scale units of the controller can be set by the user to degrees Celsius (°C) or Fahrenheit (°F). The selected units are used in displaying the well temperature, set-point, and proportional band.

Press “SET” after adjusting the set-point value to change display units.

$U_n = C$ *Scale units currently selected*

Press “UP” or “DOWN” to change the units.

$U_n = F$ *New units selected*

9.3 Scan

The scan rate can be set and enabled so that when the set-point is changed the bath heats or cools at a specified rate (degrees per minute) until it reaches the new set-point. With the scan disabled the bath heats or cools at the maximum possible rate.

9.3.1 Scan Control

The scan is controlled with the scan on/off function that appears in the main menu after the set-point function.

$S_c = OFF$ *Scan function off*

Press “UP” or “DOWN” to toggle the scan on or off.

$S_c = ON$ *Scan function on*

Press “SET” to accept the present setting and continue.

 *Accept scan setting*

9.3.2 Scan Rate

The next function in the main menu is the scan rate. The scan rate can be set from .1 to 99.9°C/min. The maximum scan rate however is actually limited by the natural heating or cooling rate of the instrument. This will be less than 10°C/min.

The scan rate function appears in the main menu after the scan control function. The scan rate units are in degrees per minute, degrees C or F depending on the selected units.

$S_r = 5.0$ *Scan rate in°C/min*

Press “UP” or “DOWN” to change the scan rate.

$S_r = 2.0$ *New scan rate*

Press “SET” to accept the new scan rate and continue.



Accept scan rate

9.4 Secondary Menu

Functions which are used less often are accessed within the secondary menu. The secondary menu is accessed by pressing “SET” and “EXIT” simultaneously and then releasing. The first function in the secondary menu is the heater power display. (See Figure 4 on page 36.)

9.5 Heater Power

The temperature controller controls the temperature of the bath by pulsing the heater on and off. The total power being applied to the heater is determined by the duty cycle or the ratio of heater on time to the pulse cycle time. By knowing the amount of heating the user can tell if the calibrator is heating up to the set-point, cooling down, or controlling at a constant temperature. Monitoring the percent heater power will let the user know how stable the bath temperature is.

The heater power display is accessed in the secondary menu. Press “SET” and “EXIT” simultaneously and release. The heater power will be displayed as a percentage of full power.

10.00C

Bath temperature



Access heater power in secondary menu

5EC

Flashes

12.0 P

Heater power in percent

To exit out of the secondary menu hold “EXIT”. To continue on to the proportional band setting function press “EXIT” momentarily or “SET”.

9.6 Proportional Band

In a proportional controller such as this the heater output power is proportional to the well temperature over a limited range of temperatures around the set-point. This range of temperature is called the proportional band. At the bottom of the proportional band the heater output is 100%. At the top of the proportional band the heater output is 0. Thus as the temperature rises the heater power is reduced, which consequently tends to lower the temperature back

down. In this way the temperature is maintained at a fairly constant temperature.

The temperature stability of the bath and response time depend on the width of the proportional band. If the band is too wide the temperature will deviate excessively from the set-point due to varying external conditions. This is because the power output changes very little with temperature and the controller cannot respond very well to changing conditions or noise in the system. If the proportional band is too narrow the temperature may swing back and forth because the controller overreacts to temperature variations. For best control stability the proportional band must be set for the optimum width. This value is usually two to three times the largest value at which the bath temperature oscillates.

The proportional band width is set at the factory to a value between 0.5 and 1.0°C. The proportional band width may be altered by the user if he desires to optimize the control characteristics for a particular application.

The proportional band width is easily adjusted from the front panel. The width may be set to discrete values in degrees C or F depending on the selected units. The proportional band adjustment is accessed within the secondary menu. Press "SET" and "EXIT" to enter the secondary menu and show the heater power. Then press "SET" to access the proportional band.

 +  *Access heater power in secondary menu*

 *Heater power in percent*

 *Access proportional band*

 *Flashes "ProP" and the setting*

 *Proportional band setting*

To change the proportional band press "UP" or "DOWN".

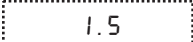
 *New proportional band setting*

To store the new setting press "SET". Press "EXIT" to continue without storing the new value.

 *Accept the new proportional band setting*

9.7 Cutout

As a protection against software or hardware fault or user error, the bath is equipped with an adjustable cutout device that shuts off power to the heater if the temperature exceeds a set value. This protects the instrument, probes, and fluid from excessive temperatures. The cutout temperature is programmable by the operator from the front panel of the controller. The cutout should be set to the temperature limits of the selected fluid.

If the cutout is activated because of excessive temperature, power to the heater shuts off and the instrument cools. The bath cools until it reaches a few degrees below the cutout set-point temperature. At this point the cutout resets and allows normal operation.

The cutout set-point may be accessed within the secondary menu. Press “SET” and “EXIT” to enter the secondary menu and show the heater power. Then press “SET” twice to access the cutout set-point.

 +  *Access heater power in secondary menu*

 *Heater power in percent*

 *Access proportional band*

 *Proportional band setting*

 *Access cutout set-point*

 *Cutout set-point*

To change the cutout set-point press “UP” or “DOWN”.

 *New cutout set-point*

To accept the new cutout set-point press “SET”.

 *Accept cutout set-point*

The next function is the configuration menu. Press “EXIT” to resume displaying the temperature.

9.8 Controller Configuration

The controller has a number of configuration and operating options and calibration parameters which are programmable via the front panel. These are accessed from the secondary menu after the proportional band function by pressing “SET”. Pressing “SET” again enters the first of three sets of configuration parameters: operating parameters, serial interface parameters, and calibration parameters. The menus are selected using the “UP” and “DOWN” keys and then pressing “SET”. (See Figure 4 on page 36.)

9.9 Operating Parameters

The operating parameters menu is indicated by,

P A r *Operating parameters menu*

The operating parameters menu contains the High Limit, Stir Speed, and Cooling parameters.

9.9.1 High Limit

The High Limit Parameter adjusts the upper set-point temperature. The factory default and maximum temperature are set to 100°C. For safety, a user can adjust the High Limit down so the maximum temperature set-point is restricted.

H L *High Limit parameter*

Press “SET” to enable adjustment of HL.

H L *Flashes “HL” and then displays the setting*

H = 100 *Current HL setting*

Adjust the HL parameter using “UP” or “DOWN”.

H = 90 *New HL setting*

Press “SET” to accept the new temperature limit.

9.9.2 Low Limit

The Low Limit (LL) Parameter adjusts the lower set-point temperature limit. The factory default and minimum temperature are set to -90°C. For safety, a user can adjust the Low Limit up so the minimum temperature set-point is restricted.

`LL` *Low Limit parameter*

Press “SET” to enable adjustment of LL.

`LL` *Flashes “LL” and then displays the setting*

`L=-90` *Current LL setting*

Adjust the LL parameter using “UP” or “DOWN”.

`L=-20` *New LL setting*

Press “SET” to accept the new temperature limit.

9.9.3

Cooling

This menu function allows the operator to disable cooling and corresponds to the remote cooling control function (see Table 3). Switching the cooling off temporarily allows the bath to heat up more quickly from a low temperature. Cooling can be manually switched off using the cooling switch on the front panel or automatically switched off any time the bath temperature or set-point is higher than about 35°C. As a result, cooling is ON only if the cooling function is ON, the cooling switch is ON, and both the bath temperature and the set-point are less than about 35°C. The cooling function is indicated by,

`Cool` *Flashes “Cool” and then displays the setting*

`Cool=OFF` *Current cooling setting*

The setting may be changed using “UP” or “DOWN” and pressing “SET”.

`Cool=On` *New cooling setting*

9.10

Serial Interface Parameters

The serial RS-232 interface parameters menu is indicated by,

`SERIAL` *Serial RS-232 interface parameters menu*

The serial interface parameters menu contains parameters which determine the operation of the serial interface. These controls only apply to instruments fitted with the serial interface. The parameters in the menu are — BAUD rate, sample period, duplex mode, and linefeed. Press “UP” to enter the menu.

9.10.1 Baud Rate

The baud rate is the first parameter in the menu. The baud rate setting determines the serial communications transmission rate.

The baud rate parameter is indicated by,

`BAUD` Flashes “BAUD” and then displays the setting

`2400 b` Current BAUD rate

The baud rate of the serial communications may be programmed to 300, 600, 1200, **2400**, 4800, or 9600 baud. Use “UP” or “DOWN” to change the baud rate value.

`4800 b` New BAUD rate

Press “SET” to set the baud rate to the new value or “EXIT” to abort the operation and skip to the next parameter in the menu.

9.10.2 Sample Period

The sample period is the next parameter in the serial interface parameter menu. The sample period is the time period in seconds between temperature measurements transmitted from the serial interface. If the sample rate is set to 5, the instrument transmits the current measurement over the serial interface approximately every five seconds. The automatic sampling is disabled with a sample period of 0. The sample period is indicated by,

`SPEr` Flashes “SPEr” and then displays the setting

`SP= 1` Current sample period (seconds)

Adjust the value with “UP” or “DOWN” and then use “SET” to store the sample rate to the displayed value. “EXIT” does not store the new value.

`SP= 60` New sample period

9.10.3 Duplex Mode

The next parameter is the duplex mode. The duplex mode may be set to full duplex or half duplex. With full duplex any commands received by the calibrator via the serial interface are immediately echoed or transmitted back to the device of origin. With half duplex the commands are executed but not echoed. The duplex mode parameter is indicated by,

`dUPL`*Flashes “dUPL” and then displays the setting*`d=FULL`*Current duplex mode setting*

The mode may be changed using “UP” or “DOWN” and pressing “SET”.

`d=HALF`*New duplex mode setting*

9.10.4

Linefeed

The final parameter in the serial interface menu is the linefeed mode. This parameter enables (on) or disables (off) transmission of a linefeed character (LF, ASCII 10) after transmission of any carriage-return. The linefeed parameter is indicated by,

`LF`*Flashes “LF” and then displays the setting*`LF=ON`*Current linefeed setting*

The mode may be changed using “UP” or “DOWN” and pressing “SET”.

`LF=OFF`*New linefeed setting*

9.11

Calibration Parameters

The operator of the CTR –80 controller has access to the Hard Cutout and a number of the bath calibration constants namely R₀, ALPHA, DELTA, and BETA. These values are set at the factory and should **not be** altered. The correct values are important to the accuracy and proper and safe operation of the bath. Access to these parameters is available to the user only so that in the event that the controller memory fails the user may restore these values to the factory settings. The user should have a list of these constants and their settings with the manual.



Caution: *DO NOT change the values of the bath calibration constants from the factory set values. The correct setting of these parameters is important to the safety and proper operation of the bath.*

The calibration parameters menu is indicated by:

`CRAL`*Calibration parameters menu*

Press “SET” five times to enter the menu.

The calibration parameters R_0 , ALPHA, DELTA, and BETA characterize the resistance-temperature relationship of the platinum control sensor. These parameters may be adjusted by an experienced user to improve the accuracy of the bath.

9.11.1 Hard Cutout

This parameter is the temperature above which the unit shuts down automatically. The parameter is set at the factory to approximately 120°C and can be changed only through the variable resistor. This parameter cannot be changed through the instrument menu or the communications port and is user settable.

9.11.2 R_0

This probe parameter refers to the resistance of the control probe at 0°C. The value of this parameter is set at the factory for best instrument accuracy.

9.11.3 ALPHA

This probe parameter refers to the average sensitivity of the probe between 0 and 100°C. The value of this parameter is set at the factory for best instrument accuracy.

9.11.4 DELTA

This probe parameter characterizes the curvature of the resistance-temperature relationship of the sensor. The value of this parameter is set at the factory for best instrument accuracy.

9.11.5 BETA

This probe parameter characterizes the low temperatures. The value of this parameter is set at the factory for best instrument accuracy.

10 Digital Communication Interface

The CTR –80 Bath calibrator is capable of communicating with and being controlled by other equipment through the digital serial interface.

With a digital interface the instrument may be connected to a computer or other equipment. This allows the user to set the set-point temperature, monitor the temperature, and access any of the other controller functions, all using remote communications equipment. Communications commands are summarized in Table 3 on page 50.

10.1 Serial Communications

The bath is installed with an RS-232 serial interface that allows serial digital communications over fairly long distances. With the serial interface the user may access any of the functions, parameters and settings discussed in Section 9 with the exception of the baud rate setting.

10.1.1 Wiring

The serial communications cable attaches to the calibrator through the DB-9 connector at the back of the instrument. Figure 5 shows the pin-out of this connector and suggested cable wiring. To eliminate noise the serial cable should be shielded with low resistance between the connector (DB-9) and the shield. If the unit is used in a heavy industrial setting, the serial cable must be limited to **ONE METER** in length.

RS-232 Cable Wiring for IBM PC and Compatibles

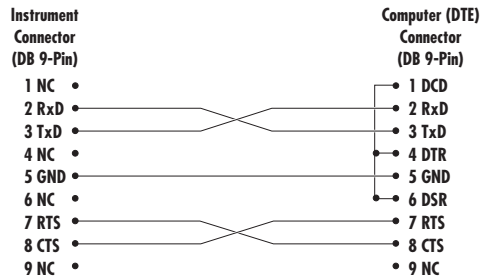

10.1.2 Setup

Before operation the serial interface must first be set up by programming the baud rate and other configuration parameters. These parameters are programmed within the serial interface menu. The serial interface parameters menu is outlined in Figure 4 on page 36.

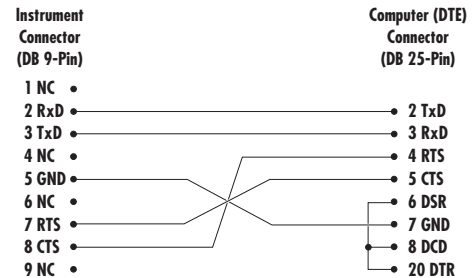

Figure 5 Serial Cable Wiring

To enter the serial parameter programming mode first press “EXIT” while pressing “SET” and release to enter the secondary menu. Press “SET” repeatedly until the display reads “PAR”. Press “UP” until the serial interface menu is indicated with “SERIAL”. Finally press “SET” to enter the serial parameter menu. In the serial interface parameters menu are the baud rate, the sample rate, the duplex mode, and the linefeed parameter.

10.1.2.1 Baud Rate

The baud rate is the first parameter in the menu. The display prompts with the baud rate parameter by showing “BAUD”. Press “SET” to choose to set the baud rate. The current baud rate value is displayed. The baud rate of the instrument serial communications may be programmed to 300, 600, 1200, **2400**, 4800, or 9600 baud. The baud rate is pre-programmed to 2400 baud. Use “UP” or “DOWN” to change the baud rate value. Press “SET” to set the baud rate to the new value or “EXIT” to abort the operation and skip to the next parameter in the menu.

10.1.2.2 Sample Period

The sample period is the next parameter in the menu and prompted with “*S P E r*”. The sample period is the time period in seconds between temperature measurements transmitted from the serial interface. If the sample rate is set to 5, the instrument transmits the current measurement over the serial interface approximately every five seconds. The automatic sampling is disabled with a sample period of 0. Press “SET” to choose to set the sample period. Adjust the period with “UP” or “DOWN” and then use “SET” to set the sample rate to the displayed value.

10.1.2.3 Duplex Mode

The next parameter is the duplex mode indicated with “*D U P L*”. The duplex mode may be set to half duplex (“HALF”) or full duplex (“FULL”). With full duplex any commands received by the thermometer via the serial interface are immediately echoed or transmitted back to the device of origin. With half duplex the commands are executed but not echoed. The default setting is half duplex. The mode may be changed using “UP” or “DOWN” and pressing “SET”.

10.1.2.4 Linefeed

The final parameter in the serial interface menu is the linefeed mode. This parameter enables (“On”) or disables (“OFF”) transmission of a linefeed character (LF, ASCII 10) after transmission of any carriage-return. The default setting is linefeed off. The mode may be changed using “UP” or “DOWN” and pressing “SET”.

10.1.3 Serial Operation

Once the cable has been attached and the interface set up properly the controller will immediately begin transmitting temperature readings at the programmed rate. The serial communications uses 8 data bits, one stop bit, and no parity. The set-point and other commands may be sent via the serial interface to set the temperature set-point and view or program the various parameters. The interface commands are discussed in Section 10.2. All commands are ASCII character strings terminated with a carriage-return character (CR, ASCII 13).

10.2 Interface Commands

The various commands for accessing the calibrator functions via the digital interfaces are listed in this section (see Table 3). These commands are used with the RS-232 serial interface. The commands are terminated with a carriage-return character. The interface makes no distinction between upper and lower case letters, hence either may be used. Commands may be abbreviated to the minimum number of letters which determines a unique command. A command may be used to either set a parameter or display a parameter depending on

Table 3 Controller Communications Commands

Command Description	Command Format	Command Example	Returned	Returned Example	Acceptable Values
Display Temperature					
Read current set-point	s[etpoint]	s	set: 999.99 {C or F}	set: 90.00 C	
Set current set-point to <i>n</i>	s[etpoint]= <i>n</i>	s=80.00			Instrument Range
Read temperature	t[emperature]	t	t: 999.99 {C or F}	t: 55.6 C	
Read temperature units	u[nits]	u	u: x	u: C	
Set temperature units:	u[nits]=c/f				C or F
Set temperature units to Celsius	u[nits]=c	u=c			
Set temperature units to Fahrenheit	u[nits]=f	u=f			
Read scan mode	sc[an]	sc	scan: {ON or OFF}	scan: ON	
Set scan mode	sc[an]=on/off	sc=on			ON or OFF
Read scan rate	sr[ate]	sr	srat: 99.9 {C or F}/min	srat:12.4C/min	
Set scan rate	sr[ate]= <i>n</i>	sr=1.1			.1 to 99.9
Secondary Menu					
Read proportional band setting	pr[opband]	pr	pb: 999.9	pb: 15.9	
Set proportional band to <i>n</i>	pr[opband]= <i>n</i>	pr=8.83			Depends on Configuration
Read cut-out setting	cu[tout]	cu	cu:9999 {C or F}	cu:105 C, in	
Set cut-out setting to <i>n</i> degrees	cu[tout]= <i>n</i>	cu-95			25 to 115°C
Read heater power (duty cycle)	po[wer]	po	po: 999.9	po: 1.0	
Configuration Menu					
Operating Parameters Menu					
Read high limit	hl	hl	hl:999	hl:126	
Set high limit	hl= <i>n</i>	hl=90			25 to 100
Read low limit	ll	ll	ll:999	ll:-90	
Set low limit	ll= <i>n</i>	ll=-90			-90 to 25
Read cooling setting	co[ol]	co	cool: {ON or OFF}	cool: ON	
Set cooling setting	co[ol]=on/off[f]	co=on			ON or OFF
Serial Interface Menu					
Read serial sample setting	sa[mple]	sa	sa: 9	sa: 1	
Set serial sampling setting to <i>n</i> seconds	sa[mple]= <i>n</i>	sa=0			0 to 999
Set serial duplex mode:	du[plex]=f[ull]/h[alf]				FULL or HALF
Set serial duplex mode to full	du[plex]=f[ull]	du=f			
Set serial duplex mode to half	du[plex]=h[alf]	du=h			

Controller Communications Commands continued

Command Description	Command Format	Command Example	Returned	Returned Example	Acceptable Values
Set serial linefeed mode:	lf[eed]=on/off[f]				ON or OFF
Set serial linefeed mode to on	lf[eed]=on	lf=on			
Set serial linefeed mode to off	lf[eed]=off[f]	lf=of			
Calibration Menu					
Read RO calibration parameter	r[0]	r	r0: 999.999	r0: 100.578	
Set RO calibration parameter to n	r[0]=n	r=100.324			90 to 110
Read ALPHA calibration parameter	al[pha]	al	al: 9.9999999	al: 0.0038573	
Set ALPHA calibration parameter to n	al[pha]=n	al=0.0038433			.002 to .005
Read DELTA calibration parameter	de[lta]	de	de:9.99999	de: 1.507	
Set DELTA calibration parameter	de[lta]=n	de=1.3742			0–3.0
Read BETA calibration parameter	be[ta]	be	be:99.999	be:03427	
Set BETA calibration parameter	be[ta]=n	be=0.342			–20 to 20
Functions not on menu					
Read firmware version number	*ver[sion]	*ver	ver.9999,9.99	ver.7103,2.00	
Read structure of all commands	h[elp]	h	list of commands		
Read all operating parameters	all	all	list of parameters		
Legend:	[] Optional Command data {} Returns either information n Numeric data supplied by user 9 Numeric data returned to user x Character data returned to user				
Note:	When DUPLEX is set to FULL and a command is sent to READ, the command is returned followed by a carriage return and linefeed. Then the value is returned as indicated in the RETURNED column.				

whether or not a value is sent with the command following a “=” character. For example “s”<CR> will return the current set-point and “s=150.0”<CR> will set the set-point to 150.0 degrees.

In the following list of commands, characters or data within brackets, “[” and “]”, are optional for the command. A slash, “/”, denotes alternate characters or data. Numeric data, denoted by “n”, may be entered in decimal or exponential notation. Characters are shown in lower case although upper case may be used. Spaces may be added within command strings and will simply be ignored. Backspace (BS, ASCII 8) may be used to erase the previous character. A terminating CR is implied with all commands.

11 Calibration Procedure

11.1 Calibration Procedure

Calibration of this instrument should be performed at regularly scheduled intervals by qualified authorized personnel in accordance with your company's policy. Following is the recommended procedure for calibrating this instrument.

11.1.1 Calibration Equipment

Calibration requires a standard thermometer that is adequately accurate and fits properly into one of the reference holes in the block. Recommended equipment includes a laboratory grade PRT with a length of 30 to 300 mm (9 to 12 inches) and a diameter of 4.76 or 6.35 mm (3/16 or 1/4 inches). The combined accuracy of the PRT and the readout which used to display the temperature should be 0.025°C or better.

11.1.2 Calibration

The accuracy of the instrument over the full range is determined by the values of the calibration parameters R0, ALPHA, DELTA, and BETA. The calibration procedure involves measuring the error between the instrument and the reference thermometer at several temperature throughout the range and adjusting the calibration parameters as necessary to reduce the errors to within acceptable limits. The stated accuracy of the instrument can be found in the specification table in Section 3.1. Because of the way the calibration parameters affect the temperature the simplest way to proceed is to measure the errors at 0°C, 100°C, 50°C, and -70°C and adjust R0, ALPHA, DELTA, and BETA at each point respectively. ***Be aware that you must use the appropriate fluid at each temperature.*** Follow these steps:

- Set the set-point to 0°C and allow adequate time for the bath to reach this temperature and stabilize. Adjust the R0 calibration parameter (see Section 9.11.2) to make the bath temperature as measured with the standard thermometer match the set-point. The approximate ratio between a change in R0 and a change in temperature at 0°C is about 0.4 to 1. For example, if the bath temperature is high by 0.1°C at 0°C then decrease R0 by 0.04.
- Set the set-point to 100°C and allow adequate time for the bath to reach this temperature and stabilize. Adjust the ALPHA calibration parameter (see Section 9.11.3) to make the bath temperature as measured with the standard thermometer match the set-point. The approximate ratio between a change in ALPHA and a change in temperature at 100°C is about 0.00004 to 1. For example, if the bath temperature is high by 0.1°C at 100°C then decrease ALPHA by 0.000004.

- Set the set-point to 50°C and allow adequate time for the bath to reach this temperature and stabilize. Adjust the DELTA calibration parameter (see Section 9.11.4) to make the bath temperature as measured with the standard thermometer match the set-point. The approximate ratio between a change in DELTA and a change in temperature at 50°C is about 4.0 to 1. For example, if the bath temperature is high by 0.1°C at 50°C then decrease DELTA by 0.4.
- Set the set-point to -70°C and allow adequate time for the bath to reach this temperature and stabilize. Adjust the BETA calibration parameter (see Section 9.11.5) to make the bath temperature as measured with the standard thermometer match the set-point. The approximate ratio between a change in BETA and a change in temperature at -70°C is about -1.0 to 1. For example, if the bath temperature is high by 0.1°C at -70°C then increase BETA by 0.1.

12 Maintenance

- The calibration instrument has been designed with the utmost care. Ease of operation and simplicity of maintenance have been a central theme in the product development. Therefore, with proper care the instrument should require very little maintenance. Avoid operating the instrument in dirty or dusty environments.
- If the outside of the bath becomes soiled, it may be wiped clean with a damp cloth and mild detergent. Do not use harsh chemicals on the surface which may damage the paint.
- Periodically check the fluid level in the bath to ensure that the level has not dropped. A drop in the fluid level affects the stability of the bath. Changes in fluid level are dependent upon several factors specific to the environment in which the equipment is used. A schedule cannot be outlined to meet each environmental setting. Therefore, the first year the bath should be checked weekly with notes kept as to changes in bath fluid. After the first year, the user can set up a maintenance schedule based on the data specific to the application.
- Heat transfer medium lifetime is dependent upon the type of medium and the environment. The fluid should be checked at least every month for the first year and regularly thereafter. This fluid check provides a baseline for knowledge of bath operation with clean, usable fluid. Once some fluids have become compromised, the break down can occur rapidly. Particular attention should be paid to the viscosity of the fluid. A significant change in the viscosity can indicate that the fluid is contaminated, being used outside of its temperature limits, contains ice particles, or is close to a chemical break-down. Once data has been gathered, a specific maintenance schedule can be outline for the instrument. Refer to the General Operation section (Section 8) for more information about the different types of fluids used in calibration baths.
- If a hazardous material is spilt on or inside the equipment, the user is responsible for taking the appropriate decontamination steps as out-lined by the national safety council with respect to the material. MSDS sheets applicable to all fluids used in the baths should be kept in close proximity to the instrument.
- If the mains supply cord becomes damaged, replace it with a cord with the appropriate gauge wire for the current of the bath. If there are any questions, call GE Kaye Instruments Customer Service for more information.
- Before using any cleaning or decontamination method except those recommended by Kaye, users should check with GE Kaye Instruments Customer Service for more information.

tomers Service to be sure that the proposed method will not damage the equipment.

- The condensing coil should be cleaned regularly. Inspect the coil through the vented rear panel. If any dust or dirt accumulation is visible, remove the rear panel to clean out the dust or dirt. Use a vacuum with a brush to remove the dirt. Do not use compressed air as it might drive the dirt between the fins where it may become lodged preventing airflow.
- If the instrument is used in a manner not in accordance with the equipment design, the operation of the bath may be impaired or safety hazards may arise.

13 Trouble Shooting

If problems arise while operating the CTR –80, this section provides some suggestions that may help you solve the problem. A wiring diagram is also included.

13.1 Troubleshooting

Below are several situations that may arise followed by suggested actions to take for fixing the problem.

Incorrect Temperature Reading

- Power the unit on and watch the display. If the first number displayed is less than “-0005-”, the unit has been re-initialized. The unit needs to be reprogrammed for R0, ALPHA, DELTA, and BETA. These numbers can be found on the Report of Calibration that was shipped with the unit.

The unit heats slowly

- Check the Scan and Scan Rate settings. The Scan may be on with the Scan Rate set low.

If the display flashes any of the following:

“err 1” - This error means there is a RAM error

“err 2” - This error means there is a NVRAM error

“err 3” - This error means there is a RAM error

“err 4” - This error means there is an ADC set up error

“err 5” - This error means there is an ADC ready error

“err 6” - This error means there is a SENSOR error

“err 7” - This error means there is a HtrCTL error

- Cycle the power off and on again. If the unit repeats the error code, contact GE Kaye Instruments Customer Support for a return authorization and for assistance.

The bath does not turn on

- If a fault condition exists upon application of power, the bath will not energize.
- This bath needs to be plugged into the line voltage for at least 2 minutes before turning power on. This is only necessary for the first time that the bath is energized or when it is moved from one location to another.

- If a **High/Low voltage condition** exists for longer than 5 seconds, the compressor will be de-energized. The controller display will flash “Lo LinE“ o and off while the condition exists.
- Re-energization is automatic upon correction of the fault condition and after a delay cycle of about 2 minutes.
 - High and Low Voltage Protection at 115 VAC
 - Voltage Cutout: +/- 12.5 % (101 - 129 VAC)
 - Voltage Cut-In: +/- 7.5 % (106 - 124 VAC)
 - High and Low Voltage Protection at 230 VAC
 - Voltage Cutout: +/- 12.5 % (203 - 257 VAC)
 - Voltage Cut-In: +/- 7.5 % (213 - 247 VAC)
- See the Caution in the front of this manual for additional information.

13.2 CE Comments

13.2.1 EMC Directive

This instrument has been tested to meet the European Electromagnetic Compatibility Directive (EMC Directive, 89/336/EEC). The Declaration of Conformity for your instrument lists the specific standards to which the unit was tested.

13.2.2 Low Voltage Directive (Safety)

In order to comply with the European Low Voltage Directive (73/23/EEC), this instrument has been designed to meet the IEC 1010-1 (EN 61010-1) and IEC 1010-2-010 (EN 61010-2-010) standards.

13.3 Wiring Diagram

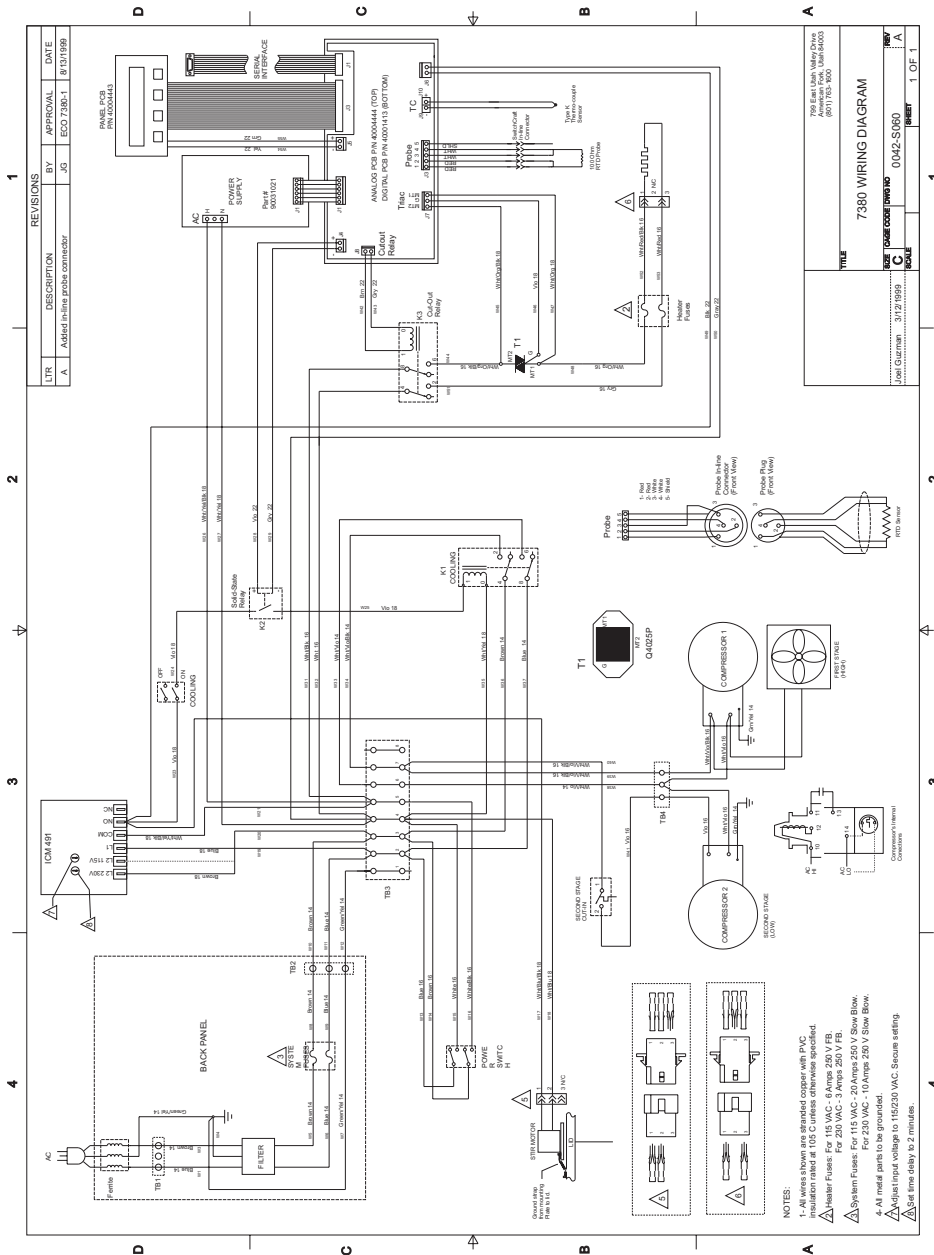

Figure 6 Wiring Diagram

Free Manuals Download Website

<http://myh66.com>

<http://usermanuals.us>

<http://www.somanuals.com>

<http://www.4manuals.cc>

<http://www.manual-lib.com>

<http://www.404manual.com>

<http://www.luxmanual.com>

<http://aubethermostatmanual.com>

Golf course search by state

<http://golfingnear.com>

Email search by domain

<http://emailbydomain.com>

Auto manuals search

<http://auto.somanuals.com>

TV manuals search

<http://tv.somanuals.com>