

The use of these products requires awareness of the following safety issues:

Warning

- Risk of electric shock - isolate from power supply before changing lamp
- Strong magnetic fields may impair lamp performance and worst case can lead to lamps shattering

Use in enclosed fixtures to avoid the following:

- Risk of fire.
- A damaged lamp emits UV radiation which may cause eye/skin injury
- Unexpected lamp shattering may cause injury, fire, or property damage

Caution

- Risk of burn when handling hot lamp
- Lamp may shatter and cause injury if broken
- Arc tube fill gas contain Kr-85

Always follow the supplied lamp operation and handling instructions.

ConstantColor™ CMH™

DATASHEET

Ceramic Metal Halide Lamps Single Ended G8.5 Product Information



Lamp technology

ConstantColor CMH™ lamps combine HPS technology (providing stability, efficiency & uniformity) and Metal Halide Technology (providing bright white quality light) to produce highly efficient light sources with good colour rendering and consistent colour performance through life. This is achieved by using the ceramic arc tube material from the Lucalox™ lamp, which minimises the chemical changes inside the lamp through life. When combined with the halide doses used in Arcstream™ Metal Halide lamps then the quality and stability of the dose maintains the colour consistency. Hence the name ConstantColor CMH™.

Metal halide lamps, traditionally made with quartz arc tubes, are prone to colour shift through life and lamp-to-lamp colour variation. Some of the dose, e.g. sodium, (an important component of metal halide lamps), can migrate through quartz to cause colour shift and loss of light through life. The ceramic arc tube resists this material loss, can be manufactured to tighter tolerances and withstands a higher temperature to provide a more constant colour.

Features

- Consistent colour over life
- Good colour uniformity lamp to lamp
- Bright light – in a very compact size
- Excellent colour rendition
- Improved reliability due to 3 part design
- Up to 97 Lumen per Watt (LPW) efficacy
- Up to 15,000 Hr life
- UV control
- Colour temperatures 3000K, 4200K

Single ended format

Single ended Ceramic Metal Halide lamps are designed to provide symmetrical beam distribution using the axial configuration of the discharge arc. A variety of beam angles are possible and adjustable beam control can be built into the luminaire. This compact lamp shape enables luminaire size to be minimised and the bi-pin lamp base enables easy changing with front access.

Applications areas

- Retail
- Offices
- Stage/Studio
- Architectural lighting
- Display Cabinet
- Hotels



Specification summary*

Ordering Information

Description	Wattage	Colour	Product Code
CMH20/T/UVC/U/830/G8.5 Plus	20	3000K	39858
CMH35/T/UVC/U/830/G8.5 Plus	35	3000K	43273
CMH35/TC/UVC/U/842/G8.5	35	4200K	26348
CMH70/TC/UVC/U/830/G8.5 Plus	70	3000K	43274
CMH70/T/UVC/U/942/G8.5	70	4200K	26349

General	Units	20W 3000K	35W 3000K Plus	35W 4200K	70W 3000K Plus	70W 4200K
Product code		39858	43273	26348	43274	26349
Nominal Wattage	W	20	35	35	70	70
Format				Single ended		
Bulb type		T4.5	T4.5	T4.5	T4.5	T4.5
Bulb diameter	mm	14.5	14.5	14.5	14.5	14.5
Bulb material				UVC Quartz		
Bulb finish				Clear		
Arc Gap	mm	3.35	4.65	4.3	7.4	5.5
Base		G8.5	G8.5	G8.5	G8.5	G8.5

Operating Conditions

Burning position	Universal
Luminaire characteristics	Enclosed

- Notes:
- 1) Lamp voltage in the luminaire should not increase by more than 5V when compared to lamp voltage in free air.
 - 2) Ballast protection required, according to IEC61167.
 - 3) 35W & 70W data is based on operation from a conventional magnetic ballast. Improved performance can be achieved using an electronic ballast.
 - 4) 35W 4200K CMH lamp is based on operation from an electronic ballast. Lamps can run on conventional ballast with a small reduction in performance.
 - 5) 20W designed for operation only from an electronic ballast.

Electrical Characteristics *

Lamp power	W	20	39	39	72	72
Lamp voltage	V	90	90	90	90	90
Lamp current	A	0.226	0.50	0.50	0.98	0.98
Max. Ignition Voltage	kV	***	5.0	5.0	5.0	5.0
Min. Ignition Voltage	kV	***	3.5	3.5	3.5	3.5
Extinction voltage (% of rated input voltage)	%	***	90 (Max.)	90 (Max.)	90 (Max.)	90 (Max.)

* The specification provides typical performance data for 35W & 70W operating from a 50Hz mains sinewave supply at nominal power. Actual values depend on ballast, supply voltage and application 20W to be used only with an electronic ballast
 *** See additional notes on electronic ballast requirements for 20W

Specification summary*

Photometric Characteristics		20W 3000K	35W 3000K Plus	35W 4200K	70W 3000K Plus	70W 4200K
Product code		39858	43237	26348	43274	26349
100 hrs Lumens	lm	1650	3400	3150	6200	6000
Typical Lumen change with burning position - vertical to horizontal	lm			100-150		
Typical voltage change with burning position - vertical to horizontal	V			8		
Correlated Colour Temperature	K	3000	3000	4200	3000	4200
Chromaticity X		0.435	0.435	0.475	0.435	0.475
Chromaticity Y		0.400	0.400	0.370	0.400	0.370
Colour Rendering Index	Ra	80+	84+	88+	80+	90+
Luminous efficacy	lm/W	85	86	80	86	83
Base				G8.5		

Starting and Warm-up Characteristics*

Time to start (at 25 °C)	sec.	< 2	< 2	< 2	< 2	< 2
Time to start - Cold box test at -30 °C	sec.	< 2	< 2	< 2	< 2	< 2
Hot restart time	min.	< 3	< 3	15	15	15
Warm-up time (for 90% lumens)	min.	1.2	1.2	3	3	3

* Typical values (actual values are ballast and ignitor dependent)

Through life Performance*

Lumen maintenance at 40% rated life (mean lumens)	%	68	68	85	71	77
Average rated life	h	12000	15000	12000	15000	15000

* Life data measured in Vertical Base up position. Performance can be greatly increased in horizontal position.

Maximum Operating temperatures**

Maximum allowed bulb temperature (horizontal orientation, thermocouple attached above burner)	°C	500	500	500	550	550
Maximum pinch temperature (vertical base up orientation)	°C	300	300	300	300	300

* The specification provides typical performance data for 35W & 70W operating from a 50Hz mains sinewave supply at nominal power. Actual values depend on ballast, supply voltage and application 20W to be used only with an electronic ballast - see later for additional notes on electronic ballast requirements.

** Temperatures above which lamp performance or reliability is impaired. Additionally, voltage rise when operated in luminaire should not exceed 5V

*** Photometric characteristics refer to lamp performance after 100hrs burning.

Dimension

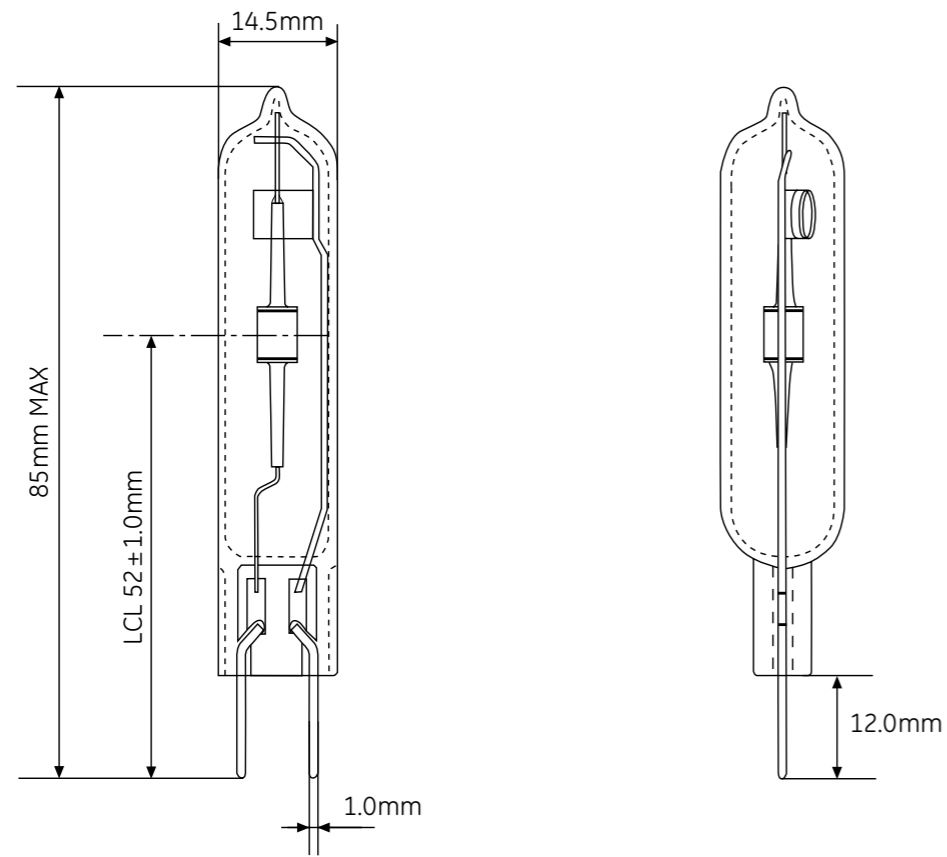

Lamp life

Life survival graphs are shown for statistically representative batches of lamps operated under controlled nominal conditions with a 7 hours per start switching cycle. Declared lamp life is the median value, i.e. when 50% of lamps from a large sample batch would have failed. Lamp life in service is affected by a number of parameters, including supply voltage variation, switching cycle, operating position, ballast impedance tolerance, luminaire design and mechanical vibration.

The information provided is intended to be a practical guide for comparison with other lamp types. Determination of lamp replacement schedules will depend upon relative costs of spot or group replacement and acceptable reduction in lighting levels.

Note: Representative curves are shown for Vertical Base-Up lamp orientation unless otherwise specified. Life performance is significantly increased in the Horizontal burning position.

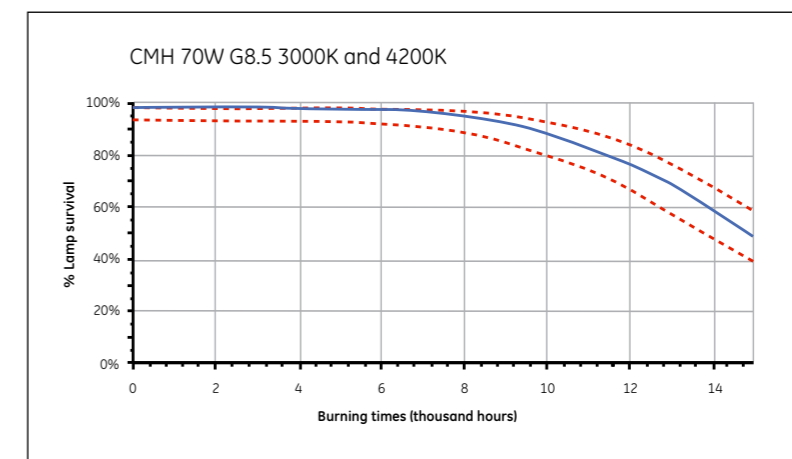
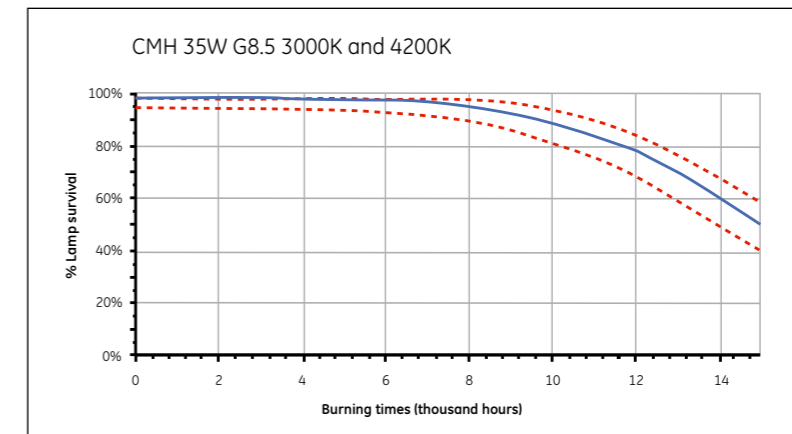
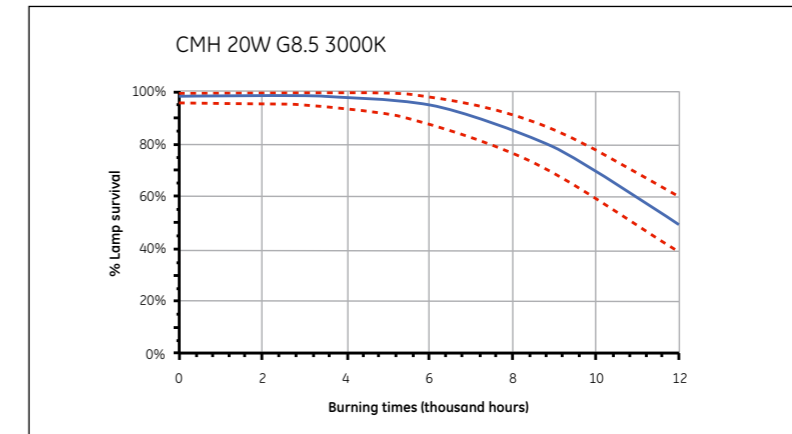

Lumen maintenance

Lumen maintenance graphs show light output performance through life for statistically representative batches of lamps operated under controlled nominal conditions with a 7 hours per start switching cycle. A common characteristic for all metal halide lamps is a reduction in light output and a slight increase in power consumption through life. Consequently there is an economic life at which lamp efficacy falls to a level when lamps should be replaced to restore design illumination levels. Where a quantity of lamps are installed within an area, consideration should be given to a group lamp replacement programme to maintain uniform illumination levels. Curves represent operating conditions for a 7 hours per start switching cycle, but less frequent switching will improve lumen maintenance.

Note: The representative curves are shown for Vertical Base-Up lamp orientation unless otherwise specified. Lumen maintenance performance is significantly improved in the Horizontal burning position.

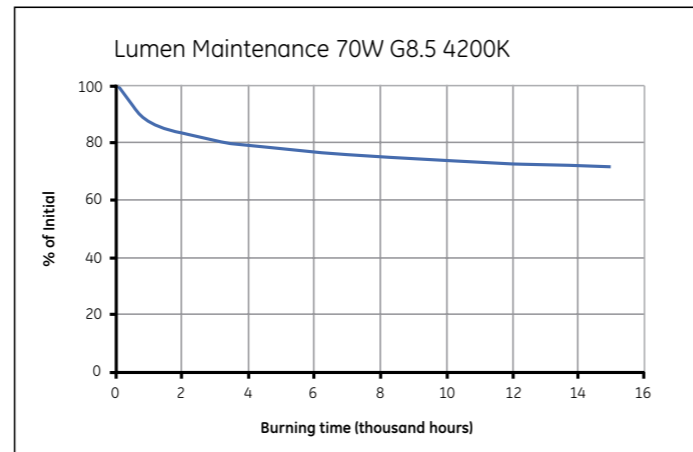
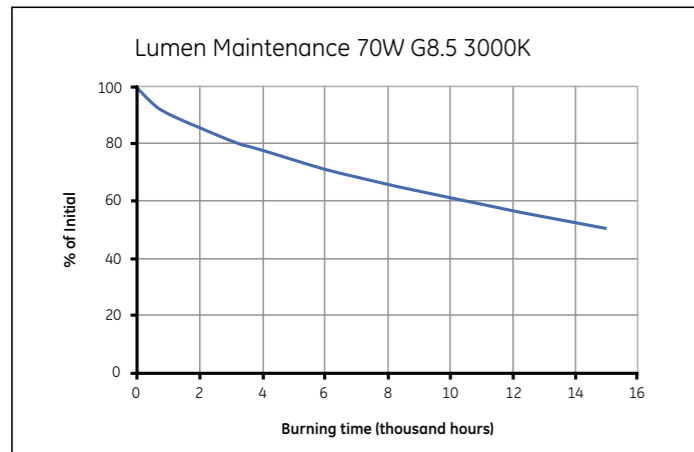
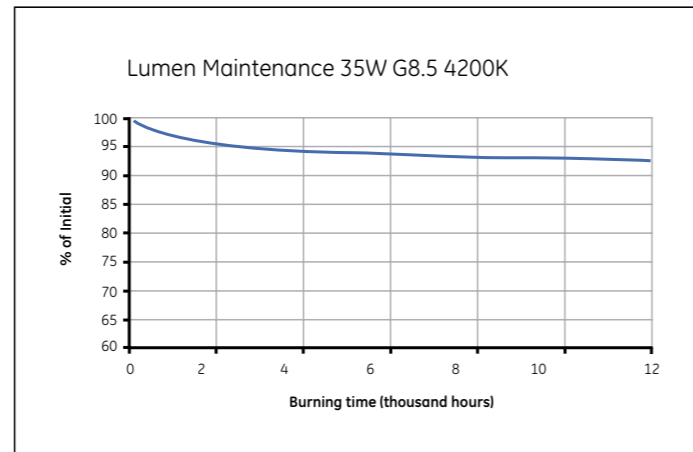
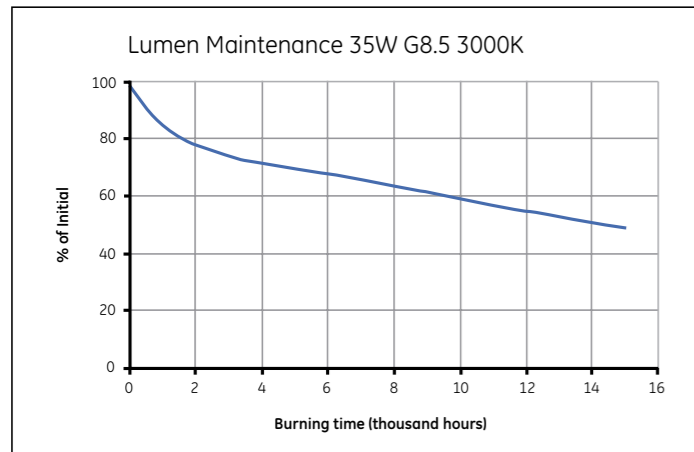
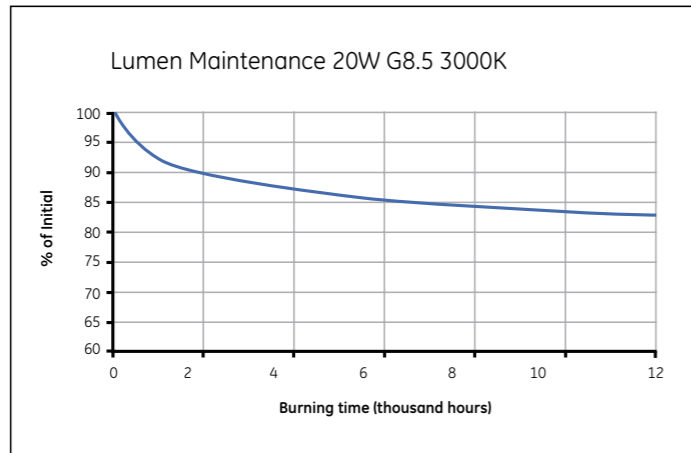

Special power distribution

Spectral Power Distribution curves are given in the following diagram

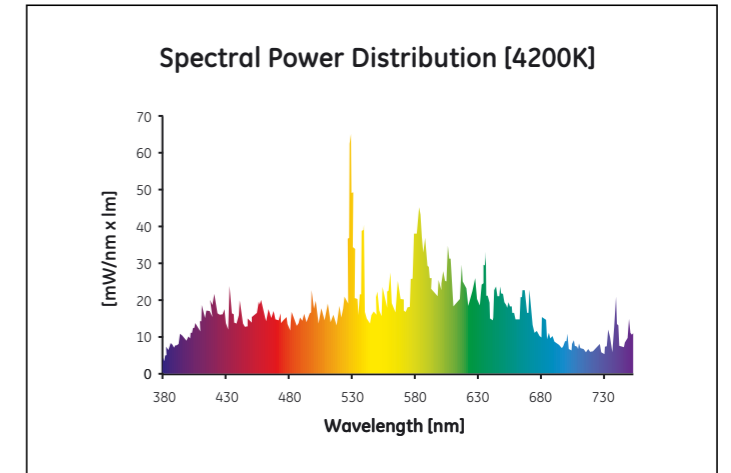
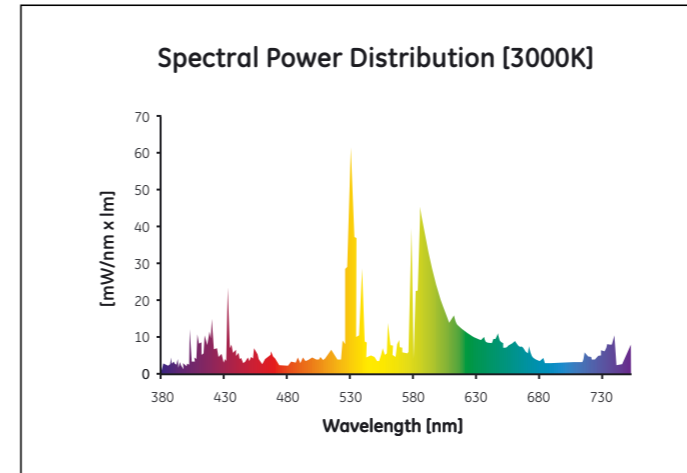

Distribution of luminous intensity

The following diagrams show polar light intensity curves for lamp base-up orientation

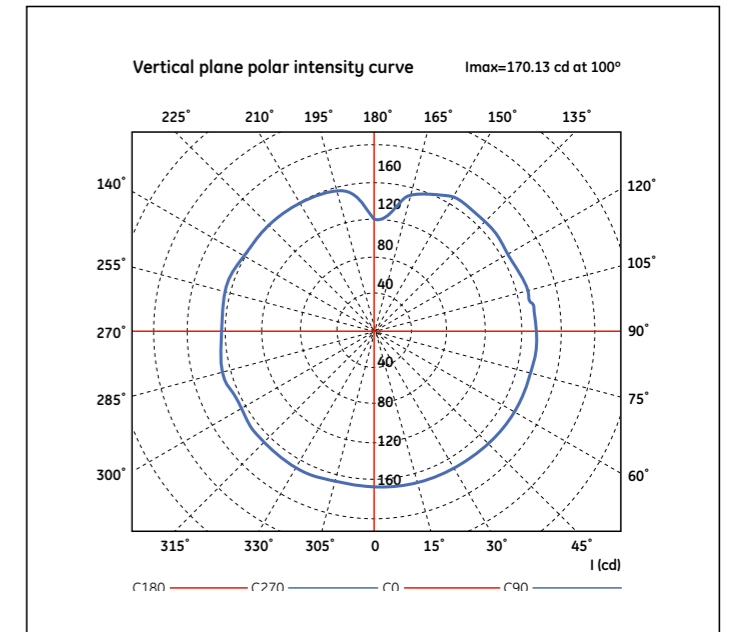
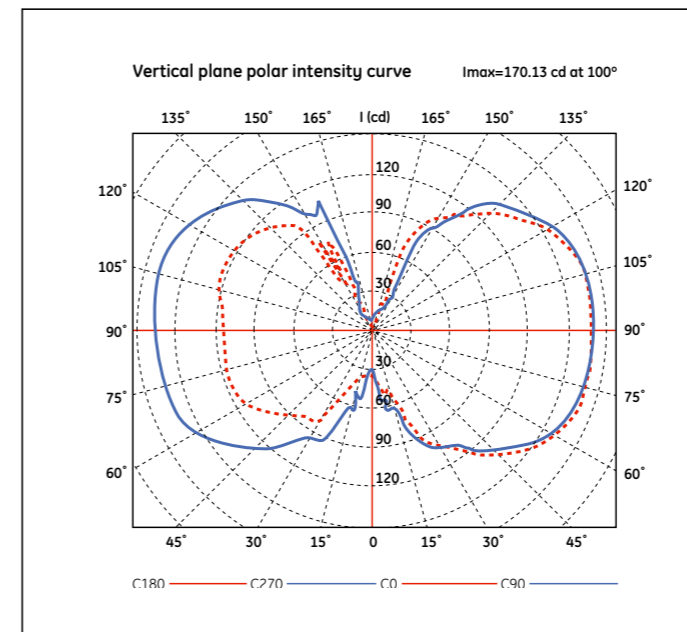

Warm-up characteristics

During the warm-up period immediately after starting, lamp temperature increases rapidly evaporating mercury and metal halide dose in the arc-tube. Lamp electrical characteristics and light output stabilise in less than 4 minutes. During this period light output increases from zero to full output and colour approaches the final visual effect as each metallic element becomes vaporised.

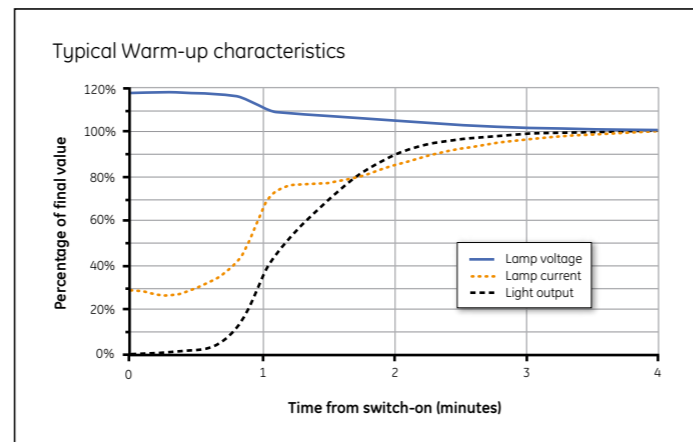

Supply voltage sensitivity

Supply line voltage to conventional magnetic ballast control gear should be as close to the rated nominal value as possible. Lamps will start and operate at 10% below rated supply voltage but this should not be considered as a normal operating condition. In order to maximise lamp survival, lumen maintenance and colour uniformity, supply voltage and rated ballast voltage should be within $\pm 3\%$. Supply variations of $\pm 5\%$ are permissible for short periods only. Where large supply voltage variation is likely to occur, use of electronic control gear, which is designed to function correctly for a voltage range typically 200-250V, should be considered.

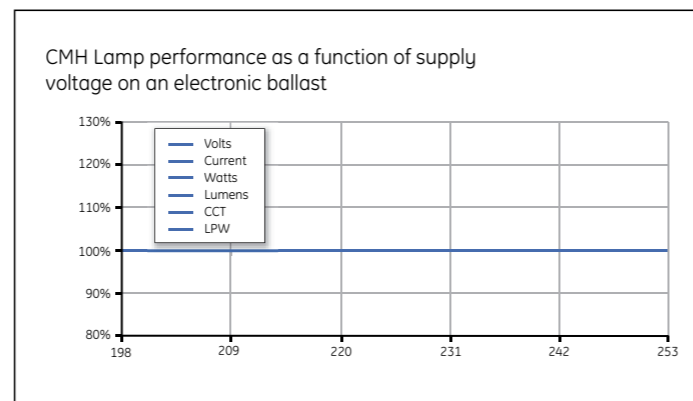
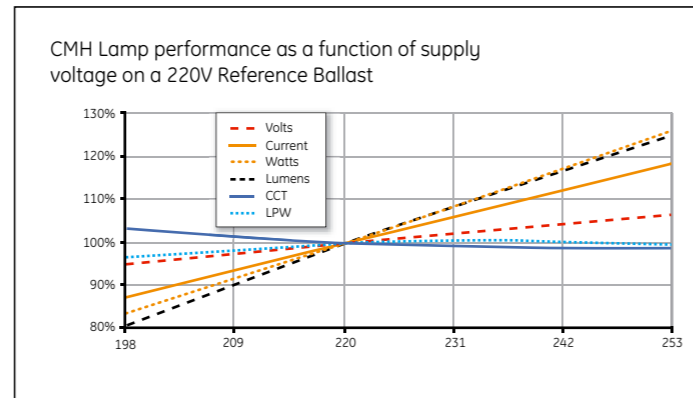

Dimming

In certain cases, dimming may be acceptable, subject to further testing. Contact your GE representative for more information. Large changes in lamp power alter the thermal characteristics of the lamp resulting in lamp colour shift and possible reduction in lamp through life survival.

Flicker

When ConstantColor CMH™ lamps are operated from a conventional magnetic ballast there will be 50Hz line frequency light output flicker typically of 1.5%, in common with all other discharge lamps. Noticeably lower flicker levels occur when lamps are operated horizontally.

Flicker levels of 1.5% do not normally cause concern to the end user, but use of electronic control gear should be considered where visual comfort and performance is critical. Suitable electronic ballasts for ConstantColor CMH™ typically provide square wave operation in the range 70-200Hz, eliminating perceptible flicker.

Lamp end of life conditions

The principal end-of-life failure mechanism for CMH™ lamps is arc tube leakage into the outer jacket. High operating temperature inside the arc-tube causes metal halide dose material to gradually corrode through the ceramic arc tube wall, eventually resulting at normal end-of-life in leakage of the filling gas and dose. Arc-tube leakage into the outer jacket can be observed by a sudden and significant lumen drop and a perceptible color change (usually towards green).

The above situation is often accompanied by the so-called rectification phenomena. This occurs where a discharge is established between two mount-frame parts of different material and/or mass, causing asymmetry in the electrical characteristic of the resulting discharge current. Rectification can lead to overheating of the ballast, therefore conventional magnetic ballasts must conform to requirements of the IEC61167 lamp standard by incorporating protection to maintain safety and prevent damage.

It is good practice when lamps are operated continuously 24 hours per day, 7 days per week to introduce switching once every 24 hours. Lamps with one electrode failing often will not restart and can therefore be easily detected and replaced.

Lumen depreciation

All metal halide lamps experience a reduction in light output and slight increase in power consumption through life. Consequently there is an economic life when the efficacy of lamps fall to a level at which is advisable to replace lamps and restore illumination levels. Where a number of lamps are used within the same area it may be well worth considering a group lamp replacement programme to ensure uniform output from all the lamps.

End of life cycling

A condition can exist at end-of-life whereby lamp voltage rises to a value exceeding the voltage supplied by the control gear. In such a case the lamp extinguishes and on cooling restarts when the required ignition voltage falls to the actual pulse voltage provided by the ignitor. During subsequent warm-up the lamp voltage will again increase, causing extinction. This condition is known as end-of-life cycling. Normally cycling is an indication that lamp end-of-life has been reached, but it can also occur when lamps are operated above their recommended temperature. Lamp voltage at 100 hours life should not increase by more than 5V when operating in the luminaire, when compared to the same lamp operating in free-air. A good luminaire design will limit lamp voltage rise to 3V.

It is good practice to replace lamps that have reached end-of-life as soon as possible after failure, to minimise electrical and thermal stress on ignitor internal components. The use of a 'timed' or 'cut-out' ignitor is not a specific requirement for ConstantColor CMH™ lamps, but is worth considering as a good optional safety feature which also prolongs the life of ignitor internal components, lamp holder contact surfaces and fixture wiring.

The operating period of a timed/cut-out ignitor must be adequate to allow lamps to cool and restart. A period of 10 to 15 minutes continuous or intermittent operation is recommended before the ignitor automatically switches off. Timed/cut-out ignitors specifically offered for High-Pressure Sodium lamps, where the period of operation is less than 5 minutes, are not suitable for ConstantColor CMH™ lamps.

UV and damage to sensitive materials

The wall of the bulb, which is produced with specially developed 'UV Control' material, absorbs potentially harmful high energy UV radiation emitted by the ceramic arc-tube.

The use of UV control material together with an optically neutral front glass cover allows the lamp to significantly reduce the risk of discolouration or fading of products. When illuminating light-sensitive materials or at high light levels, additional UV filtration is recommended. Luminaires should not be used if the front glass is broken or missing. It is recommended that a safety interlock switch is incorporated into the luminaire to prevent operation when the luminaire is opened.

Although PET determines limits of human exposure to lamp UV, the risk of fading of materials due to UV can be quantified by a Damage Factor and a Risk of Fading. The risk of fading is simply the numerical product of the illuminance, exposure time and damage factor due to the light source.

Finally the selection of luminaire materials should take into consideration the UV emission. Current UV reduction types on the market are optimised for UV safety of human eye and skin exposure. However, luminaire materials may have different wavelength dependent response functions. Designers must take account of emission in each of the UV-A, UV-B and UV-C spectral ranges as well as material temperatures when designing luminaires. Typical values for UV-A, UV-B and UV-C range radiation can be found in the table below.

Lamp type		20W 3000K	35W 3000K	35W 4200K	70W 3000K	70W 4200K
UV-PET Performance $\mu\text{W} / (\text{cm}^2) / 500\text{LUX}$						
UV C	220-280nm	0.036	0.0367	0.020	0.014	0.011
UV B	280-315nm	0.049	0.0467	0.040	0.006	0.009
UV A	315-400nm	10.170	10.360	113.870	6.980	9.800
UVC/UVB		10.720	0.786	0.509	2.365	1.321
UVB/UVA		0.005	0.005	0.003	0.001	0.0099
E _{eff}		0.052		0.034	0.015	0.014
PET (h)±10%		16	15	26	54	64
Risk Group	IESNA RP-27.3-96	Exempt	Exempt	Exempt	Exempt	Exempt

Information on luminaire design

Ballasts

ConstantColor CMH™ operate from the same type of ballast as conventional quartz technology metal halide lamps of the same nominal power. IEC 61167 MH lamp standard and IEC62035 HID lamp safety standard specify use of ballast thermal protection or equivalent protection device in the circuit. This safety device will protect the ballast and fixture from overheating damage at lamp end-of-life should rectification occur due to electrode imbalance or arc-tube failure. The IEC61167 requirement applies to both ceramic and quartz arc tube metal halide lamps of the UV-A, UV-B and UV-C spectral ranges as well as material temperatures when designing luminaires.

ConstantColor™ CMH G8.5 lamps are compatible with a list of approved ballasts; contact your GE representative for more information.

Stay magnetic field from conventional ballast

At the design stage for fixtures incorporating the control gear, careful consideration should be given to the physical layout of the lamp and ballast. The relative positions and distance between lamp and ballast can adversely affect lamp performance and drastically reduce lamp life survival.

Conventional magnetic ballasts can produce a stray magnetic field and if the lamp is placed within this field, "bowing" of the arc in the discharge tube can occur. Since ceramic is a very rigid material severe arc bowing can cause high thermal stress leading to cracking or rupture of the arc-tube resulting in failure of the lamp early in life.

Such bowing of the arc can also affect the quartz arc-tube in conventional metal halide lamps, but cracking or rupture failure is less likely since quartz softens at the resulting higher wall temperature causing the arc-tube to become swollen. Excessive swelling of a quartz arc-tube can however also result in cracking or rupture failure.

In fixtures where the ballast is necessarily placed close to the lamp, use of magnetic shielding is essential. Another solution is to use an electronic ballast, which eliminates the need for an ignitor, simplifies wiring, reduces the risk of stray magnetic field and eliminates light output flicker.

Electronic ballast operation

CMH 20W is designed only for operation from electronic gear*. This provides many advantages:

- Flicker free light output
- Well controlled electronic ignition process
- Simple wiring for fixtures due to elimination of ignitor and PFC capacitor
- Reduces fixture weight
- Automatic sensing of failed lamps and shutdown
- Lower overall system power consumption
- On further details of operating gear please refer to GE

Containment requirement

ConstantColor CMH™ lamps operate above atmospheric pressure, therefore a very small risk exists that the lamp may shatter when the end-of-life is reached. Although this failure mode is unlikely, containment of shattered particles is required as prescribed by IEC 61167. ConstantColor CMH™ lamps should only be operated in a suitable enclosed luminaire with front cover glass capable of containing the fragments of a lamp, should it shatter.

Circuit diagram electronic ballast

LH = Lamp holder
E = Electronic Gear

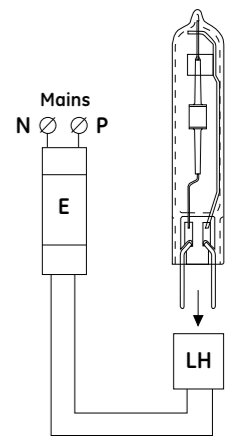

Control gear and accessories

Electronic Ballasts

A range of GE electronic ballasts have been introduced to complement the 20, 35, 70 and 150W ConstantColor™ Ceramic Metal Halide lamps
Power controlled electronic ballasts suitable for operation of Ceramic Metal Halide lamps are available from various gear manufacturers.

Advantages are:

- Good regulation against supply voltage variation
- Improved lamp colour consistency
- Elimination of lamp flicker
- Reduced weight of control gear
- Reduced electrical power losses
- Ballast noise reduced/eliminated
- Single piece compact unit
- Reduced wiring complexity in the luminaire



Features

- Integral version with open terminals for embodiment into luminaire
- Remote version with terminal cover and cable strain relief for location outside the luminaire
- 50,000 hours service life under the specified conditions
- Reduced power consumption compared to electromagnetic circuits
- Reduced component count and simplified wiring compared to electromagnetic circuits
- Rapid and controlled power run-up
- Lamp life maximised by square-wave current and constant lamp power
- Excellent lamp colour stability throughout life
- Automatic lamp failure shut-down
- Timed restart after mains voltage interruption
- Immune to mains voltage variations

General Information

Watts	Volts	Description	Mounting	Weight	Pack Qty	Product Code
20	220-240	BLS/E/20W/CMHSMP	Integral	110 g	12	42387
20	220-240	BLS/E/20W/CMH	Integral	190 g	12	13032
20	220-240	BLS/E/20W/CMH/R	Remote	230 g	12	13034
35	220-240	BLS/E/35W/CMH	Integral	215 g	12	13035
35	220-240	BLS/E/35W/CMH/R	Remote	230 g	12	13036
70	220-240	BLS/E/70W/CMH	Integral	300 g	12	13040
70	220-240	BLS/E/70W/CMH/R	Remote	310 g	12	13047
150	220-240	BLS/E/150W/CMH	Integral	430 g	12	13050
150	220-240	BLS/E/150W/CMH/R	Remote	445 g	12	13053

System Performance		20W	35W	70W	150W
System Power	W	23.5	43	78	159
System	lm/W	72	79	79	88
Lumens*	lm	1700	3400	6200	14000
Lamp Power	W	20	39	72	146
Lamp Efficacy	lm/W	85	87	86	96
Lamp Voltage Range	V	70...125	70...125	70...125	70...125

* Data shown relates to 3000K products. Please see lamp data sheets for performance of equivalent 4200K rated products.

Operating Characteristics		20W	20W	35W	70W	150W
Mains Voltage	V	220...240	220...240	220...240	220...240	220...240
Mains Current	A	0.19	0.10	0.18	0.33	0.69
Mains Frequency	Hz	50	50...60	50...60	50...60	50...60
Power Factor		> 0.55	> 0.95	> 0.95	> 0.95	> 0.95
Allowed Mains Voltage Range	V	198...264	198...264	198...264	198...264	198...264
Ignition Voltage*	kV	< 3.5	< 2.5	< 2.5	< 2.5	< 2.5
Lamp Operating Frequency	Hz	133	150	150	150	150
Max Cable Capacitance	pF	1000	1000	3000	3000	3000
Max Lamp Distance**	m	2	10	25	25	25
Ambient Temperature Range	°C	-20...+50	-20...+50	-20...+50	-20...+50	-20...+50
Maximum Case Temperature	°C	80	75	75	75	80
Thermal Cut-off on PCB	°C	110	110	110	110	110

* If a hot lamp or no lamp is detected the ballast will attempt to start the lamp after one minute, if not successful further attempts are made up to a maximum of 4 times in 5 minute cycles, then if not successful the ballast will shut-down. The ballast is reset automatically by a supply interruption.
** Typical value if cable capacitance is below the specified limit

Dimension

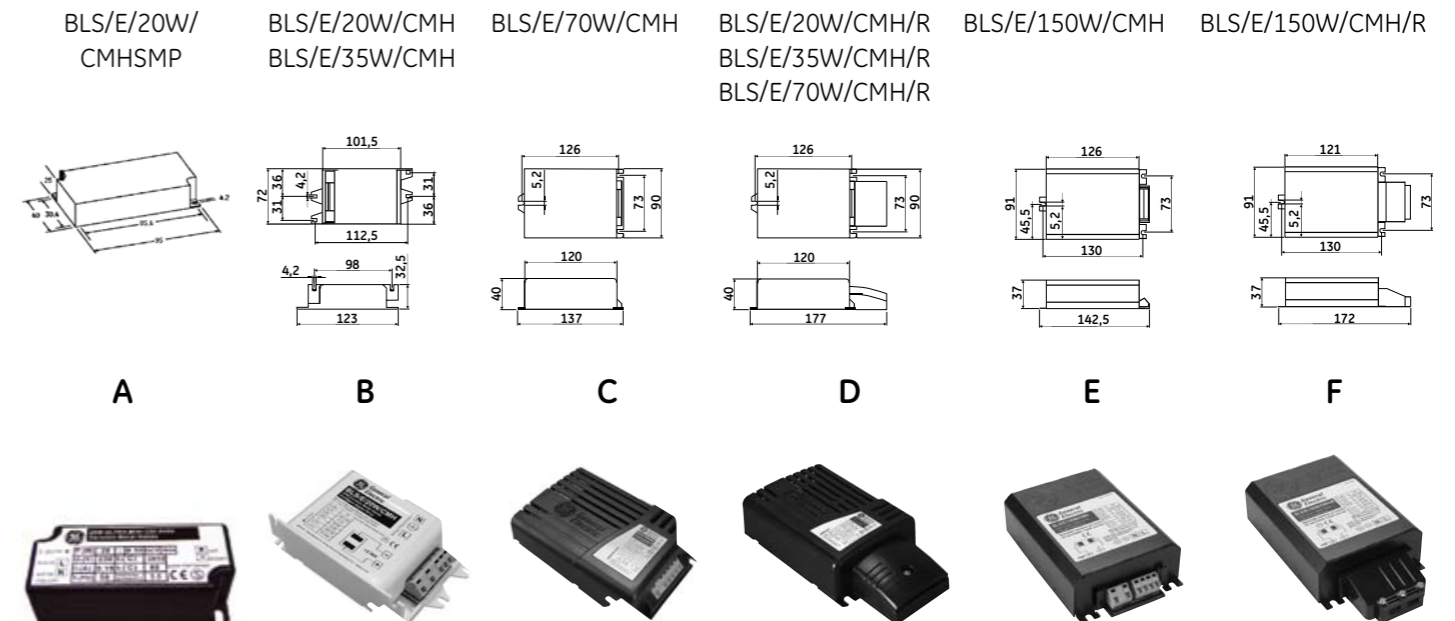

Circuitry

Wire cross section: 0.75...2.5 mm²

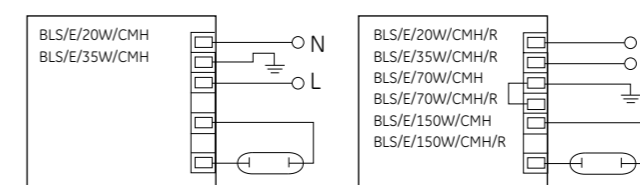

The ballasts comply with the relevant parts of the following standards:

- RFI suppression EN 55015
- Harmonics EN 61000-3-2
- Immunity EN 61547
- Safety EN 60926/EN 60928/EN 61347
- Performance EN 60927/EN 60929

Superimposed ignitors

In many installations Ceramic Metal Halide lamps are operated from a conventional magnetic ballast in conjunction with a superimposed ignitor. These ignitors generate starting pulses independently from the ballast and should be placed close to the lamp, preferably within the luminaire. Wiring between ignitor and lamp should have a maximum capacitance to earth of 100pF (length equivalent to less than 1 Metre) - contact ignitor manufacturer for details of specific ignitor types. A typical circuit diagram is shown:

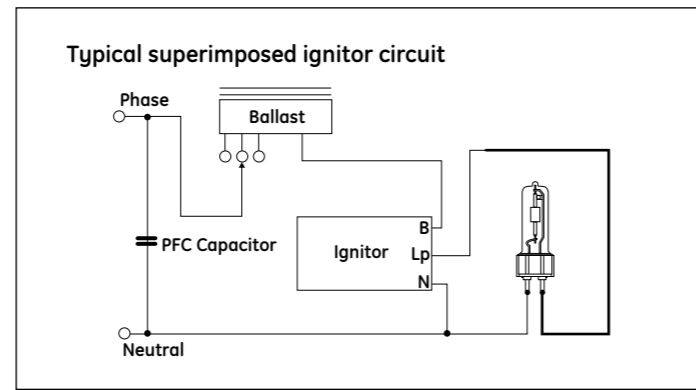

Suitable Ignitors

Suitable high-energy (superimposed) ignitors recommended by control gear manufacturers are listed below. Check with suppliers for their current range of ignitors. Lamp re-starting under warm lamp conditions can take up to 15 minutes. Suitable ignitors to achieve a warm restart of less than 15 minutes include the following, however the list may not be fully inclusive:

Maker	Products				
APF	SP23				
BAG Turgi	NI 150 SE	NI 150 SE-TM20	MZN 150 SE-C	NI 400 LE/3.5 A	NI 400 LE/3.5 A-TM20
ERC	AZ A 1.8	AZ P 1.8	AZ P 1.8 T3	AZ P 1.8 T3	AZ P 3.0 T3
Helvar	L-150	LSI-150T20			
Magnetek/May & Christe	ZG 0.5	ZG 2.0	ZG 2.0D	ZG 4.5D	
Parry/Parmer	PAV400	PCX400	PXE100		
Philips	SU20S				
Thorn	G53459	G53498	G53476	G53504.TB	
Tridonic	ZRM 1.8-ES/B	ZRM 2.5-ES/B	ZRM 4.5-ES/B	ZRM 6-ES/B	ZRM 2.5-ES/B
Vossloh-Schwabe	Z 150	Z 150 K	Z 150 K A10	Z 150 K A10	Z 250

Impulser ignitors

Impulser type ignitors use the ballast winding as a pulse transformer and can only be used with a matched ballast. Always check with the ballast and ignitor supplier that components are compatible. Longer cable lengths between ballast & ignitor and the lamp are possible due to the lower pulse frequency generated, giving greater flexibility for remote control gear applications. Ignitor pulse characteristics at the lamp must however comply with specified minimum values for ConstantColor CMH™ lamps under all conditions.

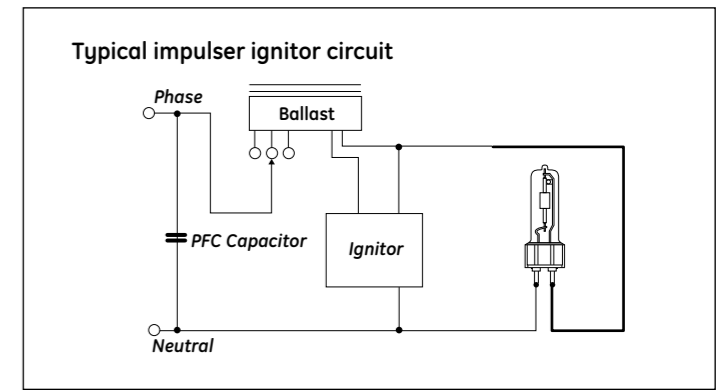

Other ignitor related considerations

Timed or Cut-out Ignitors

The use of a 'timed' or 'cut-out' ignitor is not a specific requirement for ConstantColor CMH™ lamps but it is a good optional safety feature worth considering to prolong ignitor component life. The timed on-period must be adequate to allow lamps to cool and restart as described below. A period of 10-15 minutes continuous or intermittent operation is recommended before the ignitor automatically switches off. Timed ignitors specifically offered for High-Pressure Sodium lamps where the period of operation is less than 5 minutes are not suitable for ConstantColor CMH™ lamps.

Hot Re-strike

All ratings re-strike within 15 minutes following a short interruption in the supply. Actual re-strike time is determined by the ignitor type, pulse voltage and cooling rate of the lamp. Instant hot re-strike is only possible using a suitable very high voltage ignitor and a double ended lamp. GE Lighting should be consulted when considering use of an instant hot re-striking system.

Warm Re-starting

The combined characteristics of ceramic arc-tube material and vacuum outer jacket result in ConstantColor CMH™ lamps cooling relatively slowly. It is possible with low energy ignitors to reach the required breakdown voltage but not create a full thermionic discharge. Under these conditions the lamp can remain very warm and be prevented from cooling to a temperature at which the arc can be re-established. To avoid this, turn off the power supply for approximately fifteen minutes or change to a suitable high energy ignitor from the list given in the superimposed ignitor section.

Fusing Recommendations

For a very short period immediately after switch-on, all discharge lamps can act as a partial rectifier and a conventional magnetic ballast may allow higher than the normal current to flow. At switch-on the short duration surge current drawn by the power factor correction capacitor can be high. In order to prevent nuisance fuse failure at initial switch-on, the fuse rating must take these transient conditions into account. A separate technical data sheet providing additional explanation and information for the fusing of High Intensity Discharge lighting circuits is available from GE Lighting.

Fusing of individual fixtures is recommended, in order to provide added protection for end-of-life conditions when lamp rectification can also occur.

Number of Lamps	1	2	3	4	5	6
35W Fuse Rating (A)	4	4	4	4	4	4
70W Fuse Rating (A)	4	4	4	4	4	4
150W Fuse Rating (A)	4	4	4	6	6	10

Free Manuals Download Website

<http://myh66.com>

<http://usermanuals.us>

<http://www.somanuals.com>

<http://www.4manuals.cc>

<http://www.manual-lib.com>

<http://www.404manual.com>

<http://www.luxmanual.com>

<http://aubethermostatmanual.com>

Golf course search by state

<http://golfingnear.com>

Email search by domain

<http://emailbydomain.com>

Auto manuals search

<http://auto.somanuals.com>

TV manuals search

<http://tv.somanuals.com>