



900 Watts

Model: JVM1350

Profile

SpacemakerXL Microwave Oven

Owner's Manual

	<p>Important Safety Information</p> <p><i>Precautions to Avoid Possible Exposure to Excessive Microwave Energy.....2</i></p> <p><i>Special Notes About Microwaving.....6</i></p>	2
	<p>Operating Instructions</p> <p><i>Features of Your Microwave11</i></p> <p><i>The Controls on Your Microwave.....12</i></p> <p><i>Time Cooking15</i></p> <p><i>Temperature Cooking.....21</i></p> <p><i>Automatic Cooking25</i></p> <p><i>Other Features30</i></p>	11
	<p>Helpful Information</p> <p><i>Oven Shelf34</i></p> <p><i>Care and Cleaning37</i></p>	34
	<p>If Something Goes Wrong</p> <p><i>Before You Call For Service (Problem Solver).....42</i></p> <p><i>GE Service Numbers46</i></p> <p><i>WarrantyBack Cover</i></p>	42

GE Answer Center®
800.626.2000

GE Appliances



Important Safety Information

Read all safety information before using

For Your Safety

PRECAUTIONS TO AVOID POSSIBLE EXPOSURE TO EXCESSIVE MICROWAVE ENERGY

For your safety the information in this manual must be followed to minimize the risk of fire or explosion or to prevent property damage, personal injury or loss of life.

Do Not Attempt to operate this oven with the door open since open-door operation can result in harmful exposure to microwave energy. It is important not to defeat or tamper with the safety interlocks.

Do Not Place any object between the oven front face and the door or allow soil or cleaner residue to accumulate on sealing surfaces.

Do Not Operate the oven if it is damaged. It is particularly important that the oven door close properly and that there is no damage to the:

- 1** door (bent)
- 2** hinges and latches (broken or loosened)
- 3** door seals and sealing surfaces.

The Oven Should Not be adjusted or repaired by anyone except properly qualified service personnel.

Welcome

Welcome to the GE family. We're proud of our quality products and we believe in dependable service. You'll see it in this easy-to-use manual and you'll hear it in the friendly voices of our customer service department.

Best of all, you'll experience these values each time you use your microwave. That's important, because your new microwave will be part of your family for a long time.

Start Here!

*Before
using
your
microwave
oven*

Staple your receipt to the inside back cover of this manual.

Be sure your microwave oven is registered.

It is important that we know the location of your microwave oven should a need occur for adjustments.

Your dealer (or builder) is responsible for registering you as the owner.

Please check with your dealer (or builder) to be sure he has done so; also send in your Consumer Product Ownership Registration Card. If you move, or if you are not the original purchaser, please call us with your change of address or ownership, stating model and serial numbers. Call 800.626.2000.

This appliance must be registered. Please be certain that it is.

Write down the model and serial numbers here. They are on a label inside the oven.

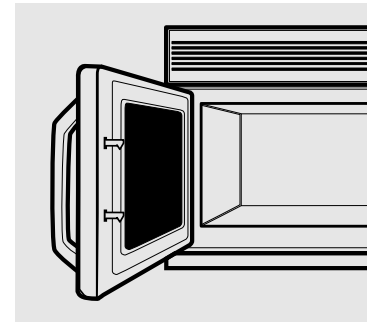

Model number

Serial number

Date of purchase

Need Help?

*Help us
help you*

800.626.2000

Before you call for service, there are a few things you can do to help us serve you better.

Read this manual. It contains instructions to help you use and maintain your microwave properly.

If you received a damaged oven... Immediately contact the dealer (or builder) that sold you the oven.

Save time and money. Check the section titled "If Something Goes Wrong" before calling. This section was designed to solve common problems you might encounter.

If you do need service, you can relax knowing help is only a phone call away. A list of toll-free customer service numbers is included in the back of this book. Or call the GE Answer Center® at 800.626.2000, 24 hours a day, 7 days a week.



Important Safety Information

Read all safety information before using

Warning

To reduce the risk of fire, electric shock, injury to persons, or exposure to excessive microwave energy when using your appliance, follow basic precautions, including the following sections.

Safety Precautions

This microwave oven is UL listed for installation over electric and gas ranges.

This microwave oven is not approved or tested for marine use.

- Read and follow the specific “Precautions to Avoid Possible Exposure to Excessive Microwave Energy.”
- This appliance must be grounded. Connect only to properly grounded outlet. See Grounding Instructions section.
- Do not mount this appliance over a sink.
- Install or locate this appliance only in accordance with the provided Installation Instructions.
- This over-the-range oven was designed for use over ranges no wider than 42 inches. It may be installed over both gas and electric cooking equipment.
- Do not operate this appliance if it has a damaged power cord or plug, if it is not working properly, or if it has been damaged or dropped.
- Use this appliance only for its intended use as described in this guide. Do not use corrosive chemicals or vapors in this appliance. This microwave oven is specifically designed to heat or cook food, and is not intended for laboratory or industrial use.
- Do not store this appliance outdoors. Do not use this product near water—for example, in a wet basement, near a swimming pool or near a sink.
- Do not cover or block any openings on the appliance.
- Keep power cord away from heated surfaces.
- Do not immerse power cord or plug in water.



- To reduce the risk of fire in the oven cavity:
 - Do not overcook food. Carefully attend appliance if paper, plastic or other combustible materials are placed inside the oven while cooking.
 - Remove wire twist-ties and metal handles from paper or plastic containers before placing them in the oven.
 - Do not use the oven for storage purposes. Do not leave paper products, cooking utensils or food in the oven when not in use.
 - If materials inside oven should ignite, keep the oven door closed, turn the oven off and disconnect the power cord, or shut off power at the fuse or circuit breaker panel. If the door is opened, the fire may spread.
- See door surface cleaning instructions in the Care and Cleaning section(s) of this guide.
- This appliance should be serviced only by qualified service personnel. Contact nearest authorized service facility for examination, repair or adjustment.
- As with any appliance, close supervision is necessary when used by children.

SAVE THESE INSTRUCTIONS



Important Safety Information

Special Notes About Microwaving

Arcing

If you see arcing, press the CLEAR/OFF pad and correct the problem.

Arcing is the microwave term for sparks in the oven. Arcing is caused by:

- The temperature probe in the microwave but not inserted in the food.
- The metal shelf not installed correctly so it touches the microwave wall.
- Metal or foil touching the side of the oven.
- Foil not molded to food (upturned edges act like antennas).
- Metal, such as twist ties, poultry pins, or gold-rimmed dishes, in the microwave.
- Recycled paper towels containing small metal pieces being used in the microwave.

Foods

- Do not pop popcorn in your microwave oven unless in a special microwave popcorn accessory or unless you use popcorn labeled for use in microwave ovens.
- Some products such as whole eggs and sealed containers—for example, closed jars—will explode and should not be heated in this microwave oven. Such use of the microwave oven could result in injury.
- Do not boil eggs in a microwave oven. Pressure will build up inside egg yolk and will cause it to burst, possibly resulting in injury.
- Operating the microwave with no food inside for more than a minute or two may cause damage to the oven and could start a fire. It increases the heat around the magnetron and can shorten the life of the oven.
- Foods with unbroken outer “skin” such as potatoes, hot dogs, sausages, tomatoes, apples, chicken livers and other giblets, and egg yolks should be pierced to allow steam to escape during cooking.
- Avoid heating baby food in glass jars, even with the lid off. Make sure all infant food is thoroughly cooked. Stir food to distribute the heat evenly. Be careful to prevent scalding when warming formula or breast milk. The container may feel cooler than the milk really is. Always test the milk before feeding the baby.



Do not boil liquids in narrow-necked containers.

- Spontaneous boiling—Under certain special circumstances, liquids may start to boil during or shortly after removal from the microwave oven. To prevent burns from splashing liquid, we recommend the following: before removing the container from the oven, allow the container to stand in the oven for 30 to 40 seconds after the oven has shut off. Do not boil liquids in narrow-necked containers such as soft drink bottles, wine flasks and especially narrow-necked coffee cups. Even if the container is opened, excessive steam can build up and cause it to burst or overflow.
- Don't defrost frozen beverages in narrow-necked bottles (especially carbonated beverages). Even if the container is opened, pressure can build up. This can cause the container to burst, possibly resulting in injury.
- Hot foods and steam can cause burns. Be careful when opening any containers of hot food, including popcorn bags, cooking pouches and boxes. To prevent possible injury, direct steam away from hands and face.
- Do not overcook potatoes. They could dehydrate and catch fire, causing damage to your oven.
- When cooking pork, follow the directions exactly and always cook the meat to an internal temperature of at least 170°F. This assures that, in the remote possibility that trichina may be present in the meat, it will be killed and meat will be safe to eat.



Important Safety Information

Special Notes About Microwaving

Microwave-Safe Cookware

If you use a meat thermometer while cooking, make sure it is safe for use in microwave ovens.



How to Test for a Microwave-Safe Dish

Make sure all cookware used in your microwave oven is suitable for microwaving. Most glass casseroles, cooking dishes, measuring cups, custard cups, pottery or china dinnerware which does not have metallic trim or glaze with a metallic sheen can be used. Some cookware is labeled “suitable for microwaving.”

- If you are not sure if a dish is microwave-safe, use this test: Place in the oven both the dish you are testing and a glass measuring cup filled with 1 cup of water—set the measuring cup either in or next to the dish. Microwave 1 minute at high. If the dish heats, it should not be used for microwaving. If the dish remains cool and only the water in the cup heats, then the dish is microwave-safe.
- Do not use recycled paper products. Recycled paper towels, napkins and waxed paper can contain metal flecks which may cause arcing or ignite. Paper products containing nylon or nylon filaments should be avoided, as they may also ignite.
- Some styrofoam trays (like those that meat is packaged on) have a thin strip of metal embedded in the bottom. When microwaved, the metal can burn the floor of the oven or ignite a paper towel.
- Do not use the microwave to dry newspapers.
- Not all plastic wrap is suitable for use in microwave ovens. Check the package for proper use.
- Paper towels, waxed paper and plastic wrap can be used to cover dishes in order to retain moisture and prevent spattering. Be sure to vent plastic wrap so steam can escape.
- Cookware may become hot because of heat transferred from the heated food. Pot holders may be needed to handle the cookware.
- “Boilable” cooking pouches and tightly closed plastic bags should be slit, pierced or vented as directed by package. If they are not, plastic could burst during or immediately after cooking, possibly resulting in injury. Also, plastic storage containers should be at least partially uncovered because they form a tight seal. When cooking with containers tightly covered with plastic wrap, remove covering carefully and direct steam away from hands and face.
- Use foil only as directed in this guide. TV dinners may be microwaved in foil trays less than 3/4” high; remove the top foil cover and return the tray to the box. When using foil in the microwave oven, keep the foil at least 1 inch away from the sides of the oven.



- **Plastic cookware**—Plastic cookware designed for microwave cooking is very useful, but should be used carefully. Even microwave-safe plastic may not be as tolerant of overcooking conditions as are glass or ceramic materials and may soften or char if subjected to short periods of overcooking. In longer exposures to overcooking, the food and cookware could ignite.

Follow these guidelines:

- 1** Use microwave-safe plastics only and use them in strict compliance with the cookware manufacturer's recommendations.
- 2** Do not microwave empty containers.
- 3** Do not permit children to use plastic cookware without complete supervision.

The Vent Fan

The fan will operate automatically under certain conditions (see Automatic Fan feature). Take care to prevent the starting and spreading of accidental cooking fires while the vent fan is in use.

- Clean the underside of the microwave often. Do not allow grease to build up on the microwave or the fan filters.
 - In the event of a grease fire on the surface units below the microwave oven, smother a flaming pan on the surface unit by covering the pan completely with a lid, a cookie sheet or a flat tray.
 - Use care when cleaning the vent fan filters. Corrosive cleaning agents, such as lye-based oven cleaners, may damage the filters.
- When flaming foods under the microwave, turn the vent fan off. The fan, if operating, may spread the flame.
 - Never leave surface units, beneath your microwave oven, unattended at high heat settings. Boilovers cause smoking and greasy spillovers that may ignite and spread if the microwave vent fan is operating. To minimize automatic fan operation, use adequate sized cookware and use high heat on surface units only when necessary.



Important Safety Information

Grounding Instructions/Optional Kits

Grounding Instructions

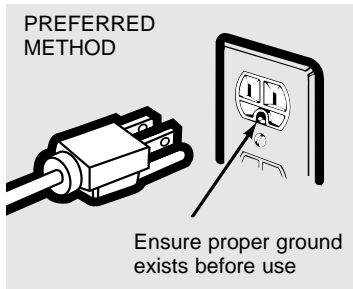

⚠ WARNING—Improper use of the grounding plug can result in a risk of electric shock.

This appliance must be grounded. In the event of an electrical short circuit, grounding reduces the risk of electric shock by providing an escape wire for the electric current. This appliance is equipped with a power cord having a grounding wire with a grounding plug. The plug must be plugged into an outlet that is properly installed and grounded.

Consult a qualified electrician or service technician if the grounding instructions are not completely understood, or if doubt exists as to whether the appliance is properly grounded.

If the outlet is a standard 2-prong wall outlet, it is your personal responsibility and obligation to have it replaced with a properly grounded 3-prong wall outlet.

Do not under any circumstances cut or remove the third (ground) prong from the power cord.

Do not use an adapter plug with this appliance.

Do not use an extension cord with this appliance. If the power cord is too short, have a qualified electrician or service technician install an outlet near the appliance.

For best operation, plug this appliance into its own electrical outlet to prevent flickering of lights, blowing of fuse or tripping of circuit breaker.

Optional Accessories

Available at extra cost from your GE supplier.

Filler Panel Kits

JX40WH—White

JX41—Black

JX40AL—Almond

When replacing a 36" or 42" range hood, this kit fills in the additional width to provide a custom built-in appearance. For installation between cabinets only; not for end-of-cabinet installation. Each kit contains two 3"-wide filler panels. Two kits are needed for a 42" opening.

Filter Kits

JX81A—Recirculating Charcoal Filter Kit

To be used when the microwave oven cannot be vented to the outside.

Decorative Panel Kit

JX22SS—Stainless Steel

When replacing a Hi/Low range, this panel kit fills in the area between the microwave and the range left by the Hi/Low model.

Operating Instructions

Features of Your Microwave



Features

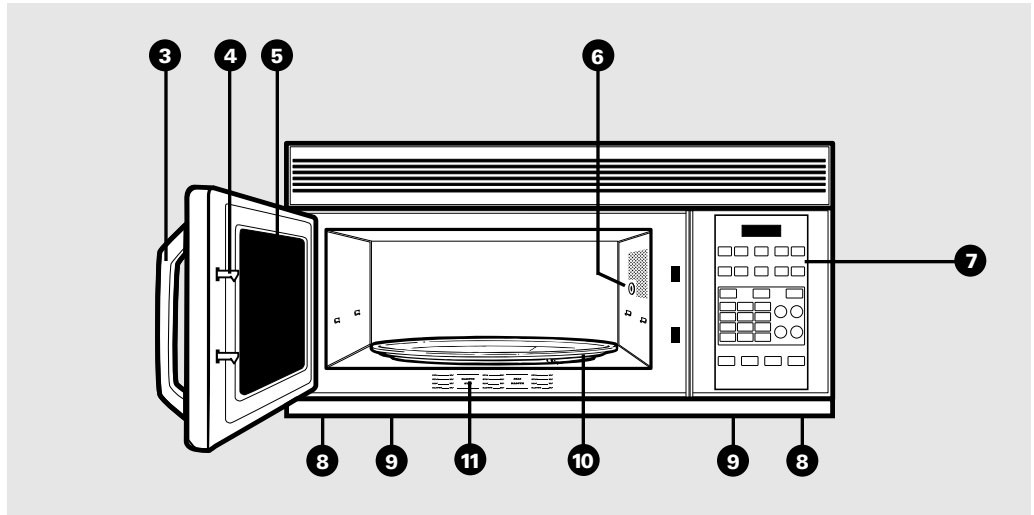
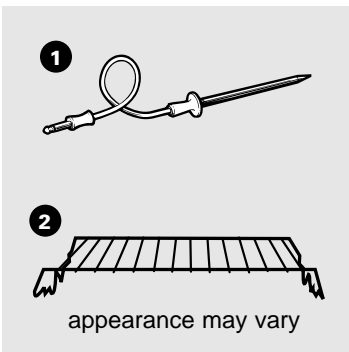

Wattage:
900 Watts

- 1 Temperature Probe.** Use with Temp Cook and Roast functions only.
 - 2 Shelf.** Lets you microwave several foods at once. Food microwaves best when placed directly on the turntable.
 - 3 Door Handle.** Pull to open the door. The door must be securely latched for the microwave to operate.
 - 4 Door Latches.**
 - 5 Window with Metal Shield.** Screen allows cooking to be viewed while keeping microwaves confined in the oven.
 - 6 Receptacle for Temperature Probe.** Probe must be securely inserted into the receptacle before the oven will Temp Cook or Roast.
 - 7 Touch Control Panel Display.**
 - 8 Cooktop Lights.**
 - 9 Grease Filters.**
 - 10 Removable Turntable.** Turntable and support **must** be in place when using the oven. The turntable may be removed for cleaning.
 - 11 Convenience Guide.**
- NOTE:** Rating plate, oven vent(s) and oven light are located on the inside walls of the microwave oven.



Quick Start

The Controls on Your Microwave Oven

You can microwave by time, temperature or with the sensor features

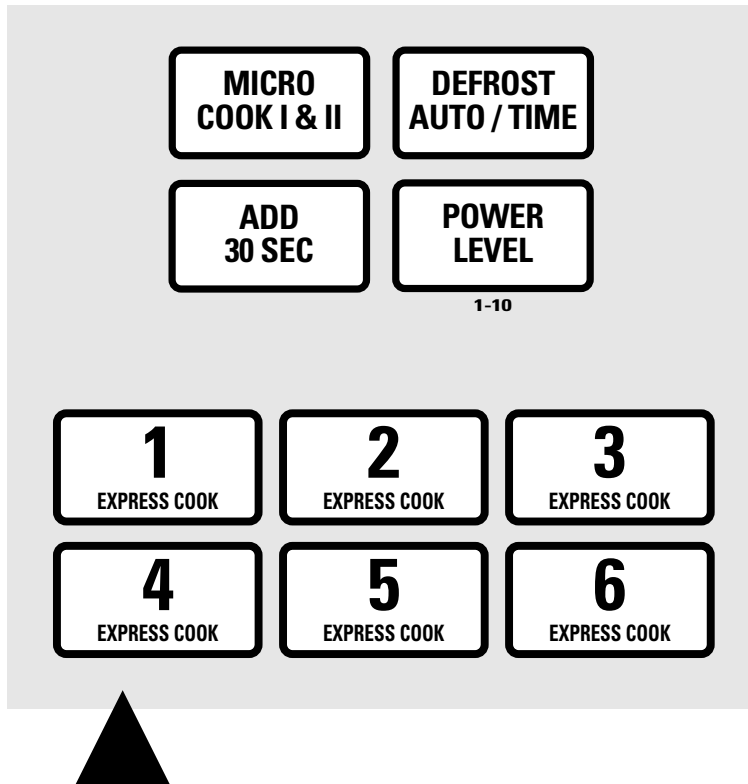

1 Time and Auto Features

Allows you to cook by time.

<i>Press</i>	<i>Enter</i>
MICRO COOK I & II (Press once or twice)	Amount of Cooking Time
DEFROST AUTO/TIME (Press twice)	Amount of Defrosting Time
EXPRESS COOK	Starts immediately!
ADD 30 SEC	Starts immediately!
POWER LEVEL	Power Level 1–10

Allows you to defrost by weight.

<i>Press</i>	<i>Enter</i>
DEFROST AUTO/TIME (Press once)	Food Weight



HELP

Press this pad and any feature pad for usage instructions and tips.

DISPLAY

Follow the instructions displayed.

GUIDE ON MICROWAVE

Before you begin, check the guide located on the inside front of the oven when you open the door.

GUIDES IN BOOK

- Cooking
- Time Defrost
- Roasting
- Simmer
- Sensor Cooking

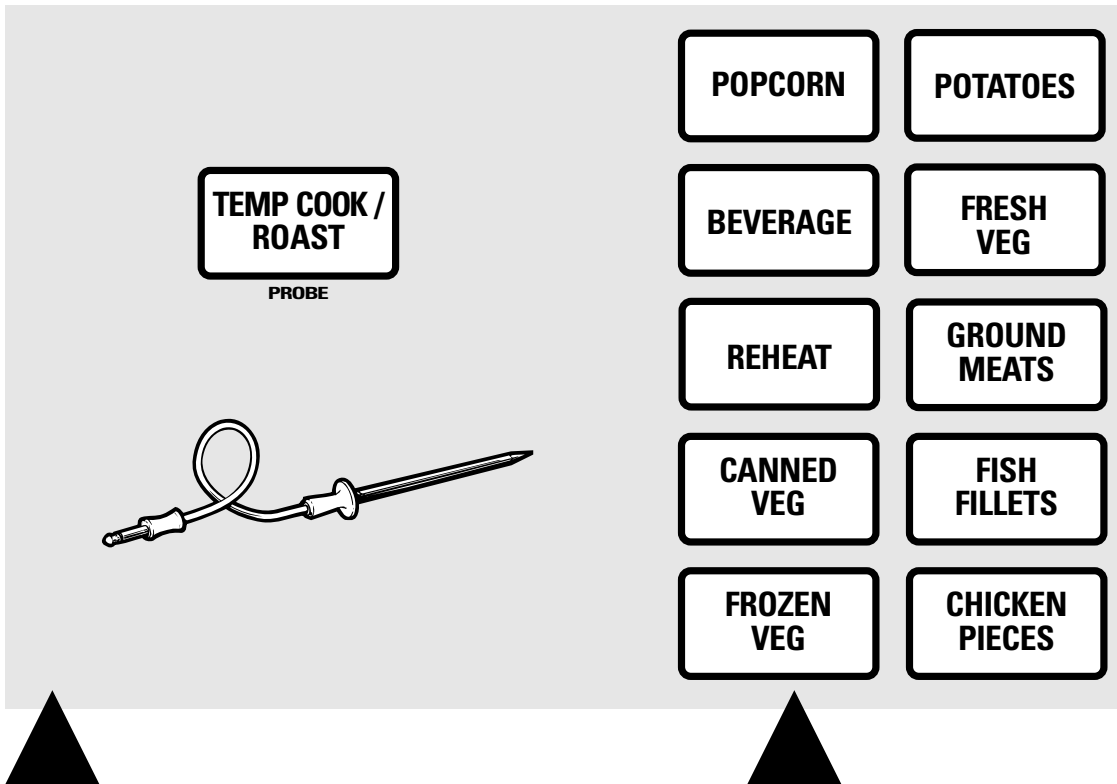

2 Temperature Features

Allows you to cook by temperature. Use the probe.

Press	Enter
TEMP COOK/ROAST (Press once)	Desired food temperature.
TEMP COOK/ROAST (Press twice)	Medium automatically selected.
TEMP COOK/ROAST (Press three times)	Well automatically selected.
TEMP COOK/ROAST (Press four times)	Simmer automatically selected.

3 Sensor Features

Press	Enter	Option
POPCORN	Starts immediately!	more/less time
BEVERAGE	Starts immediately!	
REHEAT	Starts immediately!	more/less time
CANNED VEG	Starts immediately!	
FROZEN VEG	Starts immediately!	more/less time
POTATOES	Starts immediately!	more/less time
FRESH VEG	Starts immediately!	more/less time
GROUND MEATS	Starts immediately!	more/less time
FISH FILLETS	Starts immediately!	more/less time
CHICKEN PIECES	Starts immediately!	more/less time



Operating Instructions

Changing Power Levels

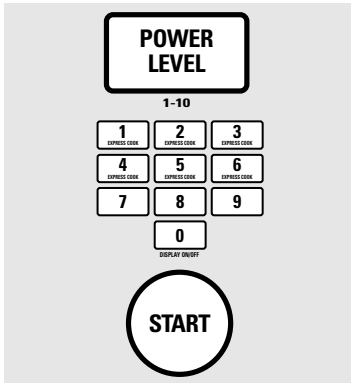

How to Change the Power Level

The power level may be entered or changed immediately after entering the feature time for MICRO COOK, TIME DEFROST or EXPRESS COOK. The power level may also be changed during time countdown.

- 1 Press MICRO COOK I & II or select Time Defrost.
- 2 Enter cooking or defrosting time.
- 3 Press POWER LEVEL.
- 4 Select desired power level 1-10.
- 5 Press START.



Variable power levels add flexibility to your microwave cooking. The power levels on your microwave oven can be compared to the surface units on a range. High (Power Level 10) or full power is the fastest way to cook and gives you 100% power. Each power level gives you microwave energy a certain percent of the time. Power Level 7 is microwave energy 70% of the time. Power Level 3 is energy 30% of the time.

A high setting (10) will cook faster but food may need additional attention such as frequent stirring, rotating or turning over. Most of your cooking will be done on High (Power Level 10). A lower setting will cook more evenly and with less attention given to stirring or rotating the food.

Some foods may have better flavor, texture or appearance if one of the lower settings is used. You may wish to use a lower power level when cooking foods that have a tendency to boil over, such as scalloped potatoes.

Rest periods (when the microwave energy cycles off) give time for the food to “equalize” or transfer heat to the inside of the food. An example of this is shown with Power Level 3—the defrost cycle. If microwave energy did not cycle off, the outside of the food would cook before the inside was defrosted.

Here are some examples of uses for various power levels:

Power Level Best Uses

- High 10** Fish, bacon, vegetables, boiling liquids.
- Med-High 7** Gentle cooking of meat and poultry; baking casseroles and reheating.
- Medium 5** Slow cooking and tenderizing such as stews and less tender cuts of meat.
- Low 2 or 3** Defrosting without cooking; simmering; delicate sauces.
- Warm 1** Keeping food warm without overcooking; softening butter.



Micro Cook

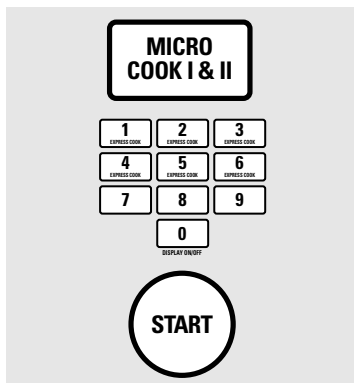

- 1 Press MICRO COOK I & II.**
- 2 Enter cooking time.**
- 3 Change power level if you don't want full power. (Press POWER LEVEL. Select a desired power level 1–10.)**
- 4 Press START.**

Micro Cook I

Allows you to microwave for any time up to 99 minutes and 99 seconds.

Power Level 10 (High) is automatically set, but you may change it for more flexibility.

You may open the door during Micro Cook to check the food. Close the door and press START to resume cooking.

Micro Cook II

Lets you change power levels automatically during cooking. Here's how to do it:

- 1 Press MICRO COOK I & II.**
- 2 Enter the first cook time.**
- 3 Change the power level if you don't want full power. (Press POWER LEVEL. Select a desired power level 1–10.)**
- 4 Press MICRO COOK I & II again.**
- 5 Enter the second cook time.**
- 6 Change the power level if you don't want full power. (Press POWER LEVEL. Select a power level 1–10.)**
- 7 Press START.**

At the end of MICRO COOK I, MICRO COOK II counts down.



Operating Instructions

Cooking Guide for Micro Cook I & II

NOTE: Use Power Level High (10) unless otherwise noted.

Vegetable	Amount	Time	Comments
Asparagus (fresh spears)	1 lb.	7 to 9 min., Med-High (7)	In 1½-qt. oblong glass baking dish, place 1/4 cup water.
(frozen spears)	10-oz. package	5 to 7 min.	In 1-qt. casserole.
Beans (fresh green)	1 lb. cut in half	10 to 12 min.	In 1½-qt. casserole, place 1/2 cup water.
(frozen green)	10-oz. package	6 to 8 min.	In 1-qt. casserole, place 2 tablespoons water.
(frozen lima)	10-oz. package	6 to 8 min.	In 1-qt. casserole, place 1/4 cup water.
Beets (fresh, whole)	1 bunch	18 to 22 min.	In 2-qt. casserole, place 1/2 cup water.
Broccoli (fresh cut)	1 bunch (1¼ to 1½ lbs.)	8 to 10 min.	In 2-qt. casserole, place 1/2 cup water.
(fresh spears)	1 bunch (1¼ to 1½ lbs.)	10 to 13 min.	In 2-qt. oblong glass baking dish, place 1/4 cup water. Rotate dish after half of time. (Turntable should be turned off.)
(frozen, chopped)	10-oz. package	5 to 7 min.	In 1-qt. casserole.
(frozen spears)	10-oz. package	5 to 7 min.	In 1-qt. casserole, place 3 tablespoons water.
Cabbage (fresh)	1 medium head (about 2 lbs.)	9 to 11 min.	In 1½- or 2-qt. casserole, place 1/4 cup water.
(wedges)		8 to 10 min.	In 2- or 3-qt. casserole, place 1/4 cup water.
Carrots (fresh, sliced)	1 lb.	7 to 9 min.	In 1½-qt. casserole, place 1/4 cup water.
(frozen)	10-oz. package	5 to 7 min.	In 1-qt. casserole, place 2 tablespoons water.
Cauliflower (flowerets)	1 medium head	10 to 14 min.	In 2-qt. casserole, place 1/2 cup water.
(fresh, whole)	1 medium head	10 to 17 min.	In 2-qt. casserole, place 1/2 cup water.
(frozen)	10-oz. package	5 to 7 min.	In 1-qt. casserole, place 2 tablespoons water.



Vegetable	Amount	Time	Comments
Corn (frozen kernel)	10-oz. package	5 to 7 min.	In 1-qt. casserole, place 2 tablespoons water.
Corn on the cob (fresh)	1 to 5 ears	3 to 4 min. per ear	In 2-qt. oblong glass baking dish, place corn. If corn is in husk, use no water; if corn has been husked, add 1/4 cup water. Rearrange after half of time. (Turntable should be turned off.)
(frozen)	1 ear 2 to 6 ears	5 to 6 min. 3 to 4 min. per ear	Place in 2-qt. oblong glass baking dish. Cover with vented plastic wrap. Rearrange after half of time. (Turntable should be turned off.)
Mixed vegetables (frozen)	10-oz. package	5 to 7 min.	In 1-qt. casserole, place 3 tablespoons water.
Peas (fresh, shelled)	2 lbs. unshelled	10 to 12 min.	In 1-qt. casserole, place 1/4 cup water.
(frozen)	10-oz. package	5 to 7 min.	In 1-qt. casserole, place 2 tablespoons water.
Potatoes (fresh, cubed, white)	4 potatoes (6 to 8 oz. each)	10 to 12 min.	Peel and cut into 1 inch cubes. Place in 2-qt. casserole with 1/2 cup water. Stir after half of time.
(fresh, whole, sweet or white)	1 (6 to 8 oz.)	3 to 4 min.	Pierce with cooking fork. Place in center of the oven. Let stand 5 minutes.
Spinach (fresh)	10 to 16 oz.	5 to 7 min.	In 2-qt. casserole, place washed spinach.
(frozen, chopped and leaf)	10-oz. package	5 to 7 min.	In 1-qt. casserole, place 3 tablespoons water.
Squash (fresh, summer and yellow)	1 lb. sliced	5 to 7 min.	In 1½-qt. casserole, place 1/4 cup water.
(winter, acorn butternut)	1 to 2 squash (about 1 lb. each)	8 to 11 min.	Cut in half and remove fibrous membranes. In 2-qt. oblong glass baking dish, place squash cut-side-down. Turn cut-side-up after 4 minutes. (Turntable should be turned off.)



Operating Instructions

Time Features

Time Defrost

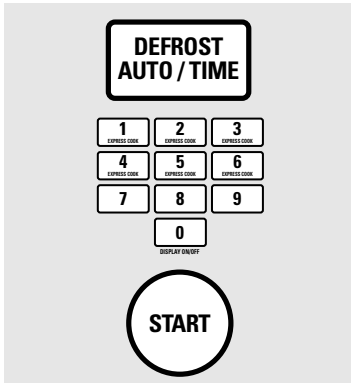

- 1 Press **DEFROST AUTO/TIME** twice.
 - 2 Enter defrosting time.
 - 3 Press **START**.
 - 4 Turn food over when the oven signals.
 - 5 Press **START**.
- (Auto Defrost explained in the Auto Feature section.)

Allows you to defrost for the length of time you select. See the Defrosting Guide for suggested times.

Power Level 3 is automatically set, but you may change this for more flexibility. You may defrost small items more quickly by raising the power level after entering the time. However, they will need more frequent attention than usual. Power Level 7 cuts the total defrosting time in about half; Power Level 10 cuts the total time to approximately 1/3. Rotate or stir food frequently.

At one half of selected defrosting time, the oven signals **TURN**. At this time, turn food over and break apart or rearrange pieces for more even defrosting. Shield any warm areas with small pieces of foil.

A dull thumping noise may be heard during defrosting. This sound is normal when the oven is not operating at High power.

Defrosting Tips

- Foods frozen in paper or plastic can be defrosted in the package. Tightly closed packages should be slit, pierced or vented **AFTER** food has partially defrosted. Plastic storage containers should be at least partially uncovered.
- Family-size, prepackaged frozen dinners can be defrosted and microwaved. If the food is in a foil container, transfer it to a microwave-safe dish.
- Foods that spoil easily, such as milk, eggs, fish, stuffings, poultry and pork, should not be allowed to sit out for more than one hour after defrosting. Room temperature promotes the growth of harmful bacteria.
- For more even defrosting of larger foods, such as beef, lamb and veal roasts, use Auto Defrost.
- Be sure large meats are completely defrosted before cooking.
- When defrosted, food should be cool but softened in all areas. If still slightly icy, return to the microwave very briefly, or let it stand a few minutes.

Defrosting Guide



Food	Time	Comments
Breads, Cakes Bread, buns or rolls (1 piece) Sweet Rolls (approx. 12 oz.)	1 min. 3 to 5 min.	
Fish and Seafood Fillet s, frozen (1 lb.) Shellfish , small pieces (1 lb.)	7 to 9 min. 5 to 7 min.	Place block in casserole. Turn over and break up after half the time.
Fruit Plastic pouch —1 to 2 (10-oz. package)	3 to 6 min.	
Meat Bacon (1 lb.) Franks (1 lb.) Ground meat (1 lb.) Roast : beef, lamb, veal, pork Steaks, chops and cutlets	3 to 5 min. 3 to 5 min. 5 to 7 min. 12 to 16 min. per lb. 6 to 8 min. per lb.	Place unopened package in oven. Let stand 5 minutes after defrosting. Place unopened package in oven. Microwave just until franks can be separated. Let stand 5 minutes, if necessary, to complete defrosting. Turn meat over after half the time. Use power level 1. Place unwrapped meat in cooking dish. Turn over after half the time and shield warm areas with foil. When finished, separate pieces and let stand to complete defrosting.
Poultry Chicken , broiler-fryer cut up (2½ to 3 lbs.) Chicken , whole (2½ to 3 lbs.) Cornish hen Turkey breast (4 to 6 lbs.)	16 to 20 min. 18 to 22 min. 8 to 14 min. per lb. 6 to 10 min. per lb.	Place wrapped chicken in dish. Unwrap and turn over after half the time. When finished, separate pieces and microwave 2 to 4 minutes more, if necessary. Let stand to finish defrosting. Place wrapped chicken in dish. After half the time, unwrap and turn chicken over. Shield warm areas with foil. Finish defrosting. If necessary, run cold water in the cavity until giblets can be removed. Place unwrapped hen in the oven breast-side-up. Turn over after half the time. Run cool water in the cavity until giblets can be removed. Place unwrapped breast in dish breast-side-down. After half the time, turn over and shield warm areas with foil. Finish defrosting. Let stand 1 to 2 hours in refrigerator to complete defrosting.



Operating Instructions

Time Features

Express Cook

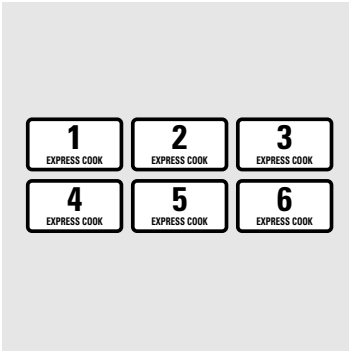

This is a quick way to set cooking time for 1–6 minutes.

Press one of the Express Cook pads (from 1 to 6) for 1 to 6 minutes of cooking at Power Level 10. For example, press the 2 pad for 2 minutes of cooking time.

The power level can be changed as time is counting down. Press **POWER LEVEL** and enter 1–10.

Add 30 Seconds

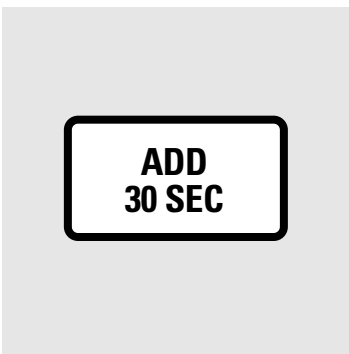

You can use this feature two ways:

- It will add 30 seconds to the time counting down each time the pad is pressed.
- It can be used as a quick way to set 30 seconds of cooking time.



Auto Defrost

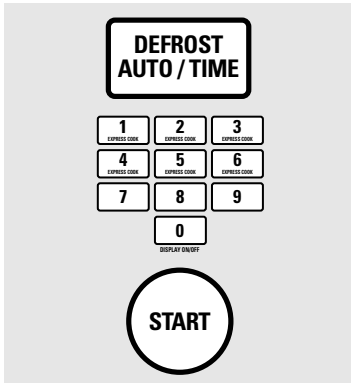

- 1 Press DEFROST AUTO/TIME once.**
- 2 Using the Conversion Guide at right, enter food weight. For example, press number pads 1 and 2 for weight of 1.2 pounds (1 pound, 3 ounces).**
- 3 Press START.**
(Time Defrost explained in the Time Features section.)

The Defrost Auto/Time feature gives you two ways to defrost frozen foods. Press DEFROST AUTO/TIME once for Auto Defrost or twice for Time Defrost.

Use Auto Defrost for meat, poultry and fish. Use Time Defrost for most other frozen foods.

Auto Defrost automatically sets the defrosting times and power levels to give even defrosting results for meats, poultry and fish.

There is a handy guide located on the inside front of the oven.

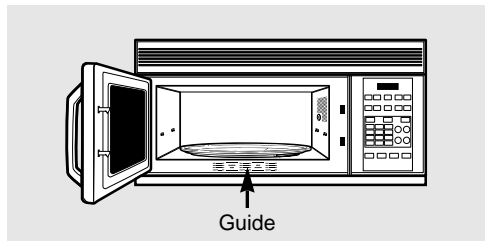

You will need to know the food weight before setting Auto Defrost.

If the weight of food is stated in pounds and ounces, the ounces must be converted to tenths (.1) of a pound.

Weight of Food in Ounces	Enter Food Weight (tenths of a pound)
1-2	.1
3	.2
4-5	.3
6-7	.4
8	.5
9-10	.6
11	.7
12-13	.8
14-15	.9

- Twice during defrost, the oven signals TURN. At each TURN signal, turn food over. Remove defrosted meat or shield warm areas with small pieces of foil.
- After defrosting, most meats need to stand 5 minutes to complete defrosting. Large roasts should stand for about 30 minutes.



Operating Instructions

Temperature Features

Temp Cook/Roast

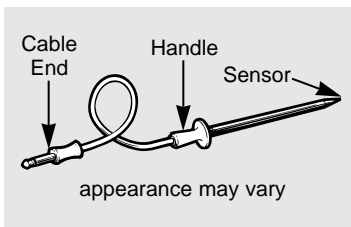
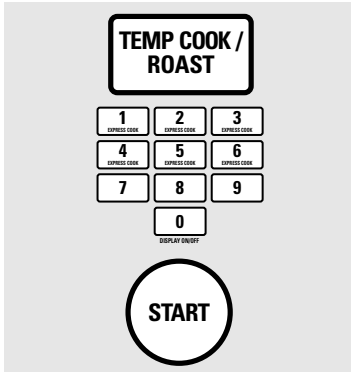

Cooking with the probe allows you to heat to a certain internal temperature. This is the best way to cook many foods.

Three Ways to Use the Temp Cook/Roast Feature

1 You set the temperature you want.

Press TEMP COOK/ROAST once. This is good for foods such as soups, casseroles, sandwiches and beverages.

2 Temperature is automatically selected for cooking roasts medium or well.

Roast Medium—Press TEMP COOK/ROAST twice.

Roast Well—Press TEMP COOK/ROAST three times.

See the Roasting Guide for suggestions.

3 Temperature is automatically selected for slow cooking of foods (simmer).

Simmer—Press TEMP COOK/ROAST 4 times. See the Simmer Guide for specific directions.

The Temperature Probe

NOTE: The turntable will not turn when the probe is in use.

The temperature probe is a food thermometer that gauges the internal temperature of food. The probe must be used when using Temp Cook or Roast.

The probe is not recommended for batters, doughs, frozen foods and foods which are difficult to cook precisely by temperature. Use the Micro Cook setting for these foods.

- Make sure the cable end is inserted all the way into the oven wall receptacle.
- Insert the probe into the center of the food. Make sure the handle does not touch the food or the top or sides of the oven.
- Do not leave the probe in the oven if it's not inserted in food. If it touches the oven wall, it may damage the oven.

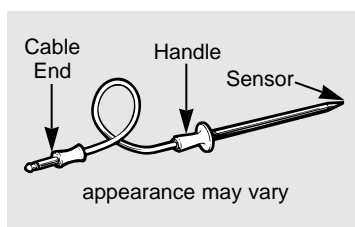
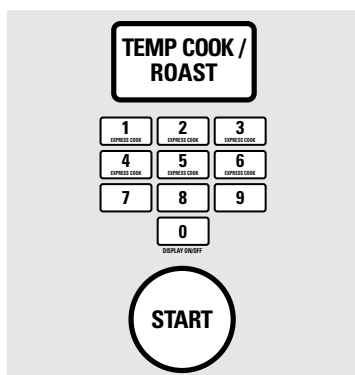

NOTE: The turntable will not turn when the probe is in use.

How to Use the Probe and Set the Temperature Yourself

- 1** Insert the temperature probe in the center of a casserole and attach it securely in the oven wall.
- 2** Press TEMP COOK/ROAST once.
- 3** Enter the desired food temperature.
- 4** Change power level if you don't want full power. (Press POWER LEVEL. Select a power level 1-10.)
- 5** Press START.
- 6** When the temperature is reached, the microwave will signal. Food will be held at this temperature for 60 minutes. The oven beeps when the hold time is complete.

Cooking Tips

- Do not twist, drop or bend the probe.
- Use a lower power level with the probe; foods will take longer to cook but they will heat more evenly.
- Be sure frozen food has been completely defrosted before inserting the probe. The probe may break off if used in frozen foods.
- Cover foods loosely for moisture control and quick, even heating.
- Just as in regular roasting, only tender roasts should be roasted by using the probe. Less tender roasts should be microwaved by time.



Operating Instructions

Temperature Features

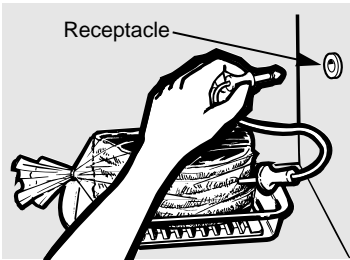

1 Insert the probe in the roast and attach it securely in the oven wall.

2 For medium doneness, press TEMP COOK/ROAST twice.

For a well-done roast, press TEMP COOK/ROAST three times.

3 Press START.

4 The microwave signals when it's time to turn the roast over. After you turn the roast, close the door and press START.

NOTE: The oven continues to cook after the signal whether or not roast is turned over.

How to Use the Probe with the Roast Settings

For the two Roast settings, the probe temperature is preprogrammed.

The microwave signals when the temperature is reached.

Food will be held at this temperature for 60 minutes. The oven beeps when hold time is complete.

Preparing Meats for Roasting

• Place a tender beef roast in a cooking bag on a trivet in a microwave-safe dish. (Refer to package instructions for proper use of the cooking bag.)

• Insert the probe through the cooking bag horizontally into the center meaty area not touching bone or fat. Make sure the handle does not touch the food or top or sides of the oven.

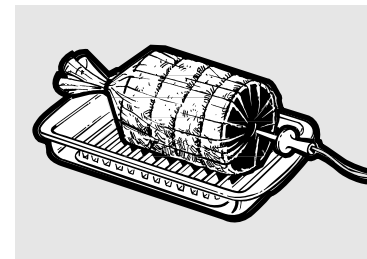

• When using the probe in chicken, turkey or other poultry, insert the probe horizontally into the meatiest area.

Roasting Guide

Food Type	Doneness Selection	Approx. Time (minutes per pound)
Beef (5 lb. max.) Tender Roast	Medium	15-23
	Well	23-30
Pork (5 lb. max.) Loin Roast	Well	23-30
Poultry (6 lb. max.) Turkey Breast	Well	16-19



How to Use the Probe to Simmer

The Simmer feature heats food to 180°F. and holds it at that temperature up to 12 hours or until you remove it and press CLEAR/OFF.

1 Insert the temperature probe into the food, resting it on the side of the dish. Attach it securely in the oven wall.

2 Press TEMP COOK/ROAST **4 times** to select Simmer.

3 Press START. If you need to stir the food, restart the oven by pressing START again.

When the simmer temperature is reached, the oven holds the food at that temperature until CLEAR/OFF is pressed.

Simmer Guide

Food Type	Hours*	Comments
Beef		
Pot Roast	5-7	Add enough liquid to just cover meat. If adding vegetables, make sure they are completely covered by liquid.
Chili	5-8	Precook meat. Stir after 3 hours, if possible.
Chicken		
Stewing	4-6	Add 4 cups liquid. Insert probe into meatiest area of thigh from below end and parallel to leg. Turn over after 1/2 of time.
Broiler/Fryer	3-4	Same as above.
Ham/Pork		
Roast	4-6	Add 4 cups liquid.
Soup		
Stock/Vegetable	7-10	Make sure that vegetables and meat are covered by liquid. Stir every 3 hours.
Split Pea	5-7	Add enough liquid to cover peas at least 2 inches. Stir after 3 hours.

**Total time includes time to bring food to 180°F. and hold at that temperature until done.*



Operating Instructions

Sensor Features

Sensor Controls

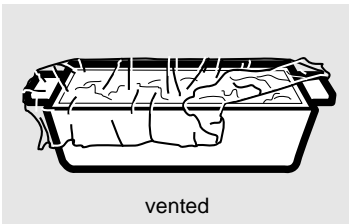
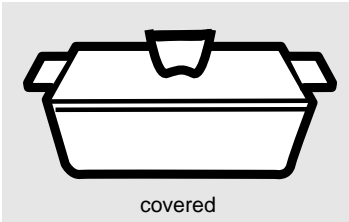

- The Auto/Sensor Controls use a gas/humidity sensor that detects the increasing humidity created during the heating process. By using this process, the oven automatically adjusts the heating or cooking time to various types and amounts of food.
- The proper containers and covering are essential for best Auto/Sensor cooking.
- Always use microwave safe containers and cover them with lids or vented plastic wrap. Never use tight sealing plastic containers—they can prevent steam from escaping and cause food to overcook.
- Be sure the outside of the cooking containers and the inside of the microwave oven are dry before placing food in the oven. Beads of moisture turning into steam can mislead the sensor.



Popcorn

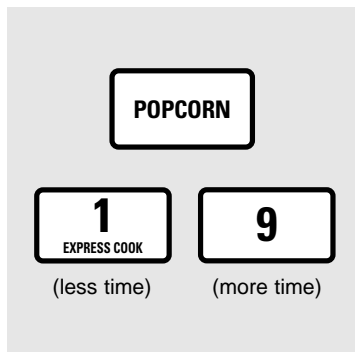

NOTE: Do not use the metal shelf when cooking popcorn.

Use only with prepackaged microwave popcorn weighing 1.75 to 3.5 ounces.

- 1 Follow package instructions.
- 2 Place the package of popcorn in the center of the microwave.
- 3 Press POPCORN. The oven starts immediately.

If you open the door while “POPCORN” is displayed, “SENSOR ERROR” will appear. Close the door, press CLEAR/OFF and begin again.

How to Adjust the Popcorn Program to Provide a Shorter or Longer Cook Time

If you find that the brand of popcorn you use underpops or overcooks consistently, you can add or subtract 20–30 seconds to the automatic popping time.

To add time:

After pressing POPCORN, press **9** immediately after the oven starts for an extra 20 seconds.

Press **9** again to add another 10 seconds (total 30 seconds additional time).

To subtract time:

After pressing POPCORN, press **1** immediately after the oven starts for 20 seconds less cooking time.

Press **1** again to reduce cooking time another 10 seconds (total 30 seconds less time).

Beverage



Press BEVERAGE to heat a cup of coffee or other beverage.

Beverages heated with the Beverage feature may be very hot. Remove the container with care.



Sensor Features

Reheat



REHEAT

For reheating single servings of previously cooked foods or a plate of leftovers.

- 1 Place covered food in the oven. Press REHEAT. The oven starts immediately.
- 2 The oven signals when steam is sensed and the time remaining begins counting down.

Do not open the oven door until time is counting down. If the door is opened, close it and press START immediately.

After removing food from the oven, stir, if possible, to even out the temperature. If food is not hot enough, use Micro Cook to reheat for more time. Reheated foods may have wide variations in temperature. Some areas may be extremely hot.

Some Foods Not Recommended For Use With Reheat

It is best to use Micro Cook for these foods:

- Bread products.
- Foods that must be reheated uncovered.
- Foods that need to be stirred or rotated.
- Foods calling for a dry look or crisp surface after reheating.



Sensor Cooking

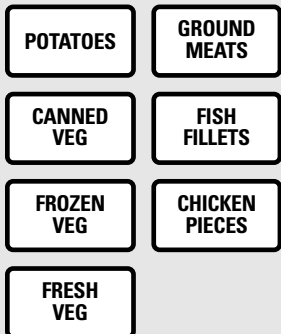

NOTE: Do not use the metal shelf with Sensor Cooking.

Canned Vegetables, Frozen Vegetables, Fresh Vegetables, Potatoes, Fish Fillets, Chicken Pieces, Ground Meats

The Sensor Cooking pads give you easy, automatic results with a variety of foods. (See the Cooking Guide below.)

1 Place covered food in the oven. Press the food pad. The oven starts immediately.

2 The oven signals when steam is sensed and time remaining is counting down. Turn or stir the food if necessary.

Do not open the oven door until time is counting down. If the door is opened, close it and press START immediately.

NOTE: If the food is not done enough, use Micro Cook to cook for more time.

Cooking Guide

Food	Amount	Comments
Canned Vegetables	4–16 oz.	Cover with lid or vented plastic wrap.
Frozen Vegetables	4–16 oz.	Follow package instructions for adding water. Cover with lid or vented plastic wrap.
Fresh Vegetables	4–16 oz.	Add 1/4 cup water per serving. Cover with lid or vented plastic wrap.
Potatoes	1/2–2 lbs.	Pierce skin with fork. Arrange in a star pattern in the center of the microwave.
Fish Fillets	4–16 oz.	Cover with vented plastic wrap.
Chicken Pieces	1–8 pieces	Cover with vented plastic wrap.
Ground Meats (Beef, Pork, Turkey)	1/2–3 lbs.	Use round casserole dish. Crumble meat into dish. Do not cover the dish. Drain and stir at signal.

How to Change the Automatic Settings

You can adjust the cooking time for all foods, except for CANNED VEG, to suit your personal taste.

Reduce time by 10%: Press  after the food pad.

Add 10% to cooking time: Press  after the food pad.



Operating Instructions

Other Features Your Model Has

Help



The HELP pad displays feature information and helpful hints. Press HELP, then select a feature pad.

Cooking Complete Reminder

To remind you that you have food in the oven, the oven will display “FOOD IS READY” and beep once a minute until you either open the oven door or press CLEAR/OFF.

Clock

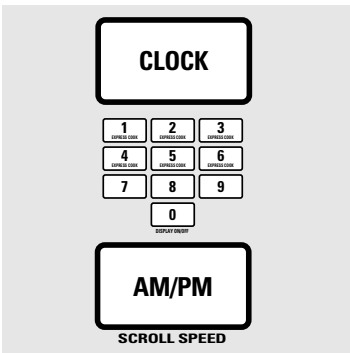

Press to enter the time of day or to check the time of day while microwaving.

- 1 Press CLOCK.
- 2 Enter time of day.
- 3 Select AM/PM.
- 4 Press START.

Scroll Speed

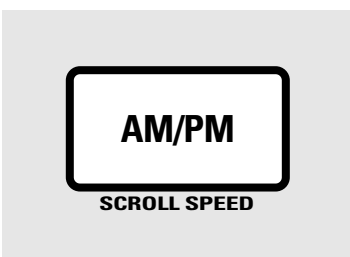

The scroll speed of the display can be changed. Press and hold the AM/PM pad about 3 seconds to bring up the display. Select 1–5 for slow to fast scroll speed.



Display On/Off

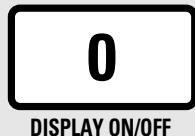

To turn the clock display off, press and hold **0** for about three seconds.

To redisplay the clock, repeat the above.

Delay Start

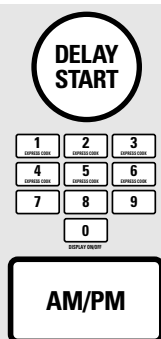

Delay Start allows you to set the microwave to delay cooking up to 24 hours.

- 1 Press DELAY START.
- 2 Enter the time you want the oven to start. (Be sure the microwave clock shows the correct time of day.)

3 Select Defrost Auto/Time, Micro Cook I & II or Temp Cook.

4 Press START.

The Delay Start time will be displayed plus “DS.” The oven will automatically start at the delayed time.

The time of day may be displayed by pressing CLOCK.

Timer On/Off



The Timer On/Off operates as a minute timer and can be used at any time, even when the oven is operating.

- 1 Press TIMER ON/OFF.
- 2 Enter time you want to count down.
- 3 Press TIMER ON/OFF to start.

When time is up, the oven will signal. To turn off the Timer signal, press TIMER ON/OFF.

NOTE: The Timer indicator will be lit while Timer On/Off is operating.

Reminder



The Reminder feature can be used like an alarm clock and can be used at any time, even when the oven is operating. The reminder time can be set up to 24 hours later.

- 1 Press REMINDER.
- 2 Enter the time you want the oven to remind you. (Be sure the microwave clock shows the correct time of day.)

3 Select AM or PM.

4 Press REMINDER. To turn off the reminder signal, press REMINDER again. The Reminder time may be displayed by pressing REMINDER.

NOTE: The REM indicator will remain lit to show that the REMINDER is set.



Operating Instructions

Other Features Your Model Has

Start/Pause



In addition to starting many functions, START/PAUSE allows you to stop cooking without opening the door or clearing the display.

Child Lock-Out



You may lock the control panel to prevent the microwave from being accidentally started or used by children.

To lock or unlock the controls, press and hold CLEAR/OFF for about three seconds. When the control panel is locked, an “L” will be displayed to the extreme right.

Turntable



For best cooking results, leave the turntable on. It can be turned off for large dishes. Press TURNTABLE to turn the turntable on or off.

Sometimes the turntable can become too hot to touch. Be careful touching the turntable during and after cooking.

Vent Fan



The Vent Fan removes steam and other vapors from surface cooking.

Press VENT FAN once for High fan speed, twice for Low fan speed or a third time to turn the fan off.



Automatic Fan

An automatic fan feature protects the microwave from too much heat rising from the cooktop below it. It automatically turns on at low speed if it senses too much heat.

If you have turned the fan on you may find that you cannot turn it off. The fan will automatically turn off when the internal parts are cool. It may stay on for 30 minutes or more after the cooktop and microwave controls are turned off.

Surface Light



Press SURFACE LIGHT **once** for bright light, **twice** for the night light or **three** times to turn the light off.

Sound Level

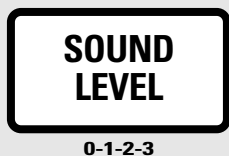

The beeper sound level can be adjusted up, down or off. Press SOUND LEVEL. Choose 0–3 for mute to loud.

Auto Nite Light



You can set the night light to turn on and off automatically at any time you want.

- 1 Press AUTO NITE LIGHT.
- 2 Enter the time you want the light to turn on. Select AM or PM.
- 3 Press AUTO NITE LIGHT again and enter the time you want the light to turn off. Select AM or PM.

4 Press AUTO NITE LIGHT. NITE will stay lit to remind you that the feature is set. You can review the auto nite light settings by pressing AUTO NITE LIGHT. To erase your settings and turn off the automatic feature, press AUTO NITE LIGHT, then 0. The NITE indicator will no longer be lit.

Helpful Information

Use of the Oven Shelf

Two-Position Shelf

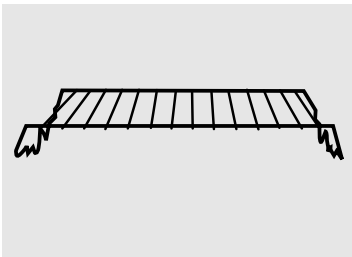

Food microwaves best when placed on the turntable or on the shelf in the lower position.

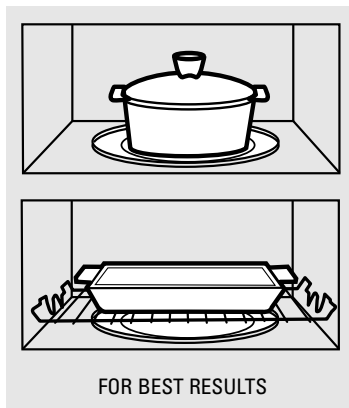

For best cooking results, remove the shelf unless you are cooking on two levels.



- Make sure the shelf is positioned properly inside the microwave to prevent damage to the oven from arcing.
- Do not use a microwave browning dish on the shelf. The shelf could overheat.
- Do not cook with the shelf on the microwave floor. This could damage the microwave.
- Use pot holders when handling the shelf—it may be hot.
- Do not use the shelf when cooking popcorn.
- Do not use the shelf with Sensor Cooking or Reheat.

Ideas for Using the Shelf

The lower position provides a flat surface for placing dishes that may tilt if placed on the turntable.

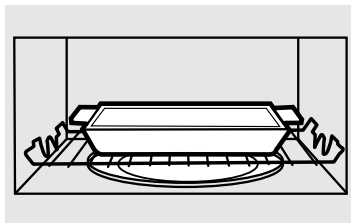

The upper position gives you the option to reheat or cook more than one dish of food at the same time.

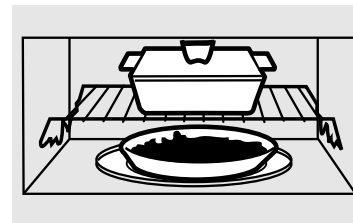

The lower position also allows you to place 2 dishes side-by-side. This is helpful for casseroles or other cookware that may be too tall to cook on 2 levels.

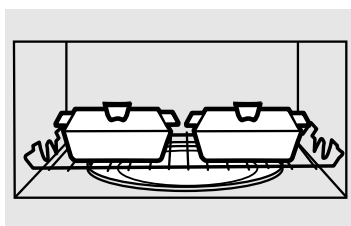

Cooking and Reheating

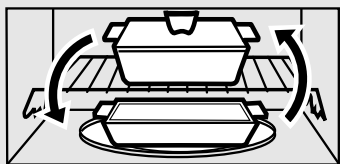

Switch places after 1/2 time.

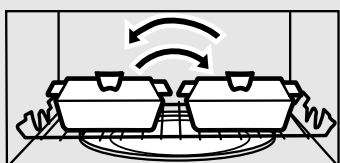

Switch places after 1/2 time.

- To cook on 2 levels

or

- To cook 2 dishes on the lower level:

- 1 Double the cooking time.
- 2 Switch places after 1/2 the time and give dishes 1/2 turn. (Place dense foods, or those that require a longer cook time, on the shelf first.)

- To reheat on 2 levels

or

- To reheat 2 dishes on the lower level:

- 1 Multiply reheat time by 1½.
- 2 Switch places after 1/2 the time.



Microwave Terms

Microwave Terms

Term	Definition
Arcing	Arcing is the microwave term for sparks in the oven. Arcing is caused by: <ul style="list-style-type: none">• the temperature probe staying in the oven but not inserted in the food.• the metal shelf being installed incorrectly and touching the microwave walls.• metal or foil touching the side of the oven.• foil that is not molded to food (upturned edges act like antennas).• metal such as twist ties, poultry pins, gold-rimmed dishes.• recycled paper towels containing small metal pieces.
Covering	Covers hold in moisture, allow for more even heating and reduce cooking time. Venting plastic wrap or covering with wax paper allows excess steam to escape.
Shielding	In a regular oven, you shield chicken breasts or baked foods to prevent over-browning. When microwaving, you use small strips of foil to shield thin parts, such as the tips of wings and legs on poultry, which would cook before larger parts.
Standing Time	When you cook with regular ovens, foods such as roasts or cakes are allowed to stand to finish cooking or to set. Standing time is especially important in microwave cooking. Note that a microwaved cake is not placed on a cooling rack.
Venting	After covering a dish with plastic wrap, you vent the plastic wrap by turning back one corner so excess steam can escape.

Helpful Hints



Opening the oven door a few minutes after cooking helps air out the inside. An occasional thorough wiping with a solution of baking soda and water keeps the inside fresh.

BE CERTAIN POWER IS OFF BEFORE CLEANING ANY PART OF THIS OVEN.

How to Clean the Inside

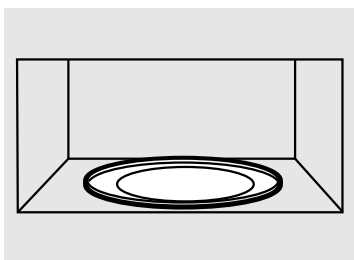

Walls, Floor, Inside Window, Metal and Plastic Parts on the Door. Some spatters can be removed with a paper towel, others may require a damp cloth. Remove greasy spatters with a sudsy cloth, then rinse with a damp cloth. Do not use abrasive cleaners or sharp utensils on oven walls. **Never use a commercial oven cleaner on any part of your microwave.**

Removable Turntable and Turntable Support. To prevent breakage, do not place the turntable into water just after cooking. Wash it carefully in warm, sudsy water or in the dishwasher. The turntable and support can be broken if dropped. Remember, do not operate the oven without the turntable and support in place.

Temperature Probe. Clean immediately after using. To clean, wipe with sudsy cloth, then rub lightly with plastic scouring ball if necessary. Rinse and dry. The probe can also be washed in the dishwasher.

Shelf. Clean with mild soap and water or in the dishwasher. **Do not clean in a self-cleaning oven.**



Helpful Information

Care and Cleaning

How to Clean the Outside

Do not use cleaners containing ammonia or alcohol on the microwave oven.

Ammonia or alcohol can damage the appearance of the microwave.

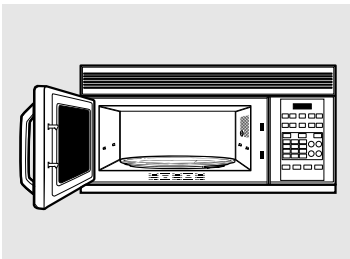

Case. Clean the outside of the microwave with a sudsy cloth. Rinse and then dry. Wipe the window clean with a damp cloth.

Control Panel and Door. Wipe with a damp cloth. Dry thoroughly. Do not use cleaning sprays, large amounts of soap and water, abrasives or sharp objects on the panel—they can damage it. Some paper towels can also scratch the control panel.

Door Surface. It's important to keep the area clean where the door seals against the microwave. Use only mild, non-abrasive detergents applied with a clean sponge or soft cloth. Rinse well.

Bottom. Clean off the grease and dust on the bottom often. Use a solution of warm water and detergent.

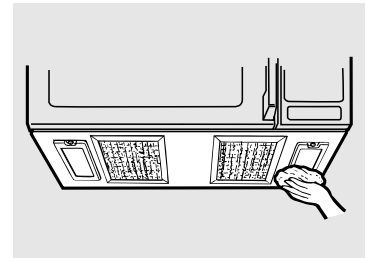

Light Bulb Replacement



Cooktop Light/ Night Light

To replace the bulb(s), first disconnect the power at the main fuse or circuit breaker panel or pull the plug.

Remove the screw at the front of the light cover and lower the cover.

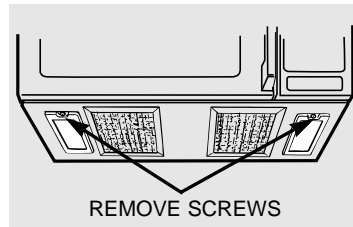

Be sure the bulb(s) to be replaced are cool before removing. After breaking the adhesive seal, remove the bulb by gently turning.

Replace with 40-watt tubular bulbs. Order WB36X936 from your GE supplier. Tubular 40-watt bulbs (40T6 $\frac{1}{2}$ /2), available in supermarkets and hardware stores, may also be used for replacements.

Replace the screw. Connect electrical power to the oven.

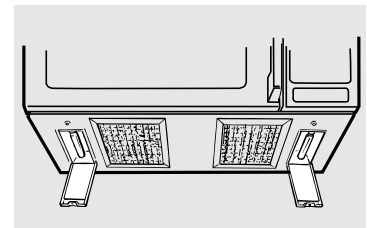

Oven Light

To replace the oven light, first disconnect the power at the main fuse or circuit breaker panel or pull the plug.



Remove the top grille by taking out the 2 screws that hold it in place.

Next, remove the two screws located above the door near the center of the oven that secure the light housing.

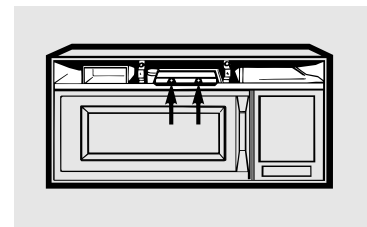

Replace the burned-out bulb with a 30-watt incandescent bulb (WB02X4235), available from your GE supplier.



Helpful Information

The Exhaust Feature

The Vent Fan

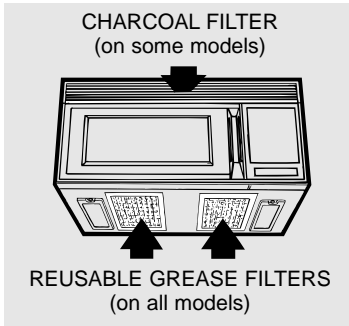

The vent fan has 2 metal reusable grease filters.

Models that recirculate air back into the room also use a charcoal filter.

Reusable Grease Filters

The metal filters trap grease released by foods on the cooktop. They also prevent flames from foods on the cooktop from damaging the inside of the microwave.

For this reason, the filters must **ALWAYS** be in place when the hood is used. The grease filters should be cleaned once a month, or as needed.

To Remove Grease Filter

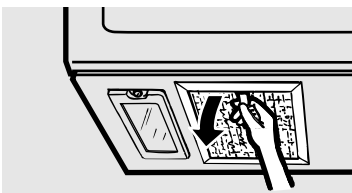

To remove, slide it to the rear using the tab. Pull it down and out.

To Clean and Replace Grease Filter

To clean the grease filter, soak it and then swish it around in hot water and detergent. Don't use ammonia or ammonia products because they will darken the metal. Light brushing can be used to remove embedded dirt.

Rinse, shake and let it dry before replacing.

To replace, slide the filter in the frame slot on the back of the opening.

Pull up and to the front to lock into place.

Charcoal Filter (on some models)

Charcoal filters cannot be cleaned. They must be replaced.

If the model is not vented to the outside, the air will be recirculated through a disposable charcoal filter that helps remove smoke and odors.

The charcoal filter should be replaced when it is noticeably dirty or discolored (usually after 6 to 12 months, depending on hood usage).

Order Part No. WB02X9883 from your GE supplier.

To Remove Charcoal Filter

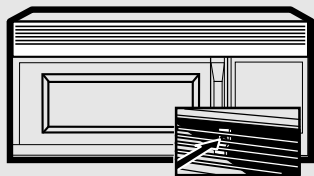

Remove 2 grille screws to remove the grille.

To remove the charcoal filter, disconnect power at the main fuse or circuit breaker panel or pull the plug.

Remove the top grille by removing the 2 screws that hold it in place. Slide the filter towards the front of the oven and remove it.

To Install Charcoal Filter

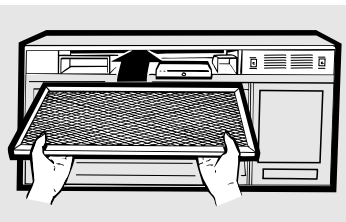

To install a new filter, remove plastic and other outer wrapping from the new filter.

Insert the filter into the top opening of the oven as shown. It will rest at an angle on 2 side support tabs and in front of the right rear tab. Replace the grille and 2 screws.



If Something Goes Wrong

Before You Call for Service

Problem	Possible Causes	What to Do
Oven Will Not Come On	A fuse in your home may be blown or the circuit breaker tripped.	<ul style="list-style-type: none">• Replace fuse or reset circuit breaker.
	Power surge.	<ul style="list-style-type: none">• Unplug the microwave oven, then plug it back in.
	Plug not fully inserted into wall outlet.	<ul style="list-style-type: none">• Make sure the 3-prong plug on the oven is fully inserted into wall outlet.
"PLEASE INSERT PROBE" Appears on Display	Probe has been forgotten or not inserted properly in the oven wall when using the Temp Cook or Roast function.	<ul style="list-style-type: none">• Insert the probe properly into the wall receptacle.
"SENSOR ERROR" Appears on Display	During Sensor Cooking, Reheat, or Popcorn program, the door was opened before steam could be detected.	<ul style="list-style-type: none">• Do not open door until steam is sensed and time is shown counting down on display.
	Steam was not detected in maximum amount of time.	<ul style="list-style-type: none">• Use Micro Cook to heat for more time.
Floor of Oven is Warm, Even When the Oven Has Not Been Used	The cooktop light is located below the oven floor. When the light is on, the heat it produces may make the oven floor get warm.	<ul style="list-style-type: none">• This is normal.
"BAD PROBE" Appears on Display	The probe has not been completely inserted into the wall receptacle.	<ul style="list-style-type: none">• Insert the probe properly into the wall receptacle.
	The probe is defective.	<ul style="list-style-type: none">• Replace the probe.



Problem	Possible Causes	What to Do
Food Amount Too Large for Sensor Reheat	Sensor Reheat is for single servings of recommended foods.	<ul style="list-style-type: none">• Use Micro Cook for large amounts of food.
You Hear an Unusual, Low-Tone Beep	You have tried to start the REMINDER without a valid time of day.	<ul style="list-style-type: none">• Start over and enter a valid time of day.
	You have tried to start the AUTO NITE LIGHT without a valid time of day entered for the on-time and off-time.	<ul style="list-style-type: none">• Start over and enter a valid time of day.
	You have tried to turn the turntable on when the probe is in use.	<ul style="list-style-type: none">• The turntable will not operate when the probe is in use.
	You have tried to change the power level when it is not allowed.	<ul style="list-style-type: none">• Many of the oven's features are preset and cannot be changed.
"LOCKED" Appears on Display	The control has been locked. (When the control panel is locked, an "L" will be displayed.)	<ul style="list-style-type: none">• Press and hold CLEAR/OFF for about 3 seconds to unlock the control.

All These Things Are Normal With Your Microwave Oven

- Steam or vapor escaping from around the door.
- Light reflection around door or outer case.
- Dimming oven light and change in blower sound may occur while operating at power levels other than high.
- Dull thumping sound while oven is operating.
- Some TV-radio interference might be noticed while using your microwave oven. It's similar to the interference caused by other small appliances and does not indicate a problem with your microwave. If you notice this interference, check that the microwave oven is on a different electrical circuit, relocate the radio or TV as far away from the microwave as possible, or check the position and signal of the receiving antenna.

GE Service Numbers



We'll be there!

GE Answer Center®

800.626.2000

Whatever your question about any GE major appliance, GE Answer Center® information service is available to help. Your call—and your question—will be answered promptly and courteously.

And you can call any time. GE Answer Center® service is open 24 hours a day, 7 days a week.

In-Home Repair Service

**800-GE-CARES
(800-432-2737)**

A GE consumer service professional will provide expert repair service, scheduled at a time that's convenient for you. Many GE Consumer Service company-operated locations offer you service today or tomorrow, or at your convenience (7:00 a.m. to 7:00 p.m. weekdays, 9:00 a.m. to 2:00 p.m. Saturdays).

Our factory-trained technicians know your appliance inside and out—so most repairs can be handled in just one visit.

For Customers With Special Needs

800.626.2000

Upon request, GE will provide Braille controls for a variety of GE appliances, and a brochure to assist in planning a barrier-free kitchen for persons with limited mobility. To obtain these items, free of charge, call 800.626.2000.

Consumers with impaired hearing or speech who have access to a TDD or a conventional teletypewriter may call 800-TDD-GEAC (800-833-4322) to request information or service.



Para los clientes de habla española

800.626.2000

Para obtener instrucciones en español, llame a GE Answer Center[®], servicio de información para el consumidor, teléfono 800.626.2000.

Service Contracts

800-626-2224

You can have the secure feeling that GE Consumer Service will still be there after your warranty expires.

Purchase a GE contract while your warranty is still in effect and you'll receive a substantial discount. With a multiple-year contract, you're assured of future service at today's prices.

Parts and Accessories

800-626-2002

Individuals qualified to service their own appliances can have parts or accessories sent directly to their home. The GE parts system provides access to over 47,000 parts...and all GE Genuine Renewal Parts are fully warranted. VISA, MasterCard and Discover cards are accepted.

Care and cleaning instructions contained in this manual cover procedures to be performed by any user. Other servicing generally should be referred to qualified service personnel. Caution must be exercised, since improper servicing may cause unsafe operation.

Further Service

We're proud of our service and want you to be pleased. If for some reason you are not happy with the service you receive, here are three steps to follow for further help.

First, contact the people who serviced your appliance. Explain why you are not pleased. In most cases, this will solve the problem.

Next, if you are still not pleased, write all the details—including your phone number—to:

Manager, Consumer Relations
GE Appliances, Appliance Park
Louisville, KY 40225

Finally, if your problem is still not resolved, write:

Major Appliance Consumer
Action Program
20 North Wacker Drive
Chicago, IL 60606

MICROWAVE OVEN WARRANTY

Staple sales slip or cancelled check here. Proof of original purchase date is needed to obtain service under warranty.

What is Covered

FULL ONE-YEAR WARRANTY

For one year from date of original purchase, we will provide, free of charge, parts and service labor in your home to repair or replace *any part of the microwave oven* that fails because of a manufacturing defect.

LIMITED ADDITIONAL NINE-YEAR WARRANTY

For the second through the tenth year from the date of original purchase, we will provide, free of charge, a replacement *magnetron tube* if the magnetron tube fails because of a manufacturing defect. You pay for the service trip to your home and service labor charges.

This warranty is extended to the original purchaser and any succeeding owner for products purchased for ordinary home use in the 48 mainland states, Hawaii and Washington, D.C. In Alaska the warranty is the same except that it is LIMITED because you must pay to ship the product to the service shop or for the service technician's travel costs to your home.

All warranty service will be provided by our Factory Service Centers or by our authorized Customer Care[®] servicers during normal working hours.

Should your appliance need service, during warranty period or beyond, call 800-GE-CARES (800-432-2737).

What is Not Covered

- Service trips to your home to teach you how to use the product.

Read your Owner's Manual. If you then have any questions about operating the product, please contact your dealer or our Consumer Affairs office at the address below, or call, toll free:

GE Answer Center[®]
800.626.2000
consumer information service

- Improper installation.

If you have an installation problem, contact your dealer or installer. You are responsible for providing adequate electrical, exhausting and other connecting facilities.

- Replacement of house fuses or resetting of circuit breakers.
- Failure of the product if it is misused, or used for other than the intended purpose or used commercially.
- Damage to product caused by accident, fire, floods or acts of God.

WARRANTOR IS NOT RESPONSIBLE FOR CONSEQUENTIAL DAMAGES.

Some states do not allow the exclusion or limitation of incidental or consequential damages, so the above limitation or exclusion may not apply to you. This warranty gives you specific legal rights, and you may also have other rights which vary from state to state. To know what your legal rights are in your state, consult your local or state consumer affairs office or your state's Attorney General.

Warrantor: General Electric Company If further help is needed concerning this warranty, write:
Manager—Consumer Affairs, GE Appliances, Louisville, KY 40225

Part No. 164D2966P212
Pub. No. 49-8697

1-96 CG

Printed in Korea

JVM1350

Free Manuals Download Website

<http://myh66.com>

<http://usermanuals.us>

<http://www.somanuals.com>

<http://www.4manuals.cc>

<http://www.manual-lib.com>

<http://www.404manual.com>

<http://www.luxmanual.com>

<http://aubethermostatmanual.com>

Golf course search by state

<http://golfingnear.com>

Email search by domain

<http://emailbydomain.com>

Auto manuals search

<http://auto.somanuals.com>

TV manuals search

<http://tv.somanuals.com>