



# Use & Care Guide

## Countertop Microwave Oven

### Contents

Adapter Plugs	32	Hold Time	8
Add 30 Seconds	10	Installation	32
Appliance Registration	2	Light Bulb Replacement	33
Auto Cook	19,20	Microwaving Tips	3
Auto Defrost	14, 15	Minute/Second Timer	8
Auto Reheat	17,18	Model and Serial Numbers	2, 6
Auto Roast	12, 13	Popcorn	11
Auto Simmer	13	Power Levels	8-13, 16
Auto Start	16	Precautions	2-5
Automatic Cooking Guide	5, 19-20	Problem Solver	34
Care and Cleaning	33	Program Cooking	5
Consumer Services	35	Recipes, Cooking Tips	22-29
Control Panel	7	Safety Instructions	2-5
Cooking by Time	10	Temperature Cook	16
Cooking Complete Reminder	6	Temperature Probe	4, 6, 12, 113, 16, 33
Cookware	21	Warranty	Back Cover
Defrosting by Time	9		
Delayed Cooking	8		
Double Duty Shelf	4, 5, 6, 30, 31, 33		
Extension Cords	32		
Features	6	<b>GE Answer Center<sup>®</sup></b>	
Grounding Instructions	32	<b>800.626.2000</b>	

### Model JE1468K

**Microwave power output  
of this oven is 800 watts.**

IEC-705 Test Procedure

GE Appliances

---

## Help us help you...

### Before using your oven, read this book carefully.

It is intended to help you operate and maintain your new microwave oven properly.

Keep it handy for answers to your questions.

If you don't understand something or need more help, write (include your phone number):

Consumer Affairs  
GE Appliances  
Appliance Park  
Louisville, KY 40225

### Write down the model and serial numbers.

You'll find them on a label inside the oven.

These numbers are also on the Consumer Product Ownership Registration Card that came with your microwave oven. Before sending in this card, please write these numbers here:

---

Model Number

---

Serial Number

Use these numbers in any correspondence or service calls concerning your microwave oven.

### Be sure your microwave oven is registered.

It is important that we know the location of your microwave oven should a need occur for adjustments.

Your supplier is responsible for registering you as the owner.

Please check with your supplier to be sure he has done so; also send in your Consumer Product Ownership Registration Card. If you move, or if you are not the original purchaser, please write to us, stating model and serial numbers.

### This appliance must be registered. Please be certain that it is.

Write to:

GE Appliances  
Range Product Service  
Appliance Park  
Louisville, KY 40225

### If you received a damaged oven...

Immediately contact the dealer (or builder) that sold you the oven.

### Save time and money. Before you request service...

Check the Problem Solver in the back of this book. It lists causes of minor operating problems that you can correct yourself.

### All these things are normal with your microwave oven.

- Steam or vapor escaping from around the door.
- Light reflection around door or outer case.
- Dimming oven light and change in blower sound may occur while operating at power levels other than high.
- Dull thumping sound while oven is operating.
- Some TV-Radio interference might be noticed while using your microwave oven. It's similar to the interference caused by other small appliances and does not indicate a problem with your oven.

### If you need service...

To obtain service, see the Consumer Services page in the back of this book.

We're proud of our service and want you to be pleased. If for some reason you are not happy with the service you receive, here are three steps to follow for further help.

FIRST, contact the people who serviced your appliance. Explain why you are not pleased. In most cases, this will solve the problem.

NEXT, if you are still not pleased, write all the details—including your phone number-to:

Manager, Consumer Relations  
GE Appliances  
Appliance Park  
Louisville, KY 40225

FINALLY, if your problem is still not resolved, write:

Major Appliance Consumer  
Action Panel  
20 North Wacker Drive  
Chicago, IL 60606

## PRECAUTIONS TO AVOID POSSIBLE EXPOSURE TO EXCESSIVE MICROWAVE ENERGY

(a) **Do Not Attempt** to operate this oven with the door open since open-door operation can result in harmful exposure to microwave energy. It is important not to defeat or tamper with the safety interlocks.

(b) **Do Not Place** any object between the oven front face and the door or allow soil or cleaner residue to accumulate on sealing surfaces.

(c) **Do Not Operate** the oven if it is damaged. It is particularly important that the oven door close properly and that there is no damage to the:

- (1) door (bent)
- (2) hinges and latches (broken or loosened)
- (3) door seals and sealing surfaces.

(d) **The Oven Should Not** be adjusted or repaired by anyone except properly qualified service personnel.

## Microwaving Tips

• **Make sure all cookware used in your microwave oven is suitable for microwaving.** Most glass casseroles, cooking dishes, measuring cups, custard cups, pottery or china dinnerware which does not have metallic trim or glaze with a metal lichen can be used. Some cookware is labeled "suitable for microwaving."

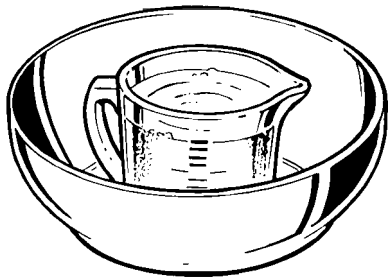

**If you are not sure if a dish is microwave-safe, use this test:** Place in the oven both the dish you are testing and a glass measuring cup filled with one cup water—set the measuring cup either in or next to the dish. Microwave 1 minute at high. If the dish heats, it should not be used for microwaving. If the dish remains cool and only the water in the cup heats, then the dish is microwave-safe.

• **Paper towels, waxed paper and plastic wrap** can be used to cover dishes in order to retain moisture and prevent spattering. Be sure to vent plastic wrap so steam can escape.

• **Some microwaved foods require stirring, rotating or rearranging.** Check cookbook supplied.

• **Steam builds up pressure in foods which are tightly covered by a skin or membrane.** Pierce potatoes, egg yolks and chicken livers to prevent bursting.

## IMPORTANT SAFETY INSTRUCTIONS

**Read all instructions before using this appliance.**

When using electrical appliances, basic safety precautions should be followed, including the following:

**WARNING—TO reduce the risk of burns, electric shock, fire, injury to persons or exposure to excessive microwave energy:**

• **Use this appliance only for its intended use as described in this manual. Do not use corrosive chemicals or vapors in this appliance.** This microwave oven is specifically designed to heat or cook food, and is not intended for laboratory or industrial use.

• **Read and follow the specific "PRECAUTIONS TO AVOID POSSIBLE EXPOSURE TO EXCESSIVE MICROWAVE ENERGY" on page 2.**

• **This appliance must be grounded.** Connect only to properly grounded outlet. See "GROUNDING INSTRUCTIONS" on page 32.

• **For best operation, plug this appliance into its own electrical outlet,** to prevent flickering of lights, blowing of fuse or tripping of circuit breaker.

• **Install or locate this appliance only in accordance with the provided Installation Instructions.**

• **Be certain to place the front surface of the door three inches or more back from the countertop edge to avoid accidental tipping of the appliance in normal usage.**

• **Do not cover or block any openings on the appliance.**

• **Do not store this appliance outdoors. Do not use this product near water—for example, in a wet basement, or near a swimming pool.**

• **Do not immerse power cord or plug in water.**

• **Keep power cord away from heated surfaces.**

• **Do not let power cord hang over edge of table or counter.**

• **Do not operate this appliance if it has a damaged power cord or plug, if it is not working properly, or if it has been damaged or dropped.**

• **See door surface cleaning instructions in the Care and Cleaning section(s) of this book.**

• **This appliance should be serviced only by qualified service personnel.** Contact nearest authorized service facility for examination, repair or adjustment.

• **As with any appliance, close supervision is necessary when used by children.**

• **To reduce the risk of fire in the oven cavity:**

—**Do not use the oven for storage purposes.** Do not leave paper products, cooking utensils, or food in the oven cavity when not in use.

—**Do not overcook food.** Carefully attend appliance if paper, plastic or other combustible materials are placed inside the oven to facilitate cooking.

*(continued next page)*

---

# IMPORTANT SAFETY INSTRUCTIONS (continued)

—Remove wire twist-ties from paper or plastic bags before placing bags in oven.

—Do not use your microwave oven to dry newspapers.

—Do not use recycled paper products. Recycled paper towels, napkins and waxed paper can contain metal flecks which may cause arcing or ignite. Paper products containing nylon or nylon filaments should be avoided, as they may also ignite.

—Do not pop popcorn in your microwave oven unless in a special microwave popcorn accessory or unless you use popcorn labeled for use in microwave ovens.

—Do not operate the oven while empty to avoid damage to the oven and the danger of fire. If by accident the oven should run empty a minute or two, no harm is done. However, try to avoid operating the oven empty at all times—it saves energy and prolongs the life of the oven.

—Do not overcook potatoes. They could dehydrate and catch fire, causing damage to your oven.

•If materials inside oven should ignite, keep oven door closed, turn oven off, and disconnect power cord, or shut off power at the fuse or circuit breaker panel.

•Some products such as whole eggs and sealed containers—for example, closed jars—will explode and should not be heated in this microwave oven. Such use of the microwave oven could result in injury.

•Avoid heating baby food in glass jars, even without their lids; especially meat and egg mixtures.

•Don't defrost frozen beverages in narrow necked bottles (especially carbonated beverages). Even if the container is opened, pressure can build up. This can cause the container to burst, possibly resulting in injury.

•Use metal only as directed in this book and the cookbook provided with your microwave oven. TV dinners may be microwaved in foil trays less than 3/4" high; remove top foil cover and return tray to box. When using metal in the microwave oven, keep metal (other than metal shelf) at least 1 inch away from sides of oven.

• Cookware may become hot because of heat transferred from the heated food. Pot holders may be needed to handle the cookware.

•Sometimes, the glass cooking tray can become too hot to touch. Be careful when touching the tray during and after cooking.

•Foods cooked in liquids (such as pasta) may tend to boil over more rapidly than foods containing less moisture. Should this occur, refer to the Care and Cleaning section for instructions on how to clean the inside of the oven.

•Thermometer—Do not use a thermometer in food you are microwaving unless the thermometer is designed or recommended for use in the microwave oven.

• Remove the temperature probe from the oven when not using it to cook with. If you leave the probe inside the oven without inserting it in food or liquid, and turn on microwave energy, it can create electrical arcing in the oven and damage oven walls.

•Plastic cookware—Plastic cookware designed for microwave cooking is very useful, but should be used carefully. Even microwave-safe plastic may not be as tolerant of overcooking conditions as are glass or ceramic materials and may soften or char if subjected to short periods of overcooking. In longer exposures to overcooking, the food and cookware could ignite. For these reasons: 1) Use microwave-safe plastics only and use them in strict compliance with the cookware manufacturer's recommendations. 2) Do not subject empty cookware to microwaving. 3) Do not permit children to use plastic cookware without complete supervision.

•When cooking pork, follow the directions exactly and always cook the meat to an internal temperature of at least 170°F. This assures that, in the remote possibility that trichina may be present in the meat, it will be killed and meat will be safe to eat.

•Do not boil eggs in a microwave oven. Pressure will build up inside egg yolk and will cause it to burst, possibly resulting in injury.

**•Foods with unbroken outer “skin”** such as potatoes, sausages, tomatoes, apples, chicken livers and other giblets, and egg yolks (see previous caution) should be pierced to allow steam to escape during cooking.

**•Not all plastic wrap is suitable for use in microwave ovens.** Check the package for proper use.

**•Spontaneous boiling—Under certain special circumstances, liquids may start to boil during or shortly after removal from the microwave oven.** To prevent burns from splashing liquid, stir the liquid briefly before removing the container from the microwave oven.

**•“Boilable” cooking pouches and tightly closed plastic bags** should be slit, pierced or vented as directed by package. If they are not, plastic could burst during or immediately after cooking, possibly resulting in injury. Also, plastic storage containers should be at least partially uncovered because they form a tight seal. When cooking with containers tightly covered with plastic wrap, remove covering carefully and direct steam away from hands and face.

**•Hot foods and steam can cause burns.** Be careful when opening any containers of hot food, including popcorn bags, cooking pouches and boxes. To prevent possible injury, direct steam away from hands and face.

### **•Use of the DOUBLE DUTY™ Shelf accessory.**

—Remove the shelf from oven when not in use.

—Do not store or cook with shelf on floor of oven. Product damage may result.

—Use pot holders when handling the shelf and cookware. They may be hot.

—Do not use microwave browning dish on shelf. The shelf could overheat.

—Be sure that the shelf is positioned properly inside the oven to prevent product damage. Use of shelf with Auto Cook, Auto Reheat or Popcorn feature is not recommended (see the Auto Cook, Auto Reheat, or Popcorn sections).

## **SAVE THESE INSTRUCTIONS**

### **Program Cooking**

Use your Touch Control Panel to Auto Cook, Auto Roast, Auto Reheat and Auto Defrost—with the oven setting the power levels and cooking or heating times; to Temp Cook & Hold, using your choice of temperature; to Time Cook or Time Defrost, using your choice of power levels from 1 (lowest) to 10 (highest); to heat foods for 30 seconds using Add 30 Seconds; to set the clock; and to time kitchen tasks with the Min/Sec Timer.

Create your own programs to suit your individual cooking style. For example: program a hold time between Time Defrost and Time Cook I & 11; set Time Cook I & 11 for a two-stage program using different times and power levels; or use the Min/Sec Timer to delay the start of a cooking function, such as Temp Cook & Hold.

### **When You Plug in the Oven**

The display panel lights up. After 15 seconds, all lights disappear and “RESET” appears. Touch the CLEAR/OFF pad and oven is ready for use and the clock can be set.

If power is disrupted at any time, the above sequence recurs and you must reset clock after touching CLEAR/OFF.

### **Optional Accessory**

Optional accessories are available at extra cost from your GE supplier.

**JX18K Installation Kit** converts this oven to a built-in wall oven.

Note: JX18K kits should not be installed above a built-in oven with rotisserie feature.

# Features of Your Oven

## Cooking Complete Reminder

(For all cooking features except Auto Roast code 4)

To remind you that you have food in the oven, the oven will beep once a minute until you either open the oven door or touch the CLEAR/OFF pad.

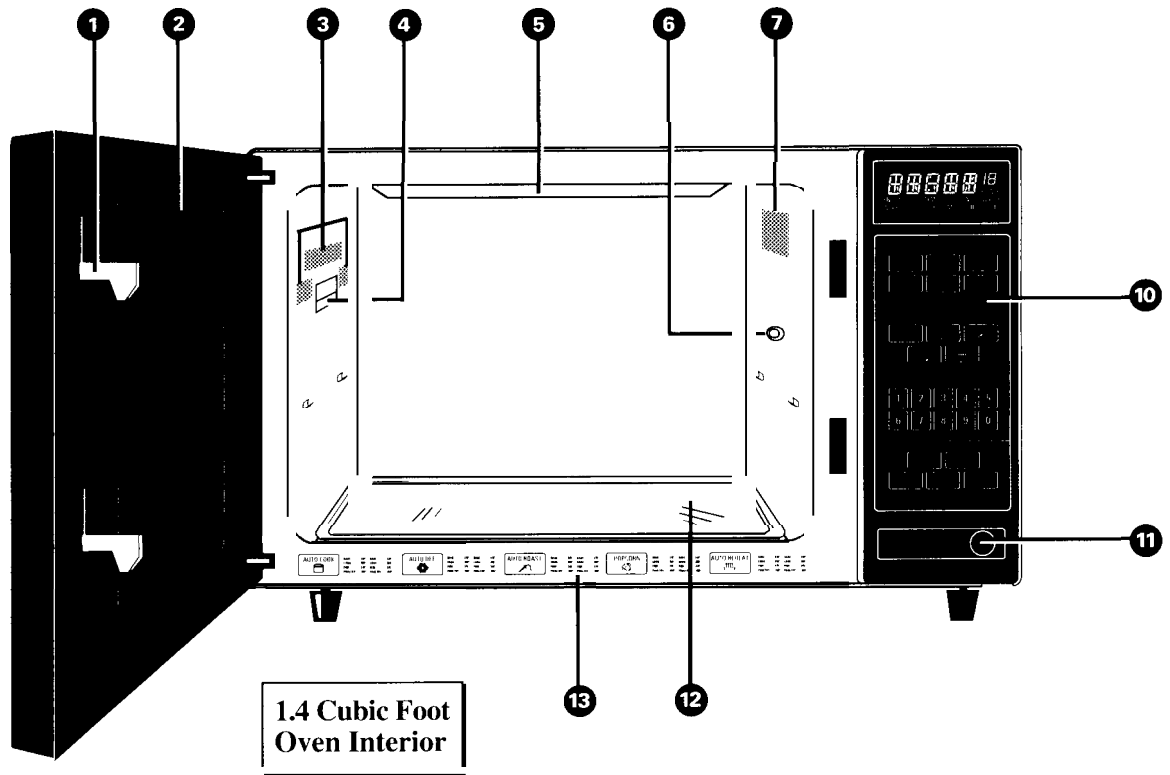
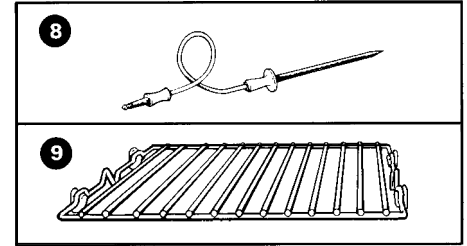

**1. Door Latches.**

**2. Door Screen.** Metal screen permits viewing of foods and keeps microwaves confined inside oven.

**3. Oven Vent.**

**4. Model and Serial Numbers.**

**5. Mode Stirrer Cover.** Protects the microwave energy distributing system. Do not remove this cover. You will damage the oven.

**6. Receptacle for Temperature Probe.** Temperature probe must be securely inserted into receptacle when using Temp Cook & Hold or Auto Roast.

**7. Oven Interior Light.** Turns on when the door is opened or when the oven is operating.

**8. Temperature Probe.** Use with Temp Cook & Hold and Auto Roast functions only.

**9. DOUBLE-DUTY™ Shelf.** Lets you microwave several foods at once. (See Safety Instructions and Double Duty™ Shelf pages for special instructions.) Use this shelf only when cooking foods on two levels.

**10. Touch Control Panel and Display.** See next page for instructions.

**11. Door Latch Release.** Press latch release button at indent to open door.

**12. Glass Cooking Tray.** Tray must be in place when using the oven. Cooking performance will be unsatisfactory without the tray in place. **The tray may be removed for cleaning.**

**13. Automatic Cooking Guide.** Quick reference codes for many frequently prepared foods.

# Your Touch Control Panel

The Touch Control Panel allows you to set the oven controls with the touch of a finger. It's designed to be easy to use and understand.

1. **DISPLAY.** Displays time of day, time or temperature during cooking functions, power level being used, cooking mode and instructions.

2. **TIME COOK I & II.** Microwave for a selected amount of time using automatic power level 10 (High).

3. **POWER LEVEL.** Touch this pad after you enter the cooking time if you want to change from automatic power level 10 (High).

4. **AUTO DEFROST.** Touch this pad and enter food weight. The oven automatically sets power levels and defrosting time.

5. **AUTO COOK.** Touch this pad and then number pad for desired code number, and oven automatically microwaves at pre-programmed power levels and determines the proper amount of cooking times until the food is done and oven shuts off.

6. **POPCORN.** Touch this pad and START, and the popcorn sensor determines the right cooking time. The microwave popcorn feature is designed to be used only with prepackaged microwave popcorn weighing 3.0 to 3.7 ounces.

7. **NUMBER PADS.** Touch these pads to enter cooking, defrosting time, time of day, temperature, power level, Auto Codes or food weights for Auto Defrost.

8. **MINUTE.** Use with number pads to enter whole minutes. For example, for 4 minutes touch 4 and MINUTE.

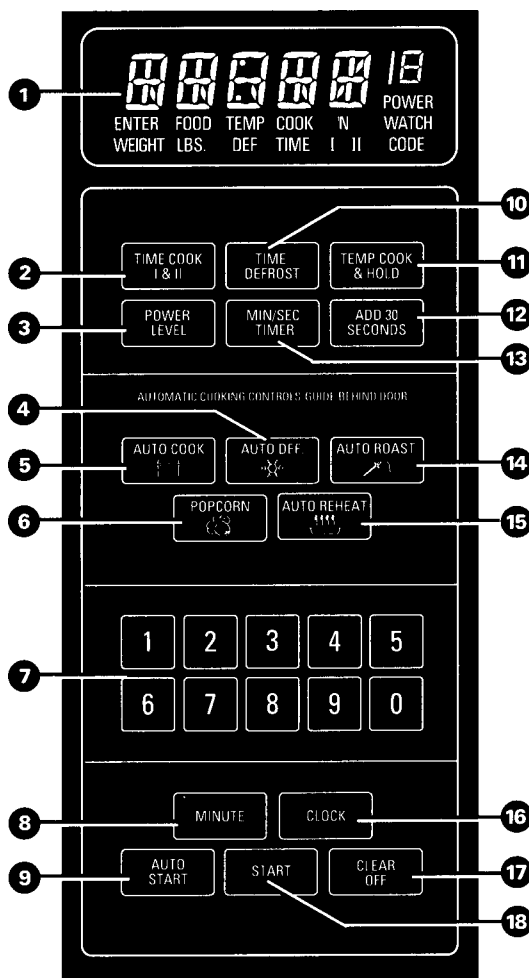

9. **AUTO START.** Allows you to program your oven to begin cooking at a preset time of day—up to a 12-hour delay.

10. **TIME DEFROST.** Gentle thawing at automatic power level 3 (Low).

11. **TEMP COOK & HOLD.** Use the temperature probe to cook by using a preset temperature. Once food reaches preset temperature, oven switches to HOLD setting and maintains that temperature until you touch the CLEAR/OFF pad.

12. **ADD 30 SECONDS.** Press this pad to add 30 seconds to the cook time as it's counting down.

13. **MIN/SEC TIMER.** This feature uses no microwave energy. It functions as either a kitchen timer, as a holding period after defrost or as a delay timer before time or temperature cooking.

14. **AUTO ROAST.** Insert probe, touch this pad, and desired number pad for code to slow-cook or temperature cook meat with automatic preset program.

15. **AUTO REHEAT.** Touch this pad, and START for quick reheating of prepared foods.

16. **CLOCK.** Touch this pad to enter time of day or check time of day while microwaving. To set clock, first touch CLOCK pad and then enter time of day. For example, if time is 1:30, touch number pads 1, 3, and 0 and "1:30" will appear in display. Then touch START pad. To reset or change time, simply repeat above process.

17. **CLEAR/OFF.** When touched, it shuts off the oven and erases all settings (except time of day).

18. **START.** After all selections are made, touch this pad to start the oven.

## "Error" Appears on Display:

- During Auto Cook, Reheat or Popcorn program, the door was opened before steam could be detected.
- No steam was detected by sensor within four minutes and 10 seconds after start of Popcorn program.

## "PROBE" Appears on Display:

- Probe has been forgotten when Auto Roast or Temp Cook & Hold function is being used.
- Probe is not securely seated in oven wall receptacle.

# How to Use the Minute/Second Timer

The MIN/SEC TIMER has three timing functions:

- It operates as a minute timer.
- It can be set to delay cooking.
- It can be used as a hold setting after defrosting.

The MIN/SEC TIMER operates without microwave energy.

## How to Time a 3-Minute Phone Call

1. Touch MI N/SEC TIMER pad.
2. Touch number pads 3 and MINUTE pad (for 3 minutes and no seconds).
3. Touch START. Display shows time counting down.
4. The timer signals when time is up.

## Using a Holding Time

The Minute/Second Timer can also be used to program a “holding time” between microwave cooking functions. The time can range from one second to 99 minutes and 99 seconds. A holding or standing time may be found in some of your own recipes or in the cookbook supplied.

## Programming Delayed Cooking

To delay cooking up to 99 minutes and 99 seconds, touch either TIME COOK I & II, TEMP COOK & HOLD or AUTO ROAST and enter cook time, temperature or code. Touch MIN/SEC TIMER and enter number of minutes to delay cooking. **When delaying Temp Cook & Hold or Auto Roast cooking, be sure probe is in food.** Touch START. Timer will count down to zero and cooking will begin.

## How to Defrost, Hold and Time Cook

Let’s say you want to defrost a frozen casserole for 15 minutes, hold for 10 minutes and then Time Cook for 25 minutes. Here’s how to do it:

**Step 1:** Take the casserole from the freezer and place it in the oven.



**Step 2:** Touch TIME DEFROST.

**Step 3:** Touch pads 1,5 and MINUTE pad for 15 minutes defrosting time. “15:00” appears on display. (Defrosting is automatically set on power level 3 but can be changed by touching the POWER LEVEL pad and the desired power level.)



**Step 4:** Set standing or hold time by touching MIN/SEC TIMER.

**Step 5:** Touch 1, 0 and MINUTE pad to hold for 10 minutes.



**Step 6:** Touch TIME COOK I & II pad.

**Step 7:** Touch 2, 5 and MINUTE pad for 25 minutes of cooking time.



**Step 8:** Touch START. As each function is automatically performed, oven display shows instructions entered and the function. When time is up, the oven signals and flashes “End.”

## Questions and Answers

**Q. What will happen if I accidentally reverse my defrost, hold and cook instructions’?**

**A.** The oven will automatically rearrange your program. Defrosting will always come first, then hold, and then the cooking function.

**Q. Can I defrost and hold only?**

**A.** Yes. Sometimes you may only want to defrost a food, hold it, and cook it later. All you need to do is program in defrost and amount of time. Then program the hold time and the amount of cooking time. Be sure to put the thawed dish in the refrigerator promptly.

**NOTE:** Foods that are highly perishable, such as milk, eggs, fish, stuffings, poultry and pork should not be allowed to sit out for more than one hour after defrosting. Room temperature promotes the growth of harmful bacteria.

**Q. I programmed my oven for a specific defrosting time but it defrosted longer than necessary. What happened?**

**A.** When instructions conflict, the oven carries out the last instruction. You may have set the oven to defrost for 4 minutes, hold for 2 minutes, and then defrost for 6 minutes. In this case, the oven would defrost for 6 minutes and hold for 2 minutes.



# Defrosting by Time

Time Defrost is designed for speedy thawing of frozen food and is one of the great advantages of a microwave oven.

Use the Time Defrost setting to quickly thaw foods such as bread, rolls, vegetables, fruits and frozen dinners. The Auto Defrost setting is preferred for meat and poultry because the oven sets the defrosting time and power levels for you.

- Power level 3 is automatically set for defrosting, but you may change this for more flexibility.

- See your cookbook for defrosting help.

To become better acquainted with the defrost function, defrost a 10 oz. package of frozen strawberries by following the steps below.

**Step 1:** Place a package of frozen strawberries in the oven and close the door. Be sure the package contains no metal.



TIME  
DEFROST

**Step 2:** Touch TIME DEFROST.

**Step 3:** Select one half of the total defrosting time recommended in your cookbook. For example, touch 4 and MINUTE pad for 4 minutes.

## How to Change Power Level

After setting defrosting time, touch POWER LEVEL pad, then touch desired number for new power level.



START

**Step 4:** Touch START. When the cycle is completed, the oven signals and flashes "End," then automatically shuts off.

**Step 5:** Turn the package over, close the door and repeat Steps 2 and 3 to set remaining half of defrosting time and touch START.

**Step 6:** When the oven signals and flashes "End," open the door, remove the package and separate strawberries to finish defrosting.

## Defrosting Tips

- Foods frozen in paper or plastic can be defrosted in the package.



- For even defrosting, some foods need to be broken up or separated part of the way through the defrosting time.

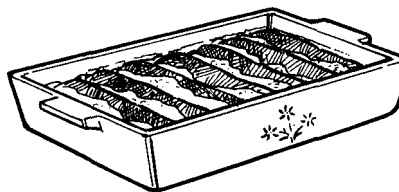

- Family-size, pre-packaged frozen dinners can be defrosted and microwaved. If the food is in a foil container, transfer it to a microwave-safe dish.

- Check your cookbook for other defrosting tips.

## Questions and Answers

**Q. When I press START, I hear a dull, thumping noise. What is it?**

**A.** This sound is normal. It is letting you know the oven is using a power level lower than 10 (High).

**Q. Can I defrost small items in a hurry?**

**A.** Yes, but they will need more frequent attention than usual. Raise the power level after entering the time by touching the desired power level pad. Power level 7 cuts the total defrosting time in about 1/2; Power level 10 cuts the total defrosting time to approximately 1/3. During either, rotate or stir food frequently.

**Q. Why don't the defrosting times in the cookbook seem right for my food?**

**A.** These times are averages. Defrosting time can vary according to the temperature in your freezer. Set your oven for the time indicated in your cookbook. If your food is still not completely thawed at the end of that time, reset your oven and adjust the time accordingly.

**Q. Should all foods be completely thawed before cooking?**

**A.** Some foods should not be completely thawed before cooking. For example, fish cooks so quickly it is better to begin cooking while it is still slightly frozen.

**Q. Can I open the door during defrosting to check on the progress of my food?**

**A. Yes.** You may open the door at any time during microwaving. To resume defrosting, close the door and press START. The oven begins operating if time is left on timer. If not, reset timer.

# Cooking by Time

**Time Cook 1 & 11** allows you to microwave for a selected amount of time.

Powerlevel 10 (High) is recommended for most cooking, but you may change this for more flexibility. See your cookbook.

To become better acquainted with time cooking, make a cup of coffee by following the steps below.

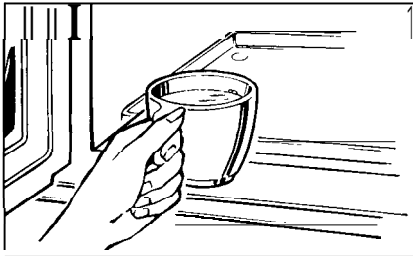

**Step 1:** Fill a cup 2/3 full of water, add 1 teaspoon of instant coffee and stir to dissolve. Use a cup that has no metal decoration and is microwave-safe (refer to Microwaving Tips in the Safety Instructions). Place cup in oven and close door.



**Step 2:** Touch TIME COOK I & II.

**Step 3:** Select your time. Touch 1 and MINUTE pad for one minute.

Because automatic power level 10 is recommended for this cup of coffee, there is no need to change the power level. (If power level 10 is not appropriate, see "How to Change Power Level" at right.)

**Step 4:** Touch START.

**Step 5:** When time is up, the oven signals and flashes "End." Oven, light and fan shut off.

**Step 6:** Open the door.

## Using the Time Cook II Feature

The Time Cook II feature lets you set two time cooking functions within one program. This is ideal if you want to change power levels during your cooking operations. Here's how to do it.

**Step 1:** Place food in oven in microwave-safe container and close the door.



**Step 2:** Touch TIME COOK I & II. Display shows ": 0" and "POWER 10." "ENTER COOK TIME I" flashes.

**Step 3:** Select your cooking time. For example, touch 2, 1 and 5 for two minutes and 15 seconds. Display shows "2: 15" and "POWER 10." "COOK TIME I" flashes.

**Step 4:** Touch TIME COOK I & II.

**Step 5:** Set your cooking time.

### How to Change Power Level

After setting cooking time, touch POWER LEVEL pad, then touch desired number for new power level.

**Step 6:** Touch START.

**Step 7:** "POWER 10" is displayed and "COOK TIME I" counts down.

**Step 8:** At the end of "COOK TIME I," the second power level is displayed and "COOK TIME II" is shown counting down.

**Step 9:** When time is up, the oven signals and flashes "End." The oven, light and fan shut off.

**Step 10:** Open the door.

## The Express Cook Feature

The Express Cook feature is a short-cut method to set time for 1–5 minutes.

To Express Cook your food or beverage:

**Step 1:** Touch a number pad (from 1 to 5) that corresponds with the amount of your desired cooking time (in minutes). For example, touch the 2 pad for 2 minutes of cooking time.

**Step 2:** Touch the START pad.

The oven will automatically signal, flash "End" and shut off at the end of the programmed time.

## Add 30 Seconds



The Add 30 Seconds feature provides a convenient way to extend cooking time by 30 seconds while the oven timer is counting down. It will add 30 seconds to the time shown each time the pad is touched.

# Popcorn

**Note:**

Use of the metal Double Duty<sup>SM</sup> shelf with Popcorn program is NOT recommended.

**Step 1:** Remove the outer wrapper from the microwave popcorn.

**Step 2:** Open oven door and place package of popcorn in the center of the oven floor as directed by the manufacturer's instructions. Close oven door.



**Step 3** Touch POPCORN pad



“POP” flashes. After 4 seconds, “START” flashes on display.



**Step 4:** Touch START The popcorn sensor automatically calculates the cooking time



After the popcorn sensor detects steam, the oven signals and displays remaining cooking time needed.

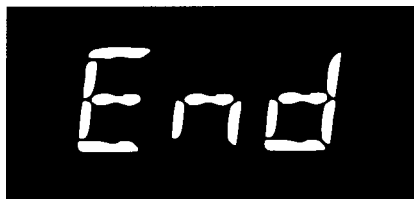

**Step 5:** When cooking is completed, the oven signals and flashes “End.” Open the door and remove the popcorn.

## How to Adjust the POP Program to Provide a Shorter or Longer Cook Time

If your favorite popcorn is not completely popped, there is a simple adjustment you can make.



Touch the POPCORN pad and then touch number pad 9. The word “POP” will appear on the display with a plus sign beside it. The plus sign indicates 20 seconds more cooking time is being provided.

If your favorite popcorn is over-cooked, there is another adjustment you can make.



Touch the POPCORN pad and then touch number pad 1. The word “POP” will appear on the display with a minus sign beside it. The minus sign indicates 20 seconds less cooking time is being provided.

## Questions and Answers

**Q. I set my oven for the time called for in the recipe, but at the end of the time allowed, my food wasn't done. What happened?**

**A.** Since house power varies due to time or location, many Time Cook recipes give you a time range to prevent overcooking. Set the oven for minimum time, test the food for doneness, and cook your food a little longer, if necessary.

**Q. I touched the number pads and selected my power level. When I touched START, however, my oven didn't come on. Why not?**

**A.** The TIME COOK I & II pad must be touched before setting the number pads or else your oven will not begin cooking.

**Q. I want to cook on a power level other than High. What do I need to do?**

**A.** To cook on a power level other than High, first touch the TIME COOK I & II pad and set the desired cooking time. Then touch the POWER LEVEL pad. “POWER 10” appears on the display panel. Enter new power level number and touch START.

**Q. Can I interrupt my Time Cook function to check the food?**

**A. Yes.** To resume cooking, simply close the door and press the START pad. The timer must be reset for cooking to resume unless time is remaining on timer.

**Q. I opened the door to check on the popcorn and “Error” appeared on the display. Why?**

**A.** The Popcorn program first detects steam and then switches to Time Cook. If you open the door while “POP” is displayed, “Error” will appear. Close the door, touch CLEAR/OFF and begin again. You may open the door when “End” appears on display.

# Automatic Roasting

Auto Roast uses the temperature probe to cook to the desired serving temperature. Unlike Temp Cook & Hold, which uses a single power level, Auto Roast uses up to 3 power settings which automatically switch during roasting, thus providing even, tender cooking results without overcooking.

Just as in conventional roasting, only tender roasts should be Auto Roasted until specified internal temperatures are reached. Less tender roasts should be microwaved by time, according to the cookbook which comes with your oven.

## Preparing Roasts for Auto Roasting

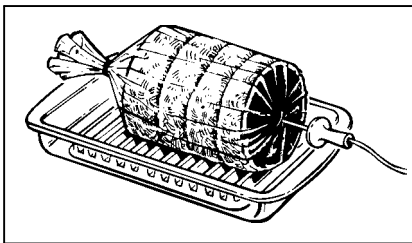

Place tender beef roast in cooking bag on trivet in microwave-safe dish. (Refer to package instructions for proper use of cooking bag.) Insert probe through cooking bag horizontally into the center meaty area not touching bone or fat. Make sure the handle does not touch the food or top or sides of the oven.

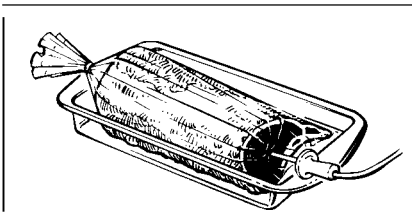

Place pork roast in cooking bag and place in microwave-safe dish.

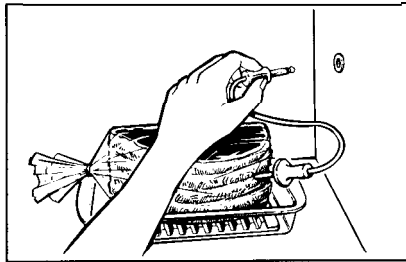

Place meat in oven with probe to the right. Insert cable end of probe firmly into receptacle on oven wall.

## How to Auto Roast Beef Roast to Medium



1. Touch AUTO ROAST pad. Touch number pad 1. "1" and the selected doneness code—in this case, "MED"—appear on the display. "CODE" flashes. After 4 seconds, "START" flashes on the display. Touch START. (See "Auto Roast Guide" for complete list of recommended codes.)



Note: By touching the AUTO ROAST pad during cooking, the meat's internal temperature will be displayed. ("COOL" will be displayed until meat reaches 90°F.) When pad is released, doneness code reappears on the display.



2. When you select Auto Roast codes 1 or 2, the oven signals with 4 beeps and "TURN" flashes on the display when it's time to turn the roast over. After you turn the roast, close the door and touch START. (Note: Oven continues to cook after the signal whether or not roast is turned over.)

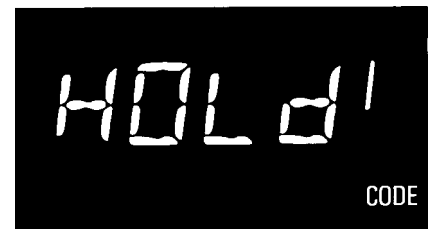

3. After a pre-programmed food temperature is reached, oven beeps 4 times and "HOLD" appears on the display.



4. Food will be held at this temperature for 60 minutes. The oven then beeps 4 times and "End" appears.

## Auto Roast Guide

- Place meats in a cooking bag in microwave-safe dish. (Refer to package instructions for proper use of cooking bag.)
- Recommended codes are shown on guide behind door, on front of oven.
- Insert probe as described in the Automatic Roasting section.

Food	Code	Minimum End Temp.	Approx. Time minutes per pound	Hold* Minutes	Doneness Display
<b>Beef (5 lb. max.)</b> Tender Roast Medium well	1	160°F.	13-15	0	MEd
	2	170°F.	15-17	<b>5-to</b>	WELL
<b>Pork (5 lb. max.)</b> Loin Roast	2	170°F.	15-19	10	WELL
<b>Poultry (6 lb. max.)</b> Turkey Breast (Insert probe horizontally into meatiest area.)	3	185°F.	<b>17-20</b>	10-15	WELL

\*1' Recommended standing time before serving.

## Automatic Simmer Guide (Auto Roast Code 4)

Food	Final Temp.	Approx. Time/Hours	Doneness Display	Comments
<b>Beef</b> Pot Roast	180°F.	<b>5-7</b>	SIM	Add enough liquid to just cover meat. If adding vegetables make sure they are completely covered by liquid.
Chili	180°F.	<b>5-8</b>	SIM	Precook meat. Place probe 1 inch from top surface. Stir after 3 hours, if possible.
<b>Chicken</b> Stewing	180°F.	4-6	SIM	Add 4 cups liquid. Insert probe into meatiest area of inner thigh from below end and parallel to leg. Turn over after 1/2 of time.
Broiler/Frycl	180°F.	3-4	SIM	Same procedure as above.
<b>Ham/Pork</b> Roast	180°F.	4-6	SIM	Add 4 cups liquid.
<b>soup</b> Stock/ Vegetable	180°F.	7-10	SIM	Make sure that vegetables and meat are covered by liquid. Stir every 3 hours.
Split Pea	180°F.	5-7	SIM	Add enough liquid to cover peas at least 2 inches. Stir after 3 hours.

## Automatic Simmer

### (Auto Roast Code 4)

Total time includes time to bring food to 180°F., and hold at that temperature until done.



Set Auto Simmer like Auto Roast as explained in the Automatic Roasting section. Display shows "SIM" and "CODE 4."



Oven switches to Hold at 180°F., and continues holding at 180°F. until you remove food and turn off oven. If stirring is recommended, you can restart oven by touching the START pad again. Touch CLEAR/OFF pad after cooking.

# Auto Defrost

With the Auto Defrost feature, the oven automatically sets the defrosting times and power levels for you.

Use the Auto Defrost guide on the next page. Enter the food weight in pounds and tenths of a pound (see Conversion Guide at right). Then touch START pad.

The oven calculates defrosting time and changes power levels during defrosting to give even defrosting results.

## How to Set Auto Defrost

Before you begin, check the guide located at front of oven when you open the door. It shows minimum and maximum food weights for a variety of foods. You will need to know your food weight before setting Auto Defrost.

1. Remove food from package, place in oven on microwave-safe dish and close door.



2. Touch AUTO DEF pad.

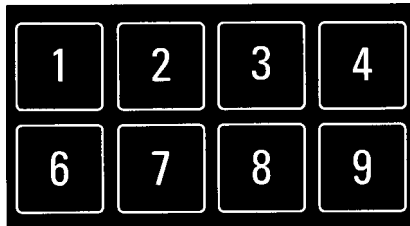

3. Enter weight. For example, touch number pads 1 and 2 for weight of 1.2 pounds ( 1 pound, 3 ounces. See Conversion Guide at right.).



4. Touch START pad Display shows defrost time counting down



Twice during defrosting, the oven beeps 4 times and “TURN” flashes. Follow the directions in the Auto Defrost Guide for what to do at the first and second signal. Then close the door and touch START. (Defrosting continues during “TURN” display.)

When defrosting time is completed, “End” flashes and oven beeps 4 times. “End” remains on display and oven beeps every minute until door is opened or CLEAR/OFF pad is touched.

## Stand Time

After Auto Defrosting, meat needs to stand in order to let the inside defrost. You may take the food out of the oven if you wish. Stand time recommendations are given in the guide on the next page.

## Conversion Guide

If the weight of the food is stated in pounds and ounces, the ounces must be converted to tenths (. 1) of a pound.

Ounces	Pounds
1-2	.1
3	.2
4-5	.3
6-7	.4
8	.5
9-10	.6
11	.7
12-13	.8
14-15	.9

# Auto Defrost Guide

RECOMMENDED FOODS	MIN.-MAX. WEIGHT	FIRST SIGNAL	SECOND SIGNAL	STAND TIME
<b>Meat</b>				
Chops	0.1 -6.0 lbs.	Turn over.	Separate and shield where necessary.	5 minutes
Frankfurters, Sausage	0.1 -6.0 lbs.	Separate.	Remove defrosted pieces.	2 minutes
Ground Meat	0.1 - 6.0 lbs.	Turn over.	Remove defrosted areas and break apart.	5 minutes
Beef Patties	0.1 -6.0 lbs.	Turn over.	Separate patties.	5 minutes
Roast	0.1 -6.0 lbs.	Turn over and shield.	Shield if necessary.	90 minutes
Ribs	0.1 -6.0 lbs.	Turn over.	Remove defrosted pieces. Shield if necessary.	10 minutes
Steak	0.1 -6.0 lbs.	Turn over.		5 minutes
Stew	0.1 -6.0 lbs.	Turn over and separate.	Separate and remove defrosted pieces.	5 minutes
<b>Poultry</b>				
Whole Chicken	0.1 -6.0 lbs.	Turn over and shield.	Turn over and shield.	10 minutes; run cold water in cavity.
Turkey Breast (breast side up)	0.1 -6.0 lbs.	Turn over.	Shield where necessary.	20 minutes in refrigerator
Chicken Pieces	0.1 -6.0 lbs.	Turn over.	Separate and remove defrosted pieces.	5 minutes
Cornish hens (whole)	0.1 -6.0 lbs.	Remove wrapper and turn over.		10 minutes; run cold water in cavity.
Cornish hens (split)	0.1 -6.0 lbs.	Turn over.		5 minutes
<b>Fish</b>				
Fish fillets	0.1 -6.0 lbs.	Turn over.	Separate and remove defrosted pieces.	5 minutes
Shrimp, scallops	0.1 -6.0 lbs.	Separate.	Separate and remove defrosted pieces.	5 minutes
Whole fish	0.1 -6.0 lbs.	Turn over and shield tail and head.		Hold under cold running water.

Edges or thin areas of meat will defrost more rapidly than other areas. After first or second signal, shield warm areas with small pieces of foil.

# Cooking by Temperature

Internal temperature is the best test of doneness for many foods.

Use Temp Cook & Hold to cook a variety of foods to the desired finished food temperature. The Time Cook I & II setting is recommended for batters, doughs, frozen foods and foods which are difficult to cook precisely with the probe.

Temp Cook & Hold takes the guesswork out of cooking, because the oven automatically switches to "Hold" setting after reaching the preset food temperature and maintains that temperature until you touch the CLEAR/OFF pad.

Note: Oven automatically switches to "Hold" when preset food temperature is reached.

## The Temperature Probe

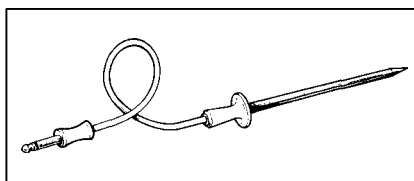

The temperature probe is a food thermometer that gauges the internal temperature of the food. (Its appearance may vary from picture above.) The probe must be used when using Temp Cook & Hold or Auto Roast. To use the probe properly, follow directions in the Automatic Roasting section.

## How to Temp Cook a Rolled Beef Rib Roast to Medium

**Step 1:** Insert temperature probe and attach probe securely in oven wall. Close the door.

**Step 2:** Touch TEMP COOK & HOLD pad.

**Step 3:** Touch 1, 6 and () for 160°F.

**Step 4:** Touch POWER LEVEL pad. Touch 5 for medium power.

**Step 5:** Touch the START pad. If internal temperature of the roast is less than 90°F., display will show "COOL"; if temperature is 90°F. or above, display shows temperature counting up.

**Step 6:** When 160°F. is reached, the oven will sound and display "Hold." The oven will then hold the temperature.

**Step 7:** Touch the CLEAR/OFF pad to stop the cycle.

**Step 8:** Remove probe and food from the oven.

## How to Use Auto Start

The Auto Start feature allows you to program your oven to begin cooking at a preset time of day—up to a 12-hour delay.

To Use Auto Start



**Step 1:** Touch AUTO START pad (instead of START pad).

**Step 2:** Enter the time you want the oven to start. (Be sure your microwave oven clock shows the correct time of day.)

**Step 3:** Enter your desired cooking program.

**Step 4:** Touch START pad. The oven will automatically start at the desired time.

## Questions and Answers

**Q. Are there any foods I can't Temp Cook?**

**A. Yes.** Delicate butter icings, ice cream, frozen whipped toppings, etc., soften rapidly at warm temperatures. Batters, doughs and frozen foods are also difficult to cook precisely with the probe. It's best to Time Cook these foods.

**Q. Why did "PROBE" flash on the display after I touched the START pad?**

**A.** "PROBE" will flash if you don't seat the cable end of the probe securely into the receptacle in the oven wall or if you touch the TEMP COOK & HOLD pad and forget to use the probe.

**Q. Can I leave my probe in the oven if it's not inserted in food?**

**A. No,** if it touches the oven wall, it may damage the oven.

**Q. Can I Temp Cook different portions of food at different temperatures?**

**A. Yes.** The temperature probe gives you the freedom to cook different portions of food at different temperatures to suit individual eating styles. Simply place probe in food and change temperature setting as needed.

## Cooking Tips

- Use a lower power level; foods will heat more evenly though requiring more time.
- Be sure frozen food has been completely defrosted before inserting probe. Probe may break off if used in frozen foods.
- Cover foods loosely for moisture control and quick, even heating.



# Auto Reheat

Auto Reheat lets you touch just 2 pads to bring previously prepared foods to serving temperature. With many leftovers, there is no need to look up reheating times in the cookbook or to rely on guesswork.

**By actually sensing the steam that escapes as food heats, this feature automatically adjusts the oven's heating time to various types and amounts of pre-cooked food.**

Because all cooking containers must be covered during automatic reheating, this feature is best with foods you want to steam or retain moisture.

**Note:**  
Use of the metal Double-Duty™ shelf with Auto Reheat is NOT recommended.

## Foods Recommended

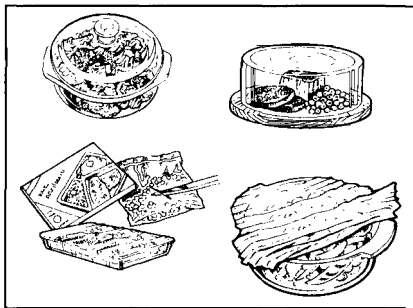

A wide variety of previously prepared foods including leftovers can be Auto Reheated. Auto Reheat is recommended for single-servings of food or plates of leftovers.

## Foods Not Recommended

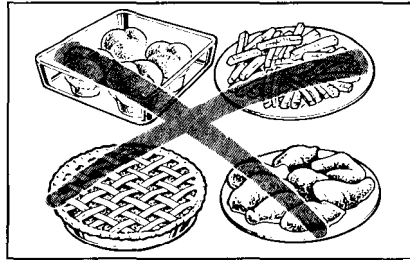

Bread products, foods that must be reheated uncovered, foods that require constant attention, foods calling for a dry look or crisp surface after reheating should not be Auto Reheated. It is best to use Time Cook 1 & II.

## Easy to Use

Simply touch AUTO REHEAT and START.

## Keep Door Closed

Do not open the oven door while the word "RHEAT" is displayed—steam escaping from the oven can affect reheating performance. If the door is opened, close the door and touch START immediately.

## Example:



Place covered food in oven. Touch AUTO REHEAT pad.



"RHEAT" shows on display and "FOOD" flashes.



After 4 seconds, "START" flashes on display. Touch START pad.



"RHEAT" and "FOOD" are displayed.

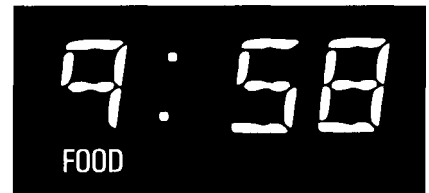

Beep sounds when steam is sensed and "RHEAT" is replaced by time counting down. Rotate or stir food if necessary. Close door and touch START to finish heating. When done, oven displays "End" and beeps every minute until door is opened or CLEAR/OFF is touched.

## Containers and Covers

Appropriate containers and coverings help assure good reheating results.

- Always use microwave-safe containers and cover them with **lids, wax paper or plastic wrap**. Wonder if it's microwave safe? Put it to the test described in the Microwaving Tips section.
- Never use tight-sealing plastic lids—they can prevent steam from escaping and cause poor reheating results.
- Match the amount of food to the size of the container. Fill containers at least half full for best results.
- **Be sure the outside of the cooking container and the inside of the microwave oven are dry** before placing food in the oven. Beads of moisture turning into steam can mislead the sensor.
- **Stir or rotate some foods after the beeping signal (if required).**



Use microwave-safe casseroles or bowls. Cover with lids that fit. If lids are not available, use plastic wrap or wax paper. Plastic wrap should be loose over food to allow for escaping steam. Seal by pressing plastic wrap firmly around edges.

## Questions & Answers

**Q. If my food is not completely reheated after using Auto Reheat, what should I do?**

**A.** Use Time Cook I & II to reheat for additional time until desired temperature is reached.

**Q. What if I don't fully cover the dish in Auto Reheat?**

**A.** Oven senses steam too quickly, which shortens the reheating time and leaves food too cool. Cover tightly and reset Auto Reheat.

**Q. Do the shapes and sizes of food make a difference when using Auto Reheat?**

**A. Yes,** in some cases, larger pieces will require additional Time Cooking. Be sure to check suggested arrangement of pieces in the dish, since proper arrangement is often a successful tip in regular microwaving.

**Q. Are there any other foods which are reheated best using Time Cook I & II, rather than Auto Reheat?**

**A.** Bakery foods, candies, melted chocolate or foods when a dry or crisp surface is desirable, are reheated best by Time Cook I & II.

**Q. Would my plastic containers with very tight fitting lids be appropriate for Auto Reheat?**

**A. No,** most types of plastic storage dishes, butter tubs, etc. with tight fitting lids are not recommended for microwaving. Also tight fitting plastic lids may prevent adequate steam from escaping and food may not heat properly during Auto Reheat.

**Q. I tried to warm some chow mein noodles using Auto Reheat. Why didn't this work?**

**A.** Food must have some moisture in order to create steam which helps the auto sensor function. Extremely dry foods such as chow mein noodles, potato chips and other such foods do not have enough moisture.

**Q. May I use Auto Reheat when I am reheating many foods in more than one dish or casserole?**

**A. No.** Because of different food densities, attention needed during reheating, and food amounts, it is best to use Time Cook I&II when reheating many foods.

# Auto Cook

The Auto Cook feature may be used to eliminate your need to look up cooking time in the cookbook or guess how long to set cooking time. By actually sensing the steam that **escapes as food microwaves, this feature automatically adjusts the oven's cooking time to various types and amounts of food.**

Because most cooking containers must be covered during Auto Cook, this feature is best with foods that you want to steam or retain moisture.

**Note:**  
Use of the metal Double Duty™ shelf with Auto Cook is NOT recommended.

## Foods Recommended

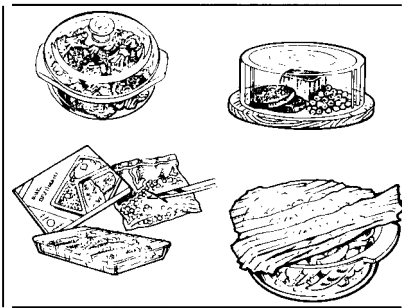

A wide variety of foods including meats, fish casseroles, vegetables, leftovers and convenience foods can be Auto Cooked.

## Foods Not Recommended

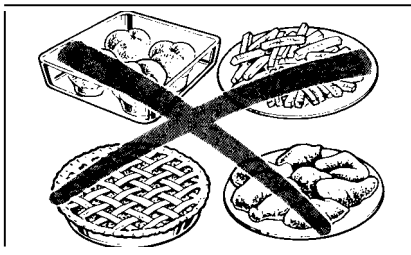

Foods that must be cooked uncovered, foods that require constant attention, foods that require addition of ingredients during cooking, and foods calling

for a dry look or crisp surface after cooking should not be Auto Cooked. It is best to Time Cook them.

Foods that microwave best using the temperature probe should be Temp Cooked or Auto Roasted.

## Easy to Use

Simply touch three control pads—AUTO COOK, desired CODE, and START. The word “AUTO” appears on the display and the sensor is activated to sense steam from food.

## Keep Door Closed

Do not open the oven door while the word “AUTO” is displayed—steam escaping from the oven can affect cooking performance. If the door is opened, close the door and touch START immediately.

## Auto Cook Codes

Auto Cook codes 1 through 8 are designed to give you easy automatic results with a number of foods.

Code 1, designed for reheating foods quickly, turns the oven off automatically as soon as the sensor detects steam from the foods.

When codes 2 through 8 are selected, the oven determines how much additional cooking time is needed after steam has been sensed, automatically switches to TIME COOK and signals. The word “AUTO” on the display is then replaced by countdown numbers indicating remaining cooking time. When the signal is heard, the oven door may be opened for stirring, turning or rotating food.

A guide behind the oven door lists cooking codes for frequently prepared fresh or uncooked foods and appropriate codes are recommended in the recipes and cooking guide in the Automatic Cooking section.

## Example:



Place covered food in oven Touch AUTO COOK pad “ENTER COOK CODE” flashes on display

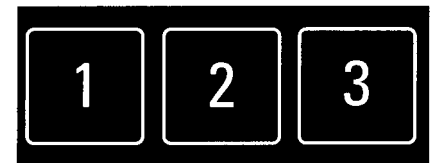

Touch number pad for desired code. “CODE 2” shows. After 4 seconds, “START” flashes on display. Touch START.



Word “AUTO” shows on display, indicating steam sensor is activated. DO NOT OPEN DOOR. OPENING DOOR MAY AFFECT COOKING PERFORMANCE.



Beep sounds when steam is sensed and “AUTO” is replaced by cook time. Rotate or stir food, if necessary. When done, oven beeps every minute until door is opened or CLEAR/OFF is touched.

## How to Adjust Auto Cook Codes to Suit Your Taste

By simply adding a 1 after any Auto Cook code number, you can set the oven to cook for 20% less time than the code would regularly provide.

For example, if code 4 cooks your chicken more done than you like it, set code 4 1 next time and you'll get 20% shorter cooking time.

If you want a longer cooking time than a code provides, add a 9 after the code.

For the chicken in the example above, code 49 would provide 20% longer cooking time than the regular code 4 would provide.

### Example:



Touch AUTO COOK pad



Touch number pads 4 and 1 in that order. "AUTO CODE 4" shows and after 4 seconds "START" flashes on display.



Touch START. "AUTO" shows on display, DO NOT OPEN DOOR until first oven signal, then rotate dish 1/2 turn if necessary. Close door and touch START to finish cooking.

## Questions & Answers

**Q. Why does my oven automatically cut off after the Auto cycle when using Auto Cook code 1, when it does not for other settings?**

**A.** When using code 1, there is no second phase of minutes counting down. All the cooking is completed in the first phase or Auto.

**Q. If my food is not completely cooked after using the suggested code, what should I do?**

**A.** Use Time Cook I and power level 10 for a few minutes until completion.

**Q. Do all fresh or frozen vegetables require a standing period after cooking with Auto Cook?**

**A.** Most vegetables are cooked to a crisp state during Auto Cook, just as in regular microwaving. Therefore, it is recommended that you let the vegetables stand for up to 5 minutes depending on size and density of pieces. This standing time also enhances the overall flavor and appearance of most vegetables.

**Q. What if I don't fully cover the dish in Auto Cook?**

**A.** Oven senses steam too quickly, which shortens the cooking time and leaves food undercooked. Cover tightly and reset Auto Cook.

**Q. Do the shapes and sizes of foods make a difference when using Auto Cook?**

**A. Yes,** in some cases, larger pieces will require additional Time Cooking. Be sure to check suggested arrangement of pieces in the dish, since proper arrangement is often a successful tip in regular microwaving.

**Q. Do fresh or frozen vegetables require water when using Auto Cook?**

**A. Yes.** Add water to the vegetables as recommended on guide and cover well for even, complete cooking.

**Q. Should I use Auto Cook to cook pudding or sauces?**

**A.** Most pudding and sauce recipes require stirring many times during cooking; therefore, Time Cook I & II is recommended.

**Q. My scalloped potatoes were not completely cooked when I removed the dish after Auto Cook. What is wrong?**

**A.** If you prepared the sauce in the oven prior to combining the sauce with potatoes, there may have been too much remaining moisture in the oven. Make sure you dry the oven completely before using Auto Cook since this function operates properly by sensing steam in the oven. Also, starting Auto Cook with hot foods creates steam in the oven too soon, and decreases the first sensing cycle.

**Q. Are there any other foods which are best Time Cooked, rather than Auto Cooked?**

**A.** Bakery foods, candies, melted chocolate or foods when a dry or crisp surface is desirable are cooked best by Time Cook I & II.

**Q. Would my plastic containers with very tight fitting lids be appropriate for Auto Cook?**

**A.** No, most types of plastic storage dishes, butter tubs, etc. with tight fitting lids are not recommended for microwaving. Also, tight fitting plastic lids may prevent adequate steam from escaping and may keep food from cooking properly during Auto Cook.

**Q. I tried to warm some chow mein noodles using Auto Cook. Why didn't this work?**

**A.** Food must have some moisture in order to create steam which helps the auto sensor function. Extremely dry foods such as chow mein noodles, potato chips and other such foods do not have enough moisture.

**Q. May I use Auto Cook when I am cooking many foods in more than one dish or casserole?**

**A.** No. Because of different food densities, attention needed during cooking and food amounts, it is best to use Time Cook I & II when cooking many foods.

# Automatic Cooking Containers & Covers

## Containers and Covers

Appropriate containers and coverings help assure good cooking results.

- **Always use microwave-safe containers and cover them with lids or vented plastic wrap.** Wonder if it's microwave safe? Put it to the test described in the Microwaving Tips section.
- **Never use tight-sealing plastic covers—they can prevent steam from escaping and cause food to overcook.**
- **Match the amount of food to the size of the container.** Fill containers at least half full for best results.
- **Be sure the outside of the cooking container and the inside of the microwave oven are dry** before placing food in the oven. Beads of moisture turning into steam can mislead the sensor.
- **Stir or rotate some foods after a beeping signal, if required. See Automatic Cooking Control Guide and recipes on the following pages.**

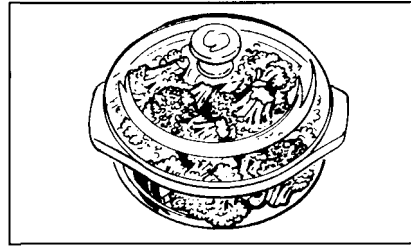

Use microwave-safe casseroles or bowls for entrees and vegetables. Cover with lids that fit. If lids are not available, use plastic wrap or wax paper. Plastic wrap should be vented over food to allow for escaping steam. Seal by pressing plastic wrap firmly around edges.

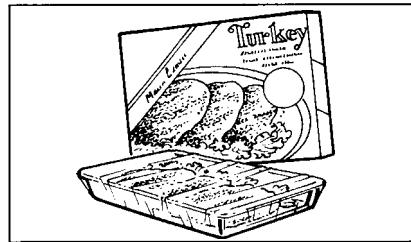

For frozen entrees in paperboard trays, remove tray from box but do not remove film over tray. Thick entrees may take longer to cook—see the Automatic Cooking Control Guide.

For frozen foods in metal trays, remove foil covering and baked goods, reinsert tray into box and close ends of box.

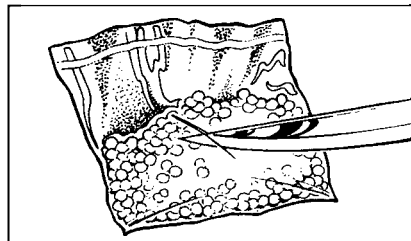

Slit plastic pouches 1 inch as shown above. Break food up thoroughly after oven signals.

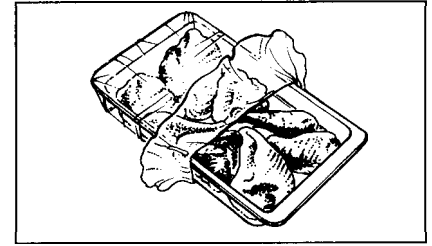

Use oblong or square containers for chicken or corn on the cob. Plastic wrap covering should be vented over food to allow for escaping steam. Seal by pressing plastic wrap firmly around edges.

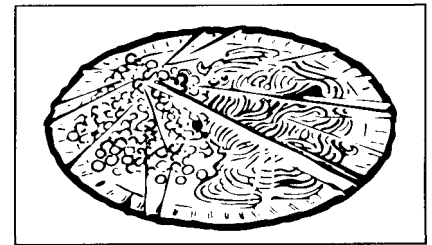

**Paper plates—while they may be used for Time and Temperature Cooking and Defrosting, do not use them with automatic cooking.** Use microwave-safe plates or bowls for reheating. Cover with plastic wrap or wax paper.

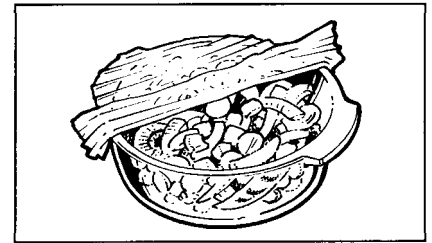

Follow Automatic Cooking Control Guide setting for casseroles. Cover casserole meat and vegetables with sauce. If they are not cool, it is better to use Time Cook I & II.

# Automatic Cooking Control Guide

- Do not open oven door during Auto cycle. When oven signals and countdown time is displayed, door may be opened for stirring, turning or rotating food. To resume cooking, close door and touch START.

- Match the amount of food to the size of container. Fill containers at least 1/2 full.

- Add 1/4 to 1/2 cup water to fresh vegetables.

- Foods should be covered with lid to dish or plastic wrap to prevent spattering to keep oven clean. Spareribs, pot roasts and meat loaf should be covered tightly to ensure even cooking.

- Be sure outside of container and inside of oven are dry.

- After completion of Auto Cook cycle, if food needs additional cooking, return food to oven and use Time Cook I & 11 to finish cooking.

To adjust cook times to suit individual tastes, add a "1" or "9" to code number when entering Auto Cook Code. See the Auto Cook section for instructions.

**•Use of Auto Cook feature with DOUBLE DUTY™ shelf is not recommended.**

Food	Auto Cook Code	Container	Approx. Time	Comments
<b>Canned Foods</b>				
Thin—water and milk-based soups, sauces, gravies	1	Microwave-safe container matched to size of food.	3 to 4 min. per cup	Cover with lid to dish or plastic wrap.
Thick—chili, beef stew, ravioli, spaghetti, chunky soups	2	Microwave-safe container matched to size of food.	3 to 4 min. per cup	Cover with lid to dish or plastic wrap.
Vegetables—8 to 16 ounces	2	Microwave-safe container matched to amount of food.	<b>4108</b> min.	Cover with lid to dish or plastic wrap.
<b>Leftovers</b>	<b>2</b>	Plate or microwave-safe container matched to amount of food.	2 to 4 min. per serving	Cover with lid to dish or plastic wrap.
<b>Convenience Foods</b>				
Frozen dinners (with entree and 2 vegetables or vegetable and pasta)	4	Package tray or plate	6 to 10 min.	Cover with plastic lid to plate or leave plastic covering in place on tray.
Frozen dinner entree (individual Pouch)	3	Pouch	3 to 6 min.	If tray has foil cover, replace with plastic wrap.
Frozen dinner entree (2 to 3 servings)	5	Tray	8 to 11 min.	
Frozen breakfast entrees	3	Package wrap or tray	3 to 5 min.	If tray has foil cover, replace with plastic wrap.
Grocery-Shelf dinner entrees	3	Package	3 to 5 min.	

Food	Auto Cook Code	Container	Approx. Time	Comments
<b>Casseroles</b> Pre-cooked ingredients in sauce, such as tuna noodle, turkey tetrazzini, and franks and beans	6	IX- to 3-qt. casserole with lid	20 to 30 min.	When oven signals, stir if necessary.
Uncooked ingredients, such as scalloped potatoes hamburger patty stew	7	IX- to 3-qt. casserole with lid	40 to 55 min.	When oven signals, stir if necessary.
<b>Meats, Poultry</b> <b>Seafood</b>				
<b>Chicken</b> pieces ( <sup>UP</sup> to 2½ lbs.)	5	2-qt. oblong glass baking dish	8 to 24 min.	Cover with plastic wrap.
Whole chicken ( <sup>UP</sup> to 3 lbs.)	8	2-qt. oblong glass baking dish	30 to 40 min.	Place in cooking bag; cut slits in bag as directed on package.
Fish fillets (1 lb.)	3	2-qt. oblong glass baking dish	7 to 10 min.	Cover with plastic wrap.
Meat loaf (1½ lbs.)	8	9 x 5 x 3-in. loaf dish	24 to 28 min.	Cover with plastic wrap.
Hamburger patties (4)	3	8-in. square dish	7 to 9 min.	Cover with plastic wrap.
Sausage patties (12 oz.)	3	2-qt. oblong glass baking dish	7 to 9 min.	When oven signals, turn patties over.
Pork chops (4, ½ to ¾-in. thick)	8	2-qt. oblong glass baking dish	30 to 35 min.	Cover with plastic wrap.
Shrimp (up to 1 lb.)	2	2-qt. oblong glass baking dish	4 to 7 min.	Cover with plastic wrap.
<b>Vegetables</b>				
<b>Frozen,</b> 10-oz. block	2	I-qt. casserole with lid	7 to 10 min.	Add amount of water recommended on package.
Frozen, 10-oz. pouch	3	Pouch on microwave-safe plate	8 to 10 min.	Cut slits in pouch as directed on package.
Baking potatoes (4, 6 to 8 oz. each)	4	8-in. square dish	12 to 16 min.	Pierce skin with fork. Arrange around sides of dish; cover with plastic wrap.
Cubed potatoes ( <sup>LIP</sup> to 2 lbs.)	4	2-qt. casserole with lid	20 to 30 min.	Add 1 to 1½ cup water.
Fresh vegetables, such as carrots, brussels sprouts, broccoli, cauli [lower, summer and winter squash, green beans	4	IX- to 2-qt. casserole with lid	13 to 15 min.	Add ¼ to ½ cup water. When oven signals, stir if necessary.
<b>Fruit</b> Baked apples, pears (4)	2	2-qt. casserole with lid	12 to 14 min.	Add 2 tablespoons water per piece of fruit to dish.

Follow THIS CHART.  
16, 18 OF RECIPES (pgs 14-20)

# Automatic Cooking Meats and Main Dishes

## Meat, Fish & Poultry

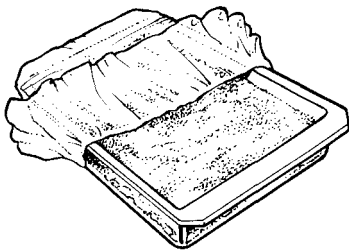

**For meat and fish loaves** use either the round or loaf microwave-safe containers. Fish loaves made with precooked or canned fish use Auto Cook code 8. Beef loaf uses Auto Cook code 8. Cover with plastic wrap.

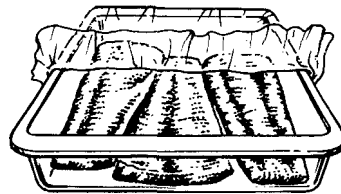

**Fish fillets, whole fish** or seafood pieces should be in single layer in flat pie plate or oblong dish to fit. Cover with plastic wrap. Use Auto Cook code 3.

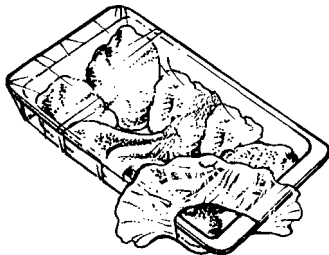

**Chicken breasts** and pieces or turkey parts should be placed in a microwave-safe square or oblong dish. Cover with plastic wrap. If cooking bag is used for whole chicken, shield breast bone with small strip of foil. Microwave using Auto Cook code 5.



**Chuck roasts** should be placed in a microwave-safe dish with 1/2 cup water. Cover with plastic wrap, venting one corner. Use Auto Cook code 2.

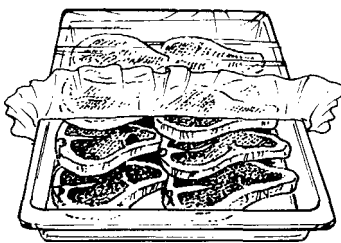

Pork chops automatically cook well in a 2-qt. oblong glass baking dish. Add barbecue sauce or other sauce on each chop. Cover with plastic wrap. Microwave using Auto Cook code 7. Rotate dish when oven signals and remaining time is displayed.

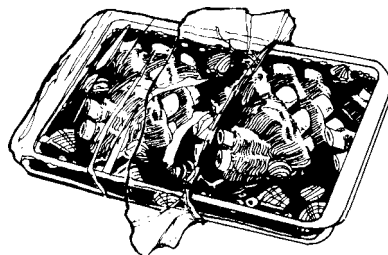

**Spare ribs and brisket** should be automatically cooked in an oblong glass container. Cover with plastic wrap. Make sure liquid covers meat. Microwave using Auto Cook code 2. Rotate dish when oven signals and remaining time is displayed.

## How to Adapt Microwave Casserole Recipes

To adapt your casserole recipes for Automatic Cooking.

1. Select recipes that do not require adding ingredients at different stages during cooking or recipes that require extra attention, stirring or rotating.
2. Use microwave-safe containers that are appropriate in size to the food amount. Use 3-qt. containers or smaller.
3. For saucy casseroles, cover container with lid or plastic wrap (no vents). For cheese or crumb-topped casseroles, remove cover after oven signals and add topping, then continue cooking uncovered.
4. Allow precooked ingredients or hot sauces to COOI slightly before adding other ingredients.
5. Meats and vegetables should be submerged in liquid.



## Meat or Main Dish Recipes

### Mexican Meatball Casserole

**Auto Cook Code 6**  
**Approx. Cooking Time—20 min.**  
**Makes 6 to 8 Servings**

- 1 lb. ground chuck
- 1/2 cup dry bread crumbs
- 1/8 teaspoon pepper
- 1 teaspoon salt
- 1 teaspoon chili powder
- 3 tablespoons dry minced onions
- 1 egg
- 3 tablespoons ketchup
- 1/2 cup instant rice
- 1 can (15½ oz.) kidney beans, undrained
- 1 can (14½ oz.) tomatoes, chopped and undrained
- 1 tablespoon chili powder

In large mixing bowl, place meat, bread crumbs, pepper, salt, chili powder, onion, egg and ketchup. Mix well and form into 18 balls. Arrange balls in 2-qt. casserole. Set aside.

In small mixing bowl place rice, beans, tomatoes and chili powder. Mix well and pour in casserole over meatballs. Cover. Microwave on Auto Cook code 6. Rearrange meatballs when oven signals and remaining time is displayed.

### Lemon/Butter Fillet of Sole

**Auto Cook Code 8**  
**Approx. Cooking Time—5 min.**  
**Makes 4 servings**

- 1/2 cup butter or margarine
- 2 tablespoons all-purpose flour
- 2 tablespoons fresh lemon juice
- 1 tablespoon parsley flakes
- 1/4 teaspoon salt
- 1/8 teaspoon pepper
- 1/4 teaspoon dill weed

Place butter in 2-qt. baking dish. Microwave at High (10) for 30-45 seconds, until melted. Blend in remaining ingredients except for fish fillets.

Coat both sides of fish with butter sauce. Arrange fillets in baking dish. Cover with plastic wrap, venting one corner about 2 inches. Microwave on Auto Cook code 8.

### Chicken Teriyaki

**Auto Cook Code 7**  
**Approx. Cooking Time—32 min.**  
**Makes 4 Servings**

- 1/4 cup soy sauce
- 1/4 cup honey
- 1/3 cup orange juice
- 1 whole chicken (about 3 lbs.)
- 1 tablespoon water
- 2 tablespoons cornstarch

In small cooking bag, mix soy sauce, honey and orange juice. Add chicken to bag and tie with plastic tie. Turn chicken on its side in 2-qt. oblong glass baking dish. Marinate 1 hour on each side. Place bird breast-side-up in dish. Slash bag near closure. Microwave on Auto Cook code 4. When oven signals, remove chicken and prepare Teriyaki sauce. In 1-pt. glass measuring cup stir together water and cornstarch. Cut off one corner of cooking bag with scissors and drain juices into cup. Microwave at High (10) 2 minutes, stirring once. Remove chicken from bag to serving platter. Pour sauce over chicken just before serving.

### Classic Ham Loaf

**Auto Cook Code 6**  
**Approx. Cooking Time—16 min.**  
**Makes 6 Servings**

- 1 lb. ground cooked ham
- 1/2 lb. ground fresh pork
- 1/2 cup soft bread crumbs
- 1/2 cup water
- 2 tablespoons instant minced onion
- 1/4 teaspoon pepper

Mix ground ham and pork thoroughly with crumbs, water, onion and pepper. Mold into flat loaf in 9-in. pie plate. Cover with plastic wrap. Microwave on Auto Cook code 6.

### Chicken and Rice

**Auto Cook Code 6**  
**Approx. Cooking Time—27 min.**  
**Makes 6 Servings**

- 1 can (10½ oz.) condensed cream of mushroom soup
- 1-1/4 cups milk (1 soup can full)
- 3/4 cup instant rice
- 1 can (4 oz.) mushrooms, stems and pieces, drained
- 1 pkg. (1½ oz.) dry onion soup mix
- 1 cut up chicken (about 3 lbs.)

In mixing bowl mix soup, milk, rice, mushrooms and onion soup mix.

Arrange chicken pieces in a 2-qt. oblong glass baking dish with meatiest pieces to outside of dish. Pour soup mixture over chicken. Cover with plastic wrap. Microwave on Auto Cook code 6.

### Swiss Steak

**Auto Cook Code 2**  
**Approx. Cooking Time—65 min.**  
**Makes 6 Servings**

- 1-1/2 lbs. round steak, 1/2-in. thick, tenderized or pounded with meat mallet
- 1/4 cup flour
- 1-1/2 teaspoons salt
- 1/8 teaspoon pepper
- 1 medium onion, sliced thin
- 1 can (16 oz.) tomatoes

Cut meat in 6 pieces and coat with mixture of flour, salt and pepper. Place in 3-qt. casserole. Cover with onion. Break up tomatoes with fork and pour over top. Cover. Microwave on Auto Cook code 2. Rearrange meat when oven signals and remaining time is displayed.

---

# Automatic Cooking Vegetables

## Fresh or Canned Vegetables

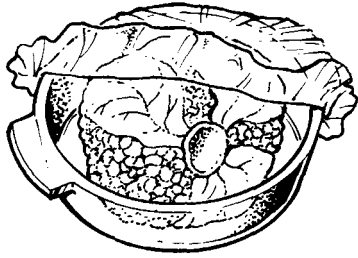

**Whole or large halves of vegetables** such as cauliflower or squash use Auto Cook code 1. Use a round container close to the size of vegetable. Add 1/2 cup water. Cover with lid or plastic wrap.

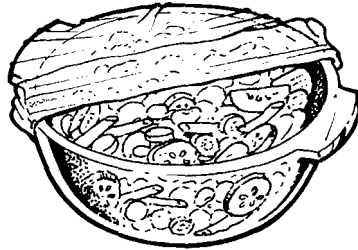

**Pieces or slices of vegetables** require 1/4 to 1/2 cup of water. Use appropriate size covered container. Microwave on Auto Cook code 1. Microwave dry root vegetables like carrots on Auto Cook code 5, stirring after oven signals and time remaining appears on display. Recover and touch START to finish cooking.

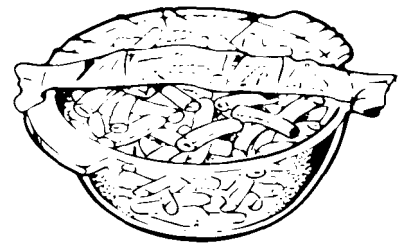

**Precooked/canned vegetables** should be placed in round container. Container should be no more than 1/3 full. Microwave on Auto Cook code 8. Stir before serving.

## Frozen Vegetables

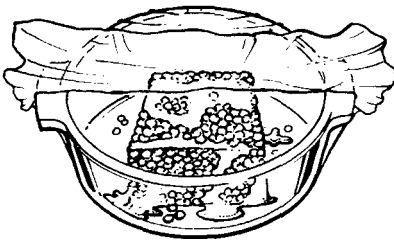

**Block or loose pieces** of frozen vegetables should be placed in suitable size container (at least half full) and covered with lid or plastic wrap. Add 1 or 2 tablespoons water. Microwave on Auto Cook code 8. Stir before serving.

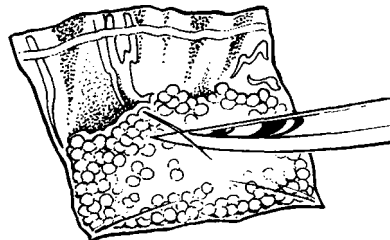

**Pouches** of frozen vegetables should be slit 1/2" in center and placed on microwave-safe plate. Microwave on Auto Cook code 1. Flex pouch before serving.

# Vegetable Recipes

## Stir Fry Vegetables

Auto Cook Code 1

Approx. Cooking Time—12 min.

Makes 4 Servings

- 1 tablespoon oil
- 1 tablespoon soft butter
- 3 medium onions, quartered
- 1 small green pepper, cut in 1/4-in. wide strips
- 2 cups thinly-sliced cabbage
- 2/3 cup carrots, sliced in thin diagonal slices
- 1/4 cup sliced green onions
- 1 cup broccoli flowerets
- 1 cup cauliflower flowerets
- 2 stalks celery, sliced diagonally

Toss vegetables with oil and butter in 3-qt. microwave-safe casserole. Cover. Microwave on Auto Cook code 1, stirring well when oven signals and time remaining appears on display. Serve immediately.

## Summer Garden Stew

Auto Cook Code 6

Approx. Cooking Time—34 min.

Makes 6 to 8 Servings

- 1 medium zucchini, cubed
- 1 large potato, peeled and cubed
- 2 large carrots, coarsely grated
- 1 small onion, cut in pieces
- 1/4 small head of cabbage, sliced
- 1 can (10 3/4 oz.) cream of mushroom soup
- 1 cup shredded cheddar cheese
- 1 can (4 oz.) mushroom pieces, drained
- 1/2 pound smoked sausage, cut in 1/4-inch pieces

**In :** 14-5-qt. deep casserole dish. mix all ingredients together until well blended. Cover. Microwave on Auto Cook code 6. Stir well before serving.

## Corn Pudding

Auto Cook Code 1

Approx. Cooking Time—9 min.

Makes 6 Servings

- 3 tablespoons butter
- 2 tablespoons flour
- 2 tablespoons sugar
- 1/2 teaspoon salt
- 1-1/4 cups milk
- 2 eggs, beaten
- 1 can (17-oz.) whole kernel corn, drained
- 3/4 cup butter flavored cracker crumbs

Melt butter in 1 - 1/2 quart casserole. Blend in flour, sugar, and salt. Stir in milk and eggs, blend well. Add corn, stir. Sprinkle cracker crumbs evenly over top. Cover. Microwave on Auto Cook code 1. When done, center will be just barely set. Let stand 5 minutes before serving.

## Eggplant Italiano

Auto Cook Code 1

Approx. Cooking Time—18 min.

Makes 4 to 6 Servings

- 1 medium eggplant
- 2 cans (8 oz. each) tomato sauce
- 1 to 2 teaspoons oregano
- 1/2 cup shredded sharp cheddar cheese
- 1 pkg. (6 oz.) Mozzarella cheese slices

Peel eggplant; slice 1/8-in. thick. Spread 2 tablespoons tomato sauce in bottom of 2-qt. casserole. Layer half of eggplant, 1 can tomato sauce, half of oregano and half of shredded cheese. Repeat layers. Cover. Microwave on Auto Cook code 1. Add Mozzarella cheese and microwave at High (10) 1 to 2 minutes, until cheese has melted.

## Green Rice

Auto Cook Code 6

Approx. Cooking Time—16 min.

Makes 4-6 Servings

- 1 pkg. (10 oz.) frozen chopped spinach, thawed
- 3/4 cup instant rice
- 2 tablespoons butter, melted
- 1/4 cup finely chopped onion
- 1 cup milk
- 2 eggs, beaten
- 1/2 teaspoon salt
- 1 cup shredded cheddar cheese

Combine rice, spinach, butter, onion, milk, egg, salt and cheese. Mix well in 2-qt. casserole. Cover and microwave on Auto Cook code 6. Remove cover after oven signals and remaining time is displayed. Continue cooking. Let stand 5 minutes, covered, before serving.

## Country Style Yellow Squash

Auto Cook Code 6

Approx. Cooking Time—25 min.

Makes 4 to 6 Servings

- 2 pounds (approx. 5 medium) yellow squash, finely chopped
- 1/4 cup onion, chopped
- 1/4 cup butter, melted
- 1 teaspoon salt
- 1/4 teaspoon pepper
- 1/4 teaspoon basil
- 5 slices fresh bread, cubed
- 1/2 cup shredded cheddar cheese
- 1 cup sour cream
- 8 strips cooked bacon, crumbled

In large mixing bowl mix all ingredients. Using 1/2 of crumbled bacon. Pour into a 2-qt. oblong glass baking dish. Sprinkle top with remaining bacon. Cover. Microwave on Auto Cook code 6.

# Automatic Cooking Fruits and Desserts

## Fruits

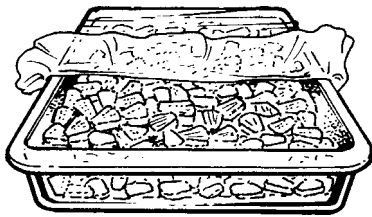

**Pineapple Casserole** is a tangy dessert or meat accompaniment. In 2-qt. oblong glass baking dish spread 2 cans (20 oz. ea. ) drained pineapple chunks.

Mix together 1 cup sugar and 1/2 cup flour. Pour mixture over pineapple and stir to evenly coat pineapple. Top with mixture of 2 cups buttery-flavored cracker crumbs and 1/2 cup melted butter. Cover with plastic wrap and cook on Auto Cook code 1.

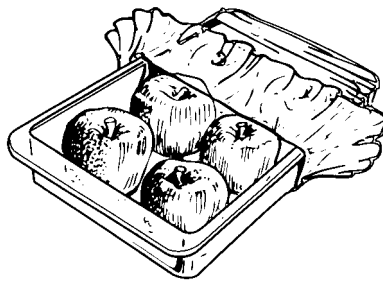

**Baked Apples** automatically cook well using Auto Cook code 8. Match number of apples to size of microwave-safe covered container. Use Auto Cook code 8 for Baked Pears also.



**Stewed Fruit and Fruit Compotes** should be stirred well before microwaving, especially if sugar is added. Cover; use Auto Cook code 1 and stir once or twice after oven signals and time appears on display. Touch START and finish cooking.

## Desserts & Breads

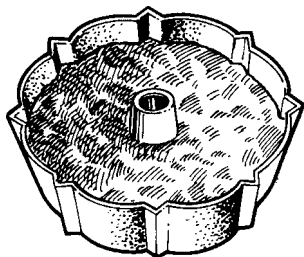

**Nut Topped Cakes** are easy to cook automatically. Grease bottom and sides of microwave-safe fluted cake container and sprinkle bottom evenly with 1/3 cup chopped nuts or coconut. Carefully pour batter from one box (2-layer size) cake mix over nuts, cover with plastic wrap. Microwave on Auto Cook code 6. Let stand 15 minutes before inverting to cool.

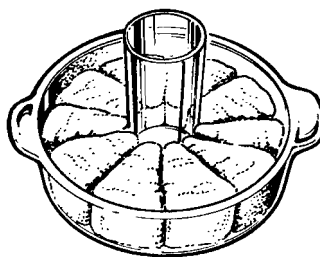

**Caramel Biscuit Ring:** Spread 1/4 cup melted butter and 1/2 cup brown sugar in 8-in. round glass dish. Sprinkle with cinnamon and 1/2 cup chopped nuts. Arrange 1 can (10 oz. ) refrigerated biscuits around edges and place drinking glass, open end up, in center. Cover with plastic wrap. Microwave on Auto Cook code 4. Invert onto serving plate, letting dish stand over ring a few minutes before removing.

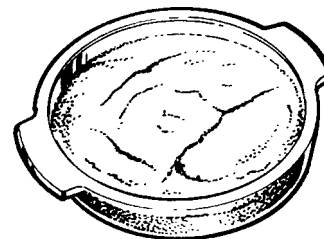

**Bacon and Cheese Topped Cornbread:** Distribute 1/2 cup chopped crisp fried bacon and 1 tablespoon Parmesan cheese in well greased 8-in. round glass dish. Carefully pour batter from 1 pkg. (8- 1/2 oz. ) cornbread mix over above ingredients. Cover with plastic wrap. Microwave on Auto Cook code 6. Rotate 1/2 turn after oven signals and time remaining appears on display. Let stand 5 to 10 minutes before inverting.

## Dessert Recipes

### Easy Chocolate Cake

Auto Cook Code 6

Approx. Cooking Time—14 min.

Makes 1 (10-in.) Tube Cake

- 1 pkg. (2-layer size) Devil's Food cake mix
- 3 eggs
- 1/2 cup cooking oil
- 1-1/3 cups water
- 1/3 cup finely chopped pecans

In large bowl, place cake mix, eggs, oil and water. Follow package recommendations for mixer speed and time.

Grease a 16-cup plastic microwave fluted or straight-sided ring mold. Sprinkle chopped nuts evenly over bottom. Pour batter over nuts.

Cover with plastic wrap and microwave on Auto Cook code 6. Let stand in dish 5 minutes before inverting.

### Cherry Cobbler

Auto Cook Code 1

Approx. Cooking Time—n min.

Makes 6 to 8 Servings

- 1 can (20-22 oz.) prepared cherry pie filling
- 2 cups dry yellow or white cake mix (1 pkg. [9 oz.] or 1/2 pkg. [17 OZ.] )
- 1/4 cup melted butter
- 1/2 cup coarsely chopped nuts
- 1 teaspoon ground cinnamon

In 8-in. square dish, spread pie filling.

In small bowl, mix together cake mix, butter, nuts, and cinnamon until crumbly. Sprinkle evenly over cherries or in three rows so cherries are visible. Cover with plastic wrap. Microwave on Auto Cook code 1.

### Mexican Bread Pudding

Auto Cook Code 6

Approx. Cooking Time—12 min.

Makes about 6 servings

- 4 cups bread cubes, loosely packed into cup
- 1/2 cup brown sugar
- 1/2 teaspoon cinnamon
- 1/4 teaspoon salt
- 1/2 cup raisins
- 1/4 cup chopped pecans
- 1/4 cup slivered almonds
- 1/4 cup Jack cheese, cubed
- 1/2 chopped apple (3/4 to 1 cup)
- 1-3/4 cups milk
- 1/4 cup butter
- 2 eggs, well beaten

Spread bread cubes evenly in 8-inch round dish. Mix sugar, cinnamon, salt, raisins, pecans, almonds, cheese and apple together. Sprinkle evenly over bread cubes.

Measure milk into 1-qt. measuring cup. Add butter. Microwave at High ( 10) 4 minutes, until butter is melted. Rapidly stir in beaten eggs with a fork and mix well. Pour over bread mixture. Cover with plastic wrap. Microwave on Auto Cook code 6.

### Streuseled Apples

Auto Cook Code 1

Approx. Cooking Time—10 min.

Makes 6 to 8 Servings

- 6 cups sliced, peeled apples
- 1/4 cup brown sugar
- 1/2 cup all-purpose flour
- 1/3 cup brown sugar
- 1/3 cup quick-cooking oats
- 1/4 cup butter
- 1/2 teaspoon cinnamon

In 8-inch square dish place apples and 1/4 cup sugar.

With pastry blender mix flour, 1/3 cup sugar, oats, butter and cinnamon until crumbly. Sprinkle over top of apples. Microwave on Auto Cook code 1.

### Pineapple Upside Down Cake

Auto Cook Code 1

Approx. Cooking Time—7 min.

Makes 1 (8-in. round) Cake

- 1/4 cup butter
- 1/3 cup brown sugar
- 1 can (8-1/4 oz.) pineapple slices, drained, reserving liquid
- 4 maraschino or candied cherries, cut in half
- 1-1/2 cups yellow cake mix
- 1 egg
- 2 tablespoons oil

Reserve liquid from pineapple slices plus water to equal 1/2 cup.

In 8-in. round dish place butter. Microwave at High ( 10) 1 minute until melted. Sprinkle sugar over butter. Drain pineapple (reserving liquid) on paper towels and arrange in dish. Decorate with cherries. Place a glass, open side up, in center of dish.

Prepare cake mix using 1 egg, 2 tablespoons oil, and reserved pineapple liquid plus water to equal 1/2 cup. Mix at high speed for 2 minutes. Carefully spread batter over fruit in dish. Cover with plastic wrap. Microwave on Auto Cook code 1.

# How to Use the Double Duty™ Shelf

- Use the shelf only when cooking foods on 2 levels.
- Do not store or cook with shelf on floor of oven. Product damage may result.
- Use pot holders when handling metal shelf and cookware. They may be hot.
- Do not store microwave browning dish on metal shelf.
- Use of DOUBLE DUTY™ shelf with Auto Cook, Auto Reheat or Popcorn program is not recommended.

The wire shelf is specifically designed for added capacity heating and reheating in your microwave oven. Now more than one food may be heated or reheated and ready to serve at the same time.

When microwaving with the oven shelf, some techniques will differ from the cookbook which came with your oven. It is important to arrange foods properly (shown on the next page). Cookware size is important; select from among the suggestions at right. Also, food size should be considered; foods over 4 inches high or 3½ pounds are not recommended for shelf cooking.

Batters and dough foods and also uncooked foods which need to be prepared from scratch should be cooked without the oven shelf, following cookbook directions.

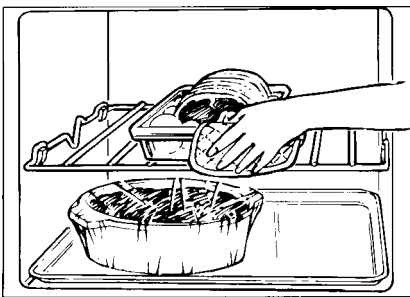

Use pot holders when handling foods heated together with your oven shelf, especially when

heating larger amounts of food. Extra steam generated from multiple food cooking may make cookware hotter than with regular microwaving.

## Cookware for Shelf Heating and Reheating

Before placing food in the dishes, check to see that they will fit together on or under the shelf. Also, be sure cookware is microwave safe.



Cookware for heating or reheating include 1 cup pleasuring cup, 9x5x3-inch loaf dishes or 9-inch pie plates.

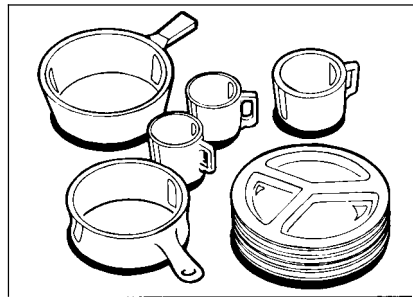

Leftovers may be placed in small individual ceramic or plastic bowls or divided plates.

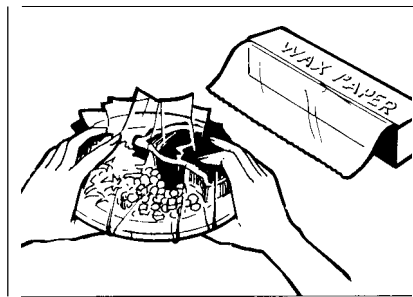

Use wax paper or plastic wrap instead of lids on casseroles. Lids may add too much height to dish.

## Positioning the Shelf

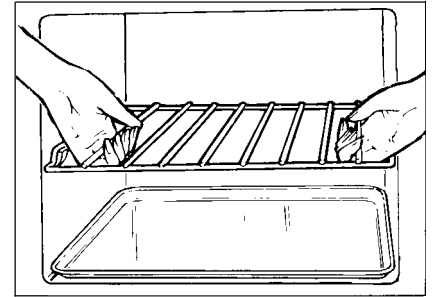

To position the DOUBLE DUTY™ shelf, tip the back slightly and fit the shelf support guides onto the support guides located on each side of the oven in the rear.

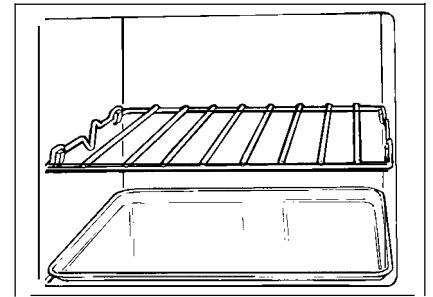

Next, lower the front until the shelf support guides fit onto the support guides located at each side of the oven in the front.

When properly positioned, the shelf should fit snugly in place, be level and not touch the back or side wall of the oven.

**If arcing occurs when using the shelf to cook more than one food at the same time, turn the oven off. Make sure the shelf is positioned right-side-up on all four shelf supports and not touching oven walls.**

## How to Heat or Reheat Similar Types of Food

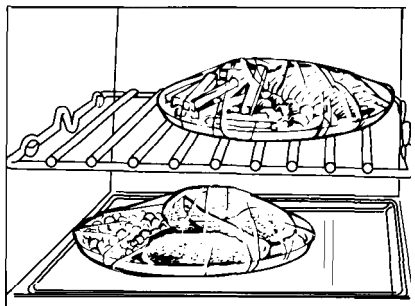

**Two plates of leftovers** may be reheated together. Arrange thick or dense foods to outside edges of plate and cover with plastic wrap. Microwave at High (10) for 3 minutes. Reverse position of plates (top to bottom) and rotate 1/2 turn. Continue microwaving at High (10) for 2 to 3 minutes. Continue heating, if necessary, until hot.

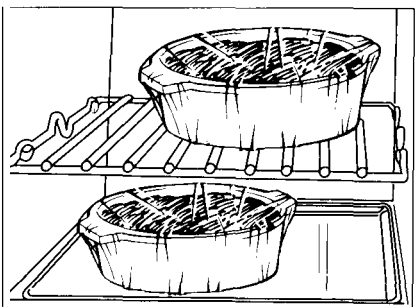

**Reheating two casseroles** (height should be less than 4 inches) is possible. Cover with plastic wrap. Use staggered arrangements of food, placing food on right side of shelf and left side of floor. Refer to Heating or Reheating Guide in cookbook for suggested microwave time per casserole and add the times together. Microwave at High (10) reversing position of foods (top to bottom) after half of time. Several small bowls of leftovers may be heated in the same way, stirring and reversing positions after half of time.

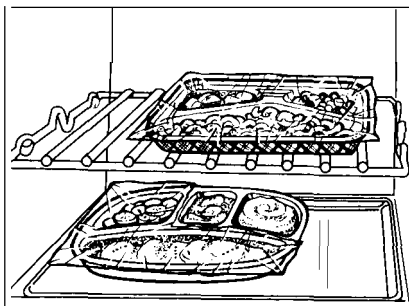

**Two frozen individual entrees (5 to 7 oz. each) or two TV dinners (10 to 12 oz. each)** are both ready to serve at the same time. Remove trays of food from their boxes. If there are foil covers, remove them and return the trays of food to their boxes. (Batter foods should be removed from the trays and cooked conventionally.) Place in oven with one TV dinner on right shelf and the second dinner on left floor. Microwave at High (10) for 8 minutes. Reverse positions (top to bottom) and rotate foods 1/2 turn. Continue microwaving at High (10) for 8 minutes. Check dinners for heating. If one dinner seems less done than desired, return it to the box and continue heating on floor 1 to 2 more minutes.

## How to Reheat Several Different Types of Foods Together

When heating several different types of food together, foods which should be served hot must be placed on the shelf, while foods which need only to be warmed should be placed on the oven floor. This is because microwave energy enters the oven from the top only. Also, it is important to remember that foods absorb microwave energy at different rates. Rates can be affected by the size of the food, and its starting temperature.

Because of the varying rates, you may need to start reheating a large or dense food a few minutes ahead of time, then add other smaller or less dense foods. Alternately, if one of the foods you are heating seems undercooked but the others are heated satisfactorily, let the underheated food continue cooking.

Heat or reheat different types of food at High (10). To determine heating times, add times for all foods together. (See heating guide in cookbook.) After half of time, stir or rearrange foods (do not reverse positions). Check foods (especially those on oven floor) after 3/4 of total time and remove any which are done. Continue cooking others.

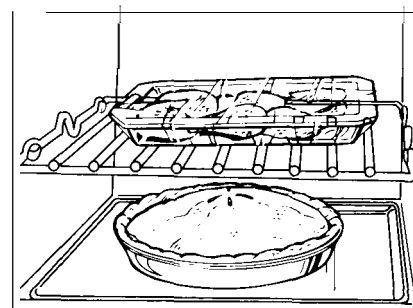

**Place on shelf large or dense food** which need the most heating, such as leftover fried chicken, casseroles of canned or leftover vegetables, rice or pasta. Place on floor those foods which need only be warmed, such as bakery pies, rolls, muffins or breads.

**Pop popcorn on the microwave oven floor only.** Popcorn placed on the oven shelf will not pop properly. Use a special microwave popcorn accessory or prepackaged popcorn labeled for use in microwave ovens.

# GROUNDING INSTRUCTIONS

This appliance must be grounded. In the event of an electrical short circuit, grounding reduces the risk of electric shock by providing an escape wire for the electric current. This' appliance is equipped with a power cord having a grounding wire with a grounding plug. The plug must be plugged into an outlet that is properly installed and grounded. (Fig. 1 )

**WARNING-improper** use of the grounding plug can result in a risk of electric shock.

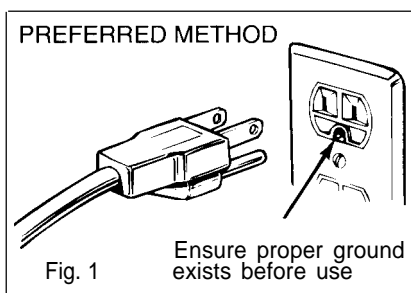

Consult a qualified electrician or service technician if the grounding instructions are not completely understood, or if doubt exists as to whether the appliance is properly grounded.

Where a standard two-prong wall receptacle is encountered, it is your personal responsibility and obligation to have it replaced with a properly grounded three-prong wall receptacle.

**Do not under any circumstances cut or remove the third (ground) prong from the power cord.**

## Use of Adapter Plugs

### Usage situations where appliance's power cord will be disconnected infrequently.

Because of potential safety hazards under certain conditions, we **strongly recommend against the use of an adapter plug.** However, if you still elect to use an adapter, where local codes permit, a **TEMPORARY CONNECTION** may be made to a properly grounded two-prong wall receptacle by the use of a UL listed adapter (Fig. 2) which is available at most local hardware stores.

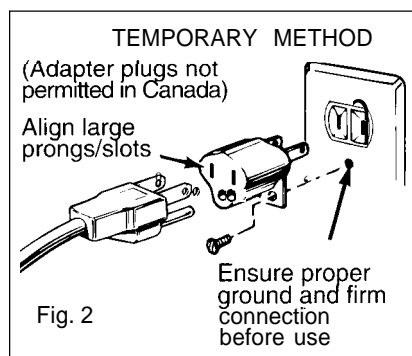

The larger slot in the adapter must be aligned with the larger slot in the wall receptacle to provide proper polarity in the connection of the power cord.

**Caution:** Attaching the adapter ground terminal to the wall receptacle cover screw does not ground the appliance unless the cover screw is metal, and not insulated, and the wall receptacle is grounded through the house wiring. You should have the circuit checked by a qualified electrician to make sure the receptacle is properly grounded.

When disconnecting the power cord from the adapter, always hold the adapter with one hand. If this is not done, the adapter ground terminal is very likely to break with repeated use. Should this happen, **DO NOT USE** the appliance until a proper ground has again been established.

### Usage situations where appliance's power cord will be disconnected frequently.

**Do not use an adapter plug in** these situations because disconnecting of the power cord places undue strain on the adapter and leads to eventual failure of the adapter ground terminal. You should have the two-prong wall receptacle replaced with a three-prong (grounding) receptacle by a qualified electrician before using the appliance.

## Use of Extension Cords

Because of potential safety hazards under certain conditions, we strongly recommend against the use of an extension cord. However, if it is necessary to use an extension cord, use only a 3-wire extension cord that has a 3-blade grounding plug, and a 3-slot receptacle that will accept the plug on the appliance. The marked rating of the extension cord shall be equal to or greater than the electrical rating of the appliance (15 amperes).

**If you do use an extension cord with your microwave oven, the interior light may flicker and the blower sound may vary when oven is in use.** Cook times may be longer as well.

A short power-supply cord is provided to reduce risks of becoming entangled in or tripping over a longer cord. Do not drape the cord over a countertop or table where it can be pulled on by children or tripped over accidentally.



# Care and Cleating

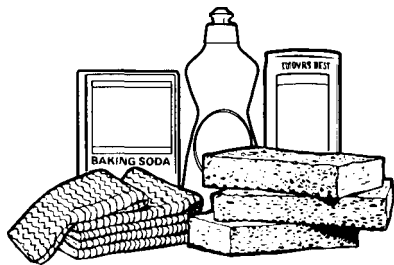

**Your new microwave oven is a valuable appliance. Protect it from misuse by following these rules:**

• **Keep your oven clean and sweet-smelling.** Opening the oven door a few minutes after cooking helps air-out the interior. An occasional thorough wiping with a solution of baking soda and water keeps the interior fresh.

• **Don't use sharp-edged utensils on your oven.** The inside and outside oven walls can be scratched. The control panel can be damaged.

**BE CERTAIN POWER IS OFF BEFORE CLEANING ANY PART OF THIS OVEN.**

## How to Clean the Inside

**Walls, floor and mode stirrer cover.** Some spatters can be removed with a paper towel, others may require a damp cloth. Remove greasy spatters with a sudsy cloth, then rinse with a damp cloth. Do not use abrasive cleaners on oven walls. **NEVER USE A COMMERCIAL OVEN CLEANER ON ANY PART OF YOUR MICROWAVE OVEN.**

**Door (inside). Window:** Wipe up spatters daily and wash when soiled with a damp cloth. Rinse thoroughly and dry.

Metal and plastic parts on door: Wipe frequently with a damp cloth to remove all soil. **DO NOT USE ABRASIVES, SUCH AS CLEANING POWDERS OR STEEL AND PLASTIC PADS. THEY WILL MAR THE SURFACE.**

**Glass Cooking Tray.** Occasionally it is necessary to remove the cooking tray for cleaning of the tray or oven. To prevent breakage, do not place tray into water just after cooking. Wash it carefully in warm, sudsy water or in the dishwasher. The tray can be broken if dropped. Remember, do not operate the oven without the cooking tray in place.

**Special note when using Brown 'N Sear Dish:** If grease is present, high heat generated on bottom of a Brown 'N Sear dish may cause the grease to burn onto the oven tray. This may be removed with a cleanser such as Bon Ami® brand cleanser.

After using Bon Ami® brand cleanser, rinse and dry thoroughly, following instructions on can. Do not use Bon Ami® brand cleanser on the painted surfaces such as the walls. It may scratch the paint.

**Automatic Temperature Probe.** Probe is sturdy, but care should be taken in handling. Do not twist or bend; avoid dropping temperature probe.

Clean as soon after using as possible. To clean, wipe with sudsy cloth, then rub lightly with plastic scouring ball if necessary. Rinse and dry or wash in dishwasher.

**DOUBLE DUTY™ shelf.** Your shelf accessory is designed for use in a microwave oven only; do not use in a conventional oven. Do not use a browning dish with the shelf. Arcing could occur.

Clean shelf with mild soap and water or in the dishwasher. **Do not clean shelf in a self-cleaning oven.**

## How to Clean the Outside

**Case.** Clean the outside of your oven with soap and damp cloth, rinse with a damp cloth and then dry. Wipe the window clean with a damp cloth. Chrome trim is best wiped with a damp cloth and then with a dry towel.

**Control Panel.** Wipe with a damp cloth. Dry thoroughly. Do not use cleaning sprays, large amounts of soap and water, abrasives, or sharp objects on the panel—they can damage it.

**Door Surface.** When cleaning surfaces of door and oven that come together on closing the door, use only mild, non-abrasive soaps or detergents applied with a sponge or soft cloth.

**Power Cord.** If the cord becomes soiled, unplug and wash with damp cloth. For stubborn spots, sudsy water may be used, but be certain to rinse with a damp cloth and dry thoroughly before plugging cord into outlet.

## Oven Lamp Replacement

First unplug the oven. Then remove lamp compartment cover by removing screw which holds cover in place. Cover is located on the back of the outer case.

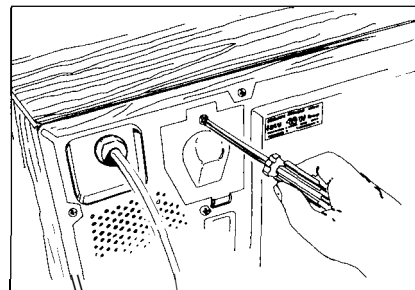

Replace with 40-watt appliance bulb. (It is available in drug and hardware stores.) Replace compartment cover. Plug in the oven.



## Questions? Use This Problem Solver

PROBLEM	POSSIBLE CAUSE AND REMEDY
OVEN WILL NOT COME ON	<ul style="list-style-type: none"><li>• A fuse in your home may be blown or the circuit breaker tripped. Replace fuse or reset circuit breaker.</li><li>• Unplug your microwave oven, then plug it back in.</li><li>• Make sure 3-prong plug on oven is fully inserted into wall receptacle.</li></ul>
CONTROL PANEL LIGHTED, YET OVEN WILL NOT START	<ul style="list-style-type: none"><li>• Door not securely closed.</li><li>• START must be touched after entering cooking selection.</li><li>• Another selection entered already in oven and CLEAR/OFF pad not touched to cancel it.</li><li>• Make sure you have entered cooking time after touching TIME COOK 1 &amp; 11.</li><li>• CLEAR/OFF pad was touched accidentally. Reset cooking program and touch START pad.</li><li>• Make sure you have entered a temperature after touching TEMP COOK &amp; HOLD.</li><li>• Make sure you entered a code number after touching AUTO COOK or AUTO ROAST.</li></ul>
FOODS ARE EITHER OVERCOOKED OR UNDERCOOKED	<ul style="list-style-type: none"><li>• Cooking times may vary because of starting food temperature, food density or amount of foods in oven. Touch TIME COOK I &amp; 11 pad and additional cooking time for completion.</li><li>• Incorrect power level entered. Check cookbook for recommended power level.</li><li>• Dish was not rotated, turned or stirred. Some dishes require specific instructions. Check cookbook or recipe for instructions.</li><li>• Too many dishes in oven at same time. Cooking time must be increased when cooking more than one food item. Check cookbook time recommendations.</li><li>• Dish not completely covered as directed during Auto Cook.</li><li>• Previous microwaving left humidity or moisture in oven, thus lessening the cooking time in Auto Cook function.</li><li>• Certain vegetables need a standing time after using Auto Cook. Check Automatic Cooking Guide.</li><li>• Probe not inserted properly into meat or dish when using Temp Cook &amp; Hold or Auto Roast functions. Check cookbook for specific instructions.</li></ul>
“PROBE” APPEARS ON DISPLAY	<ul style="list-style-type: none"><li>• Probe has been forgotten or not seated properly in oven wall when using Temp Cook &amp; Hold or Auto Roast functions.</li></ul>
“Error” APPEARS ON DISPLAY	<ul style="list-style-type: none"><li>• During Auto Cook, Auto Reheat or Popcorn program, the door was opened before steam could be detected or steam was not detected in maximum time.</li><li>• No steam was detected by sensor within four minutes and 10 seconds after start of Popcorn program.</li></ul>

### All these things are normal with your microwave oven:

- Steam or vapor escaping from around the door.
- Light reflection around door or outer case.
- Dimming oven light and change in blower sound may occur while operating at power levels other than high.
- Dull thumping sound while oven is operating.
- Some TV-Radio interference might be noticed while using your microwave oven. It's similar to the interference caused by other small appliances and does not indicate a problem with your oven.

If you need more help...call, toll free: GE Answer Center® / 800.626.2000/ consumer information service



# YOUR GE MICROWAVE OVEN WARRANTY

Save proof of original purchase date such as your sales slip or cancelled check to establish warranty period.

## WHAT IS COVERED

### FULL ONE-YEAR WARRANTY

For one year from date of original purchase, we will provide, free of charge, parts and service labor in your home to repair or replace **any part of the microwave oven** that fails because of a manufacturing defect.

### LIMITED ADDITIONAL NINE-YEAR WARRANTY

For the second through tenth year from date of original purchase, we will provide, free of charge, a replacement **magnetron tube** if the magnetron tube fails because of a manufacturing defect. You pay for the service trip to your home and service labor charges.

This warranty is extended to the original purchaser and any succeeding owner for products purchased for ordinary home use in the 48 mainland states, Hawaii and Washington, D.C. In Alaska the warranty is the same except that it is LIMITED because you must pay to ship the product to the service shop or for the service technician's travel costs to your home.

All warranty service will be provided by our Factory Service Centers or by our authorized Customer Care™ servicers during normal working hours.

Look in the White or Yellow Pages of your telephone directory for GENERAL ELECTRIC COMPANY, GENERAL ELECTRIC FACTORY SERVICE, GENERAL ELECTRIC-HOTPOINT FACTORY SERVICE or GENERAL ELECTRIC CUSTOMER CARE® SERVICE.

## WHAT IS NOT COVERED

•Service trips to your home to teach you how to use the product.

### Read your Use and Care material.

If you then have any questions about operating the product, please contact your dealer or our Consumer Affairs office at the address below, or call, toll free:

GE Answer Center™  
800.626.2000  
consumer information service

•Improper installation.

If you have an installation problem, contact your dealer or installer. You are responsible for providing adequate electrical, gas, exhausting and other connecting facilities.

•Replacement of house fuses or resetting of circuit breakers.

•Failure of the product if it is used for other than its intended purpose or used commercially.

•Damage to product caused by accident, fire, floods or acts of God.

WARRANTOR IS NOT RESPONSIBLE FOR CONSEQUENTIAL DAMAGES.

Some states do not allow the exclusion or limitation of incidental or consequential damages, so the above limitation or exclusion may not apply to you. This warranty gives you specific legal rights, and you may also have other rights which vary from state to state. To know what your legal rights are in your state, consult your local or state consumer affairs office or your state's Attorney General.

**Warrantor: General Electric Company**

**If further help is needed concerning this warranty, write:  
Manager—Consumer Affairs, GE Appliances, Louisville, KY 40225**

Part No. 164 D2588P007

Pub. No. 49-8210

**JE1468K**

## Free Manuals Download Website

<http://myh66.com>

<http://usermanuals.us>

<http://www.somanuals.com>

<http://www.4manuals.cc>

<http://www.manual-lib.com>

<http://www.404manual.com>

<http://www.luxmanual.com>

<http://aubethermostatmanual.com>

Golf course search by state

<http://golfingnear.com>

Email search by domain

<http://emailbydomain.com>

Auto manuals search

<http://auto.somanuals.com>

TV manuals search

<http://tv.somanuals.com>