







650 Watts
Models: JE610
JE620

Sub-Compact Microwave Oven

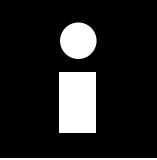
Owner's Manual

	<i>Important Safety Information</i> <i>Precautions to Avoid Possible Exposure to Excessive Microwave Energy2</i> <i>Special Notes About Microwaving6</i>	2
	<i>Operating Instructions</i> <i>Features of Your Microwave11</i> <i>The Controls on Your Microwave12</i> <i>Time Cooking15</i> <i>Other Features20</i>	11
	<i>Helpful Information</i> <i>Care and Cleaning22</i>	21
	<i>If Something Goes Wrong</i> <i>Before You Call For Service24</i> <i>GE Service Numbers26</i> <i>WarrantyBack Cover</i>	24

GE Appliances



Important Safety Information

Read all safety information before using

For Your Safety

! PRECAUTIONS TO AVOID POSSIBLE EXPOSURE TO EXCESSIVE MICROWAVE ENERGY

For your safety the information in this manual must be followed to minimize the risk of fire or explosion or to prevent property damage, personal injury or loss of life.

Do Not Attempt to operate this oven with the door open since open-door operation can result in harmful exposure to microwave energy. It is important not to defeat or tamper with the safety interlocks.

Do Not Place any object between the oven front face and the door or allow soil or cleaner residue to accumulate on sealing surfaces.

Do Not Operate the oven if it is damaged. It is particularly important that the oven door close properly and that there is no damage to the:

- 1** door (bent),
- 2** hinges and latches (broken or loosened),
- 3** door seals and sealing surfaces.

The Oven Should Not be adjusted or repaired by anyone except properly qualified service personnel.

Welcome

Welcome to the GE family. We're proud of our quality products and we believe in dependable service. You'll see it in this easy-to-use manual and you'll hear it in the friendly voices of our customer service department.

Best of all, you'll experience these values each time you use your microwave. That's important, because your new microwave will be part of your family for a long time.

Start Here!

*Before
using
your
microwave
oven*

Staple your receipt to the inside back cover of this manual.

Write down the model and serial numbers here. They are on a label inside the oven.

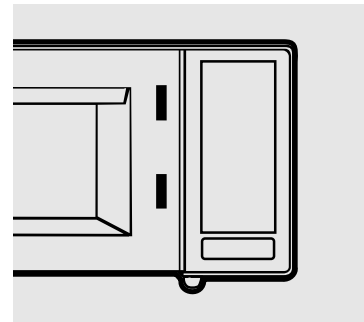

Model number

Serial number

Date of purchase

Need Help?

Before you call for service, there are a few things you can do to help us serve you better.

Read this manual. It contains instructions to help you use and maintain your microwave properly.

If you received a damaged oven...

Immediately contact the dealer (or builder) that sold you the oven.

Save time and money. Check the section titled "If Something Goes Wrong" before calling. This section was designed to solve common problems you might encounter.

If you do need service, you can relax knowing help is only a phone call away. A list of toll-free customer service numbers is included in the back of this book.



Important Safety Information

Read all safety information before using

! WARNING

When using electrical appliances, basic safety precautions should be followed, including the following:

Safety Precautions

This microwave oven is not approved or tested for marine use.

- Read and follow the specific “Precautions to Avoid Possible Exposure to Excessive Microwave Energy” section on page 2.
- This appliance must be grounded. Connect only to properly grounded outlet. See Grounding Instructions section on pages 9-10.
- Do not mount this appliance over a sink.
- Install or locate this appliance only in accordance with the provided Installation Instructions.
- Be certain to place the front surface of the door 3” or more back from the countertop edge to avoid accidental tipping of the appliance in normal usage.
- Do not mount the microwave oven over or near any portion of a heating or cooking appliance.
- Do not store anything directly on top of the microwave oven surface when the microwave oven is in operation.
- Do not cover or block any openings on the appliance.
- Do not operate this appliance if it has a damaged power cord or plug, if it is not working properly, or if it has been damaged or dropped. If the power cord is damaged, it must be replaced by General Electric Service or an authorized service agent using a power cord available from General Electric.
- Use this appliance only for its intended use as described in this manual. Do not use corrosive chemicals or vapors in this appliance. This microwave oven is specifically designed to heat or cook food, and is not intended for laboratory or industrial use.
- Do not store this appliance outdoors. Do not use this product near water—for example, in a wet basement, near a swimming pool, near a sink or in similar locations.
- Keep power cord away from heated surfaces.
- Do not immerse power cord or plug in water.
- Do not let power cord hang over edge of table or counter.



- To reduce the risk of fire in the oven cavity:
 - Do not overcook food. Carefully attend appliance when paper, plastic or other combustible materials are placed inside the oven while cooking.
 - Remove wire twist ties and metal handles from paper or plastic containers before placing them in the oven.
 - Do not use the oven for storage purposes. Do not leave paper products, cooking utensils or food in the oven when not in use.
 - If materials inside oven ignite, keep the oven door closed, turn the oven off and disconnect the power cord, or shut off power at the fuse or circuit breaker panel. If the door is opened, the fire may spread.
- See door surface cleaning instructions in the Care and Cleaning section(s) of this manual.
- This appliance must only be serviced by qualified service personnel. Contact nearest authorized service facility for examination, repair or adjustment.
- As with any appliance, close supervision is necessary when used by children.

SAVE THESE INSTRUCTIONS



Important Safety Information

Special Notes About Microwaving

Arcing

If you see arcing, press the CLEAR/OFF pad and correct the problem.

Arcing is the microwave term for sparks in the oven. Arcing is caused by:

- Metal or foil touching the side of the oven.
- Foil not molded to food (upturned edges act like antennas).
- Metal, such as twist ties, poultry pins, or gold-rimmed dishes, in the microwave.
- Recycled paper towels containing small metal pieces being used in the microwave.

Foods

- Do not pop popcorn in your microwave oven unless in a special microwave popcorn accessory or unless you use popcorn labeled for use in microwave ovens.
- Some products such as whole eggs and sealed containers—for example, closed jars—are able to explode and should not be heated in this microwave oven. Such use of the microwave oven could result in injury.
- Do not boil eggs in a microwave oven. Pressure will build up inside egg yolk and will cause it to burst, possibly resulting in injury.
- Operating the microwave with no food inside for more than a minute or two may cause damage to the oven and could start a fire. It increases the heat around the magnetron and can shorten the life of the oven.
- Foods with unbroken outer “skin” such as potatoes, hot dogs, sausages, tomatoes, apples, chicken livers and other giblets, and egg yolks should be pierced to allow steam to escape during cooking.
- Avoid heating baby food in glass jars, even with the lid off. Make sure all infant food is thoroughly cooked. Stir food to distribute the heat evenly. Be careful to prevent scalding when warming formula or breast milk. The container may feel cooler than the milk really is. Always test the milk before feeding the baby.



SAFETY FACT

SUPERHEATED WATER

Liquids, such as water, coffee or tea are able to be overheated beyond the boiling point without appearing to be boiling. Visible bubbling or boiling when the container is removed from the microwave oven is not always present. THIS COULD RESULT IN VERY HOT LIQUIDS SUDDENLY BOILING OVER WHEN THE CONTAINER IS DISTURBED OR A SPOON OR OTHER UTENSIL IS INSERTED INTO THE LIQUID.

To reduce the risk of injury to persons:

- Do not overheat the liquid.
- Stir the liquid both before and halfway through heating it.
- Do not use straight-sided containers with narrow necks.
- After heating, allow the container to stand in the microwave oven for a short time before removing the container.
- Use extreme care when inserting a spoon or other utensil into the container.

- Don't defrost frozen beverages in narrow-necked bottles (especially carbonated beverages). Even if the container is opened, pressure can build up. This can cause the container to burst, possibly resulting in injury.
- Hot foods and steam can cause burns. Be careful when opening any containers of hot food, including popcorn bags, cooking pouches and boxes. To prevent possible injury, direct steam away from hands and face.
- Do not overcook potatoes. They could dehydrate and catch fire, causing damage to your oven.
- Cook meat and poultry thoroughly—meat to at least an INTERNAL temperature of 160°F and poultry to at least an INTERNAL temperature of 180°F. Cooking to those temperatures usually protects against food-borne illness.



Important Safety Information

Special Notes About Microwaving

Microwave-Safe Cookware

If you use a meat thermometer while cooking, make sure it is safe for use in microwave ovens.



How to Test for a Microwave-Safe Dish

Make sure all cookware used in your microwave oven is suitable for microwaving. Most glass casseroles, cooking dishes, measuring cups, custard cups, pottery or china dinnerware which does not have metallic trim or glaze with a metallic sheen can be used. Some cookware is labeled “suitable for microwaving.”

- If you are not sure if a dish is microwave-safe, use this test: Place in the oven both the dish you are testing and a glass measuring cup filled with 1 cup of water—set the measuring cup either in or next to the dish. Microwave 1 minute at high. If the dish heats, it should not be used for microwaving. If the dish remains cool and only the water in the cup heats, then the dish is microwave-safe.
- Do not use recycled paper products. Recycled paper towels, napkins and waxed paper can contain metal flecks which may cause arcing or ignite. Paper products containing nylon or nylon filaments should be avoided, as they may also ignite.
- Some styrofoam trays (like those that meat is packaged on) have a thin strip of metal embedded in the bottom. When microwaved, the metal can burn the floor of the oven or ignite a paper towel.
- Do not use the microwave to dry newspapers.
- Not all plastic wrap is suitable for use in microwave ovens. Check the package for proper use.
- Paper towels, waxed paper and plastic wrap can be used to cover dishes in order to retain moisture and prevent spattering. Be sure to vent plastic wrap so steam can escape.
- Cookware may become hot because of heat transferred from the heated food. Pot holders may be needed to handle the cookware.
- “Boilable” cooking pouches and tightly closed plastic bags should be slit, pierced or vented as directed by package. If they are not, plastic could burst during or immediately after cooking, possibly resulting in injury. Also, plastic storage containers should be at least partially uncovered because they form a tight seal. When cooking with containers tightly covered with plastic wrap, remove covering carefully and direct steam away from hands and face.
- Use foil only as directed in this guide. TV dinners may be microwaved in foil trays less than 3/4” high; remove the top foil cover and return the tray to the box. When using foil in the microwave oven, keep the foil at least 1” away from the sides of the oven.



- **Plastic cookware**—Plastic cookware designed for microwave cooking is very useful, but should be used carefully. Even microwave-safe plastic may not be as tolerant of overcooking conditions as are glass or ceramic materials and may soften or char if subjected to short periods of overcooking. In longer exposures to overcooking, the food and cookware could ignite.

Follow these guidelines:

- 1** Use microwave-safe plastics only and use them in strict compliance with the cookware manufacturer's recommendations.
- 2** Do not microwave empty containers.
- 3** Do not permit children to use plastic cookware without complete supervision.

Grounding Instructions

Grounding Instructions

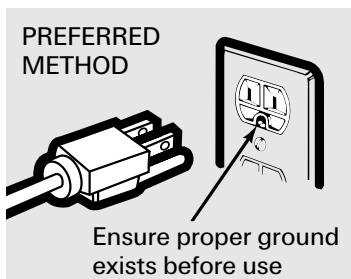

⚠ WARNING—
Improper use of the grounding plug can result in a risk of electric shock.

This appliance must be grounded. In the event of an electrical short circuit, grounding reduces the risk of electric shock by providing an escape wire for the electric current. This appliance is equipped with a power cord having a grounding wire with a grounding plug. The plug must be plugged into an outlet that is properly installed and grounded.

Consult a qualified electrician or service technician if the grounding instructions are not completely understood, or if doubt exists as to whether the appliance is properly grounded.

If the outlet is a standard 2-prong wall outlet, it is your personal responsibility and obligation to have it replaced with a properly grounded 3-prong wall outlet.

Do not under any circumstances cut or remove the third (ground) prong from the power cord.

We do not recommend using an extension cord with this appliance. If the power cord is too short, have a qualified electrician or service technician install an outlet near the appliance. (See “Use of Extension Cords” section.)

For best operation, plug this appliance into its own electrical outlet to prevent flickering of lights, blowing of fuse or tripping of circuit breaker.



Important Safety Information

Grounding Instructions

Use of Adapter Plugs

(Adapter plugs not permitted in Canada)

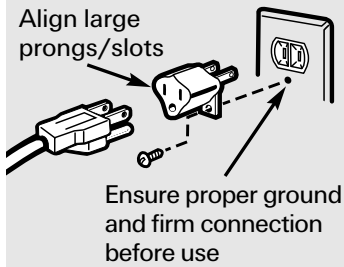

TEMPORARY METHOD

Usage situations where appliance's power cord will be disconnected infrequently.

Because of potential safety hazards under certain conditions, **we strongly recommend against the use of an adapter plug.** However, if you still elect to use an adapter, where local codes permit, a **TEMPORARY CONNECTION** may be made to a properly grounded 2-prong wall receptacle by the use of a UL listed adapter which is available at most local hardware stores.

The larger slot in the adapter must be aligned with the larger slot in the wall receptacle to provide proper polarity in the connection of the power cord.

CAUTION: Attaching the adapter ground terminal to the wall receptacle cover screw does not ground the appliance unless the cover screw is metal, and not insulated, and the wall receptacle is grounded through the house wiring.

You should have the circuit checked by a qualified electrician to make sure the receptacle is properly grounded.

When disconnecting the power cord from the adapter, always hold the adapter with one hand. If this is not done, the adapter ground terminal is very likely to break with repeated use. Should this happen, **DO NOT USE** the appliance until a proper ground has again been established.

Usage situations where appliance's power cord will be disconnected frequently.

Do not use an adapter plug in these situations because frequent disconnection of the power cord places undue strain on the adapter and leads to eventual failure of the adapter ground terminal. You should have the 2-prong wall receptacle replaced with a 3-prong (grounding) receptacle by a qualified electrician before using the appliance.

Use of Extension Cords

A short power-supply cord is provided to reduce the risks resulting from becoming entangled in or tripping over a longer cord.

Extension cords may be used if you are careful in using them.

If an extension cord is used—

1 The marked electrical rating of the extension cord should be at least as great as the electrical rating of the appliance;

2 The extension cord must be a grounding-type 3-wire cord and it must be plugged into a 3-slot outlet;

3 The extension cord should be arranged so that it will not drape over the counter top or tabletop where it can be pulled on by children or tripped over unintentionally.

If you use an extension cord, the interior light may flicker and the blower sound may vary when the microwave oven is on. Cooking times may be longer, too.

Operating Instructions

Features of Your Microwave

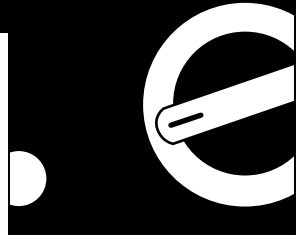

Features

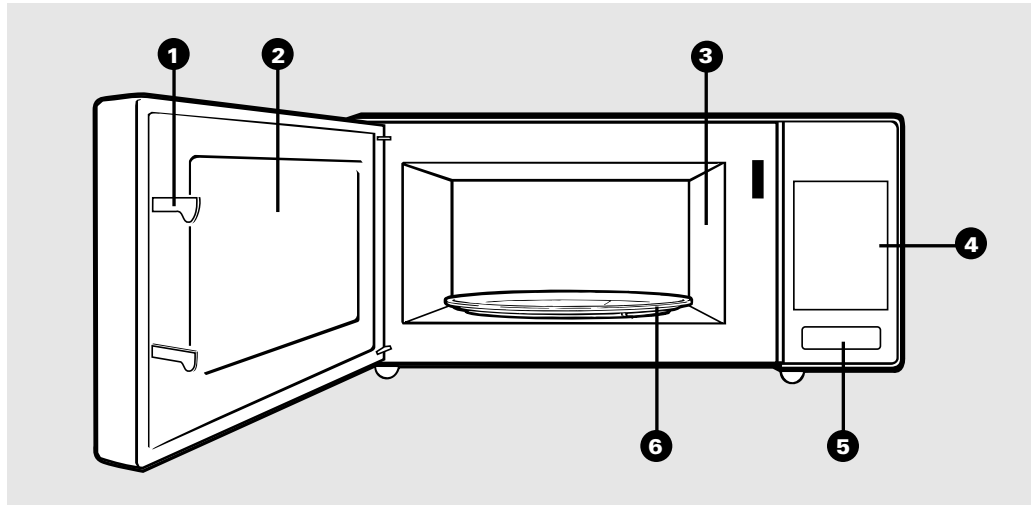

**Wattage:
650 Watts**

**Optional Accessory
(Available at extra cost
from your GE supplier):
4-A019-3 Hanging Kit
allows this oven to be
mounted under a cabinet.**

1 Door Latches.

2 Window with Metal Shield. Screen allows cooking to be viewed while keeping microwaves confined in the oven.

3 Waveguide Cover (on some models). Protects the microwave energy distributing system. Do not remove this cover. You will damage the oven.

4 Control Panel Display (panel layout will vary by model).

5 Door Open Bar. Press to open door. Door must be securely latched for oven to operate.

6 Removable Turntable. Turntable and support **must** be in place when using the oven. The turntable may be removed for cleaning.

NOTE: Rating plate, oven vent(s) and the oven interior light (on some models) are located on the inside walls of the microwave oven.



Quick Start *(Features and appearance vary by model)*

*The
controls
on your
microwave
oven*

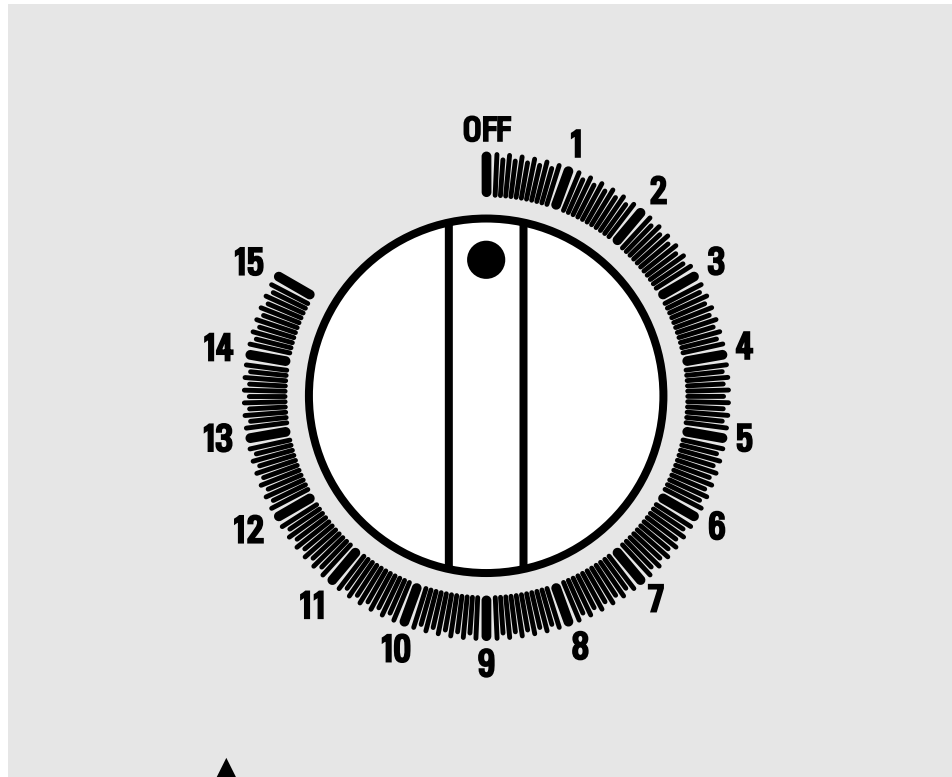

1 *Timer*

Allows you to cook by time for up to 15 minutes.



GUIDES IN BOOK

- Cooking
- Defrosting
- Heating and Reheating

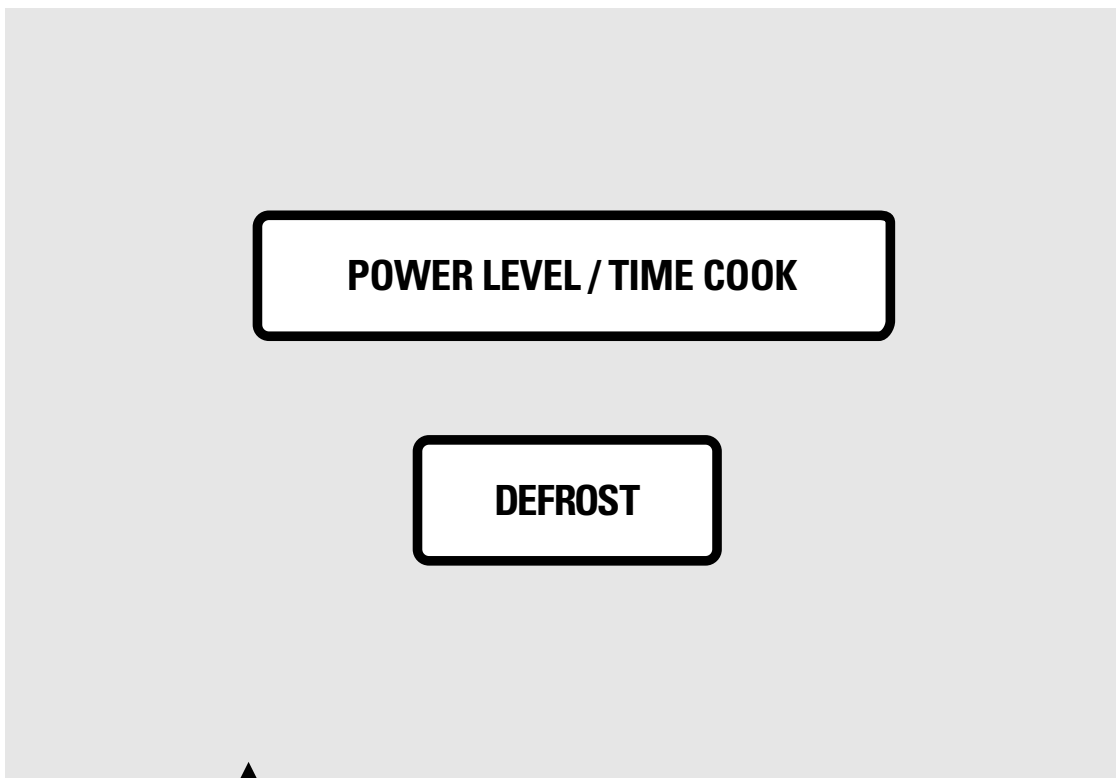

2 *Time Features*

Allows you to cook by time.

<i>Press</i>	<i>Enter</i>
POWER LEVEL/TIME COOK (press one to ten times to choose power level)	Amount of cooking time.
DEFROST	Amount of defrosting time.



Operating Instructions

Changing Power Levels

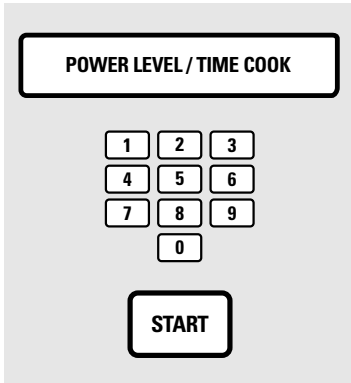

How to Change the Power Level

The power level may be changed before setting the cooking time.

- 1 Press POWER LEVEL/TIME COOK one to ten times to choose a power level other than Hi.
- 2 Enter cooking time.
- 3 Press START.

Variable power levels add flexibility to your microwave cooking. The power levels on your microwave oven can be compared to the surface units on a range. Hi or full power is the fastest way to cook and gives you 100% power. Each power level gives you microwave energy a certain percent of the time. Power Level 70 is microwave energy 70% of the time. Power Level 30 is energy 30% of the time.

Power Level Hi will cook faster but food may need additional attention such as frequent stirring, rotating or turning over. Most of your cooking will be done on Hi. A lower setting will cook more evenly and with less attention given to stirring or rotating the food. Some foods may have better flavor, texture or appearance if one of the lower settings is used. You may wish to use a lower power level when cooking foods that have a tendency to boil over, such as scalloped potatoes.

Rest periods (when the microwave energy cycles off) give time for the food to “equalize” or transfer heat to the inside of the food. An example of this is shown with Power Level 30—the defrost cycle. If microwave energy did not cycle off, the outside of the food would cook before the inside was defrosted.

Here are some examples of uses for various power levels:

Power Level	Best Uses
Hi	Fish, bacon, vegetables, boiling liquids.
Med-High 70	Gentle cooking of meat and poultry; baking casseroles and reheating.
Medium 50	Slow cooking and tenderizing such as stews and less tender cuts of meat.
Low 30	Defrosting without cooking; simmering; delicate sauces.
Warm 10	Keeping food warm without overcooking; softening butter.



Time Features (vary by model)

Timer Cooking (on some models)

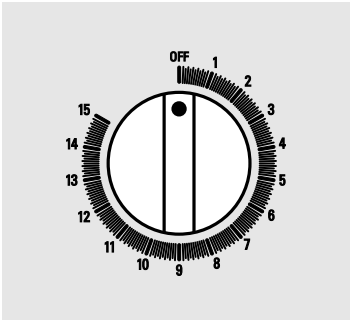

Turn the dial for up to 15 minutes of cooking time.

Allows you to microwave for up to 15 minutes.

You may open the door during Timer cooking to check the food. Close the door and cooking resumes automatically.

Popcorn Tip

For best results when cooking microwave popcorn, turn under the ends of the popcorn bag. This allows the bag to rotate properly in the oven.

Time Cook (on some models)

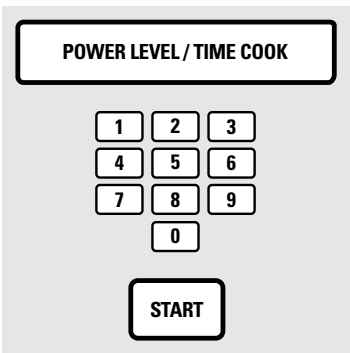

1 Press POWER LEVEL/TIME COOK one to ten times to choose a power level other than Hi.

2 Enter cooking time.

3 Press START.

Allows you to microwave for up to 99 minutes and 99 seconds.

Power Level Hi is automatically set, but you may change it for more flexibility.

You may open the door during Time Cook to check the food. Close the door and press START to resume cooking.

Popcorn Tip

For best results when cooking microwave popcorn, turn under the ends of the popcorn bag. This allows the bag to rotate properly in the oven.



Operating Instructions

Cooking Guide for Timer Cooking and Time Cook

Fresh Vegetables

For frozen vegetables, follow the instructions on the package. Place a 10 oz. package in a 1-qt. casserole and add 2–4 tablespoons of water. Turn the dish after half of time.

NOTE: Use Power Level Hi unless otherwise noted.

Vegetable	Amount	Time	Comments
Green Beans	1 lb. cut in half	13 to 17 min.	In 1-1/2-qt. casserole, place 1/2 cup water.
Whole Beets	1 bunch	20 to 25 min.	In 2-qt. casserole, place 1/2 cup water.
Broccoli (chopped)	1 bunch (1-1/4 to 1-1/2 lbs.)	8 to 10 min.	In 2-qt. casserole, place 1/2 cup water.
(spears)	1 bunch (1-1/4 to 1-1/2 lbs.)	10 to 13 min.	In 2-qt. casserole, place 1/4 cup water.
Cabbage Wedges		14 to 16 min.	In 2-qt. casserole, place 1/4 cup water.
Sliced Carrots	1 lb.	7 to 9 min.	In 1-1/2-qt. casserole, place 1/4 cup water.
Cauliflower Flowerets	1 medium head	10 to 14 min.	In 2-qt. casserole, place 1/2 cup water.
Corn on the Cob	1 to 5 ears	4 to 5 min. per ear	In 2-qt. casserole, place corn. If corn is in husk, use no water; if corn has been husked, add 1/4 cup water. Rearrange after half of time.
Shelled Peas	2 lbs. unshelled	10 to 12 min.	In 1-qt. casserole, place 1/4 cup water.
Potatoes (cubed, white)	4 potatoes (6 to 8 oz. each)	12 to 14 min.	Peel and cut into 1-inch cubes. Place in 2-qt. casserole with 1/2 cup water. Stir after half of time.
(whole, sweet or white)	1 (6 to 8 oz.)	3 to 5 min.	Pierce with cooking fork. Place in center of the oven. Let stand 5 minutes.
Spinach	10 to 16 oz.	6 to 8 min.	In 2-qt. casserole, place washed spinach.
Squash (summer and yellow)	1 lb. sliced	5 to 7 min.	In 1-1/2-qt. casserole, place 1/4 cup water.
(winter, acorn butternut)	1 to 2 squash (about 1 lb. each)	8 to 11 min.	Cut in half and remove fibrous membranes. In 2-qt. casserole, place squash cut-side-down. Turn cut-side-up after 4 minutes.



Time Features

Defrost

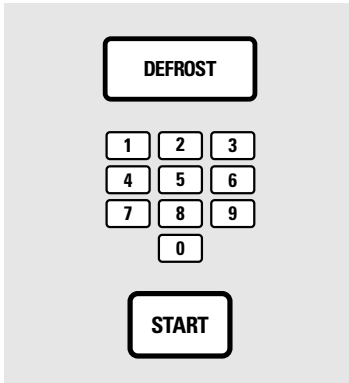

- 1 Press **DEFROST**.
- 2 Enter defrosting time.
- 3 Press **START**.

Allows you to defrost for the length of time you select. See the Defrosting Guide for suggested times.

A dull thumping noise may be heard during defrosting. This sound is normal when the oven is not operating at Hi power.

Defrosting Tips

- Foods frozen in paper or plastic can be defrosted in the package. Tightly closed packages should be slit, pierced or vented **AFTER** food has partially defrosted. Plastic storage containers should be at least partially uncovered.
- Family-size, prepackaged frozen dinners can be defrosted and microwaved. If the food is in a foil container, transfer it to a microwave-safe dish.
- Foods that spoil easily, such as milk, eggs, fish, stuffings, poultry and pork, should not be allowed to sit out for more than one hour after defrosting. Room temperature promotes the growth of harmful bacteria.
- Be sure large meats are completely defrosted before cooking.
- When defrosted, food should be cool but softened in all areas. If still slightly icy, return to the microwave very briefly, or let it stand a few minutes.



Operating Instructions

Defrosting Guide

Food	Time	Comments
Breads, Cakes		
Bread, buns or rolls (1 piece)	1 min.	
Sweet Rolls (approx. 12 oz.)	4 to 6 min.	Rearrange after half the time.
Fish and Seafood		
Fillets , frozen (1 lb.)	9 to 12 min.	
Shellfish , small pieces (1 lb.)	6 to 8 min.	Place block in casserole. Turn over and break up after half the time.
Fruit		
Plastic pouch —1 to 2 (10-oz. package)	4 to 7 min.	
Meat		
Bacon (1 lb.)	4 to 6 min.	Place unopened package in oven. Let stand 5 minutes after defrosting.
Franks (1 lb.)	4 to 6 min.	Place unopened package in oven. Microwave just until franks can be separated. Let stand 5 minutes, if necessary, to complete defrosting.
Ground meat (1 lb.)	6 to 8 min.	Turn meat over after half the time.
Roast : beef, lamb, veal, pork	12 to 16 min. per lb.	Place unwrapped meat in cooking dish. Turn over after half the time and shield warm areas with foil.
Steaks, chops and cutlets	6 to 10 min. per lb.	Place unwrapped meat in cooking dish. Turn over after half the time and shield warm areas with foil. When finished, separate pieces and let stand to complete defrosting.
Poultry		
Chicken , broiler-fryer cut up (2-1/2 to 3 lbs.)	18 to 22 min.	Place wrapped chicken in dish. Unwrap and turn over after half the time. When finished, separate pieces and microwave 2–4 minutes more, if necessary. Let stand to finish defrosting.
Chicken , whole (2-1/2 to 3 lbs.)	24 to 28 min.	Place wrapped chicken in dish. After half the time, unwrap and turn chicken over. Shield warm areas with foil. Finish defrosting. If necessary, run cold water in the cavity until giblets can be removed.
Cornish hen	10 to 16 min. per lb.	Place unwrapped hen in the oven breast-side-up. Turn over after half the time. Run cool water in the cavity until giblets can be removed.
Turkey breast (4 to 5 lbs.)	6 to 10 min. per lb.	Place unwrapped breast in dish breast-side-down. After half the time, turn over and shield warm areas with foil. Finish defrosting. Let stand 1–2 hours in refrigerator to complete defrosting.



Heating or Reheating Guide

- 1 Directions below are for heating or reheating already-cooked foods stored in refrigerator or at room temperature. Use microwave-safe cookware.
- 2 Cover most foods for fastest, most even heating. Exceptions are some sandwiches, griddle foods and baked items.
- 3 Bubbling around edges of dish is normal, since the center is the last to heat. Foods heated to 160°F. to 165°F. will provide safe, palatable results.

Adjust temperatures to suit your personal taste. Let foods stand a few minutes before serving.

- 4 Be sure foods are heated throughout before serving. Steaming or bubbling around edges of dish does not necessarily mean food is heated throughout.

If you use a meat thermometer while cooking, make sure it is safe for use in microwave ovens.

NOTE: Use Power Level Hi unless otherwise noted.

Food	Amount	Power Level	Time
Bakery Foods			
Cake, coffee cake, doughnuts, sweet rolls, nut or fruit bread	1 piece 9 inch cake or 12 rolls or doughnuts	Low (30) Low (30)	1/2 to 2 min. 3 to 5 min.
Dinner rolls, muffins	1 6 to 8	Medium (50) Medium (50)	1/2 to 1 min. 1-1/2 to 2-1/2 min.
Pie	1 slice 9 inch pie	Med-High (70)	1 to 1-1/2 min. 6 to 8 min.
Beverages			
Cocoa, other milk-based drinks (6 oz. cup)	1 to 2 cups	Med-High (70)	4 to 7 min.
Coffee, other water-based drinks (6 oz. cup)	1 to 2 cups		2 to 4 min.
Meats and Main Dishes			
Chicken pieces, hamburger, meat pieces	1 to 2 pieces		3 to 5 min.
Hot dogs and sausages	1 to 2		1 to 2 min.
Rice and pasta (2/3—3/4 cup per serving)	1 to 2 servings		1-1/2 to 4 min.
Saucy, main dishes: chop suey, spaghetti, creamed chicken, chili, stew, macaroni and cheese, etc. (3/4—1 cup per serving)	1 to 2 servings		4 to 6 min.
Plate of Leftovers	1 plate		4 to 6 min.
Sandwiches	1 to 2 servings	Med-High (70)	2 to 4 min.
Soups (6 oz. serving)	1 to 2 servings	Med-High (70)	2 to 4 min.
Vegetables	1 to 2 servings		2 to 3 min.



Operating Instructions

Other Features Your Model May Have

Cooking Complete Reminder

To remind you that you have food in the oven, the oven will beep once a minute until you either open the oven door or press CLEAR/OFF.

Clock

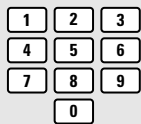

Press to enter the time of day or to check the time of day while microwaving.

- 1 Press CLOCK.
- 2 Enter time of day.
- 3 Press CLOCK.

Pause



In addition to starting many functions, START/PAUSE allows you to stop cooking without opening the door or clearing the display.



Microwave Terms

Microwave Terms

Term	Definition
Arcing	Arcing is the microwave term for sparks in the oven. Arcing is caused by: <ul style="list-style-type: none">• metal or foil touching the side of the oven.• foil that is not molded to food (upturned edges act like antennas).• metal such as twist ties, poultry pins, gold-rimmed dishes.• recycled paper towels containing small metal pieces.
Covering	Covers hold in moisture, allow for more even heating and reduce cooking time. Venting plastic wrap or covering with wax paper allows excess steam to escape.
Shielding	In a regular oven, you shield chicken breasts or baked foods to prevent over-browning. When microwaving, you use small strips of foil to shield thin parts, such as the tips of wings and legs on poultry, which would cook before larger parts.
Standing Time	When you cook with regular ovens, foods such as roasts or cakes are allowed to stand to finish cooking or to set. Standing time is especially important in microwave cooking. Note that a microwaved cake is not placed on a cooling rack.
Venting	After covering a dish with plastic wrap, you vent the plastic wrap by turning back one corner so excess steam can escape.



Helpful Information

Care and Cleaning

Helpful Hints



An occasional thorough wiping with a solution of baking soda and water keeps the inside fresh.

UNPLUG THE CORD BEFORE CLEANING ANY PART OF THIS OVEN.

How to Clean the Inside

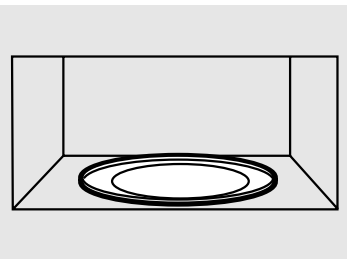

Walls, Floor, Inside Window, Metal and Plastic Parts on the Door. Some spatters can be removed with a paper towel, others may require a damp cloth. Remove greasy spatters with a sudsy cloth, then rinse with a damp cloth. Do not use abrasive cleaners or sharp utensils on oven walls. **Never use a commercial oven cleaner on any part of your microwave.**

Removable Turntable and Turntable Support. To prevent breakage, do not place the turntable into water just after cooking. Wash it carefully in warm, sudsy water or in the dishwasher. The turntable and support can be broken if dropped. Remember, do not operate the oven without the turntable and support in place.

How to Clean the Outside

Do not use cleaners containing ammonia or alcohol on the microwave oven. Ammonia or alcohol can damage the appearance of the microwave.

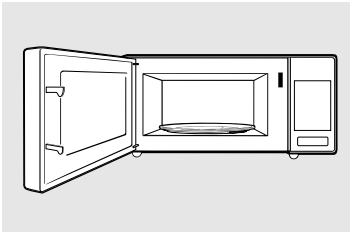

Case. Clean the outside of the microwave with a sudsy cloth. Rinse and then dry. Wipe the window clean with a damp cloth.

Control Panel and Door. Wipe with a damp cloth. Dry thoroughly. Do not use cleaning sprays, large amounts of soap and water, abrasives or sharp objects on the panel—they can damage it. Some paper towels can also scratch the control panel.

Door Surface. It's important to keep the area clean where the door seals against the microwave. Use only mild, non-abrasive detergents applied with a clean sponge or soft cloth. Rinse well.



If Something Goes Wrong

Before You Call for Service

<i>Problem</i>	<i>Possible Causes</i>	<i>What to Do</i>
<i>Oven Will Not Come On</i>	A fuse in your home may be blown or the circuit breaker tripped.	<ul style="list-style-type: none">• Replace fuse or reset circuit breaker.
	Power surge.	<ul style="list-style-type: none">• Unplug the microwave oven, then plug it back in.
	Plug not fully inserted into wall outlet.	<ul style="list-style-type: none">• Make sure the 3-prong plug on the oven is fully inserted into wall outlet.
	Door not securely closed.	<ul style="list-style-type: none">• Open the door and close securely.
<i>Foods Are Either Overcooked or Undercooked</i>	Cooking times may vary because of starting food temperature, food density or amount of foods in oven.	<ul style="list-style-type: none">• Set additional cooking time for completion.
	Food was not rearranged or stirred.	<ul style="list-style-type: none">• Some dishes require specific instructions. Check Cooking Guide or recipe for instructions.
<i>Control Panel Lighted, Yet Oven Will Not Start</i>	Door not securely closed.	<ul style="list-style-type: none">• Open the door and close securely.
	START pad not pressed after entering cooking selection.	<ul style="list-style-type: none">• Press START.
	Another selection entered already in oven and CLEAR/OFF pad not pressed to cancel it.	<ul style="list-style-type: none">• Press CLEAR/OFF.
	Cooking time not entered after pressing POWER LEVEL/TIME COOK.	<ul style="list-style-type: none">• Make sure you have entered cooking time after pressing POWER LEVEL/TIME COOK.
	CLEAR/OFF was pressed accidentally.	<ul style="list-style-type: none">• Reset cooking program and press START.

All These Things are Normal with Your Microwave Oven

- Steam or vapor escaping from around the door.
- Light reflection around door or outer case.
- Dimming oven light and change in blower sound may occur while operating at power levels other than high.
- Dull thumping sound while oven is operating.
- Some TV-radio interference might be noticed while using your microwave oven. It's similar to the interference caused by other small appliances and does not indicate a problem with your microwave. If you notice this interference, check that the microwave oven is on a different electrical circuit, relocate the radio or TV as far away from the microwave as possible, or check the position and signal of the receiving antenna.

GE Service Numbers



We'll Be There!

GE Appliances Website

www.GEAppliances.com

Have a question or need assistance with your appliance? Try the GE Appliances Website 24 hours a day, any day of the year!

For greater convenience and faster service, you can now download Owner's Manuals, order parts, catalogs, or even schedule service on-line. You can also "Ask Our Team of Experts™" your questions, and so much more...

Schedule Service

www.GEAppliances.com

800.GE.CARES
(800.432.2737)

Expert GE repair service is only one step away from your door. Get on-line and schedule your service at your convenience 24 hours any day of the year! Or call 800.GE.CARES (800.432.2737) during normal business hours.

Real Life Design Studio

www.GEAppliances.com

800.TDD.GEAC
(800.833.4322)

GE supports the Universal Design concept—products, services and environments that can be used by people of all ages, sizes and capabilities. We recognize the need to design for a wide range of physical and mental abilities and

impairments. For details of GE's Universal Design applications, including kitchen design ideas for people with disabilities, check out our Website today. For the hearing impaired, please call 800.TDD.GEAC (800.833.4322).

Extended Warranties

www.GEAppliances.com

800.626.2224

Purchase a GE extended warranty and learn about special discounts that are available while your warranty is still in effect. You can purchase it on-line anytime, or

call 800.626.2224 during normal business hours. GE Consumer Home Services will still be there after your warranty expires.



Parts and Accessories

www.GEAppliances.com

800.626.2002

Individuals qualified to service their own appliances can have parts or accessories sent directly to their home. (VISA, MasterCard and Discover cards are accepted.)

Order on-line today, 24 hours every day or by phone at ***800.626.2002*** during normal business hours.

Instructions contained in this manual cover procedures to be performed by any user. Other servicing generally should be referred to qualified service personnel. Caution must be exercised, since improper servicing may cause unsafe operation.

Register Your Appliance

www.GEAppliances.com

Register your new appliance on-line—at your convenience!

Timely product registration will allow for enhanced communication and prompt service under the terms of your warranty, should the need arise. You may also mail in the pre-printed registration card included in the packing material.

MICROWAVE OVEN WARRANTY

Staple sales slip or cancelled check here. Proof of original purchase date is needed to obtain service under warranty.

What is Covered

LIMITED ONE-YEAR WARRANTY

For one year from date of original purchase, we will provide, free of charge, parts and service labor to repair or replace *any part of the microwave oven* that fails because of a manufacturing defect.

LIMITED ADDITIONAL FOUR-YEAR WARRANTY

For the second through the fifth year from the date of original purchase, we will provide, free of charge, a replacement *magnetron tube* if the magnetron tube fails because of a manufacturing defect. You pay for the service trip to your home and service labor charges.

For each of the above warranties:

To avoid any trip charges, you must take the microwave oven to a General Electric Factory Service Center or a General Electric Customer Care® servicer and pick it up following service.

In-home service is also available, but you must pay for the service technician's travel costs to your home.

This warranty is extended to the original purchaser and any succeeding owner for products purchased for ordinary home use in the 48 mainland states, Hawaii and Washington, D.C. In Alaska the warranty is the same except that it is LIMITED because you must pay to ship the product to the service shop or for the service technician's travel costs to your home.

All warranty service will be provided by our Factory Service Centers or by our authorized Customer Care® servicers during normal working hours.

Should your appliance need service, during warranty period or beyond, call 800.GE.CARES (800.432.2737).

What is Not Covered

- Service trips to your home to teach you how to use the product.
- Improper installation, delivery or maintenance.
- Failure of the product if it is misused, or used for other than the intended purpose or used commercially.
- Damage to product caused by accident, fire, floods or acts of God.
- Incidental or consequential damage caused by possible defects with this appliance.
- Replacement of house fuses or resetting of circuit breakers.
- Damage caused after delivery.

If you have an installation problem, contact your dealer or installer. You are responsible for providing adequate electrical, exhausting and other connecting facilities.

Some states do not allow the exclusion or limitation of incidental or consequential damages, so the above limitation or exclusion may not apply to you. This warranty gives you specific legal rights, and you may also have other rights which vary from state to state. To know what your legal rights are in your state, consult your local or state consumer affairs office or your state's Attorney General.

Warrantor: General Electric Company, Louisville, KY 40225

164D3370P305
49-40375

06-03 JR

Printed in Malaysia

JE610

JE620

Free Manuals Download Website

<http://myh66.com>

<http://usermanuals.us>

<http://www.somanuals.com>

<http://www.4manuals.cc>

<http://www.manual-lib.com>

<http://www.404manual.com>

<http://www.luxmanual.com>

<http://aubethermostatmanual.com>

Golf course search by state

<http://golfingnear.com>

Email search by domain

<http://emailbydomain.com>

Auto manuals search

<http://auto.somanuals.com>

TV manuals search

<http://tv.somanuals.com>