



Use and Care Guide

Built-In Microwave/Convection Oven



Safety Instructions	3-5
Precautions to Avoid Possible Exposure to Excessive Microwave Energy	2



Operating Instructions, Tips	
Aluminum Foil	4, 24, 26
Clock.....	8, 9
Combination Cooking	25-28
Combination Roast.....	27, 28
Cooking by Temperature.....	26
Cooking by Time.....	25
Control Panel.....	8, 9
Convection Cooking	23, 24
Cooking by Temperature.....	24
Cooking by Time.....	23
Cooking Reference Guide	29
Cookware and Accessories	11
Features	7
Microwave Cooking	6, 13-22
Add 30 Seconds.....	14
Auto Defrost.....	17, 18
Cooking by Temperature.....	16
Cooking by Time.....	13, 14
Cooking Complete Reminder	7
Defrosting by Time	15
Delay Start/Reminder	14
Delayed Cooking.....	12
Express Cook Feature.....	14
Hold Time	12
Kitchen Timer	12
Microwaving Tips	6
Power Levels	6, 8, 12, 13, 15, 16
Sensor Beverage.....	19
Sensor Cook.....	21
Sensor Cooking Control Guide.....	22
Sensor Popcorn	19
Sensor Reheat.....	20
Sound Level Feature	14
Oven Shelf.....	4, 7, 11, 19-21, 31
Temperature Probe	4, 7-9, 16, 24, 26-28, 31
What Your Oven Can Do	10



Problem Solver	32
-----------------------------	----



Care and Cleaning	30, 31
Light Bulb Replacement	31



Installation	31
Adapter Plugs.....	31
Extension Cords	31
Grounding Instructions	31



Consumer Services	35
Appliance Registration	2
Important Phone Numbers	35
Model and Serial Number Location	2
Warranty	Back Cover

Model: JEB1095

Microwave power output of this oven is 800 watts.
(IEC-705 Test Procedure)



HELP US HELP YOU...

Before using your oven, read this guide carefully.

It is intended to help you operate and maintain your new microwave oven properly.

Keep it handy for answers to your questions.

Write down the model and serial numbers.

You'll find them on a label inside the oven.

These numbers are also on the Consumer Product Ownership Registration Card that came with your microwave oven. Before sending in this card, please write these numbers here:

Model Number

Serial Number

Use these numbers in any correspondence or service calls concerning your microwave oven.

If you received a damaged oven...

Immediately contact the dealer (or builder) that sold you the oven.

Save time and money. Before you request service...

Check the Problem Solver in the back of this guide. It lists causes of minor operating problems that you can correct yourself.

All these things are normal with your microwave oven.

- Steam or vapor escaping from around the door.
- Light reflection around door or outer case.
- Dimming oven light and change in blower sound may occur while operating at power levels other than high.
- Dull thumping sound while oven is operating.
- Some TV-radio interference might be noticed while using your microwave oven. It's similar to the interference caused by other small appliances and does not indicate a problem with your microwave. If you notice this interference, check that the microwave oven is on a different electrical circuit, relocate the radio or TV as far away from the microwave as possible, or check the position and signal of the receiving antenna.

PRECAUTIONS TO AVOID POSSIBLE EXPOSURE TO EXCESSIVE MICROWAVE ENERGY

- (a) **Do Not Attempt** to operate this oven with the door open since open-door operation can result in harmful exposure to microwave energy. It is important not to defeat or tamper with the safety interlocks.
- (b) **Do Not Place** any object between the oven front face and the door or allow soil or cleaner residue to accumulate on sealing surfaces.
- (c) **Do Not Operate** the oven if it is damaged. It is particularly important that the oven door close properly and that there is no damage to the:
- (1) door (bent),
 - (2) hinges and latches (broken or loosened),
 - (3) door seals and sealing surfaces.
- (d) **The Oven Should Not** be adjusted or repaired by anyone except properly qualified service personnel.

IMPORTANT SAFETY INSTRUCTIONS

Read all instructions before using your appliance.



When using electrical appliances, basic safety precautions should be followed, including the following:

⚠ WARNING—To reduce the risk of burns, fire, electric shock, injury to persons or exposure to excessive microwave energy, follow basic precautions, including the following:

- **Read and follow** the specific “Precautions to Avoid Possible Exposure to Excessive Microwave Energy” on the previous page.
 - **This appliance must be grounded.** Connect only to properly grounded outlet. See Grounding Instructions section in the back of this guide.
 - **Use this appliance only for its intended use as described in this guide.** Do not use corrosive chemicals or vapors in this appliance. This microwave/convection oven is specifically designed to heat or cook food, and is not intended for laboratory or industrial use.
 - **For best operation, plug this appliance into its own electrical outlet, to prevent flickering of lights, blowing of fuse or tripping of circuit breaker.**
-
- **Do not mount this appliance over a sink.** Install or locate this appliance only in accordance with the provided Installation Instructions.
 - **Do not cover or block any openings on the appliance.**
 - **Do not store this appliance outdoors.** Do not use this product near water—for example, in a wet basement, near a swimming pool, near a sink or in similar locations.
 - **This microwave oven is not approved or tested for marine use.**
 - **Do not store anything directly on top of the microwave/convection oven surface when the oven is in operation.**
 - **Do not immerse power cord or plug in water.**
 - **Keep power cord away from heated surfaces.**

- **Do not let power cord hang over edge of table or counter.**
- **Do not operate this appliance if it has a damaged power cord or plug, if it is not working properly, or if it has been damaged or dropped.**
- See door surface cleaning instructions in the Care and Cleaning section(s) of this guide.
- **This appliance must only be serviced by qualified service personnel.** Contact nearest authorized service facility for examination, repair or adjustment.
- **As with any appliance, close supervision is necessary when used by children.**

-
- **To reduce the risk of fire in the oven cavity:**
 - **Do not overcook food.** Carefully attend appliance when paper, plastic or other combustible materials are placed inside the oven to facilitate cooking.
 - **Remove wire twist-ties and metal handles from paper or plastic containers before placing them in the oven.**
 - **Do not use your microwave/convection oven to dry newspapers.**
 - **Do not use recycled paper products.** Recycled paper towels, napkins and waxed paper can contain metal flecks which may cause arcing or ignite. Paper products containing nylon or nylon filaments should be avoided, as they may also ignite.
 - **Do not pop popcorn in your microwave/convection oven** unless in a special microwave popcorn accessory or unless you use popcorn labeled for use in microwave ovens.
 - **Do not overcook potatoes.** They could dehydrate and catch fire, causing damage to your oven.
 - **Do not operate the oven while empty to avoid damage to the oven and the danger of fire.** If by accident the oven should run empty a minute or two, no harm is done. However, try to avoid operating the oven empty at all times—it saves energy and prolongs the life of the oven.

(continued next page)



IMPORTANT SAFETY INSTRUCTIONS

(continued)

- **Do not use the Sensor Features twice in succession on the same food portion. If food is undercooked after the first countdown, use MICRO COOK for additional cooking time.**
- **Do not use the oven for storage purposes. Do not leave paper products, cooking utensils or food in the oven when not in use.**
- **If materials inside the oven ignite, keep oven door closed, turn oven off, and disconnect power cord, or shut off power at the fuse or circuit breaker panel.**

-
- **When using the convection or combination cooking functions, both the outside and inside of the oven will become hot. Always use hot pads to remove containers of food and accessories such as the metal accessory rack and temperature probe.**
 - **Oversized food or oversized metal cookware should not be used in a microwave/convection oven because they increase the risk of electric shock and could cause a fire.**
 - **Do not clean with metal scouring pads. Pieces can burn off the pad and touch electrical parts involving risk of electric shock.**
 - **Do not use paper products when the microwave/convection oven is operated in the convection or combination mode.**
 - **Do not store any materials, other than our recommended accessories, in this oven when not in use.**
 - **Some products such as whole eggs and sealed containers—for example, closed glass jars—are able to explode and should not be heated in this microwave/convection oven. Such use of the microwave/convection oven could result in injury.**
 - **Avoid heating baby food in glass jars, even with the lid off. Make sure all infant food is thoroughly cooked. Stir food to distribute the heat evenly. Be careful to prevent scalding when warming formula or breast milk. The container may feel cooler than the milk really is. Always test the milk before feeding the baby.**

- **Don't defrost frozen beverages** in narrow necked bottles (especially carbonated beverages). Even if the container is opened, pressure can build up. This can cause the container to burst, possibly resulting in injury.
- **Use foil only as directed in this guide.** TV dinners may be microwaved in foil trays less than 3/4" high; remove top foil cover and return tray to box. When using foil in the microwave/ convection oven, **keep foil at least 1" away from sides of oven.**
- **Do not cover the shelf or any other part of the oven with metal foil. This will cause overheating of the microwave/convection oven.**



- **Cookware may become hot** because of heat transferred from the heated food. Pot holders may be needed to handle the cookware.
- **Sometimes, the oven floor and walls can become too hot to touch.** Be careful touching the floor and walls during and after cooking.
- **Foods cooked in liquids** (such as pasta) may tend to boil over more rapidly than foods containing less moisture. Should this occur, refer to the Care and Cleaning section(s) for instructions on how to clean the inside of the oven.

-
- **Thermometer—Do not use regular cooking or oven thermometers when cooking by microwave or combination.** The metal and mercury in these thermometers could cause "arcing" and possible damage to the oven. Do not use a thermometer in food you are microwaving unless the thermometer is designed or recommended for use in the microwave/convection oven.
 - **Remove the temperature probe from the oven when not using it to cook with.** If you leave the probe inside the oven without inserting it in food or liquid, and turn on microwave energy, it can create electrical arcing in the oven, damage oven walls and damage the temperature probe.



- **Plastic cookware**—Plastic cookware designed for microwave cooking is very useful, but should be used carefully. Even microwave-safe plastic may not be as tolerant of overcooking conditions as are glass or ceramic materials, and may soften or char if subjected to short periods of overcooking. In longer exposures to overcooking, the food and cookware could ignite.

For these reasons:

- 1) Use microwave-safe plastics only and use them in strict compliance with the cookware manufacturer's recommendations.
- 2) Do not subject empty cookware to microwaving.
- 3) Do not permit children to use plastic cookware without complete supervision.

- **Cook meat and poultry thoroughly**—meat to at least an INTERNAL 160°F and poultry to at least an INTERNAL 180°F. Cooking to these temperatures usually protects against foodborne illness.

SAFETY FACT—Superheated water. Liquids, such as water, coffee or tea, are able to be overheated beyond the boiling point without appearing to be boiling. Visible bubbling or boiling when the container is removed from the microwave oven is not always present. THIS COULD RESULT IN VERY HOT LIQUIDS SUDDENLY BOILING OVER WHEN THE CONTAINER IS DISTURBED OR A SPOON OR OTHER UTENSIL IS INSERTED INTO THE LIQUID.

To reduce the risk of injury to persons:

- Do not overheat the liquid.
- Stir the liquid both before and halfway through heating it.
- Do not use straight-sided containers with narrow necks.
- After heating, allow the container to stand in the microwave oven for a short time before removing the container.
- Use extreme care when inserting a spoon or other utensil into the container.

- **Do not boil eggs in a microwave/convection oven.** Pressure will build up inside egg yolk and will cause it to burst, possibly resulting in injury.



- **Foods with unbroken outer "skin"** such as potatoes, sausages, tomatoes, apples, chicken livers and other giblets, and egg yolks (see previous caution) should be pierced to allow steam to escape during cooking.

- **Not all plastic wrap is suitable for use in microwave/convection ovens.** Check the package for proper use.
- **"Boilable" cooking pouches and tightly closed plastic bags** should be slit, pierced or vented as directed by package. If they are not, plastic could burst during or immediately after cooking, possibly resulting in injury. Also, plastic storage containers should be at least partially uncovered because they form a tight seal. When cooking with containers tightly covered with plastic wrap, remove covering carefully and direct steam away from hands and face.



- **Hot foods and steam can cause burns.** Be careful when opening any containers of hot food, including popcorn bags, cooking pouches and boxes. To prevent possible injury, direct steam away from hands and face.

- **Use of the shelf accessory.**
 - Use pot holders when handling the shelf and cookware. They will be hot.
 - Never use the shelf for microwave-only cooking. Remove the shelf from the oven when microwave-only cooking.
 - Always place the shelf on the floor of the oven for convection and combination cooking.

SAVE THESE INSTRUCTIONS



MICROWAVING TIPS

- **Make sure all cookware used in your microwave/convection oven is suitable for microwaving.** Most glass casseroles, cooking dishes, measuring cups, custard cups, pottery or china dinnerware which does not have metallic trim or glaze with a metallic sheen can be used. Some cookware is labeled “suitable for microwaving.”

- **If you are not sure if a dish is microwave-safe, use this test:**

Place in the oven both the dish you are testing and a glass measuring cup filled with 1 cup of water—set the measuring cup either in or next to the dish. Microwave 1 minute at high. If the dish heats, it should not be used for microwaving. If the dish

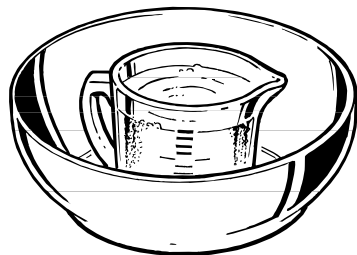

remains cool and only the water in the cup heats, then the dish is microwave-safe.

- **Paper towels, waxed paper and plastic wrap** can be used to cover dishes in order to retain moisture and prevent spattering. Be sure to vent plastic wrap so steam can escape.
- **Some microwaved foods require stirring, rotating or rearranging.**
- **Steam builds up pressure in foods which are tightly covered by a skin or membrane.** Pierce potatoes, egg yolks and chicken livers to prevent bursting.

If you use a meat thermometer while cooking, make sure it is safe for use in microwave ovens.

VARIABLE POWER LEVELS (1–10)

How to Change Power Level

1. Press MICRO COOK or TIME DEFROST.
2. Select cooking or defrosting time.
3. Press POWER LEVEL.
4. Select desired power level 1–10.
5. Press START.



Variable power levels add flexibility to your microwave cooking. The power levels on your microwave oven can be compared to the surface units on a range. High (Power Level 10) or full power is the fastest way to cook and gives you 100% power. Each power level gives you microwave energy a certain percent of the time. Power Level 7 is microwave energy 70% of the time. Power Level 3 is energy 30% of the time.

A high setting (10) will cook faster but may need additional attention such as frequent stirring, rotating or turning over. Most of your cooking will be done on High (Power Level 10). A lower setting will cook more evenly and with less attention given to stirring or rotating the food. Some foods may have better flavor, texture or appearance if one of the lower settings is used. You may wish to use a lower power level when cooking foods that have a tendency to boil over, such as scalloped potatoes.

Rest periods (when the microwave energy cycles off) give time for the food to “equalize” or transfer heat to the inside of the food. An example of this is shown with Power Level 3—the defrost cycle. If microwave energy did not cycle off, the outside of the food would cook before the inside was defrosted.

Here are some examples of uses for various power levels:

POWER LEVEL	BEST USES
High 10	Fish, bacon, vegetables, boiling liquids.
Med-High 7	Gentle cooking of meat and poultry; baking casseroles and reheating.
Medium 5	Slow cooking and tenderizing such as stews and less tender cuts of meat.
Low 3	Defrosting without cooking; simmering; delicate sauces.
Warm 1	Keeping food warm without overcooking; softening butter.

FEATURES OF YOUR OVEN

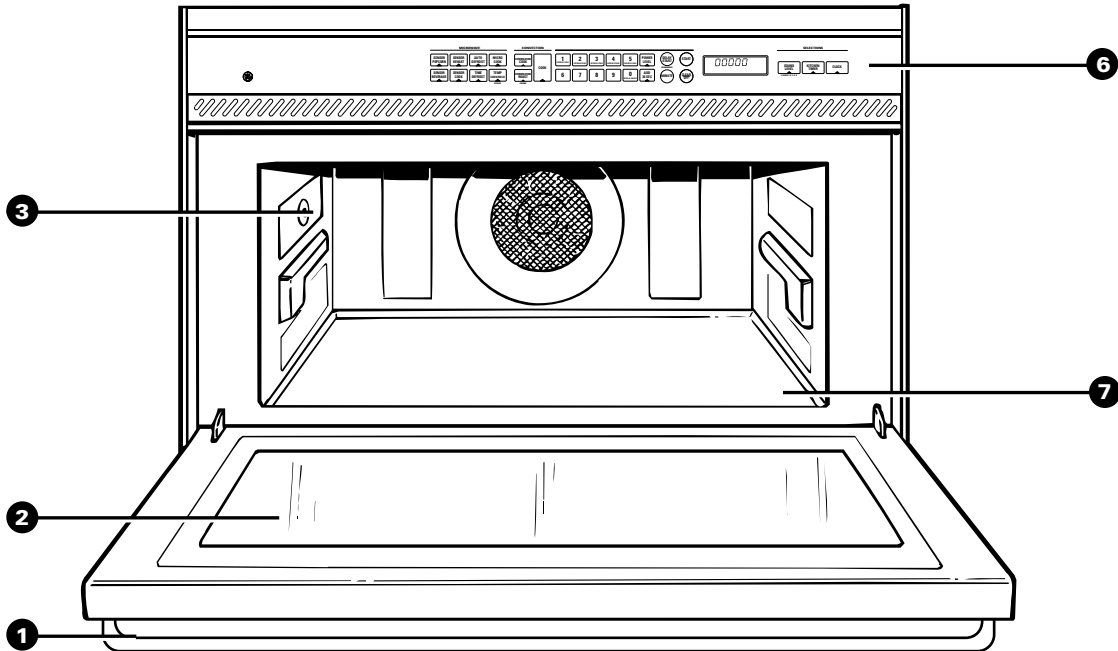
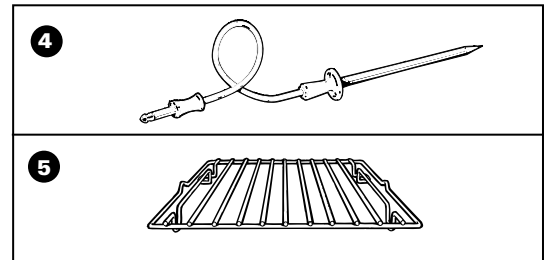

- 1. Door Handle.** Pull to open door. Door must be securely closed for oven to operate.
- 2. Window with Metal Shield.** Screen allows cooking to be viewed while keeping microwaves confined in oven.
- 3. Receptacle for Temperature Probe.** Probe must be securely inserted into receptacle before oven will start any temperature or Combination Roast cooking.
- 4. Temperature Probe.** Use with Combination Roast, Convection/Combination Cook and Temp Cook/Hold.

- 5. Shelf.** The metal shelf must be in place on the oven floor when using convection or combination cooking. Remove the shelf when using microwave-only cooking.
- 6. Touch Control Panel and Digital Display.** For detailed information on each feature, see Your Touch Control Panel section.
- 7. Oven Floor.**

NOTE: Rating plate, oven light and oven vent(s) are located on the inside walls of the microwave oven.

Cooking Complete Reminder

(For all defrost and cook cycles except Temp Cook/Hold)

To remind you that you have food in the oven, the oven will display “End” and beep once a minute until you either open the oven door or touch the CLEAR/OFF pad.



YOUR TOUCH CONTROL PANEL

The touch control panel allows you to set the oven controls with the touch of a finger. It's designed to be easy to use and understand. With your new oven, you have several cooking options. In addition to microwave or convection cooking, you have combination cooking, which uses both methods. Also sensor microwave cooking (Sensor Cook) and sensor microwave defrosting (Sensor Defrost), and sensor combination temperature cooking (Combination Roast). Or you may make your own programs to suit your own cooking needs.

- 1. SENSOR POPCORN.** Touch this pad to cook prepackaged microwave popcorn weighing 3.0 to 3.5 ounces. No need to touch START, the oven will start immediately.
- 2. SENSOR REHEAT.** Touch this pad for quick reheating of prepared foods. No need to touch START, the oven will start immediately.
- 3. AUTO DEFROST.** Touch this pad and food weight, then START. The oven automatically sets power levels and defrosting time.
- 4. MICRO COOK.** Microwave for a selected amount of time using automatic Power Level 10 (High).
- 5. COMBINATION COOK.** Touch this pad before entering desired oven temperature, then cook time or food temperature. Combination cooking uses alternating microwave and convection for maximum speed and browning.
- 6. CONVECTION COOK.** Touch this pad before entering desired oven temperature, then cook time or food temperature.
- 7. EXPRESS COOK.** Touch number pads 1 through 5 for 1 to 5 minutes of cooking. No need to touch START, the oven will start immediately.
- 8. POWER LEVEL.** Touch this pad before entering another power level number if you want to change from automatic Power Level 10 (High) for cooking or Power Level 3 (Low) for defrosting.
- 9. DELAY START/REMINDER.** Allows you to program your oven to begin cooking at a preset time of day—up to a 12-hour delay. The Reminder feature can be used like an alarm clock.
- 10. START.** After all selections are made, touch this pad to start the oven.
- 11. DISPLAY.** Displays time of day, time or temperature during cooking functions, doneness code words, preheat code words, power level being used, cooking mode and instructions.
- 12. SENSOR BEVERAGE.** Touch this pad to heat or reheat a beverage. No need to touch START, the oven will start immediately.
- 13. SENSOR COOK.** Touch this pad, number pad for desired code number, and START. The oven automatically microwaves at pre-programmed power levels and determines the proper amount of cooking time until the food is done and oven shuts off.
- 14. TIME DEFROST.** Gentle thawing at automatic Power Level 3 (Low).
- 15. TEMP COOK/HOLD.** Use the temperature probe to cook by using a preset temperature. When internal food temperature reaches 90°F., oven shows temperature until preset temperature is reached and holds temperature for up to 1 hour.
- 16. COMBINATION ROAST.** Insert probe. Touch this pad (once for Medium, twice for Well), then START. The oven roasts meat with the automatic preset program.
- 17. NUMBER PADS.** Touch these pads to program the microwave.
- 18. CLOCK DISPLAY ON/OFF.** Touch the 0 number pad to turn the clock display on or off. The Clock Display On/Off feature cannot be used while a cooking feature is in use.
- 19. ADD 30 SECONDS.** Press this pad for 30 seconds of cook time, to add 30 seconds to the cook time as it's counting down, or for an "instant on" for 30 seconds.
- 20. MINUTE.** Use this with number pads to enter whole minutes. For example, for 6 minutes touch 6 and MINUTE.
- 21. CLEAR/OFF.** When touched, it stops the oven and erases all settings except time of day.
- 22. SOUND LEVEL.** Press the SOUND LEVEL pad. Press number pad 0, 1, 2, or 3 then press START pad to change the sound level of the oven beeper.
- 23. KITCHEN TIMER.** This feature uses no microwave energy while it functions as both a kitchen timer or as a holding period between defrost and time or temperature cooking.
- 24. CLOCK.** Touch this pad to enter time of day or check time of day while microwaving. To set clock, first touch CLOCK pad and then enter time of day. For example, if time is 1:30, touch number pads 1, 3, and 0 and "1:30" will appear in display. Then touch START or CLOCK. If you wish to reset or change time, simply repeat above process.

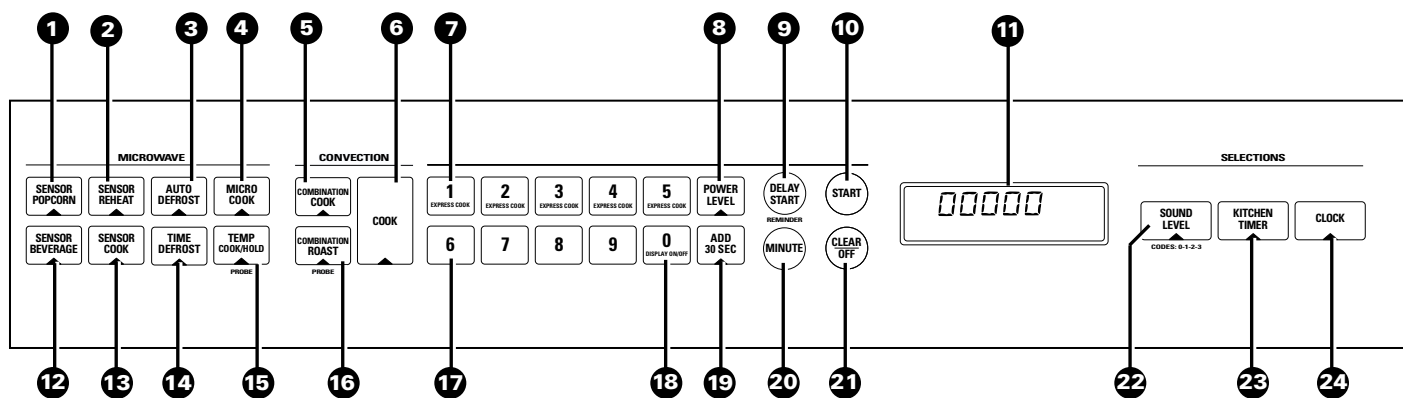
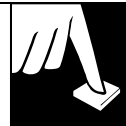

When You Plug in the Oven

The panel displays “88888” on the upper portion and all of the oven functions on the lower portion. After 15 seconds, all lights disappear and “RESET” appears in the upper portion. Touch the CLEAR/OFF pad, set the clock and oven is ready for use.

This will happen any time there is a power outage.

Temperature Probe

“PROBe” Appears in the Display

- Probe has been forgotten when Combination Roast or Temp Cook/Hold function is being used.
- Probe is not securely seated in oven wall receptacle.

Clock Display On/Off Feature

The Clock Display On/Off Feature allows you to turn the clock display on or off without changing the time on the clock. Touch the 0 number pad to turn the clock display on or off. The Clock Display On/Off feature cannot be used while a cooking feature is in use.



WHAT YOUR OVEN CAN DO

Cooking with your new oven offers a wide variety of food preparation options. Microwave cooking uses very short, high frequency radio waves. The movement of the microwaves through the food generates heat and cooks most foods faster than regular methods, while retaining their natural texture and moisture. Microwave cooking heats food directly, not the cookware or the interior of the oven. Reheating is easy and defrosting is particularly convenient because less time is spent in food preparation.

Convection cooking constantly circulates heated air around the food, creating even browning and sealed-in flavor by the constant motion of hot air over the food surfaces.

Your new oven also offers the option of combination cooking, using microwave energy along with convection cooking. You cook with speed and accuracy, while browning and crisping to perfection.

You can use microwave cooking, convection cooking or combination cooking to cook by time. Simply preset the length of cooking time desired and your oven turns off automatically. Or you can cook by temperature, by these methods, using the temperature probe to determine the doneness by the internal temperature of the food. This method takes the guesswork out of cooking, shutting the oven off automatically when the food reaches the desired temperature.

The Microwave Sensor Cooking Features (Sensor Cook, Sensor Reheat and Sensor Popcorn) do your microwave cooking for you. They are easy and convenient—just follow the step-by-step instructions in this guide. A sensor detects steam from the food and automatically adjusts cooking time and power level for best results.

Do not use the Sensor Features twice in succession on the same food portion—it may result in severely overcooked or burnt food. If food is undercooked after the countdown, use MICRO COOK for additional cooking time.

Combination Roast uses alternating microwave and convection to roast meats to perfection.

Auto Defrost automatically sets the defrosting time and power levels for you. Enter the food weight in pounds and tenths of a pound and touch the START pad. The oven calculates the defrosting time and changes power levels during defrosting to give even defrosting results.

The Delay Start/Reminder feature lets you program the oven to start cooking at a desired time, even if you're not at home. The Reminder feature can be used like an alarm clock.

The following guide shows at a glance the difference between microwave, convection and combination cooking.

Comparison Guide

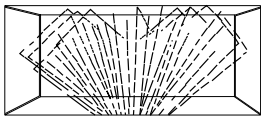
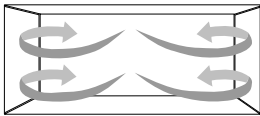
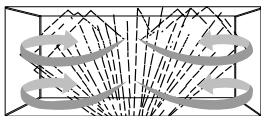
	Microwave	Convection	Combination
			
COOKING METHOD	Microwave energy is distributed evenly throughout the oven for thorough, fast cooking of food.	Hot air circulates around food to produce browned exteriors and seal in juices.	Microwave energy and convection heat combine to cook foods in up to one-third less time than ovens, while browning and sealing in juices.
HEAT SOURCE	Microwave energy.	Circulating heated air.	Microwave energy and circulating heated air.
HEAT CONDUCTION	Heat produced within food by instant energy penetration.	Heat conducted from outside of food to inside.	Food heats from instant energy from penetration and heat conducted from outside of food.
BENEFITS	Fast, high efficiency cooking. Oven and surroundings do not get hot. Easy clean-up.	Aids in browning and seals in flavor. Cooks some foods faster than regular ovens.	Shortened cooking time from microwave energy, plus browning and crisping from convection heat.

Read this guide to learn the many different things your Microwave/Convection/Combination Oven can do. You will find a wide variety of cooking methods and programs designed to suit your lifestyle.

COOKWARE AND ACCESSORIES

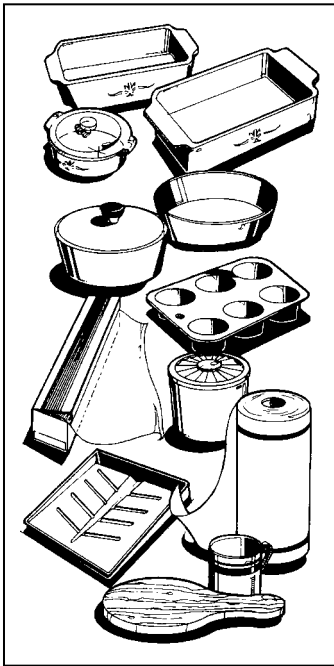

Cookware	Microwave	Convection	Combination
Heat-Resistant Glass, Glass-Ceramic (Pyrex, [®] Fire King, [®] Corning Ware, [®] etc.)	YES	YES	YES
Ceramic (Cookware with no metal trim)	YES	YES	YES
Metal	NO	YES	NO
Non Heat-Resistant Glass	NO	NO	NO
Microwave-Safe Plastics	YES	NO	YES*
Plastic Films and Wraps	YES	NO	NO
Paper Products	YES	NO	NO
Straw, Wicker and Wood	YES	NO	NO

*Use only microwave cookware that is safe to 400°F.

Cookware Tips

Convection Cooking

METAL PANS are recommended for all types of baked products, but especially where browning or crusting is important.

Dark or dull finish metal pans are best for breads and pies because they absorb heat and produce crisper crust.

Shiny aluminum pans are better for cakes, cookies or muffins because these pans reflect heat and help produce a light tender crust.

GLASS OR GLASS-CERAMIC casserole or baking dishes are best suited for egg and cheese recipes due to the cleanability of glass.

Combination Cooking

GLASS OR GLASS-CERAMIC baking containers are recommended. Be sure not to use items with metal trim as it may cause arcing (sparking) with oven wall or metal accessory shelf, damaging the cookware, the shelf or the oven.

HEAT-RESISTANT PLASTIC microwave cookware (safe to 400°F) may be used, but it is not recommended for foods requiring crusting or all-around browning, because the plastic is a poor conductor of heat.

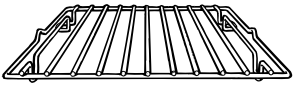
	Microwave	Convection	Combination
	NO	YES, on the floor of the oven.	YES, on the floor of the oven.

METAL SHELF

The shelf is required for good air circulation and even browning when using Convection and Combination Cook. Allow at least one inch between the pan and the walls of the oven for air circulation.



HOW TO USE THE KITCHEN TIMER

The Kitchen Timer

The Kitchen Timer has 3 timing functions:

- It operates as a minute timer.
- It can be set to delay cooking.
- It can be used as a hold setting after defrosting.

The Kitchen Timer operates without microwave energy.

Using a Holding Time

The Kitchen Timer can also be used to program a “holding time” between microwave cooking functions. The time can range from 1 second to 99 minutes and 99 seconds. A holding or standing time may be found in some of your own recipes or in a cookbook.

How to Time a 3-Minute Phone Call

Step 1: Touch KITCHEN TIMER pad.

Step 2: Touch number pad 3 and MINUTE pad (for 3 minutes and no seconds).

Step 3: Touch START. Display shows time counting down. The timer signals when time is up.

Programming Delayed Cooking

To delay cooking up to 99 minutes and 99 seconds, touch either MICRO COOK, TEMP COOK/HOLD or COMBINATION ROAST and enter cook time, temperature or code. Touch KITCHEN TIMER and enter number of minutes to delay cooking. **When delaying Temp Cook/Hold or Combination Roast cooking, be sure probe is in food.** Touch START. Timer will count down to zero and cooking will begin.

NOTE: Cooling fan comes on during delay time.

How to Defrost, Hold and Micro Cook

Let's say you want to defrost a frozen casserole for 15 minutes, hold for 10 minutes and then Micro Cook for 25 minutes. Here's how to do it:

Step 1: Take casserole from freezer and place in oven.



Step 2: Touch TIME DEFROST pad.

Step 3: Touch pads 1, 5 and MINUTE for 15 minutes defrosting time. (Defrosting is automatically set on power level 3 but can be changed by touching the POWER LEVEL pad and the desired power level 1–10.)



Step 4: Set standing or hold time by touching KITCHEN TIMER pad.

Step 5: Touch 1, 0 and MINUTE to hold for 10 minutes.



Step 6: Touch MICRO COOK pad.

Step 7: Touch 2, 5 and MINUTE for 25 minutes of cooking time.



Step 8: Touch START. As each function is automatically performed, oven display shows instructions entered and the function. When time is up, the oven signals and flashes “End.”

COOKING BY TIME



Micro Cook I

Micro Cook allows you to microwave for a preset amount of time.

Power Level 10 (High) is recommended for most cooking, but you may change this for more flexibility. See the Cooking Guide.

To become better acquainted with time cooking, make a cup of coffee by following the steps below.

Step 1: Fill a cup 2/3 full of water, add 1 teaspoon of instant coffee and stir to dissolve. Use a cup that has no metal decoration and is microwave-safe (refer to Microwaving Tips section). Place cup in oven and close door.

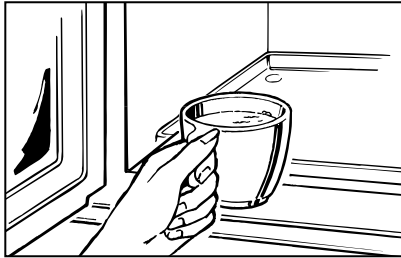

Step 2: Touch MICRO COOK.

Step 3: Select your time. Touch pad 1 and MINUTE pad for 1 minute.

Because automatic Power Level 10 is recommended for this cup of coffee, there is no need to change the power level. (If Power Level 10 is not appropriate, see “How to Change Power Level” below.)



Step 4: Touch START.

Step 5: When time is up, the oven signals and flashes “End”. The oven, light and fan shut off.

Step 6: Open the door.

If you interrupt Micro Cook to check the food, simply close the door and press START to resume cooking. If there is no time remaining on the timer you must reset the timer to resume cooking.

How to Change Power Level When Setting Micro Cook I

1. Press MICRO COOK.
2. Select cooking time.
3. Press POWER LEVEL.
4. Select desired power level 1–10.
5. Press START.



Using the Micro Cook II Feature

The Micro Cook II feature lets you set 2 time cooking functions within one program. This is ideal if you want to change power levels during your cooking operations. Here’s how to do it.

Step 1: Place the food in the oven in a microwave-safe container and close the door.



Step 2: Touch MICRO COOK.

Step 3: Select your first cook time. For example, touch 2, 1 and 5 for 2 minutes and 15 seconds.

Step 4: Now is the time to change the power level if you don’t want full power for MICRO COOK. (Press POWER LEVEL. Select desired power level 1–10.)

Step 5: Touch MICRO COOK again.

Step 6: Set your second cook time.

Step 7: Change the power level for MICRO COOK. (Press POWER LEVEL. Select desired power level 1–10.)



Step 8: Press START.

The microwave oven will start and the time set for “COOK TIME I” will count down. Also, “POWER 10” or the power level selected for “COOK TIME I” will be displayed.

At the end of “COOK TIME I”, the second power level is displayed and the time for “COOK TIME II” is shown counting down.

When time is up, the oven signals and flashes “End”. The oven, light and fan shut off. Open the door.

If you interrupt Micro Cook to check the food, simply close the door and press START to resume cooking. If there is no time remaining on the timer you must reset the timer to resume cooking.

(continued next page)



COOKING BY TIME

(continued)

The Express Cook Feature

The Express Cook feature is a short-cut method to set time for 1-5 minutes at Power Level 10.



To Express Cook your food or beverage:

Touch a number pad (from 1 to 5) for 1 to 5 minutes of cooking at Power Level 10. For example, touch the 2 pad for 2 minutes of cooking time. No need to touch START, the oven will start immediately.

The oven will signal and turn off automatically when finished.

How to Use Delay Start

The Delay Start feature allows you to program your oven to begin cooking at a preset time of day—up to a 12-hour delay.

Step 1: Touch DELAY START pad.



Step 2: Enter the time you want the oven to start. (Be sure your microwave oven clock shows the correct time of day.)

Step 3: Enter your desired cooking program.



Step 4: Touch START pad. The display will show the time you entered. The time of day may be displayed by touching the CLOCK pad. The oven will automatically start at the desired time.

How to Use Reminder

The Reminder feature can be used like an alarm clock, without starting the oven.

Example: It is 7 a.m. and you must remember to leave for a dentist appointment at 10 a.m.

Step 1: Touch DELAY START pad.



Step 2: Enter the time you want the oven to remind you. (Be sure your microwave oven clock shows the correct time of day. The reminder time can be set up to 12 hours later.)

Step 3: Touch START pad. The reminder is now set at the time you programmed, and will signal you at that time with a beeping sound

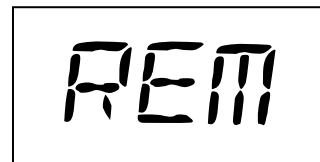

until you open the door or touch the CLEAR/OFF pad. The display will show “REM” until the oven door is opened or CLEAR/OFF is touched. The REMinder time may be displayed by touching the DELAY START pad. The time-of-day may be displayed by touching the CLOCK pad.

The Sound Level Feature

The Sound Level Feature lets you change the sound level of the oven beeper. To set the beeper sound level:

Step 1: Touch the SOUND LEVEL pad.

Step 2: Touch 0 for No Sound, 1 for Soft, 2 for Normal or 3 for Loud. When you touch each number pad the oven will beep at the volume that you have selected.

Step 3: When you have selected your desired sound level, touch the START pad.

Add 30 Seconds



The Add 30 Seconds feature provides a convenient way to extend cooking time by 30 seconds while the oven timer is counting down. It will add 30 seconds to the time shown each time the pad is touched.

This pad may also be used as an express cook for 30 seconds of cooking. No need to touch START, the oven will start immediately.

DEFROSTING BY TIME



Time Defrost (Power Level 3)

Time Defrost is designed for speedy thawing of frozen food and is one of the great advantages of a microwave oven.

Use the Time Defrost setting to quickly thaw foods such as bread, rolls, vegetables, fruits and frozen dinners. The Auto Defrost setting is preferred for meat and poultry because the oven sets the defrosting time and power levels for you.

- Power Level 3 is automatically set when you press TIME DEFROST pad, but you may change this for more flexibility.
- See the Defrosting Guide for defrosting help.

How to Change Power Level

1. Press TIME DEFROST.

2. Select defrosting time.

3. Press POWER LEVEL.

4. Select desired power level 1–10.

5. Press START.



To become better acquainted with the defrost function, defrost a 10 oz. package of frozen strawberries by following the steps below.

Step 1: Place a package of frozen strawberries in the oven and close door. Be sure package contains no metal.

Step 2: Touch TIME DEFROST.



Step 3: Select one half of the total defrosting time recommended. For example, touch pads 4, 0 and 0 for 4 minutes.



Step 4: Touch START. When the cycle is completed, the oven signals and flashes “End”, then automatically shuts off.

Step 5: Turn the package over, close the door and repeat Steps 2 and 3 to set remaining half of defrosting time. Touch START.

Step 6: When the oven signals and flashes “End”, open the door, remove the package and separate strawberries to finish defrosting.

Defrosting Tips



- Foods frozen in paper or plastic can be defrosted in the package. Tightly closed packages should be slit, pierced or vented, AFTER food has partially defrosted, as directed by package. Plastic storage containers should be at least partially uncovered.
- Family-size, pre-packaged frozen dinners can be defrosted and microwaved. If the food is in a foil container, transfer it to a microwave-safe dish.



- For even defrosting, some foods need to be broken up or separated part of the way through the defrosting time.
- Foods that spoil easily, such as milk, eggs, fish, stuffings, poultry and pork should not be allowed to sit out for more than one hour after defrosting. Room temperature promotes the growth of harmful bacteria.
- Check the Defrosting Guide for other defrosting tips.

Questions and Answers

Q. When I press START, I hear a dull thumping noise. What is it?

A. This sound is normal. It is letting you know the magnetron is in operation.

Q. Can I defrost small items in a hurry?

A. Yes, but they will need more frequent attention than usual. Raise the power level after entering the time by touching the desired power level pad. Power Level 7 cuts the total defrosting time in about 1/2; Power Level 10 cuts the total defrosting time to approximately 1/3. During either, rotate or stir food frequently.



COOKING BY TEMPERATURE

Internal temperature is the best test of doneness for many foods.

Use Temp Cook/Hold to cook a variety of foods to the desired finished food temperature. The Micro Cook setting is recommended for batters, doughs, frozen foods and foods which are difficult to cook precisely with the probe.

Temp Cook/Hold takes the guesswork out of cooking because the oven automatically switches to “Hold” setting after reaching the preset food temperature and maintains that temperature until you touch the CLEAR/OFF pad.

NOTE: Oven automatically switches to “Hold” when preset food temperature is reached.

The Temperature Probe

The temperature probe is a food thermometer that gauges the internal temperature of your food. Use the probe when you want to Convection Cook or Combination Cook to a preferred internal temperature. (Its appearance may vary from picture shown.) The probe must be used when using Temp Cook/Hold or Combination Roast. To use the probe properly, follow directions in the Combination Roasting section.

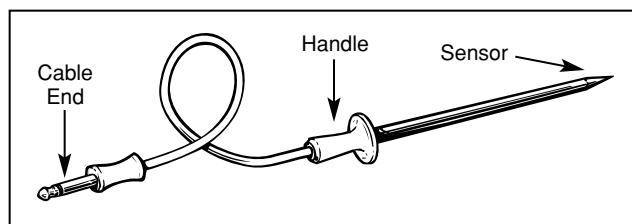

How to Temp Cook a Rolled Beef Rib Roast to Medium

Step 1: Insert temperature probe and attach probe securely in oven wall. Close the door.

Step 2: Touch TEMP COOK/HOLD pad.

Step 3: Touch 1, 6 and 0 for 160°F.

Step 4: Touch POWER LEVEL pad. Touch 5 for medium power.

Step 5: Touch the START pad. If internal temperature of the roast is less than 90°F, display will show “COOL”; if temperature is 90°F or above, display shows temperature counting up.

Step 6: When 160°F is reached, the oven will sound and display “Hold.” The oven will then hold the temperature for up to one hour.

Step 7: Touch the CLEAR/OFF pad to stop the cycle.

Step 8: Remove probe and food from the oven.

Cooking Tips

- Use a lower power level; foods will heat more evenly though requiring more time.
- Be sure frozen food has been completely defrosted before inserting probe. Probe may break off if used in frozen foods.
- Cover foods loosely for moisture control and quick, even heating.
- Insert the probe horizontally into the center meaty area not touching bone or fat. Make sure the handle does not touch the food or top or sides of the oven.

Questions and Answers

Q. Why did “PROBE” flash on the display?

A. “PROBE” will flash if you don’t seat the cable end of the probe securely into the receptacle in the oven wall or if you touch the TEMP COOK/HOLD pad and forget to use the probe.

Q. Can I leave my probe in the oven if it’s not inserted in food?

A. No, if it touches the oven wall, it may damage the oven.

AUTO DEFROST



Auto Defrost

With the Auto Defrost feature, the oven automatically sets the defrosting times and power levels for you.

Use the Auto Defrost Guide. Enter the food weight in pounds and tenths of a pound (see Conversion Guide below). Then touch START pad.

The oven calculates defrosting time and changes power levels during defrosting to give even defrosting results.

How to Set Auto Defrost

Before you begin, check the Auto Defrost guide located in this section. It shows minimum and maximum food weights for a variety of foods. You will need to know your food weight before setting Auto Defrost.

Step 1: Remove food from package, place in oven on microwave-safe dish and close door.



Step 2: Touch AUTO DEFROST pad.

Step 3: Enter weight. For example, touch number pads 1 and 2 for weight of 1.2 pounds (1 pound, 3 ounces). See Conversion Guide below. After approximately 5 seconds “START” flashes.



Step 4: Touch START pad. Display shows defrost time counting down.

Twice during defrosting, the oven beeps 4 times and “TURN” flashes. Follow the directions in the Auto Defrost Guide for what to do at the first and second signal. Then close the door and touch START pad.

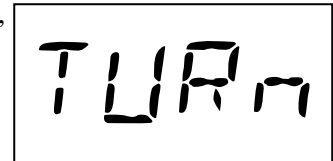

When defrosting time is completed, “End” flashes and oven beeps 4 times. “End” remains on display and oven beeps every minute until door is opened or CLEAR/OFF pad is touched.

Stand Time

After Auto Defrosting, meat needs to stand in order to let the inside defrost. You may take the food out of the oven if you wish. Stand time recommendations are given in the Auto Defrost Guide.

Conversion Guide

If the weight of food is stated in pounds and ounces, the ounces must be converted to tenths (.1) of a pound.

Ounces	Pounds
1–2	.1
3	.2
4–5	.3
6–7	.4
8	.5
9–10	.6
11	.7
12–13	.8
14–15	.9



AUTO DEFROST GUIDE

RECOMMENDED FOODS	MIN.–MAX. WEIGHT	FIRST SIGNAL	SECOND SIGNAL	STAND TIME
Meat				
Chops	0.1 – 6.0 lbs.	Turn over.	Separate and shield where necessary.	5 minutes
Frankfurters, Sausage	0.1 – 6.0 lbs.	Separate.	Remove defrosted pieces.	2 minutes
Ground Meat	0.1 – 6.0 lbs.	Turn over.	Remove defrosted areas and break apart.	5 minutes
Beef Patties	0.1 – 6.0 lbs.	Turn over.	Separate patties.	5 minutes
Roast	0.1 – 6.0 lbs.	Turn over and shield.	Shield if necessary.	30 minutes
Ribs	0.1 – 6.0 lbs.	Turn over.	Remove defrosted pieces. Shield if necessary.	5 minutes
Steak	0.1 – 6.0 lbs.	Turn over.		5 minutes
Stew	0.1 – 6.0 lbs.	Turn over and separate.	Separate and remove defrosted pieces.	5 minutes
Poultry				
Whole Chicken	0.1 – 6.0 lbs.	Turn over and shield.	Turn over and shield.	10 minutes; run cold water in cavity.
Turkey Breast (breast side up)	0.1 – 6.0 lbs.	Turn over.	Shield where necessary.	20 minutes; run cold water in cavity.
Chicken Pieces	0.1 – 6.0 lbs.	Turn over.	Separate and remove defrosted pieces.	5 minutes
Cornish Hens (whole)	0.1 – 6.0 lbs.	Remove wrapper and turn over.		10 minutes; run cold water in cavity.
Cornish Hens (split)	0.1 – 6.0 lbs.	Turn over.		5 minutes
Seafood				
Fish Fillets	0.1 – 6.0 lbs.	Turn over.	Separate and remove defrosted pieces.	5 minutes
Shrimp, Scallops	0.1 – 6.0 lbs.	Separate.	Separate and remove defrosted pieces.	5 minutes
Whole Fish	0.1 – 6.0 lbs.	Turn over and shield tail and head.		5 minutes; hold under cold running water.

Edges or thin areas of meat will defrost more rapidly than other areas. After first or second signal, shield warm areas with small pieces of foil.

SENSOR POPCORN



NOTE: Do NOT use the metal shelf with the Sensor Popcorn program.

NOTE: Do not use this feature twice in succession on the same food portion—it may result in severely overcooked or burnt food.

The Sensor Popcorn feature is designed to be used only with prepackaged microwave popcorn weighing 3.0 to 3.5 ounces.

Step 1: Remove the outer wrapper from the microwave popcorn.

Step 2: Open oven door and place package of popcorn in the center of the oven floor as directed by the package instructions. Close oven door.



Step 3: Touch SENSOR POPCORN pad. No need to touch START, the oven will start immediately.

After the popcorn sensor detects steam, the oven signals and displays remaining cooking time needed.



Step 4: When cooking is completed, the oven signals and flashes “End”. Open the door and remove the popcorn.

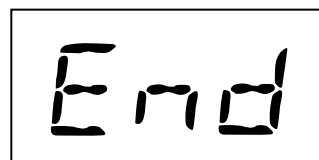

If food is undercooked after the countdown use MICRO COOK for additional cooking time.

How to Adjust the Sensor Popcorn Program to Provide a Shorter or Longer Cook Time

If your favorite popcorn is not completely popped, there is a simple adjustment you can make.

Touch the SENSOR POPCORN pad.

(The oven will start immediately.) Then touch number pad 9.

A plus sign will appear on the display beside the word “POP”. The plus sign indicates 20 seconds more cooking time is being provided.

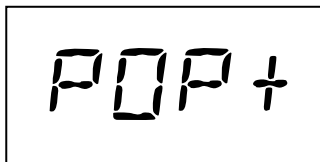

If your favorite popcorn is overcooked, there is a simple adjustment you can make.

Touch the SENSOR POPCORN pad.

(The oven will start immediately.) Then touch number pad 1.

A minus sign will appear on the display beside the word “POP”. The minus sign indicates 20 seconds less cooking time is being provided.

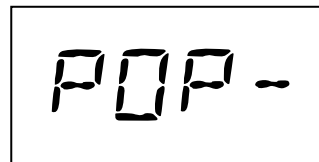

Questions and Answers

Q. I opened the door to check on the popcorn and “Error” appeared on the display. Why?

A. The Sensor Popcorn program first detects steam and then switches to Micro Cook. If you open the door while “POP” is displayed, “Error” will appear. Close the door, touch CLEAR/OFF and begin again. You may open the door when “End” appears on display.

Q. Can I use regular popcorn with the Sensor Popcorn feature in my microwave oven?

A. No. This automatic function is designed to be used only with prepackaged microwave popcorn.

Q. When I touched the POPCORN pad, the oven signalled and “HOT” appeared in the display, and the feature would not operate. Why?

A. If the temperature inside the oven is greater than 200°, the sensor will not operate properly as the oven does not allow the sensor cooking feature to be used.

SENSOR BEVERAGE

NOTE: Do not use this feature twice in succession on the same food portion—it may result in severely overcooked or burnt food.

The Sensor Beverage program makes it simple to heat a cup of hot chocolate or other beverage. Use a cup that has no metal decoration and is microwave-safe (refer to the Microwaving Tips section).



Touch SENSOR BEVERAGE pad. No need to touch START, the oven will start immediately.

The oven will signal and turn off automatically when finished.

CAUTION: Beverages heated with the Sensor Beverage feature may be quite hot. Remove the container with care.

If food is undercooked after the countdown use MICRO COOK for additional cooking time.



SENSOR REHEAT

Sensor Reheat is designed for reheating single serving sizes of previously prepared foods. With many leftovers, there is no need to look up reheating times in a cookbook or to rely on guesswork.

By actually sensing the steam that escapes as food heats, this feature automatically adjusts the oven's heating time to various types and amounts of pre-cooked food.

Because all cooking containers must be covered during automatic reheating, this feature is best with foods you want to steam or retain moisture.

NOTE: Do NOT use the metal shelf with Sensor Reheat.

NOTE: Do not use this feature twice in succession on the same food portion—it may result in severely overcooked or burnt food.

Foods Recommended

A wide variety of previously prepared foods including leftovers can be reheated using this feature. Reheat is recommended for single-servings of food or plates of leftovers.

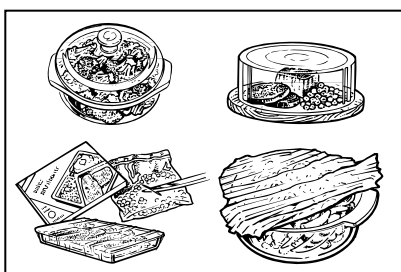

Foods Not Recommended

Bread products, foods that must be reheated uncovered, foods that require constant attention, foods calling for a dry look or crisp surface after reheating should not be reheated using this feature. It is best to use Micro Cook.

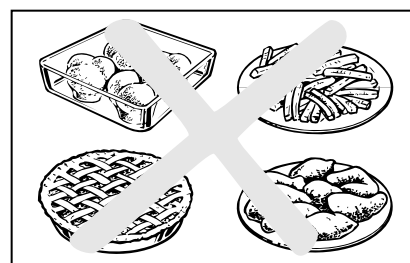

Easy to Use

Simply touch the SENSOR REHEAT pad. No need to touch START, the oven will start immediately.

Keep Door Closed

Do not open the oven door while the word "RHEAT" is displayed—steam escaping from the oven can affect reheating performance. If the door is opened, close the door and touch START immediately.

Example:

Place covered food in oven. Touch SENSOR REHEAT pad. No need to touch START, the oven will start immediately.

"RHEAT" and "FOOD" are displayed.



Beep sounds when steam is sensed and "RHEAT" is replaced by time counting down. Rotate or stir food if necessary. Close door and touch START to finish heating. When done, oven displays "End" and beeps every minute until door is opened or CLEAR/OFF is touched.

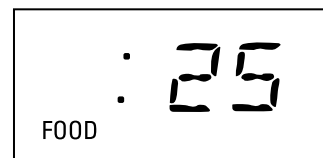

If food is not hot enough after the countdown use MICRO COOK for additional reheating time.

Questions & Answers

Q. If my food is not completely reheated after using Sensor Reheat, what should I do?

A. Use Micro Cook to reheat for additional time until desired temperature is reached.

Q. What if I don't fully cover the dish in Sensor Reheat?

A. Oven senses steam too quickly, which shortens the reheating time and leaves food too cool. Cover tightly and reset Sensor Reheat.

SENSOR COOK



The Sensor Cook feature makes cooking your favorite foods easy. By actually sensing the steam that escapes as food cooks, this feature automatically adjusts the oven's cooking time to various types and amounts of food.

Because most cooking containers must be covered during Sensor Cook, this feature is best with foods that you want to steam or retain moisture.

NOTE: Do NOT use the metal shelf with Sensor Cook.

NOTE: Do not use this feature twice in succession on the same food portion—it may result in severely overcooked or burnt food.

Foods Recommended

A wide variety of foods including meats, fish and vegetables can be cooked using this feature.

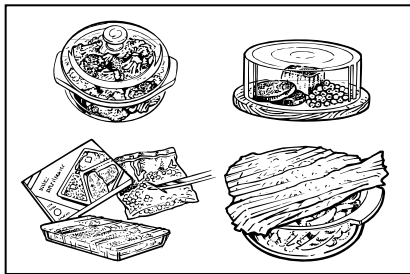

Foods Not Recommended

Foods that must be cooked uncovered, foods that require constant attention, foods that require addition of ingredients during cooking and foods calling for a dry

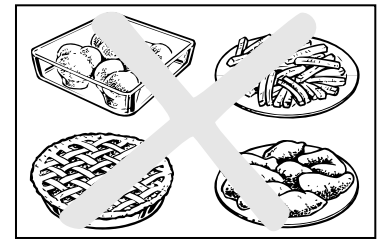

look or crisp surface after cooking should not be cooked using this feature. It is best to Micro Cook them.

Foods that microwave best using the temperature probe should be Temp Cooked or Combination Roasted.

Easy to Use

Simply touch 3 control pads—SENSOR COOK, desired CODE, and START. The word “AUTO” appears on the display and the sensor is activated to sense steam from food.

If food is undercooked after the countdown use MICRO COOK for additional cooking time.

Keep Door Closed

Do not open the oven door while the word “AUTO” is displayed—steam escaping from the oven can affect cooking performance. If the door is opened, close the door and touch START immediately.

Sensor Cook Codes

Sensor Cook codes 1 through 7 are designed to give you easy, automatic results with a number of popular foods. See the Sensor Cooking Control Guide section for specific foods and instructions.

Example:

Step 1: Place covered food in oven. Touch SENSOR COOK pad. “ENTER FOOD CODE” flashes on display.

Step 2: Touch number pad of desired food code. The code and food type you selected will appear on the display. “FOOD” and “CODE” flash. After 4 seconds, “START” flashes on the display. Touch START.

Word “AUTO” shows on display, indicating steam sensor is activated. DO NOT OPEN DOOR. OPENING DOOR MAY AFFECT COOKING PERFORMANCE.

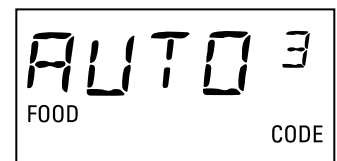

Beep sounds when steam is sensed and “AUTO” is replaced by cook time. Rotate or stir food, if necessary. When done, oven beeps every minute until door is opened or CLEAR/OFF is touched.





SENSOR REHEAT AND SENSOR COOK CONTAINERS AND COVERS

Containers and Covers

Appropriate containers and coverings help assure good cooking results.

- **Always use microwave-safe containers and cover them with lids or vented plastic wrap.** Wonder if it's microwave-safe? Put it to the test described in the Microwaving Tips section.
- **Never use tight-sealing plastic covers**—they can prevent steam from escaping and cause food to overcook.

- **Match the amount of food to the size of the container.** Fill containers at least half full for best results.
- **Be sure the outside of the cooking container and the inside of the microwave oven are dry** before placing food in the oven. Beads of moisture turning into steam can mislead the sensor.
- **Stir or rotate some foods after a beeping signal, if required.** See the Sensor Cooking Control Guide section.

SENSOR COOKING CONTROL GUIDE

- Do not open oven door during cycle. When oven signals and countdown time is displayed, door may be opened for stirring, turning or rotating food. To resume cooking, close door and touch START.
- Match the amount of food to the size of container. Fill containers at least 1/2 full.
- Be sure outside of container and inside of oven are dry.
- After completion of Sensor Cook cycle, if food needs additional cooking, return food to oven and use Micro Cook to finish cooking.

Food	Sensor Cook Code	Servings	Serving Size	Comments
Canned Vegetables	1	1 to 4	4 oz.	Use microwave-safe casserole or bowl. Cover with lid or plastic wrap.
Frozen Vegetables	2	1 to 4	4 oz.	Use microwave-safe casserole or bowl. Follow package instructions for adding water. Cover with lid or plastic wrap.
Fresh Vegetables	3	1 to 4	4 oz.	Use microwave-safe casserole or bowl. Add 2 tablespoons water for each serving. Cover with lid or plastic wrap.
Potatoes	4	1 to 4	8 oz.	Pierce skin with fork. Cluster potatoes in center of oven floor.
Fish	5	1 to 4	4 oz.	Use oblong, square or round dish. Cover with plastic wrap.
Chicken Pieces	6	1 to 4	1 to 2 pieces	Use oblong, square or round dish. Cover with wax paper.
Ground Meat (Beef, Pork, Turkey)	7	—	1/2 to 3 lbs.	Use round casserole dish. Crumble meat into dish. Cover with wax paper or plastic wrap.

CONVECTION TIME COOKING



During convection cooking, a heating element is used to raise the temperature of the air inside the oven. Any oven temperature from 225°F to 450°F may be programmed. A fan gently circulates this heated air throughout the oven, over and around the food, producing golden brown exteriors and rich, moist interiors.

Because the heated air is kept constantly moving, not permitting a layer of cooler air to develop around the food, some foods cook faster than in regular oven cooking.

NOTE: For information on suggested cookware, see Cookware and Accessories section.

For best results

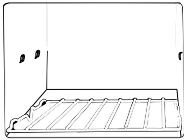

1. Place the shelf on the oven floor.
2. Allow at least one inch between the pan and the walls of the oven.
3. When converting your favorite recipe from regular oven cooking to convection, lower the oven temperature 25–35° and check at minimum time.

How to Convection Preheat and Time Cook



Step 1: Touch Convection COOK pad.

Step 2: Enter the oven temperature by touching the number pads that correspond with the desired oven temperature. For example, touch number pads 2, 7, and 5 for 275°F. Do not enter convection cook time now.



Step 3: Touch START. If you do not open the door within 1 hour the oven will turn off automatically.

Step 4: Open the oven door and place the food in the oven.

Step 5: Close the oven door. Set the desired cooking time in hours and minutes by touching number pads in sequence beginning with hours. For example, to set 2 hours and 30 minutes, touch number pads 2, 3, and 0 in that order. To enter time less than one hour, for example, 30 minutes, touch 0, 3 and 0.



Step 6: Touch START pad. When cooking is completed, the display shows “End” and the oven signals and turns off.

How to Convection Time Cook Without Preheating



Step 1: If your recipe does not require preheating, touch the Convection COOK pad.

Step 2: Enter the oven temperature by touching the number pads that correspond to the desired oven temperature. For example, touch number pads 2, 2 and 5 for 225°F.

Step 3: Set the desired cooking time in hours and minutes by touching number pads in sequence beginning with hours. For example, to set 2 hours and 30 minutes, touch number pads 2, 3 and 0, in that order. To enter time less than one hour, for example, 30 minutes, touch 0, 3 and 0.



Step 4: Touch START pad.



CONVECTION TEMPERATURE COOKING

You can also convection cook with the temperature probe, to assure that foods are cooked precisely to the degree of doneness desired, while the constantly circulating hot air assures even cooking and delicious browning. The temperature probe monitors the internal temperature of the food and turns the oven off automatically when the desired temperature is reached.

For best results

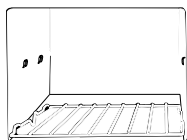

1. Place the shelf on the oven floor.
2. Allow at least one inch between the pan and the walls of the oven.
3. When converting your favorite recipe from regular oven cooking to convection, lower the oven temperature 25–35° and check at minimum time.

How to Convection Temperature Cook

Step 1: Insert probe in food as directed in the Cookbook or in this guide. Plug other end of probe securely into wall receptacle.

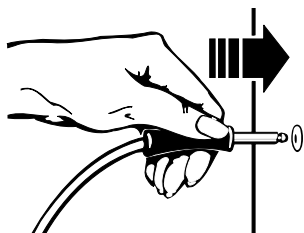

Step 2: Touch Convection COOK pad.

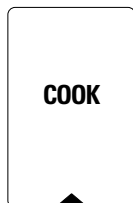

Step 3: Enter oven temperature by touching the number pads that correspond with the desired oven temperature. For example, touch 2, 2, 5 for 225°F.

Step 4: Touch the appropriate number pads in sequence to enter the desired food temperature. Any food temperature from 90°F to 199°F may be programmed. For example, touch 1, 8 and 0, in that order, for 180°F. The temperature selected is shown on the display.



Step 5: Touch START pad. When food reaches preselected temperature, display shows “End,” oven signals and turns off.

Questions and Answers

Q. After I preheated my oven, I tried to set cooking time, but nothing happened. What is the problem?

A. Until you open the oven door or touch the CLEAR/OFF pad, the oven remains in the preheat mode and no further instructions can be entered. After 1 hour oven automatically turns off.

Q. Can I check during the cooking cycle to be sure that I have set the correct oven temperature?

A. Yes. If you touch the Convection COOK pad at any time during cooking, the selected oven temperature is displayed on the display.

Q. Can I store the probe in the oven when it is not in use?

A. Leaving the probe in the oven is not recommended. If you forget and leave it in during cooking, without having inserted it in food, damage to the probe or to the oven may result.

COMBINATION TIME COOKING



Combination cooking offers the best features of microwave energy and convection cooking. Microwaves cook food fast and convection circulation of heated air browns foods beautifully.

For best results

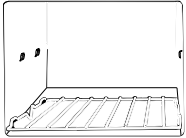

1. Place the shelf on the oven floor.
2. Allow at least one inch between the pan and the walls of the oven.
3. When converting your favorite recipe from regular oven cooking to combination cooking, lower the oven temperature 25–35° and check at minimum time.

How to Combination Time Cook With Preheat



Step 1: Touch COMBINATION COOK pad.

Step 2: Enter the oven temperature by touching the number pads that correspond with the desired oven temperature. For example, touch number pads 2, 7, and 5 for 275°F. Do not enter convection cook time now.



Step 3: Touch START. If you do not open the door within 1 hour the oven will turn off automatically.

Step 4: Open the oven door and place the food in the oven.

Step 5: Close the oven door. Set the desired cooking time in hours and minutes by touching number pads in sequence beginning with hours. For example, to set 2 hours and 30 minutes, touch number pads 2, 3, and 0 in that order. To enter time less than one hour, for example, 30 minutes, touch 0, 3 and 0.



Step 6: Touch START pad. When cooking is completed, the display shows “End” and the oven signals and turns off.

How to Combination Time Cook Without Preheating



Step 1: If your recipe does not require preheating, touch the COMBINATION COOK pad.

Step 2: Enter the oven temperature by touching the number pads that correspond to the desired oven temperature. For example, touch number pads 2, 2 and 5 for 225°F.

Step 3: Set the desired cooking time in hours and minutes by touching number pads in sequence beginning with hours. For example, to set 2 hours and 30 minutes, touch number pads 2, 3 and 0, in that order. To enter time less than one hour, for example, 30 minutes, touch 0, 3 and 0.



Step 4: Touch START pad.

Questions and Answers

Q. May I use my metal roasting pan to Combination Cook a roast?

A. No. Do not use metal cookware when Combination cooking. Place the roast in a glass dish.

Q. Is it necessary to place a glass dish on the oven floor when Combination cooking?

A. No. For best roasting results, place the glass dish on the oven shelf which rests on the oven floor during Combination cooking.

Remember:

- Check the Cookware and Accessories section for correct cookware when Combination cooking.
- For best roasting and browning results, whole roasts and poultry should be cooked in a dish placed directly on the oven shelf.
- Place meat in a glass dish on a trivet to collect juices and prevent spattering.
- Some recipes call for preheating.



COMBINATION TEMPERATURE COOKING

With this function of your new oven, you can enjoy the benefits of combination cooking with the precision of the temperature probe. The probe makes it simple to cook to the exact degree of doneness desired, by monitoring the internal temperature of the food. This function is exactly like combination time cooking except you set internal food temperature desired instead of cooking time.

For best results

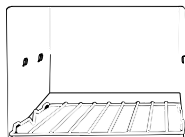

1. Place the shelf on the oven floor.
2. Allow at least one inch between the pan and the walls of the oven.
3. When converting your favorite recipe from regular oven cooking to combination temperature cooking, lower the oven temperature 25–35° and check at minimum time.

How to Combination Temperature Cook

Step 1: Insert probe in food as directed in the Cookbook or in this guide. Plug other end of probe securely into wall receptacle.

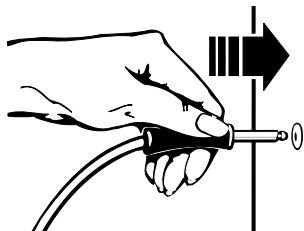

Step 2: Touch COMBINATION COOK pad.

Step 3: Enter oven temperature by touching the number pads that correspond with the desired oven temperature. For example, touch 2, 2, 5 for 225°F.

Step 4: Touch the appropriate number pads in sequence to enter the desired food temperature. Any food temperature from 90°F to 199°F may be programmed. For example, touch 1, 8 and 0, in that order, for 180°F. The temperature selected is shown on the display.



Step 5: Touch START pad. When food reaches preselected temperature, display shows “End,” oven signals and turns off.

COMBINATION ROAST



Combination Roast is a combination function which is similar to combination temperature cooking, using both microwave and convection cooking in conjunction with the temperature probe. However, the Combination Roast feature eliminates most of the steps necessary to program combination temperature cooking.

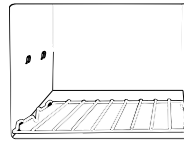

The metal shelf must be in place on the oven floor when using convection or combination cooking. The food is placed in a glass dish on a trivet for cooking during Combination Roast.

How to Combination Roast

Step 1: Insert temperature probe into meat and plug the probe firmly into oven wall receptacle.



Step 2: Touch the COMBINATION ROAST pad once for cooking your roast to MEDium doneness. Touch the pad twice for cooking to "WELL".



Step 3: Touch START. When food reaches the programmed temperature for proper degree of doneness, the oven will sound and display "Hold". The oven will then hold the temperature for up to one hour.

Combination Roast Guide (Use Probe)

Food	Medium	Well
Beef	✓	✓
Lamb	✓	✓
Pork	—	✓
Chicken	—	✓
Turkey	—	✓

†The U. S. Department of Agriculture says "Rare beef is popular, but you should know that cooking it to only 140°F. means some food poisoning organisms may survive."
(Source: *Safe Food Book. Your Kitchen Guide.* USDA Rev. June 1985.)

(continued next page)



COMBINATION ROAST

(continued)

Questions and Answers

Q. When I cook poultry, the thin, small areas like legs and wings often overcook before the rest of the bird is thoroughly cooked. How can I prevent this?

A. Thin, uneven portions of poultry may be shielded with aluminum foil during cooking. Do not allow foil to touch shelf or oven sides, arcing may occur.

Q. Usually my temperature probe gives very accurate results, but this time it didn't. What happened?

A. If the temperature probe is positioned touching fat or bone, an inaccurate reading may result. Be sure to place the probe in solid muscle, usually the thickest, meatiest part of the roast or poultry, or in the center of a meat loaf or casserole.

Q. Meats often take longer than indicated in the guides to reach the desired internal temperature. Why?

A. If the meat is recently defrosted and still very cold or icy inside, it will require a longer cooking time than meat which has been merely refrigerated. Times shown in the guides are usually for meats that are refrigerator temperature.

Q. Do most meats require standing time after cooking with Combination Roast?

A. You may want to let meats stand briefly, to allow easier carving and serving. Most meat roasts continue to cook for a few minutes after removing from the oven.

COOKING REFERENCE GUIDE



This is a Quick Reference to guide you in selecting the best method of cooking. Specific recipes can be adapted to any method of cooking.

* — Best Method
 A — Alternate
 N — Not Recommended

Foods	Microwave	Combination	Convection
Appetizers			
Dips and Spreads	*	N	N
Pastry Snacks	A	*	A
Beverages	*	N	N
Sauces and Toppings	*	N	N
Soups and Stews	*	A	N
Meats			
Defrosting	*	N	N
Roasting	A	*	A
Poultry			
Defrosting	*	N	N
Roasting	A	*	A
Fish and Seafood			
Defrosting	*	N	N
Cooking	*	A	A
Casseroles	A	*	A
Eggs and Cheese			
Scrambled, Omelets	*	N	N
Quiche, Souffle	A	A	*
Vegetables, Fresh	*	N	N
Breads			
Quick	A	A	*
Yeast	N	A	*
Muffins, Coffee Cake	A	*	A
Desserts			
Cakes, Layer and Bundt	A	A	*
Angel Food and Chiffon	N	N	*
Custard and Pudding	*	N	N
Bar Cookies	A	*	A
Pies and Pastry	N	A	*
Candy, Fruit	*	N	N
Blanching Vegetables	*	N	N
Frozen Convenience Foods	*	A	A



CARE AND CLEANING



Keep your oven clean and sweet-smelling. Opening the oven door a few minutes after cooking helps air out the inside. An occasional thorough wiping with a solution of baking soda and water keeps the inside fresh.

Don't use sharp-edged utensils on your oven. The inside and outside oven walls can be scratched. The control panel can be damaged.

BE CERTAIN POWER IS OFF BEFORE CLEANING ANY PART OF THIS OVEN.

How to Clean the Inside

Walls and floor. Some spatters can be removed with a paper towel, others may require a damp cloth. Remove greasy spatters with a sudsy cloth, then rinse with a damp cloth. Do not use abrasive cleaners on oven walls. **NEVER USE A COMMERCIAL OVEN CLEANER ON ANY PART OF YOUR MICROWAVE OVEN.**

Door (inside). Window: Wipe up spatters daily and wash when soiled with a damp cloth. Rinse thoroughly and dry.

Metal and plastic parts on door: Wipe frequently with a damp cloth to remove all soil. **DO NOT USE ABRASIVES, SUCH AS CLEANING POWDERS OR STEEL AND PLASTIC PADS. THEY WILL DAMAGE THE SURFACE.**

Special note when using Brown 'N Sear Dish: If grease is present, high heat generated on bottom of a Brown 'N Sear dish may cause the grease to burn onto the oven tray. This may be removed with a cleanser such as Bon Ami® brand cleanser.

After using Bon Ami® brand cleanser, rinse and dry thoroughly, following instructions on can. Do not use Bon Ami® brand cleanser on the painted surfaces such as the walls. It may scratch the paint.

Automatic Temperature Probe. Probe is sturdy, but care should be taken in handling. Do not twist or bend; avoid dropping temperature probe.

Clean as soon after using as possible. To clean, wipe with sudsy cloth, then rub lightly with plastic scouring ball if necessary. Rinse and dry or wash in dishwasher.

Shelf. Clean the shelf with mild soap and water or in the dishwasher. **Do not clean in a self-cleaning oven.**

How to Clean the Outside

Case. Clean the outside of your oven with soap and damp cloth, rinse with a damp cloth and then dry. Wipe the window clean with a damp cloth. Chrome trim is best wiped with a damp cloth and then with a dry towel.

Control Panel. Wipe with a damp cloth. Dry thoroughly. Do not use cleaning sprays, large amounts of soap and water, abrasives or sharp objects on the panel—they can damage it.

Door Surface. When cleaning surfaces of door and oven that come together on closing the door, use only mild, non-abrasive soaps or detergents applied with a sponge or soft cloth.

Power Cord. If the cord becomes soiled, unplug and wash with a damp cloth. For stubborn spots, sudsy water may be used, but be certain to rinse with a damp cloth and dry thoroughly before plugging cord into outlet.

GROUNDING INSTRUCTIONS

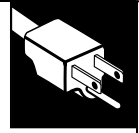

This appliance must be grounded. In the event of an electrical short circuit, grounding reduces the risk of electric shock by providing an escape wire for the electric current. This appliance is equipped with a power cord having a grounding wire with a grounding plug. The plug must be plugged into an outlet that is properly installed and grounded. (Fig. 1)

WARNING—Improper use of the grounding plug can result in a risk of electric shock.

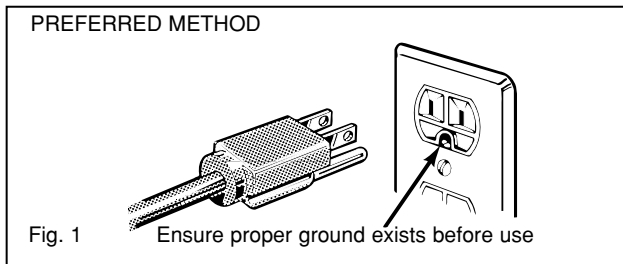

Consult a qualified electrician or service technician if the grounding instructions are not completely understood, or if doubt exists as to whether the appliance is properly grounded.

Where a standard 2-prong wall receptacle is encountered, it is your personal responsibility and obligation to have it replaced with a properly grounded 3-prong wall receptacle.

Do not under any circumstance cut or remove the third (ground) prong from the power cord.

Do not use an adapter plug with this appliance.

Do not use an extension cord with this appliance.



LIGHT BULB REPLACEMENT

Oven Light

To replace your oven light, first **disconnect power at main fuse or circuit breaker panel or pull plug.**

Step 1: Open the oven door.

Step 2: Remove the front grille by taking out the 2 screws that hold it in place.

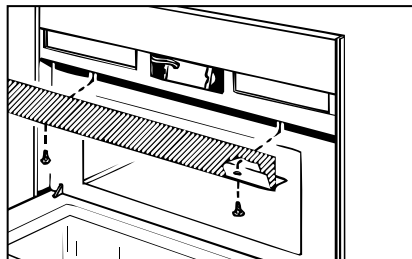

Step 3: Rotate the light bulb housing out and toward you to access the light bulb. Replace the burned-out bulb with a 40-watt incandescent bulb (WB02X4253) available from your GE supplier.

Reverse Step 2 and Step 3 to replace the grille, while making sure the grille is flush against the control panel.

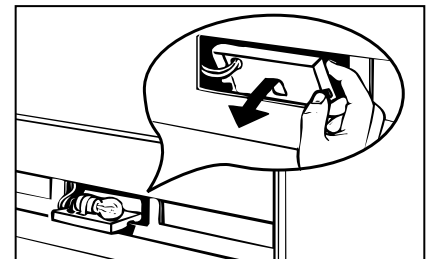



QUESTIONS? USE THIS PROBLEM SOLVER

PROBLEM	POSSIBLE CAUSE
OVEN WILL NOT COME ON	<ul style="list-style-type: none">• A fuse in your home may be blown or the circuit breaker tripped. Replace fuse or reset circuit breaker.• Set the circuit breaker to the off position. Wait 30 seconds. Reset the circuit breaker to the on position.
CONTROL PANEL LIGHTED, YET OVEN WILL NOT START	<ul style="list-style-type: none">• Door not securely closed.• START pad must be touched after entering cooking selection.• Another selection entered already in oven and CLEAR/OFF pad not touched to cancel it.• Make sure you have entered cooking time or temperature after touching MICRO COOK or TEMP COOK/HOLD pads.• CLEAR/OFF pad was touched accidentally. Reset cooking program and touch START pad.• Temperature probe not inserted properly or not being used during Combination Roast or Temp Cook/Hold.• Make sure you have entered a desired finished food temperature or oven temperature after setting temperature cooking programs.• Make sure you have entered a code number after touching SENSOR COOK.
“PRObE” APPEARS ON DISPLAY	<ul style="list-style-type: none">• Temperature probe is missing or not plugged in securely when using cooking functions that measure food temperature.• Temperature probe is inserted for a program that does not use the probe.
“Error” APPEARS ON DISPLAY	<ul style="list-style-type: none">• During Sensor Cook, Sensor Reheat, Sensor Beverage or Sensor Popcorn program, the door was opened before steam could be detected, or steam was not detected in maximum time.
“HOT” APPEARS ON DISPLAY	<ul style="list-style-type: none">• This is normal when the temperature inside the oven is greater than 200 degrees and the door is opened.• One of the sensor cooking pads was touched when the temperature inside the oven was greater than 200 degrees. These features will not operate when the oven is hot.

All these things are normal with your microwave oven:

- Dimming oven light and change in blower sound may occur while operating at power levels other than high.
- Dull, thumping sound while oven is operating.
- Some TV-Radio interference might be noticed while using your microwave oven. It's similar to the interference caused by other small appliances and does not indicate a problem with your oven.
- Steam or vapor escaping from around the door.
- Light reflection around door.
- During cooking you will hear “cracking” and “popping” noises which are nothing more than normal expansion of the oven.
- At the end of microwave cycles you will hear a slight thump. This is normal.

NOTES



IF YOU NEED SERVICE...

To obtain service, see the Consumer Services page in the back of this guide.

We're proud of our service and want you to be pleased. If for some reason you are not happy with the service you receive, here are 2 steps to follow for further help.

FIRST, contact the people who serviced your appliance. Explain why you are not pleased. In most cases, this will solve the problem.

NEXT, if you are still not pleased, write all the details—including your phone number—to:

Manager, Consumer Relations
GE Appliances
Appliance Park
Louisville, KY 40225

**YOUR GE MICROWAVE/
CONVECTION OVEN
WARRANTY**

**Staple sales slip or cancelled
check here. Proof of original
purchase date is needed to obtain
service under warranty.**

WHAT IS COVERED

FULL ONE-YEAR WARRANTY

For one year from date of original purchase, we will provide, free of charge, parts and service labor in your home to repair or replace **any part of the microwave/convection oven** that fails because of a manufacturing defect.

**LIMITED ADDITIONAL
NINE-YEAR WARRANTY**

For the second through tenth year from date of original purchase, we will provide, free of charge, a replacement **magnetron tube** if the magnetron tube fails because of a manufacturing defect. You pay for the service trip to your home and service labor charges.

This warranty is extended to the original purchaser and any succeeding owner for products purchased for ordinary home use in the 48 mainland states, Hawaii and Washington, D.C. In Alaska the warranty is the same except that it is LIMITED because you must pay to ship the product to the service shop or for the service technician's travel costs to your home.

All warranty service will be provided by our Factory Service Centers or by our authorized Customer Care[®] servicers during normal working hours.

Should your appliance need service, during warranty period or beyond, call 800.GE.CARES (800.432.2737).

**WHAT IS NOT
COVERED**

- Service trips to your home to teach you how to use the product.
- Improper installation, delivery or maintenance.

If you have an installation problem, contact your dealer or installer. You are responsible for providing adequate electrical, gas, exhausting and other connecting facilities.

- Replacement of house fuses or resetting of circuit breakers.
- Failure of the product if it is used for other than its intended purpose or used commercially.
- Damage to product caused by accident, fire, floods or acts of God.
- Incidental or consequential damage caused by possible defects with this appliance.
- Damage caused after delivery.

Some states do not allow the exclusion or limitation of incidental or consequential damages, so the above limitation or exclusion may not apply to you. This warranty gives you specific legal rights, and you may also have other rights which vary from state to state. To know what your legal rights are in your state, consult your local or state consumer affairs office or your state's Attorney General.

Warrantor: General Electric Company

**If further help is needed concerning this warranty, write:
Manager—Consumer Affairs, GE Appliances, Louisville, KY 40225**

JEB1095

Consumer Support.



GE Appliances Website

www.GEAppliances.com

Have a question or need assistance with your appliance? Try the GE Appliances Website 24 hours a day, any day of the year! For greater convenience and faster service, you can now download Owner's Manuals, order parts, catalogs, or even schedule service on-line. You can also "Ask Our Team of Experts™" your questions, and so much more...

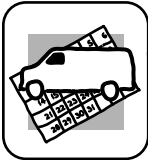

Schedule Service

www.GEAppliances.com

Expert GE repair service is only one step away from your door. Get on-line and schedule your service at your convenience 24 hours any day of the year! Or call 800.GE.CARES (800.432.2737) during normal business hours.

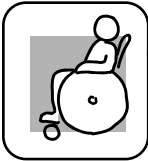

Real Life Design Studio

www.GEAppliances.com

GE supports the Universal Design concept—products, services and environments that can be used by people of all ages, sizes and capabilities. We recognize the need to design for a wide range of physical and mental abilities and impairments. For details of GE's Universal Design applications, including kitchen design ideas for people with disabilities, check out our Website today. For the hearing impaired, please call 800.TDD.GEAC (800.833.4322).



Extended Warranties

www.GEAppliances.com

Purchase a GE extended warranty and learn about special discounts that are available while your warranty is still in effect. You can purchase it on-line anytime, or call 800.626.2224 during normal business hours. GE Consumer Home Services will still be there after your warranty expires.

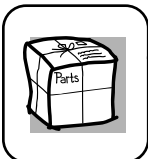

Parts and Accessories

www.GEAppliances.com

Individuals qualified to service their own appliances can have parts or accessories sent directly to their homes (VISA, MasterCard and Discover cards are accepted). Order on-line today, 24 hours every day or by phone at 800.626.2002 during normal business hours.

Instructions contained in this manual cover procedures to be performed by any user. Other servicing generally should be referred to qualified service personnel. Caution must be exercised, since improper servicing may cause unsafe operation.

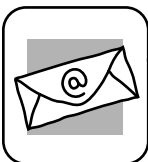

Contact Us

www.GEAppliances.com

If you are not satisfied with the service you receive from GE, contact us on our Website with all the details including your phone number, or write to: General Manager, Customer Relations
GE Appliances, Appliance Park
Louisville, KY 40225



Register Your Appliance

www.GEAppliances.com

Register your new appliance on-line—at your convenience! Timely product registration will allow for enhanced communication and prompt service under the terms of your warranty, should the need arise. You may also mail in the preprinted registration card included in the packing material.

Printed in Korea

Free Manuals Download Website

<http://myh66.com>

<http://usermanuals.us>

<http://www.somanuals.com>

<http://www.4manuals.cc>

<http://www.manual-lib.com>

<http://www.404manual.com>

<http://www.luxmanual.com>

<http://aubethermostatmanual.com>

Golf course search by state

<http://golfingnear.com>

Email search by domain

<http://emailbydomain.com>

Auto manuals search

<http://auto.somanuals.com>

TV manuals search

<http://tv.somanuals.com>